

Bearings for Material Handling System

物流系统轴承

- 物流系统轴承主要包括叉车门架用滚轮轴承、叉车用链条导向滚轮、标准滚轮轴承。这类轴承的外圈有较大的壁厚能够承担较高的接触载荷，叉车门架用滚轮和标准滚轮产品的接触工作区进行了优化设计，以确保在接触应力状态下更合理的分配载荷。叉车用链条导向滚轮具有能导向链条的凸缘。

产品内部结构包括：满装圆柱滚子、滚针结构和球结构两类。

The material handling system bearings consist of roller bearings for forklift portal, chain-guided roller bearings for forklift and standard combined bearings. With thick outer race, these bearings could afford heavy contact load. The contact working area of forklift portal bearings and standard combined bearings has been optimized to ensure a more reasonable load distribution when there is contact stress. Chain-guided forklift bearings have a flange to guide the chain.

There are two internal designs available, full complement roller/needle and ball design.



滚轮轴承是外圈壁特别厚的滚动轴承，能够承受重负荷与冲击负荷。是一种快装组件，可以直接在滚道上滚动，用于各种凸轮驱动、轨道、输送机、物流系统等。

滚轮的外径面有圆柱形、弧形和各种异形，可根据客户要求使用要求设计，利用弧形面可使安装时的倾斜误差得到补偿，应用于可能出现角度对中误差的场合，并使压力面处于最小的边缘应力状态。

滚轮轴承内部结构形式有球轴承、滚针轴承和圆柱滚子轴承等，可按客户要求有多种设计，适用于不同的使用场合。

WD滚轮轴承包括：

- 复合滚轮
- 螺栓型滚轮
- 叉车门架用滚轮链轮
- 凸轮滚子
- 支承型滚轮
- 其它非标准滚轮

公差

按照Po标准的正常公差生产，符合ISO492标准，但是滚轮外径的公差除外。

游隙

提供C2、C0、C3、C4、C5的标准游隙，也可按客户使用工况要求提供特殊游隙。游隙极限值符合ISO 5753的规定。

负荷承载能力

额定动负荷按ISO281/1标准，额定静负荷按ISO76标准。

润滑

滚轮填入锂基润滑脂，有良好的防锈特性，工作温度范围是摄氏-30至+120℃。一般是永久性脂润滑，在通常运行条件下，无需补充润滑脂。但是，如果轴承要承受水气或固体污染物，或者如果在摄氏70度以上的温度下长期运行，应补充润滑脂。内圈上有注油孔或其它润滑通道是用于补充润滑脂，应使用具相同特性的润滑脂。

可按客户要求提供耐高、耐低温润滑脂。

产品简介

1、复合滚轮轴承

复合滚轮应用于叉车门架和移动搬运系统等物流设备。

复合滚轮可同时承受径向和轴向两个方向的力，简化了结构，有效的节省安装空间，方便使用，只需在安装板孔内焊接轴头，不必拆卸整个轴承。

该轴承为密封结构，填充高质量润滑脂，提供长期有效润滑，并提供补充润滑通道，提高轴承使用寿命。径向滚轮使用于不需承受大的轴向力的场合，其余同复合滚轮。

2、螺栓型滚轮

螺栓型滚轮轴承基本上外圈壁较厚的滚针、圆柱滚子或球轴承。外圈的外径表面是弧形的，在螺栓型滚轮轴承倾斜或倾侧运行的情况下，起到防止边缘应力的作用。螺栓滚轮轴承是快装组件，填充润滑脂。适用于各种凸轮驱动、轨道和输送机系统等。

螺栓型滚轮轴承无内圈，而有一个带螺纹的轴，以便可以用六角螺母快速、方便地将轴承装到对应的机器部件上。外圈的轴向引导是由整体挡边和压在轴上的挡圈来提供，或者由满滚子来提供。

螺栓型滚轮轴承有几种不同的设计，尺寸相同，只是内部设计不同。一般说来，螺栓滚轮轴承在轴上是同心安装，但是有些则带有偏心套，加热后套紧在轴上。带有偏心套的螺栓型滚轮轴承能够获得与凸轮的最合适的过盈配合，而相关部件可以使用不太严格的制造公差。

3、叉车门架用滚轮链轮

叉车门架用滚轮基本上外圈壁较厚的球、圆柱滚子或滚针轴承。滚轮的外径面有圆柱形和弧形，可根据客户要求使用要求设计，与滚道面相配合。利用这种外圈，滚轮可以直接在滚道上滚动，并可以承受较重负荷和冲击负荷。该轴承是密封结构，填充润滑脂，提供长期有效润滑，客户可免润滑。对于使用工况恶劣的可按客户要求设计补充润滑脂的通道，提高轴承使用寿命。

4、凸轮滚子

凸轮滚子是外圈壁特别厚的球轴承。它是预润滑的快装组件，用于各种凸轮传动、输送机系统等。该轴承有单列和双列设计，滚轮的外径面有圆柱形和弧形，可根据客户要求使用要求设计。在可能出现角度对中误差的场合，应使用弧形滚动面的凸轮滚子，保持最小的边缘应力。

5、支承型滚轮

支承型滚轮基本上外圈壁较厚的滚针或圆柱滚子轴承。滚轮的外径面有圆柱形和弧形，可根据客户要求使用要求设计。

利用这种外圈，滚轮可以直接在滚道上滚动，并可以承受大的负荷。外圈的外表面是弧形的，在滚轮倾斜或倾侧运行的情况下，起到防止边缘应力的作用。该轴承是快装组件，填充润滑脂，适用于各种凸轮驱动、轨道和输送机系统等。

支承型滚轮有两种，无轴向引导和有轴向引导的。按密封结构有非密封（开放）型和密封型的。



物流系统轴承
Bearings for material handling system

Track roller bearings can withdraw heavy load rating and shock load rating by their thick outer race. They are ready-to-fit units and are intended for all types of cam drives, tracks, conveyors, material handling systems and so on.

According to customer's application, the OD surface can be designed to be flat, crowned and other special ones. Cam rollers with crowned runner surfaces should always be used where angular misalignments with respect to the track expected and edge stresses kept to a minimum.

Track roller bearings are based on ball bearings, needle roller bearings as well as cylindrical roller bearings. Because of the wide variety of designs they are suitable for the most diverse operating conditions.

The WD track roller bearings consist of:

- Combined bearings
- Cam followers
- Mast rollers and chain pulleys
- Cam roller bearings
- Supporting rollers
- Other non-standard rollers

Tolerances

WD track roller bearings are produced according to Normal tolerance P0 standard, except for the tolerance of the crowned runner surface diameter. The values for tolerances tally with ISO 492.

Clearance

C2, C0, C3, C4, C5 radial internal clearance are available and also special radial internal clearance is available as customer's application providing the clearance limits are as specified in ISO 5753.

Load rating

Dynamic load rating conform to ISO281/1 and static load rating conform to ISO76.

Lubrication

The track roller bearings, filled with lithium grease, have a good anti-rust capability and can work among the temperature range from -30°C to +120°C. Generally speaking, they are greased for life and are maintenance-free under normal working condition. However, if they are subjected to moisture or solid contaminants, or if they keep running for a long periods under temperatures above 70°C, they should be relubricated with same grease by the oil hole in the inner race or other lubrication method.

High and low temperature grease are also available according to customer's request.

Product introduction

1. Combined bearings

The combined bearings are particularly suitable for truck lift columns and all other shifting and conveying systems requiring profiles.

They can afford load from both axial and radial direction at the same time. With the optimized structure, the mount space can be saved, and the usage is also simple that just to weld the pivot in the mount plate, it is

not necessary to dismantle the whole set.

The radial bearings are particularly suitable for automation and shift systems, which do not require heavy axial loads, and they come from the combined bearings and maintain the same features of construction.

2. Cam followers

The cam followers are essentially needle or cylindrical roller or ball bearings with a thick-walled outer race. The outside (runner) surface of the outer ring is crowned which serves to prevent edge stresses if the cam follower runs in a tilted or inclined position. Cam followers are ready-to-mount units which are filled with grease. They are suitable for all types of cam drives, tracks, conveyor systems and etc. Instead of an inner race, cam followers have a solid stud which is threaded, so they can be quickly and easily attached to appropriate machine components by means of a hexagonal nut. Axial guidance for the outer race is provided by an integral flange at the head of the stud and a side washer pressed on to the stud, or by the roller complement.

The cam followers are available in different designs which have the same dimensions and differ only in their internal designs. Generally, the cam followers have a concentric seating on the stud, but some are also available with an eccentric collar which is shrunk on to the stud. Cam followers with eccentric collar enable an optimum interaction with the cam to be obtained and also allow less stringent manufacturing tolerances to be used for the associated components.

3. Mast rollers and chain pulleys

They are essentially ball or cylindrical roller and needle bearings with a thick-walled outer race. The rollers are available with a flat runner surface or a crowned one, which can be designed according to customer's application. They can roll directly on the tray under heavy load and shock load. They are greased for life. Under normal operating conditions, they are maintenance-free, while they should be relubricated under the severe working condition to prolong the working lifespan.

4. Cam rollers

Cam rollers are ball bearings which have a particularly thick-walled outer race. They are ready-to-fit pregreased units and are used for all types of cam drives, conveyor systems and etc.

Either single row or double row design is available and the outer race surface can be designed to be crowned or flat to suit for customer's application. Cam rollers with crowned runner surfaces should always be used in where angular misalignments with respect to the track expected and edge stresses kept to a minimum.

5. Support rollers

Support rollers are basically needle or cylindrical roller bearings with a thick-walled outer race. The rollers are available either with a flat runner surface or crowned runner surface, which can be designed according to customer's application.

With this outer race, the cam rollers are able to roll directly in the raceway and bear a heavy load rating. The crowned runner surface should always be used where angular misalignments with respect to the track expected and edge stresses kept to a minimum. They are ready-to-fit units, filled with grease and are suitable for all types of cam drives, tracks, conveyor systems and etc.

The support rollers can be divided into ones with axial guidance and without axial guidance. And from sealing structure, they can be divided into open type and sealed type.

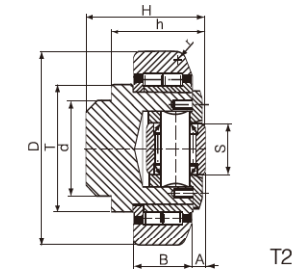
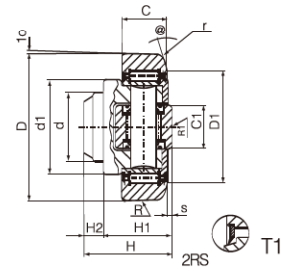
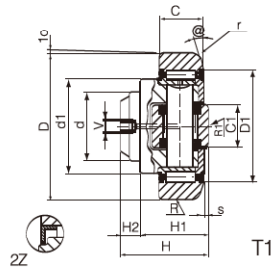

Standard Combined Bearings

Bearing Code	Dimensions											Load rating				OD on request			Reference Index							
	2Z	2RS	d	D	C	H	H1	H2	D1	C1	d1	S	α	r	R	R1	V	C	Co	Ca	Coa	mm	Germany	Italy A	Italy B	
		mm	mm	mm	mm	mm	mm	mm	mm	mm	mm	mm	degree	mm	mm	mm	mm	KN	KN	KN	KN	mm			2Z	2RS
WD054-62.2Z	WD054-62.2RS	30	62	20	37.5	30.5	7	50	20	42	2.5	20°	3	500	500		31	35.5	11	11	62.5	4.054	4.0054-62	MR.001	MR.021	
WD055-70.2Z	WD055-70.2RS	35	70.1	23	44	36	8	57	22	48	2.5	20°	4.5	500	500	M6X1	45.5	51	13	14	70.4 / 70.4	4.055	4.0055-70	MR.002	MR.022	
WD056-78.2Z	WD056-78.2RS	40	77.7	23	48	36.5	11.5	61	26	53	3	20°	4.5	500	500	M6X1	48	56.8	18	18	78.1 / 78.5	4.056	4.0056-78	MR.003	MR.023	
WD058-88.2Z	WD058-88.2RS	45	88.4	30	57	44	13	68	26	59	3.5	20°	4.5	700	700	M6X1	68	72	23	23	88.9	4.058	4.0058-88	MR.005	MR.025	
WD061-108.2Z	WD061-108.2RS	60	107.7	31	69	55	14	82	34	71	4	20°	5	1000	700	M6X1	81	95	31	36	108.2 / 108.5	4.061	4.0061-108	MR.007	MR.027	
WD062-123.2Z	WD062-123.2RS	60	123	37	72.3	56	16.3	92	40	80	5	20°	5	1000	1000	M6X1	110	132	43	50		4.062	4.0062-123	MR.009	MR.029	
WD063-149.2Z	WD063-149.2RS	60	149	45	78.5	58.5	20	116	50	103	5.5	15°	4	1500	1000	M6X1	151	192	68	71		4.063	4.0063-149	MR.010	MR.030	
WD011-149.2Z	WD011-149.2RS	60	149	45	86	67	19	120	50	103	5.5	15°	3	1500	1000	1/8GAS	151	192	68	71			4.0011-149	MR.191		
WD037-174.2Z	WD037-174.2RS	80	174	55	95	71	24	141	63	120	7	20°	7	1500	1000	1/8GAS	278	518	132	210			4.0037-174			
WD039-185.2Z	WD039-185.2RS	80	185	55	95	71	24	141	63	120	7	20°	7	1500	1000	1/8GAS	278	518	132	210			4.0039-185			

T1

Adjustable Combined Bearings

Bearing Code	d	T	D	H	h	B	A	S	r	C	Co	Ca	Coa	OD on request	Reference index		
	mm	mm	mm	mm	mm	mm	mm	mm	mm	KN	KN	KN	KN	mm			
WD072-62	30	42	62	43	33	20	5.5	16	3	31	35.5	8	8	62.5	4.072	4.0072-62	MR.146
WD073-70	35	48	70.1	48	40	23	6.5	16	4.5	45.5	51	14	14	70.7 / 70.4	4.073	4.0073-70	MR.147
WD074-78	40	53	77.7	51	39.5	23	7	21	4.5	48	56.8	14	14	78.1 / 78.5	4.074	4.0074-78	MR.148
WD076-88	45	59	88.4	61	48	30	7	21	4.5	68	72	15	15	88.9	4.076	4.0076-88	MR.150
WD078-108	60	71	107.7	73	59	31	8	33	5	81	95	31	36	108.2 / 108.5	4.078	4.0078 / L	MR.142
WD079-123	60	80	123	75.8	59.5	37	8	33	5	110	132	31	36		4.079	4.0079-123	MR.153
WD080-149	60	103	149	89	69	45	15	50	5	151	192	68	71		4.080	4.0080-149	MR.154

C: dynamic load Ca: axial dynamic load
 Co: static load Coa: axial static load

T2

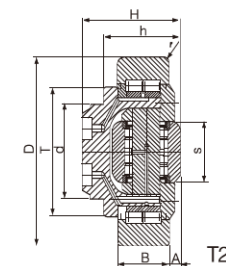
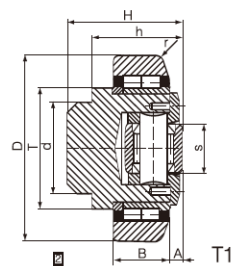
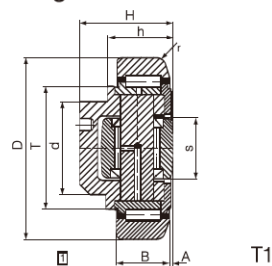

Combined Bearings for "1" Standard Profiles

Bearing Code	d mm	T mm	D mm	H mm	h mm	B mm	A mm	S mm	r mm	C KN	Co KN	Ca KN	Coa KN	OD on request mm	Reference index		Structure
															Italy A	Germany	
WD055-70	35	48	70.1	40	30.5	23	2.5	22	4.5	45.5	51	14	13	70.4 / 70.7	4.0055-40	4.0055	1
WD057-78	40	53	77.7	40.7	29	23	3	24	4	48	56.8	18	18	78.1 / 78.5	4.0057-78	4.0057	1
WD075-78	40	53	77.7	45	34	23	7	21	4	48	56.8	14	14	78.1 / 78.5	4.0075-78	4.0075	2
WD058-88	45	59	88.4	49	37	30	3.5	26	4	68	72	23	23	88.9	4.0058-49	4.0058	1
WD059-101	50	67	101.2	46	33	28	3	30	3	73	82	25	27	101.9	4.0059-101	4.0059	1
WD077-101	50	67	101.2	50.5	37.5	28	7	21	3	73	82	189	19	101.9	4.0077-101	4.0077	2
WD060-108	55	71	107.7	53	39	31	3	34	5	81	95	31	36	108.2 / 108.5	4.0060-108	4.0060	1
WD078-108	55	71	107.7	58.5	44.5	31	8	33	5	81	95	31	36	108.2 / 108.5	4.0078-108	4.0078	2
WD097-123	58	76	123	58	43	33	4.5	33	5	125	141	40	48		4.0097-123	4.0097	2

C: dynamic load Ca: axial dynamic load
Co: static load Coa: axial static load

T1

Adjustable Combined Bearings for Heavy Industry

Bearing Code	d mm	T mm	D mm	H mm	h mm	B mm	A mm	S mm	r mm	C KN	Co KN	Ca KN	Coa KN	Reference index
														Italy A
WD069-170	70	98	170	109.7	84.7	51	14.5	49.7	4	195	361	83	129	4.0069-170
WD087-185	80	115	185	100	75	47	15	49.7	3	235	440	83	130	4.0087-185
WD019-220	110	150	220	115	90	60	13.5	70	5	367	719	103	230	4.0019-220
WD038-260	130	184	260	120	95	60	18.5	80	5	475	1000	167	279	4.0038-260
WD274-260	150	187	260	135	110	80	10	80	5	566	1300	167	279	4.0274-260
WD088-300	140	190	300	140	110	80	10	86	8	549	1272	195	335	4.0088-300
WD084-340	140	240	340	150	120	89	10	100	8	785	1690	227	392	4.0084-340
WD275-390	170	242	390	200	150	118	11	100	8	1076	2535	227	392	4.0275-390

C: dynamic load Ca: axial dynamic load
Co: static load Coa: axial static load

T2

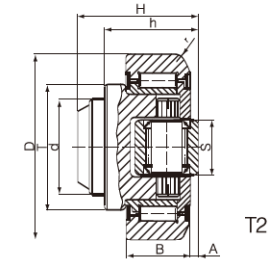
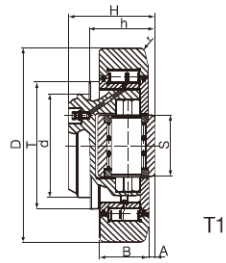

JUMBO Combined Bearings

Bearing Code	d	T	D	H	h	B	A	S	r	C	Co	Ca	Coa	Reference index		
	mm	mm	mm	Min – Max	Min – Max	mm	mm							mm	mm	KN
WD089	80	113	165	69 – 72	53 – 56	40	5	50	3	213	388	85	133	4.089	4.0089	MR.038A
WD090	100	124	190	84.5 – 87.5	64.5 – 67.5	48	6.5	60	4	266	500	100	180	4.090	4.0090	MR.012A
WD091	110	146	220	94.5 – 97.5	74.5 – 77.5	58	6.5	75	5	326	681	138	257	4.091	4.0091	MR.013A
WD092	120	168	250	102 – 105	77 – 80	60	7	75	5	369	748	138	257	4.092	4.0092	MR.014A
WD093	150	188	280	119.5 – 123.5	89.5 – 93.5	72	7.5	90	5	489	1066	182	488	4.093	4.0093	MR.015A

C: dynamic load Ca: axial dynamic load
 Co: static load Coa: axial static load

T1

Adjustable Combined Bearings with Eccentric Pin

Bearing Code	d	T	D	H	h	B	A	S	r	C	Co	Ca	Coa	Reference index		
	mm	mm	mm	Min – Max	Min – Max	mm	mm							mm	mm	KN
WD454	30	42	62	37.5 – 39	30.5 – 32	20	4	20	3	31	35.5	11	11	4.454	4.0454	KRES.062
WD455	35	48	70.1	44 – 45.5	36 – 37.5	23	4	20	4	45.5	51	11	11	4.455	4.0455	KRES.070
WD456	40	54	77.7	48 – 50	37 – 38.5	23	3.5	26	4	48	56.8	18	18	4.456	4.0456	KRES.078
WD457	40	54	77.7	40 – 41.5	29 – 30.5	23	3.5	26	4	48	56.8	18	18	4.457	4.0457	
WD458	45	59	88.4	57 – 58.5	44 – 45.5	30	4	26	4	68	72	23	23	4.458	4.0458	KRES.089
WD459	50	69	101.2	46 – 48	33 – 35	26	4.5	30	3	73	82	25	27	4.459	4.0459	
WD460	55	69	107.7	54 – 56	40 – 42	31	4	30	5	81	95	25	27	4.460	4.0460	
WD461	60	69	107.7	69 – 71	55 – 57	31	4	30	5	81	95	25	27	4.461	4.0461	KRES.108
WD462	60	80	123	72.3 – 76.3	56 – 60	37	4.5	34	5	110	132	31	36	4.462	4.0462	KRES.123
WD463	60	108	149	78.5 – 82.5	58.5 – 62.5	45	6	34	3	151	192	31	36	4.463	4.0463	KRES.149

C: dynamic load Ca: axial dynamic load
 Co: static load Coa: axial static load

T2

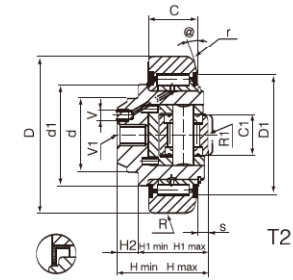
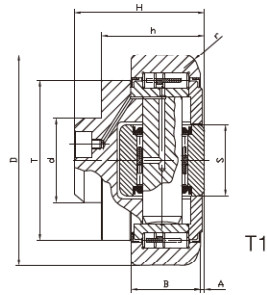

High Speed Combined Bearings

Bearing Code	d	T	D	H	h	B	A	S	r	C	Co	Ca	Coa	Reference index
	mm	mm	mm	mm	mm	mm	mm	mm	mm	KN	KN	KN	KN	Italy
WD235-89	45	59	88.9	57	44	30	3.5	26	3	46.6	50	26	32.2	4.0235-89
WD227-108	60	71	107.7	69	55	31	4	34	5	76	90	30	32	4.0227-108
WD228-123	60	80	123	72.3	56	37	5	40	5	106	120	42	46	4.0228-123
WD229-149	60	108	149	86	67	45	5	50	3	129	180	62	70	4.0229-149
WD230-185	80	120	185	90.5	76	55	7	65	7.5	170	250	80	104	4.0230-185

C: dynamic load Ca: axial dynamic load
Co: static load Coa: axial static load

T1

Adjustable Combined Bearings with Screw

Bearing Code	d	D	C	Hmin	Hmax	H1min	H1max	H2	D1	C1	d1	@	r	R	R1	S	V	V1	C	Co	CA	CoA	Grease	Mass	Reference index
	mm	mm	mm	mm	mm	mm	mm	mm	mm	mm	mm	degree	mm	mm	mm	mm	mm	mm	KN	KN	KN	KN	rev/min	Kg	Italy
WD964 (f)	45	88.9	30	48.5	51	36.5	39	12	68	21	59	20°	4	700	700	4	M6X1	M10	68	72	15	15	700	1.43	MR.964
WD965 (c, f)	50	101.9	28	46	48.5	33	35.5	13	77	24	67	20°	4	850	700	2.5	M6X1	M10	73	82	18	19	700	1.70	MR.965
WD966 (f)	55	107.7	31	53.5	56.5	41.5	44.5	12	82	30	71	20°	4	1000	700	6	M6X1	M16	81	95	31	36	650	2.45	MR.966
WD967 (f)	60	123	33	61.5	64.5	49.5	52.5	12	94	30	80	15°	4	1000	1000	6.5	M6X1	M16	110	132	31	36	500	3.50	MR.967
WD968 (f)	60	149	43	75.5	79	58.5	62	17	116	45	103	15°	4	1000	1000	6.8	M6X1	M16	151	192	68	71	400	6.50	MR.968

Remarks:

"a": non relubricatable "b": with plastic axial support only
"c": taper outer D profile "d": dimension S adjustable by means of screw DIN916
"e": References "f": for the axial support in oilamid

T2

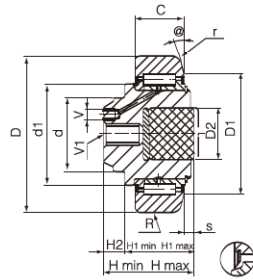

T1

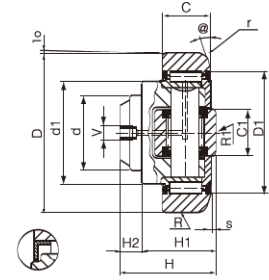

T2

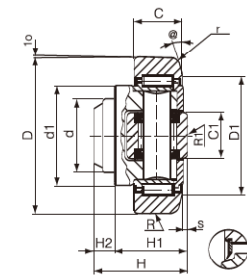

T2

Adjustable Combined Bearings with Plastic Axial Roller

Bearing Code	d	D	C	Hmin	Hmax	H1min	H1max	H2	D1	D2	d1	@	r	R	S	V	V1	C	Co	CA	CoA	Grease	Mass	Reference index
	mm	mm	mm	mm	mm	mm	mm	mm	mm	mm	mm	degree	mm	mm	mm	mm	mm	KN	KN	KN	KN	rev/min	Kg	Italy
WD961 (a, b)	30	62	20	38	40	30.5	32.5	7	50	26	42	20°	3	500	2.5		M10	31	35.5			900	0.52	MR.961
WD962 (b)	35	70.1	23	38.5	40.5	31.5	33.5	7	57	30	48	20°	3	500	3	M6X1	M10	45.5	51			900	0.60	MR.962
WD963 (b)	40	77.7	23	40.7	42.7	31.7	33.7	9	61	30	54	20°	3	700	4	M6X1	M10	48	56.8			800	0.82	MR.963
WD964 (f)	45	88.9	30	48.5	51	36.5	39	12	68	33	59	20°	4	700	4	M6X1	M10	68	72	15	15	700	1.43	MR.964
WD965 (c, f)	50	101.9	28	46	48.5	33	35.5	13	77	38	67	20°	4	850	2.5	M6X1	M10	73	82	18	19	700	1.70	MR.965
WD966 (f)	55	107.7	31	53.5	56.5	41.5	44.5	12	82	42	71	20°	4	1000	6	M6X1	M16	81	95	31	36	650	2.45	MR.966
WD967 (f)	60	123	33	61.5	64.5	49.5	52.5	12	94	42	80	15°	4	1000	6.5	M6X1	M16	110	132	31	36	500	3.50	MR.967
WD968 (f)	60	149	43	75.5	79	58.5	62	17	116	63	103	15°	4	1000	6.8	M6X1	M16	151	192	68	71	400	6.50	MR.968

Remarks:

- "a": non relubricatable
- "b": with plastic axial support only
- "c": taper outer D profile
- "d": dimension S adjustable by means of screw DIN916
- "e": References
- "f": for the axial support in oilamid

T1

Adjustable Combined Bearings for Steel Industry

Bearing Code	d	D	C	H	H1	H2	D1	C1	d1	S	@	r	R	R1	V	C	Co	CA	CoA	Speed	Grease	Mass	Reference index	
2Z	2RS	mm	mm	mm	mm	mm	mm	mm	mm	mm	degree	mm	mm	mm	mm	KN	KN	KN	KN	rpm	/Kg	Kg	Italy	
																							ZZ	2RS
WD031.2Z	WD031.2RS	35	70.35	23	40.5	30.5	10	57	22	48	2.5	20°	4	650	500		45.5	51	14	13	900	0.47	MR.031	MR.032
WD004.2Z	WD004.2RS	40	78.3	23	40.7	29	11.7	61	24	54	2.5	20°	4	700	700	M6X1	48	56.8	18	18	800	0.88	MR.004	MR.024
WD034.2Z	WD034.2RS	45	89.25	30	50	37.5	12.5	68	26	59	3	20°	4	850	700	M6X1	68	72	23	23	800	1.58	MR.034	MR.035
WD006.2Z	WD006.2RS	50	101.9	28	46	33	13	77	30	67	2.5	20°	4	850	700	M6X1	73	82	25	27	700	1.72	MR.006	MR.026
WD008.2Z	WD008.2RS	55	108.55	31	53	39	14	82	34	71	3.5	20°	4	1000	700	M6X1	81	95	31	36	700	2.22	MR.008	MR.028
WD040.2Z	WD040.2RS	60	123.5	33	57	42	15	94	40	78	2.5	15°	4	1000	750	M6X1	105	108	32	39	500	3.20	MR.040	MR.041
WD016.2Z	WD016.2RS	60	129.4	33	56.5	42.5	14	94	40	78	2.5	10°	4	1000	750	M6X1	105	108	32	39	500	3.40	MR.016	
WD011.2Z	WD011.2RS	60	165	36	61	46	15	130	60	113	3	10°	4	1000	1000	M6X1	125	181	46	61	400	6.30	MR.011	

C: dynamic load Ca: axial dynamic load
 Co: static load Coa: axial static load

T2

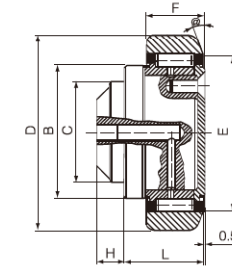
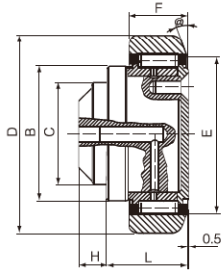

Standard Radial Bearings

Bearing Code	C	B	D	L	F	H	E	@	C	Co	Reference index	
	mm	mm	mm	mm	mm	mm	mm	degree	KN	KN	Germany	Italy
WD0856-62	25	42	62	23.5	20	7	50	20°	31	35.5		
WD0363-62	30	42	62	29.5	20	7	50	20°	31	35.5	2.054	MR.121
WD0360-70	35	48	70.1	33.5	23	8.2	57	20°	45.5	51	2.055	MR.122
WD0361-78	40	53	77.7	33.2	23	11.3	61	20°	48	56.8	2.056	MR.123
WD0448-88	45	59	88.9	41	30	13	68	20°	68	72	2.058	MR.125
WD1641-108	55	69	107.7	35	31	14	82	20°	81	95	2.060	MR.123
WD1641/1-108	60	69	107.7	50.5	31	14	82	20°	81	95	2.061	MR.127
WD1642-123	60	79	123	51.5	37	16.3	92	20°	110	132	2.062	MR.129
WD1643-149	60	103	149	54	43	20	116	15°	151	192	2.063	MR.130

Precise Radial Bearings

Bearing Code	C	B	D	L	F	H	E	@	C	Co	Reference index	
	mm	mm	mm	mm	mm	mm	mm	degree	KN	KN	Germany	
WD.P054	30	42	64.8	29.5	20	7	50	20°	31	35,5		PR2.054
WD.P055	35	48	73.8	34	23	8	57	20°	45.5	51		PR2.055
WD.P056	40	53	81.8	34	23	11.5	61	20°	48	56.8		PR2.056
WD.P058	45	59	92.8	41	30	13	68	20°	68	72		PR2.058
WD.P061	60	71	111.8	51.5	31	14	82	20°	81	95		PR2.061
WD.P062	60	80	127.8	51.5	37	16.3	92	20°	110	132		PR2.062
WD.P063	60	103	153.8	54	45	20	116	20°	151	192		PR2.063

Remarks: If the specifications are not listed above, please contact WD bearings.
 Email: sales@wd-bearing.com

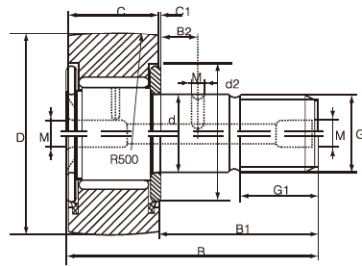

KR...PP

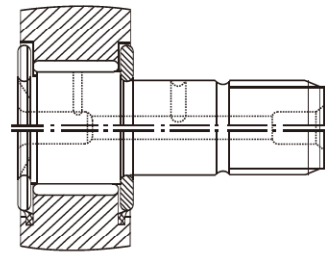

KRV...PP

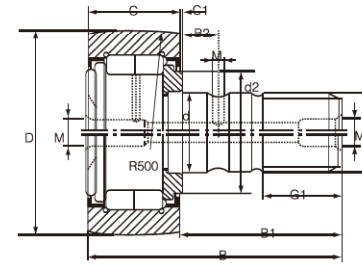

NUKR

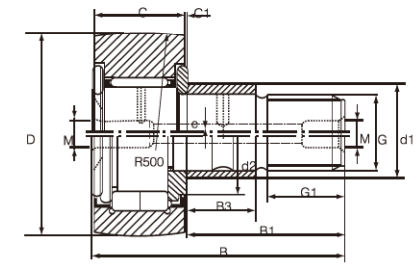

NUKRE

Stud Type Track Roller (Roller Type)

OD mm	Bearing Code and Approx Mass		Boundary Dimensions													Bearing Designation		Cr Dynamic N	Cor Static N	Basic Load Rating				Limiting Speed rpm		
	Without Eccentric Collar	Mass g	With Eccentric Collar	Mass g	D	d	C	B	B1	B2	G	G1	M	M1	C1	d2	d1			B3	e	Tightening Torque MA Nm	Cw		Cow	Fr perm N
16	KR 16	18	KRE 16	20	16	6	11	28	16	M6	8	4(5)	0.6	12	9	7	0.5	2.5	3650	6540	3020	3100			18000	
	KR 16 PP	18	KRE 16 PP	20	16	6	11	28	16	M6	8	4(5)	0.6	12	9	7	0.5	2.5	3650	6540	3020	3100			12000	
	KRV 16	20	KRVE 16	22	16	6	11	28	16	M6	8	4(5)	0.6	12	9	7	0.5	2.5	6000	8000	4610	6000			7200	
19	KR 19	28	KRE 19	31.2	19	8	11	32	20	M8	10	4(5)	0.6	14	11	9	0.5	6.8	3820	4160	3220	3100			16000	
	KR 19 PP	28	KRE 19 PP	31.2	19	8	11	32	20	M8	10	4(5)	0.6	14	11	9	0.5	6.8	3820	4160	3220	3100			11300	
	KRV 19	32	KRVE 19	35.2	19	8	11	32	20	M8	10	4(5)	0.6	14	11	9	0.5	6.8	6300	9800	5000	6900			6000	
22	KR 22	44	KRE 22	48.3	22	10	12	36	23	M10x1	12	4	0.6	17	13	10	0.5	12.5	4770	5010	3450	4020			10000	
	KR 22 PP	44	KRE 22 PP	48.3	22	10	12	36	23	M10x1	12	4	0.6	17	13	10	0.5	12.5	4770	5010	3450	4020			9000	
	KRV 22	45	KRVE 22	49.3	22	10	12	36	23	M10x1	12	4	0.6	17	13	10	0.5	12.5	6200	9900	5300	7100			4500	
26	KR 26	58	KRE 26	62.3	26	10	12	36	23	M10x1	12	4	0.6	17	13	10	0.5	12.5	4100	5500	4100	5200			10000	
	KR 26 PP	58	KRE 26 PP	62.3	26	10	12	36	23	M10x1	12	4	0.6	17	13	10	0.5	12.5	4100	5500	4100	5200			9100	
	KRV 26	61	KRVE 26	65.3	26	10	12	36	23	M10x1	12	4	0.6	17	13	10	0.5	12.5	6600	9900	5320	8900			4300	
30	KR 30	87	KRE 30	92.5	30	12	14	40	25	6	M12x1.513	6	3	0.6	23	15	11	0.5	18.2	6140	7700	5820	6400			9000
	KR 30 PP	87	KRE 30 PP	92.5	30	12	14	40	25	6	M12x1.513	6	3	0.6	23	15	11	0.5	18.2	6140	7700	5820	6400			6300
	KRV 30	89	KRVE 30	94.5	30	12	14	40	25	6	M12x1.513	6	3	0.6	23	15	11	0.5	18.2	9200	10100	7500	10600			3200
32	KR 32	98	KRE 32	103.5	32	12	14	40	25	6	M12x1.513	6	3	0.6	23	15	11	0.5	18.2	6100	8700	5100	7001			9000
	KR 32 PP	98	KRE 32 PP	103.5	32	12	14	40	25	6	M12x1.513	6	3	0.6	23	15	11	0.5	18.2	6100	8700	5100	7001			6300
	KRV 32	100	KRVE 32	105.5	32	12	14	40	25	6	M12x1.513	6	3	0.6	23	15	11	0.5	18.2	8220	12600	8000	11800			3220
35	KR 35	169	KRE 35	181.5	35	16	18	52	32.5	8	M16x1.517	6	3	0.8	27	20	14	1	45.8	9900	15000	7900	10100			5800
	KR 35 PP	169	KRE 35 PP	181.5	35	16	18	52	32.5	8	M16x1.517	6	3	0.8	27	20	14	1	45.8	9900	15000	7900	10100			5800

1. Suffix designation "X": columned surface. For example, NUKR52X

2. Usually when the columned outer ring is mounted into the housing in normal tolerance, Cr and Cor is working; When the outer ring is used as track roller, Cw and Cow is working.

3. Limiting speed for oil lubrication: about 30% higher than the one of grease; Limiting speed for sealed types will be exception.

4. NUKRE: 35 B1=31.5; C1=1.8; d2=24 NUKRE 40: B1=35.5; C1=1.8; d2=26

5. Lubrication hole is in side-face of the side with slinger for stud

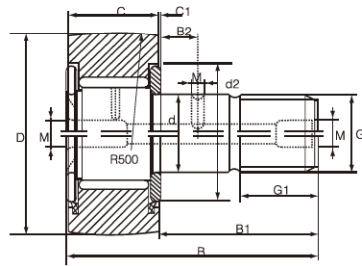

KR...PP

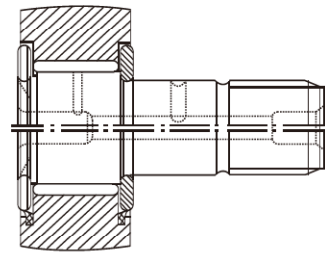

KRV...PP

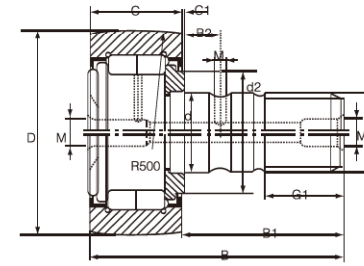

NUKR

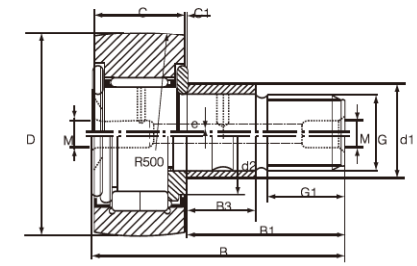

NUKRE

Stud Type Track Roller (Roller Type)

OD	Bearing Code and Approx Mass				Boundary Dimensions										Bearing Designation			Cr Dynamic	Cor Static	Basic Load Rating				Limiting Speed				
	Without Eccentric	Mass	With Eccentric	Mass	D	d	C	B	B1	B2	G	G1	M	M1	C1	d2	d1			B3	e	Tightening Torque MA	N		N	N	N	N
mm	Collar	g	Collar	g	mm										mm	Nm	N	N	N	N	N	N	N	rpm				
35	KRV 35	171	KRVE 35	183.5	35	16	18	52	32.5	8	M16x1.5	17	6	3	0.8	27	20	14	1	45.8	10300	24000	9800	16000				2800
	KRV 35 PP	171	KRVE 35 PP	183.5	35	16	18	52	32.5	8	M16x1.5	17	6	3	0.8	27	20	14	1	45.8	10300	24000	9800	16000				2800
	NUKR 35	164	NUKRE 35	176.5	35	16	18	52	32.5	8	M16x1.5	17	6	3	0.8	27	20	14	1	45.8	15100	19980	10120	16300	8300	16400		4320
	KR 40	247	KRE 40	262.8	40	18	20	58	36.5	8	M18x1.5	19	6	3	0.8	32	22	16	1	68.7	9290	11400	8100	11500				4200
	KR 40 PP	247	KRE 40 PP	262.8	40	18	20	58	36.5	8	M18x1.5	19	6	3	0.8	32	22	16	1	68.7	9290	11400	8100	11500				4200
40	KRV 40	249	KRVE 40	264.8	40	18	20	58	36.5	8	M18x1.5	19	6	3	0.8	32	22	16	1	68.7	11200	23500	10800	18500				2100
	KRV 40 PP	249	KRVE 40 PP	264.8	40	18	20	58	36.5	8	M18x1.5	19	6	3	0.8	32	22	16	1	68.7	13800	18000	12500	18800	13200	22800		4210
	NUKR 40	242	NUKRE 40	257.8	40	18	20	58	36.5	8	M18x1.5	19	6	3	0.8	32	24	18	1	101	12500	22000	10500	20500				3900
	KR 47	386	KRE 47	405.5	47	20	24	66	40.5	9	M20x1.5	21	8	4	0.8	37	24	18	1	101	12500	22000	10500	20500				3900
	KR 47 PP	386	KRE 47 PP	405.5	47	20	24	66	40.5	9	M20x1.5	21	8	4	0.8	37	24	18	1	101	16000	41000	16600	32000				1800
47	KRV 47	390	KRVE 47	409.5	47	20	24	66	40.5	9	M20x1.5	21	8	4	0.8	37	24	18	1	101	16000	41000	16600	32000				1800
	KRV 47 PP	390	KRVE 47 PP	409.5	47	20	24	66	40.5	9	M20x1.5	21	8	4	0.8	37	24	18	1	101	30200	40000	18900	28500	10500	30000		3200
	NUKR 47	380	NUKRE 47	399.5	47	20	24	66	40.5	9	M20x1.5	21	8	4	0.8	37	24	18	1	101	10500	21000	10800	22500				3990
	KR 52	461	KRE 52	480.5	52	20	24	66	40.5	9	M20x1.5	21	8	4	0.8	37	24	18	1	101	10500	21000	10800	22500				3990
	KR 52 PP	461	KRE 52 PP	480.5	52	20	24	66	40.5	9	M20x1.5	21	8	4	0.8	37	24	18	1	101	22000	39000	10500	38100				1800
52	KRV 52	465	KRVE 52	484.5	52	20	24	66	40.5	9	M20x1.5	21	8	4	0.8	37	24	18	1	101	22000	39000	10500	38100				1800
	KRV 52 PP	465	KRVE 52 PP	484.5	52	20	24	66	40.5	9	M20x1.5	21	8	4	0.8	37	24	18	1	101	37500	49300	15001	22503	10400	30500		1990
	NUKR 52	450	NUKRE 52	469.5	52	20	24	66	40.5	9	M20x1.5	21	8	4	0.8	31	28	22	1	205	20500	33000	16500	31500				2100
	KR 62	790	KRE 62	818.2	62	24	29	80	49.5	11	M24x1.5	25	8	4	0.8	44	28	22	1	205	20500	33000	16500	31500				2100
	KR 62 PP	790	KRE 62 PP	818.2	62	24	29	80	49.5	11	M24x1.5	25	8	4	0.8	44	28	22	1	205	31700	61000	29600	56000				1300
62	KRV 62	802	KRVE 62	830.2	62	24	29	80	49.5	11	M24x1.5	25	8	4	0.8	44	28	22	1	205	31700	61000	29600	56000				1300
	KRV 62 PP	802	KRVE 62 PP	830.2	62	24	29	80	49.5	11	M24x1.5	25	8	4	0.8	44	28	22	1	205	41000	59300	40500	51000	18800	39500		13000
	NUKR 62	795	NUKRE 62	823.5	62	24	29	80	49.5	11	M24x1.5	25	8	4	0.8	38												

1. Suffix designation "X": columned surface. For example, NUKR52X

2. Usually when the columned outer ring is mounted into the housing in normal tolerance, Cr and Cor is working; When the outer ring is used as track roller, Cw and Cow is working.

3. Limiting speed for oil lubrication: about 30% higher than the one of grease; Limiting speed for sealed types will be exception.

4. NUKRE: 35 B1=31.5; C1=1.8; d2=24 NUKRE 40: B1=35.5; C1=1.8; d2=26

5. Lubrication hole is in side-face of the side with slinger for stud

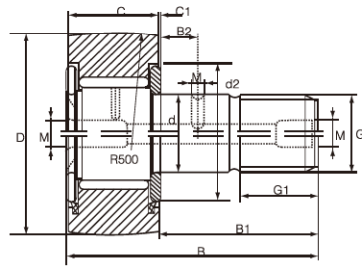

KR...PP

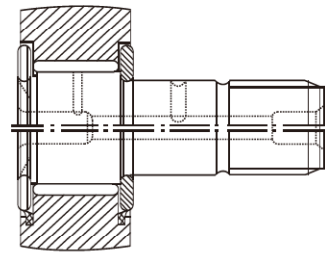

KRV...PP

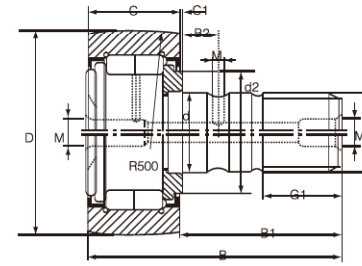

NUKR

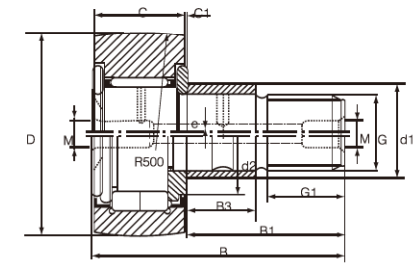

NUKRE

Stud Type Track Roller (Roller Type)

OD	Bearing Code and Approx Mass				Boundary Dimensions											Bearing Designation	Nut	Cr	Cor	Basic Load Rating				Limiting Speed			
	Without Eccentric	Mass	With Eccentric	Mass	D	d	C	B	B1	B2	G	G1	M	M1	C1					d2	d1	B3	e		Tightening Torque MA	Dynamic	Static
mm	Collar	g	Collar	g	mm											mm	Nm	N	N	N	N	N	N	N	N	N	rpm
72	KR 72	1040	KRE 72	1068.2	72	24	29	80	49.5	11	M24x1.5	25	8	4	0.8	44	28	22	1	205	20500	503000	25000	50890			2800
	KR 72 PP	1040	KRE 72 PP	1068.2	72	24	29	80	49.5	11	M24x1.5	25	8	4	0.8	44	28	22	1	205	20500	50000	25000	50890			2800
80	KRV 72	1045	KRVE 72	1073.2	72	24	29	80	49.5	11	M24x1.5	25	8	4	0.8	44	28	22	1	205	31500	71000	27000	75000			1200
	KRV 72 PP	1045	KRVE 72 PP	1073.2	72	24	29	80	49.5	11	M24x1.5	25	8	4	0.8	44	28	22	1	205	31500	71000	27000	75000			1200
85	NUKR 72	1200	NUKRE 72	1038.2	72	24	29	80	49.5	11	M24x1.5	25	8	4	0.8	44	28	22	1	205	45000	63000	35000	41000	23500	51000	1020
	KR 80	1550	KRE 80	1610	80	30	35	100	63	15	M30x1.5	32	8	4	1	53	35	29	1.5	351	40800	75300	24500	57000			2030
90	KR 80 PP	1550	KRE 80 PP	1610	80	30	35	100	63	15	M30x1.5	32	8	4	1	53	35	29	1.5	351	40800	75300	24500	57000			2030
	KRV 80	1561	KRVE 80	1621	80	30	35	100	63	15	M30x1.5	32	8	4	1	53	35	29	1.5	351	46000	102000	39900	100600			1000
90	KRV 80 PP	1561	KRVE 80 PP	1621	80	30	35	100	63	15	M30x1.5	32	8	4	1	53	35	29	1.5	351	46000	102000	39900	100600			1000
	NUKR 80	1800	NUKRE 80	1600	80	30	35	100	63	15	M30x1.5	32	8	4	1	47	35	29	1.5	351	75000	103600	50200	71000	34900	72000	1200
90	KR 85	1740	KRE 85	1800	85	30	35	100	63	15	M30x1.5	32	8	4	1	53	35	29	1.5	351	38700	64300	29900	69000			1840
	KR 85 PP	1740	KRE 85 PP	1800	85	30	35	100	63	15	M30x1.5	32	8	4	1	53	35	29	1.5	351	38700	64300	29900	69000			1840
90	KR 90	1950	KRE 90	2010	90	30	35	100	63	15	M30x1.5	32	8	4	1	53	35	29	1.5	351	38700	64300	29900	69000			1840
	KR 90 PP	1950	KRE 90 PP	2010	90	30	35	100	63	15	M30x1.5	32	8	4	1	53	35	29	1.5	351	38700	64300	29900	69000			1840
90	KRV 90	1970	KRVE 90	2030	90	30	35	100	63	15	M30x1.5	32	8	4	1	53	35	29	1.5	351	48970	102300	38800	100000			1600
	KRV 90 PP	1970	KRVE 90 PP	2030	90	30	35	100	63	15	M30x1.5	32	8	4	1	53	35	29	1.5	351	48970	102300	38800	100000			1600
90	NUKR 90	2300	NUKRE 90	2020	90	30	35	100	63	15	M30x1.5	32	8	4	1	53	35	29	1.5	351	7500	103300	51400	93000	58000	97000	1500

1. Suffix designation "X": columned surface. For example, NUKR52X

2. Usually when the columned outer ring is mounted into the housing in normal tolerance, Cr and Cor is working; When the outer ring is used as track roller, Cw and Cow is working.

3. Limiting speed for oil lubrication: about 30% higher than the one of grease; Limiting speed for sealed types will be exception.

4. NUKRE: 35 B1=31.5; C1=1.8; d2=24 NUKRE 40: B1=35.5; C1=1.8; d2=26

5. Lubrication hole is in side-face of the side with slinger for stud

Cam Followers

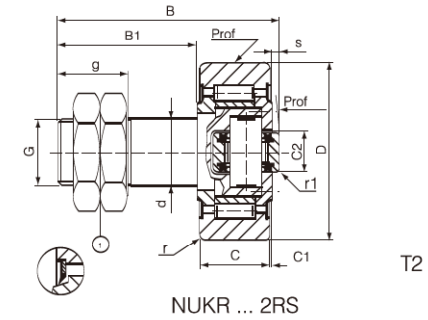
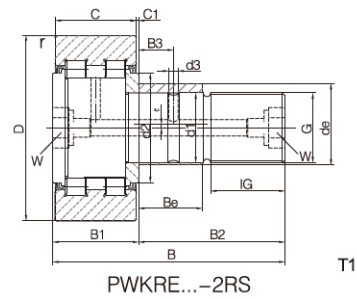
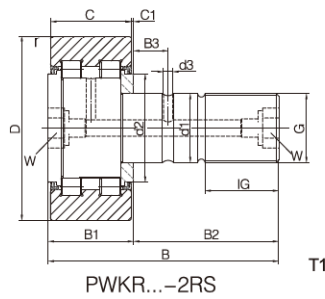

Stud Type Track Roller (Roller Type)

without eccentric collar	Bearing Code		Boundary dimensions										Basic load rating										
	mass g	With eccentric collar g	mass g	d1 mm	D mm	B mm	B1max mm	B2 mm	B3 mm	r mm	C mm	C1 mm	d2 mm	d3 mm	G mm	IG mm	W mm	de mm	Be mm	e mm	Crw N	Corw N	Limiting speed rpm
PWKR35-2RS	164	PWKRE35-2RS	177	16	35	52	19.6	32.5	7.8	1.5	18	0.8	20	3	M16X1.5	17	8	20	12	1	11900	14600	6000
PWKR40-2RS	242	PWKRE40-2RS	258	18	40	58	21.6	36.5	8	1.5	20	0.8	22	3	M18X1.5	19	8	22	14	1	13600	17200	5000
PWKR47-2RS	380	PWKRE47-2RS	400	20	47	66	25.6	40.5	9	1.5	24	0.8	27	4	M20X1.5	21	10	24	18	1	23800	30500	3800
PWKR52-2RS	450	PWKRE52-2RS	470	20	52	66	25.6	40.5	9	1.5	24	0.8	31	4	M20X1.5	21	10	24	18	1	24600	33000	3800
PWKR62-2RS	795	PWKRE62-2RS	824	24	62	80	30.6	49.5	11	2	28	1.3	38	4	M24X1.5	25	14	28	22	1	34000	45500	2200
PWKR72-2RS	1020	PWKRE72-2RS	1050	24	72	80	30.6	49.5	11	2	28	1.3	44	4	M24X1.5	25	14	28	22	1	38000	54000	2200
PWKR80-2RS	1600	PWKRE80-2RS	1670	30	80	100	37	63	15	2	35	1	47	4	M30X1.5	32	14	35	29	1.5	55000	79000	1800
PWKR90-2RS	1960	PWKRE90-2RS	2020	30	90	100	37	63	15	2	35	1	47	4	M30X1.5	32	14	35	29	1.5	62000	90000	1800

T1

“NUKRA” Combined Stud Type Track Rollers

Bearing Code	d mm	D mm	C mm	B mm	B1 mm	C2 mm	C1 mm	s mm	r mm	r1 mm	G mm	g mm	C KN	Co KN	Ca mm	Coa mm	Mass Kg	Reference index Italy
NUKRA52-2RS	20	52	22	66	40.5	13	0.8	2	1.5	1	M20X1.5	21	28	36	2.9	2.7	0.55	CFA 52 2RS
NUKRA62-2RS	24	62	26	80	49.5	15	1	2.5	1.5	1	M24X1.5	25	39	50	6.4	8.5	0.95	CFA 62 2RS
NUKRA72-2RS	24	72	26	80	49.5	15	1	2.5	2	1	M24X1.5	25	44	61	6.4	8.5	1.15	CFA 72 2RS
NUKRA80-2RS	30	80	32	100	63	18	1	3	2	1.5	M30X1.5	32	65	61	10	9.9	1.6	CFA 80 2RS
NUKRA90-2RS	30	90	32	100	63	18	1	2	2	1.5	M30X1.5	32	74	105	10.5	10.6	1.9	CFA 90 2RS

T2

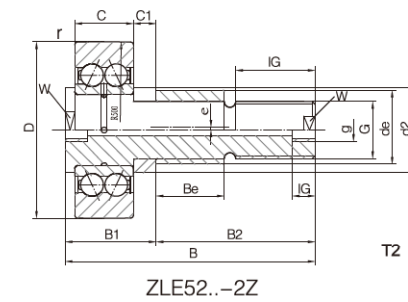
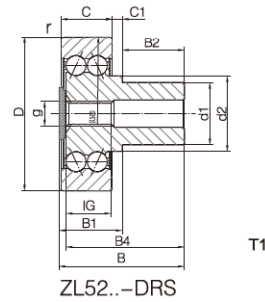
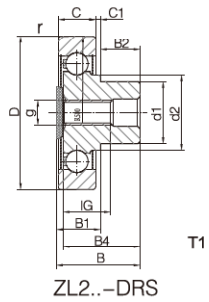

Stud Type Track Roller (Ball Type)

Bearing Code	Boundary dimensions											Basic load rating			
	d1	D	B	B1max	B2	B4	C	C1	d2	g	IG	rmin	Crw	Corw	mass
	mm	mm	mm	mm	mm	mm	mm	mm	mm	mm	mm	mm	N	N	g
ZL202-DRS	16	40	23.8	14	10	21.5	11	2	20	M8	15	0.6	6600	3350	0.08
ZL203-DRS	18	47	26.5	14.5	12	24.5	12	2	22.9	M8	16	0.6	8500	4450	0.12
ZL204-DRS	20	52	30.7	17	14	28.5	14	2	26.8	M10	18	1	10600	5700	0.17
ZL205-DRS	25	62	33.8	18	16	31	15	2	30.3	M10	19	1	12500	7100	0.25
ZL5201-DRS	14	35	33.2	19.5	14	31	15.9	2.6	17.1	M8	14	0.6	8700	5200	0.09
ZL5202-DRS	16	40	36.2	20.5	16	34	15.9	3.5	20	M8	15	0.6	10000	6300	0.12
ZL5203-DRS	18	47	39.5	21.5	18	37.5	17.5	3.5	22.9	M8	15	0.6	12800	8400	0.19
ZL5204-DRS	20	52	45.3	25.5	20	43	20.6	4	26.8	M10	18	1	16100	10700	0.25
ZL5205-DRS	25	62	50.4	25.5	25	47.5	20.6	4	30.3	M10	18	1	18800	13300	0.38
ZL5206-DRS	30	72	59	29	30	56.5	23.8	4.5	37.3	M16	20	1	25000	18100	0.55
ZL5207-DRS	35	80	69.2	33.5	36	66.5	27	5.5	42.4	M16	20	1.1	31000	22800	0.71

T1

Stud Type Track Roller (Ball Type)

Bearing Code	Boundary dimensions										Basic load rating									
	de	D	B	B1max	B2	Be	C	C1	d2	e	G	g	IG	IG	rmin	W	W1	Crw	Corw	mass
	mm	mm	mm	mm	mm	mm	mm	mm	mm	mm	mm	mm	mm	mm	mm	mm	mm	N	N	Kg
ZLE5201-2Z	18	35	65.5	20.5	45	18	15.9	2	25	1	M12X1.5	M6	24	6	0.6	15	9	8700	5200	0.25
ZLE5202-2Z	22	40	66.5	21.5	45	16	15.9	2.5	27	1	M14	M8X1	25	8	0.6	17	10	10000	6300	0.35
ZLE5204-2Z	24	52	76	26	50	18	20.6	2.5	30	1	M20X1.5	M8X1	29	8	1	22	17	16200	10700	0.46
ZLE5205-2Z	24	62	88	32	56	25	20.6	8	30	1	M20X1.5	M8X1	28	8	1	22	17	18800	13200	0.64
ZLE5207-2Z	35	80	99	35	64	29	27	3	45	1.5	M30X1.5	M8X1	32	8	1.1	40	27	31000	22800	1.3

T2

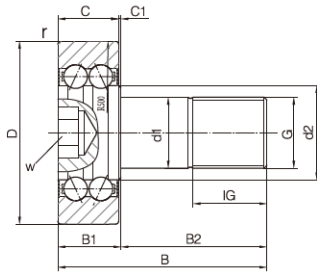

Stud Type Track Roller (Ball Type)

Bearing Code	Boundary dimensions										Basic load rating				
	d1	D	B	B1max	B2	C	C1	d2	G	IG	rmin	W	Crw	Corw	Mass
	mm	mm	mm	mm	mm	mm	mm	mm	mm	mm	mm	mm	N	N	Kg
KR5201-2RS	12	35	49.2	17	32.5	15.9	0.8	17.1	M12X1.5	17	0.6	6	8700	5200	0.12
KR5202-2RS	16	40	53.2	17	36.5	15.9	0.8	20	M16X1.5	19	0.6	8	10000	6300	0.19
KR5203-2RS	18	47	58.8	18.5	40.5	17.5	0.8	22.9	M18X1.5	21	0.6	8	12800	8400	0.29
KR5204-2RS	20	52	63.6	22.5	41.5	20.6	1.5	26.8	M20X1.5	21	1	10	16100	10700	0.38
KR5205-2RS	24	62	70.9	21.5	49.5	20.6	0.8	30.3	M24X1.5	25	1	10	18800	13200	0.58
KR5206-2RS	24	72	74.1	25	49.5	23.8	0.8	37.3	M24X1.5	25	1	10	25000	18100	0.8
KR5207-2RS	30	80	91	28	63	27	1	42.4	M30X1.5	32	1.1	12	31000	22800	1.2

Mast Rollers and Chain Pulleys

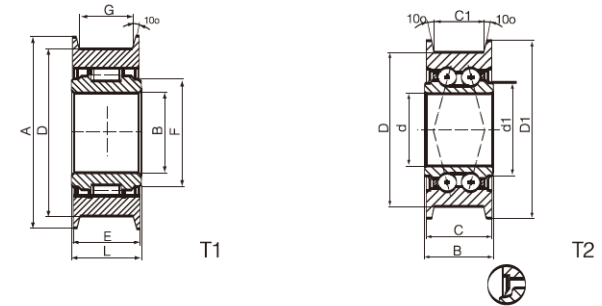

Chain Pulley (Cylindrical Roller)

Bearing Code	B	D	L	E	G	A	F	C	Co	Mass	Reference index		
	mm	mm	mm	mm	mm	mm	mm	mm	KN	KN	Kg	Italy A	Italy B
NCL407026-2RS	40	70	26.5	25	19	78	50	44	46	0.5	2.0247 / 2-70	MR.051	
NCL408028-2RS	40	80	28	26	19	90	50	50	54	0.75	2.1644 / 2-80	MR.052	
NCL408538-2RS	40	85	38	36	28	98	50	64	70	1.2	2.1080 / 2-85	MR.053	
NCL408043-2RS	40	80	43	41	33	98	50	81	87	1.2	2.0252-80	MR.054	
NCL5010042-2RS	50	100	42	40	33	115	60	89	162	1.7	2.0241 / 2-100	MR.055	
NCL5511058-2RS	55	110	58	56	45	135	65	135	146	1.7	2.1190-110	MR.056	
NCL5513067-2RS	55	130	67	65	55	158	65	200	218	3.5	2.1191-130	MR.057	

T1

Chain Pulley (Double Row Angular Contact Ball Bearings)

Bearing Code	d	D	B	C	C1	D1	d1	C	Co	Mass	Reference index
	mm	mm	mm	mm	mm	mm	mm	KN	KN	kg	Italy
CL3208KTN-2RS	40	75	26	28	19	85	50	25	32	0.45	MRS.1240
CL3208K1TN-2RS	40	80	28	26	19	90	50	25	32	0.7	MRS.1239
CL3208K2TN-2RS	40	85	38	36	28	98	50	37	45	1.1	MRS.1238
CL3208K3TN-2RS	40	80	43	41	33	98	50	37	45	1.1	MRS.1237
CL3210KTN-2RS	50	100	42	40	33	115	60	52.8	58.5	1.5	MRS.1236
CL3211KTN-2RS	55	110	58	56	45	135	65	57.2	67	1.5	MRS.1235
CL3211K1TN-2RS	55	130	67	65	55	158	65	72.1	85	3.1	MRS.1234

T2

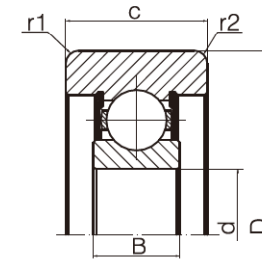
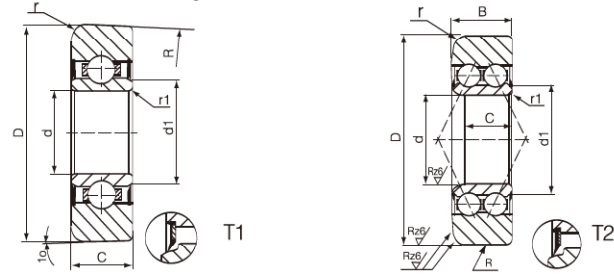

Mast Rollers (Single Row Ball Bearings)

Bearing Code	d	D	C	d1	r	r1	R	C	Co	Speed /grease rpm	Reference index Italy
CZ307022-2RS	30	70	22	40	5	1	500	19.6	13.7	1850	MR.0433
CZ307122-2RS	30	70.8	22	40	5	1	500	19.6	13.7	1850	MR.0434
CZ307822-2RS	30	78	22	40	5	1	500	19.6	13.7	1850	MR.0435
CZ307922-2RS	30	79	22	40	5	1	500	19.6	13.7	1850	MR.0436

T1

Mast Rollers (Double Row Angular Contact Ball Bearings)

Bearing Code	d	D	B	C	d1	r	r1	R	C	Co	Cw	Cow	Speed /grease rpm	Reference index Italy
3306K-2RS	30	70.2	23	19.2	38	5	1	500	30	21	25	18	7000	MR.1202
3306K1-2RS	30	77.7	23	19.2	38	5	1	500	30	21	25	18	7000	MR.1204
3308K-2RS	40	88.8	29	23.2	50	6	1	500	48	36	35	25	5000	MR.1219

T2

Mast Rollers (Single Row Deep Groove Ball Bearings)

Bearing Code	d	D	C	B	r1	r2
CZ257027X-2RS	25	70	27	15	2.5	2.5
CZ257028X-2RS	25	70	28	15	2.5	2.5
CZ257625X-2RS	25	76.2	25.2	17	2.5	4
CZ255718X-2RS	25.4	57.15	18.115	14	2.5	2.5
CZ257525X-2RS	25.4	74.6	25.4	17	2.5	4
CZ258022X-2RS	25	80	22	16	3	3
CZ307620X-2RS	30	76	20	19	3	5
CZ307629X-2RS	30	76.2	28.575	16	3	3
CZ308022X-2RS	30	80	22	17	3	3
CZ308129X-2RS	30	81	29	16.59	3	5
CZ308229X-2RS	30	81.5	29	16.59	3	5
CZ308229K1X-2RS	30	82	29	16.59	3	5
CZ308327X-2RS	30	82.55	26.975	19	3	5
CZ308829X-2RS	30	88	29	16.59	3	5
CZ308925X-2RS	30	88.9	25.4	19	3	5
CZ309022X-2RS	30	90	22	17	3	3
CZ358025X-2RS	35	80	25	21	3	3
CZ358227X-2RS	35	81.864	27.1	21	3	3
CZ358825X-2RS	35	88	25	21	3	5
CZ3588932-2RS	35	88.392	31.75	17	3	3
CZ359031X-2RS	35	90	31.34	21	3	3
CZ359428X-2RS	35	94	28	21	3	5
CZ359525X-2RS	35	94.5	25	17	3	3
CZ359525K1X-2RS	35	94.5	25.2	17	3	3
CZ359525K2X-2RS	35	94.615	25.4	21	3	5
CZ359528X-2RS	35	95	28	17	3	3
CZ359528K1X-2RS	35	95.2	28	21	3	5
CZ359728X-2RS	35	97	28	21	3	5
CZ3510026X-2RS	35	100	26	18	2	2
CZ3510032X-2RS	35	100.092	31.75	21	3	3
CZ3510137X-2RS	35	100.762	36.513	21	3	3
CZ3510129X-2RS	35	101.346	28.575	21	3	5
CZ3510129K1X-2RS	35	101.6	28.575	21	3	5
CZ3510225X-2RS	35	102	25.4	21	3	5
CZ3510528X-2RS	35	105	28	21	3	5

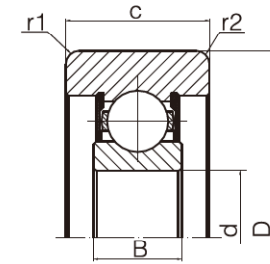
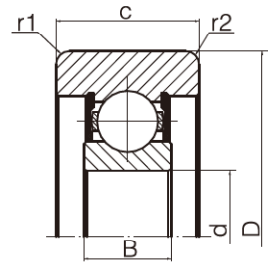

Mast Rollers (Single Row Deep Groove Ball Bearings)

Bearing Code	d	D	C	B	r1	r2
CZ3510831X-2RS	35	107.9	31	21	3	5
CZ3510931X-2RS	35	108.9	31	21	3	5
CZ3512028X-2RS	35	120	28	17	3	3
CZ3512028K1X-2RS	35	120	28	21	3	3
CZ3512030X-2RS	35	120	30.4	21	3	3
CZ409930X-2RS	40	99	30	23	3.5	10
CZ4010229X-2RS	40	101.6	28.575	23	3.5	10
CZ4010832X-2RS	40	108.1	32	23	3.5	10
CZ4011032X-2RS	40	109.7	32	23	3	7
CZ4011032K1X-2RS	40	110	32	23	3.5	10
CZ4011131X-2RS	40	110.7	31	23	3	3
CZ4011130X-2RS	40	111	30	23	3	10
CZ4011232X-2RS	40	111.8	32	23	3.5	10
CZ4011230X-2RS	40	112	30	23	3	10
CZ4011225X-2RS	40	112.3	24.5	18	3	3 or 8
CZ4011330X-2RS	40	113	30	23	3	10
CZ4011432X-2RS	40	113.944	31.75	23	3.5	10
CZ4011428X-2RS	40	114.2	28.194	23	3.5	10
CZ4011532X-2RS	40	115	32	23	6	6
CZ4011533X-2RS	40	115	33	23	3.5	10
CZ4011625X-2RS	40	116	24.5	18	3	3 or 8
CZ4012134X-2RS	40	120.5	34	23	3	3
CZ4510128X-2RS	45	100.956	28.437	19	3	5
CZ4511534X-2RS	45	114.5	34	25	3.5	10
CZ4511535X-2RS	45	115	35	25	3.5	10
CZ4511735X-2RS	45	117	40	25	3.5	10
CZ4511930X-2RS	45	119	30	25	3	3
CZ4512029X-2RS	45	119.72	29	29	5	5
CZ4512236X-2RS	45	121.5	36	25	3.5	10
CZ4512434X-2RS	45	123.5	34	25	3.5	10
CZ4512534X-2RS	45	124.5	34	25	3.5	10
CZ45112732X-2RS	45	127.063	31.75	25	3.5	10
CZ5011534X-2RS	50	115.3	34	25	3	3
CZ5012935X-2RS	50	129	35	27	3	3
CZ5110127X-2RS	50.8	101.092	27	27	5	5

Mast Rollers (Single Row Deep Groove Ball Bearings)

Bearing Code	d	D	C	B	r1	r2
CZ5110333X-2RS	50.8	103.27	32.542	19	5	5
CZ5511031X-2RS	55	110	31.34	21	3	3
CZ5511034X-2RS	55	110	34	21	5	5
CZ5511234X-2RS	55	112	34	21	5	5
CZ5511734X-2RS	55	117	34	25	5	5
CZ5512034X-2RS	55	120	34	25	5	5
CZ5512234X-2RS	55	121.5	34	25	5	5
CZ5514945X-2RS	55	149.43	45.3	29	5	5
CZ5515145X-2RS	55	151	45	33	4	4
CZ5515238X-2RS	55	152.476	38.1	29	3.5	10
CZ5516038X-2RS	55	159.892	38.1	29	3.5	10
CZ5516142X-2RS	55	161	42	33	5	5
CZ5516438X-2RS	55	164.287	38.1	29	3.5	10
CZ5516445X-2RS	55	164.46	45	29	3.5	10
CZ6015045X-2RS	60	149.5	44.7	31	3.5	10
CZ6015045K1X-2RS	60	150	45	35	6.5	6.5
CZ7518052X-2RS	75	179.5	52	40	5	12
CZ7518045X-2RS	75	180	45	40	5	5
CZ9022045X-2RS	90	220	45	43	5	12
CZ9022055X-2RS	90	220	55	43	7	7

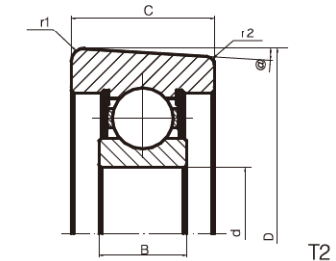
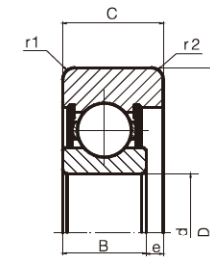
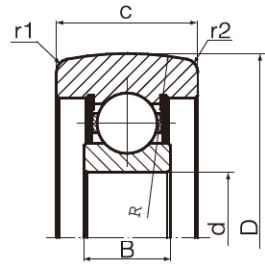

Mast Rollers (Single Row Deep Groove Ball Bearings)

Bearing Code	d	D	C	B	r1	r2	R
CZ307723-2RS	30	77	23	19	3	5	200
CZ307823-2RS	30	78	23	19	3	5	200
CZ307923-2RS	30	79	23	19	3	5	200
CZ359428-2RS	35	94	28	21	3	5	200
CZ359728-2RS	35	97	28	21	3	5	200
CZ3510128-2RS	35	101.343	28	21	3	5	200
CZ3510130-2RS	35	101.346	29.575	21	3	5	200
CZ3510228-2RS	35	102	28	21	3	5	200
CZ3510528-2RS	35	105	28	21	3	5	200
CZ409930-2RS	40	99	30	23	3	7	200
CZ4010030-2RS	40	100	30	23	5	8	200
CZ4010030-2RS	40	100	30	23	3	7	200
CZ4010130-2RS	40	101	30	23	3	7	200
CZ4010327-2RS	40	103	27	23	3	5.5	200
CZ4010427-2RS	40	104	27	23	3	5.5	200
CZ4010527-2RS	40	105	27	23	3	5.5	200
CZ4010931-2RS	40	108.6	31	23	5	8	200
CZ4011032-2RS	40	109.5	32	23	5	8	200
CZ4011532-2RS	40	115	32	23	5	8	200
CZ4511435-2RS	45	114	35	25	3	8	200
CZ4511435-2RS	45	114	35	25	5	8	200
CZ4511535-2RS	45	115	35	25	3	8	200
CZ4511535-2RS	45	115	35	25	5	8	200
CZ4511635-2RS	45	116	35	25	3	8	200
CZ4511740-2RS	45	117	40	25	5	8	200
CZ4511840-2RS	45	118	40	25	5	8	200
CZ4511940-2RS	45	119	40	25	5	8	200
CZ4512832-2RS	45	128.11	31.75	25	5	8	200
CZ5515245-2RS	55	151.5	45	29	8	8	500
CZ6518445-2RS	65	183.5	45	33	8	8	575

Mast Rollers (Single Row Deep Groove Ball Bearings)

Bearing Code	d	D	C	B	r1	r2	e
CZ206016KX-2RS	20	60	16	15	2	2	1
CZ257017KX-2RS	25	70	17	15	2.5	2.5	2
CZ307823KX-2RS	30	78	23	19	3.5	3.5	4
CZ309224KX-2RS	30	91.5	24	19	2	5	5
CZ309224K1X-2RS	30	91.5	24	20	2	5	4
CZ3510226KX-2RS	35	102	25.5	21	2	5	4.5
CZ3510225KX-2RS	35	102	25.4	20	3.5	3.5	5.4
CZ4010427KX-2RS	40	114	27	23	3.5	3.5	4
CZ4511929KX-2RS	45	119	29	25	3.5	3.5	4
CZ5515145KX-2RS	55	151	45	33	2	5	12

T1

Mast Rollers (Single Row Deep Groove Ball Bearings)

Bearing Code	d	D	C	B	r1	r2	@
CZ4011229-2RS	40	112.3	29	18	3	3 or 8	2° 30'
CZ4011028-2RS	40	109.7	28	23	7	5	3° 29'
CZ4511926-2RS	45	118.5	26	25	5	5	3° 29'
CZ5011834-2RS	50	117.5	34	25	5	5	3° 29'
CZ5511234-2RS	55	111.8	34	21	5	8	2° 30'
CZ5511231-2RS	55	112.2	31.34	21	3	3	2° 52'
CZ5511131-2RS	55	111.2	31.34	21	2	5	2° 52'
CZ5511631-2RS	55	116	31.34	21	2	5	2° 52'
CZ5511634-2RS	55	116	34	25	5	5	2° 52'
CZ5512334-2RS	55	122.5	34	25	5	8	2° 52'
CZ5512034-2RS	55	120	34	25	5	5	2° 52'
CZ5512136-2RS	55	121.4	36	25	5	8	2° 52'
CZ6516145-2RS	65	161	45	33	5	5	2° 52'

T2

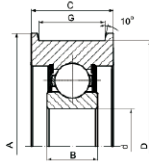

Chain Pulleys (Single Row Deep Groove Ball Bearings)

Bearing Code	d	D	C	B	A	G
CL307K-2RS	35	80	29	21	90	21
CL308K-2RS	40	100	36	23	114	28
CL308K1-2RS	40	123	36	23	138	28
CL309K-2RS	45	110	40	25	123	31
CL310K-2RS	50	122	46	27	141	34

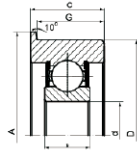

Chain Pulleys (Single Row Deep Groove Ball Bearings)

Bearing Code	d	D	C	B	A	G
F6307K-2RS	35	80	25	21	90	20
F6307K1-2RS	35	80	30	21	90	23
F6308K-2RS	40	100	35	23	114	28
F6309K-2RS	45	110	40	25	123	31
F6310K-2RS	50	122	42	27	141	34

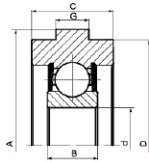

Chain Pulleys (Single Row Deep Groove Ball Bearings)

Bearing Code	d	D	C	B	A	G
YS6307K-2RS	35	77	25	21	88	15
YS6308K-2RS	40	88	28	23	100	18
YS6309K-2RS	45	100	28	25	110	18
YS6310K-2RS	50	115	30	27	129	18

Cam Rollers

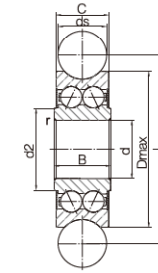

Track Rollers with Profiled Outer Ring

Bearing Code	Boundary dimensions							Basic load rating			
	d	Dmax	B	C	d2	ds	AT	rmin	Crw	Corw	Mass
	mm	mm	mm	mm	mm	mm	mm	mm	N	N	Kg
LFR50/5-4-KDD	5	16	8	7	7.9	4	9	0.2	1200	860	0.01
LFR50/5-KDD	5	17	8	7	8	6	10.5	0.2	1630	900	0.01
LFR50/8-KDD	8	24	11	11	10.5	6	14	0.3	4100	2300	0.02
LFR5201-KDD	12	35	15.9	15.9	17.1	10	20.65	0.6	8300	5000	0.08
LFR5201-12-KDD	12	35	15.9	15.9	17.1	12	21.75	0.6	8300	5000	0.08
LFR5301-KDD	12	42	19	19	18	10	24	0.6	13200	7700	0.1
LFR5302-KDD	15	47	19	19	21.7	10	26.65	1	14500	9100	0.17
LFR5204-16-KDD	20	52	22.6	20.6	26.5	16	31.5	1	15300	10100	0.23
LFR5206-16-KDD	25	72	25.8	23.8	37.4	20	41	1	23200	16500	0.25
LFR5206-25-KDD	25	72	25.8	23.8	37.4	25	43.5	1	22700	16100	0.25
LFR5207-30-KDD	30	80	29	27	42.4	30	51	1	28500	20800	0.66
LFR5208-40-KDD	40	98	38	36	48.4	40	62.5	1.1	38500	29000	1.36
LFR5308-50-KDD	40	110	46	44	52.5	50	72.5	1.1	53000	39500	1.4

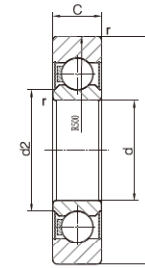
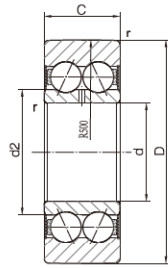

Track Rollers

Bearing Code	Boundary dimensions					Basic load rating		
	d mm	D mm	C mm	d2 mm	rmin mm	Crw N	Corw N	Mass Kg
LR50/5-2RS	5	17	7	8.2	0.2	1690	940	0.01
LR50/6-2RS	6	19	9	9.3	0.3	2700	1370	0.02
LR50/7-2RS	7	22	10	10.5	0.3	3350	1720	0.02
LR50/8-2RS	8	24	11	10.5	0.3	4300	2390	0.03
LR5000-2RS	10	28	12	13.5	0.3	4800	2850	0.03
LR5001-2RS	12	30	12	15.5	0.3	5100	3100	0.03
LR5002-2RS	15	35	13	20.4	0.3	6600	4150	0.03
LR5003-2RS	17	40	14	21.6	0.3	7800	5300	0.03
LR5004-2RS	20	47	16	25.2	0.6	11700	7700	0.12
LR5005-2RS	25	52	16	29.8	0.6	11800	8200	0.15
LR5006-2RS	30	62	19	35.5	1	16100	11900	0.25
LR5007-2RS	35	68	20	41.7	1	17900	13300	0.3
LR5200-2RS	10	32	14	15.4	0.6	6800	4100	0.07
LR5201-2RS	12	35	15.9	17.1	0.6	8700	5200	0.08
LR5202-2RS	15	40	15.9	20	0.6	10000	6300	0.11
LR5203-2RS	17	47	17.5	22.5	0.6	12800	8300	0.17
LR5204-2RS	20	52	20.6	26.5	1	16200	10700	0.23
LR5205-2RS	25	62	20.6	30.3	1	18800	13200	0.34
LR5206-2RS	30	72	23.8	37.4	1	25000	18000	0.51
LR5207-2RS	35	80	27	42.4	1.1	31000	22800	0.66
LR5208-2RS	40	85	30.2	48.4	1.1	35000	26000	0.75
LR5303-2RS	17	52	22.2	23.5	1	17600	11300	0.21
LR5304-2RS	20	62	22.2	29	1.1	21600	14800	0.34
LR5305-2RS	25	72	25.4	34.4	1.1	28000	19900	0.5
LR5306-2RS	30	80	30.2	41.4	1.1	36000	25500	0.67
LR5307-2RS	35	90	34.9	47.7	1.5	44000	32500	0.97
LR5308-2RS	40	100	36.5	52.4	1.5	55000	40500	1.2

Track Rollers

Bearing Code	Boundary dimensions					Basic load rating		
	d mm	D mm	C mm	d2 mm	rmin mm	Crw N	Corw N	Mass Kg
LR604-2RS	4	13	4	6.1	0.2	870	350	0.01
LR605-2RS	5	16	5	7.5	0.2	1220	510	0.01
LR606-2RS	6	19	6	8.7	0.3	1830	790	0.01
LR607-2RS	7	22	6	9	0.3	2130	880	0.01
LR608-2RS	8	24	7	10	0.3	2750	1240	0.02
LR6000-2RS	10	28	8	14.6	0.3	3650	2490	0.02
LR6001-2RS	12	30	8	16.6	0.3	3850	2750	0.03
LR200-2RS	10	32	9	15.4	0.6	4400	2150	0.05
LR201-2RS	12	35	10	18.3	0.6	5600	2700	0.05
LR202-2RS	15	40	11	21	0.6	6600	3350	0.07
LR203-2RS	17	47	12	24	0.6	8500	4450	0.11
LR204-2RS	20	52	14	29	1	10600	5700	0.15
LR205-2RS	25	62	15	33.5	1	12500	7100	0.23
LR206-2RS	30	72	16	37.4	1	16600	9700	0.33
LR207-2RS	35	80	17	42.4	1.1	20400	12100	0.4
LR209-2RS	45	90	19	53.2	1.1	22400	13700	0.5

Support Rollers

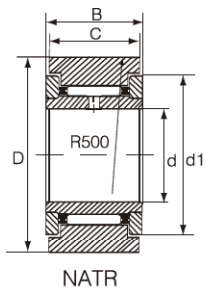

NATR

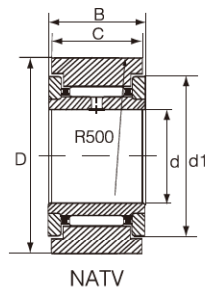

NATV

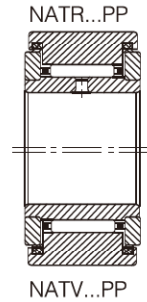

NATR...PP

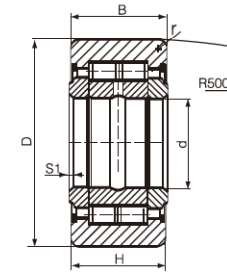

Yoke Type Track Rollers

Shaft Diameter mm	Bearing Code and Approx Mass		Boundary Dimensions						Basic Load Rating		Limiting Speed	
	Mass		d	D	B	C	d1	Cr Dynamic N	Cor Static N	Grease rpm		
	Without Seal g	Sealed g										
16	NATR5	14	NATR5PP	14	5	16	12	11	12	3050	3000	22000
	NATV5	15	NATV5PP	15	5	16	12	11	12	4500	6300	8500
19	NATR6	20	NATR6PP	20	6	19	12	11	14	3600	36500	20000
	NATV6	21	NATV6PP	21	6	19	12	11	14	5700	8700	7000
24	NATR8	41	NATR8PP	41	8	24	15	14	19	4500	5400	5000
	NATV8	42	NATV8PP	42	8	24	15	14	19	8600	12000	5500
30	NATR10	64	NATR10PP	64	10	30	15	14	23	6100	7800	11000
	NATV10	65	NATV10PP	65	10	30	15	14	23	10900	17000	4500
32	NATR12	71	NATR12PP	71	12	32	15	14	25	6600	9800	9000
	NATV12	72	NATV12PP	72	12	32	15	14	25	11800	19000	3900
35	NATR15	103	NATR15PP	103	15	35	19	18	27	10500	17500	7000
	NATV15	105	NATV15PP	105	15	35	19	18	27	16000	32500	3400
40	NATR17	144	NATR17PP	144	17	40	21	20	32	11800	19400	6000
	NATV17	152	NATV17PP	152	17	40	21	20	32	196900	37000	2900
47	NATR20	246	NATR20PP	246	20	47	25	24	37	17500	29800	4900
	NATV20	254	NATV20PP	254	20	47	25	24	37	25800	57000	2600
52	NATR25	275	NATR25PP	275	25	52	25	24	42	19500	36500	3600
	NATV25	285	NATV25PP	285	25	52	25	24	42	29000	69600	2100
62	NATR30	470	NATR30PP	470	30	62	29	28	51	31000	57500	2600
	NATV30	481	NATV30PP	481	30	62	29	28	51	45500	104000	1700
72	NATR35	635	NATR35PP	635	35	72	29	28	58	34500	67500	2000
	NATV35	647	NATV35PP	647	35	72	29	28	58	50800	109500	1400
80	NATR40	805	NATR40PP	805	40	80	32	30	66	47000	91500	1700
	NATV40	890	NATV40PP	890	40	80	32	30	66	64000	139000	1300
85	NATR45	910	NATR45PP	910	45	85	32	30	72	49100	98000	1500
	NATV45	960	NATV45PP	960	45	85	32	30	72	50500	10600	1300
90	NATR50	960	NATR50PP	960	50	90	32	30	76	69500	187000	1000
	NATV50	990	NATV50PP	990	50	90	32	30	76	69500	187000	1000

- Suffix designation "X": columned surface. For example, NATR 5X
- Usually when the columned outer ring is mounted into the housing in normal tolerance, Cr and Cor is working; When the outer ring is used as track roller, Cw and Cow is working
- Limiting speed for oil lubrication: about 30% higher than the one of grease; Limiting speed types will be 30% lower.

Yoke Type Track Rollers

Bearing Code	d	D	B	H	S1	r	C	Co	Reference index	
	mm	mm	mm	mm	mm	mm	N	N	SKF	Italy
NUTR2047-2RS	20	47	24	25	0.5	1.5	39	50	NUTR20	
NUTR2052-2RS	20	52	24	25	0.5	1.5	39	50	NUTR2052	TR2052 2RS
NUTR2552-2RS	25	52	24	25	0.5	1.5	43.5	60	NUTR25	TR2552 2RS
NUTR2562-2RS	25	62	24	25	0.5	1.5	43.5	60	NUTR2562	TR2562 2RS
NUTR3062-2RS	30	62	28	29	0.5	1.5	59	79	NUTR30	TR3062 2RS
NUTR3072-2RS	30	72	28	29	0.5	1.5	59	79	NUTR3072	TR3072 2RS
NUTR3572-2RS	35	72	28	29	1	2	65	93	NUTR35	TR3572 2RS
NUTR3580-2RS	35	80	28	29	1	2	65	93	NUTR3580	TR3580 2RS
NUTR4080-2RS	40	80	30	32	1	2	90	134	NUTR40	TR4080 2RS
NUTR4090-2RS	40	90	30	32	1	2	90	134	NUTR4090	TR4090 2RS
NUTR4585-2RS	45	85	30	32	1	2	95	147	NUTR45	TR4585 2RS
NUTR45100-2RS	45	100	30	32	1	2	95	147	NUTR45100	TR45100 2RS
NUTR5090-2RS	50	90	30	32	1	2	100	161	NUTR50	TR5090 2RS
NUTR50110-2RS	50	110	30	32	1	2	100	161	NUTR50110	TR50110 2RS

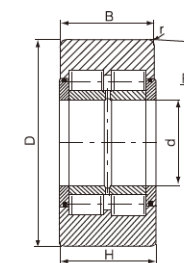
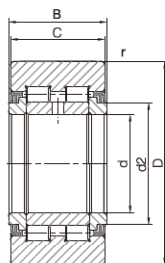

Bearing Code	Boundary dimensions					Basic load rating		limiting speed	mass Kg
	d	D	B	C	d2	Crw	Corw		
	mm	mm	mm	mm	mm	N	N		
PWTR15-2RS	15	35	19	18	20	11900	14600	6000	99
PWTR1542-2RS	15	42	19	18	20	13900	15200	6000	158
PWTR17-2RS	17	40	21	20	22	13600	17200	5000	147
PWTR1747-2RS	17	47	21	20	22	15100	17200	5000	220
PWTR20-2RS	20	47	25	24	27	23800	30500	3800	245
PWTR2052-2RS	20	52	25	24	27	26000	34000	3800	321
PWTR25-2RS	25	52	25	24	31	24600	33000	3800	281
PWTR2562-2RS	25	62	25	24	31	29000	40500	3800	450
PWTR30-2RS	30	62	29	28	38	34000	45500	2200	465
PWTR3072-2RS	30	72	29	28	38	40000	54000	2200	697
PWTR35-2RS	35	72	29	28	44	38000	54000	1800	630
PWTR3580-2RS	35	80	29	28	44	42500	64000	1800	836
PWTR40-2RS	40	80	32	30	50.5	43500	61000	1500	816
PWTR4090-2RS	40	90	32	30	50.5	51000	75000	1500	1129
PWTR45-2RS	45	85	32	30	55.2	44500	63000	1300	883
PWTR45100-2RS	45	100	32	30	55.2	55000	85000	1300	1396
PWTR50-2RS	50	90	32	30	59.8	44500	66000	1100	950
PWTR50110-2RS	50	110	32	30	59.8	58000	94000	1100	1690

Bearing Code	d	D	B	H	R	r	C	Co	Reference index	
	mm	mm	mm	mm	mm	mm	mm	KN	KN	Italy A
RSU50130-2RS	50	130	63	65	10000	3	219	249	RSU 50-130	TTR50X130X65-2RS
RSU55120-2RS	55	120	40	43	10000	2	170	260	RSU 55-120	TTR55X120X43-2RS
RSU55140-2RS	55	140	68	70	10000	3	266	304	RSU 55-140	TTR55X140X70-2RS
RSU60150-2RS	60	150	73	75	10000	3	314	354	RSU 60-150	TTR60X150X75-2RS
RSU65160-2RS	65	160	75	75	10000	3	323	361	RSU 65-160	TTR65X160X75-2RS
RSU70180-2RS	70	180	83	85	10000	3	404	450	RSU 70-180	TTR70X180X85-2RS
RSU80200-2RS	80	200	88	90	10000	4	461	524	RSU 80-200	TTR80X200X90-2RS
RSU90220-2RS	90	220	98	100	10000	4	572	684	RSU 90-220	TTR90X220X100-2RS
RSU100240-2RS	100	240	103	105	10000	4	650	790	RSU 100-240	TTR100X240X105-2RS
RSU110260-2RS	110	260	113	115	10000	4	748	905	RSU 110-260	TTR110X260X115-2RS
RSU120290-2RS	120	290	133	135	15000	4	924	1140	RSU 120-290	TTR120X290X135-2RS
RSU130310-2RS	130	310	144	146	15000	5	1122	1332	RSU 130-310	TTR130X310X146-2RS
RSU140340-2RS	140	340	160	162	15000	5	1353	1710	RSU 140-340	TTR140X340X162-2RS
RSU150360-2RS	150	360	171	173	15000	5	1592	1890	RSU 150-360	TTR150X360X173-2RS

Bearings for Material Handling System

Support Rollers

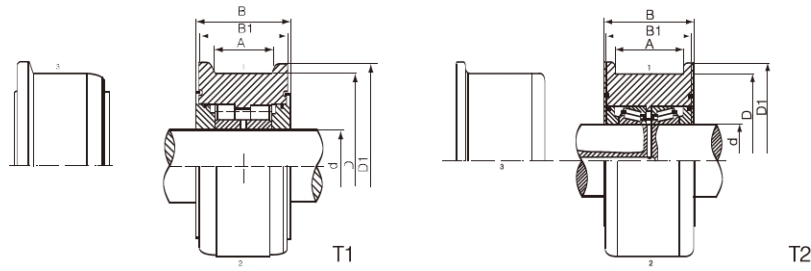

Bearing Code	d	D	D1	A	B1	B	C	Co	Reference index
	mm	mm	mm	mm	mm	mm	KN	KN	Italy
NNFPN50125-2Z NNFPN50125-2RS	50	125	140	40	60	65	128	133	9.1947 / A
NNFPN60150-2Z NNFPN60150-2RS	60	150	170	50	70	75	195	214	9.1947 / B
NNFPN70165-2Z NNFPN70165-2RS	70	165	190	55	75	80	228	246	9.1947 / C
NNFPN80185-2Z NNFPN80185-2RS	80	185	210	60	80	85	283	319	9.1947 / D
NNFPN100215-2Z NNFPN100215-2RS	100	215	250	65	85	90	356	411	9.1947 / E
NNFPN120255-2Z NNFPN120255-2RS	120	255	290	70	95	100	472	581	9.1947 / F

Remarks:
Outer profile 1, 2 & 3 are available on request.

T1

Conveyor Track Roller Bearings (Taper Roller)

Bearing Code	d	D	D1	A	B1	B	C	Co	Reference index
	mm	mm	mm	mm	mm	mm	KN	KN	Italy
ET330/50125DS-2Z ET330/50125DS-2RS	50	125	140	45	70	75	98	177	9.1946 / A
ET330/60150DS-2Z ET330/60150DS-2RS	60	150	170	55	80	85	131	246	9.1946 / B
ET330/70165DS-2Z ET330/70165DS-2RS	70	165	190	60	85	90	163	306	9.1946 / C
ET330/80185DS-2Z ET330/80185DS-2RS	80	185	210	65	95	100	219	426	9.1946 / D
ET330/100215DS-2Z ET330/100215DS-2RS	100	215	250	75	105	115	275	552	9.1946 / E
ET330/120255DS-2Z ET330/120255DS-2RS	120	255	290	85	120	130	390	824	9.1946 / F

Remarks:
Outer profile 1, 2 & 3 are available on request.

T2

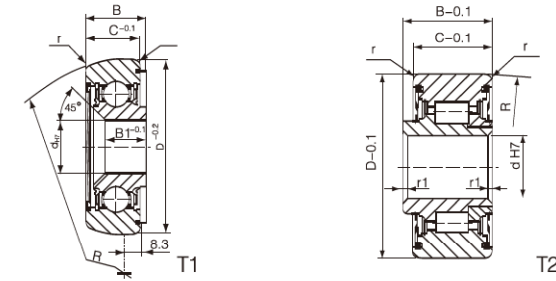

Bearing Code	d	D	C	B	B1	R	r	C	Co	Reference index
	mm	mm	mm	mm	mm	mm	mm	KN	KN	Italy
6404K-2RS	20	80	25.5	29.5	18	50.8	3	20.5	13.7	MRVS.001
6404K1-2RS	20	100	25.5	29.5	18	50.8	3	20.5	13.7	MRVS.002
6405K-2RS	25	80	25.5	29.5	18	50.8	3	20.5	13.7	MRVS.003
6405K1-2RS	25	100	25.5	29.5	18	50.8	3	20.5	13.7	MRVS.004
6405K2-2RS	26	82.5	25.5	28.5	19	50.8	3	28	16	MRVS.005

T1

Yoke Type Track Rollers (Cylindrical Roller Bearings)

Bearing Code	d	D	C	B	R	r	r1	C	Co	Reference index
	mm	mm	mm	mm	mm	mm	mm	KN	KN	Italy
NJV404K-2RS	20	80	25.5	29.5	50	2	0.5	36.9	41.2	MRVR.101
NJV404K1-2RS	20	100	25.5	29.5	50	2	0.5	36.9	41.2	MRVR.102
NJV405K1-2RS	24	70	30	33.6	50	2	0.5	45.5	42.5	MRVR.103
NJV405K-2RS	25	80	25.5	29.5	50	2	0.5	38.7	44.5	MRVR.104
NJV405K2-2RS	26	100	25.5	28.5	50	2	0.5	38.7	44.5	MRVR.105

T2

Bearings for Material Handling System

Support Rollers

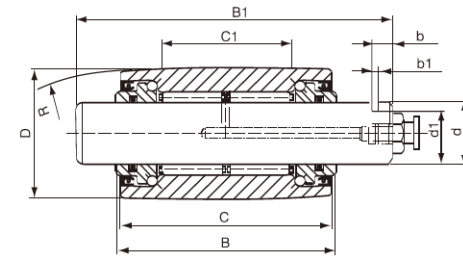
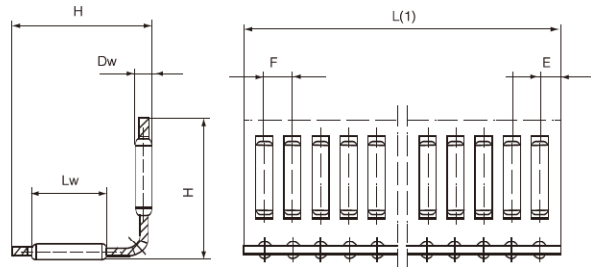

Bearing Code	H	DW	Lw	F	E	C	C0	Reference index
	mm	mm	mm	mm	mm	KN	KN	Italy
LNS2010WP02	10	2	4.8	4	3	10.7	27.4	GA 10
LNS2015WP02	15	2	6.8	4.5	3.5	14.3	40	GA 15
LNS2017WP02	17	2	9.8	4.5	3.5	20.2	58	GA 15S
LNS2.520WP02	20	2.5	9.8	5.5	4	25.5	73	GA 20
LNS3025WP02	25	3	13.8	6	4.5	43	125	GA 25
LNS3.530WP02	30	3,5	17.8	7	5	64	187	GA 30

Bearing Code	d	D	C	B	B1	C1	b	b1	d1	R	C	Co	Cw	Cow	Reference index
	mm	mm	mm	mm	mm	mm	mm	mm	mm	mm	KN	KN	KN	KN	Italy
NKIA12X25.5X61.5-2RS12	25.5	30	32	61.5	25	4.5	2	9	140	9	15	8	13	MRSC.0012	
NKIA14X27X75-2RS	14	27	41	43	75	25	5	2.5	11	140	13.5	20	11.5	17	MRSC.0014
NKIA15X31X77-2RS	15	31	44	46	77	38	6	2.5	12	145	18	23	16	21	MRSC.0015
NKIA15X31X82-2RS	15	31	46	48	82	38	6	2.5	12	145	18	23	16	21	MRSC.0016
NKIA18X33X90-2RS	18	33	57	58	90	39	5	2.5	15	145	20	37	17	30	MRSC.0017
NKIA18X36X95-2RS	18	36	62	64	95	34	6	2.5	15	145	25	46	22	44	MRSC.0018
NKIA20X41X81-2RS	20	41	48	50	81	40	6	2.5	17	50	34	52	30	46	MRSC.0019
NKIA20X40X110-2RS	20	41	68	70	110	42	7	2.5	17	145	40	68	35	62	MRSC.0020
NKIA25X48X95-2RS	25	48	58	60	95	48	6	2.5	22	145	40	75	35	64	MRSC.0023
NKIA25X48X133-2RS	25	48	83	85	133	59	7	2.5	22	180	66	112	52	90	MRSC.0024
NKIA25X52X138-2RS	25	52	78	80	138	60	7	3	22	180	79	124	56	102	MRSC.0025
NKIA28X52X110-2RS	28	52	69	72	110	55	7	3	25	180	45	110	39	100	MRSC.0026
NKIA30X56X133-2RS	30	56	83	85	133	59	7	3	27	180	67	132	53	102	MRSC.0028
NKIA30X60X99.5-2RS	30	60	57	58.5	99.5	46	10	5	27	180	62	109	47	99	MRSC.0029
NKIA32X63X133-2RS	32	63	83	85	133	51	7	3	27	180	75	118	63	105	MRSC.0030
NKIA32X66X178-2RS	32	66	103	105	178	93	7	3	29	180	104	130	74	108	MRSC.0032
NKIA50X83X190-2RS	50	83	128	130	190	94	9	4	45.5	180	120	300	88	212	MRSC.0050

Remarks: If the specifications are not listed above, please contact WD bearings.
Email: sales@wd-bearing.com

Bearings for Material Handling System

Support Rollers

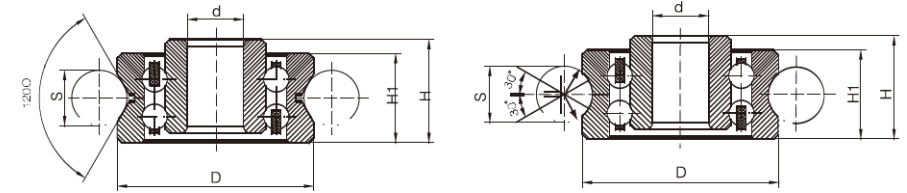
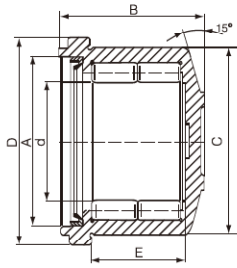

Bearing Code	d	D	A	B	C	E	Reference index
	mm	mm	mm	mm	mm	mm	Italy
W/4660R-RS	45.85	84	70	60	74	39.5	9.2061
W/5270R-RS	51.5	92	80	70	83	45.5	9.2062
W/6177R-RS	60.5	105	85	76.5	95	49.5	9.2059
W/7085R-RS	70	122	100	84.8	110	56	9.2063
W/7697R-RS	76.3	135	115	96.5	120	62	9.2064
W/83103R-RS	82.75	147	128	102.5	130	70.8	9.2065
W/98114R-RS	98.18	174	150	113.5	154	75.5	9.2055
W/98114AR-RS	98.18	174	160	113.5	154	75.5	9.2066
W/4660R-RS	119.28	192	170	124	170	83.5	9.2056
W/4660R-RS	133.266	220	200	140	195	94	9.2057
W/4660R-RS	152.2	243	210	162.5	220	107	9.206
W/4660R-RS	160.4	263	220	171	235	109	9.2058

Bearing Code	d	D	H	H1	S	Cy	Cyo	Cz	Czo	SGB	OSGB
4000WBK1-2RS	5	17	9.75	8	6	890	1610	200	340	15	20
4000WBK-2RS	6	24	12.75	11	8	2280	4100	550	1080	20	25
406X3WBK-2RS	8	30	15.5	14	10	3500	6000	850	1700	25	30
4000X2WBK-2RS	12	42	22	19	12	5200	9800	1910	4190	35	40

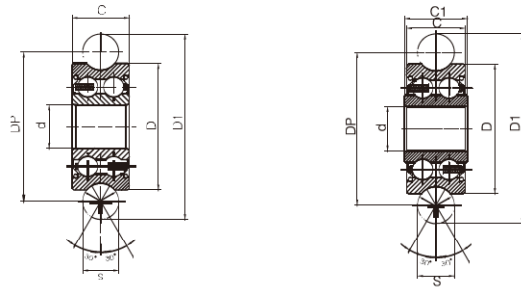

High Speed Linear Motion Double Row Ball Bearings

Bearing Code	d	D	C	S	DP	D1	Cr	Cor	Cw	Cow
LR201	12	35	15.9	10	41.3	51.3	5100	10200	8500	5100
LR201	12	35	15.9	12	43.5	55.5	5100	10200	8500	5100
LR20/8	8	24	11	6	28	34	3500	6000	1700	850
LR301	12	42	19	10	48	58	5100	10200	8500	5100
LR301	15	47	19	10	53.26	63.26	8200	18400	14500	9200

Bearing Code	d	D	C	C1	S	DP	D1	Cr	Cor	Cw	Cow
LR20/5	5	17	7	8	6	21	27	890	1610	200	340
LR20/5-4	5	16	7	8	4	18	22	890	1610	200	340
LR201-14	12	39.9	18	20	14	48	62	5900	10600	9300	5700
LR204-16	20	52	20.6	22.6	16	63	79	12800	16600	14600	8300
LR206-20	25	72	23.8	25.8	20	82	102	21400	30000	23400	16600
LR206-25	25	72	23.8	25.8	25	87	112	21400	30000	23100	16400
LR207-30	30	80	27	29	30	102	132	28700	39500	28500	20800
LR208-40	40	98	36	38	40	125	165	55000	58000	38500	29000