

U.S. TSUBAKI DRIVE CHAINS

Contents	Page
ASME/ANSI RS ROLLER CHAIN	A-1 ~ A-24
INTRODUCTION	A-1 ~ A-5
RS25 THROUGH RS240	A-6 ~ A-19
HEAVY SERIES	A-20
RS DOUBLE PITCH ROLLER CHAINS	A-21
SELECTION AND ENGINEERING INFORMATION	A-22 ~ A-24
LAMBDA® CHAIN	A-25 ~ A-30
INTRODUCTION	A-25 ~ A-26
RS DRIVE LAMBDA	A-27
NICKEL-PLATED DRIVE LAMBDA	A-28
BS/DIN DRIVE LAMBDA	A-28
LAMBDA HORSEPOWER RATINGS	A-29 ~ A-30
ENERGY SERIES® CHAIN	A-31 ~ A-34
SUPER CHAIN	A-35 ~ A-42
INTRODUCTION	A-35 ~ A-36
RS-T SERIES	A-37
RS-HT SERIES	A-38
SUPER SERIES	A-39
SUPER-H SERIES	A-40
ULTRA SUPER SERIES	A-41
SELECTION INFORMATION	A-42
MINIATURE CHAIN	A-43 ~ A-46
BS/DIN ROLLER CHAIN	A-47 ~ A-52
INTRODUCTION	A-47
BS/DIN CHAIN SERIES	A-48
BS/DIN DRIVE LAMBDA	A-49
BS/DIN STAINLESS STEEL	A-50
SELECTION AND ENGINEERING INFORMATION	A-51 ~ A-52
ANTI-CORROSIVE/HEAT RESISTANT CHAIN	A-53 ~ A-62
INTRODUCTION	A-53
NEPTUNE® CHAIN	A-54
NICKEL-PLATED CHAIN	A-55 ~ A-56
STAINLESS STEEL CHAIN	A-57 ~ A-58
POLY-STEEL CHAIN	A-59
CORROSION RESISTANCE GUIDE	A-60
SELECTION AND ENGINEERING INFORMATION	A-61 ~ A-62
LEAF CHAIN	A-63 ~ A-68
SPECIALTY CHAIN	A-69 ~ A-72
LUBE-FREE CHAIN, FX CHAIN	A-70
ROLLERLESS CHAIN, WRENCH CHAIN, LAMINATED BLOCK CHAIN	A-71
AGRICULTURE CHAIN	A-72
CHAIN TOOLS	A-73 ~ A-74
ENGINEERING INFORMATION	A-75 ~ A-83
INSTALLATION AND ARRANGEMENT	A-76
LUBRICATION	A-77
TROUBLESHOOTING GUIDE	A-78
ANSI SPROCKET DIMENSIONS	A-79 ~ A-82
PITCH CONVERSION TABLE	A-83 ~ A-84
WARNING STATEMENT	A-85

U.S. TSUBAKI RS ROLLER CHAIN

U.S. TSUBAKI ROLLER CHAIN — A SOLID DIFFERENCE

ASME/ANSI RS Roller Chain



RS ROLLER CHAIN RS11 ~ RS240

Longer Wear Life

U.S. Tsubaki Roller Chain lasts up to twice as long as our previous chain in many applications. Advanced technology allows us to combine the strength, durability, and reliability of a solid bushing with our patented lube groove on the inner surface of sizes RS80 through RS140. The solid bushings are precise round cylinders, which means better contact between the pin and bushing. The lube grooves hold oil where chain needs it most. The result is longer lasting chain.

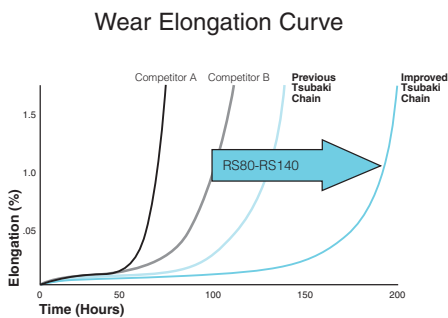

Higher Horsepower Ratings

U.S. Tsubaki ASME/ANSI Chains handle up to 33 percent more horsepower so you can increase drive performance without increasing chain size. In fact, depending on your application, you may be able to transmit the same horsepower with a smaller, less costly chain. The improvement comes from a U.S. Tsubaki exclusive ring coining process for the slip fit connecting link and special processing on the two-pitch offset link.

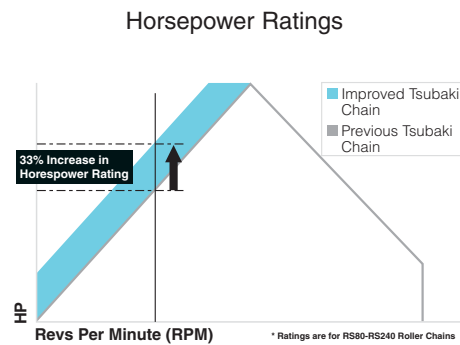

Greater Fatigue Strength

U.S. Tsubaki ASME/ANSI Chains are designed to have higher fatigue strength. The wider waist of the link plates puts more metal where you need it — running your application. There is less downtime because chains operate longer. Operating costs are reduced because chains perform more efficiently. These benefits go right to your bottom line.

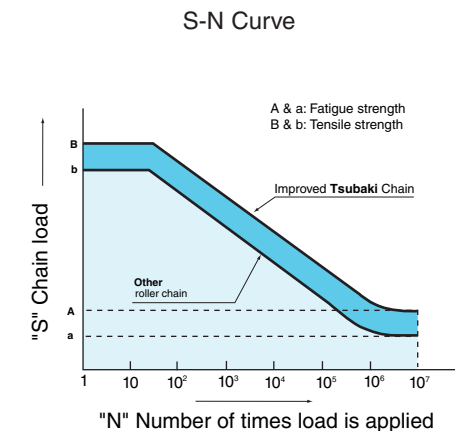

Save Time & Money

Wear in the pin-bushing joint can lead to elongation and replacement. U.S. Tsubaki's ASME/ANSI Chains have a patented lube groove that holds lubricant right where it's needed — in the pin-bushing joint. Tsubaki chains last longer, reducing maintenance, operating, and replacement costs.

U.S. TSUBAKI RS ROLLER CHAIN

Assurance of Greater Fatigue Strength

The wider waist of U.S. Tsubaki link plates ensures greater fatigue strength for all chain sizes. Fatigue strength (max. allowable load) of each size can be found in this catalog.



U.S. Tsubaki



Other Brands

Longer Wear Life & Less Initial Adjustment

- 1) U.S. Tsubaki has decreased initial wear elongation to 0.01% and increased wear life by up to twice as long in many applications. Where initial elongation is a problem, as in precision applications or when you simply demand the best, U.S. Tsubaki roller chain is the solution.
- 2) Our original prelubricant minimizes wear elongation to enable a vast increase in the chain's wear life.
- 3) U.S. Tsubaki's lube groove bushings hold oil at the pin-bushing interface, extending the working life of the chain.

Perfectly cylindrical inside bushing wall



- 4) Micron control has enabled U.S. Tsubaki to produce perfectly straight bushings and significantly reduce wear elongation during initial operation.

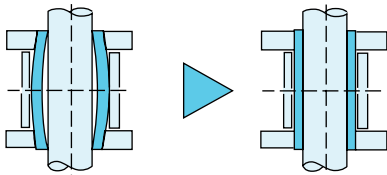

Micron Control

- 5) Improved U.S. Tsubaki roller chain sizes RS80 through RS140 have the patented PerforMax™ solid lube groove bushings and last up to twice as long in many applications. The lube groove retains oil at the critical pin-bushing contact point, extending the life of the chain.



Patented PerforMax™ solid lube groove bushing

Shot Peened Parts

Link plates and rollers are shot peened for greater fatigue strength.



Factory Preloading

U.S. Tsubaki roller chains are continuously preloaded on multi-sprockets after final assembly as shown below. This results in minimum initial stretch.

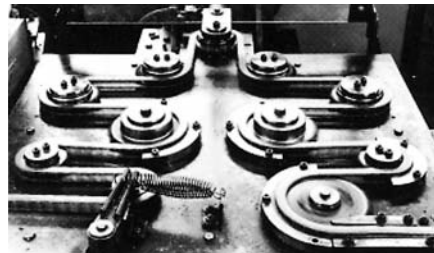

Preloading on Sprockets

Heat Treatment Ensures Durability

Chain durability depends to a great extent on the heat-treatment of the various parts. The use of the most advanced heat-treatment methods and equipment guarantees that U.S. Tsubaki roller chains are highly durable.

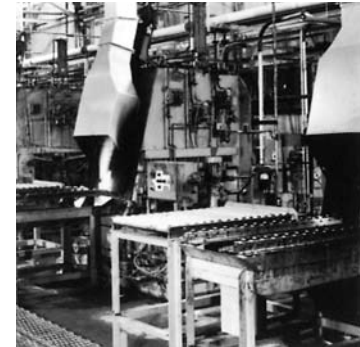

Heat Treatment

Prelubrication

A special lubrication is applied by U.S. Tsubaki to bearing surfaces by hot dipping to extend chain life and reduce maintenance costs.

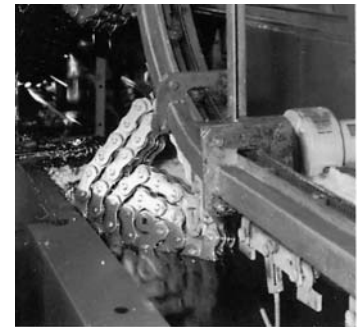

Prelubrication

A Completely Automated Manufacturing Process

The manufacture of U.S. Tsubaki roller chains employs advanced, automated techniques. The specialized equipment used in each process ensures that all parts are uniform and high quality. The photo below shows the automated positioning of curled bushings.

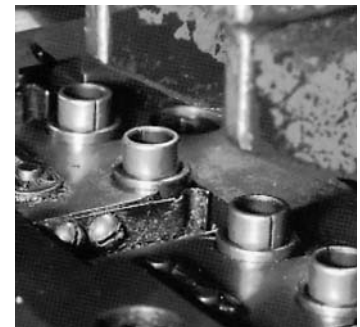

Automated Manufacturing

U.S. TSUBAKI RS ROLLER CHAIN

APPLICATIONS

Roller chains can be operated at speeds of up to 10,000 rpm. Even at high speeds, chain drive is quieter and smoother than a gear drive. You never have to worry about slippage as you would with a belt.

Roller chains are inherently elastic. Compared with gear drives, they soften shock and absorb vibration. They can be used in machines which are subjected to great shock or which constantly move or vibrate. Both the machine's body and bearing parts are protected against damage.

A - DRIVE CHAINS

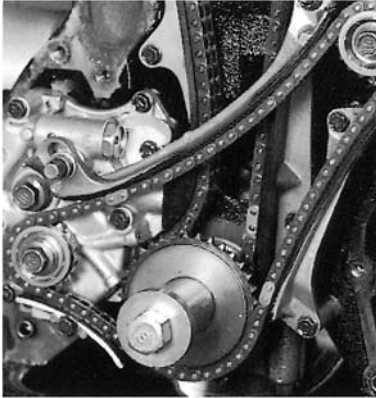

For accurate high speed drives... automobile engines

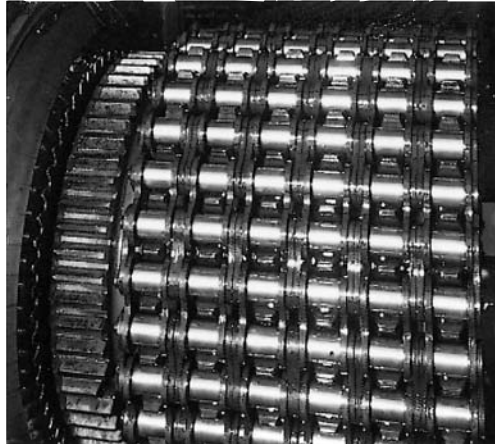

For high speed and heavy load drives... oil-well drilling equipment

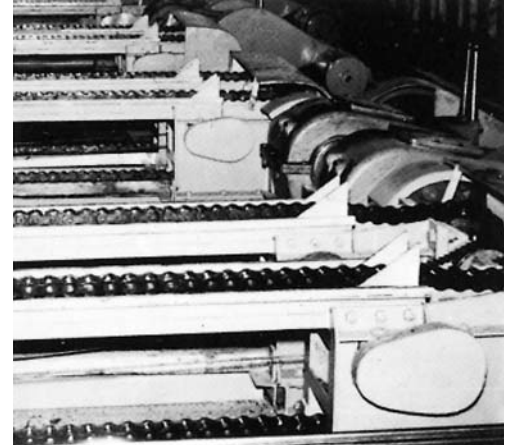

For heavy shock... draw benches

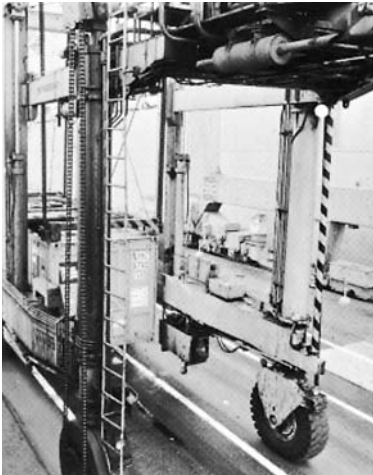

For long center distance drives... container straddle carriers

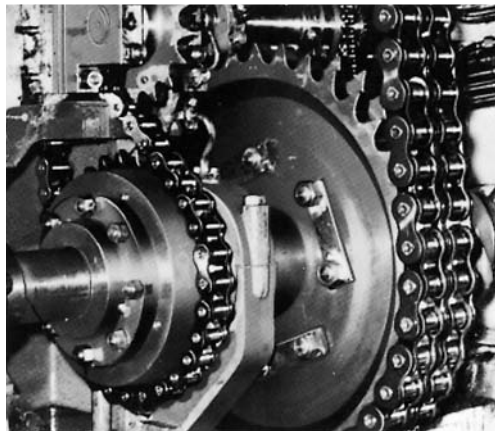

For precision drives... marine diesel engines

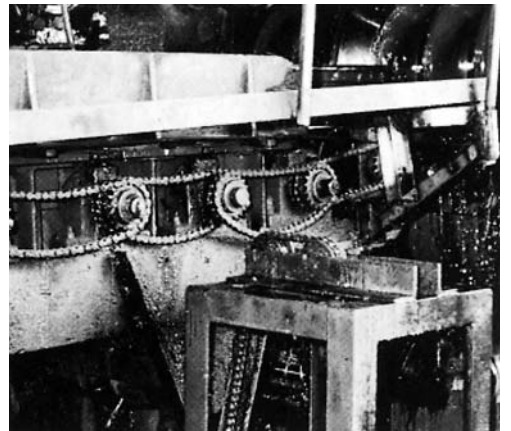

For severe conditions... tilting tables

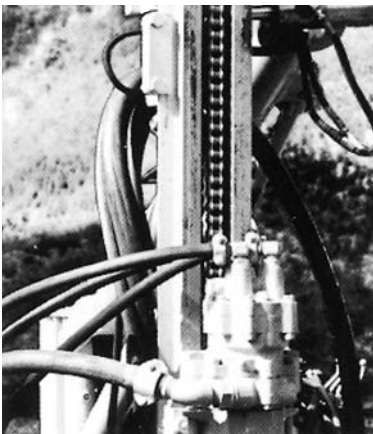

For heavy shock... crawler drills

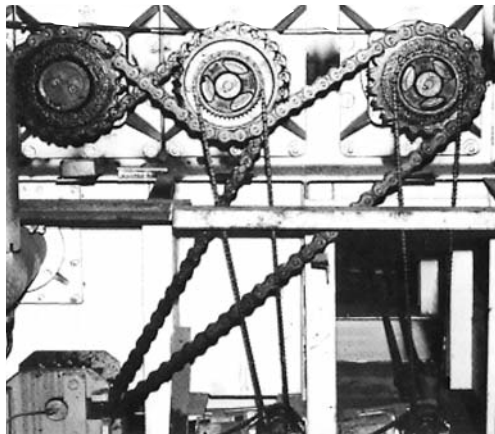

For multi-shaft drives... roller tables

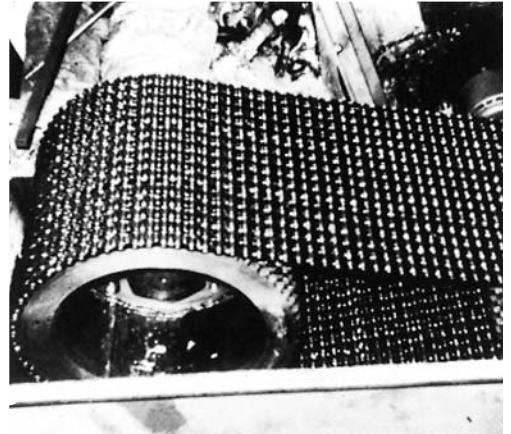

For high speed operation... pump drives

U.S. TSUBAKI RS ROLLER CHAIN

CONNECTION OF RS ROLLER CHAIN – IMPROVED

Roller chain is normally used as a continuous length with a connecting link, resulting in an even number of pitches.

Connecting Links

Standard connecting links are used when RS roller chain is operated under normal conditions. For severe applications, press fit connecting links are suggested. In either case, a spring clip connecting link is used for RS roller chains of sizes RS60 or smaller, a cottered connecting link for sizes RS80 to RS200, and a spring pin connecting link for RS240. A cottered type connecting link is used for three to six strands of RS40 to RS60. A cottered type can be provided for single and double strands of RS40 to RS60 upon request.

Standard connecting links have a slip fit cover plate.

The wider waist of U.S. Tsubaki's cover plates provides higher fatigue strength.

Installation of press fit connecting links may be less convenient than that of standard connecting links, but performance is better. Press fit connecting links should be used in extremely high-speed or heavy duty applications.

The slip fit connecting links on improved U.S. Tsubaki chain have 25% greater fatigue strength. These connecting links are ring coined, which means improved capacity for your application.



Spring Clip Connecting Link



Cottered Connecting Link

If a continuous length has an odd number of pitches, an offset link must be used. However, the use of offset links should be avoided.

Offset Links

Both two-pitch offset links and one-pitch offset links are available for RS roller chains. U.S. Tsubaki's redesigned link plate and improved manufacturing process make our two-pitch offset links stronger than ever.

The two-pitch offset link is a combination of a roller link and an offset link connected with a riveted pin. The connecting link can be attached to either side of a two-pitch offset link.

One-pitch offset links are very handy, but pin and offset link plates have to be slip-fitted. One-pitch offset links are also weaker than plain chain and two-pitch offset links. Therefore, one-pitch offset links are not suggested, especially for frequent on-and-off operation, heavy impact loads, and high-speed driving.

Note: Only two-pitch offset links are available for RS25.



Two-Pitch Offset Link



One-Pitch Offset Link

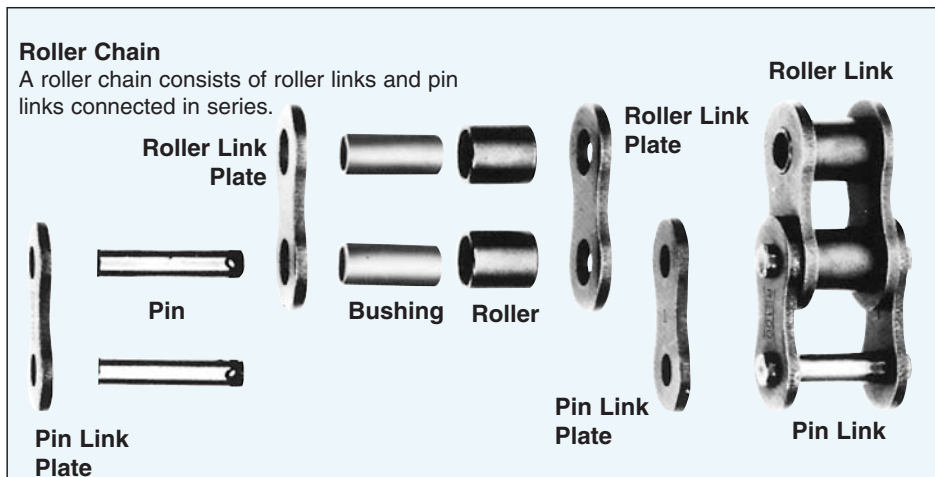

U.S. TSUBAKI RS ROLLER CHAIN

CHAIN DIMENSIONS (inch)

U.S. TSUBAKI									Single Strand			
Chain No.	ANSI No.	Page No.	Pitch	Roller Diameter	Width Between Roller Link Plates	Connecting Pin Length	Plate Thickness	Minimum Ultimate Strength ANSI Standard lbs.	Average Tensile Strength lbs.	** Maximum Allowable Load lbs.	Number of Links Per 10 ft.	
RS11SS▲	—	A-45	.1475	*.090	.072	.214	.015	—	175	11	814	
RS15▲	—	A-45	.1875	*.098	.094	.272	.024	—	510	70	640	
RS25▲	25	A-6	.250	*.130	.125	.339	.030	780	1,050	140	480	
RS35▲	35	A-7	.375	*.200	.188	.500	.050	1,760	2,530	480	320	
RS37 (43)	—	—	.500	.306	.134	.425	.040	—	2,120	370	240	
RS38 (42)	—	—	.500	.306	.188	.496	.040	—	2,120	370	240	
RS41	41	A-8	.500	.306	.250	.579	.050	1,500	2,640	500	240	
RS40	40	A-9	.500	.312	.312	.717	.060	3,125	4,290	810	240	
RS50	50	A-10	.625	.400	.375	.878	.080	4,880	7,050	1,430	192	
RS60	60	A-11	.750	.469	.500	1.087	.094	7,030	9,920	1,980	160	
RS80	80	A-12	1.000	.625	.625	1.398	.125	12,500	17,640	3,300	120	
RS100	100	A-13	1.250	.750	.750	1.678	.156	19,530	26,460	5,070	96	
RS120	120	A-14	1.500	.875	1.000	2.118	.187	28,125	37,480	6,830	80	
RS140	140	A-15	1.750	1.000	1.000	2.307	.219	38,280	48,510	9,040	68	
RS160	160	A-16	2.000	1.125	1.250	2.705	.250	50,000	60,630	11,900	60	
RS180	180	A-17	2.250	1.406	1.406	3.075	.281	63,280	80,480	13,670	54	
RS200	200	A-18	2.500	1.562	1.500	3.299	.312	78,125	103,630	16,090	48	
RS240	240	A-19	3.000	1.875	1.875	4.071	.375	112,500	152,140	22,270	40	

▲ Rollerless

* Bushing Diameter

** Refer to page A-23, "Selection for Slow Speed."

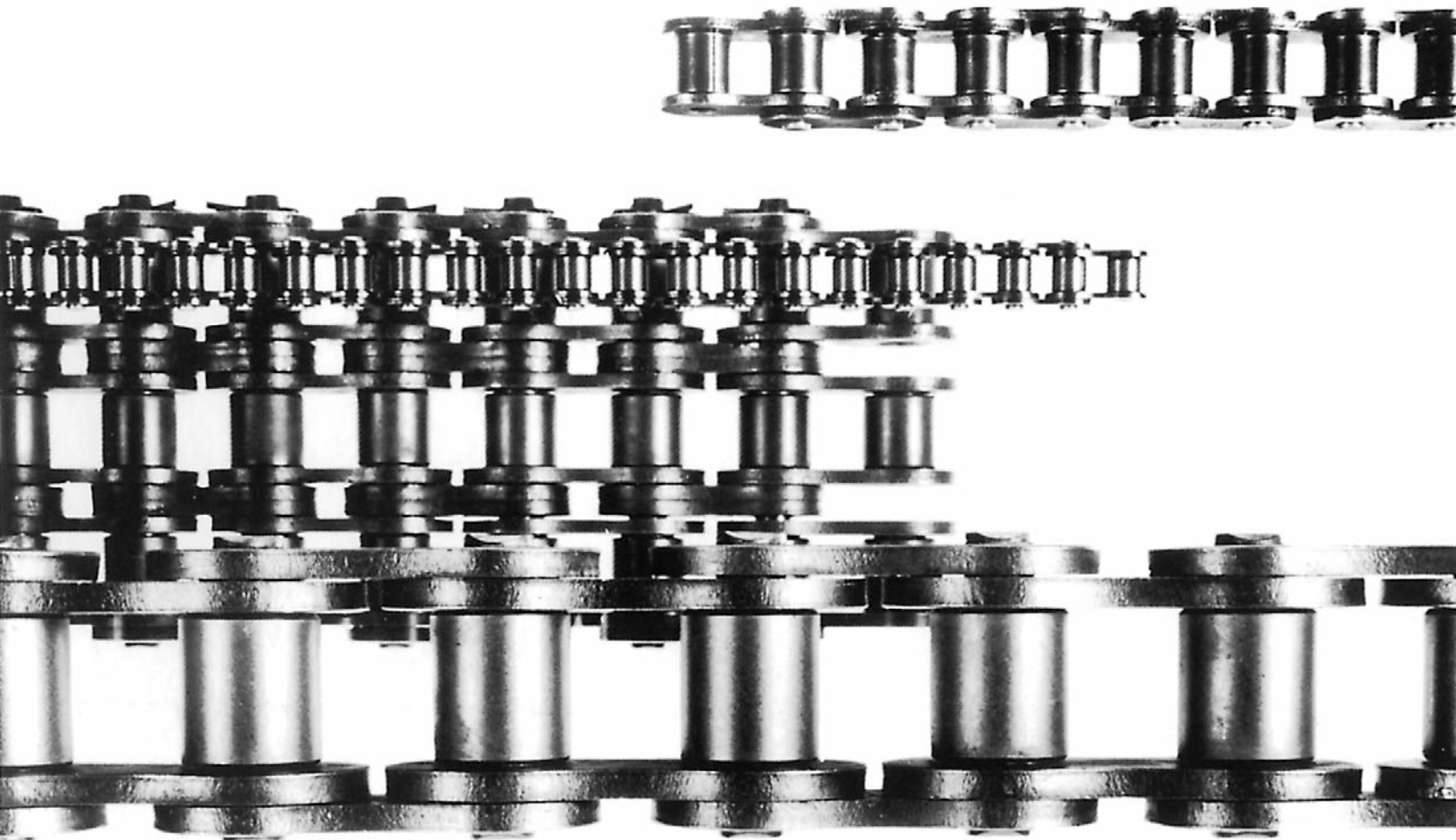

RS25 ^{1/4"} Pitch

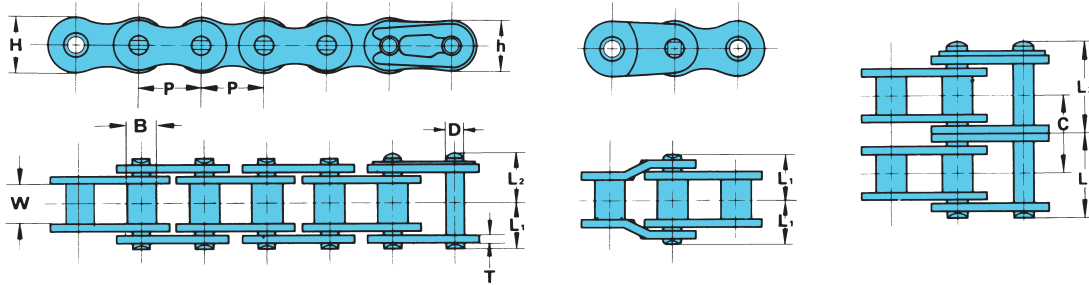

U.S. TSUBAKI Chain No.	ANSI Pitch No.	Bushing Diameter B	Width Between Inner Link Plates W	Link Plate			Pin Diameter D	
				T	H	h		
RS25	25	.250	.130	.125	.030	.230	.199	.0905

U.S. TSUBAKI Chain No.	Number of Strands	Pin		Transverse Pitch C	Standard Type of Pin	Minimum Ultimate Strength ANSI Standard lbs.	Average Tensile Strength lbs.	* Maximum Allowable Load lbs.	Approx. Weight lbs./ft.	Number of Links per 10 ft.	
		L1+L2	L1								L2
RS25	1	.339	.150	.189	.252	Riveted	780	1,050	140	.094	480
RS25-2	2	.591	.276	.315		Riveted	1,560	2,100	240	.181	

Note: Only two-pitch offset links are available for RS25 and RS25-2.

* Refer to page A-23, "Selection for Slow Speed."

Maximum Horsepower Ratings

No. of Teeth Small Splt.	Maximum Speed - Small Sprocket (rpm)																								
	50	100	300	500	700	900	1200	1500	1800	2100	2500	3000	3500	4000	4500	5000	5500	6000	6500	7000	7500	8000	8500	9000	10,000
	Lubrication System A										Lubrication System B														
11	0.03	0.05	0.14	0.23	0.31	0.39	0.50	0.60	0.71	0.83	0.95	1.13	1.29	1.38	1.16	0.99	0.86	0.75	0.67	0.60	0.54	0.49	0.45	0.41	0.35
12	0.03	0.06	0.16	0.25	0.34	0.43	0.55	0.66	0.78	0.90	1.05	1.23	1.42	1.57	1.32	1.12	0.97	0.86	0.76	0.68	0.61	0.56	0.51	0.47	0.40
13	0.04	0.06	0.17	0.27	0.37	0.47	0.60	0.72	0.84	0.98	1.14	1.34	1.54	1.74	1.49	1.27	1.10	0.96	0.86	0.77	0.69	0.63	0.57	0.53	0.45
14	0.04	0.07	0.19	0.30	0.40	0.50	0.65	0.78	0.94	1.06	1.23	1.46	1.68	1.89	1.66	1.42	1.23	1.08	0.96	0.86	0.77	0.70	0.64	0.59	0.50
15	0.04	0.08	0.20	0.32	0.43	0.54	0.68	0.84	0.99	1.14	1.33	1.57	1.81	2.04	1.84	1.57	1.36	1.20	1.06	0.95	0.86	0.78	0.71	0.65	0.56
16	0.04	0.08	0.22	0.34	0.47	0.58	0.74	0.90	1.06	1.22	1.43	1.69	1.93	2.19	2.03	1.73	1.50	1.32	1.17	1.05	0.94	0.86	0.78	0.72	0.61
17	0.05	0.09	0.23	0.37	0.48	0.60	0.79	0.97	1.14	1.30	1.53	1.80	2.07	2.33	2.22	1.90	1.64	1.44	1.28	1.14	1.03	0.94	0.86	0.79	0.67
18	0.05	0.09	0.25	0.39	0.53	0.64	0.84	1.02	1.21	1.38	1.62	1.92	2.20	2.48	2.42	2.07	1.79	1.57	1.39	1.25	1.12	1.02	0.93	0.86	0.73
19	0.05	0.10	0.26	0.41	0.56	0.68	0.89	1.09	1.29	1.48	1.72	2.02	2.33	2.63	2.62	2.24	1.94	1.70	1.51	1.35	1.22	1.11	1.01	0.93	0.79
20	0.06	0.10	0.28	0.44	0.59	0.72	0.94	1.15	1.35	1.56	1.82	2.15	2.47	2.78	2.83	2.42	2.10	1.84	1.63	1.46	1.32	1.20	1.09	1.00	0.86
21	0.06	0.11	0.29	0.46	0.60	0.76	0.99	1.21	1.42	1.64	1.92	2.27	2.60	2.92	3.05	2.60	2.26	1.98	1.76	1.57	1.42	1.29	1.17	1.08	0.92
22	0.06	0.11	0.31	0.48	0.64	0.80	1.05	1.27	1.50	1.73	2.01	2.37	2.74	3.08	3.27	2.79	2.42	2.12	1.88	1.69	1.52	1.38	1.26	1.16	0.99
23	0.06	0.12	0.32	0.51	0.67	0.84	1.10	1.34	1.57	1.81	2.12	2.49	2.87	3.23	3.50	2.98	2.59	2.27	2.01	1.80	1.62	1.47	1.35	1.24	1.06
24	0.07	0.13	0.34	0.53	0.72	0.90	1.14	1.39	1.65	1.89	2.21	2.61	3.00	3.38	3.73	3.18	2.76	2.42	2.15	1.92	1.73	1.57	1.44	1.32	1.12
25	0.07	0.13	0.35	0.55	0.75	0.94	1.19	1.46	1.72	1.98	2.32	2.72	3.14	3.54	3.93	3.38	2.93	2.57	2.28	2.04	1.84	1.67	1.53	1.40	1.20
26	0.07	0.14	0.37	0.56	0.76	0.98	1.25	1.53	1.80	2.07	2.41	2.84	3.27	3.69	4.10	3.59	3.11	2.73	2.42	2.17	1.95	1.77	1.62	1.49	1.27
28	0.08	0.15	0.40	0.63	0.83	1.05	1.35	1.65	1.94	2.24	2.61	3.08	3.54	4.00	4.44	4.01	3.47	3.05	2.70	2.42	2.18	1.98	1.81	1.66	1.42
30	0.08	0.16	0.43	0.66	0.90	1.13	1.46	1.78	2.09	2.41	2.82	3.33	3.82	4.30	4.79	4.45	3.85	3.38	3.00	2.68	2.42	2.20	2.01	1.84	1.57
32	0.09	0.17	0.44	0.71	0.98	1.21	1.56	1.90	2.25	2.59	3.02	3.57	4.09	4.61	5.14	4.90	4.25	3.73	3.30	2.96	2.67	2.42	2.21	2.03	1.73
35	0.10	0.19	0.51	0.78	1.06	1.33	1.72	2.11	2.48	2.84	3.33	3.93	4.51	5.08	5.65	5.60	4.86	4.26	3.78	3.38	3.05	2.77	2.53	2.32	1.98
40	0.12	0.22	0.58	0.90	1.22	1.53	1.98	2.43	2.86	3.29	3.85	4.53	5.20	5.87	6.53	6.85	5.93	5.21	4.62	4.13	3.73	3.38	3.09	2.83	2.42
45	0.13	0.25	0.64	1.03	1.39	1.74	2.25	2.76	3.25	3.73	4.37	5.15	5.91	6.66	7.42	8.15	7.08	6.21	5.51	4.93	4.45	4.04	3.69	3.38	2.89

Note: 1. Multiply the value given above by the multiple strand factor (page A-22, Table II) in order to obtain the transmission horsepower of multiple strand chain.

2. For lubrication systems A, B & C, refer to page A-77 for explanation. Please consult U.S. Tsubaki for use of horsepower ratings to the right of the boundary line.

3. Refer to page A-22, "Procedures for Selecting Roller Chain."

4. Gray portion of Maximum Horsepower Ratings Table is Lubrication System C.

U.S. TSUBAKI RS ROLLER CHAIN

RS35 3/8" Pitch

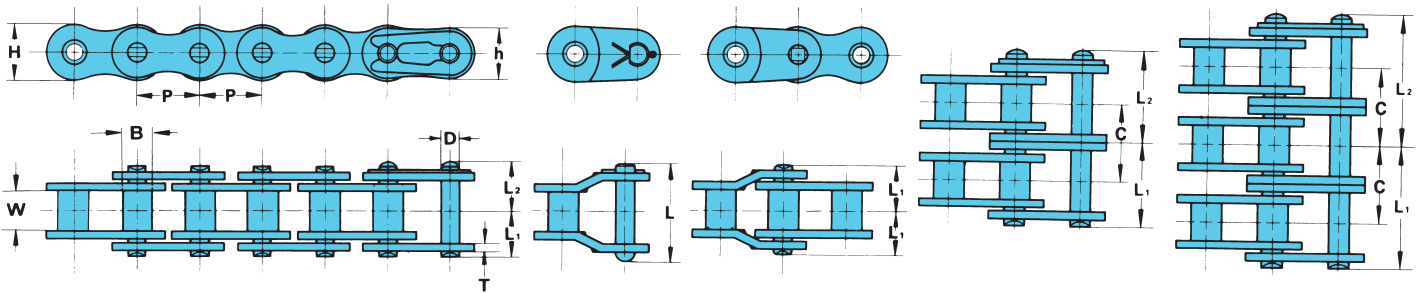

U.S. TSUBAKI Chain No.	ANSI No.	Pitch P	Bushing Diameter B	Link Plate				Pin Diameter D
				W	T	H	h	
RS35	35	.375	.200	.188	.050	.354	.307	.141

U.S. TSUBAKI Chain No.	Number of Strands	Pin				Transverse Pitch C	Standard Type of Pin	Minimum Ultimate Strength ANSI Standard lbs.	Average Tensile Strength lbs.	*Maximum Allowable Load lbs.	Approx. Weight lbs./ft.	Number of Links per 10 ft.
		L ₁ +L ₂	L ₁	L ₂	L							
RS35	1	.500	.230	.270	.531	Riveted	1,760	2,530	480	.22	320	
RS35-2	2	.898	.429	.469	.965	Riveted	3,520	5,060	810	.46		
RS35-3	3	1.295	.630	.665	1.362	Riveted	5,280	7,590	1,200	.70		

Note: * Refer to page A-23, "Selection for Slow Speed."

Maximum Horsepower Ratings

No. of Teeth Small Splt.	Maximum Speed - Small Sprocket (rpm)																								
	50	100	300	500	700	900	1200	1500	1800	2100	2500	3000	3500	4000	4500	5000	5500	6000	6500	7000	7500	8000	8500	9000	10,000
	Lubrication System A											Lubrication System B						Lubrication System C							
11	0.16	0.30	0.78	1.23	1.66	2.09	2.71	3.31	3.90	4.48	3.86	2.92	2.32	1.90	1.58	1.35	1.18	1.03	0.91	0.82	0.74	0.67	0.60	0.56	0.48
12	0.17	0.32	0.86	1.35	1.84	2.29	2.98	3.63	4.29	4.92	4.40	3.35	2.66	2.17	1.82	1.56	1.35	1.18	1.05	0.94	0.84	0.76	0.70	0.64	0.55
13	0.19	0.35	0.94	1.48	2.00	2.51	3.25	3.97	4.68	5.38	4.96	3.75	2.99	2.45	2.05	1.74	1.50	1.33	1.17	1.05	0.94	0.86	0.78	0.72	0.62
14	0.20	0.38	1.01	1.60	2.16	2.71	3.51	4.30	5.07	5.82	5.55	4.21	3.34	2.72	2.29	1.96	1.70	1.49	1.31	1.18	1.06	0.97	0.87	0.80	0.68
15	0.21	0.40	1.09	1.72	2.33	2.92	3.80	4.63	5.46	6.26	6.16	4.65	3.70	3.03	2.53	2.17	1.88	1.65	1.46	1.31	1.18	1.07	0.98	0.90	0.76
16	0.23	0.43	1.17	1.85	2.49	3.14	4.06	4.96	5.85	6.72	6.77	5.10	4.08	3.34	2.80	2.39	2.07	1.82	1.61	1.43	1.30	1.18	1.07	0.99	0.83
17	0.25	0.47	1.25	1.97	2.67	3.35	4.33	5.30	6.25	7.17	7.42	5.59	4.47	3.66	3.06	2.61	2.27	1.98	1.77	1.58	1.42	1.29	1.18	1.07	0.93
18	0.27	0.50	1.33	2.09	2.84	3.57	4.61	5.65	6.64	7.63	8.09	6.09	4.87	3.98	3.34	2.84	2.47	2.17	1.92	1.72	1.54	1.41	1.29	1.18	1.01
19	0.28	0.52	1.41	2.23	3.02	3.77	4.89	5.98	7.04	8.09	8.77	6.60	5.28	4.32	3.62	3.08	2.68	2.35	2.09	1.86	1.68	1.53	1.38	1.27	1.09
20	0.30	0.55	1.49	2.35	3.18	4.00	5.16	6.32	7.44	8.56	9.47	7.13	5.70	4.67	3.90	3.34	2.90	2.53	2.25	2.01	1.82	1.65	1.50	1.41	1.18
21	0.31	0.58	1.57	2.48	3.35	4.21	5.44	6.66	7.84	9.01	10.2	7.67	6.13	5.02	4.21	3.59	3.11	2.72	2.41	2.17	1.96	1.77	1.62	1.49	1.27
22	0.32	0.62	1.65	2.60	3.53	4.43	5.73	7.00	8.25	9.48	10.9	8.31	6.58	5.38	4.51	3.85	3.34	2.92	2.60	2.33	2.09	1.90	1.74	1.60	1.35
23	0.35	0.64	1.73	2.74	3.70	4.64	6.01	7.35	8.66	9.95	11.6	8.88	7.05	5.77	4.83	4.13	3.58	3.14	2.79	2.49	2.25	2.04	1.86	1.72	1.46
24	0.36	0.67	1.81	2.86	3.88	4.85	6.29	7.70	9.07	10.4	12.2	9.47	7.50	6.13	5.15	4.39	3.80	3.34	2.96	2.64	2.39	2.17	1.98	1.82	1.54
25	0.38	0.70	1.89	2.99	4.05	5.08	6.57	8.05	9.48	10.9	12.7	10.1	7.99	6.54	5.48	4.66	4.05	3.57	3.16	2.82	2.55	2.31	2.11	1.94	1.65
26	0.39	0.74	1.97	3.12	4.22	5.30	6.87	8.39	9.88	11.4	13.3	10.7	8.46	6.92	5.81	4.96	4.30	3.77	3.34	2.99	2.70	2.45	2.24	2.05	1.74
28	0.43	0.79	2.13	3.38	4.57	5.74	7.43	9.09	10.7	12.3	14.3	11.9	9.48	7.75	6.49	5.55	4.81	4.22	3.74	3.35	3.02	2.74	2.51	2.31	1.96
30	0.46	0.86	2.31	3.65	4.93	6.18	8.01	9.79	11.5	13.2	15.6	13.2	10.5	8.57	7.17	6.14	5.32	4.67	4.14	3.70	3.34	3.03	2.76	2.53	2.17
32	0.50	0.91	2.47	3.90	5.28	6.62	8.58	10.5	12.4	14.2	16.6	14.6	11.5	9.44	7.91	6.76	5.86	5.14	4.56	4.08	3.67	3.34	3.04	2.80	0
35	0.54	1.01	2.72	4.30	5.82	7.31	9.45	11.6	13.7	15.7	18.4	16.6	13.2	10.8	9.07	7.72	6.71	5.87	5.22	4.67	4.21	3.82	3.49	3.21	0
40	0.63	1.17	3.14	4.98	6.73	8.44	10.9	13.4	15.7	18.1	21.2	20.4	16.1	13.2	11.1	9.45	8.19	7.19	6.37	5.70	5.14	4.67	0	0	0
45	0.71	1.33	3.57	5.65	7.64	9.57	12.4	15.2	17.8	20.5	24.0	24.3	19.3	15.8	13.2	11.3	9.79	8.60	7.63	6.83	0	0	0	0	0

- Note: 1. Multiply the value given above by the multiple strand factor (page A-22, Table II) in order to obtain the transmission horsepower of multiple strand chain.
 2. For lubrication systems A, B & C, refer to page A-77 for explanation. Please consult U.S. Tsubaki for use of horsepower ratings to the right of the boundary line.
 3. Refer to page A-22, "Procedures for Selecting Roller Chain."

RS41

1/2" Pitch

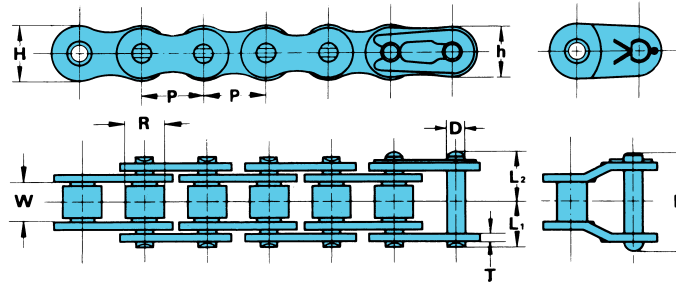

U.S. TSUBAKI Chain No.	ANSI No.	Pitch P	Roller Diameter R	Width Between Roller Link Plates W	Link Plate			Pin Diameter D
					T	H	h	
RS41	41	.500	.306	.250	.050	.386	.331	.141

U.S. TSUBAKI Chain No.	Pin				Standard Type of Pin	Minimum Ultimate Strength ANSI Standard lbs.	Average Tensile Strength lbs.	* Maximum Allowable Load lbs.	Approx. Weight lbs./ft.	Number of Links per 10 ft.
	L1+L2	L1	L2	L						
RS41	.579	.266	.313	.594	Riveted	1,500	2,640	500	.27	240

Note: *Refer to page A-23, "Selection for Slow Speed."

Maximum Horsepower Ratings

No. of Teeth Small Spkt.	Maximum Speed - Small Sprocket (rpm)																								
	10	25	50	100	200	300	400	500	700	900	1000	1200	1400	1600	1800	2100	2400	2700	3000	3500	4000	5000	6000	7000	8000
	Lubrication System A										Lubrication System B										Lubrication System C				
11	0.04	0.09	0.16	0.31	0.58	0.82	1.06	1.30	1.76	2.20	2.27	1.71	1.36	1.11	0.93	0.74	0.61	0.51	0.43	0.34	0.28	0.20	0.15	0.12	0.10
12	0.04	0.09	0.19	0.34	0.63	0.90	1.17	1.42	1.93	2.41	2.59	1.95	1.55	1.27	1.06	0.84	0.69	0.58	0.49	0.39	0.32	0.23	0.17	0.14	0.11
13	0.04	0.11	0.20	0.36	0.68	0.98	1.27	1.55	2.10	2.63	2.90	2.20	1.75	1.43	1.20	0.95	0.78	0.65	0.56	0.44	0.36	0.26	0.20	0.16	0.13
14	0.05	0.11	0.21	0.39	0.74	1.06	1.37	1.68	2.28	2.85	3.14	2.46	1.95	1.60	1.34	1.06	0.87	0.73	0.62	0.49	0.40	0.29	0.22	0.17	0.14
15	0.05	0.12	0.23	0.43	0.79	1.14	1.47	1.81	2.45	3.07	3.38	2.73	2.17	1.77	1.49	1.18	0.96	0.81	0.69	0.55	0.45	0.32	0.24	0.19	0.16
16	0.05	0.13	0.24	0.46	0.84	1.22	1.58	1.94	2.63	3.30	3.62	3.01	2.39	1.95	1.64	1.30	1.06	0.89	0.76	0.60	0.49	0.35	0.27	0.21	0.17
17	0.07	0.13	0.25	0.48	0.91	1.31	1.69	2.08	2.80	3.51	3.86	3.29	2.61	2.14	1.79	1.42	1.16	0.98	0.83	0.66	0.54	0.39	0.29	0.23	0.19
18	0.07	0.15	0.28	0.52	0.97	1.39	1.80	2.20	2.98	3.74	4.11	3.59	2.86	2.33	1.95	1.55	1.27	1.06	0.91	0.72	0.59	0.42	0.32	0.25	0
19	0.07	0.16	0.29	0.55	1.02	1.47	1.90	2.33	3.16	3.97	4.36	3.89	3.10	2.53	2.12	1.68	1.38	1.15	0.98	0.78	0.64	0.46	0.35	0.28	0
20	0.07	0.16	0.31	0.58	1.09	1.55	2.02	2.47	3.34	4.20	4.61	4.24	3.33	2.73	2.29	1.81	1.49	1.24	1.06	0.84	0.69	0.49	0.38	0.30	0
21	0.08	0.17	0.32	0.62	1.14	1.65	2.13	2.60	3.52	4.41	4.85	4.56	3.59	2.94	2.46	1.95	1.60	1.34	1.14	0.91	0.74	0.53	0.40	0.32	0
22	0.08	0.19	0.35	0.64	1.19	1.73	2.22	2.73	3.70	4.64	5.11	4.88	3.85	3.15	2.64	2.09	1.71	1.44	1.23	0.97	0.80	0.57	0.43	0.34	0
23	0.08	0.19	0.36	0.67	1.26	1.81	2.35	2.87	3.89	4.87	5.36	5.21	4.11	3.37	2.82	2.24	1.83	1.54	1.31	1.04	0.85	0.61	0.46	0.37	0
24	0.09	0.20	0.38	0.71	1.31	1.90	2.45	3.00	4.07	5.11	5.60	5.56	4.38	3.59	3.01	2.39	1.95	1.64	1.40	1.11	0.91	0.65	0.49	0.39	0
25	0.09	0.21	0.40	0.74	1.38	1.98	2.57	3.14	4.25	5.33	5.86	5.91	4.66	3.81	3.20	2.54	2.08	1.74	1.49	1.18	0.96	0.69	0.53	0	0
26	0.09	0.23	0.42	0.76	1.43	2.06	2.68	3.28	4.44	5.56	6.11	6.27	4.94	4.05	3.39	2.69	2.20	1.85	1.58	1.25	1.02	0.73	0.56	0	0
28	0.11	0.24	0.44	0.83	1.55	2.24	2.91	3.55	4.81	6.03	6.62	7.01	5.52	4.52	3.79	3.01	2.46	2.06	1.76	1.40	1.14	0.82	0.62	0	0
30	0.11	0.25	0.48	0.90	1.68	2.41	3.12	3.82	5.17	6.49	7.13	7.77	6.13	5.01	4.20	3.33	2.73	2.29	1.95	1.55	1.27	0.91	0.69	0	0
32	0.12	0.28	0.51	0.97	1.80	2.59	3.36	4.10	5.55	6.96	7.65	8.56	6.75	5.52	4.63	3.67	3.01	2.52	2.15	1.71	1.40	1.00	0	0	0
35	0.13	0.31	0.58	1.06	1.98	2.85	3.70	4.52	6.11	7.67	8.43	9.80	7.72	6.32	5.29	4.20	3.44	2.88	2.46	1.95	1.60	1.14	0	0	0
40	0.16	0.35	0.66	1.23	2.29	3.30	4.26	5.21	7.06	8.86	9.73	11.5	9.43	7.72	6.47	5.13	4.20	3.52	3.01	2.39	1.95	1.40	0	0	0
45	0.17	0.40	0.75	1.39	2.60	3.74	4.85	5.92	8.03	10.1	11.1	13.0	11.3	9.21	7.72	6.13	5.01	4.20	3.59	2.85	2.33	0	0	0	0

Note: 1. For lubrication systems A, B & C, refer to page A-77 for explanation. Please consult U.S. Tsubaki for use of horsepower ratings to the right of the boundary line.

2. Refer to page A-22, "Procedures for Selecting Roller Chain."

U.S. TSUBAKI RS ROLLER CHAIN

A - DRIVE CHAINS

RS40 1/2" Pitch

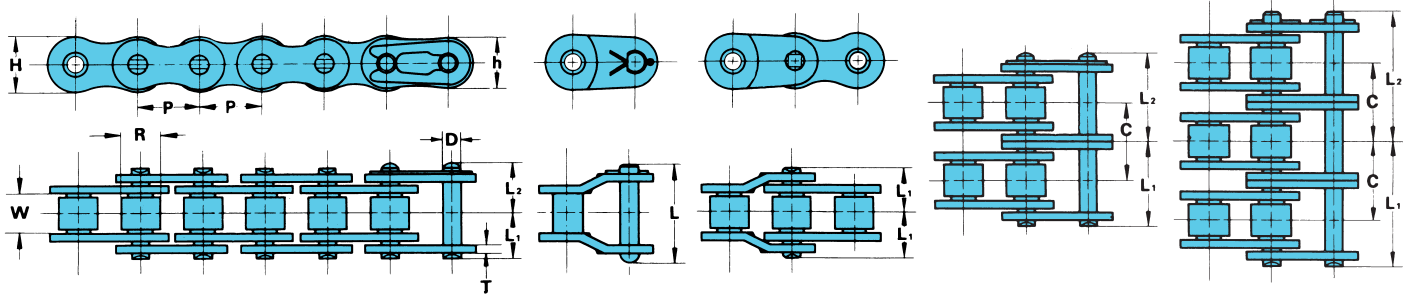

U.S. TSUBAKI Chain No.	ANSI No.	Pitch P	Roller Diameter R	Link Plate				Pin Diameter D
				Width Between Roller Link Plates W	T	H	h	
RS40	40	.500	.312	.312	.060	.472	.409	.156

U.S. TSUBAKI Chain No.	Number of Strands	Pin				Transverse Pitch C	Standard Type of Pin	Minimum Ultimate Strength ANSI Standard lbs.	Average Tensile Strength lbs.	*Maximum Allowable Load lbs.	Approx. Weight lbs./ft.	Number of Links per 10 ft.
		L ₁ +L ₂	L ₁	L ₂	L							
RS40	1	.717	.325	.392	.709	.566	Riveted	3,125	4,290	810	.43	240
RS40-2	2	1.283	.608	.675	1.319		Riveted	6,250	8,580	1,370	.85	
RS40-3	3	1.843	.892	.951	1.886		Riveted	9,375	12,870	2,020	1.28	
RS40-4	4	2.409	1.177	1.232	2.453		Riveted	12,500	17,160	2,670	1.70	
RS40-5	5	2.980	1.461	1.519	3.024		Riveted	15,625	21,450	3,150	2.12	
RS40-6	6	3.547	1.744	1.803	3.591		Riveted	18,750	25,740	3,720	2.55	

Note: * Refer to page A-23, "Selection for Slow Speed."

Maximum Horsepower Ratings

No. of Teeth Small Spkt.	Maximum Speed - Small Sprocket (rpm)																								
	10	25	50	100	200	300	400	500	700	900	1000	1200	1400	1600	1800	2100	2400	2700	3000	3500	4000	5000	6000	7000	8000
	A											B						C							
11	0.08	0.19	0.35	0.64	1.21	1.73	2.24	2.74	3.70	4.65	5.11	6.02	6.81	5.58	4.67	3.70	3.03	2.55	2.15	1.72	1.41	1.01	0.76	0.62	0.50
12	0.09	0.20	0.38	0.71	1.31	1.90	2.47	3.00	4.08	5.11	5.62	6.61	7.60	6.36	5.31	4.22	3.45	2.90	2.47	1.96	1.60	1.14	0.87	0.68	0.58
13	0.09	0.23	0.42	0.76	1.43	2.07	2.68	3.29	4.44	5.57	6.13	7.21	8.29	7.16	5.99	4.76	3.89	3.26	2.79	2.21	1.81	1.29	0.98	0.78	0.64
14	0.11	0.24	0.44	0.83	1.56	2.24	2.91	3.55	4.81	6.03	6.64	7.82	8.97	8.01	6.71	5.31	4.36	3.65	3.11	2.47	2.02	1.45	1.10	0.87	0.71
15	0.11	0.25	0.48	0.90	1.68	2.41	3.14	3.84	5.19	6.50	7.15	8.42	9.67	8.88	7.43	5.89	4.83	4.04	3.45	2.74	2.24	1.60	1.22	0.97	0.79
16	0.12	0.28	0.52	0.97	1.80	2.59	3.35	4.10	5.55	6.97	7.66	9.03	10.4	9.79	8.18	6.49	5.31	4.45	3.81	3.02	2.47	1.77	1.34	1.07	0.87
17	0.13	0.30	0.55	1.03	1.92	2.76	3.58	4.39	5.93	7.44	8.18	9.64	11.1	10.7	8.97	7.11	5.82	4.88	4.17	3.31	2.71	1.94	1.48	1.17	0.97
18	0.13	0.31	0.59	1.10	2.04	2.95	3.81	4.67	6.32	7.91	8.70	10.2	11.8	11.7	9.76	7.75	6.34	5.31	4.55	3.61	2.96	2.11	1.60	1.27	0
19	0.15	0.34	0.62	1.17	2.17	3.12	4.05	4.95	6.69	8.39	9.23	10.9	12.5	12.7	10.5	8.41	6.88	5.77	4.92	3.92	3.21	2.29	1.74	1.38	0
20	0.16	0.35	0.66	1.23	2.29	3.30	4.28	5.23	7.07	8.86	9.75	11.5	13.2	13.7	11.1	9.08	7.53	6.22	5.31	4.22	3.45	2.47	1.88	1.49	0
21	0.16	0.38	0.70	1.29	2.41	3.47	4.51	5.51	7.46	9.35	10.3	12.1	13.9	14.8	12.4	9.76	7.99	6.71	5.73	4.55	3.71	2.66	2.02	1.60	0
22	0.17	0.39	0.72	1.35	2.53	3.66	4.73	5.79	7.84	9.83	10.8	12.7	14.6	15.8	13.2	10.5	8.57	7.19	6.13	4.87	3.98	2.86	2.17	1.72	0
23	0.17	0.42	0.76	1.42	2.67	3.84	4.98	6.07	8.22	10.3	11.3	13.4	15.3	16.9	14.1	11.2	9.16	7.68	6.56	5.20	4.26	3.06	2.32	1.84	0
24	0.19	0.43	0.80	1.49	2.79	4.02	5.20	6.36	8.61	10.8	11.9	13.9	16.1	18.0	15.0	11.9	9.76	8.18	7.00	5.54	4.55	3.25	2.47	1.96	0
25	0.20	0.44	0.83	1.56	2.91	4.20	5.44	6.65	9.00	11.3	12.4	14.6	16.8	18.9	16.0	12.7	10.4	8.70	7.43	5.89	4.83	3.45	2.63	0	0
26	0.20	0.47	0.87	1.62	3.04	4.39	5.67	6.93	9.39	11.8	12.9	15.3	17.6	19.7	17.0	13.5	11.0	9.24	7.89	6.25	5.12	3.66	2.76	0	0
28	0.23	0.51	0.95	1.77	3.30	4.75	6.14	7.51	10.2	12.8	14.1	16.5	19.0	21.5	19.0	15.0	12.3	10.3	8.81	7.00	5.73	4.09	3.11	0	0
30	0.24	0.55	1.02	1.90	3.55	5.11	6.62	8.10	11.0	13.7	15.2	17.8	20.4	23.1	21.1	16.8	13.5	11.4	9.76	7.75	6.34	4.55	3.45	0	0
32	0.25	0.59	1.09	2.04	3.81	5.48	7.09	8.68	11.7	14.8	16.2	19.0	21.9	24.7	23.2	18.4	15.0	12.6	10.8	8.54	7.00	5.00	0	0	0
35	0.28	0.64	1.21	2.24	4.20	6.03	7.82	9.56	12.9	16.2	17.8	21.1	24.1	27.2	26.6	21.1	17.2	14.3	12.3	9.76	7.99	5.73	0	0	0
40	0.32	0.75	1.39	2.59	4.84	6.97	9.04	11.1	14.9	18.8	20.7	24.3	27.9	31.5	32.5	25.7	21.1	17.6	15.0	11.9	9.76	7.00	0	0	0
45	0.38	0.84	1.58	2.95	5.50	7.93	10.3	12.5	17.0	21.3	23.5	27.6	31.6	35.7	38.6	30.6	25.1	21.1	18.0	14.2	11.7	0	0	0	0

- Note: 1. Multiply the value given above by the multiple strand factor (page A-22, Table II) in order to obtain the transmission horsepower of multiple strand chain.
 2. For lubrication systems A, B & C, refer to page A-77 for explanation. Please consult U.S. Tsubaki for use of horsepower ratings to the right of the boundary line.
 3. Refer to page A-22, "Procedures for Selecting Roller Chain."

RS50 ^{5/8" Pitch}

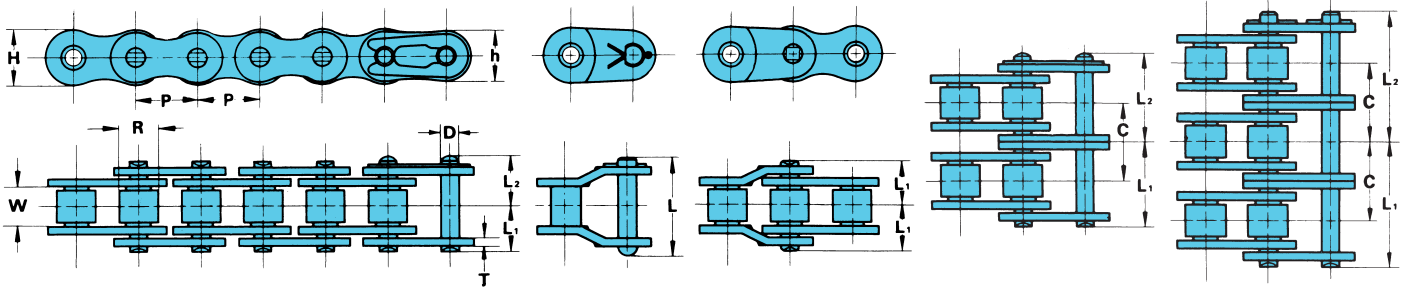

U.S. TSUBAKI Chain No.	ANSI No.	Pitch P	Roller Diameter R	Width Between Roller Link Plates W	Link Plate			Pin Diameter D
					T	H	h	
RS50	50	.625	.400	.375	.080	.591	.512	.200

U.S. TSUBAKI Chain No.	Number of Strands	Pin				Transverse Pitch C	Standard Type of Pin	Minimum Ultimate Strength ANSI Standard lbs.	Average Tensile Strength lbs.	* Maximum Allowable Load lbs.	Approx. Weight lbs./ft.	Number of Links per 10 ft.
		L ₁ +L ₂	L ₁	L ₂	L							
RS50	1	.878	.406	.472	.886	.713	Riveted	4,880	7,050	1,430	.70	192
RS50-2	2	1.595	.762	.833	1.646		Riveted	9,760	14,100	2,430	1.39	
RS50-3	3	2.307	1.118	1.189	2.358		Riveted	14,640	21,150	3,570	2.08	
RS50-4	4	3.020	1.475	1.545	3.075		Riveted	19,520	28,200	4,710	2.76	
RS50-5	5	3.732	1.831	1.901	3.787		Riveted	24,400	35,250	5,570	3.45	
RS50-6	6	4.449	2.189	2.260	4.504		Riveted	29,280	42,300	6,570	4.14	

Note: *Refer to page A-23, "Selection for Slow Speed."

Maximum Horsepower Ratings

No. of Teeth Small Spkt.	Maximum Speed - Small Sprocket (rpm)																								
	10	25	50	100	200	300	400	500	700	900	1000	1200	1400	1600	1800	2100	2400	2700	3000	3500	4000	4500	5000	5500	6000
	A											B						C							
11	0.16	0.38	0.71	1.33	2.48	3.58	4.64	5.66	7.67	9.62	10.6	10.3	8.14	6.65	5.58	4.43	3.62	3.04	2.59	2.07	1.68	1.41	1.21	1.05	0.93
12	0.19	0.42	0.78	1.46	2.72	3.93	5.10	6.22	8.42	10.6	11.6	11.7	9.27	7.59	6.36	5.04	4.13	3.46	2.95	2.35	1.92	1.61	1.37	1.19	1.05
13	0.20	0.46	0.86	1.60	2.98	4.28	5.55	6.79	9.19	11.5	12.7	13.2	10.4	8.56	7.16	5.70	4.65	3.90	3.33	2.64	2.16	1.81	1.56	1.34	0
14	0.21	0.50	0.93	1.73	3.22	4.64	6.01	7.35	9.95	12.5	13.7	14.8	11.7	9.56	8.02	6.36	5.20	4.36	3.73	2.95	2.43	2.02	1.73	1.50	0
15	0.23	0.54	0.99	1.86	3.47	5.00	6.48	7.93	10.7	13.4	14.8	16.4	13.0	10.6	8.89	7.05	5.77	4.83	4.13	3.27	2.68	2.25	1.92	1.66	0
16	0.25	0.58	1.07	2.00	3.73	5.36	6.95	8.49	11.5	14.3	15.8	18.0	14.3	11.7	9.79	7.76	6.36	5.32	4.55	3.61	2.95	2.47	2.11	1.84	0
17	0.27	0.62	1.14	2.13	3.97	5.73	7.42	9.07	12.3	15.4	16.9	19.7	15.7	12.8	10.7	8.50	6.96	5.83	4.99	3.96	3.23	2.71	2.31	2.01	0
18	0.28	0.66	1.22	2.27	4.22	6.09	7.89	9.64	13.0	16.4	18.0	21.2	17.0	13.9	11.7	9.27	7.59	6.36	5.42	4.30	3.53	2.95	2.52	0	
19	0.31	0.68	1.29	2.40	4.48	6.45	8.37	10.2	13.8	17.3	19.0	22.5	18.5	15.2	12.7	10.0	8.22	6.89	5.89	4.67	3.82	3.21	2.74	0	
20	0.32	0.72	1.35	2.53	4.73	6.83	8.84	10.8	14.6	18.4	20.1	23.7	20.0	16.4	13.7	10.8	8.89	7.44	6.36	5.04	4.13	3.46	2.95	0	
21	0.34	0.76	1.43	2.68	4.99	7.19	9.32	11.4	15.4	19.3	21.2	25.1	21.5	17.6	14.8	11.7	9.57	8.02	6.84	5.42	4.44	3.73	3.18	0	
22	0.35	0.80	1.50	2.82	5.24	7.56	9.80	12.0	16.2	20.4	22.4	26.3	23.1	18.8	15.8	12.5	10.2	8.60	7.34	5.82	4.76	4.00	3.41	0	
23	0.38	0.84	1.58	2.95	5.51	7.94	10.3	12.6	17.0	21.3	23.5	27.6	24.7	20.1	16.9	13.4	11.0	9.19	7.84	6.22	5.10	4.28	0		
24	0.39	0.89	1.66	3.08	5.77	8.30	10.8	13.2	17.8	22.4	24.5	29.0	26.3	21.5	18.0	14.3	11.7	9.79	8.35	6.64	5.42	4.55	0		
25	0.40	0.93	1.73	3.23	6.02	8.68	11.3	13.8	18.6	23.3	25.6	30.2	27.9	22.8	19.2	15.2	12.4	10.4	8.89	7.05	5.77	4.83	0		
26	0.43	0.97	1.81	3.37	6.29	9.05	11.7	14.3	19.4	24.4	26.8	31.5	29.6	24.3	20.2	16.1	13.2	11.0	9.43	7.47	6.13	5.14	0		
28	0.46	1.05	1.96	3.65	6.81	9.82	12.7	15.6	21.1	26.4	29.0	34.2	33.1	27.0	22.7	18.0	14.8	12.3	10.5	8.35	6.84	5.74	0		
30	0.50	1.13	2.11	3.93	7.34	10.6	13.7	16.8	22.7	28.4	31.2	36.7	36.7	30.0	25.1	19.8	16.4	13.7	11.7	9.27	7.59	0			
32	0.54	1.21	2.27	4.21	7.87	11.3	14.6	18.0	24.3	30.4	33.5	39.4	40.4	33.3	27.8	22.0	18.0	15.2	12.9	10.2	8.35	0			
35	0.59	1.33	2.49	4.64	8.66	12.5	16.2	19.7	26.8	33.5	36.9	43.4	46.3	38.1	31.6	25.1	20.7	17.2	14.8	11.7	9.56	0			
40	0.67	1.54	2.87	5.36	10.0	14.5	18.6	22.8	31.0	38.8	42.6	50.3	56.5	46.4	38.8	30.7	25.1	21.1	18.0	14.3	0				
45	0.76	1.74	3.27	6.09	11.4	16.4	21.2	25.9	35.1	44.0	48.4	57.0	65.6	55.1	46.1	36.6	30.0	25.1	21.5	0					

- Note: 1. Multiply the value given above by the multiple strand factor (page A-22, Table II) in order to obtain the transmission horsepower of multiple strand chain.
 2. For lubrication systems A, B & C, refer to page A-77 for explanation. Please consult U.S. Tsubaki for use of horsepower ratings to the right of the boundary line.
 3. Refer to page A-22, "Procedures for Selecting Roller Chain."

U.S. TSUBAKI RS ROLLER CHAIN

A - DRIVE CHAINS

RS60 ^{3/4" Pitch}

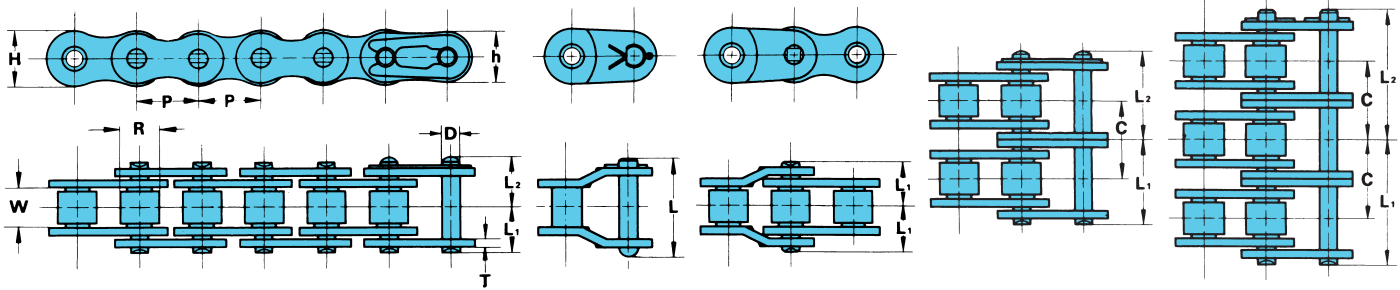

U.S. TSUBAKI Chain No.	ANSI No.	Pitch P	Roller Diameter R	Link Plate			Pin Diameter D	
				Width Between Roller Link Plates W	T	H		h
RS60	60	.750	.469	.500	.094	.713	.614	.234

U.S. TSUBAKI Chain No.	Number of Strands	Pin				Transverse Pitch C	Standard Type of Pin	Minimum Ultimate Strength ANSI Standard lbs.	Average Tensile Strength lbs.	* Maximum Allowable Load lbs.	Approx. Weight lbs./ft.	Number of Links per 10 ft.
		L ₁ +L ₂	L ₁	L ₂	L							
RS60	1	1.087	.506	.581	1.110	.897	Riveted	7,030	9,920	1,980	1.03	160
RS60-2	2	1.988	.955	1.033	2.071		Riveted	14,060	19,840	3,360	2.04	
RS60-3	3	2.906	1.404	1.502	2.972		Riveted	21,090	29,760	4,950	3.05	
RS60-4	4	3.803	1.852	1.951	3.870		Riveted	28,120	39,680	6,530	4.06	
RS60-5	5	4.705	2.303	2.402	4.772		Riveted	35,150	49,600	7,720	5.07	
RS60-6	6	5.606	2.752	2.854	5.669		Riveted	42,180	59,520	9,100	6.08	

Note: * Refer to page A-23, "Selection for Slow Speed."

Maximum Horsepower Ratings

No. of Teeth Small Spkt.	Maximum Speed - Small Sprocket (rpm)																								
	10	25	50	100	150	200	300	400	500	600	700	800	900	1000	1100	1200	1400	1600	1800	2000	2500	3000	3500	4000	4500
	A										B					C									
11	0.30	0.67	1.26	2.35	3.39	4.39	6.32	8.19	10.0	11.8	13.5	15.3	17.0	15.6	13.5	11.9	9.41	7.70	6.45	5.51	3.94	3.00	2.39	1.94	1.64
12	0.32	0.74	1.38	2.59	3.71	4.81	6.95	9.00	11.0	13.0	14.9	16.8	18.6	17.8	15.6	13.5	10.7	8.77	7.35	6.29	4.49	3.42	2.71	2.23	1.86
13	0.35	0.80	1.52	2.82	4.06	5.26	7.58	9.80	12.0	14.1	16.2	18.2	20.4	20.1	17.4	15.2	12.1	9.90	8.30	7.08	5.07	3.85	3.06	2.51	0
14	0.39	0.87	1.64	3.06	4.40	5.70	8.21	10.6	13.0	15.3	17.6	19.8	22.0	22.4	19.4	17.0	13.5	11.1	9.27	7.91	5.66	4.32	3.42	2.80	0
15	0.42	0.94	1.76	3.29	4.73	6.13	8.84	11.5	13.9	16.5	18.9	21.3	23.7	24.8	21.6	18.8	15.0	12.3	10.3	8.77	6.29	4.77	3.80	3.10	0
16	0.44	1.01	1.89	3.53	5.08	6.57	9.47	12.3	15.0	17.7	20.2	22.9	25.5	27.4	23.7	20.9	16.5	13.5	11.3	9.67	6.92	5.26	4.17	3.42	0
17	0.47	1.09	2.01	3.77	5.42	7.03	10.1	13.1	16.0	18.9	21.7	24.4	27.2	29.9	26.0	22.9	18.1	14.8	12.4	10.6	7.58	5.77	4.57	3.74	0
18	0.51	1.15	2.15	4.00	5.77	7.47	10.8	13.9	17.0	20.1	23.1	26.0	29.0	31.8	28.3	24.9	19.7	16.1	13.5	11.5	8.26	6.29	4.99	4.08	0
19	0.54	1.22	2.28	4.24	6.12	7.91	11.4	14.8	18.1	21.3	24.4	27.6	30.7	33.7	30.7	27.1	21.5	17.6	14.6	12.5	8.96	6.81	5.40	4.43	0
20	0.56	1.29	2.40	4.48	6.46	8.37	12.1	15.6	19.0	22.5	25.9	29.1	32.5	35.7	33.1	29.2	23.1	18.9	15.8	13.5	9.67	7.35	5.83	0	0
21	0.59	1.35	2.53	4.73	6.81	8.82	12.7	16.5	20.1	23.7	27.2	30.7	34.2	37.5	35.7	31.5	24.8	20.2	17.0	14.5	10.4	7.91	6.29	0	0
22	0.63	1.42	2.67	4.98	7.16	9.28	13.4	17.3	21.2	24.9	28.7	32.3	35.9	39.4	38.2	33.8	26.6	21.9	18.2	15.6	11.1	8.49	6.73	0	0
23	0.66	1.50	2.79	5.22	7.51	9.74	14.1	18.1	22.3	26.1	30.0	33.9	37.7	41.4	40.9	36.1	28.4	23.3	19.4	16.8	11.9	9.08	7.19	0	0
24	0.68	1.57	2.92	5.46	7.87	10.2	14.6	19.0	23.2	27.4	31.5	35.5	39.4	43.3	43.6	38.2	30.3	24.8	20.8	17.8	12.7	9.67	7.67	0	0
25	0.72	1.64	3.06	5.71	8.22	10.6	15.3	19.8	24.3	28.6	32.9	37.1	41.2	45.3	46.4	40.6	32.2	26.4	22.1	18.9	13.5	10.3	8.15	0	0
26	0.75	1.72	3.19	5.95	8.58	11.1	16.0	20.8	25.3	29.9	34.3	38.8	43.0	47.3	49.2	43.2	34.2	28.0	23.5	20.0	14.3	10.9	8.55	0	0
28	0.82	1.85	3.46	6.45	9.29	12.0	17.3	22.4	27.5	32.3	37.1	42.0	46.7	51.2	55.0	48.3	38.2	31.4	26.1	22.4	16.0	12.2	0	0	0
30	0.87	2.00	3.73	6.95	10.0	13.0	18.6	24.1	29.6	34.9	40.1	45.2	50.2	55.3	60.2	53.5	42.4	34.7	29.1	24.8	17.8	13.5	0	0	0
32	0.94	2.15	4.00	7.46	10.7	13.9	20.0	25.9	31.8	37.4	42.9	48.4	53.8	59.1	64.5	58.9	46.7	38.2	32.1	27.4	19.6	14.9	0	0	0
35	1.03	2.36	4.40	8.21	11.8	15.3	22.1	28.6	35.0	41.2	47.3	53.4	59.3	65.2	71.1	67.5	53.4	43.7	36.6	31.4	22.4	17.0	0	0	0
40	1.19	2.72	5.08	9.48	13.7	17.7	25.5	33.0	40.4	47.6	54.6	61.6	68.5	75.4	82.1	82.3	65.7	53.5	44.8	38.2	27.4	0	0	0	0
45	1.35	3.10	5.77	10.8	15.6	20.1	29.0	37.5	45.9	54.0	62.1	70.0	77.8	85.6	93.2	98.3	78.4	63.7	53.4	45.6	32.6	0	0	0	0

- Note: 1. Multiply the value given above by the multiple strand factor (page A-22, Table II) in order to obtain the transmission horsepower of multiple strand chain.
 2. For lubrication systems A, B & C, refer to page A-77 for explanation. Please consult U.S. Tsubaki for use of horsepower ratings to the right of the boundary line.
 3. Refer to page A-22, "Procedures for Selecting Roller Chain."

RS80 1" Pitch

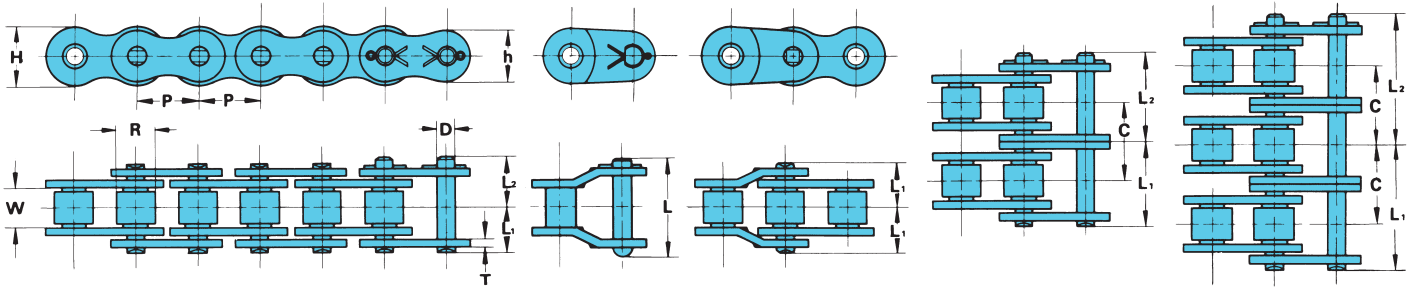

U.S. TSUBAKI Chain No.	ANSI No.	Pitch P	Roller Diameter R	Width Between Roller Link Plates W	Link Plate			Pin Diameter D
					T	H	h	
RS80	80	1.000	.625	.625	.125	.949	.819	.312

U.S. TSUBAKI Chain No.	Number of Strands	Pin				Transverse Pitch C	Standard Type of Pin	Minimum Ultimate Strength ANSI Standard lbs.	Average Tensile Strength lbs.	* Maximum Allowable Load lbs.	Approx. Weight lbs./ft.	Number of Links per 10 ft.
		L ₁ +L ₂	L ₁	L ₂	L							
RS80	1	1.398	.640	.758	1.417	1.153	Riveted	12,500	17,640	3,300	1.79	120
RS80-2	2	2.552	1.217	1.335	2.657		Riveted	25,000	35,280	5,610	3.54	
RS80-3	3	3.704	1.795	1.909	3.815		Riveted	37,500	52,920	8,250	5.30	
RS80-4	4	4.862	2.372	2.490	4.972		Riveted	50,000	70,560	10,890	7.06	
RS80-5	5	6.020	2.951	3.069	6.126		Riveted	62,500	88,200	12,870	8.81	
RS80-6	6	7.170	3.528	3.642	7.280		Riveted	75,000	105,840	15,180	10.57	

Note: * Refer to page A-23, "Selection for Slow Speed."

Maximum Horsepower Ratings

No. of Teeth Small Splt.	Maximum Speed - Small Sprocket (rpm)																											
	10	25	50	100	150	200	300	400	500	600	700	800	900	1000	1100	1200	1400	1600	1800	2000	2200	2400	2700	3000	3400			
	A														B							C						
11	0.88	2.02	3.76	7.02	10.1	13.1	18.9	24.4	29.9	30.3	30.3	27.4	23.0	19.6	17.0	14.9	11.8	9.70	8.13	6.94	6.01	5.28	4.42	3.78	1.70			
12	0.97	2.21	4.13	7.71	11.1	14.4	20.7	26.8	32.8	33.4	33.3	31.2	26.2	22.4	19.4	17.0	13.5	11.0	9.26	7.90	6.85	6.01	5.04	4.30				
13	1.06	2.41	4.50	8.40	12.1	15.7	22.6	29.3	35.8	36.3	36.3	35.2	29.5	25.2	21.9	19.2	15.2	12.5	10.4	8.91	7.73	6.78	5.68	4.85				
14	1.15	2.61	4.88	9.10	13.1	17.0	24.5	31.7	38.8	39.4	39.4	39.4	33.0	28.2	24.4	21.4	17.0	13.9	11.7	9.96	8.63	7.58	6.35	5.42				
15	1.23	2.82	5.26	9.81	14.1	18.3	26.4	34.2	41.8	43.7	43.7	43.7	36.6	31.2	27.1	23.8	18.9	15.4	12.9	11.0	9.58	8.40	7.04	6.01				
16	1.32	3.02	5.64	10.5	15.1	19.6	28.3	36.6	44.8	48.1	48.1	48.1	40.3	34.4	29.8	26.2	20.8	17.0	14.3	12.2	10.5	9.26	7.76	6.62				
17	1.41	3.22	6.02	11.2	16.2	21.0	30.2	39.1	47.8	56.3	52.7	52.7	44.2	37.7	32.7	28.7	22.8	18.6	15.6	13.3	11.6	10.1	8.50	7.26				
18	1.50	3.43	6.40	11.9	17.2	22.3	32.1	41.6	50.8	57.4	57.4	57.4	48.1	41.1	35.6	31.2	24.8	20.3	17.0	14.5	12.6	11.0	9.26	7.90				
19	1.59	3.64	6.79	12.7	18.2	23.6	34.0	44.1	53.9	61.7	61.7	61.7	52.2	44.5	38.6	33.9	26.9	22.0	18.4	15.7	13.7	12.0	10.0	8.57				
20	1.68	3.84	7.17	13.4	19.3	25.0	36.0	46.6	57.0	65.3	65.3	65.3	56.3	48.1	41.7	36.6	29.0	23.8	19.9	17.0	14.7	12.9	10.8					
21	1.78	4.05	7.56	14.1	20.3	26.3	37.9	49.1	60.0	68.8	68.8	68.8	60.6	51.8	44.9	39.4	31.2	25.6	21.4	18.3	15.9	13.9	11.7					
22	1.87	4.26	7.95	14.8	21.4	27.7	39.9	51.7	63.1	72.3	72.3	72.3	65.0	55.5	48.1	42.2	33.5	27.4	23.0	19.6	17.0	14.9	12.5					
23	1.96	4.47	8.34	15.6	22.4	29.0	41.8	54.2	66.2	75.9	75.9	75.9	69.5	59.3	51.4	45.1	35.8	29.3	24.6	21.0	18.2	16.0	13.4					
24	2.05	4.68	8.73	16.3	23.5	30.4	43.8	56.7	69.4	79.5	79.5	79.5	74.1	63.2	54.8	48.1	38.2	31.2	26.2	22.4	19.4	17.0	14.3					
25	2.14	4.89	9.13	17.0	24.5	31.8	45.8	59.3	72.5	83.0	83.0	83.0	78.7	67.2	58.3	51.1	40.6	33.2	27.8	23.8	20.6	18.1	15.2					
26	2.24	5.10	9.52	17.8	25.6	33.2	47.8	61.9	75.6	86.6	86.6	86.6	83.5	71.3	61.8	54.2	43.0	35.2	29.5	25.2	21.9	19.2	16.1					
28	2.42	5.53	10.3	19.2	27.7	35.9	51.7	67.0	81.9	93.9	93.9	93.9	93.3	79.7	69.1	60.6	48.1	39.4	33.0	28.2	24.4	21.4						
30	2.61	5.95	11.1	20.7	29.9	38.7	55.7	72.2	88.3	104	104	104	104	88.4	76.6	67.2	53.4	43.7	36.6	31.2	27.1	23.8						
32	2.80	6.38	11.9	22.2	32.0	41.5	59.8	77.4	94.6	112	114	114	114	97.4	84.4	74.1	58.8	48.1	40.3	34.4	29.8	26.2						
35	3.08	7.03	13.1	24.5	35.3	45.7	65.8	85.3	104	123	130	130	130	111	96.5	84.7	67.2	55.0	46.1	39.4	34.1							
40	3.56	8.12	15.2	28.3	40.8	52.8	76.0	98.5	120	142	153	153	153	136	118	104	82.1	67.2	56.3	48.1	20.0							
45	4.04	9.23	17.2	32.1	46.3	60.0	86.4	112	137	161	174	174	174	162	141	124	98.0	80.2	67.2	54.2								

Note: 1. Multiply the value given above by the multiple strand factor (page A-22, Table II) in order to obtain the transmission horsepower of multiple strand chain.

2. For lubrication systems A, B & C, refer to page A-77 for explanation. Please consult U.S. Tsubaki for use of horsepower ratings to the right of the boundary line.

3. Refer to page A-22, "Procedures for Selecting Roller Chain."

U.S. TSUBAKI RS ROLLER CHAIN

A - DRIVE CHAINS

RS100 1 1/4" Pitch

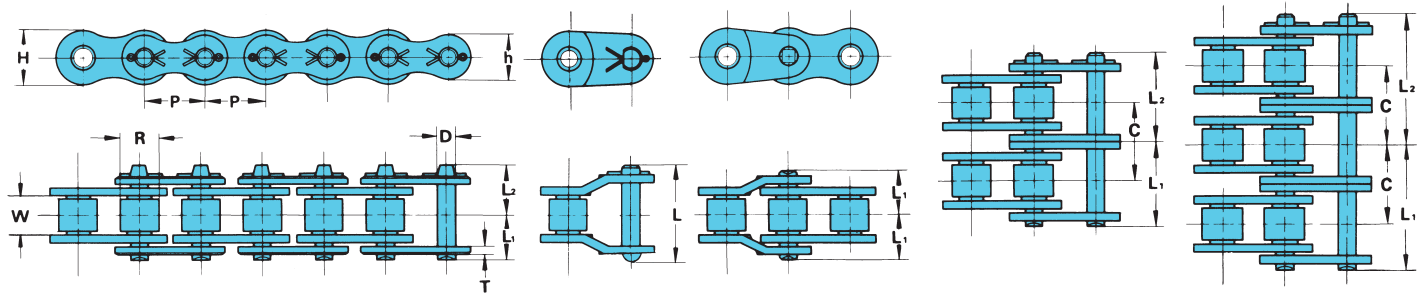

U.S. TSUBAKI Chain No.	ANSI No.	Pitch P	Roller Diameter R	Width Between Roller Link Plates		Link Plate			Pin Diameter D
				W	T	H	h		
RS100	100	1.250	.750	.750	.156	1.185	1.024	.375	

U.S. TSUBAKI Chain No.	Number of Strands	Pin				Transverse Pitch C	Standard Type of Pin	Minimum Ultimate Strength ANSI Standard lbs.	Average Tensile Strength lbs.	*Maximum Allowable Load lbs.	Approx. Weight lbs./ft.	Number of Links per 10 ft.
		L ₁ +L ₂	L ₁	L ₂	L							
RS100	1	1.678	.778	.900	1.748	1.408	Cottered	19,530	26,460	5,070	2.68	96
RS100-2	2	3.090	1.484	1.606	3.209		Cottered	39,060	52,920	8,610	5.27	
RS100-3	3	4.504	2.191	2.313	4.618		Cottered	58,590	79,380	12,670	7.91	
RS100-4	4	5.914	2.896	3.018	6.028		Riveted	78,120	105,840	16,730	10.55	
RS100-5	5	7.326	3.602	3.724	7.437		Riveted	97,650	132,300	19,770	13.12	
RS100-6	6	8.740	4.309	4.431	8.846		Riveted	117,180	158,760	23,320	15.78	

Note: *Refer to page A-23, "Selection for Slow Speed."

Maximum Horsepower Ratings

No. of Teeth Small Spkt.	Maximum Speed - Small Sprocket (rpm)																										
	10	25	50	100	150	200	300	400	500	600	700	800	900	1000	1100	1200	1300	1400	1600	1800	2000	2200	2400	2600	2700		
	A									B									C								
11	1.70	3.87	7.23	13.5	19.4	25.2	36.2	44.0	44.0	44.0	40.1	32.8	27.5	23.5	20.3	17.8	15.8	14.2	11.6	9.71	8.29	7.19	6.31	1.29			
12	1.86	4.25	7.94	14.8	21.3	27.6	39.8	48.4	48.4	48.4	45.6	37.4	31.3	26.7	23.2	20.3	18.0	16.1	13.2	11.1	9.45	8.19	7.19				
13	2.03	4.64	8.65	16.2	23.3	30.1	43.4	52.7	52.7	52.7	51.5	42.1	35.3	30.1	26.1	22.9	20.3	18.2	14.9	12.5	10.7	9.24	8.11				
14	2.20	5.02	9.38	17.5	25.2	32.6	47.0	57.5	57.5	57.5	47.1	39.4	33.7	29.2	25.6	22.7	20.3	16.6	13.9	11.9	10.3	9.06					
15	2.37	5.41	10.1	18.8	27.2	35.2	50.7	63.8	63.8	63.8	52.2	43.7	37.4	32.4	28.4	25.2	22.5	18.5	15.5	13.2	11.4	10.0					
16	2.54	5.80	10.8	20.2	29.1	37.7	54.3	70.3	70.3	70.3	57.5	48.2	41.2	35.7	31.3	27.8	24.8	20.3	17.0	14.5	12.6	11.1					
17	2.72	6.20	11.6	21.6	31.1	40.3	58.0	75.1	77.0	77.0	63.0	52.8	45.1	39.1	34.3	30.4	27.2	22.3	18.7	15.9	13.8	0.79					
18	2.89	6.59	12.3	23.0	33.1	42.8	61.7	79.9	83.8	83.8	68.6	57.5	49.1	42.6	37.4	33.1	29.6	24.3	20.3	17.4	15.0						
19	3.06	6.99	13.0	24.3	35.0	45.4	65.4	84.7	90.9	90.9	74.4	62.4	53.3	46.2	40.5	35.9	32.1	26.3	22.1	18.8	16.3						
20	3.24	7.39	13.8	25.7	37.0	48.0	69.1	89.6	96.4	96.4	80.4	67.4	57.5	49.8	43.7	38.8	34.7	28.4	23.8	20.3	17.6						
21	3.41	7.79	14.5	27.1	39.0	50.6	72.9	94.4	102	102	86.5	72.5	61.9	53.6	47.1	41.7	37.4	30.6	25.6	21.9	19.0						
22	3.59	8.19	15.3	28.5	41.1	53.2	76.6	99.3	107	107	92.7	77.7	66.3	57.5	50.5	44.8	40.1	32.8	27.5	23.5	20.3						
23	3.77	8.59	16.0	29.9	43.1	55.8	80.4	104	112	112	99.1	83.1	70.9	61.5	54.0	47.8	42.8	35.0	29.4	25.1	7.74						
24	3.94	8.99	16.8	31.3	45.1	58.4	84.2	109	117	117	106	88.5	75.6	65.5	57.5	51.0	45.6	37.4	31.3	26.7							
25	4.12	9.40	17.5	32.7	47.1	61.1	88.0	114	123	123	112	94.1	80.4	69.7	61.1	54.2	48.5	39.7	33.3	28.4							
26	4.30	9.80	18.3	34.1	49.2	63.7	91.8	119	128	128	119	99.8	85.2	73.9	64.8	57.5	51.5	42.1	35.3	30.1							
28	4.66	10.6	19.8	37.0	53.3	69.0	99.4	129	138	138	133	112	95.3	82.6	72.5	64.3	57.5	47.1	39.4	33.7							
30	5.02	11.4	21.4	39.8	57.4	74.4	107	139	149	149	148	124	106	91.6	80.4	71.3	63.8	52.2	43.7	10.0							
32	5.38	12.3	22.9	42.7	61.5	79.7	115	149	162	162	163	136	116	101	88.5	78.5	70.3	57.5	45.2								
35	5.93	13.5	25.2	47.1	67.8	87.8	127	164	186	186	186	156	133	115	101	89.8	80.4	65.8	55.1								
40	6.84	15.6	29.1	54.4	78.3	101	146	189	228	228	227	191	163	141	124	110	98.2	80.4									
45	7.77	17.7	33.1	61.7	88.9	115	166	215	263	263	261	227	194	168	148	131	117	45.3									

- Note: 1. Multiply the value given above by the multiple strand factor (page A-22, Table II) in order to obtain the transmission horsepower of multiple strand chain.
 2. For lubrication systems A, B & C, refer to page A-77 for explanation. Please consult U.S. Tsubaki for use of horsepower ratings to the right of the boundary line.
 3. Refer to page A-22, "Procedures for Selecting Roller Chain."

RS120 1 1/2" Pitch

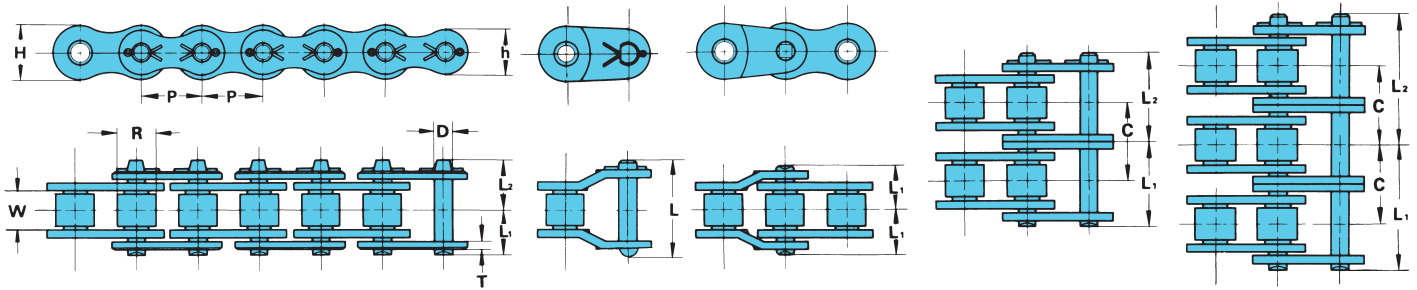

U.S. TSUBAKI	ANSI No.	Pitch	Roller Diameter	Width Between Roller Link Plates	Link Plate			Pin Diameter
Chain No.	P	R	W	T	H	h	D	
RS120	120	1.500	.875	1.000	.187	1.425	1.228	.437

U.S. TSUBAKI	Number of Strands	Pin				Transverse Pitch	Standard Type of Pin	Minimum Ultimate Strength ANSI Standard lbs.	Average Tensile Strength lbs.	*Maximum Allowable Load lbs.	Approx. Weight lbs./ft.	Number of Links per 10 ft.
		L ₁ +L ₂	L ₁	L ₂	L							
Chain No.					C							
RS120	1	2.118	.980	1.138	2.197	Cottered	28,125	37,480	6,830	3.98	80	
RS120-2	2	3.905	1.874	2.031	4.063	Cottered	56,250	74,960	11,560	7.86		
RS120-3	3	5.701	2.772	2.929	5.850	Cottered	84,375	112,440	17,070	11.78		
RS120-4	4	7.488	3.665	3.823	7.638	Riveted	112,500	149,920	22,530	15.70		
RS120-5	5	9.280	4.561	4.719	9.425	Riveted	140,625	187,400	26,630	19.59		
RS120-6	6	11.067	5.455	5.612	11.213	Riveted	168,750	224,880	31,410	23.49		

Note: *Refer to page A-23, "Selection for Slow Speed."

Maximum Horsepower Ratings

No. of Teeth Small Splt.	Maximum Speed - Small Sprocket (rpm)																								
	10	25	50	100	150	200	300	400	500	600	700	800	900	1000	1100	1200	1300	1400	1500	1600	1700	1800	1900	2000	2100
	A										B					C									
11	2.74	6.25	11.7	21.8	31.4	40.6	58.5	68.4	68.4	58.4	46.3	37.9	31.8	27.1	23.5	20.6	18.3	16.4	14.8	13.4	12.2	11.2	10.4	9.60	
12	3.01	6.87	12.8	23.9	34.4	44.6	64.3	75.2	75.2	66.5	52.8	43.2	36.2	30.9	26.8	23.5	20.9	18.7	16.8	15.3	14.0	12.8	11.8	10.9	
13	3.28	7.49	14.0	26.1	37.6	48.6	70.1	81.9	82.0	75.0	59.5	48.7	40.8	34.9	30.2	26.5	23.5	21.1	19.0	17.2	15.7	14.4	13.3	12.3	
14	3.56	8.11	15.1	28.2	40.7	52.7	75.9	88.8	88.8	83.8	66.5	54.5	45.6	39.0	33.8	29.6	26.3	23.5	21.2	19.3	17.6	16.1	14.9	8.9	
15	3.83	8.74	16.3	30.4	43.8	56.8	81.8	95.6	95.7	93.0	73.8	60.4	50.6	43.2	37.5	32.9	29.2	26.1	23.5	21.4	19.5	17.9	16.5		
16	4.11	9.37	17.5	32.6	47.0	60.9	87.7	103	103	102	81.3	66.5	55.8	47.6	41.3	36.2	32.1	28.7	25.9	23.5	21.5	19.7	18.2		
17	4.38	10.0	18.7	34.8	50.2	65.0	93.6	112	112	112	89.0	72.9	61.1	52.1	45.2	39.7	35.2	31.5	28.4	25.8	23.5	21.6	19.9		
18	4.66	10.6	19.9	37.0	53.4	69.1	99.6	122	122	122	97.0	79.4	66.5	56.8	49.2	43.2	38.3	34.3	30.9	28.1	25.6	23.5	11.3		
19	4.94	11.3	21.0	39.3	56.6	73.3	106	133	133	133	105	86.1	72.2	61.6	53.4	46.9	41.6	37.2	33.5	30.4	27.8	25.5			
20	5.23	11.9	22.2	41.5	59.8	77.5	112	143	143	143	114	93.0	77.9	66.5	57.7	50.6	44.9	40.2	36.2	32.9	30.0	27.6			
21	5.51	12.6	23.5	43.8	63.0	81.7	118	152	154	154	122	100	83.8	71.6	62.1	54.5	48.3	43.2	39.0	35.4	32.3	29.6			
22	5.79	13.2	24.7	46.0	66.3	85.9	124	160	165	165	131	107	89.9	76.8	66.5	58.4	51.8	46.3	41.8	37.9	34.6	16.6			
23	6.08	13.9	25.9	48.3	69.5	90.1	130	168	177	177	140	115	96.1	82.1	71.1	62.4	55.4	49.5	44.7	40.5	37.0				
24	6.36	14.5	27.1	50.5	72.8	94.3	136	176	188	187	149	122	102	87.5	75.8	66.5	59.0	52.8	47.6	43.2	39.5				
25	6.65	15.2	28.3	52.8	76.1	98.6	142	184	196	196	159	130	109	93.0	80.6	70.7	62.7	56.1	50.6	45.9	41.3				
26	6.94	15.8	29.5	55.1	79.4	103	148	192	204	204	168	138	116	98.6	85.5	75.0	66.5	59.5	53.7	48.7	26.6				
28	7.52	17.1	32.0	59.7	86.0	111	160	208	221	221	188	154	129	110	96.0	83.8	74.4	66.5	60.0	54.5					
30	8.10	18.5	34.5	64.3	92.7	120	173	224	239	238	209	171	143	122	106	93.0	82.5	73.8	66.5	42.4					
32	8.68	19.8	37.0	69.0	99.3	129	185	240	256	256	230	188	158	135	117	102	90.9	81.3	73.3						
35	9.56	21.8	40.7	76.0	109	142	204	265	282	282	263	215	180	154	134	117	104	93.0	47.7						
40	11.0	25.2	47.0	87.8	126	164	236	306	325	325	321	263	220	188	163	143	127	59.5							
45	12.5	28.6	53.4	99.7	144	186	268	347	384	384	383	314	263	225	195	171	80.1								

1. Multiply the value given above by the multiple strand factor (page A-22, Table II) in order to obtain the transmission horsepower of multiple strand chain.
2. For lubrication systems A, B & C, refer to page A-77 for explanation. Please consult U.S. Tsubaki for use of horsepower ratings to the right of the boundary line.
3. Refer to page A-22, "Procedures for Selecting Roller Chain."

U.S. TSUBAKI RS ROLLER CHAIN

A - DRIVE CHAINS

RS140 1 3/4" Pitch

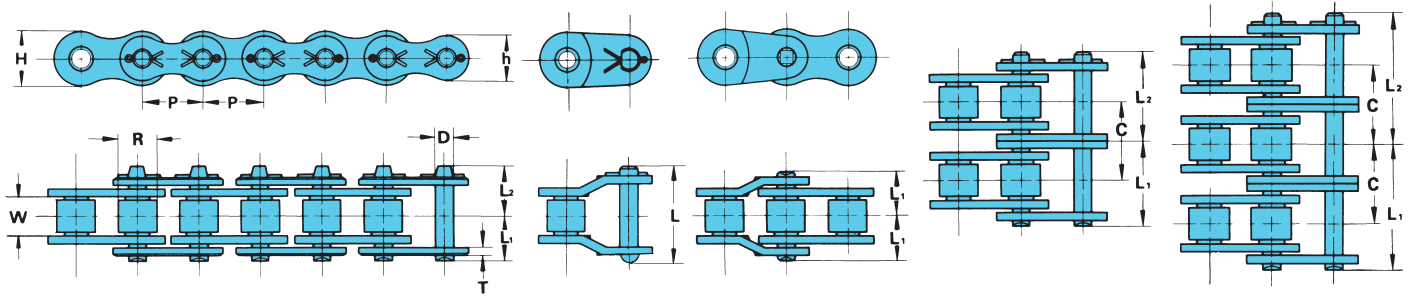

U.S. TSUBAKI Chain No.	ANSI No.	Pitch P	Roller Diameter R	Width Between Roller Link Plates W	Link Plate			Pin Diameter D
					T	H	h	
RS140	140	1.750	1.000	1.000	.219	1.661	1.433	.500

U.S. TSUBAKI Chain No.	Number of Strands	Pin				Transverse Pitch C	Standard Type of Pin	Minimum Ultimate Strength ANSI Standard lbs.	Average Tensile Strength lbs.	*Maximum Allowable Load lbs.	Approx. Weight lbs./ft.	Number of Links per 10 ft.
		L ₁ +L ₂	L ₁	L ₂	L							
RS140	1	2.307	1.059	1.248	2.382	1.924	Cottered	38,280	48,510	9,040	5.03	68
RS140-2	2	4.233	2.022	2.211	4.421		Cottered	76,560	97,020	15,360	9.97	
RS140-3	3	6.165	2.986	3.179	6.350		Cottered	114,840	145,530	22,600	14.92	
RS140-4	4	8.091	3.949	4.142	8.276		Riveted	153,120	194,040	29,830	19.16	
RS140-5	5	10.015	4.913	5.102	10.201		Riveted	191,400	242,550	35,250	24.84	
RS140-6	6	11.949	5.878	6.071	12.126		Riveted	229,680	291,060	41,580	29.77	

Note: * Refer to page A-23, "Selection for Slow Speed."

Maximum Horsepower Ratings

No. of Teeth Small Spkt.	Maximum Speed - Small Sprocket (rpm)																												
	10	25	50	100	150	200	250	300	350	400	450	500	550	600	700	800	900	1000	1100	1200	1300	1400	1500	1600	1700				
	Lubrication System A										Lubrication System B										Lubrication System C								
11	4.23	9.64	18.0	33.6	48.4	62.7	76.6	90.3	97.5	97.5	97.5	86.8	75.3	66.1	52.4	42.9	36.0	30.7	26.6	23.4	20.7	18.5	16.7	15.2					
12	4.64	10.6	19.8	36.9	53.1	68.8	84.1	99.2	107	107	107	98.9	85.8	75.3	59.7	48.9	41.0	35.0	30.3	26.6	23.6	21.1	19.0	17.3					
13	5.06	11.5	21.6	40.2	57.9	75.1	91.7	108	117	117	117	112	96.7	84.9	67.4	55.1	46.2	39.4	34.2	30.0	26.6	23.8	21.5	19.5					
14	5.49	12.5	23.3	43.6	62.8	81.3	99.4	117	127	127	127	125	108	94.9	75.3	61.6	51.6	44.1	38.2	33.5	29.7	26.6	24.0	21.8					
15	5.91	13.5	25.2	46.9	67.6	87.6	107	126	138	138	138	138	120	105	83.5	68.3	57.3	48.9	42.4	37.2	33.0	29.5	26.6						
16	6.34	14.5	27.0	50.3	72.5	93.9	115	135	153	153	153	152	132	116	92.0	75.3	63.1	53.9	46.7	41.0	36.3	32.5	29.3						
17	6.76	15.4	28.8	53.7	77.4	100	123	144	166	166	166	167	145	127	101	82.4	69.1	59.0	51.1	44.9	39.8	35.6	32.1						
18	7.20	16.4	30.6	57.2	82.3	107	130	154	176	182	182	182	158	138	110	89.8	75.3	64.3	55.7	48.9	43.4	38.8	35.0						
19	7.63	17.4	32.5	60.6	87.3	113	138	163	187	193	193	193	171	150	119	97.4	81.6	69.7	60.4	53.0	47.0	42.1	37.9						
20	8.06	18.4	34.3	64.0	92.3	120	146	172	198	204	204	205	185	162	129	105	88.2	75.3	65.2	57.3	50.8	45.4							
21	8.50	19.4	36.2	67.5	97.2	126	154	181	208	216	216	216	199	174	138	113	94.9	81.0	70.2	61.6	54.6	48.9							
22	8.94	20.4	38.0	71.0	102	132	162	191	219	227	227	227	213	187	148	121	102	86.8	75.3	66.1	58.6	52.4							
23	9.38	21.4	39.9	74.5	107	139	170	200	230	237	237	238	228	200	159	130	109	92.8	80.5	70.6	62.6	56.0							
24	9.82	22.4	41.8	78.0	112	146	178	210	241	249	249	249	243	213	169	138	116	98.9	85.8	75.3	66.8	59.7							
25	10.3	23.4	43.7	81.5	117	152	186	219	252	260	260	260	258	226	180	147	123	105	91.2	80.0	71.0	63.5							
26	10.7	24.4	45.6	85.0	122	159	194	229	263	274	274	274	274	240	191	156	131	112	96.7	84.9	75.3								
28	11.6	26.5	49.4	92.1	133	172	210	248	284	306	306	306	306	268	213	174	146	125	108	94.9	84.1								
30	12.5	28.5	53.2	99.2	143	185	226	267	306	339	339	339	339	298	236	193	162	138	120	105	93.3								
32	13.4	30.6	57.0	106	153	199	243	286	329	370	370	370	370	328	260	213	178	152	132	116									
35	14.8	33.7	62.8	117	169	219	267	315	362	408	408	408	408	375	298	244	204	174	151	133									
40	17.0	38.9	72.6	135	195	253	309	364	418	471	471	471	471	458	364	298	249	213	178										
45	19.4	44.2	82.4	154	221	287	351	413	475	535	547	547	547	547	434	355	298	237	192.8										

- Note: 1. Multiply the value given above by the multiple strand factor (page A-22, Table II) in order to obtain the transmission horsepower of multiple strand chain.
 2. For lubrication systems A, B & C, refer to page A-77 for explanation. Please consult U.S. Tsubaki for use of horsepower ratings to the right of the boundary line.
 3. Refer to page A-22, "Procedures for Selecting Roller Chain."

RS160 2" Pitch

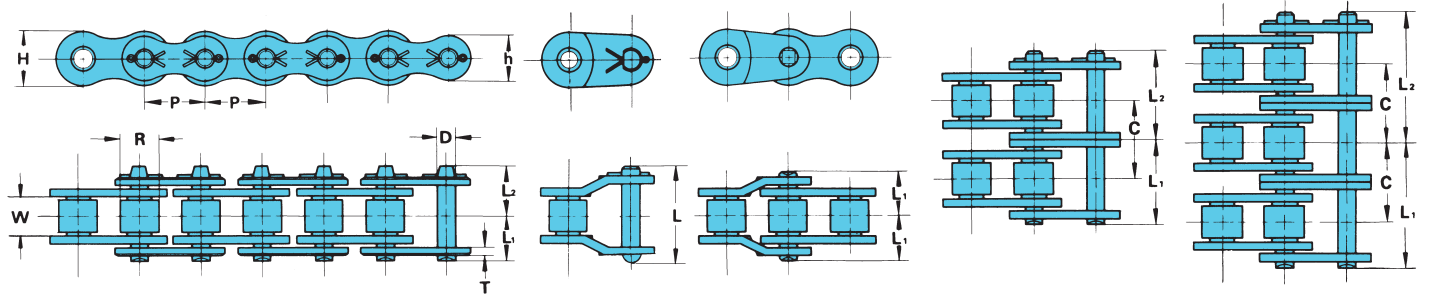

U.S. TSUBAKI	ANSI No.	Pitch	Roller Diameter	Width Between Link Plates	Link Plate			Pin Diameter
Chain No.	P	R	W	T	H	h	D	
RS160	160	2.000	1.125	1.250	.250	1.898	1.638	.562

U.S. TSUBAKI	Number of Strands	Pin				Transverse Pitch	Standard Type of Pin	Minimum Ultimate Strength ANSI Standard lbs.	Average Tensile Strength lbs.	* Maximum Allowable Load lbs.	Approx. Weight lbs./ft.	Number of Links per 10 ft.
		L ₁ +L ₂	L ₁	L ₂	L							
RS160	1	2.705	1.254	1.451	2.795	2.305	Cottered	50,000	60,630	11,900	6.79	60
RS160-2	2	5.011	2.407	2.604	5.205		Cottered	100,000	121,260	20,230	13.47	
RS160-3	3	7.319	3.561	3.758	7.508		Cottered	150,000	181,890	29,750	20.17	
RS160-4	4	9.622	4.715	4.907	9.811		Riveted	200,000	242,520	39,270	26.92	
RS160-5	5	11.929	5.868	6.061	12.114		Riveted	250,000	303,150	46,410	33.53	
RS160-6	6	14.237	7.020	7.217	14.417		Riveted	300,000	363,780	54,740	40.27	

Note: * Refer to page A-23, "Selection for Slow Speed."

Maximum Horsepower Ratings

No. of Teeth Small Spkt.	Maximum Speed - Small Sprocket (rpm)																								
	10	25	50	100	150	200	250	300	350	400	450	500	550	600	650	700	750	800	850	900	1000	1100	1200	1300	1400
	Lubrication System																								
	A					B					C														
11	6.37	14.5	27.1	50.6	72.9	94.4	115	132	132	132	113	96.6	83.8	73.5	65.2	58.3	52.6	47.7	43.6	40.0	34.2	29.6	26.0	23.0	
12	7.00	16.0	29.8	55.6	80.1	104	127	145	145	145	129	110	95.4	83.8	74.3	66.5	59.9	54.4	49.7	45.6	38.9	33.7	29.6	26.3	
13	7.63	17.4	32.5	60.6	87.3	113	138	158	158	158	145	124	108	94.4	83.8	74.9	67.6	61.3	56.0	51.4	43.9	38.0	33.4	29.6	
14	8.26	18.9	35.2	65.7	94.6	123	150	172	172	172	163	139	120	106	93.6	83.8	75.5	68.6	62.6	57.5	49.1	42.5	37.3	33.1	
15	8.90	20.3	37.9	70.7	102	132	161	185	185	185	180	154	133	117	104	92.9	83.8	76.0	69.4	63.7	54.4	47.2	41.4		
16	9.55	21.8	40.6	75.8	109	142	173	198	198	198	170	147	129	114	102	92.3	83.8	76.5	70.2	59.9	51.9	45.6			
17	10.2	23.3	43.4	81.0	117	151	185	217	217	217	186	161	141	125	112	101	91.7	83.8	76.9	65.6	56.9	49.9			
18	10.8	24.7	46.2	86.1	124	161	196	231	237	237	202	175	154	136	122	110	99.9	91.3	83.8	71.5	62.0	54.4			
19	11.5	26.2	48.9	91.3	132	170	208	245	257	257	219	190	167	148	132	119	108	99.0	90.8	77.6	67.2	59.0			
20	12.1	27.7	51.7	96.5	139	180	220	259	278	278	237	205	180	160	143	129	117	107	98.1	83.8	72.6	63.7			
21	12.8	29.2	54.5	102	147	190	232	273	295	295	255	221	194	172	154	139	126	115	106	90.1	78.1	68.6			
22	13.5	30.7	57.3	107	154	200	244	288	310	310	273	237	208	184	165	149	135	123	113	96.6	83.8				
23	14.1	32.2	60.1	112	162	209	256	302	326	326	292	253	222	197	176	159	144	132	121	103	89.5				
24	14.8	33.7	63.0	118	169	219	268	316	341	341	311	270	237	210	188	170	154	140	129	110	95.4				
25	15.5	35.3	65.8	123	177	229	280	330	357	357	331	287	252	223	200	180	164	149	137	117	101				
26	16.1	36.8	68.7	128	185	239	292	344	371	371	351	304	267	237	212	191	174	158	145	124	108				
28	17.5	39.9	74.4	139	200	259	317	373	402	402	392	340	299	265	237	214	194	177	163	139	120				
30	18.8	42.9	80.1	150	215	279	341	402	436	436	436	377	331	294	263	237	215	196	180	154					
32	20.2	46.0	85.9	160	231	299	366	431	480	480	480	416	365	323	289	261	237	216	199	170					
35	22.2	50.7	94.6	177	254	330	403	475	545	548	548	475	417	370	331	299	271	247	227	180					
40	25.7	58.6	109	204	294	381	465	548	630	650	650	581	510	452	405	365	331	302	257						
45	29.2	66.5	124	232	334	432	528	623	715	739	739	693	608	539	483	418	349	271	189						

- Note: 1. Multiply the value given above by the multiple strand factor (page A-22, Table II) in order to obtain the transmission horsepower of multiple strand chain.
 2. For lubrication systems A, B & C, refer to page A-77 for explanation. Please consult U.S. Tsubaki for use of horsepower ratings to the right of the boundary line.
 3. Refer to page A-22, "Procedures for Selecting Roller Chain."

U.S. TSUBAKI RS ROLLER CHAIN

RS180 2 1/4" Pitch

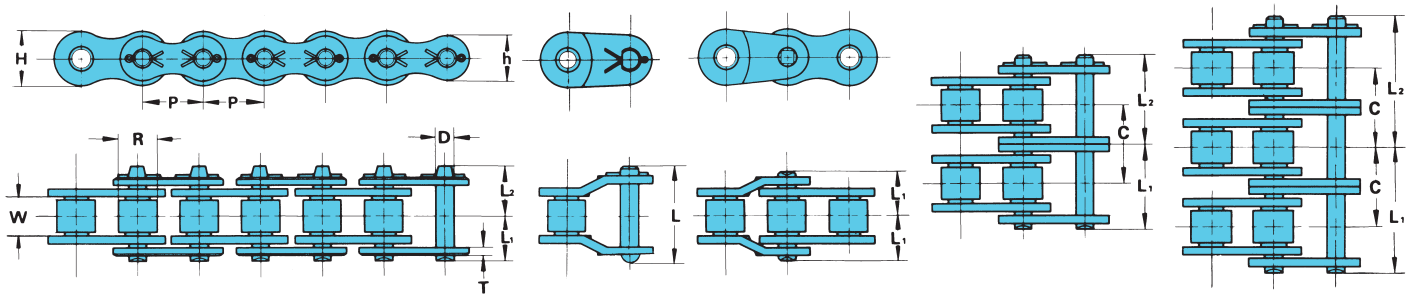

U.S. TSUBAKI Chain No.	ANSI No.	Pitch P	Roller Diameter R	Link Plate				Pin Diameter D
				Width Between Roller Link Plates W	T	H	h	
RS180	180	2.250	1.406	1.406	.281	2.134	1.843	.687

U.S. TSUBAKI Chain No.	Number of Strands	Pin				Transverse Pitch C	Standard Type of Pin	Minimum Ultimate Strength ANSI Standard lbs.	Average Tensile Strength lbs.	*Maximum Allowable Load lbs.	Approx. Weight lbs./ft.	Number of Links per 10 ft.
		L ₁ +L ₂	L ₁	L ₂	L							
RS180	1	3.075	1.404	1.671	3.173	2.592	Cottered	63,280	80,480	13,670	9.04	54
RS180-2	2	5.674	2.707	2.967	5.949		Cottered	126,560	160,960	23,230	17.82	
RS180-3	3	8.276	4.004	4.272	8.539		Cottered	189,840	241,440	34,170	25.68	
RS180-4	4	10.870	5.301	5.569	11.134		Riveted	253,120	321,920	45,110	34.20	
RS180-5	5	13.464	6.598	6.866	13.724		Riveted	316,400	402,400	53,310	42.73	
RS180-6	6	16.059	7.896	8.163	16.315		Riveted	379,680	482,880	62,880	51.25	

Note: *Refer to page A-23, "Selection for Slow Speed."

Maximum Horsepower Ratings

No. of Teeth Small Spkt.	Maximum Speed - Small Sprocket (rpm)																								
	10	25	50	100	150	200	250	300	350	400	450	500	550	600	650	700	750	800	850	900	950	1000	1050	1100	1150
	A										B										C				
11	8.22	18.8	35.0	65.3	94.1	122	149	152	152	148	124	106	92.0	80.8	71.6	64.1	57.8	52.5	47.9	44.0	40.5	37.5	34.9	32.5	
12	9.03	20.6	38.4	71.7	103	134	164	169	169	169	142	121	105	92.0	81.6	73.0	65.9	59.8	54.6	50.1	46.2	42.8	39.8	37.1	
13	9.85	22.5	41.9	78.2	113	146	178	190	190	191	160	136	118	104	92.0	82.4	74.3	67.4	61.5	56.5	52.1	48.2	44.8		
14	10.7	24.3	45.4	84.7	122	158	193	213	213	213	179	152	132	116	103	92.0	83.0	75.3	68.8	63.1	58.2	53.9	50.1		
15	11.5	26.2	48.9	91.3	131	170	208	236	236	236	198	169	147	129	114	102	92.0	83.5	76.3	70.0	64.6	59.8	55.6		
16	12.3	28.1	52.4	97.9	141	183	223	256	256	256	218	186	161	142	126	112	101	92.0	84.0	77.1	71.1	65.9	61.2		
17	13.2	30.0	56.0	104	151	195	238	270	270	270	239	204	177	155	138	123	111	101	92.0	84.5	77.9	72.1			
18	14.0	31.9	59.6	111	160	207	254	290	290	290	260	222	193	169	150	134	121	110	100	92.0	84.9	78.6			
19	14.8	33.8	63.1	118	170	220	269	307	307	307	282	241	209	183	163	146	131	119	109	99.8	92.0	85.2			
20	15.7	35.8	66.7	125	179	232	284	326	326	326	305	260	226	198	176	157	142	129	117	108	99.4	92.0			
21	16.5	37.7	70.4	131	189	245	299	343	343	343	328	280	243	213	189	169	152	138	126	116	107	99.0			
22	17.4	39.6	74.0	138	199	258	315	361	361	361	352	300	260	228	203	181	163	148	135	124	115				
23	18.2	41.6	77.6	145	209	270	330	378	378	378	376	321	278	244	217	194	175	159	145	133	123				
24	19.1	43.5	81.3	152	218	283	346	401	401	401	342	297	260	231	207	186	169	154	142	131					
25	20.0	45.5	84.9	158	228	296	362	426	426	426	364	315	277	245	220	198	180	164	151	139					
26	20.8	47.5	88.6	165	238	309	377	444	452	452	386	334	294	260	233	210	191	174	160						
28	22.5	51.4	96.0	179	258	334	409	481	506	506	431	374	328	291	260	235	213	195	179						
30	24.3	55.4	103	193	278	360	440	519	561	561	478	415	364	323	289	260	236	216	198						
32	26.0	59.4	111	207	298	386	472	556	601	601	527	457	401	355	318	287	260	238							
35	28.7	65.5	122	228	328	425	520	613	662	662	603	522	458	407	364	328	291	220							
40	33.1	75.6	141	263	379	491	601	676	676	676	621	575	524	465	398	325	244								
45	37.6	85.9	160	299	431	558	682	739	739	739	680	632	578	514	441	361	271								

- Note: 1. Multiply the value given above by the multiple strand factor (page A-22, Table II) in order to obtain the transmission horsepower of multiple strand chain.
 2. For lubrication systems A, B & C, refer to page A-77 for explanation. Please consult U.S. Tsubaki for use of horsepower ratings to the right of the boundary line.
 3. Refer to page A-22, "Procedures for Selecting Roller Chain."

RS200 2 1/2" Pitch

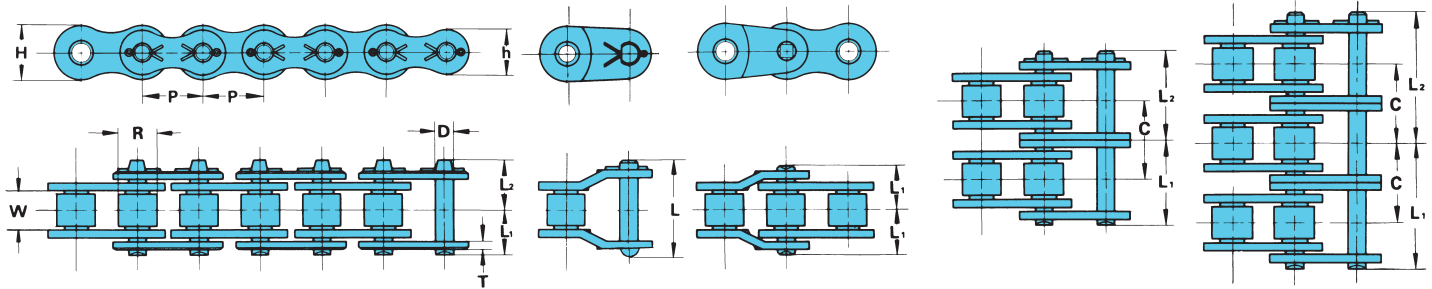

U.S. TSUBAKI Chain No.	ANSI No.	Pitch P	Roller Diameter R	Width Between Roller Link Plates W	Link Plate			Pin Diameter D
					T	H	h	
RS200	200	2.500	1.562	1.500	.312	2.374	2.047	.781

U.S. TSUBAKI Chain No.	Number of Strands	Pin				Transverse Pitch C	Standard Type of Pin	Minimum Ultimate Strength ANSI Standard lbs.	Average Tensile Strength lbs.	* Maximum Allowable Load lbs.	Approx. Weight lbs./ft.	Number of Links per 10 ft.
		L ₁ +L ₂	L ₁	L ₂	L							
RS200	1	3.299	1.535	1.764	3.437	2.817	Cottered	78,125	103,630	16,090	11.08	48
RS200-2	2	6.122	2.947	3.175	6.346		Cottered	156,250	207,260	27,350	21.93	
RS200-3	3	8.945	4.360	4.585	9.173		Riveted	234,375	310,890	40,220	32.94	
RS200-4	4	11.768	5.772	5.996	11.996		Riveted	312,500	414,520	53,090	43.79	
RS200-5	5	14.590	7.181	7.409	14.815		Riveted	390,625	518,150	62,750	54.64	
RS200-6	6	17.414	8.593	8.821	17.638		Riveted	468,750	621,780	74,010	65.58	

Note: * Refer to page A-23, "Selection for Slow Speed."

Maximum Horsepower Ratings

No. of Teeth Small Spkt.	Maximum Speed – Small Sprocket (rpm)																			
	10	15	20	30	40	50	70	100	150	200	250	300	350	400	450	500	550	600	650	700
	Lubrication System																			
	A				B								C							
11	10.8	15.5	20.1	28.9	37.5	45.8	62.0	85.4	123	159	181	181	181	161	135	116	100	87.9	77.9	
12	11.8	17.0	22.0	31.8	41.1	50.3	68.1	93.9	135	175	198	198	198	184	154	132	114	100		
13	12.9	18.6	24.0	34.6	44.9	54.8	74.2	102	147	191	216	216	216	207	174	148	129	113		
14	14.0	20.1	26.0	37.5	48.6	59.4	80.4	111	160	207	235	235	235	232	194	166	144	126		
15	15.0	21.7	28.1	40.4	52.4	64.0	86.6	119	172	223	257	257	257	257	215	184	159	140		
16	16.1	23.2	30.1	43.3	56.1	68.6	92.9	128	184	239	283	283	283	283	237	203	176	154		
17	17.2	24.8	32.1	46.3	59.9	73.3	99.2	137	197	255	310	310	310	310	260	222	192	169		
18	18.3	26.4	34.2	49.2	63.8	77.9	105	145	209	271	332	338	338	338	283	242	210	184		
19	19.4	28.0	36.2	52.2	67.6	82.6	112	154	222	288	352	366	366	366	307	262	227	199		
20	20.5	29.6	38.3	55.1	71.4	87.3	118	163	235	304	372	389	389	389	332	283	245			
21	21.6	31.1	40.4	58.1	75.3	92.1	125	172	247	321	392	409	409	409	357	305	264			
22	22.7	32.8	42.4	61.1	79.2	96.8	131	181	260	337	412	430	430	430	383	327	283			
23	23.9	34.4	44.5	64.1	83.1	102	137	190	273	354	432	452	452	452	409	349	303			
24	25.0	36.0	46.6	67.1	87.0	106	144	198	286	370	453	473	473	473	436	372	323			
25	26.1	37.6	48.7	70.2	90.9	111	150	207	299	387	473	495	495	495	464	396	343			
26	27.2	39.2	50.8	73.2	94.8	116	157	216	312	404	493	516	516	516	492	420	364			

- Note: 1. Multiply the value given above by the multiple strand factor (page A-22, Table II) in order to obtain the transmission horsepower of multiple strand chain.
 2. For lubrication systems A, B & C, refer to page A-77 for explanation. Please consult U.S. Tsubaki for use of horsepower ratings to the right of the boundary line.
 3. Refer to page A-22, "Procedures for Selecting Roller Chain."

U.S. TSUBAKI RS ROLLER CHAIN

RS240 3" Pitch

A - DRIVE CHAINS

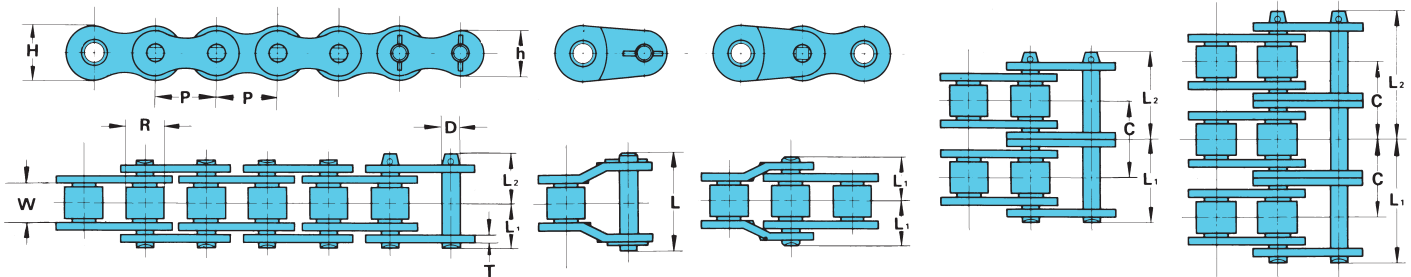

U.S. TSUBAKI Chain No.	ANSI No.	Pitch P	Roller Diameter R	Link Plate				Pin Diameter D
				Width Between Roller Link Plates W	T	H	h	
RS240	240	3.000	1.875	1.875	.375	2.850	2.457	.937

U.S. TSUBAKI Chain No.	Number of Strands	Pin				Transverse Pitch C	Standard Type of Pin	Minimum Ultimate Strength ANSI Standard lbs.	Average Tensile Strength lbs.	*Maximum Allowable Load lbs.	Approx. Weight lbs./ft.	Number of Links per 10 ft.
		L ₁ +L ₂	L ₁	L ₂	L							
RS240	1	4.071	1.886	2.185	4.201	3.458	Riveted	112,500	152,140	22,270	16.46	40
RS240-2	2	7.531	3.618	3.913	7.811		Riveted	225,000	304,280	37,850	32.32	
RS240-3	3	10.984	5.348	5.636	11.272		Riveted	337,500	456,420	55,670	48.11	
RS240-4	4	14.453	7.079	7.374	14.732		Riveted	450,000	608,560	73,490	63.90	
RS240-5	5	17.913	8.809	9.104	18.189		Riveted	562,500	760,700	86,850	79.70	
RS240-6	6	21.370	10.539	10.831	21.657		Riveted	675,000	912,840	102,440	95.49	

Note: * Refer to page A-23, "Selection for Slow Speed."

Maximum Horsepower Ratings

No. of Teeth Small Spkt.	Maximum Speed - Small Sprocket (rpm)																				
	5	10	15	20	25	30	40	50	60	80	100	125	150	175	200	250	300	350	400	450	500
	A											B					C				
11	9.56	17.8	25.7	33.3	40.7	48.0	62.1	76.0	89.5	116	142	173	204	235	265	271	271	228	188	156	
12	10.5	19.6	28.2	36.6	44.7	52.7	68.3	83.5	98.3	127	156	190	224	258	291	298	298	260	213		
13	11.5	21.4	30.8	39.9	48.8	57.5	74.4	91.0	107	139	170	208	245	281	317	325	325	294	240		
14	12.4	23.2	33.4	43.2	52.8	62.2	80.6	98.6	116	150	184	225	265	304	343	353	353	329	268		
15	13.4	24.9	35.9	46.6	56.9	67.1	86.9	106	125	162	198	242	285	328	370	380	380	363	298		
16	14.3	26.7	38.5	49.9	61.0	71.9	93.1	114	134	174	212	260	306	352	397	401	401	361	329		
17	15.3	28.6	41.1	53.3	65.1	76.8	99.5	122	143	186	227	277	327	375	402	402	402	377	359		
18	16.3	30.4	43.8	56.7	69.3	81.7	106	129	152	197	241	295	348	399	406	406	406	390	377		
19	17.3	32.2	46.4	60.1	73.5	86.6	112	137	162	209	256	313	368	423	425	425	425	408	393		
20	18.2	34.0	49.0	63.5	77.6	91.5	119	145	171	221	270	331	389	443	443	443	443	424	408		
21	19.2	35.9	51.7	67.0	81.8	96.4	125	153	180	233	285	348	411	463	463	463	463	440	421		
22	20.2	37.7	54.3	70.4	86.1	101	131	161	189	245	300	366	432	464	464	464	459	455	422		
23	21.2	39.6	57.0	73.9	90.3	106	138	169	199	257	314	384	453	496	496	496	481	469	448		
24	22.2	41.4	59.7	77.3	94.5	111	144	176	208	269	329	402	474	531	531	531	504	483			
25	23.2	43.3	62.4	80.8	98.8	116	151	184	217	281	344	421	496	550	550	550	520	496			
26	24.2	45.2	65.1	84.3	103	121	157	192	227	294	359	439	517	561	561	561	532	510			

- Note: 1. Multiply the value given above by the multiple strand factor (page A-22, Table II) in order to obtain the transmission horsepower of multiple strand chain.
 2. For lubrication systems A, B & C, refer to page A-77 for explanation. Please consult U.S. Tsubaki for use of horsepower ratings to the right of the boundary line.
 3. Refer to page A-22, "Procedures for Selecting Roller Chain."

Heavy Series

Heavy Series roller chains differ from the ASME/ANSI standard series in the extra thickness of the link plates and the extra length of the pins. These link plates have the same thickness as the link plates of ASME/ANSI chains having the next larger pitch. The thicker link plates provide greater capacity (approximately 10%) for absorbing shock loads. These chains are suitable in situations where the load is heavy or operating conditions are severe.

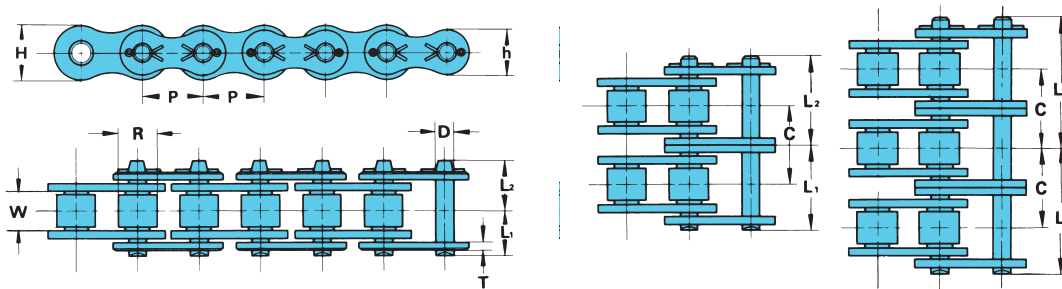

U.S. TSUBAKI Chain No.	Pitch P	Roller Dia. R	Width Between Roller Link Plates W	Link Plate				Pin		Transverse Pitch C	Average Tensile Strength lbs.	‡Maximum Allowable Load lbs.	Approx. Weight lbs./ft.
				T	H	h	D	L ₁	L ₂				
SINGLE STRAND													
RS60H	.75	.469	.500	.125	.713	.614	.234	.583	.669	—	9,920	2,200	1.21
RS80H	1.00	.625	.625	.156	.949	.819	.312	.720	.823	—	17,640	3,630	2.08
RS100H	1.25	.750	.750	.187	1.185	1.024	.375	.858	.965	—	26,460	5,510	3.07
RS120H	1.50	.875	1.000	.219	1.425	1.228	.437	1.061	1.203	—	37,480	7,270	4.38
RS140H	1.75	1.000	1.000	.250	1.661	1.433	.500	1.138	1.303	—	48,510	9,590	5.54
RS160H	2.00	1.125	1.250	.281	1.898	1.638	.562	1.337	1.514	—	60,630	12,500	7.35
RS200H	2.50	1.562	1.500	.375	2.374	2.047	.781	1.689	1.894	—	103,630	17,600	12.33
RS240H	3.00	1.875	1.875	.500	2.850	2.457	.937	2.157	2.453	—	152,140	25,300	19.54
DOUBLE STRAND													
RS60H-2	.75	.469	.500	.125	.713	.614	.234	1.083	1.181	1.028	19,840	3,700	2.41
RS80H-2	1.00	.625	.625	.156	.949	.819	.312	1.358	1.492	1.283	35,280	6,100	4.15
RS100H-2	1.25	.750	.750	.187	1.185	1.024	.375	1.630	1.736	1.539	52,920	9,300	6.07
RS120H-2	1.50	.875	1.000	.219	1.425	1.228	.437	2.014	2.171	1.924	71,880	12,300	8.67
RS140H-2	1.75	1.000	1.000	.250	1.661	1.433	.500	2.163	2.343	2.055	94,370	16,300	11.01
RS160H-2	2.00	1.125	1.250	.281	1.898	1.638	.562	2.555	2.736	2.437	121,260	21,200	14.64
RS200H-2	2.50	1.562	1.500	.375	2.374	2.047	.781	3.230	3.437	3.083	207,260	29,900	24.51
RS240H-2	3.00	1.875	1.875	.500	2.850	2.457	.937	4.146	4.461	3.985	304,280	43,000	38.47
TRIPLE STRAND													
RS60H-3	.75	.469	.500	.125	.713	.614	.234	1.614	1.720	1.028	29,760	5,500	3.60
RS80H-3	1.00	.625	.625	.156	.949	.819	.312	1.998	2.120	1.283	52,920	9,000	6.21
RS100H-3	1.25	.750	.750	.187	1.185	1.024	.375	2.400	2.510	1.539	79,380	13,700	9.10
RS120H-3	1.50	.875	1.000	.219	1.425	1.228	.437	2.984	3.134	1.924	107,820	18,100	12.99
RS140H-3	1.75	1.000	1.000	.250	1.661	1.433	.500	3.191	3.370	2.055	141,550	23,900	16.48
RS160H-3	2.00	1.125	1.250	.281	1.898	1.638	.562	3.756	3.961	2.437	181,890	31,200	21.93
RS200H-3	2.50	1.562	1.500	.375	2.374	2.047	.781	4.760	4.969	3.083	310,890	44,000	36.81
RS240H-3	3.00	1.875	1.875	.500	2.850	2.457	.937	6.104	6.423	3.985	456,420	63,200	57.33

Note: 1. Riveted or cottered types are available.

* 2. Refer to page A-23, "Selection for Slow Speed."

U.S. TSUBAKI RS ROLLER CHAIN

RS Double Pitch Roller Chains

RS DOUBLE PITCH ROLLER CHAINS



An economical choice in drive applications where the speed is low, the load moderate, or the center distance relatively long.

U.S. Tsubaki Double Pitch Drive Chains are also available in stainless steel, nickel-plated, and NEPTUNE®.

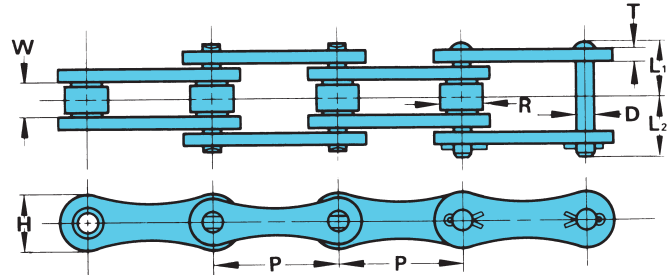

U.S. TSUBAKI Chain No.	Pitch P	Roller Dia. R	Width Between Roller Link Plates W	Pin			Link Plate		Average Tensile Strength lbs.	Approx. Weight lbs./ft.	No. of Links per 10 ft.
				D	L ₁	L ₂	T	H			
A2040	1.000	.312	.312	.156	.325	.380	.060	.472	3,700	.26	120
A2050	1.250	.400	.375	.200	.406	.469	.080	.591	6,100	.42	96
A2060	1.500	.469	.500	.234	.506	.600	.094	.709	8,500	.63	80
A2080	2.000	.625	.625	.312	.640	.754	.125	.906	14,500	1.03	60

Note: Spring clip type connecting links will be provided for A2040 ~ A2060, unless otherwise specified.

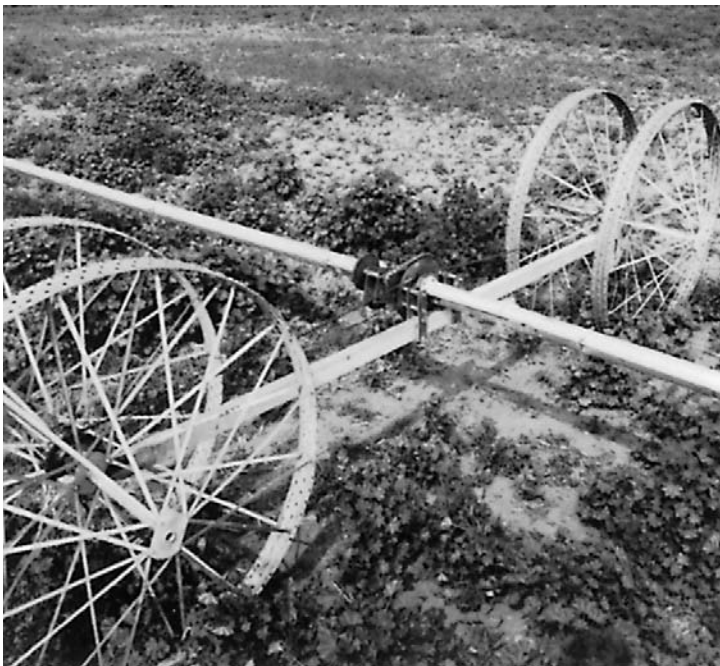

Sprockets for RS Double Pitch Roller Chain

There are special sprockets for RS Double Pitch roller chains. However, ASME/ANSI standard sprockets are also available for use, if the roller is a standard roller and the number of sprocket teeth is 30 or over. Please contact U.S. Tsubaki for details of special sprockets.

CHAIN DRIVE SELECTION

Horsepower Rating

The horsepower rating in Table IV on page A-24 is based on the following conditions:

- 1) The chains are operated under ordinary conditions. The ambient temperature range must be between 15°F and 140°F. They should not be used in an atmosphere in which abrasive dust or corrosive gas is present or where the humidity is high.
- 2) The two transmission shafts are in a horizontal position, and the chains are properly installed.
- 3) The suggested lubrication system and oil are used.
- 4) The load does not change significantly during transmission. The "Service Factor" given in Table I should be taken into account when the chains are used under various operating conditions. The load conditions will affect the life of the chain.
- 5) The increase in the horsepower rating of multiple strand roller chain cannot be calculated simply by multiplying the horsepower rating of one strand by the number of strands, since the load on each strand is not exactly the same. In order to estimate the service life of a multiple strand chain, the "Multiple Strand Factor" given in Table II must be used. When the chain length is 100 pitches and the above conditions are met, a service life of approximately 15,000 hours can be expected.

Procedures for Selecting Roller Chain

- 1) The following factors must be considered when selecting roller chain.
 - a. Source of power
 - b. Driven machine
 - c. Horsepower to be transmitted
 - d. RPM of driving and driven shafts
 - e. Diameter of driving and driven shafts
 - f. Center distance of the shafts

- 2) Use Table I to obtain the "Service Factor."
- 3) Multiply the horsepower value by the service factor to obtain the design horsepower value.
- 4) Use Table IV on page A-24 and the horsepower ratings tables on pages A-6 to A-19 to obtain the appropriate chain number and the number of teeth for small sprockets. Refer to the number of revolutions of the high speed shaft (the driving shaft when the speed is reduced; the driven shaft when the speed is increased) and the design horsepower value. For smoother chain drive, a smaller pitch chain is suggested. If a single strand chain does not satisfy the transmission requirements, use a multiple strand chain. If there are space limitations, a multiple strand roller chain with a smaller pitch may be used.
- 5) After determining the number of teeth necessary for the small sprocket, refer to the Sprocket Dimension Table (pages A-79 to A-82) to check if the sprocket diameter satisfies the space limitations.
- 6) The number of teeth for the large sprocket is determined by multiplying the number of teeth for the small sprocket by the speed ratio. More than 15 teeth on the small sprocket is suggested. The number of teeth for the large sprocket should be less than 120. By reducing the number of teeth for the small sprocket, the number of teeth for the large sprocket can be reduced.
- 7) For temperatures below 15°F, see the Environmental Temperatures and Points of Concern Table on page B-38.

Basic Formula for Chain Drive

- 1) Chain speed: S

$$S = \frac{P \cdot N \cdot n}{12} \text{ (ft./min.)}$$

P : Chain pitch (inch)
 N : Number of teeth of sprocket
 n : Revolution per minute (rpm)

- 2) Chain tension: T

$$T = \frac{33,000 \cdot \text{HP}}{S} \text{ (lbs.)}$$

S : Chain Speed (ft./min.)
 HP: Horsepower to be transmitted (hp)

- 3) Number of pitches of chain: L

$$*L = \frac{N_1 + N_2}{2} + 2C + \frac{(N_2 - N_1)^2}{4C}$$

N₁ : Number of teeth (small sprocket)
 N₂ : Number of teeth (large sprocket)
 C : Center distance in pitches

* Any fraction of L is counted as one pitch.

- 4) Center distance in pitches: C

$$C = \frac{1}{8} \left\{ 2L - N_1 - N_2 + \sqrt{(2L - N_1 - N_2)^2 - \frac{8}{9.86}(N_2 - N_1)^2} \right\}$$

Table II: Multiple Strand Factor

Number of Roller Chain Strands	Multiple Strand Factor
2	1.7
3	2.5
4	3.3
5	3.9
6	4.6

Table I: Service Factor

Type of Impact	Machines	Source of Power		
		Electric Motor or Turbine	Internal Combustion Engine	
			With hydraulic drive	Without hydraulic drive
Smooth	Belt conveyors with small load fluctuation, chain conveyors, centrifugal blowers, general textile machines, machines with small load fluctuation	1.0	1.0	1.2
Some impact	Centrifugal compressors, marine engines, conveyors with some load fluctuation, automatic furnaces, dryers, pulverizers, general machine tools, compressors, general work machines, general paper mills	1.3	1.2	1.4
Large impact	Press, construction or mining machines, vibration machines, oil well rigs, rubber mixers, rolls, general machines with reverse or large impact loads	1.5	1.4	1.7

U.S. TSUBAKI RS ROLLER CHAIN

Example

Step 1 Data Required

- Type of application:
Centrifugal Blower
- Shock Load:
Small load fluctuation
- Source of Power: Motor
- HP to be transmitted: 40 hp
- Drive shaft:
Diameter 2 inches, 750 rpm
Driven shaft:
Diameter 3 inches, 250 rpm
- Center distance:
Less than 9 inches
- Space limitation:
Less than 20 inches

Step 2 Use Table I to determine the service factor.

Service Factor SF = 1.0

Step 3 Obtain Design HP

Design HP = (HP to be transmitted) • SF
= 40 hp • 1.0
= 40 hp

Step 4 Obtain the chain number and the number of teeth on the small sprocket from the Roller Chain Selection Table (page A-24) referring to the above 40 hp and 750 rpm.

Then check it by referring to the Horsepower Rating Tables (pages A-6 to A-19).

- According to the horsepower rating, the best choice would normally be a single strand of RS80-17 teeth. Since the speed ratio is 1/3 (250/750 rpm), the necessary number of sprocket teeth would be 17 for the small sprocket and 51 for the large sprocket. But, as the outside diameters are 5.94 inches for 17 teeth and 16.81 inches for 51 teeth (refer to sprocket dimensions on pages A-79 to A-82), it exceeds the space limitation of 20 inches (5.94 + 16.81 > 20 inches).

Therefore, these sprockets are not suitable.

- As a single strand chain is not suitable, a multiple-strand RS60-2, 22 and 66 teeth would be possible. But this combination is not suitable due to the space limitation again (5.67 + 16.18 > 20 inches).
- For triple strand, RS60-3, 15 and 45 teeth would be possible.

The sprockets' diameters are 3.90 inches and 11.18 inches respectively, the sum of which is less than 20

inches. The horsepower rating of a 15-tooth sprocket for the RS60-3 should be confirmed by the horsepower rating for the RS60 (see page A-11).

The horsepower rating of a 15 tooth sprocket is 15.1 hp at 700 rpm and 17 hp at 800 rpm. So the horsepower rating at 750 rpm is about 16 hp. Since 16 hp is for a single strand chain, the horsepower rating must be multiplied by a multiple strand factor of 2.5 for a triple strand (see page A-22).

Therefore, the horsepower rating of RS60-3, 15 teeth at 750 rpm is 40 hp (16 • 2.5 = 40).

Step 5 Refer to Sprocket Section (C) in this catalog to check the diameter of the bore.

A 45-tooth sprocket meets the necessary requirement, but since the maximum bore diameter (1.87 inches) of a 15-tooth sprocket is smaller than the drive shaft diameter of 2 inches, it can't be used.

A 16-tooth sprocket with a maximum bore diameter of 2 inches must be used. Check again that the outside diameter, 4.21 inches for 16 teeth and 11.89 inches for 48 teeth, is less than the space limitation (4.21 + 11.89 < 20).

A combination of RS60-3, 16 and 48 teeth must be used to fulfill all the necessary requirements.

Selection for Slow Speed

When the chain speed (S) is less than 160 ft./min., select the RS roller chain that is one size smaller than the chain chosen from the horsepower rating method mentioned above.

- Tentatively select the chain and sprocket from Table IV (page A-24) and proceed by using a one-size-smaller chain and its sprocket with the number of teeth close to the sprocket selected above. Be sure to confirm that the sprocket meets the application requirements such as bore diameter and space limitation, etc.
- Calculate the chain speed from the number of teeth on the driving sprocket using equation (A). Also check that the speed is less than 160 ft./min.
- Calculate the chain tension for the above drive from equation (B).
- Select the service factor and the chain speed coefficient from Table I (page A-22) and Table III.

- Verify that the chain has maximum allowable load which satisfies equation (C).

$$S = \frac{P \cdot N \cdot n}{12} \text{ (ft./min.)} \dots\dots\dots (A)$$

$$T = \frac{33,000 \cdot \text{HP}}{S} \text{ (lbs.)} \dots\dots\dots (B)$$

T • Service Factor • Chain Speed Coefficient ≤ Maximum Allowable Load(C)

- S: chain speed (ft./min.)
P: chain pitch (inch)
N: number of sprocket teeth
n: revolutions per minute (rpm)
T: chain tension (lbs.)
HP: horsepower to be transmitted (hp)

There are two different ways to do the next step: to increase the number of teeth, or to use the same procedure for Super Chains of the same size (refer to Super Chains on pages A-35 to A-42).

Note: Please use press fit connecting links for slow speed chain selection.

Table III: Chain Speed Coefficient

Chain Speed	Speed Coefficient
Less than 50 ft./min.	1.0
50 to 100 ft./min.	1.2
100 to 160 ft./min.	1.4

Selection for High Temperatures

U.S. Tsubaki Improved Drive Chains are made of heat treated carbon steel. When exposed to high temperatures, the mechanical properties of the heat treated chain components are lost.

- The hardness, and therefore the wear resistance of pins and bushings, is reduced.
- At temperatures above 390°F, the rollers and plates lose their hardness and strength.

Standard roller chains can be used in temperatures up to 500°F with the following adjustments:

Temperature	Percentage of Catalog Capacity Rating
Up to 340°F	100%
390°F	75%
500°F	50%

For temperatures below 15°F, see the Environmental Temperatures and Points of Concern Table on page B-38.

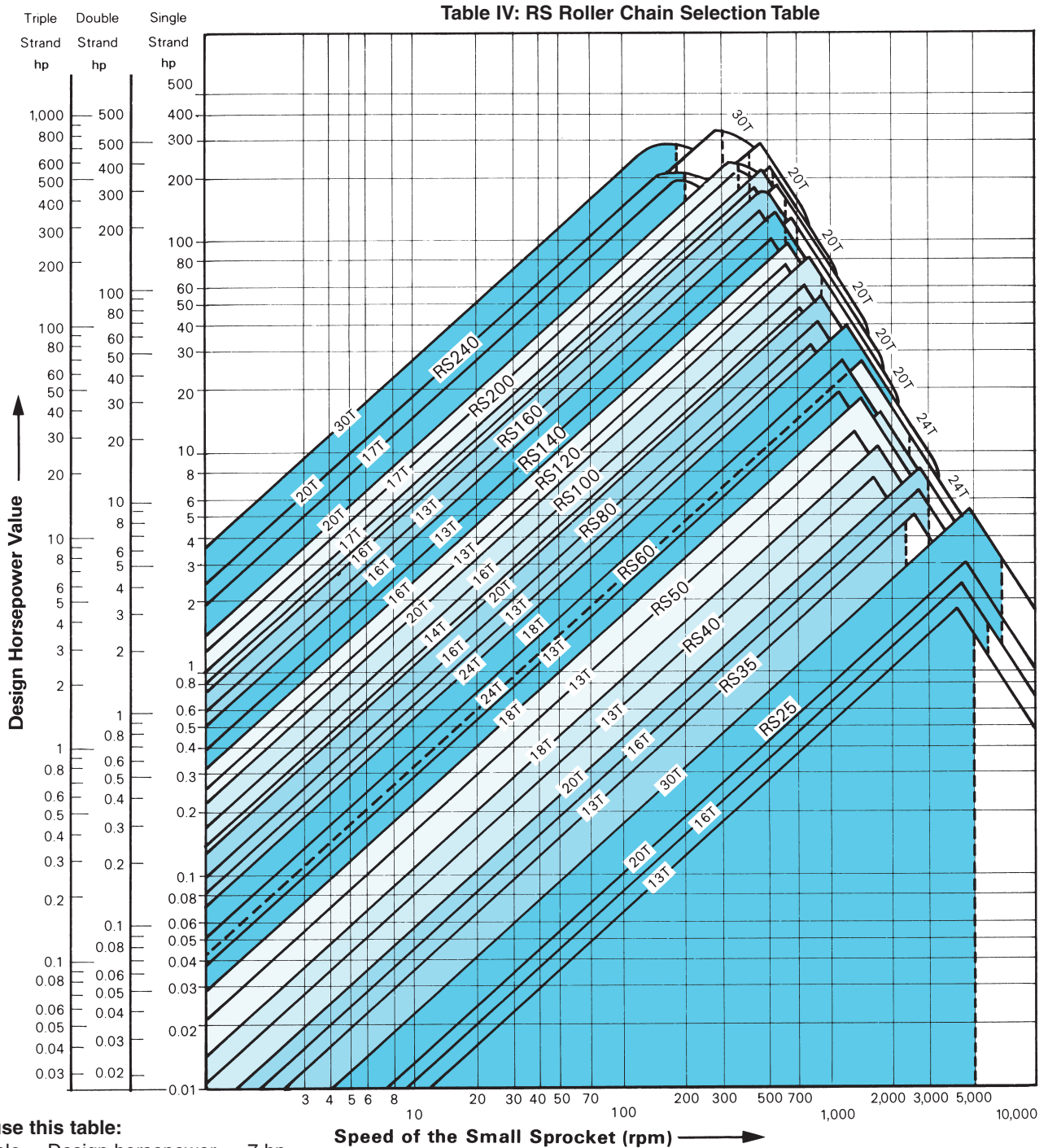

How to use this table:

1. Example ... Design horsepower — 7 hp
 - a) Assume that the RPM of the small sprocket is 100. Judging from the intersection point of the design horsepower's value of 7 hp and the RPM value of 100, RS80 and a sprocket with either 17 teeth or 18 teeth can be selected. Sprockets with 17 teeth are more economical than those with 18 teeth.
 - b) Assume that the RPM of the small sprocket is 300. An RS60, 15-tooth sprocket is appropriate from the intersection point in the same manner as above. The line for RS50-24 teeth can also be seen near the intersection of 7 hp and 300 rpm. Therefore, either RS60-15 teeth or RS50-24 teeth can be selected. This table is used to make a tentative selection. The Horsepower Rating Tables should be used to determine the most appropriate chain and sprocket.
2. Horsepower lines of 20, 24 and 30-tooth sprockets are shown only in the high speed range on the right hand side of the above chart. When checking the horsepower line of these sprockets, make a line parallel to the other lines on the left hand side of the dotted line for RS50-24 teeth.
3. When using a chain in the white part on the right side of the table, please consult with U.S. Tsubaki.
4. When the chain speed is less than 160 ft./min., it is more economical to select your RS roller chain by the selection method for slow speed drives (see page A-23).

Lambda Chain

Lube-free Drive Chain

- Maintenance-free
- Even longer wear life
- Increased operating temperatures

UNIQUE PATENTED DESIGN

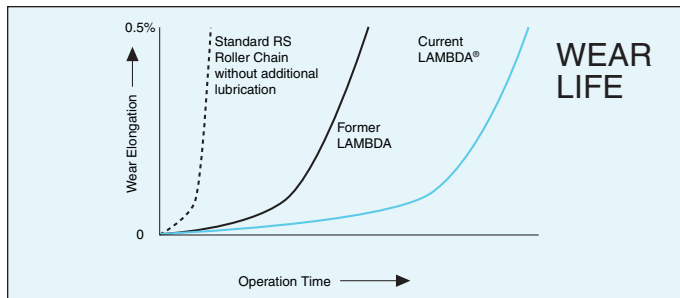

LAMBDA Chain outlasts standard chain without post-lubrication. It outlasts our former LAMBDA Chain up to twice as long in normal temperature range (+14°F ~ +140°F).

LAMBDA Drive Chain means real savings for your operation

- Reduce maintenance costs
- Eliminate product contamination
- Reduce downtime
- Increase sprocket life

Better than ever for lube-free applications

When your operation runs “clean,” when machines and conveyed materials must be free from contact with oil, or when lubrication is difficult, LAMBDA Chain is the right choice.

- Outlasts our former LAMBDA Chain without additional lubrication.
- Outstanding performance in temperatures up to 302°F.
- Available in single and double strand — from RSD40 to RSD140.
- Factory pre-loaded to minimize initial stretch.

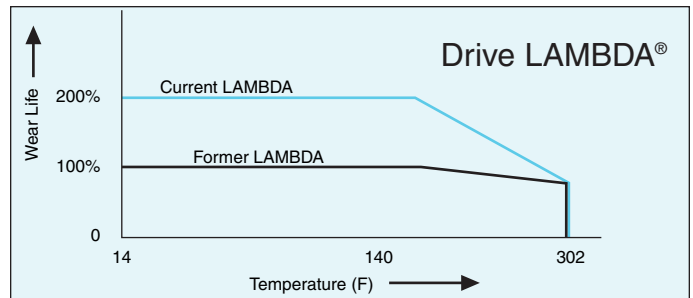

LAMBDA Drive Chain is ideal for clean applications, where machines and conveyed materials must be free from contact with oil, or when lubrication is difficult. If product contamination is a concern, if lubrication is difficult, or if you simply want to reduce maintenance costs, choose LAMBDA Chain from U.S. Tsubaki.

Select the LAMBDA Chain that's right for your operation

Standard LAMBDA Drive Chain works in temperatures up to 302°F, with a wide range of sizes and types for special applications.

Start Saving Immediately

Maximize the efficiency of your existing system without costly design or reconfiguration changes. LAMBDA Chain is directly interchangeable with most standard ASME/ANSI chain and will articulate smoothly with sprockets. And LAMBDA Chain is in stock and ready when you need it, so your line is up and running right away.

Next Generation LAMBDA® Chain for Special Applications

In addition to our standard sizes and types of LAMBDA Chain, we offer Next Generation LAMBDA Chain for special applications:

LAMBDA Chain with NEPTUNE® Coating

Corrosion-resistant lube-free chain with the strength of carbon steel. You get:

- Excellent corrosion resistance to extend wear life in applications that require water washdowns or exposure to moisture (not suitable for applications that require contact with food)
- Protection that won't flake or peel off, keeping your line free from the exposure that causes product damage and premature chain wear
- Strong, dependable chain free from steel-weakening hydrogen embrittlement to give you longer service life

BS/DIN LAMBDA Chain

Lube-free chain that operates on ISO standard sprockets. Some dimensions vary slightly from ISO standards.

- Replaces BS/DIN chain for cost-effective lube-free operations
- Extra temperature resistance up to 302°F

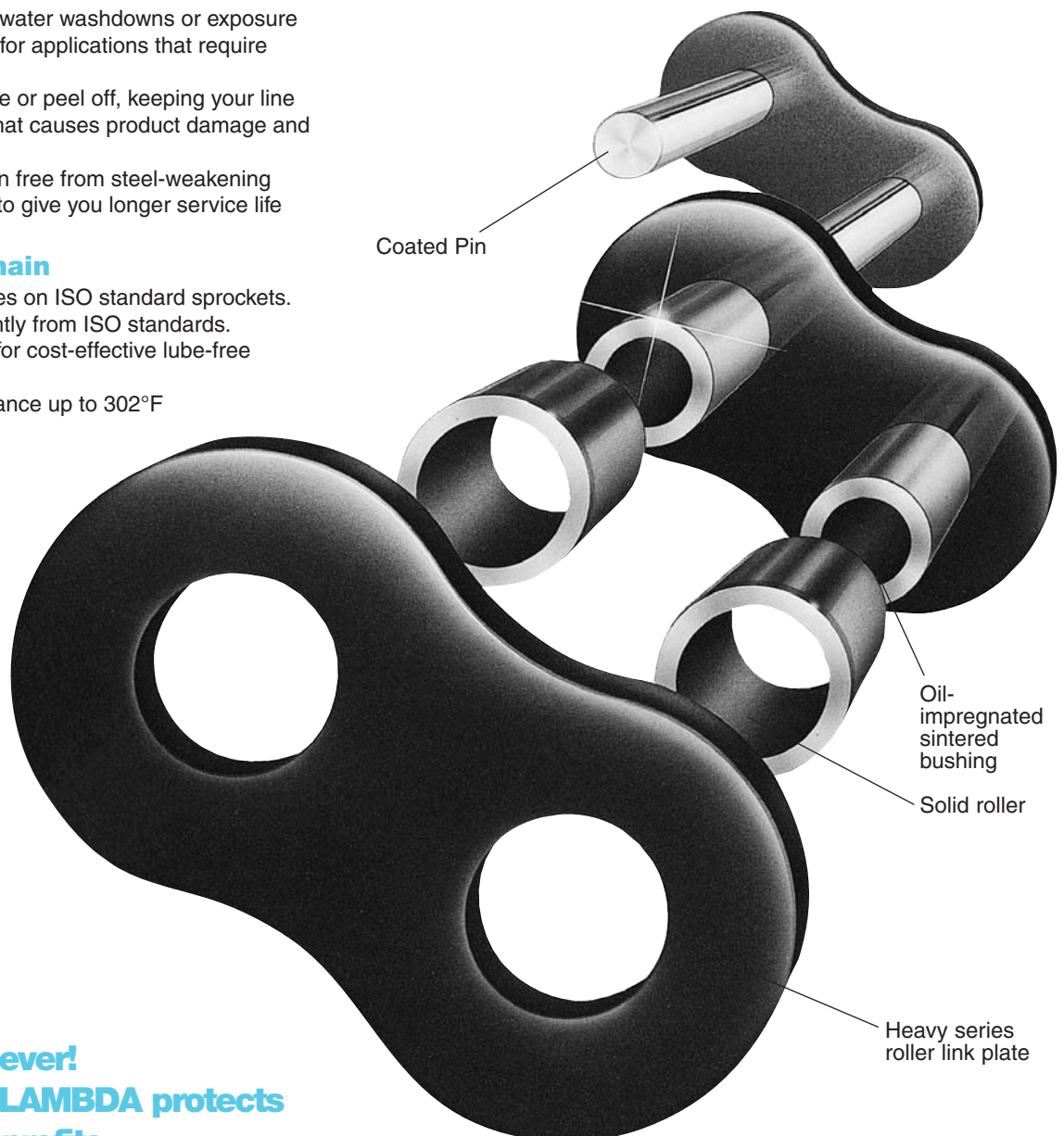

Now better than ever!
Next Generation LAMBDA protects applications and profits

U.S. TSUBAKI LAMBDA® CHAINS



LAMBDA for lube-free drive applications

- Operates in temperatures up to 302°F
- Same maximum allowable load as our standard RS chain
- Available in sizes from RSD40 to RSD140

Single Strand Drive LAMBDA®

U.S. TSUBAKI Chain No.	Standard Type of Pin*	Pitch P	Roller Dia. R	Width Between Roller Link Plates W**	Link Plates				Pin				Average Tensile Strength lbs.	Maximum Allowable Load lbs.	Approx. Weight lbs./ft.
					PLP Thickness T ₁	RLP Thickness T ₂	RLP Height H	PLP Height h	D	L ₁	L ₂	L			
RSD40-LAMBDA	R	.500	.312	.297	.060	.080	.472	.409	.156	.344	.411	.787	4,300	816	0.47
RSD50-LAMBDA	R	.625	.400	.365	.080	.094	.591	.512	.200	.423	.490	.945	7,050	1,430	0.75
RSD60-LAMBDA	R	.750	.469	.483	.094	.125	.713	.614	.234	.541	.616	1.260	9,920	1,980	1.16
RSD80-LAMBDA	R	1.000	.625	.609	.125	.156	.949	.819	.312	.675	.797	1.571	17,600	3,310	1.86
RSD100-LAMBDA	C/R	1.250	.750	.736	.156	.187	1.185	1.024	.375	.813	.939	1.870	26,500	5,070	2.89
RSD120-LAMBDA	C/R	1.500	.875	.974	.187	.220	1.425	1.228	.437	1.014	1.179	2.323	37,500	6,830	4.30
RSD140-LAMBDA	C/R	1.750	1.000	.974	.220	.252	1.661	1.433	.500	1.091	1.268	2.508	48,500	9,040	5.40

Double Strand Drive LAMBDA®

U.S. TSUBAKI Chain No.	Standard Type of Pin*	Pitch P	Roller Dia. R	Width Between Roller Link Plates W**	Link Plates				Pin				Average Tensile Strength lbs.	Maximum Allowable Load lbs.	Approx. Weight lbs./ft.
					PLP Thickness T ₁	RLP Thickness T ₂	RLP Height H	PLP Height h	D	L ₁	L ₂	C			
RSD40(H)-2LAMBDA	R	.500	.312	.297	.080	.080	.472	.409	.156	.689	.754	.646	8,600	1,390	1.00
RSD50(H)-2LAMBDA	R	.625	.400	.365	.094	.094	.591	.512	.200	.825	.892	.776	14,100	2,430	1.64
RSD60(H)-2LAMBDA	R	.750	.469	.483	.125	.125	.713	.614	.234	1.083	1.181	1.028	19,840	3,370	2.41
RSD80(H)-2LAMBDA	R	1.000	.625	.609	.156	.156	.949	.819	.312	1.358	1.492	1.283	35,200	5,630	4.15
RSD100(H)-2LAMBDA	C	1.250	.750	.736	.187	.187	1.185	1.024	.375	1.630	1.736	1.539	53,000	8,620	6.07
RSD120(H)-2LAMBDA	C	1.500	.875	.974	.220	.220	1.425	1.228	.437	2.014	2.171	1.924	75,000	11,600	8.67
RSD140(H)-2LAMBDA	C	1.750	1.000	.974	.252	.252	1.661	1.433	.500	2.163	2.343	2.055	97,000	15,400	11.01

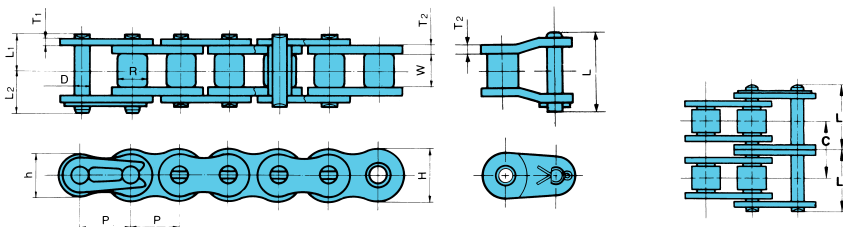

* R indicates riveted, C indicates cottered, C/R indicates available with cottered or riveted pins.

** Width between roller link plates (W) is slightly narrower than ANSI standard, however this chain runs on standard sprockets.

Note:

1. Drive and Conveyor series LAMBDA chains cannot be intercoupled or interchanged.
2. The heavy roller link plates slightly increase the width, which means Drive LAMBDA connecting links are required.
3. Connecting links for RSD80-LAMBDA to RSD140-LAMBDA and RSD80(H)-2LAMBDA to RSD140(H)-2LAMBDA have cottered pins.
4. Double Strand Drive LAMBDA requires heavy-series sprockets.

LAMBDA for corrosion resistance

- Operates in temperatures up to 302°F
- Ideal for mildly corrosive environments
- Long-lasting and lube-free

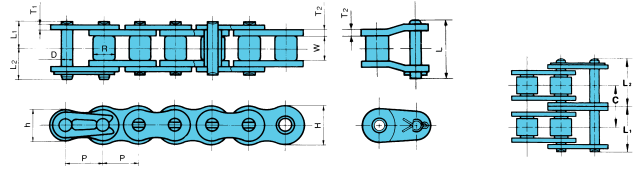

Nickel-Plated Single Strand Drive LAMBDA®

U.S. TSUBAKI	Standard Type of Pin*	Pitch	Roller Dia.	Width Between Roller Link Plates	Link Plates				Pin				Average Tensile Strength lbs.	Maximum Allowable Load lbs.	Approx. Weight lbs./ft.
					PLP Thickness	RLP Thickness	RLP Height	PLP Height	D	L ₁	L ₂	L			
Chain No.	P	R	W**	T ₁	T ₂	H	h	D	L ₁	L ₂	L				
RSD40NP-LAMBDA	R	.500	.312	.297	.060	.080	.472	.409	.156	.344	.411	.787	4,300	683	0.47
RSD50NP-LAMBDA	R	.625	.400	.365	.080	.094	.591	.512	.200	.423	.490	.945	7,050	1,210	0.75
RSD60NP-LAMBDA	R	.750	.469	.483	.094	.125	.713	.614	.234	.541	.616	1.260	9,920	1,630	1.16
RSD80NP-LAMBDA	R	1.000	.625	.609	.125	.156	.949	.819	.312	.675	.797	1.571	17,600	2,870	1.86
RSD100NP-LAMBDA	C	1.250	.750	.736	.156	.187	1.185	1.024	.375	.813	.939	1.870	26,500	4,300	2.89
RSD120NP-LAMBDA	C	1.500	.875	.974	.187	.220	1.425	1.228	.437	1.014	1.179	2.323	37,500	5,730	4.30
RSD140NP-LAMBDA	C	1.750	1.000	.974	.220	.252	1.661	1.433	.500	1.091	1.268	2.508	48,500	7,720	5.40

Nickel-Plated Double Strand Drive LAMBDA®

U.S. TSUBAKI	Standard Type of Pin*	Pitch	Roller Dia.	Width Between Roller Link Plates	Link Plates				Pin			Average Tensile Strength lbs.	Maximum Allowable Load lbs.	Approx. Weight lbs./ft.	
					PLP Thickness	RLP Thickness	RLP Height	PLP Height	D	L ₁	L ₂				C
Chain No.	P	R	W**	T ₁	T ₂	H	h	D	L ₁	L ₂	C				
RSD40(H)NP-2LAMBDA	R	.500	.312	.297	.080	.080	.472	.409	.156	.689	.754	.646	8,600	1,160	1.00
RSD50(H)NP-2LAMBDA	R	.625	.400	.365	.094	.094	.591	.512	.200	.825	.892	.776	14,100	2,060	1.64
RSD60(H)NP-2LAMBDA	R	.750	.469	.483	.125	.125	.713	.614	.234	1.083	1.181	1.028	19,840	2,770	2.41
RSD80(H)NP-2LAMBDA	R	1.000	.625	.609	.156	.156	.949	.819	.312	1.358	1.492	1.283	35,200	4,880	4.15
RSD100(H)NP-2LAMBDA	C	1.250	.750	.736	.187	.187	1.185	1.024	.375	1.630	1.736	1.539	53,000	7,310	6.07
RSD120(H)NP-2LAMBDA	C	1.500	.875	.974	.220	.220	1.425	1.228	.437	2.014	2.171	1.924	75,000	9,740	8.67
RSD140(H)NP-2LAMBDA	C	1.750	1.000	.974	.252	.252	1.661	1.433	.500	2.163	2.343	2.055	97,000	13,100	11.01

LAMBDA for international standards

- Operates in temperatures up to 302°F
- Replaces BS/DIN chain
- Cost effective, lube-free operation

* R indicates riveted, C indicates cottered.
 ** Width between roller link plates (W) is slightly narrower than ANSI standard, however this chain runs on standard sprockets.

- Note:
1. Drive and Conveyor series LAMBDA chains cannot be intercoupled or interchanged.
 2. The heavy roller link plates slightly increase the width, which means Drive LAMBDA connecting links are required.
 3. Connecting links for RSD80NP-LAMBDA to RSD140NP-LAMBDA and RSD80(H)NP-2LAMBDA to RSD140(H)NP-2LAMBDA have cottered pins.
 4. Double Strand Drive LAMBDA requires heavy-series sprockets.

BS/DIN Drive LAMBDA®

U.S. TSUBAKI	Pitch	Roller Dia.	Width Between Roller Link Plates	Link Plates				Pin				Average Tensile Strength lbs.	Approx. Weight lbs./ft.
				PLP Thickness	RLP Thickness	RLP Height	PLP Height	D	L ₁	L ₂	L		
Chain No.	P	R	W**	T ₁	T ₂	H	h	D	L ₁	L ₂	L		
RSD08B-LAMBDA	.500	.335	.305	.060	.080	.472	.409	.175	.346	.411	.787	4,230	0.47
RSD10B-LAMBDA	.625	.400	.380	.080	.080	.591	.512	.200	.406	.472	.886	6,080	0.70
RSD12B-LAMBDA	.750	.475	.460	.094	.094	.713	.614	.225	.486	.565	1.138	9,060	1.01

- Note:
1. Although some dimensions differ from British Standard (BS/DIN), the primary dimensions are identical, enabling BS-compatible LAMBDA to engage perfectly with British Standard sprockets.
 2. The heavy roller link plates slightly increase the width, which means drive LAMBDA connecting links are required.

Horsepower Ratings

The horsepower ratings shown in these charts are based on the following conditions.

1. The chains are operated under ordinary conditions. The ambient temperatures during typical operating conditions range between 14°F and 302°F. They should not be used in an atmosphere in which abrasive dust or corrosive gas is present or where humidity is high.
2. The two transmission shafts are horizontal and the chains are properly installed.
3. The load does not change significantly during transmission. The Service Factors given in Table I on page A-22 should be taken into account when the chains are used under various operating conditions.

RSD50-LAMBDA®

No. of Teeth	HORSEPOWER RATINGS									
Small Spkt.	Maximum Speed - Small Sprocket (rpm)									
	10	25	50	100	200	300	400	500	700	900
11	0.16	0.38	0.71	1.33	2.48	3.58	4.64	5.66	6.67	7.67
12	0.19	0.42	0.78	1.46	2.72	3.93	5.09	6.22	7.33	8.42
13	0.20	0.46	0.86	1.59	2.98	4.28	5.55	6.78	7.99	
14	0.21	0.50	0.92	1.73	3.22	4.64	6.00	7.34	8.66	
15	0.23	0.54	0.99	1.86	3.47	5.00	6.47	7.92		
16	0.25	0.58	1.07	2.00	3.73	5.36	6.94	8.48		
17	0.27	0.62	1.14	2.13	3.97	5.72	7.41	9.06		
18	0.28	0.66	1.22	2.27	4.22	6.08	7.88			
19	0.31	0.68	1.29	2.40	4.48	6.45	8.36			
20	0.32	0.72	1.35	2.53	4.73	6.82	8.83			
21	0.34	0.76	1.43	2.68	4.99	7.18	9.32			
22	0.35	0.80	1.50	2.81	5.24	7.56				
23	0.38	0.84	1.58	2.95	5.51	7.93				
24	0.39	0.88	1.66	3.08	5.76	8.30				
25	0.40	0.92	1.73	3.23	6.02	8.67				
26	0.43	0.97	1.81	3.36	6.29	9.05				
28	0.46	1.05	1.96	3.65	6.81	9.81				
30	0.50	1.13	2.10	3.93	7.33					
32	0.54	1.21	2.27	4.21	7.87					
35	0.59	1.33	2.49	4.64	8.66					
40	0.67	1.54	2.87	5.36	10.0					
45	0.76	1.74	3.27	6.08						

RSD40-LAMBDA®

No. of Teeth	HORSEPOWER RATINGS										
Small Spkt.	Maximum Speed - Small Sprocket (rpm)										
	10	25	50	100	200	300	400	500	700	900	1000
11	0.08	0.19	0.35	0.64	1.21	1.73	2.24	2.73	3.70	4.65	5.11
12	0.09	0.20	0.38	0.71	1.31	1.90	2.47	3.00	4.07	5.11	
13	0.09	0.23	0.42	0.76	1.43	2.06	2.68	3.28	4.44	5.56	
14	0.11	0.24	0.44	0.83	1.55	2.24	2.91	3.55	4.81		
15	0.11	0.25	0.48	0.90	1.68	2.41	3.14	3.83	5.19		
16	0.12	0.28	0.52	0.97	1.80	2.59	3.35	4.10	5.55		
17	0.13	0.29	0.55	1.03	1.92	2.76	3.58	4.38			
18	0.13	0.31	0.59	1.10	2.04	2.95	3.81	4.66			
19	0.15	0.34	0.62	1.17	2.17	3.12	4.05	4.95			
20	0.16	0.35	0.66	1.23	2.29	3.30	4.28	5.23			
21	0.16	0.38	0.70	1.29	2.41	3.47	4.50	5.51			
22	0.17	0.39	0.72	1.35	2.53	3.66	4.73	5.79			
23	0.17	0.42	0.76	1.42	2.67	3.83	4.97	6.07			
24	0.19	0.43	0.80	1.49	2.79	4.02	5.20				
25	0.20	0.44	0.83	1.55	2.91	4.20	5.44				
26	0.20	0.47	0.87	1.62	3.04	4.38	5.67				
28	0.23	0.51	0.95	1.77	3.30	4.74	6.14				
30	0.24	0.55	1.02	1.90	3.55	5.11					
32	0.25	0.59	1.09	2.04	3.81	5.48					
35	0.28	0.64	1.21	2.24	4.20	6.03					
40	0.32	0.75	1.39	2.59	4.84						
45	0.38	0.84	1.58	2.95	5.50						

RSD60-LAMBDA®

No. of Teeth	HORSEPOWER RATINGS									
Small Spkt.	Maximum Speed - Small Sprocket (rpm)									
	10	25	50	100	150	200	250	300	400	500
11	0.29	0.67	1.26	2.35	3.39	4.38	5.36	6.31	8.19	10.0
12	0.32	0.74	1.38	2.59	3.71	4.81	5.88	6.94	8.99	11.0
13	0.35	0.80	1.51	2.81	4.06	5.25	6.42	7.57	9.80	
14	0.39	0.87	1.64	3.06	4.40	5.70	6.96	8.20	10.6	
15	0.42	0.94	1.76	3.28	4.73	6.13	7.49	8.83	11.4	
16	0.44	1.01	1.89	3.52	5.08	6.57	8.04	9.46		
17	0.47	1.09	2.01	3.77	5.41	7.02	8.58	10.1		
18	0.51	1.15	2.14	3.99	5.76	7.47	9.13	10.7		
19	0.54	1.22	2.28	4.24	6.11	7.91	9.68	11.4		
20	0.56	1.29	2.40	4.48	6.46	8.36	10.2	12.0		
21	0.59	1.35	2.53	4.73	6.81	8.82	10.8			
22	0.63	1.42	2.67	4.97	7.16	9.27	11.3			
23	0.66	1.50	2.79	5.21	7.51	9.73	11.9			
24	0.68	1.57	2.92	5.46	7.87	10.2	12.5			
25	0.72	1.64	3.06	5.71	8.22	10.6	13.0			
26	0.75	1.72	3.19	5.95	8.58	11.1				
28	0.82	1.85	3.46	6.45	9.29	12.0				
30	0.87	2.00	3.73	6.94	10.0	13.0				
32	0.94	2.14	3.99	7.45	10.7					
35	1.03	2.36	4.40	8.20	11.8					
40	1.19	2.72	5.08	9.48	13.7					
45	1.35	3.10	5.76	10.8						

RSD80-LAMBDA®

No. of Teeth Small Spkt.	HORSEPOWER RATINGS									
	Maximum Speed - Small Sprocket (rpm)									
	10	25	50	75	100	125	150	200	250	300
11	0.66	1.51	2.81	4.06	5.27	6.43	7.57	9.82	12.0	14.2
12	0.72	1.66	3.10	4.46	5.78	7.06	8.32	10.8	13.2	
13	0.79	1.81	3.38	4.87	6.30	7.71	9.07	11.8	14.3	
14	0.86	1.96	3.66	5.27	6.82	8.35	9.84	12.7	15.5	
15	0.92	2.12	3.94	5.68	7.36	8.99	10.6	13.7		
16	0.99	2.27	4.22	6.08	7.88	9.64	11.4	14.7		
17	1.06	2.41	4.52	6.50	8.42	10.3	12.1	15.7		
18	1.13	2.57	4.80	6.92	8.95	11.0	12.9			
19	1.19	2.72	5.09	7.33	9.49	11.6	13.7			
20	1.26	2.88	5.37	7.75	10.0	12.3	14.5			
21	1.33	3.04	5.67	8.16	10.6	12.9	15.3			
22	1.39	3.19	5.96	8.59	11.1	13.5	16.1			
23	1.47	3.35	6.26	9.01	11.7	14.2	16.8			
24	1.54	3.51	6.55	9.44	12.2	14.9				
25	1.61	3.67	6.85	9.85	12.8	15.5				
26	1.68	3.82	7.14	10.3	13.3	16.4				
28	1.82	4.14	7.73	11.1	14.5	17.7				
30	1.96	4.46	8.34	12.0	15.5					
32	2.10	4.78	8.94	12.9	16.6					
35	2.32	5.28	9.84	14.2	18.4					
40	2.67	6.10	11.4	16.4						
45	3.03	6.92	12.9	18.6						

RSD100-LAMBDA®

No. of Teeth Small Spkt.	HORSEPOWER RATINGS									
	Maximum Speed - Small Sprocket (rpm)									
	10	25	50	75	100	125	150	175	200	225
11	1.10	2.52	4.70	6.77	8.77	10.7	12.6	14.5	16.4	18.2
12	1.21	2.76	5.16	7.44	9.64	11.8	13.9	15.9	18.0	
13	1.33	3.02	5.63	8.11	10.5	12.8	15.1	17.4		
14	1.43	3.27	6.10	8.78	11.4	13.9	16.4	18.8		
15	1.54	3.52	6.57	9.46	12.3	15.0	17.7			
16	1.65	3.78	7.05	10.1	13.1	16.1	18.9			
17	1.77	4.03	7.52	10.8	14.1	17.2				
18	1.88	4.29	8.00	11.5	14.9	18.2				
19	2.00	4.54	8.48	12.2	15.8	19.3				
20	2.10	4.80	8.97	12.9	16.8	20.5				
21	2.22	5.07	9.45	13.7	17.7					
22	2.33	5.32	9.93	14.3	18.5					
23	2.45	5.59	10.4	15.0	19.4					
24	2.56	5.84	10.9	15.7	20.4					
25	2.68	6.11	11.4	16.5	21.3					
26	2.80	6.38	11.9	17.2						
28	3.03	6.90	12.9	18.6						
30	3.26	7.44	13.9	20.0						
32	3.50	7.97	14.9	21.4						
35	3.86	8.79	16.4							
40	4.45	10.2	18.9							
45	5.05	11.5	21.6							

RSD120-LAMBDA®

No. of Teeth Small Spkt.	HORSEPOWER RATINGS											
	Maximum Speed - Small Sprocket (rpm)											
	5	10	15	20	25	30	40	50	60	80	100	125
11	1.09	2.02	2.91	3.78	4.61	5.44	7.04	8.60	10.1	13.1	16.1	19.6
12	1.19	2.22	3.20	4.14	5.07	5.98	7.73	9.46	11.1	14.5	17.7	21.6
13	1.30	2.43	3.48	4.52	5.52	6.51	8.43	10.3	12.2	15.7	19.3	23.5
14	1.41	2.63	3.78	4.89	5.99	7.05	9.14	11.2	13.2	17.0	20.9	
15	1.51	2.83	4.07	5.28	6.45	7.60	9.85	12.0	14.2	18.4	22.5	
16	1.62	3.03	4.37	5.66	6.92	8.15	10.6	12.9	15.1	19.7	24.1	
17	1.73	3.23	4.66	6.04	7.39	8.70	11.3	13.8	16.2	21.0		
18	1.85	3.44	4.96	6.42	7.85	9.25	12.0	14.6	17.3	22.3		
19	1.96	3.65	5.25	6.81	8.32	10.2	12.7	15.5	18.4	23.6		
20	2.06	3.86	5.56	7.20	8.81	10.4	13.4	16.5	19.3	25.0		
21	2.18	4.06	5.86	7.59	9.27	10.9	14.2	17.3	20.4			
22	2.29	4.28	6.17	7.97	9.76	11.5	14.9	18.2	21.4			
23	2.40	4.49	6.46	8.38	10.2	12.1	15.7	19.0	23.4			
24	2.52	4.69	6.77	8.77	10.7	12.6	16.4	20.0	24.5			
25	2.63	4.91	7.08	9.15	11.2	13.2	17.2	20.9	25.6			
26	2.75	5.12	7.37	9.56	11.7	13.8	17.8	21.8				
28	2.98	5.55	7.99	10.3	12.7	14.9	19.3	23.6				
30	3.20	5.98	8.60	11.2	13.7	16.1	20.8	25.5				
32	3.43	6.41	9.23	12.0	14.6	17.3	22.4	27.4				
35	3.78	7.06	10.2	13.2	16.1	19.0	24.5					
40	4.37	8.15	11.7	15.3	18.6	22.0	28.3					
45	4.96	9.26	13.3	17.3	21.2	24.8						

RSD140-LAMBDA®

No. of Teeth Small Spkt.	HORSEPOWER RATINGS										
	Maximum Speed - Small Sprocket (rpm)										
	5	10	15	20	25	30	40	50	60	80	100
11	1.70	3.16	4.57	5.91	7.22	8.51	11.0	13.5	15.9	20.6	25.2
12	1.86	3.48	5.01	6.50	7.93	9.36	12.1	14.9	17.4	22.7	
13	2.04	3.79	5.47	7.08	8.66	10.2	13.2	16.2	19.0	24.7	
14	2.20	4.11	5.92	7.67	9.38	11.1	14.3	17.6	20.6	26.7	
15	2.37	4.42	6.38	8.27	10.1	11.9	15.4	18.9	22.2		
16	2.55	4.74	6.84	8.86	10.8	12.8	16.5	20.2	23.9		
17	2.72	5.07	7.30	9.46	11.6	13.7	17.7	21.6	25.5		
18	2.90	5.39	7.77	10.1	12.3	14.5	18.8	22.9	27.1		
19	3.07	5.72	8.23	10.7	13.0	15.4	20.0	24.4			
20	3.24	6.04	8.70	11.3	13.8	16.2	21.0	25.7			
21	3.42	6.37	9.18	11.9	14.5	17.2	22.2	27.1			
22	3.59	6.70	9.65	12.5	15.3	18.0	23.3	28.5			
23	3.77	7.02	10.1	13.1	16.1	18.9	24.5				
24	3.94	7.36	10.6	13.7	16.8	19.8	25.6				
25	4.11	7.69	11.1	14.3	17.6	20.6	26.8				
26	4.30	8.03	11.6	15.0	18.4	21.6	27.9				
28	4.66	8.69	12.5	16.2	19.8	23.3	30.3				
30	5.01	9.37	13.5	17.4	21.3	25.2					
32	5.37	10.0	14.5	18.8	22.9	26.9					
35	5.92	11.1	15.9	20.6	25.2	29.8					
40	6.85	12.8	18.4	23.9	29.1						

Energy Series® Chain

Energy Series® Chain is designed for high speed and high shock load applications. This chain is built to deliver reliable power and performance in demanding applications like oil fields, mining, logging, and ball mills.



American
Petroleum
Institute

License
No. 7F-0016

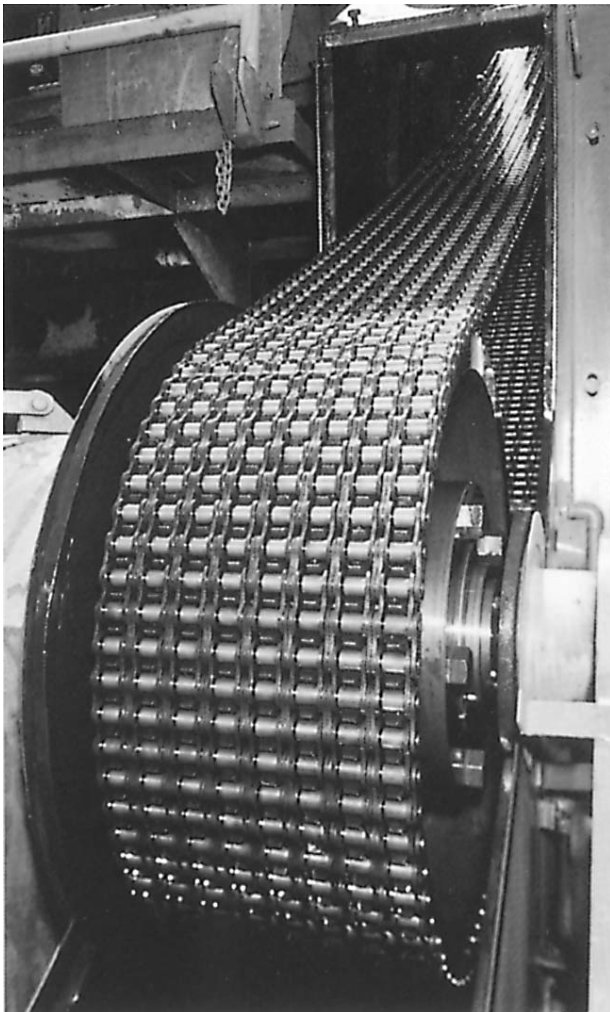

Pump Drive

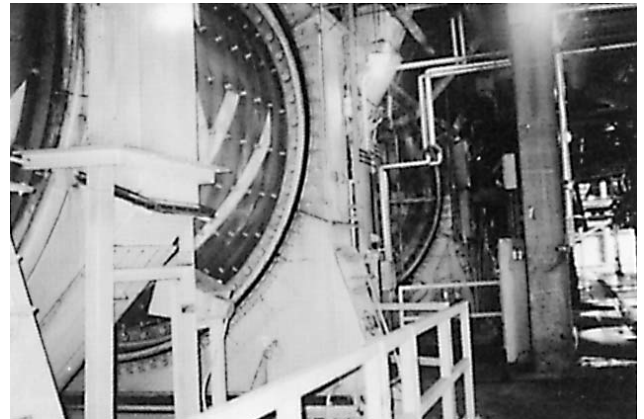

Ball Mill

Energy Series®



BY TSUBAKI



Benefits

- Stronger pins for longer chain life
- Ballized holes for improved fatigue strength
- Shot peened link plates for maximum strength
- Bushings and rollers that last longer
- Factory applied hot-dip lube penetrates deeper
- Unique Z-cotter design



Z-cotters hold tight, minimizing vibration and maximizing fatigue life, yet they're easy to assemble/disassemble in the field

Single Strand

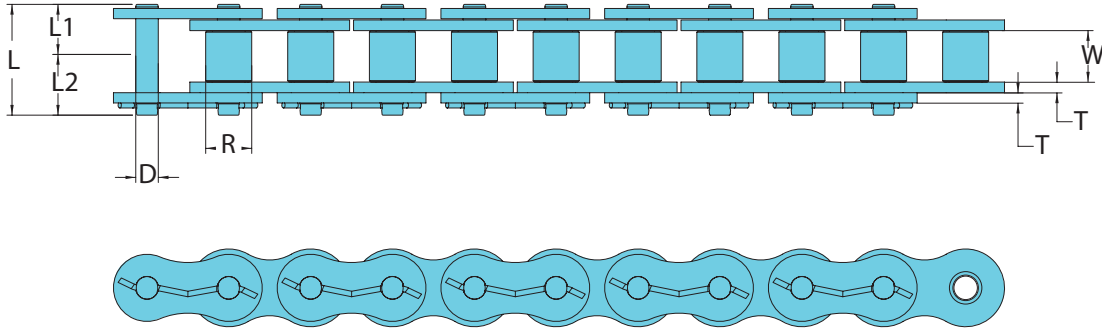

Dimensions

Chain No.	Pitch	L1	L2	L	D	R	W	h	H	T	ATS ¹
80	1.000	0.640	0.758	1.398	0.312	0.625	0.625	0.819	0.949	0.125	17,600
100	1.250	0.778	0.900	1.678	0.375	0.750	0.750	1.025	1.185	0.156	27,300
120	1.500	0.980	1.138	2.118	0.437	0.875	1.000	1.228	1.425	0.187	39,700
140	1.750	1.059	1.248	2.307	0.500	1.000	1.000	1.433	1.661	0.219	52,900
160	2.000	1.254	1.451	2.705	0.562	1.125	1.250	1.638	1.898	0.250	68,300
180	2.250	1.404	1.671	3.075	0.687	1.406	1.406	1.843	2.134	0.281	80,500
200	2.500	1.535	1.764	3.299	0.781	1.562	1.500	2.047	2.374	0.312	105,800
240	3.000	1.886	2.185	4.071	0.937	1.875	1.875	2.457	2.850	0.375	154,300
80H	1.000	0.720	0.823	1.543	0.312	0.625	0.625	0.819	0.949	0.156	20,900
100H	1.250	0.858	0.965	1.823	0.375	0.750	0.750	1.025	1.185	0.187	32,000
120H	1.500	1.061	1.203	2.264	0.437	0.875	1.000	1.228	1.425	0.219	43,000
140H	1.750	1.138	1.303	2.441	0.500	1.000	1.000	1.433	1.661	0.250	56,200
160H	2.000	1.337	1.514	2.851	0.562	1.125	1.250	1.638	1.898	0.281	71,700
180H	2.250	1.486	1.734	3.220	0.687	1.406	1.406	1.843	2.134	0.312	80,500
200H	2.500	1.689	1.894	3.583	0.781	1.562	1.500	2.047	2.374	0.375	125,700
264	2.500	1.686	1.965	3.651	0.875	1.562	1.500	2.047	2.366	0.375	121,000
240H	3.000	2.157	2.453	4.610	0.937	1.875	1.875	2.457	2.850	0.500	198,400

¹ Average Tensile Strength

Multi-Strand

Energy Series® is available in two, three, four, five, six, eight, and ten strands. Call U.S. Tsubaki for details.

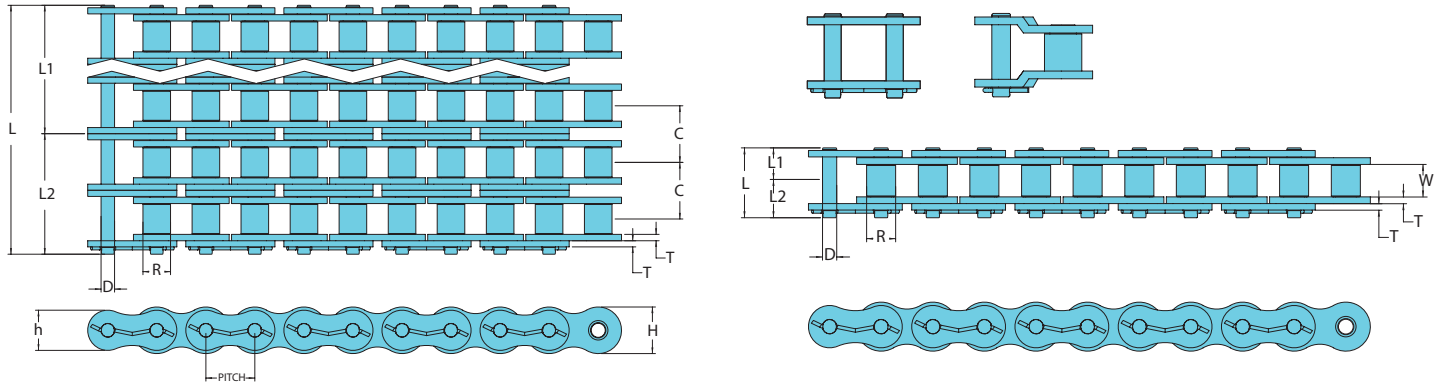

Dimensions

Chain No.	Pitch	Strands																			
		2						3						4							
L1	L2	L	D	R	W	h	H	C	T	L1	L2	ATS ¹	WPF ²	L1	L2	ATS ¹	WPF ²	L1	L2	ATS ¹	WPF ²
80	1.000	0.640	0.758	1.398	0.312	0.625	0.625	0.819	0.949	1.153	0.125	1.217	1.335	35,200	3.54	1.793	1.911	52,800	5.30		
100	1.250	0.778	0.900	1.678	0.375	0.750	0.750	1.025	1.185	1.408	0.156	1.482	1.604	54,600	5.27	2.186	2.308	81,900	7.91		
120	1.500	0.980	1.138	2.118	0.437	0.875	1.000	1.228	1.425	1.789	0.187	1.875	2.033	71,880	7.86	2.769	2.927	107,820	11.78		
140	1.750	1.059	1.248	2.307	0.500	1.000	1.000	1.433	1.661	1.924	0.219	2.021	2.210	94,370	9.97	2.983	3.172	141,550	14.92		
160	2.000	1.254	1.451	2.705	0.562	1.125	1.250	1.638	1.898	2.305	0.250	2.407	2.604	136,600	13.47	3.559	3.756	204,900	20.17		
180	2.250	1.404	1.671	3.075	0.687	1.406	1.406	1.843	2.134	2.592	0.281	2.700	2.967	161,000	17.82	3.996	4.263	241,500	25.68		
200	2.500	1.535	1.764	3.299	0.781	1.562	1.500	2.047	2.374	2.817	0.312	2.944	3.173	211,600	21.93	4.352	4.581	317,400	32.94		
240	3.000	1.886	2.185	4.071	0.937	1.875	1.875	2.457	2.850	3.458	0.375	3.615	3.914	308,600	32.32	5.344	5.643	462,900	48.11		
80H	1.000	0.720	0.823	1.543	0.312	0.625	0.625	0.819	0.949	1.283	0.156	1.362	1.465	41,800	4.15	2.003	2.106	62,700	6.21		
100H	1.250	0.858	0.965	1.823	0.375	0.750	0.750	1.025	1.185	1.539	0.187	1.628	1.735	64,000	6.07	2.397	2.504	96,000	9.10		
120H	1.500	1.061	1.203	2.264	0.437	0.875	1.000	1.228	1.425	1.924	0.219	2.023	2.165	71,880	8.67	2.985	3.127	107,820	12.99		
140H	1.750	1.138	1.303	2.441	0.500	1.000	1.000	1.433	1.661	2.055	0.250	2.166	2.331	94,370	11.01	3.193	3.358	141,550	16.48		
160H	2.000	1.337	1.514	2.851	0.562	1.125	1.250	1.638	1.898	2.437	0.281	2.556	2.733	143,400	14.64	3.774	3.951	215,100	21.93		
180H	2.250	1.486	1.734	3.221	0.687	1.406	1.406	1.843	2.134	2.722	0.312	2.847	3.095	161,000	19.20	4.208	4.456	241,500	28.80		
200H	2.500	1.689	1.894	3.583	0.781	1.562	1.500	2.047	2.374	3.083	0.375	3.231	3.436	207,260	24.51	4.772	4.977	310,890	36.81		
264	2.500	1.686	1.965	3.651	0.875	1.562	1.500	2.047	2.366	3.083	0.375	3.228	3.507	250,000	24.93	4.769	5.048	375,000	37.32		
240H	3.000	2.157	2.453	4.610	0.937	1.875	1.875	2.457	2.850	3.985	0.500	4.150	4.446	304,280	38.47	6.142	6.438	456,420	57.33		

Strands																					
4				5				6				8				10					
L1	L2	ATS ¹	WPF ²	L1	L2	ATS ¹	WPF ²	L1	L2	ATS ¹	WPF ²	L1	L2	ATS ¹	WPF ²	L1	L2	ATS ¹	WPF ²		
2.370	2.488	70,400	7.06	2.946	3.064	88,000	8.81	3.523	3.641	105,600	10.57	4.676	4.794	140,800	14.08	5.829	5.947	176,000	17.59		
2.890	3.012	109,200	10.55	3.594	3.716	136,500	13.12	4.298	4.420	163,800	15.78	5.706	5.828	218,400	21.01	7.114	7.236	273,000	26.24		
3.664	3.822	143,760	15.70	4.558	4.716	179,700	19.59	5.453	5.611	215,640	23.49	7.242	7.400	287,520	31.28	9.031	9.189	359,400	39.07		
3.945	4.134	188,740	19.16	4.907	5.096	235,920	24.84	5.869	6.058	283,110	29.77	7.793	7.982	377,490	40.38	9.717	9.906	471,870	50.99		
4.712	4.909	273,200	26.92	5.864	6.061	341,500	33.53	7.017	7.214	409,800	40.27	9.322	9.519	546,400	53.62	11.627	11.824	683,000	66.97		
5.292	5.559	322,000	34.20	6.588	6.855	402,500	42.73	7.884	8.151	483,000	51.25	10.476	10.743	644,000	68.30	13.068	13.335	805,000	85.35		
5.761	5.990	423,200	43.79	7.169	7.398	529,000	54.64	8.578	8.807	634,800	65.58	11.395	11.624	846,400	87.37	14.212	14.441	1,058,000	109.16		
7.073	7.372	617,200	63.90	8.802	9.101	771,500	79.70	10.531	10.830	925,800	95.49	13.989	14.288	1,234,400	127.08	—	—	—	—		
2.645	2.748	83,600	8.27	3.286	3.389	104,500	10.33	3.928	4.031	125,400	12.39	5.211	5.314	167,200	16.51	6.494	6.597	209,000	20.63		
3.167	3.274	128,000	12.13	3.936	4.043	160,000	15.16	4.706	4.813	192,000	18.19	6.245	6.352	256,000	24.25	7.784	7.891	320,000	30.31		
3.947	4.089	143,760	17.31	4.909	5.051	179,700	21.63	5.871	6.013	215,640	25.95	7.795	7.937	287,520	34.59	9.719	9.861	359,400	43.23		
4.221	4.386	188,730	21.95	5.248	5.413	235,910	27.42	6.276	6.441	283,090	32.89	8.331	8.496	377,450	43.83	10.386	10.551	471,810	54.77		
4.993	5.170	286,800	29.22	6.211	6.388	358,500	36.51	7.430	7.607	430,200	43.80	9.867	10.044	573,600	58.38	12.304	12.481	717,000	72.96		
5.569	5.817	322,000	38.40	6.930	7.178	402,500	48.00	8.291	8.539	483,000	57.60	11.013	11.261	644,000	76.80	13.735	13.983	805,000	96.00		
6.314	6.519	502,800	49.11	7.855	8.060	628,500	61.41	9.397	9.602	754,200	73.71	12.480	12.685	1,005,600	98.31	15.563	15.768	1,257,000	122.91		
6.311	6.590	500,000	49.81	7.852	8.131	625,000	62.30	9.394	9.673	750,000	74.79	12.477	12.756	1,000,000	99.77	—	—	—	—		
8.135	8.431	793,600	76.19	10.127	10.423	992,000	95.05	12.120	12.416	1,190,400	113.91	16.105	16.401	1,587,200	151.63	—	—	—	—		

¹ Average Tensile Strength (lbs.)
² Approximate Weight (lbs./ft.)

Super Chain

Proven Performance



ASME/ANSI standard roller chains are widely used in various industries. To meet the insistent demands of heavy industry, construction and agriculture, stronger and higher performing chains which can replace the corresponding ASME/ANSI standard chains are necessary. U.S. Tsubaki offers a line-up of Super and Ultra Super Chains which will solve your specific driving and conveying problems relating to heavy shock load and/or space limitations.

SUPER ROLLER CHAIN SUPER 80 ~ 240

High fatigue and tensile strength allow the selection of a chain one size smaller than would be required with standard chain.

Pins constructed of "high toughness" steel give this chain exceptional ability to absorb shock loads.

The link plate holes are ball drifted to obtain high fatigue strength.

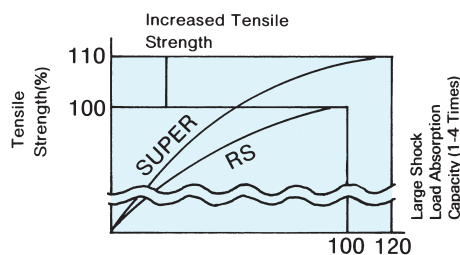

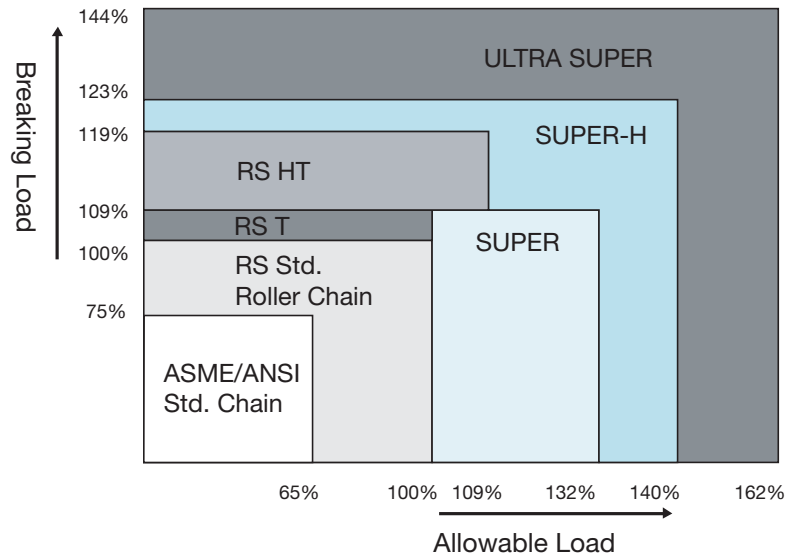

If you have a problem like breakage of pins due to heavy shock loads, we suggest that you use either the T Series or the HT Series.

If you have problems such as fatigue breakage of link plates, generally poor performance, or a space limitation, we suggest that you use the Super Series, Super-H Series or Ultra Super Series. You may be able to use the next smaller size chain or even a chain two sizes smaller.

T Series

T Series chains have greater shock load resistance and higher ultimate tensile strength than comparable ASME/ANSI standard roller chains. This is accomplished by using thru hardened pins. The dimensions of the chains are identical to ASME/ANSI standard roller chains.

HT Series

HT Series chains have a greater ultimate tensile strength (plus 15-30%) than ASME/ANSI standard roller chains by using thru hardened pins and link plates of the next larger chain size. These chains also provide greater shock load resistance. The dimensions of the chains are identical to those of the ASME/ANSI Heavy Series standard roller chains.

Super Series

The dimensions of Super Series Chain are identical to those of ASME/ANSI standard roller chain. Super Series Chain has a wider waist link plate than our standard chain and special manufacturing techniques are used to produce the pitch holes. After heat treatment, the holes are then ball drifted for greater fatigue strength. The pins are thru hardened for greater shock resistance. Because of this, Super Series Chain has a Maximum Allowable Load 25-30% higher than our standard RS roller chain.

Super-H Series

Super-H Series Chain has the same wide waist as Super Series. The link plate thickness is identical to those of the ASME/ANSI Heavy Series roller chains. The same special manufacturing techniques used in Super Series Chain are used to produce the pitch holes. The pins are thru hardened. Because of this, Super-H Series Chain has an even higher Maximum Allowable Load than the Super Series.

Ultra Super Series

U.S. Tsubaki Ultra Super Series has a greater ultimate tensile strength and allowable load than any other roller chain we manufacture. With the Ultra Super Series, a chain up to two sizes smaller than standard can be selected.

U.S. TSUBAKI SUPER CHAIN

RS-T Series

A - DRIVE CHAINS

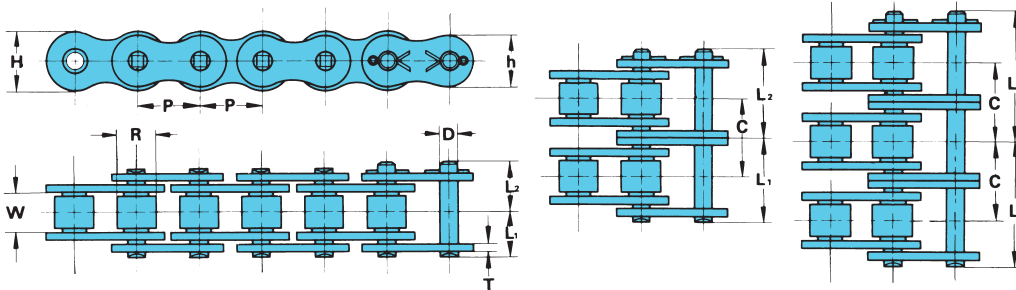

U.S. TSUBAKI Chain No.	Pitch P	Roller Dia. R	Width Between Roller Link Plates W	Link Plate			Pin			Transverse Pitch C	Average Tensile Strength lbs.	*Maximum Allowable Load lbs.	Approx. Weight lbs./ft.
				T	H	h	D	L ₁	L ₂				
SINGLE STRAND													
RS60T	.750	.469	.500	.094	.713	.614	.234	.506	.581	—	10,300	1,980	1.03
RS80T	1.000	.625	.625	.125	.949	.819	.312	.640	.758	—	17,600	3,300	1.79
RS100T	1.250	.750	.750	.156	1.185	1.024	.375	.778	.900	—	27,300	5,070	2.68
RS120T	1.500	.875	1.000	.187	1.425	1.228	.437	.980	1.138	—	39,700	6,830	3.98
RS140T	1.750	1.000	1.000	.219	1.661	1.433	.500	1.059	1.248	—	52,900	9,040	5.03
RS160T	2.000	1.125	1.250	.250	1.898	1.638	.562	1.254	1.451	—	68,300	11,900	6.79
RS200T	2.500	1.562	1.500	.312	2.374	2.047	.781	1.535	1.764	—	105,800	16,090	11.08
RS240T	3.000	1.875	1.875	.375	2.850	2.457	.937	1.886	2.185	—	154,300	22,270	16.46
DOUBLE STRAND													
RS60T-2	.750	.469	.500	.094	.713	.614	.234	.955	1.033	.897	20,600	3,360	2.04
RS80T-2	1.000	.625	.625	.125	.949	.819	.312	1.217	1.335	1.153	35,200	5,610	3.54
RS100T-2	1.250	.750	.750	.156	1.185	1.024	.375	1.484	1.606	1.408	54,600	8,610	5.27
RS120T-2	1.500	.875	1.000	.187	1.425	1.228	.437	1.874	2.031	1.789	79,400	11,560	7.86
RS140T-2	1.750	1.000	1.000	.219	1.661	1.433	.500	2.022	2.211	1.924	105,800	15,360	9.97
RS160T-2	2.000	1.125	1.250	.250	1.898	1.638	.562	2.407	2.604	2.305	136,600	20,230	13.47
RS200T-2	2.500	1.562	1.500	.312	2.374	2.047	.781	2.947	3.175	2.817	211,600	27,350	21.93
RS240T-2	3.000	1.875	1.875	.375	2.850	2.457	.937	3.618	3.913	3.458	308,600	37,850	32.32
TRIPLE STRAND													
RS60T-3	.750	.469	.500	.094	.713	.614	.234	1.404	1.502	.897	30,900	4,950	3.05
RS80T-3	1.000	.625	.625	.125	.949	.819	.312	1.795	1.909	1.153	52,800	8,250	5.30
RS100T-3	1.250	.750	.750	.156	1.185	1.024	.375	2.191	2.313	1.408	81,900	12,670	7.91
RS120T-3	1.500	.875	1.000	.187	1.425	1.228	.437	2.772	2.929	1.789	119,100	17,070	11.78
RS140T-3	1.750	1.000	1.000	.219	1.661	1.433	.500	2.986	3.179	1.924	158,700	22,600	14.92
RS160T-3	2.000	1.125	1.250	.250	1.898	1.638	.562	3.561	3.758	2.305	204,900	29,750	20.17
RS200T-3	2.500	1.562	1.500	.312	2.374	2.047	.781	4.360	4.585	2.817	317,400	40,220	32.94
RS240T-3	3.000	1.875	1.875	.375	2.850	2.457	.937	5.348	5.636	3.458	462,900	55,670	48.11

Note: Riveted type chain will be provided unless otherwise specified.

Cottered type chain will be provided upon request.

* Refer to page A-42, "Chain Drive Selection."

RS-HT Series

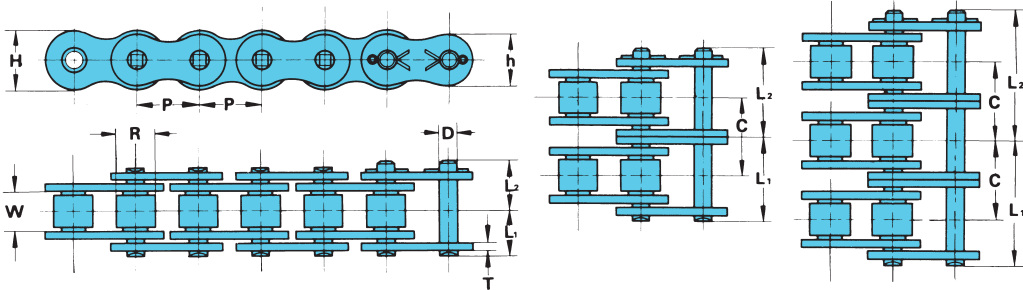

U.S. TSUBAKI Chain No.	Pitch P	Roller Dia. R	Width Between Roller Link Plates W	Link Plate			Pin			Transverse Pitch C	Average Tensile Strength lbs.	*Maximum Allowable Load lbs.	Approx. Weight lbs./ft.
				T	H	h	D	L ₁	L ₂				
SINGLE STRAND													
RS40HT	.500	.312	.312	.080	.472	.409	.156	.375	.433	—	5,290	1,170	.53
RS50HT	.625	.400	.375	.094	.591	.512	.200	.437	.504	—	8,260	1,870	.79
RS60HT	.750	.469	.500	.125	.713	.614	.234	.582	.669	—	12,500	2,200	1.21
RS80HT	1.000	.625	.625	.156	.949	.819	.312	.720	.823	—	20,900	3,630	2.08
RS100HT	1.250	.750	.750	.187	1.185	1.024	.375	.858	.965	—	31,900	5,510	3.07
RS120HT	1.500	.875	1.000	.219	1.425	1.228	.437	1.061	1.203	—	43,000	7,270	4.38
RS140HT	1.750	1.000	1.000	.250	1.661	1.433	.500	1.138	1.303	—	56,200	9,590	5.54
RS160HT	2.000	1.125	1.250	.281	1.898	1.638	.562	1.337	1.514	—	71,600	12,500	7.35
RS200HT	2.500	1.562	1.500	.375	2.374	2.047	.781	1.689	1.894	—	125,600	17,600	12.33
RS240HT	3.000	1.875	1.875	.500	2.850	2.457	.937	2.157	2.453	—	198,400	25,300	19.57
DOUBLE STRAND													
RS60HT-2	.750	.469	.500	.125	.713	.614	.234	1.083	1.181	1.028	25,100	3,700	2.41
RS80HT-2	1.000	.625	.625	.156	.949	.819	.312	1.358	1.492	1.283	41,800	6,100	4.15
RS100HT-2	1.250	.750	.750	.187	1.185	1.024	.375	1.630	1.736	1.539	63,900	9,300	6.06
RS120HT-2	1.500	.875	1.000	.219	1.425	1.228	.437	2.014	2.171	1.925	86,000	12,300	8.65
RS140HT-2	1.750	1.000	1.000	.250	1.661	1.433	.500	2.163	2.343	2.055	112,400	16,300	10.98
RS160HT-2	2.000	1.125	1.250	.281	1.898	1.635	.562	2.555	2.736	2.437	143,000	21,200	14.61
RS200HT-2	2.500	1.562	1.500	.375	2.374	2.047	.781	3.230	3.437	3.083	251,300	29,900	24.46
RS240HT-2	3.000	1.575	1.875	.500	2.850	2.457	.937	4.146	4.461	3.984	396,800	43,000	38.46
TRIPLE STRAND													
RS60HT-3	.750	.469	.500	.125	.713	.614	.234	1.614	1.720	1.028	37,700	5,500	3.60
RS80HT-3	1.000	.625	.625	.156	.949	.819	.312	1.998	2.120	1.283	62,800	9,000	6.20
RS100HT-3	1.250	.750	.750	.187	1.185	1.024	.375	2.400	2.510	1.539	95,900	13,700	9.08
RS120HT-3	1.500	.875	1.000	.219	1.425	1.228	.437	2.984	3.134	1.924	129,000	18,100	12.96
RS140HT-3	1.750	1.000	1.000	.250	1.661	1.433	.500	3.191	3.370	2.055	168,600	23,900	16.46
RS160HT-3	2.000	1.125	1.250	.281	1.898	1.635	.562	3.756	3.961	2.437	214,900	31,200	21.88
RS200HT-3	2.500	1.562	1.500	.375	2.374	2.047	.781	4.760	4.969	3.083	377,000	44,000	36.73
RS240HT-3	3.000	1.875	1.875	.500	2.850	2.457	.937	6.104	6.423	3.985	595,200	63,200	57.32

Note: Riveted type chain will be provided unless otherwise specified.

Cottered type chain will be provided upon request.

* Refer to page A-42, "Chain Drive Selection."

U.S. TSUBAKI SUPER CHAIN

Super Series

A - DRIVE CHAINS

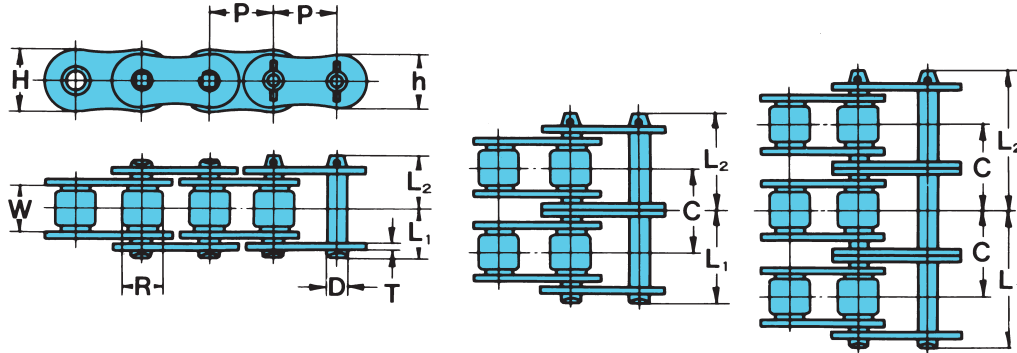

U.S. TSUBAKI Chain No.	Pitch P	Roller Dia. R	Width Between Roller Link Plates W	Link Plate			Pin			Transverse Pitch C	Average Tensile Strength lbs.	* Maximum Allowable Load lbs.	Approx. Weight lbs./ft.
				T	H	h	D	L ₁	L ₂				
SINGLE STRAND													
SUPER80	1.000	.625	.625	.125	.949	.819	.312	.640	.758	—	19,100	4,180	1.89
SUPER100	1.250	.750	.750	.156	1.185	1.024	.375	.778	.900	—	28,600	6,830	2.86
SUPER120	1.500	.875	1.000	.187	1.425	1.228	.437	.980	1.138	—	41,800	8,810	4.23
SUPER140	1.750	1.000	1.000	.219	1.661	1.433	.500	1.059	1.248	—	55,100	12,100	5.40
SUPER160	2.000	1.125	1.250	.250	1.898	1.638	.562	1.254	1.451	—	70,500	15,800	7.25
SUPER200	2.500	1.562	1.500	.312	2.374	2.047	.781	1.535	1.764	—	113,500	21,100	11.85
SUPER240	3.000	1.875	1.875	.375	2.850	2.457	.937	1.886	2.185	—	165,300	29,700	17.22
DOUBLE STRAND													
SUPER80-2	1.000	.625	.625	.125	.949	.819	.312	1.217	1.335	1.153	38,300	7,100	3.78
SUPER100-2	1.250	.750	.750	.156	1.185	1.024	.375	1.484	1.606	1.408	57,300	11,610	5.63
SUPER120-2	1.500	.875	1.000	.187	1.425	1.228	.437	1.874	2.031	1.789	83,700	14,990	8.36
SUPER140-2	1.750	1.000	1.000	.219	1.661	1.433	.500	2.022	2.211	1.924	110,200	20,610	10.70
SUPER160-2	2.000	1.125	1.250	.250	1.898	1.638	.562	2.407	2.604	2.305	141,000	26,980	14.40
SUPER200-2	2.500	1.562	1.500	.312	2.374	2.047	.781	2.947	3.175	2.817	227,000	35,980	23.46
SUPER240-2	3.000	1.875	1.875	.375	2.850	2.457	.937	3.618	3.913	3.458	330,700	50,590	34.19
TRIPLE STRAND													
SUPER80-3	1.000	.625	.625	.125	.949	.819	.312	1.795	1.909	1.153	57,500	10,470	5.64
SUPER100-3	1.250	.750	.750	.156	1.185	1.024	.375	2.191	2.313	1.408	85,900	17,080	8.45
SUPER120-3	1.500	.875	1.000	.187	1.425	1.228	.437	2.772	2.929	1.789	125,600	22,040	12.53
SUPER140-3	1.750	1.000	1.000	.219	1.661	1.433	.500	2.986	3.179	1.924	165,300	30,310	16.02
SUPER160-3	2.000	1.125	1.250	.250	1.898	1.638	.562	3.561	3.758	2.305	211,600	39,680	21.57
SUPER200-3	2.500	1.562	1.500	.312	2.374	2.047	.781	4.360	4.585	2.817	340,600	52,910	35.24
SUPER240-3	3.000	1.875	1.875	.375	2.850	2.457	.937	5.348	5.636	3.458	496,000	74,400	51.14

- Note:
- Offset links are not available.
 - Riveted type chain will be provided unless otherwise specified.
 - Press-fit connecting links will be supplied.
 - Carbon steel sprockets with hardened teeth should be used with Super Series chain.
 - *5. Refer to page A-42, "Chain Drive Selection."

Super-H Series

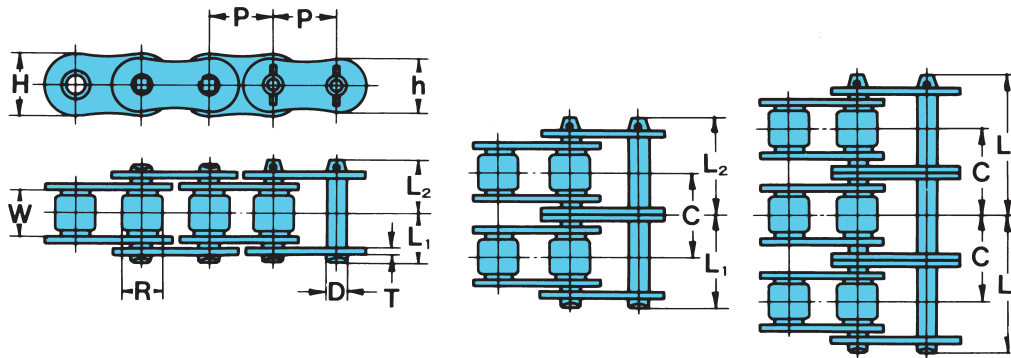

U.S. TSUBAKI Chain No.	Pitch P	Roller Dia. R	Width Between Roller Link Plates W	Link Plate			Pin			Transverse Pitch C	Average Tensile Strength lbs.	*Maximum Allowable Load lbs.	Approx. Weight lbs./ft.
				T	H	h	D	L ₁	L ₂				
SINGLE STRAND													
SUPER80H	1.000	.625	.625	.156	.949	.819	.312	.720	.823	—	22,000	4,630	2.21
SUPER100H	1.250	.750	.750	.187	1.185	1.024	.375	.858	.965	—	32,600	7,270	3.28
SUPER120H	1.500	.875	1.000	.219	1.425	1.228	.437	1.061	1.203	—	44,000	9,480	4.66
SUPER140H	1.750	1.000	1.000	.250	1.661	1.433	.500	1.138	1.303	—	57,300	12,780	5.97
SUPER160H	2.000	1.125	1.250	.281	1.898	1.638	.562	1.337	1.514	—	72,700	16,500	7.88
SUPER200H	2.500	1.562	1.500	.375	2.374	2.047	.781	1.689	1.894	—	134,400	22,500	13.22
SUPER240H	3.000	1.875	1.875	.500	2.850	2.457	.937	2.157	2.453	—	207,200	31,300	20.47
DOUBLE STRAND													
SUPER80H-2	1.000	.625	.625	.156	.949	.819	.312	1.358	1.492	1.283	44,000	7,870	4.38
SUPER100H-2	1.250	.750	.750	.187	1.185	1.024	.375	1.630	1.736	1.539	65,200	12,360	6.39
SUPER120H-2	1.500	.875	1.000	.219	1.425	1.228	.437	2.014	2.171	1.924	88,100	16,110	9.08
SUPER140H-2	1.750	1.000	1.000	.250	1.661	1.433	.500	2.163	2.343	2.055	114,600	21,730	11.68
SUPER160H-2	2.000	1.125	1.250	.281	1.898	1.638	.562	2.555	2.736	2.437	145,500	28,100	15.44
SUPER200H-2	2.500	1.562	1.500	.375	2.374	2.047	.781	3.230	3.437	3.083	268,900	38,220	25.86
SUPER240H-2	3.000	1.875	1.875	.500	2.850	2.457	.937	4.146	4.461	3.985	414,400	53,220	40.16
TRIPLE STRAND													
SUPER80H-3	1.000	.625	.625	.156	.949	.819	.312	1.998	2.120	1.283	66,100	11,570	6.55
SUPER100H-3	1.250	.750	.750	.187	1.185	1.024	.375	2.400	2.510	1.539	97,800	18,180	9.50
SUPER120H-3	1.500	.875	1.000	.219	1.425	1.228	.437	2.954	3.134	1.925	132,200	23,700	13.50
SUPER140H-3	1.750	1.000	1.000	.250	1.661	1.433	.500	3.191	3.370	2.055	171,900	31,960	17.39
SUPER160H-3	2.000	1.125	1.250	.281	1.898	1.638	.562	3.756	3.961	2.437	218,200	41,330	22.99
SUPER200H-3	2.500	1.562	1.500	.375	2.374	2.047	.781	4.761	4.968	3.083	403,400	56,210	38.50
SUPER240H-3	3.000	1.875	1.875	.500	2.850	2.457	.937	6.105	6.424	3.985	621,700	78,260	59.87

- Note:
1. Offset links are not available.
 2. Riveted type chain will be provided unless otherwise specified. Cottered type chain will be provided upon request.
 3. Press-fit connecting links will be supplied.
 4. Carbon steel sprockets with hardened teeth should be used with Super-H Series chain.
 - *5. Refer to page A-42, "Chain Drive Selection."

U.S. TSUBAKI SUPER CHAIN

Ultra Super Series

U.S. Tsubaki Ultra Super chains have superior strength, excellent durability, greater allowable load, higher breaking load, and are stronger than any other roller chain we manufacture. With 170% higher allowable load than that of ASME/ANSI RS standard chains, you can select up to two chain sizes smaller. U.S. Tsubaki Ultra Super chains will solve your specific driving and conveying problems relating to heavy shock load and/or space limitation.

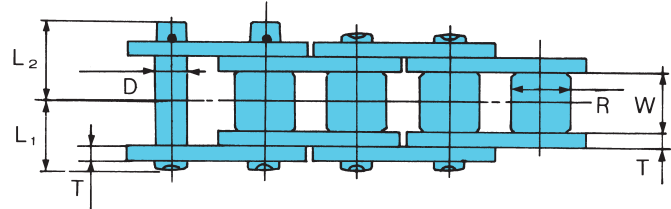
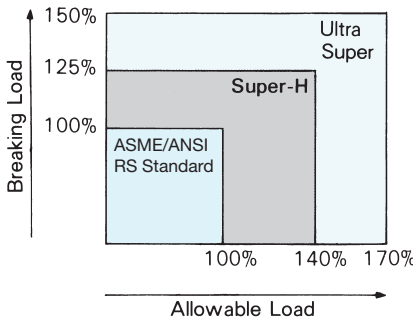
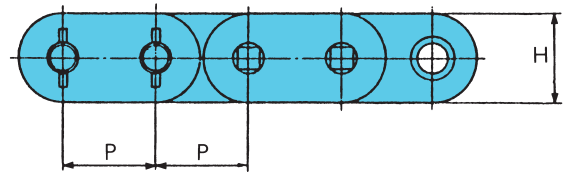
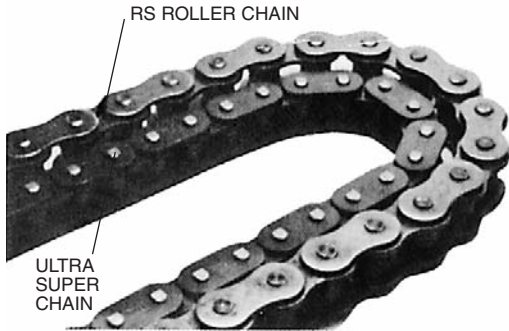

U.S. TSUBAKI Chain No.	Pitch P	Roller Dia. R	Width Between Roller Link Plates W	Link Plates		Pins			Average Tensile Strength lbs.	* Maximum Allowable Load lbs.	Approx. Weight lbs./ft.
				T	H	D	L ₁	L ₂			
US100	1.250	.750	.750	.187	1.185	.406	.880	.998	38,500	8,800	3.40
US120	1.500	.875	1.000	.219	1.425	.483	1.085	1.242	55,100	12,100	4.84
US140	1.750	1.000	1.000	.250	1.661	.550	1.161	1.346	70,500	14,300	6.20
US160	2.000	1.125	1.250	.281	1.898	.615	1.358	1.583	88,000	19,140	8.17
US200	2.500	1.562	1.500	.375	2.374	.804	1.691	2.006	149,600	24,200	13.73
US240	3.000	1.875	1.875	.500	2.850	.959	2.157	2.555	220,000	33,900	21.25

- Note:
- RS standard sprockets can be used if the sprocket teeth have been hardened and the sprocket is not of the cast iron type.
 - Chain should be lubricated using:
 - drip method
 - oil bath
 - lubrication pump
 - Offset links are not available.
 - Riveted type chains will be supplied unless otherwise specified.
 - Chains cannot be coupled with RS standard chains.
 - * Refer to page A-42, "Chain Drive Selection."

CHAIN DRIVE SELECTION

Chain Drive Selection

Generally, Super Series chains are suggested when the chain speed is less than 160 ft./min. and where the RS roller chain or the ASME/ANSI Heavy Series are not strong enough to meet the application requirements.

- 1) Tentatively select the chain and sprocket with the same size and number of teeth as used in "Selection for Slow Speed" on page A-23.
- 2) Calculate the chain speed from the number of teeth of the driving sprocket using equation (A) and check whether the speed is less than 160 ft./min.
- 3) Calculate the chain tension necessary for the above drive from equation (B).
- 4) Select the service factor and the chain speed coefficient from Tables I and II.
- 5) Select the suitable chain and verify that the chain satisfies equation (C).

$$S = \frac{P \cdot N \cdot n}{12} \text{ (ft./min.)} \dots\dots\dots (A)$$

$$T = \frac{33,000 \cdot \text{HP}}{S} \text{ (lbs.)} \dots\dots\dots (B)$$

$$T \cdot \text{Service Factor} \cdot \text{Chain Speed Coefficient} \leq \text{Maximum Allowable Load} \dots\dots\dots (C)$$

- S: chain speed (ft./min.)
- P: chain pitch (inch)
- N: number of teeth of driving sprocket
- n: RPM of driving sprocket
- T: chain tension (lbs.)
- HP: horsepower to be transmitted (HP)

The following three lubricating systems are suggested:

<p>System A</p> 	<p>Manual lubrication</p> <p>The oil is applied with an oil can or brush in the gap between the pin and roller link on the slack side of the chain. It should be applied about every eight hours or as often as necessary to prevent the bearing areas from becoming dry. Suitable chain speed is to be below 50 ft./min.</p>
<p>System B</p> 	<p>Drip lubrication</p> <p>A simple casing can be used. The oil is supplied by a drip feed. Each strand of chain should ordinarily receive 5 to 20 drops of oil per minute. The amount is increased as the speed increases. Suitable chain speed is from 50 to 100 ft./min.</p>
<p>System C</p> 	<p>Oil bath lubrication</p> <p>The chain is installed in a leak-free casing. The oil depth of "h" should be 1/4 to 1/2 inch deep. If the oil is too deep, it will be adversely affected by the heat generated. Suitable chain speed is from 100 to 160 ft./min.</p>

Table I: Service Factor

Type of Impact	Service Factor
Smooth	1.0
Some impact	1.3
Large impact	1.5

For details, refer to Table I on page A-22.

Table II: Chain Speed Coefficient

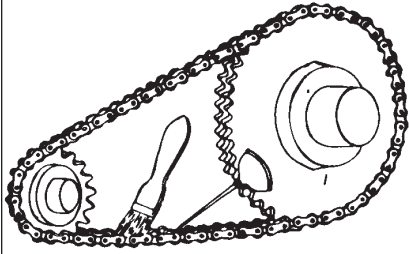
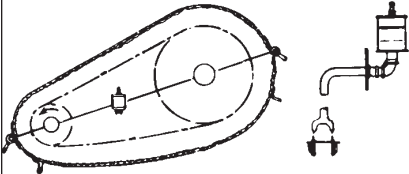
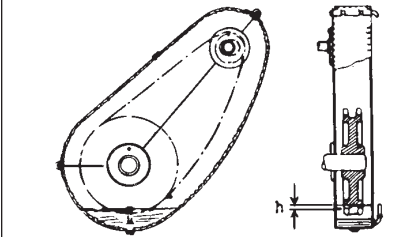
Chain Speed	Speed Coefficient
Less than 50 ft./min.	1.0
50 ~ 100 ft./min.	1.2
100 ~ 160 ft./min.	1.4

Ultra Miniature Chain

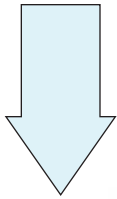

Maximum Allowable Load

Average Tensile Strength

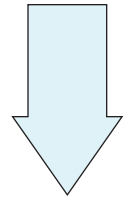

180 lbs.



BF25H



1,170 lbs.

140 lbs.



RS25



1,050 lbs.

70 lbs.



RS15



510 lbs.

11 lbs.



RS11-SS



175 lbs.

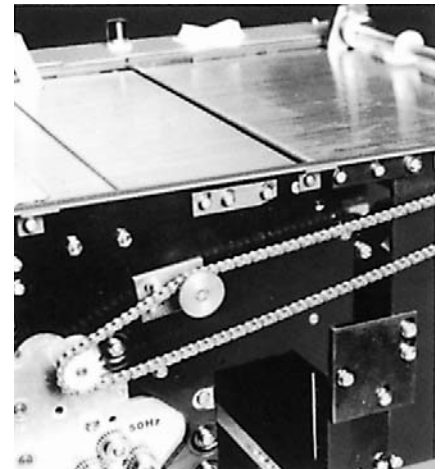
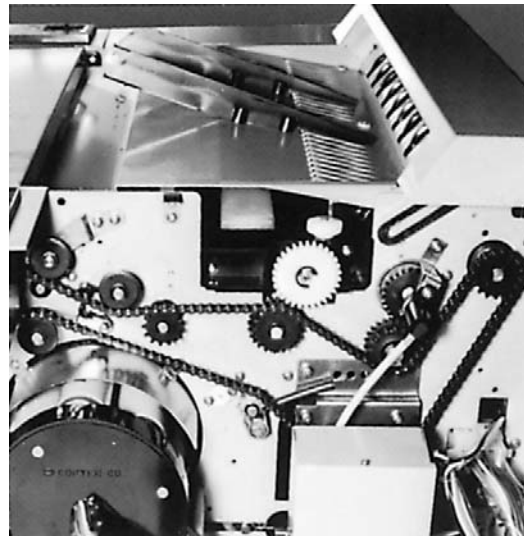
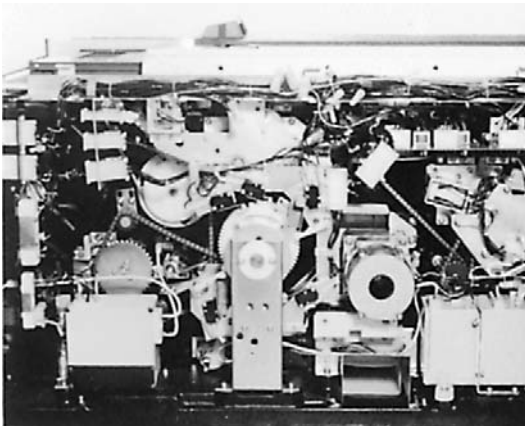

Ultra Miniature chain from U.S. Tsubaki is specially designed for applications with extremely limited space. Manufactured to the most exacting specifications, Ultra Miniature chain is perfect for applications requiring quiet, compact, lightweight chain with minimal polygonal action.

U.S. Tsubaki Ultra Miniature chain provides superior performance in a variety of demanding applications such as communications equipment, business machines, medical equipment, photographic equipment, and other electro-mechanical devices. U.S. Tsubaki Ultra Miniature chain is available in four styles to meet the needs of the most challenging small-scale chain applications.

Chain Selection

For smooth low-speed power transmission at speeds less than 160 ft./min., use the formula below to select optimum chain size.

$$\boxed{\text{Max. load (lbs.) on chain}} \times \boxed{\text{Service factor}} \times \boxed{\text{Chain speed coefficient}} \leq \boxed{\text{Max. allowable load (lbs.) on chain}}$$

Chain Speed Coefficient Table

Chain Speed	Chain Speed Coefficient
0 ~ 50 ft./min.	1.0
50 ~ 100 ft./min.	1.2
100 ~ 160 ft./min.	1.4

Table I: Service Factor

Type of Impact	Service Factor
Smooth	1.0
Some impact	1.3

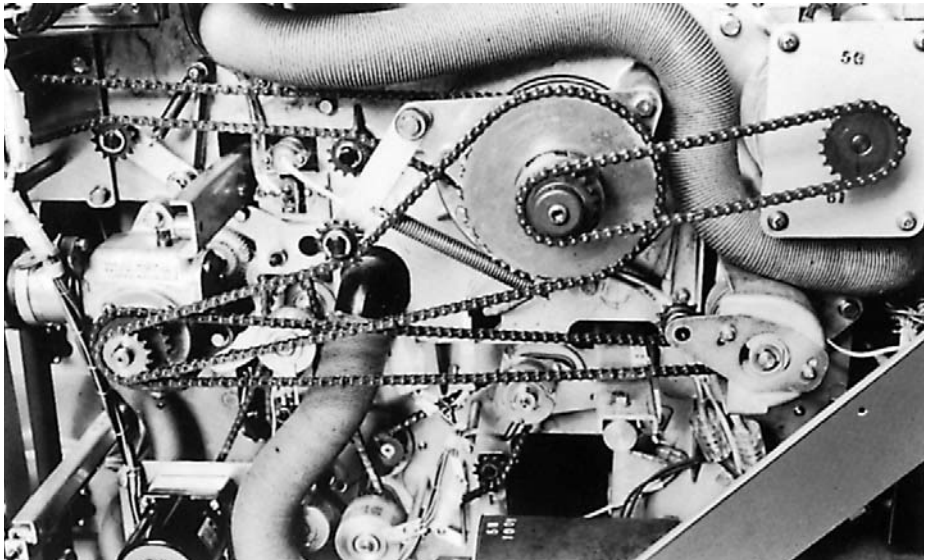
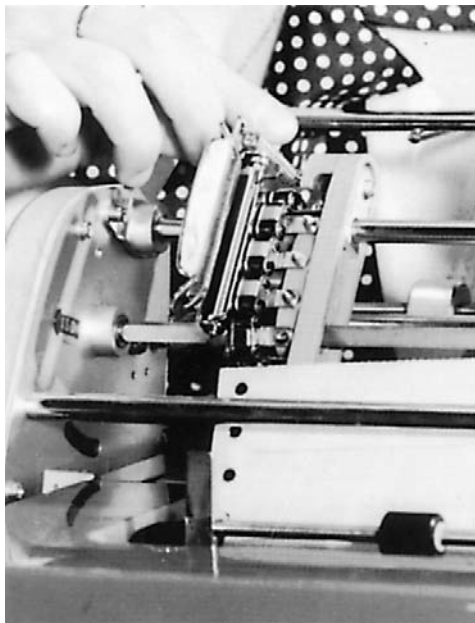

U.S. TSUBAKI MINIATURE CHAIN

RS11SS

U.S. Tsubaki Miniature chain RS11SS is made of 304 stainless steel throughout. This provides superior corrosion resistance and high temperature resistance. The chain is specially designed for use where space is extremely limited, such as in communications equipment, business machines and electro-mechanical devices.

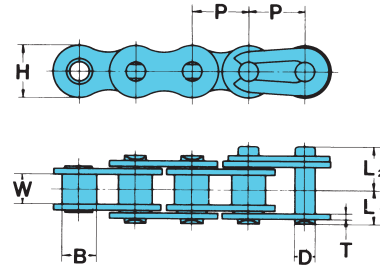

U.S. TSUBAKI Chain No.	Pitch	Bushing Diameter	Width Between Inner Link Plates	Link Plate			Pin			Average Tensile Strength lbs.	*Maximum Allowable Load lbs.	Approx. Weight lbs./ft.	Number of Links per 10 ft.
	P	B	W	T	H	D	L ₁	L ₂	L ₁ +L ₂				
RS11SS	.1475	.090	.072	.015	.138	.062	.090	.125	.214	175	11	.035	814

Note: No offset links available.

* Refer to page A-44, "Chain Selection."

RS15



U.S. Tsubaki RS15 bushed chain is between RS25 and RS11SS in size and is economical for compact applications.

- Strong and precise, this chain is based on RS roller chain production technology.
- Lightweight and compact, it is only half the weight of RS25 which is the smallest ASME/ANSI roller chain.
- All parts are heat-treated for better strength and wear resistance.
- Suitable for industrial data equipment, business machines, electric and electronic equipment, medical instruments, photographic equipment and other devices.

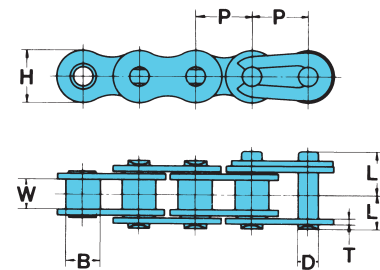

U.S. TSUBAKI Chain No.	Pitch	Bushing Diameter	Width Between Inner Link Plates	Link Plate			Pin			Average Tensile Strength lbs.	*Maximum Allowable Load lbs.	Approx. Weight lbs./ft.	Number of Links per 10 ft.
	P	B	W	T	H	D	L ₁	L ₂	L ₁ +L ₂				
RS15	.1875	.098	.094	.024	.169	.064	.120	.152	.272	510	70	.05	640

Note: No offset links available.

* Refer to page A-44, "Chain Selection."

RS25 • BF25H

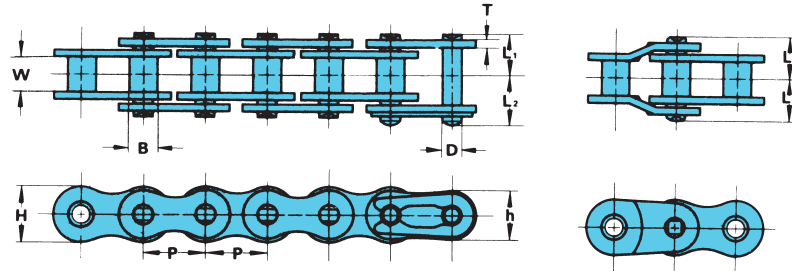

RS25

RS25/BF25H

U.S. Tsubaki RS25 bushed chain is the smallest ANSI roller chain. It is ideal for power transmission in business machines, electro-optical equipment, and precision and general industrial machines where relatively large space is allowed for miniature drives.

U.S. Tsubaki BF25H bushed chain works with standard sprockets. It is a flat side-bar chain, and its inner link plates are thicker than RS25.

These chains can accommodate a large allowable load and are widely used for driving motorcycle cam shafts and power transmission machinery in general.

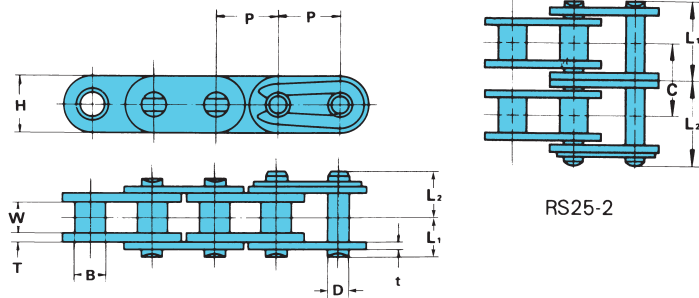

BF25H

RS25-2

U.S. TSUBAKI Chain No.	ANSI No.	Pitch P	Bushing Diameter B	Width Between Inner Link Plates W	Link Plate				Pin Diameter D
					T	t	H	h	
RS25	25	.250	.130	.125	.030	—	.230	.199	.0905
BF25H	—	.250	.130	.125	.039	.030	.230	—	.0905

U.S. TSUBAKI Chain No.	Number of Strands	Pin			Transverse Pitch C	Type of Pin	Minimum Ultimate Strength ANSI Standard lbs.	Average Tensile Strength lbs.	* Maximum Allowable Load lbs.	Approx. Weight lbs./ft.	Number of Links per 100 ft.
		L ₁ +L ₂	L ₁	L ₂							
RS25	1	.339	.150	.189	—	Riveted	780	1,050	140	.09	480
RS25-2	2	.591	.276	.315	.252	Riveted	1,560	2,100	240	.18	480
BF25H	1	.362	.161	.201	—	Riveted	—	1,320	170	.11	480

Note: Only two-pitch offset links are available for RS25 and RS25-2.

No offset links are available for BF25H.

* Refer to page A-44, "Chain Selection."

U.S. TSUBAKI BS/DIN ROLLER CHAIN

A - DRIVE CHAINS

BS/DIN Roller Chain



These chains are manufactured to International Standards Organization metric dimensions (ISO 606), British Standard (BS 228), and DIN 8187.

They are available in a variety of sizes and types from U.S. Tsubaki and are ideal for use as replacement chains on imported equipment or new machinery manufactured for export.

British Standard chains are manufactured with the same quality materials used in our ASME/ANSI standard chains.

U.S. Tsubaki British Standard chains are available in stainless steel, nickel-plated, NEPTUNE®, and LAMBDA®.

Pin Link



Riveted type
Standard for all sizes
of roller chains.

Roller Link



Available for
all sizes of
roller
chains.

Connecting Link



Spring clip type.
Standard for 3/8" to
1" pitch chains.

Cotter pin type.
For 1-1/4" to
2-1/2" pitch chains.

One Pitch Offset Link



Slip-fit type.
The use of offset links
should be avoided
whenever possible.

Two Pitch Offset Link



Press-fit and riveted type.
Not available for chain sizes of
RS20B and over.

BS/DIN Chain Series

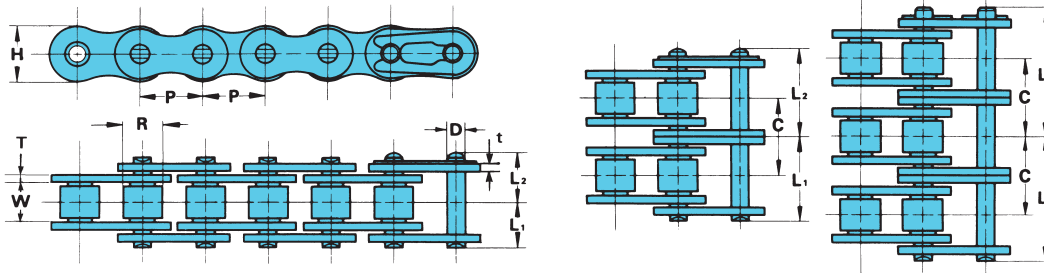

U.S. TSUBAKI Chain No.	ISO BS/DIN No.	Pitch P	Roller Dia. R	Width Between Roller Link Plates W	Pin		Link Plate			Transverse Pitch C	Average Tensile Strength lbs.	Bearing Area (Nominal) inch ²	Approx. Weight lbs./ft.	Number of Links per 10 ft.	
					D	L ₁	L ₂	T	t						H
SINGLE STRAND															
RF06B ★	06B	.375	.250	.225	.129	.255	.296	.050	.040	.323	—	2,310	.040	.26	320
RS08B	08B	.500	.335	.305	.175	.329	.395	.060	.060	.465	—	4,410	.078	.47	240
RS10B	10B	.625	.400	.380	.200	.370	.449	.060	.060	.579	—	5,840	.104	.64	192
RS12B	12B	.750	.475	.460	.225	.433	.520	.070	.070	.634	—	7,500	.138	.84	160
RS16B	16B	1.000	.625	.670	.326	.705	.783	.156	.125	.827	—	16,500	.326	1.82	120
RS20B	20B	1.250	.750	.770	.401	.791	.912	.177	.138	1.024	—	24,300	.457	2.59	96
RS24B	24B	1.500	1.000	1.000	.576	1.051	1.238	.236	.204	1.315	—	41,900	.859	5.01	80
RS28B	28B	1.750	1.100	1.220	.626	1.278	1.474	.295	.248	1.433	—	48,500	1.147	6.35	68
RS32B	32B	2.000	1.150	1.220	.701	1.264	1.484	.276	.248	1.661	—	63,100	1.257	6.89	60
RS40B	40B	2.500	1.550	1.500	.901	1.545	1.774	.335	.315	2.083	—	88,200	1.978	10.99	48
DOUBLE STRAND															
◆ RF06B-2 ★	06B-2	.375	.250	.225	.129	.451	.506	.050	.040	.323	.403	4,080	.090	.50	320
◆ RS08B-2	08B-2	.500	.335	.305	.175	.603	.669	.060	.060	.465	.548	7,600	.156	.90	240
RS10B-2	10B-2	.625	.400	.380	.200	.699	.773	.060	.060	.579	.653	11,700	.208	1.24	192
RS12B-2	12B-2	.750	.475	.460	.225	.819	.901	.070	.070	.634	.766	15,000	.276	1.68	160
RS16B-2	16B-2	1.000	.625	.670	.326	1.335	1.413	.157	.125	.827	1.255	31,500	.652	3.62	120
RS20B-2	20B-2	1.250	.750	.770	.401	1.509	1.631	.177	.138	1.024	1.435	46,100	.916	5.14	96
RS24B-2	24B-2	1.500	1.000	1.000	.576	2.004	2.191	.236	.204	1.315	1.904	79,800	1.719	9.84	80
RS28B-2	28B-2	1.750	1.100	1.220	.626	2.450	2.646	.295	.248	1.433	2.345	92,400	2.296	12.63	68
RS32B-2	32B-2	2.000	1.150	1.220	.701	2.417	2.636	.276	.248	1.661	2.305	119,900	2.516	13.51	60
RS40B-2	40B-2	2.500	1.550	1.500	.901	2.970	3.197	.335	.315	2.083	2.846	169,300	3.957	21.50	48
TRIPLE STRAND															
◆ RS08B-3	08B-3	.500	.335	.305	.175	.876	.943	.060	.060	.465	.548	10,900	.234	1.34	240
RS10B-3	10B-3	.625	.400	.380	.200	1.026	1.100	.060	.060	.579	.653	17,500	.312	1.88	192
RS12B-3	12B-3	.750	.475	.460	.225	1.205	1.283	.070	.070	.634	.766	22,500	.414	2.55	160
RS16B-3	16B-3	1.000	.625	.670	.326	1.963	2.041	.156	.125	.827	1.255	47,000	.978	5.36	120
RS20B-3	20B-3	1.250	.750	.770	.401	2.226	2.349	.177	.138	1.024	1.435	69,200	1.374	7.70	96
RS24B-3	24B-3	1.500	1.000	1.000	.576	2.956	3.142	.236	.204	1.315	1.904	119,500	2.580	14.62	80
RS28B-3	28B-3	1.750	1.100	1.220	.626	3.623	3.820	.295	.248	1.433	2.345	138,500	3.443	18.95	68
RS32B-3	32B-3	2.000	1.150	1.220	.701	3.569	3.789	.276	.248	1.661	2.305	180,100	3.774	20.10	60
RS40B-3	40B-3	2.500	1.550	1.500	.901	4.393	4.621	.335	.315	2.083	2.846	255,300	5.935	32.09	48

Note: ★ Flat shape link plate 
 ◆ Middle link plate has one solid plate.
 Riveted type chain will be supplied unless otherwise specified.
 Stainless steel is available.
 Refer to Section "B" for BS/DIN attachment specifications.

U.S. TSUBAKI BS/DIN ROLLER CHAIN

BS/DIN Drive Lambda Λ ®

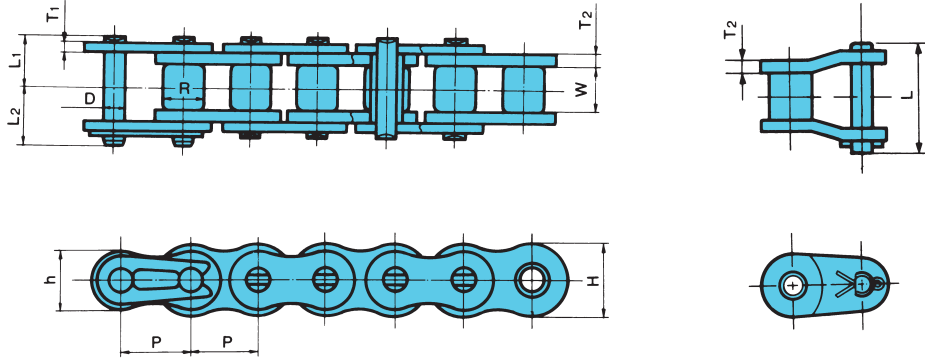

Dimensions – Inches

U.S. TSUBAKI Chain No.	Pitch P	Roller Diameter R	Width Between Roller Link Plates W	Link Plates			
				PLP Thickness T_1	RLP Thickness T_2	RLP Height H	PLP Height h
RSD08B-LAMBDA®	.500	.335	.305	.060	.080	.472	.409
RSD10B-LAMBDA	.625	.400	.380	.080	.080	.591	.512
RSD12B-LAMBDA	.750	.475	.460	.094	.094	.713	.614

U.S. TSUBAKI Chain No.	Pin				Avg. Tensile Strength lbs.	Approx. Weight lbs./ft.
	D	L_1	L_2	L		
RSD08B-LAMBDA	.175	.346	.411	.787	4,230	.47
RSD10B-LAMBDA	.200	.406	.472	.886	6,080	.70
RSD12B-LAMBDA	.225	.486	.565	1.138	9,060	1.01

Note: Although some dimensions differ from British Standard (DIN), the primary dimensions are identical, enabling BS LAMBDA® to engage perfectly with British Standard sprockets.

BS/DIN Stainless Steel

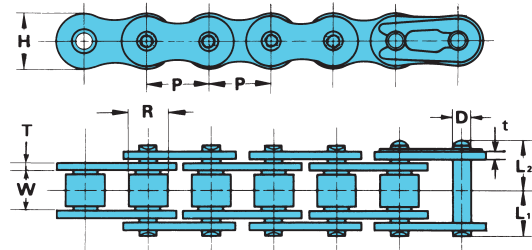

U.S. TSUBAKI Chain No.	ISO BS/DIN No.	Pitch P	Roller Diameter R	Width Between Roller Link Plates W	Pin			Link Plate			Average Tensile Strength lbs.	Bearing Area (Nominal) inch ²	Approx. Weight lbs./ft.
					D	L ₁	L ₂	T	t	Height (max.) H			
RF06BSS ★	06B	.375	.250	.225	.129	.255	.296	.050	.040	.323	1,430	.040	.26
RS08BSS	08B	.500	.335	.305	.175	.329	.395	.060	.060	.465	2,200	.078	.47
RS10BSS	10B	.625	.400	.380	.200	.370	.449	.060	.060	.579	3,190	.104	.64
RS12BSS	12B	.750	.475	.460	.225	.433	.520	.070	.070	.634	3,740	.138	.84
RS16BSS	16B	1.000	.625	.670	.326	.705	.783	.156	.125	.827	10,560	.326	1.82

Note: ★ Flat shape link plate 
 Stainless steel roller chains with over 1.00 inch pitch plate are also available upon request.
 Double-strand and triple-strand are also available.

U.S. TSUBAKI BS/DIN ROLLER CHAIN

CHAIN DRIVE SELECTION

SELECTION PROCEDURE

- 1) The following factors must be considered when selecting roller chains for transmission needs.
 - The power to be transmitted.
 - The speed and the diameters of the driving shaft and the driven shaft.
 - The distance between the centers of the shafts.
- 2) Use Table I to obtain the service factor. (The "Service Factor" table refers to the type of machine and source of power.)
- 3) Multiply the HP value by the service factor to obtain the design HP value.
- 4) Use Table III page A-52 to obtain the appropriate chain number and the number of teeth for the small sprocket by referring to the number of revolutions of the high speed shaft (the driving shaft when the speed is reduced; the driven shaft when the speed is increased) and the design HP value. For a smoother chain drive, a smaller pitch chain is suggested. If a single strand chain does not satisfy the transmission requirements, use a multi-strand chain. If the distance between the shafts and the diameter of the sprockets must be relatively small due to space considerations, a multiple strand roller chain with a smaller pitch may be used.

- 5) After determining the number of teeth for the small sprockets, confirm if the sprocket will meet the shaft diameter requirements.
- 6) The number of teeth for the large sprocket is determined by multiplying the number of teeth for the small sprocket by the speed ratio. While it is preferable that the number of teeth for the small sprocket be greater than 15, it is suggested that the number of teeth for the large sprocket not exceed 120. By reducing the number of teeth for the small sprocket, the number of teeth for the large sprocket can also be reduced.

Table II: Multiple-Strand Factor

Number of Roller Chain Strand	Multiple-Strand Factor
Double Strand	1.7
Triple Strand	2.5

Number of Pitches of Chain

$$L = \frac{N_1 + N_2}{2} + 2C + \frac{\left(\frac{N_2 - N_1}{6.28}\right)^2}{C}$$

Any fraction of L is counted as one pitch.

Center Distance in Pitches

$$C = \frac{1}{8} \left\{ 2L - N_1 - N_2 + \sqrt{(2L - N_1 - N_2)^2 - \frac{8}{9.86} (N_2 - N_1)^2} \right\}$$

- L: Number of pitches of chain
 N₁: Number of teeth (small sprocket)
 N₂: Number of teeth (large sprocket)
 C: Center distance in pitches

Chain Speed

$$S = \frac{P \cdot N \cdot n}{12} \text{ (ft./min.)}$$

- S: Chain speed (ft./min.)
 P: Chain pitch (inch)
 N: Number of teeth of sprocket
 n: rpm of the sprocket

Chain Tension from HP

$$T = \frac{33,000 \cdot \text{HP}}{S} \text{ (lbs.)}$$

- T: Chain tension (lbs.)

Table I: Service Factor

Type of Impact	Machines	Source of Power		
		Electric Motor or Turbine	Internal Combustion Engine With hydraulic drive	Internal Combustion Engine Without hydraulic drive
Smooth	Belt conveyors with small load fluctuation, chain conveyors, centrifugal blowers, general textile machines, machines with small load fluctuation.	1.0	1.0	1.2
Some impact	Centrifugal compressors, marine engines, conveyors with some load fluctuation, automatic furnaces, dryers, pulverizers, general machine tools, compressors, general work machines, general paper mills.	1.3	1.2	1.4
Large impact	Presses, construction or mining machines, vibration machines, oil well rigs, rubber mixers, general machines with reverse or impact load.	1.5	1.4	1.7

Table III: BS Roller Chain Selection Table

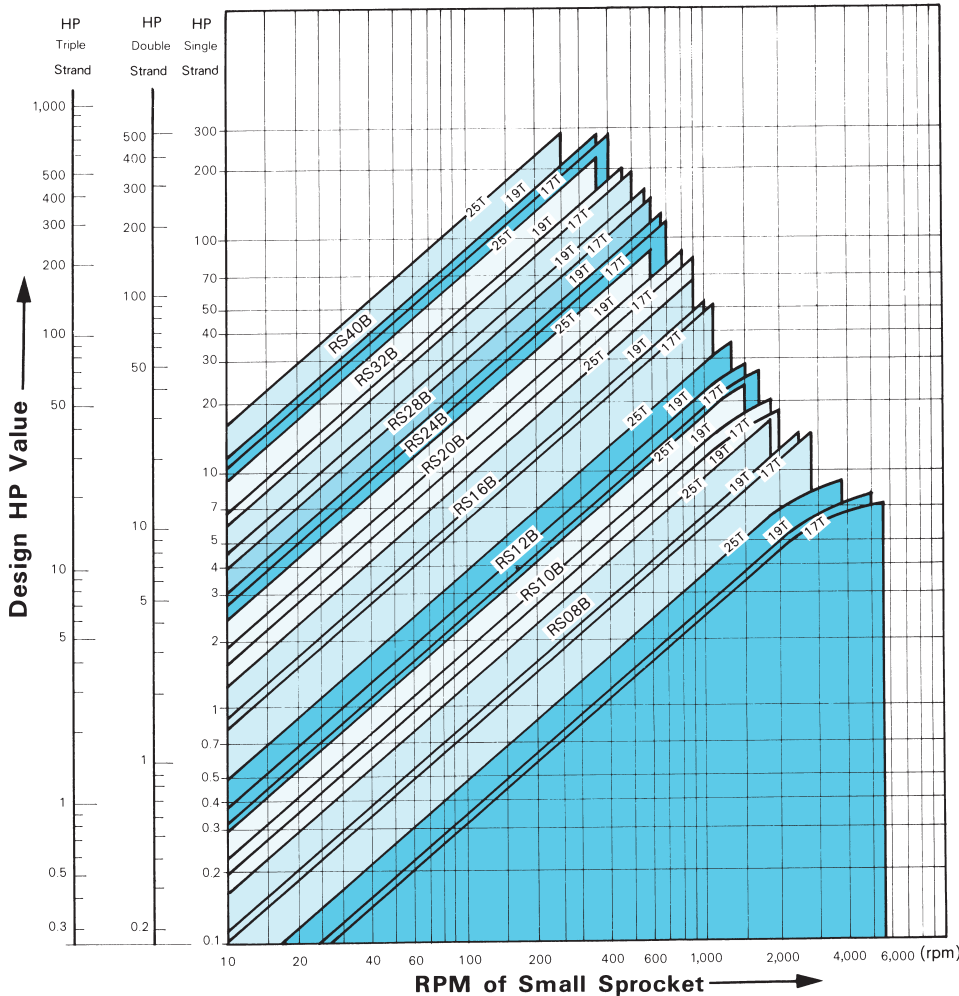

The selection table is based on the following conditions:

- 1) The chains are operated under ordinary conditions. The ambient temperature range is between 15°F and 140°F. They are not to be used in an atmosphere where abrasive dust or corrosive gas is present or when the humidity is exceptionally high.
- 2) The two transmission shafts are in a horizontal position and the chains are properly installed.
- 3) The suggested lubrication system shown on Table IV is used.
- 4) The load does not change significantly during transmission. The "Service Factors" given in Table I are used when the chains are used under various operating conditions. The load conditions will affect the life of the chain. The increase in the horsepower rating of multiple-strand roller chains cannot be calculated simply by multiplying the horsepower rating of one strand by the total number of strands, since the load on each strand is not exactly the same. In order to estimate the service life of a multiple-strand chain, the "Multiple-Strand Factor" given in Table II must be used.

Table IV: Chain Speed and Lubrication System

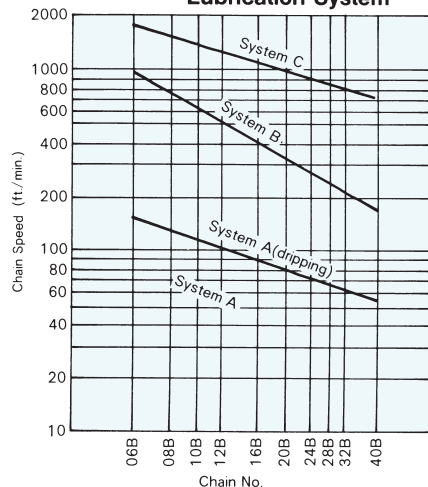

Note: Refer to page A-77 for details of lubrication system.

Example

- Data:
1. Type of application: Centrifugal Blowers
 2. Source of power: Electric Motor
 3. HP to be transmitted: 40 hp
 4. Driving shaft: 600 rpm
 5. Driven shaft: 200 rpm
 6. Center distance: 19 inches
 7. Space limit: Max. 24 inches

- Step 1** Use Table I and determine the service factor.
Service factor (SF): 1.0
- Step 2** Obtain design HP
Design HP = HP to be transmitted • SF
= 40 hp • 1.0
= 40 hp
- Step 3** Obtain the chain size and the number of teeth of the small sprocket from the selection table for 40 hp and 600 rpm.

According to the selection table, the selected chain and sprocket rpms are:

- (a) RS12B-3 chain and 25-tooth sprocket
- (b) RS16B-2 chain and 17-tooth sprocket
- (c) RS16B-1 chain and 25-tooth sprocket

- * For (a), the necessary number of teeth for both small and large sprockets are 25 teeth and 75 teeth respectively, since the speed ratio is 1/3 (200/600 rpm). But the outside diameter of both sprockets, 6.3 inches for 25 teeth and 18.3 inches for 75 teeth, exceeds the limitation (6.3 inches + 18.3 inches > 24 inches). Therefore, these sprockets cannot be installed.
- * For (c), the necessary number of teeth for both small and large sprockets are 25 teeth (outside dia. 8.4 inches) and 75 teeth (outside dia. 24.4 inches), respectively. It exceeds the space limitation again (8.4 inches + 24.4 inches > 24 inches).
- * For (b), the necessary number of teeth for both the small and large sprockets are 17 (outside dia. 5.9 inches) and 51 (outside dia: 16.8 inches). It satisfies the space limitation (5.9 inches + 16.8 inches < 24 inches). A combination of RS16B-2, and 17 teeth and 51 teeth must be used to fulfill all the necessary requirements.

- Step 4** Use Table IV to determine the lubrication method.

$$\text{Chain speed (S)} = \frac{P \cdot N \cdot n}{12}$$

$$= \frac{1 \cdot 600 \cdot 17}{12} = 850 \text{ ft./min.}$$

System B is suggested.

- Step 5** Obtain the number of pitches of chain (L).

$$= \frac{N_1 + N_2}{2} + 2C + \frac{(N_2 - N_1)^2}{6.28^2 C}$$

$$= \frac{17 + 51}{2} + 2 \cdot \frac{19}{1} + \frac{(51 - 17)^2}{\frac{6.28^2}{1}}$$

$$= 73.35 \rightarrow 74 \text{ links}$$

Anti-Corrosive Heat Resistant Chain

NEPTUNE® CHAIN

NEPTUNE® chain resists corrosion when exposed to harsh outdoor environments, including seawater. The exclusive **NEPTUNE** surface treatment process gives the chain its unique matte grey color and provides a protective finish that is more corrosion resistant than Nickel-Plated chains. **NEPTUNE** chain has the same high maximum allowable load as our standard carbon steel roller chain.

NICKEL-PLATED CHAIN

Nickel-Plated chains provide acceptable performance where equipment must operate in mildly corrosive environments.

600 AS SERIES

AS Series chains are an excellent choice for drives requiring both corrosion resistance and high load capacity. Link plates are made of 304 stainless steel and the round parts are made of hardened 600 series stainless steel. Of all the stainless steel chains offered by U.S. Tsubaki, **AS Series** has the highest load capacity. Use where stainless steel is required by FDA regulations.

304 SS SERIES

SS Series chains are made completely of 304 stainless steel. **SS Series** has an excellent resistance to corrosion & temperature extremes. It is generally considered non-magnetic, although some permeability can be found in these chains. This is caused by the cold working of the components during the manufacturing process. If more complete non-magnetic permeability is required, we suggest our NS Series.

316 NS SERIES

NS Series chains are made completely of 316 stainless steel. It is the most corrosion resistant standard stainless steel chain offered by U.S. Tsubaki. It also has the highest resistance to temperature extremes, and is sometimes referred to as our *non-magnetic series* because of its extremely low magnetic permeability. The load capacity of 316 **NS Series** is equal to that of our 304 SS Series.

POLY-STEEL CHAIN

Poly-Steel chain is made of molded engineered plastic with 304 stainless steel pin links. This combination effectively incorporates the advantages of both materials into one chain. **Poly-Steel** chain from U.S. Tsubaki has superior wear life, excellent corrosion resistance, and requires no lubrication. This design provides a quiet, lightweight chain for economical solutions to difficult application problems.

TITANIUM TI SERIES

TI Series chains are made completely of Titanium. Available in sizes RS35TI - RS60TI, **TI Series** brings the unique properties of Titanium to roller chain applications, specifically extreme corrosion resistance in a lightweight chain. Available on a made-to-order basis in the same dimensions as the 304 SS Series. Call U.S. Tsubaki for further details.

NEPTUNE[®] Chain

Drive Chain

U.S. TSUBAKI Chain Size	Pitch P	Width Between Roller Link Plates W	Roller Diameter R	Link Plate			Pin			Average Tensile Strength lbs.	Max. Allowable Load lbs.	Approx. Weight lbs./ft.
				T	H	h	L ₁	L ₂	D			
RS35NT	.375	.188	.200	.050	.354	.307	.230	.270	.141	2,530	480	.22
RS40NT	.500	.312	.312	.060	.472	.409	.325	.392	.156	4,290	810	.43
RS50NT	.625	.375	.400	.080	.591	.512	.406	.472	.200	7,050	1,430	.70
RS60NT	.750	.500	.469	.094	.713	.614	.506	.581	.234	9,920	1,980	1.03
RS80NT	1.000	.625	.625	.125	.949	.819	.640	.758	.312	17,640	3,300	1.79
RS100NT	1.250	.750	.750	.156	1.185	1.024	.778	.900	.375	26,460	5,070	2.68

Note: RS40NT ~ RS60NT are provided with clip type connecting links. RS80NT & RS100NT are cottered type. All other links are riveted.

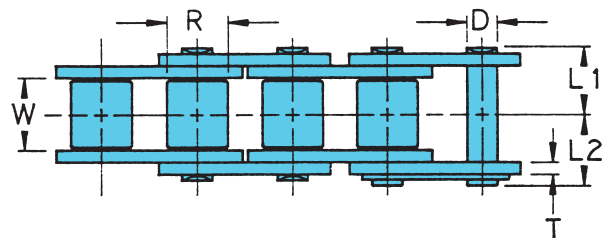
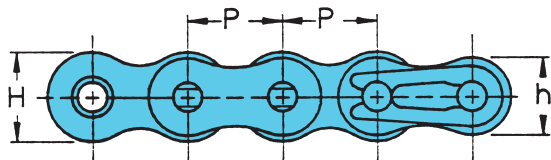

Double Pitch Conveyor Chain

U.S. TSUBAKI Chain Size	Pitch P	Width Between Roller Link Plates W	Roller Diameter R	Pin			Plate		Average Tensile Strength lbs.	Max. Allowable Load lbs.	Approx. Weight lbs./ft.
				L ₁	L ₂	D	H	T			
C2040NT	1.000	.312	.312	.325	.380	.156	.472	.060	3,740	590	.34
C2050NT	1.250	.375	.400	.406	.469	.200	.591	.080	6,170	970	.56
C2060HNT	1.500	.500	.469	.575	.646	.234	.677	.125	9,040	1,410	1.01
C2080HNT	2.000	.625	.625	.720	.823	.312	.906	.156	15,430	2,400	1.78

Note: C2040NT ~ C2060HNT are provided with clip type connecting links. C2080HNT is a cottered type. All other links are riveted.

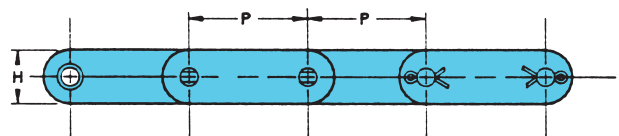
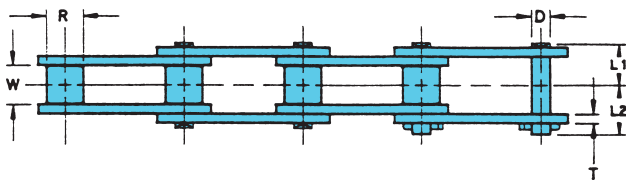

Standard Roller Type

U.S. TSUBAKI ANTI-CORROSIVE / HEAT RESISTANT CHAIN

A - DRIVE CHAINS

Nickel-Plated Chain

1. RS ROLLER CHAIN

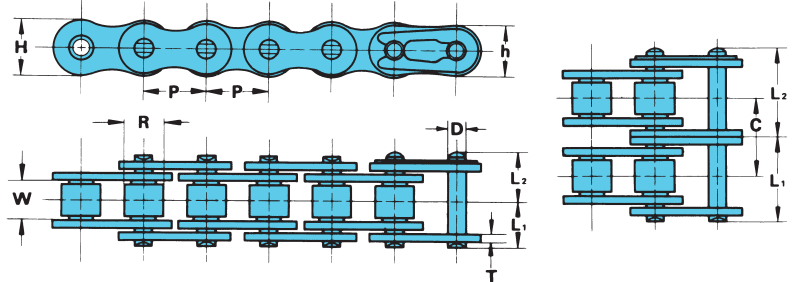

U.S. TSUBAKI Chain No.	Pitch P	Roller Diameter R	Width Between Roller Link Plates W	Pin			Link Plate			Transverse Pitch C	Average Tensile Strength lbs.	Maximum Allowable Load lbs.	Approx. Weight lbs./ft.
				D	L ₁	L ₂	T	H	h				
SINGLE STRAND													
▲ RS25NP ★	.250	.130	.125	.0905	.150	.189	.030	.230	.199	—	1,050	140	.094
▲ RS35NP ★	.375	.200	.188	.141	.230	.270	.050	.354	.307	—	2,500	350	.220
▲ RS41NP ★	.500	.306	.251	.141	.266	.312	.050	.382	.331	—	2,600	370	.270
▲ RS40NP ★	.500	.312	.312	.156	.325	.392	.060	.472	.409	—	4,250	660	.430
▲ RS50NP ★	.625	.400	.375	.200	.406	.472	.080	.591	.512	—	7,050	1,140	.700
▲ RS60NP	.750	.469	.500	.234	.506	.581	.094	.713	.614	—	9,900	1,630	1.030
▲ RS80NP	1.000	.625	.625	.312	.640	.758	.125	.949	.819	—	16,500	2,900	1.790
▲ RS100NP	1.250	.750	.750	.375	.778	.900	.156	1.185	1.024	—	25,500	4,100	2.680
▲ RS120NP	1.500	.875	1.000	.437	.980	1.138	.187	1.425	1.228	—	35,000	5,200	3.980
DOUBLE STRAND													
RS35NP-2	.375	.200	.188	.141	.439	.469	.050	.354	.307	.399	5,000	590	.460
RS40NP-2	.500	.312	.312	.156	.608	.675	.060	.472	.409	.566	8,500	1,120	.850
RS50NP-2	.625	.400	.375	.200	.762	.833	.080	.591	.512	.713	14,100	1,940	1.390
RS60NP-2	.750	.469	.500	.234	.955	1.053	.094	.713	.614	.897	19,800	2,800	2.040
RS80NP-2	1.000	.625	.625	.312	1.217	1.335	.125	.949	.819	1.153	32,500	4,900	3.540
RS100NP-2	1.250	.750	.750	.375	1.484	1.606	.156	1.185	1.024	1.408	51,000	7,000	5.270
RS120NP-2	1.500	.875	1.000	.437	1.874	2.031	.187	1.425	1.228	1.789	70,000	8,900	7.860

Note: ▲ Rollerless (bushing only) ★ Riveted only
 Double strand nickel-plated chains are also available.
 Attachment chain is available. Refer to Section "B" for dimensions.

2. BRITISH STANDARD CHAIN

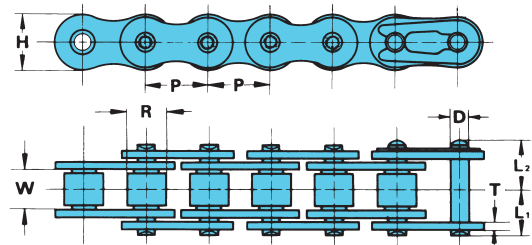

U.S. TSUBAKI Chain No.	ISO BS/DIN No.	Pitch P	Roller Diameter R	Width Between Roller Link Plates W	Pin			Link Plate Height (Max.) H	Average Tensile Strength lbs.	Bearing Area (Nominal) inch ²	Approx. Weight lbs./ft.
					D	L ₁	L ₂				
RF06BNP ★	06B	.375	.250	.225	.129	.255	.296	.323	2,310	.040	.26
RS08BNP	08B	.500	.335	.305	.175	.329	.395	.465	4,410	.078	.47
RS10BNP	10B	.625	.400	.380	.200	.370	.449	.579	5,840	.104	.64
RS12BNP	12B	.750	.475	.460	.225	.433	.520	.634	7,500	.138	.84
RS16BNP	16B	1.000	.625	.670	.326	.705	.783	.827	16,500	.326	1.82
RS20BNP	20B	1.250	.750	.770	.401	.791	.912	1.024	24,300	.457	2.59
RS24BNP	24B	1.500	1.000	1.000	.576	1.051	1.238	1.315	41,900	.859	5.01
RS28BNP	28B	1.750	1.100	1.220	.626	1.278	1.474	1.433	48,500	1.147	6.35
RS32BNP	32B	2.000	1.150	1.220	.701	1.264	1.484	1.661	63,100	1.257	6.89
RS40BNP	40B	2.500	1.550	1.500	.901	1.545	1.774	2.083	88,200	1.978	10.99

Note: ★ Flat shape link plate Double strand nickel-plated chains are also available.

3. DOUBLE PITCH CHAIN

RS Double Pitch Drive Chain



Double Pitch Conveyor Chain



STANDARD ROLLER TYPE



OVERSIZE ROLLER TYPE

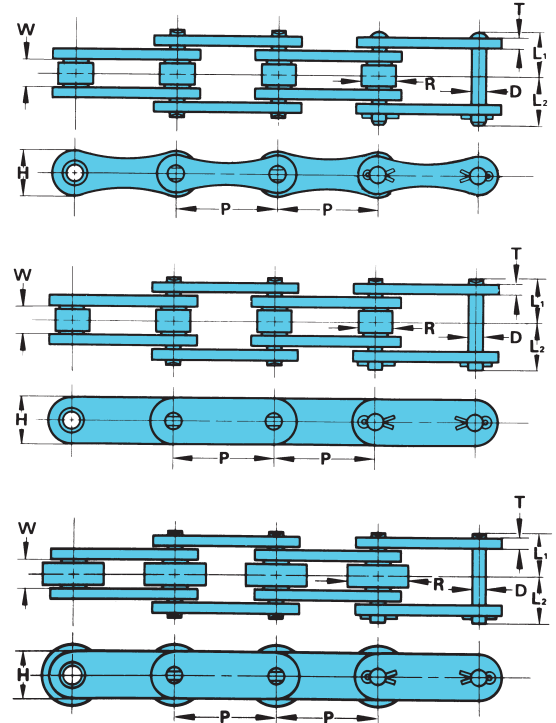

U.S. TSUBAKI Chain No.	Pitch P	Roller Diameter R	Width Between Roller Link Plates W	Pin			Link Plate		Average Tensile Strength lbs.	Approx. Weight lbs./ft.	No. of Links per 10 ft.
				D	L ₁	L ₂	T	H			
STANDARD ROLLER TYPE											
A2040NP	1.000	.312	.312	.156	.325	.380	.060	.472	3,700	.26	120
A2050NP	1.250	.400	.375	.200	.406	.469	.080	.591	6,100	.42	96
A2060NP	1.500	.469	.500	.234	.506	.581	.094	.709	8,500	.63	80
A2080NP	2.000	.625	.625	.312	.640	.758	.125	.906	14,500	1.03	60
STANDARD ROLLER TYPE											
C2040NP	1.000	.312	.312	.156	.325	.380	.060	.472	3,700	.34	120
C2050NP	1.250	.400	.375	.200	.406	.469	.080	.591	6,100	.56	96
C2060HNP	1.500	.469	.500	.234	.573	.652	.125	.677	9,000	1.01	80
C2080HNP	2.000	.625	.625	.312	.720	.823	.156	.906	15,400	1.78	60
C2100HNP	2.500	.750	.750	.375	.858	.965	.187	1.126	24,000	2.67	48
OVERSIZE ROLLER TYPE											
C2042NP	1.000	.625	.312	.156	.325	.380	.060	.472	3,700	.58	120
C2052NP	1.250	.750	.375	.200	.406	.469	.080	.591	6,100	.87	96
C2062HNP	1.500	.875	.500	.234	.573	.652	.125	.677	9,000	1.47	80
C2082HNP	2.000	1.125	.625	.312	.720	.823	.156	.906	15,400	2.47	60
C2102HNP	2.500	1.562	.750	.375	.858	.965	.187	1.126	24,000	4.23	48

Note: Attachment chain is available. Refer to Section "B" for dimensions.

Spring clip type connecting links will be provided for A2040NP~A2060NP, C2040NP~C2060HNP and C2042NP~C2062HNP.

U.S. TSUBAKI ANTI-CORROSIVE / HEAT RESISTANT CHAIN

Stainless Steel Chain

1. RS ROLLER CHAIN



- Available in **304 SS SERIES**
- 316 NS SERIES**
- 600 AS SERIES**

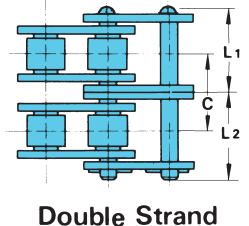
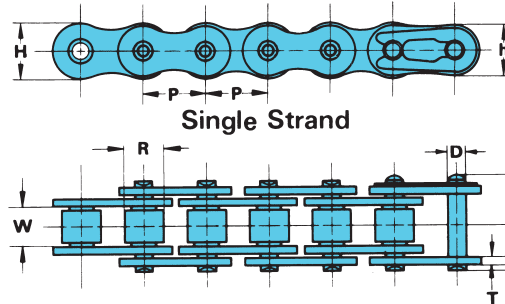

Double Strand

Dimensions in inches

SS • NS • AS Dimensions

Specifications			Pitch P	Width Between Roller Link Plates W	Roller Dia. R	Link Plate		Pin Dia. D	Pin				Maximum Allowable Load lbs.	Approx. Weight lbs./ft.	
SS	NS	AS				T	H		SS•NS•LS		AS				
								L ₁	L ₂	L ₁	L ₂	SS•NS	AS		
RS25SS▲	RS25NS▲	—	.250	.125	.130	.030	.230	.090	.150	.189			26	.09	
RS35SS▲	RS35NS▲	RS35AS▲	.375	.188	.200	.050	.354	.141	.238	.281	.238	.281	60	91	.22
RS40SS	RS40NS	RS40AS	.500	.312	.312	.060	.472	.156	.325	.380	.325	.392	99	150	.43
RS50SS	RS50NS	RS50AS	.625	.375	.400	.080	.591	.200	.406	.469	.406	.472	154	231	.70
RS60SS	RS60NS	RS60AS	.750	.500	.469	.094	.713	.234	.506	.600	.506	.581	231	346	1.03
RS80SS	RS80NS	RS80AS	1.000	.625	.625	.125	.949	.312	.638	.768	.638	.768	397	596	1.79
RS100SS	—	—	1.250	.750	.750	.156	1.185	.375	.791	.909			573		2.69

▲ Rollerless

Note: Attachment chain is available. Refer to Section "B" for dimensions.
Titanium Series chain available in sizes RS35-RS60.
Double strand chains are available.

2. DOUBLE PITCH CONVEYOR CHAIN

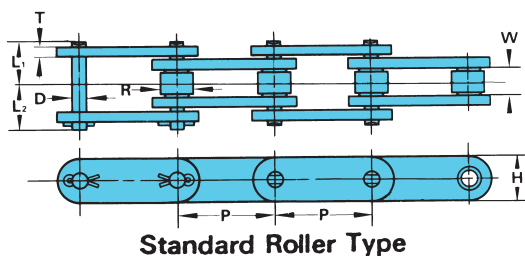

Standard Roller Type

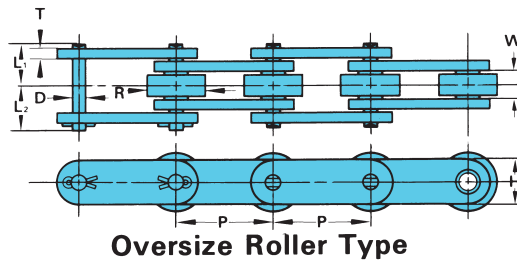

Oversize Roller Type

U.S. TSUBAKI Chain No.	Pitch P	Roller Diameter R	Width Between Roller Link Plates W	Pin			Link Plate		Maximum Allowable Load lbs.	Approx. Weight lbs./ft.
				D	L ₁	L ₂	T	H		
STANDARD ROLLER TYPE										
C2040AS	1.000	.312	.312	.156	.325	.380	.060	.472	150	.34
C2050AS	1.250	.400	.375	.200	.406	.469	.080	.591	231	.56
C2060HAS	1.500	.469	.500	.234	.573	.652	.125	.677	346	1.01
C2080HAS	2.000	.625	.625	.312	.720	.823	.156	.906	596	1.62
OVERSIZE ROLLER TYPE										
C2042AS	1.000	.625	.312	.156	.325	.380	.060	.472	150	.58
C2052AS	1.250	.750	.375	.200	.406	.469	.080	.591	231	.87
C2062HAS	1.500	.875	.500	.234	.573	.652	.125	.677	346	1.47
C2082HAS	2.000	1.125	.625	.312	.720	.823	.156	.906	596	2.37

Note: 1. Material of oversize roller is 304 stainless steel.
2. Attachment chain is available. Refer to Section "B" for dimensions.

3. BS/DIN ROLLER CHAIN

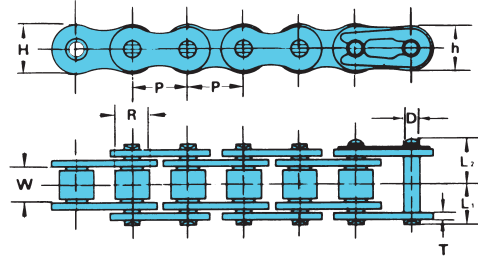

U.S. TSUBAKI Chain No.	ISO BS/DIN No.	Pitch P	Roller Diameter R	Width Between Roller Link Plates		Pin		Link Plate		Average Tensile Strength lbs.	Bearing Area (Nominal) inch ²	Approx. Weight lbs./ft.
				W	D	L ₁	L ₂	T	H			
RF06BSS ★	06B	.375	.250	.225	.129	.255	.296	.050	.323	1,430	.040	.26
RS08BSS	08B	.500	.335	.305	.175	.329	.395	.060	.465	2,200	.078	.47
RS10BSS	10B	.625	.400	.380	.200	.370	.449	.060	.579	3,190	.104	.64
RS12BSS	12B	.750	.475	.460	.225	.433	.520	.070	.634	3,740	.138	.84
RS16BSS	16B	1.000	.625	.670	.326	.705	.783	.156	.827	10,560	.326	1.82

Note: ★ Flat shape link plate Stainless steel roller chains with over 1.00 inch pitch are also available upon request. Double-strand and triple-strand are also available.

4. DOUBLE PITCH CHAIN

RS Double Pitch Drive Chain



Double Pitch Conveyor Chain

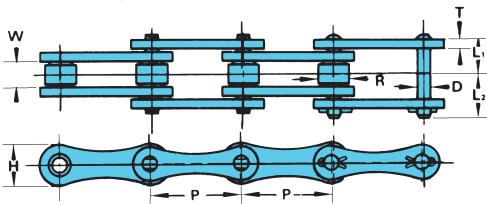

STANDARD ROLLER TYPE



OVERSIZE ROLLER TYPE

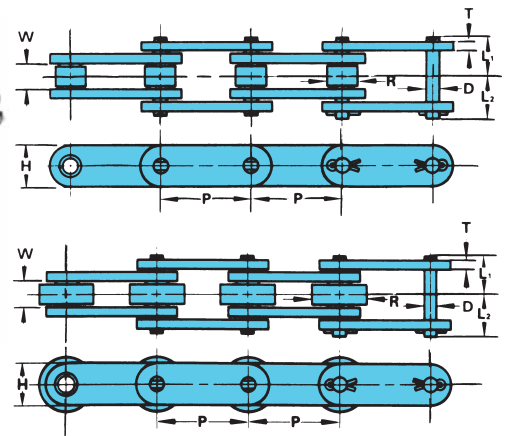

U.S. TSUBAKI Chain No.	Pitch P	Roller Diameter R	Width Between Roller Link Plates		Pin		Link Plate		Maximum Allowable Load lbs.	Approx. Weight lbs./ft.	No. of Links per 10 ft.
			W	D	L ₁	L ₂	T	H			
RS DOUBLE PITCH DRIVE CHAIN											
A2040SS	1.000	.312	.312	.156	.325	.380	.060	.472	99	.26	120
A2050SS	1.250	.400	.375	.200	.406	.469	.080	.591	154	.42	96
A2060SS	1.500	.469	.500	.234	.506	.600	.094	.709	231	.63	80
A2080SS	2.000	.625	.625	.312	.640	.758	.125	.906	397	1.03	60
DOUBLE PITCH CONVEYOR CHAIN STANDARD ROLLER											
C2040SS	1.000	.312	.312	.156	.325	.380	.060	.472	99	.34	120
C2050SS	1.250	.400	.375	.200	.406	.469	.080	.591	154	.56	96
C2060HSS	1.500	.469	.500	.234	.573	.652	.125	.677	231	1.01	80
C2080HSS	2.000	.625	.625	.312	.720	.823	.156	.906	397	1.62	60
DOUBLE PITCH CONVEYOR CHAIN OVERSIZE ROLLER											
C2042SS	1.000	.625	.312	.156	.325	.380	.060	.472	99	.58	120
C2052SS	1.250	.750	.375	.200	.406	.469	.080	.591	154	.87	96
C2062HSS	1.500	.875	.500	.234	.573	.652	.125	.677	231	1.47	80
C2082HSS	2.000	1.125	.625	.312	.720	.823	.156	.906	397	2.37	60

Note: 600 Series stainless steel chains are also available.
Attachment chain is available. Refer to Section "B" for dimensions.
Spring clip type connecting links will be provided for A2040SS~A2060SS, C2040SS~C2060HSS and C2042SS~C2062HSS.

U.S. TSUBAKI ANTI-CORROSIVE / HEAT RESISTANT CHAIN

Poly-Steel Chain

U.S. Tsubaki Poly-Steel chains are made to exacting specifications from polyacetal stainless steel.

The combination of polyacetal inner links and 304 stainless steel pins and outer link plates effectively incorporates the advantages of both materials into one chain. U.S. Tsubaki Poly-Steel chains can be used in both driving and conveying applications.

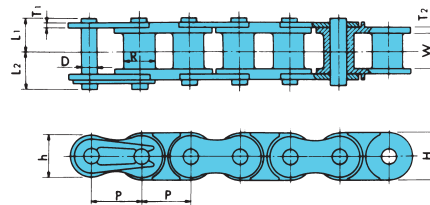
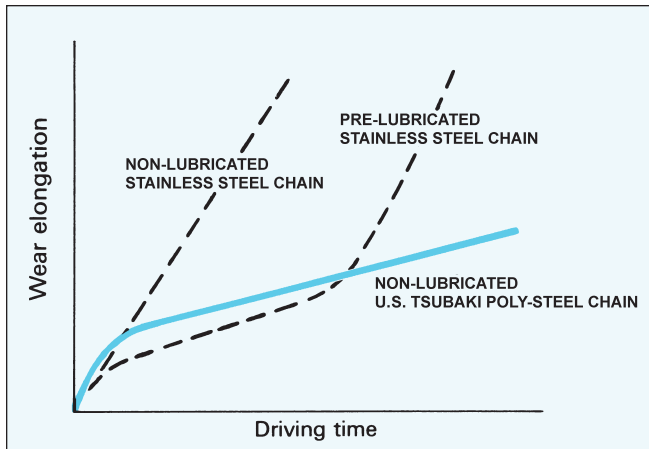

U.S. TSUBAKI Chain No.	Pitch P	Bushing Diameter B	Width Between Roller Link Plates W	Link Plate				Pin			Maximum Allowable Load lbs.	Approx. Weight lbs./ft.	Color
				T ₁	T ₂	H	h	D	L ₁	L ₂			
RF25PC	.250	.130	.125	.030	.051	.236	.199	.091	.177	.217	18	.06	Brown
RF35PC	.375	.200	.188	.050	.087	.354	.307	.141	.270	.309	40	.15	Brown
RF40PC	.500	.312	.312	.060	.060	.472	.409	.156	.325	.392	99	.26	Brown
RF50PC	.625	.400	.375	.080	.080	.591	.512	.200	.406	.472	154	.39	Brown
RF60PC	.750	.469	.500	.094	.094	.713	.614	.234	.506	.581	198	.55	Brown

Additional Information

- Offset links are not available. Please use an even number of links.
- Existing RS standard sprockets can be used.
- RF40PC to RF60PC use the same connecting links as stainless steel chain. RF25PC and RF35PC use special connecting links.
- When replacing stainless steel chain with Poly-Steel chain, please check the chain tension. Chain tension should be less than the maximum allowable tension.
- Ambient temperature range: -14°F ~ 176°F (-10°C ~ 80°C)
- Maximum chain speed: less than 230 ft./min.
- Coefficient of sliding friction between chain and guide rail is 0.25 (without lubrication).
- The guide rail should support the bottom side of the links.
- The color of the inner links is WHITE.

Connecting and Disconnecting

1. Disconnect as follows:

As shown in the drawing, place the pin link plate on the jig and press down on the pin heads. Please be careful not to apply too much pressure to the plastic portion as there is the possibility of breakage.

2. Please inquire about our disconnecting jig.

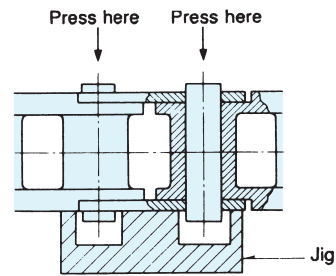

3. For connecting, please use a connecting link.

Corrosion Resistance Guide

1. Highly corrosion resistant
2. Partially corrosion resistant
3. Not corrosion resistant

Substance	Concentration	Temp. °F	AS	SS	NS	TI	PC	PC-SY
Acetic Acid	10%	68	1	1	1	1	1	1
Acetone		68	1	1	1	1	1	3
Alcohol			1	1	1	1	1	1
Aluminum Sulfate	Saturation	68	3	1	1	1	—	—
Ammonia Water		68	1	1	1	1	1	1
Ammonium Chloride	50%	Boiling	3	2	1	1	—	—
Ammonium Nitrate		Boiling	1	1	1	1	2	1
Ammonium Sulfate	Saturation	Boiling	2	1	1	1	—	—
Beer		68	1	1	1	1	1	1
Benzene		68	1	1	1	1	1	1
Boric Acid	50%	Boiling	1	1	1	1	—	—
Butyric Acid		68	1	1	1	1	1	—
Calcium Chloride	Saturation	68	3	2	1	1	2	1
Calcium Hydroxide	20%	Boiling	1	1	1	1	1	1
Calcium Hypochlorite	11-14%	68	3	1	1	1	3	1
Carbolic Acid			1	1	1	1	3	1
Carbon Tetrachloride (dry)		68	1	1	1	1	1	1
Chlorinated Water			3	3	1	1	3	—
Chlorine Gas (dry)		68	3	2	2	1	—	1
Chlorine Gas (moist)		68	3	3	2	1	—	1
Chromic Acid	5%	68	2	1	1	1	3	1
Citric Acid	50%	68	1	1	1	1	—	1
Coffee		Boiling	1	1	1	1	1	1
Creosote		68	1	1	1	1	—	—
Developing Solution		68	2	1	1	1	1	1
Ethyl Ether		68	1	1	1	1	1	1
Ferric Acid	50%	68	1	1	1	1	3	1
Ferric Chloride	5%	68	3	2	2	1	—	—
Formalin	40%	68	1	1	1	1	—	—
Formic Acid	50%	68	1	1	1	1	3	1
Fruit Juice		68	2	1	1	1	1	1
Gasoline		68	1	1	1	1	1	1
Glycerol		68	1	1	1	1	1	1
Honey			1	1	1	1	1	1
Hydrochloric Acid	2%	68	3	3	3	1	3	1
Hydrogen Peroxide	30%	68	2	1	1	1	3	1
Hydrogen Sulfide (dry)			1	1	1	1	1	1
Hydrogen Sulfide (wet)			3	3	3	1	3	—
Hydroxybenzene		68	1	1	1	1	3	—
Kerosene		68	1	1	1	1	—	—
Ketchup		68	1	1	1	1	1	1
Lactic Acid	10%	68	2	1	1	1	1	1
Lard			1	1	1	1	—	—
Linseed Oil	100%	68	2	1	1	1	1	—
Malic Acid	50%	Boiling	1	1	1	1	1	1
Mayonnaise		68	2	1	1	1	1	1
Milk		68	1	1	1	1	1	1

Substance	Concentration	Temp. °F	AS	SS	NS	TI	PC	PC-SY
Nitric Acid	5%	68	2	1	1	1	3	1
Nitric Acid	65%	68	3	1	1	1	3	1
Nitric Acid	65%	Boiling	3	2	2	1	3	3
Oil (Plant, Mineral)		68	1	1	1	1	1	1
Oleic Acid		68	1	1	1	1	1	—
Oxalic Acid	10%	68	2	1	1	1	—	1
Paraffin		68	1	1	1	1	1	—
Petroleum		68	1	1	1	1	1	1
Phosphate			1	1	1	1	—	—
Phosphoric Acid	5%	68	2	1	1	1	3	1
Phosphoric Acid	10%	68	2	2	2	1	3	1
Picric Acid	Saturation	68	1	1	1	1	—	—
Potassium	Saturation	68	2	1	1	1	—	—
Potassium Bichromate	10%	68	1	1	1	1	1	—
Potassium Chloride	Saturation	68	2	1	1	1	—	—
Potassium Hydroxide	20%	68	1	1	1	1	1	1
Potassium Nitrate	25%	68	1	1	1	1	1	—
Potassium Nitrate	25%	Boiling	3	1	1	1	—	—
Potassium Permanganate	Saturation	68	1	1	1	1	—	1
Sal Ammoniac	50%	Boiling	3	2	1	1	—	—
Sea-Water		68	3	2	1	1	2	1
Soap-and-Water-Solution		68	1	1	1	1	1	—
Sodium Carbonate	Saturation	Boiling	1	1	1	1	—	—
Sodium Chloride	5%	68	2	1	1	1	1	1
Sodium Cyanide		68	—	1	1	1	—	—
Sodium Hydrocarbonate		68	1	1	1	1	1	1
Sodium Hydroxide	25%	68	1	1	1	1	1	—
Sodium Hypochlorite	10%	68	3	3	1	1	3	1
Sodium Perchlorate	10%	Boiling	3	1	1	1	—	—
Sodium Sulfate	Saturation	68	1	1	1	1	—	—
Sodium Thiosulfate	25%	Boiling	1	1	1	1	—	—
Soft Drink		68	1	1	1	1	1	1
Stearic Acid	100%	Boiling	3	3	1	1	3	—
Sugar Solution		68	1	1	1	1	1	1
Sulfuric Acid	5%	68	3	3	1	1	3	1
Sulfur Dioxide		68	3	1	1	1	—	—
Synthetic Detergent			1	1	1	1	1	1
Syrup			1	1	1	1	1	1
Tartaric Acid	10%	68	1	1	1	1	1	1
Turpentine		95	1	1	1	1	—	1
Varnish			1	1	1	1	—	1
Vegetable Juice		68	1	1	1	1	1	1
Vinegar		68	3	2	1	1	2	1
Water			1	1	1	1	1	1
Whiskey		68	1	1	1	1	1	1
Wine		68	1	1	1	1	1	1
Zinc Chloride	50%	68	3	2	2	1	2	1
Zinc Sulfate	25%	68	1	1	1	1	—	1

Key: AS: 600 AS Series NS: 316 NS Series PC: Poly-Steel Chain
 SS: 304 SS Series TI: Titanium TI Series PC-SY: Poly-Steel Anti-Chemical Series

Note: For information on the corrosion resistance of LS Series Chain, please consult U.S. Tsubaki Engineering.

U.S. TSUBAKI ENGINEERING INFORMATION & CHAIN SELECTION

MATERIALS OF COMPONENT PARTS

	Link Plate	Pin	Bushing	Roller
AS Series	AISI 304	Special (13-7PH)	ASTM631-HT (17-7PH)	ASTM631-HT (17-7PH)
SS Series	AISI 304	AISI 304	AISI 304	AISI 304
NS Series	AISI 316	AISI 316	AISI 316	AISI 316

PH: Precipitation Hardened
 The corrosion resistance of special 13-7 PH is equal to that of 17-7 PH.

PERFORMANCE OF ANTI-CORROSIVE CHAINS

	Corrosion Resistance	Temperature Resistance	Magnetism	Wear Resistance
NP Chain	Acceptable for outdoor and decorative applications	14°F~140°F (Never use below -4°F or over 300°F)	Magnetic	Excellent
NEPTUNE® Chain	Excellent for outdoors, exposure to rain, and seawater	14°F~140°F	Magnetic	Excellent
AS Series	Good for general acid, alkali and water	-40°F~750°F (Never use over 930°F)	Magnetic	Good
SS Series	Good for general acid, alkali and water	-40°F~750°F (Never use below -270°F or over 1300°F)	Slightly magnetic due to cold forming of parts	Fair
NS Series	Superior to SS & AS	-40°F~750°F (Never use below -420°F or over 1500°F)	Non-magnetic	Fair

CHAIN SELECTION

General selection is based on bearing pressure between the pin and bushing. Anti-corrosive roller chains are normally intended to be used at slow speed without lubrication. Chain selection should be made based on the bearing pressure as shown below.

	Maximum Allowable Bearing Pressure Between Pin and Bushing	Maximum Operating Speed
AS Series	2,130 psi	230 ft./min.
SS Series	1,420 psi	230 ft./min.
NS Series	1,420 psi	230 ft./min.

Chain selection can be made using the following formula.

$$\boxed{\text{Maximum Chain Tension}} \times \boxed{\text{Service Factor}} \times \boxed{\text{Speed Coefficient}} \times \boxed{\text{Temperature Factor}} \leq \boxed{\text{Maximum Allowable Load}}$$

Maximum allowable load or maximum bearing pressure as shown above can be doubled only when chain is used in group "1" of the "Corrosion Resistance Guide" on page A-60 and properly lubricated.

■ MAXIMUM ALLOWABLE LOAD

The chain's maximum allowable load can be obtained by the formula:
(Maximum allowable bearing pressure) • (Bearing area between pin and bushing).

	AS Series	SS Series	NS Series
RS25	—	26 lbs.	26 lbs.
RS35	90 lbs.	60 lbs.	60 lbs.
RS40	150 lbs.	99 lbs.	99 lbs.
RS50	231 lbs.	154 lbs.	154 lbs.
RS60	346 lbs.	231 lbs.	231 lbs.
RS80	596 lbs.	397 lbs.	397 lbs.
RS100	—	573 lbs.	573 lbs.

■ SERVICE FACTOR

Type of Impact	Service Factor
Smooth transmission	1.0
Transmission with some impact	1.3
Transmission with large impact	1.5

■ SPEED COEFFICIENT

Chain Speed	Speed Coefficient
0 ~ 50 ft./min.	1.0
50 ~ 100 ft./min.	1.2
100 ~ 160 ft./min.	1.4
160 ~ 230 ft./min.	1.6

■ TEMPERATURE FACTOR*

Temperature	AS Series	SS Series	NS Series
~ -270°F	X	X	X
-270°F ~ -40°F	X	1.0	1.0
-40°F ~ 750°F	1.0	1.0	1.0
750°F ~ 930°F *	1.8	1.2	1.0
930°F ~ 1,100°F *	X	1.5	1.2
1,100°F ~ 1,300°F *	X	1.8	1.5
1,300°F ~ 1,500°F*	X	X	2.0
1,500°F ~ *	X	X	X

X: Not suggested.

* Use in temperatures exceeding 750°F requires increased clearances to accommodate thermal expansion. Consult U.S. Tsubaki prior to ordering.

Leaf Chain



Leaf chains generally have greater tensile strength than roller chains, and run over sheaves rather than sprockets. They are most often used as counterweight chains for machine tools, elevator and oven doors, fork lift truck masts, spinning frames and similar lifting or balancing applications. BL series can, in most instances, replace the older AL series Leaf chains; consult U.S. Tsubaki for interchange information.

These chains are supplied with male or female terminations to allow addition of various clevises as desired.

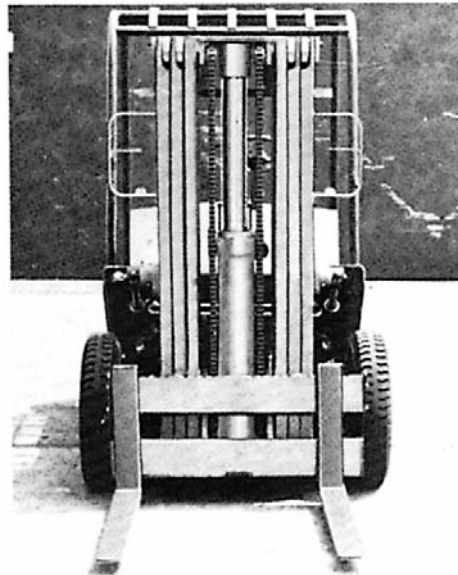

AL Series

New applications should use BL series chain. AL series was removed from the A.N.S.I. B29.8 Leaf chain standard in 1975.

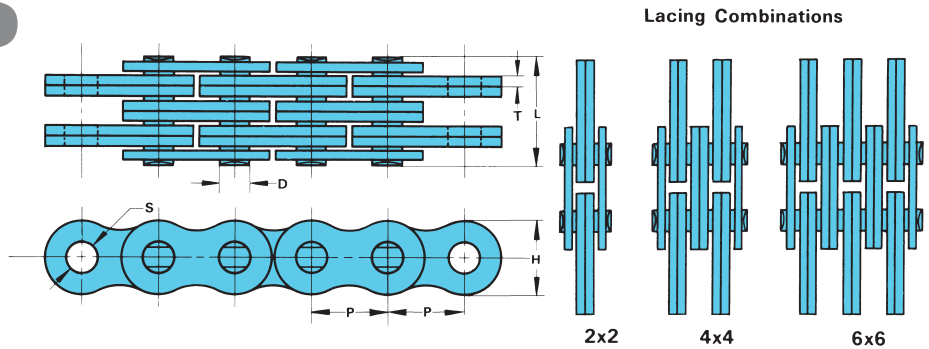

U.S. TSUBAKI Chain No.	Pitch P	Lacing	Min. Tensile Strength lbs.	Pin		Link Plate		Hole Dia. (min.) S	Approx. Weight lbs./ft.
				D	L	T	H		
AL422	.500	2x2	3,700	.156	.331	.060	.409	.1578	.25
AL444	.500	4x4	7,500	.156	.585	.060	.409	.1578	.50
AL466	.500	6x6	11,200	.156	.839	.060	.409	.1578	.74
AL522	.625	2x2	6,200	.200	.427	.080	.512	.2019	.42
AL544	.625	4x4	12,300	.200	.762	.080	.512	.2019	.82
AL566	.625	6x6	18,500	.200	1.094	.080	.512	.2019	1.21
AL622	.750	2x2	8,600	.234	.498	.094	.614	.2362	.58
AL644	.750	4x4	17,200	.234	.888	.094	.614	.2362	1.15
AL666	.750	6x6	25,800	.234	1.278	.094	.614	.2362	1.70
AL822	1.000	2x2	14,600	.311	.644	.125	.819	.3138	1.01
AL844	1.000	4x4	29,100	.311	1.173	.125	.819	.3138	2.00
AL866	1.000	6x6	43,600	.311	1.701	.125	.819	.3138	2.97
AL1022	1.250	2x2	22,000	.373	.789	.156	1.024	.3768	1.80
AL1044	1.250	4x4	44,000	.373	1.445	.156	1.024	.3768	3.56
AL1066	1.250	6x6	66,000	.373	2.098	.156	1.024	.3768	5.31
AL1222	1.500	2x2	31,700	.437	.953	.187	1.228	.4386	2.39
AL1244	1.500	4x4	63,400	.437	1.732	.187	1.228	.4386	4.75
AL1266	1.500	6x6	95,000	.437	2.514	.187	1.228	.4386	7.07
AL1444	1.750	4x4	83,600	.500	2.020	.219	1.433	.5016	6.95
AL1466	1.750	6x6	125,400	.500	2.935	.219	1.433	.5016	10.18
AL1644	2.000	4x4	105,800	.562	2.285	.250	1.638	.5638	8.70
AL1666	2.000	6x6	158,000	.562	3.325	.250	1.638	.5638	13.00

Non-Standard Chain

U.S. TSUBAKI Chain No.	Pitch P	Lacing	Min. Tensile Strength lbs.	Pin		Link Plate		Hole Dia. (min.) S	Approx. Weight lbs./ft.
				D	L	T	H		
BL532 (6H-5)	.625	3x2	7,000	.187	.583	.094	.590	.189	.79

NOTE: BL532 is available only as a replacement chain and should not be specified for new applications or designs.

U.S. TSUBAKI LEAF CHAIN

A - DRIVE CHAINS

BL Series

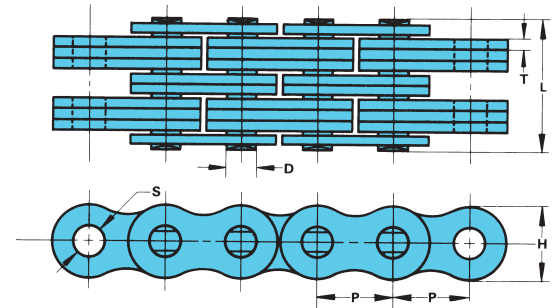
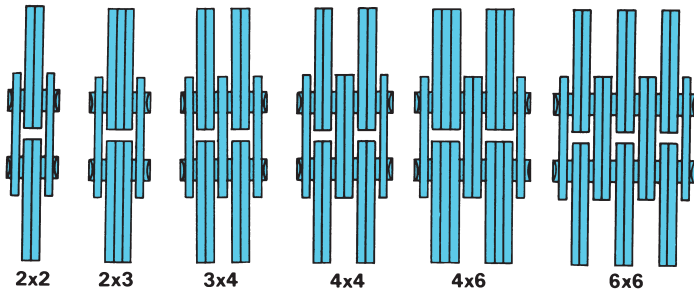

U.S. TSUBAKI Chain No.	Pitch P	Lacing	Min. Tensile Strength lbs.	ANSI Min. Tensile Strength lbs.	Pin		Link Plate		Hole Dia. (min.)	Approx. Weight lbs./ft.
					D	L	T	H		
BL422	.500	2x2	5,300	5,000	.200	.427	.080	.472	.2019	.46
BL423	.500	2x3	5,300	5,000	.200	.510	.080	.472	.2019	.56
BL434	.500	3x4	7,900	7,500	.200	.677	.080	.472	.2019	.76
BL444	.500	4x4	10,600	10,000	.200	.764	.080	.472	.2019	.86
BL446	.500	4x6	10,600	10,000	.200	.929	.080	.472	.2019	1.11
BL466	.500	6x6	15,600	15,000	.200	1.094	.080	.472	.2019	1.32
BL522	.625	2x2	8,800	7,500	.234	.498	.094	.591	.2362	.72
BL523	.625	2x3	8,800	7,500	.234	.594	.094	.591	.2362	.85
BL534	.625	3x4	13,200	11,000	.234	.791	.094	.591	.2362	1.14
BL544	.625	4x4	17,600	15,000	.234	.888	.094	.591	.2362	1.27
BL546	.625	4x6	17,600	15,000	.234	1.083	.094	.591	.2362	1.61
BL566	.625	6x6	26,400	22,500	.234	1.278	.094	.591	.2362	1.88
BL622	.750	2x2	14,300	11,000	.312	.645	.125	.713	.3138	1.13
BL623	.750	2x3	14,300	11,000	.312	.778	.125	.713	.3138	1.37
BL634	.750	3x4	21,500	17,000	.312	1.041	.125	.713	.3138	1.90
BL644	.750	4x4	28,500	22,000	.312	1.173	.125	.713	.3138	2.14
BL646	.750	4x6	28,500	22,000	.312	1.437	.125	.713	.3138	2.69
BL666	.750	6x6	43,000	33,000	.312	1.701	.125	.713	.3138	3.18
BL822	1.000	2x2	23,100	19,000	.375	.794	.156	.949	.3768	1.74
BL823	1.000	2x3	23,100	19,000	.375	.953	.156	.949	.3768	2.15
BL834	1.000	3x4	34,800	29,000	.375	1.281	.156	.949	.3768	2.98
BL844	1.000	4x4	46,200	38,000	.375	1.453	.156	.949	.3768	3.39
BL846	1.000	4x6	46,200	38,000	.375	1.772	.156	.949	.3768	4.25
BL866	1.000	6x6	69,500	57,000	.375	2.098	.156	.949	.3768	5.07
BL1022	1.250	2x2	31,700	26,000	.437	.944	.187	1.185	.4386	2.53
BL1023	1.250	2x3	31,700	26,000	.437	1.138	.187	1.185	.4386	3.15
BL1034	1.250	3x4	48,500	41,000	.437	1.530	.187	1.185	.4386	4.40
BL1044	1.250	4x4	63,400	52,000	.437	1.708	.187	1.185	.4386	5.03
BL1046	1.250	4x6	63,400	52,000	.437	2.114	.187	1.185	.4386	6.24
BL1066	1.250	6x6	95,200	78,000	.437	2.514	.187	1.185	.4386	7.50
BL1222	1.500	2x2	41,800	34,000	.500	1.104	.219	1.425	.5016	3.25
BL1223	1.500	2x3	41,800	34,000	.500	1.335	.219	1.425	.5016	4.39
BL1234	1.500	3x4	67,200	55,000	.500	1.791	.219	1.425	.5016	6.11
BL1244	1.500	4x4	83,600	68,000	.500	2.020	.219	1.425	.5016	6.98
BL1246	1.500	4x6	83,600	68,000	.500	2.478	.219	1.425	.5016	8.07
BL1266	1.500	6x6	125,600	102,000	.500	2.936	.219	1.425	.5016	9.80
BL1422	1.750	2x2	52,900	43,000	.562	1.245	.250	1.661	.5638	4.91
BL1423	1.750	2x3	52,900	43,000	.562	1.504	.250	1.661	.5638	6.09
BL1434	1.750	3x4	87,000	71,000	.562	2.024	.250	1.661	.5638	7.61
BL1444	1.750	4x4	105,800	86,000	.562	2.285	.250	1.661	.5638	8.71
BL1446	1.750	4x6	105,800	86,000	.562	2.805	.250	1.661	.5638	12.10
BL1466	1.750	6x6	158,700	130,000	.562	3.325	.250	1.661	.5638	15.13
BL1622	2.000	2x2	79,300	65,000	.687	1.401	.281	1.898	.6886	6.61
BL1623	2.000	2x3	79,300	65,000	.687	1.703	.281	1.898	.6886	8.17
BL1634	2.000	3x4	124,500	99,000	.687	2.299	.281	1.898	.6886	11.39
BL1644	2.000	4x4	158,600	130,000	.687	2.593	.281	1.898	.6886	12.75
BL1646	2.000	4x6	158,600	130,000	.687	3.191	.281	1.898	.6886	16.19
BL1666	2.000	6x6	238,300	195,030	.687	3.785	.281	1.898	.6886	19.31
BL2022	2.500	2x2	119,000	97,500						
BL2023	2.500	2x3	119,000	97,500						
BL2034	2.500	3x4	178,800	146,000						
BL2044	2.500	4x4	238,500	195,000						
BL2046	2.500	4x6	238,500	195,000						
BL2066	2.500	6x6	357,800	292,500						

CONSULT U.S. TSUBAKI ENGINEERING

AL Series, BL Series

SELECTION

Step 1

From the Application Table below, determine the type of chain and service factor.

Application Table

Type of Chain	Shock	Applications	Service Factor	Chain Speed ft./min.
AL series	Moderate	Suspension of counterweights	1.0	Less than 100
AL and BL series		Fork lift	1.3	
BL series	Heavy	Mining machinery Construction equipment	1.5	

Step 2

Multiply the required working load by the service factor and safety factor below to obtain the design tensile strength.

Safety Factor

Type of Chain	Safety Factor	Chain Speed ft./min.	Maximum Number of Reciprocations
AL series	12	Less than 100	Less than 100 per day
BL series	9	Less than 100	Less than 1,000 per day

Step 3

From the chain list, select a chain having a tensile strength not less than that obtained in Step 2.

$$\boxed{\text{Working Load}^*} \times \boxed{\text{Service Factor}} \times \boxed{\text{Safety Factor}} \leq \boxed{\text{Minimum Tensile Strength}}$$

*Working Load including weights of attachments, inertia force and impact force.

When ordering, specify your requirements.

- For odd numbers of pitches inner links at both ends will be provided as standard.
- For even numbers of pitches a clevis connector or press fit and rivet outer link can be furnished.
- Clevis connector or press fit and rivet outer links are both available from stock in popular sizes.

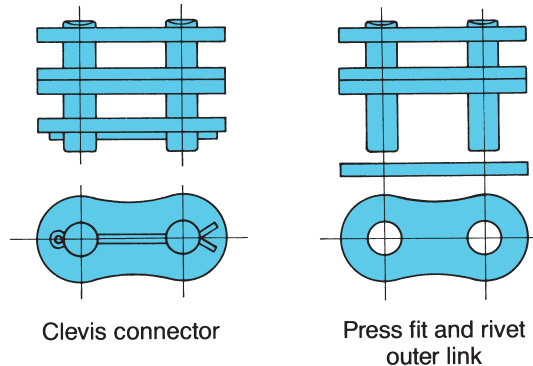

Connection with Clevis:

1. When an inner link is used for the end, a clevis pin is normally supplied by the clevis manufacturer.
2. When an outer link is used for the end, the press fit outer link provides the most integrity.



U.S. TSUBAKI LEAF CHAIN

TYPICAL APPLICATIONS

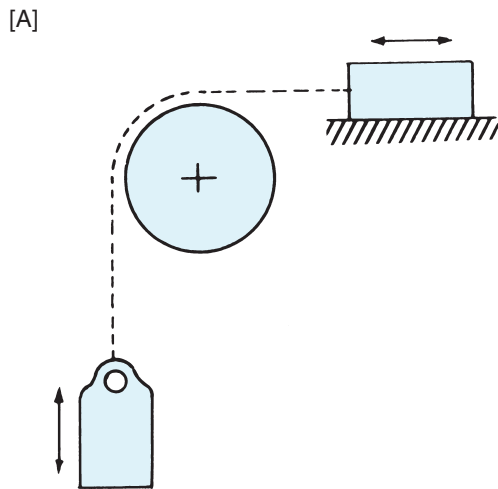

For counterweights of heavy machine tools — planers, multi-spindle drills, etc.

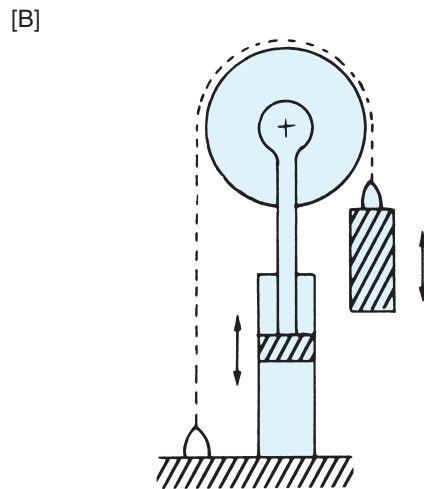

For increasing the travel distance on hydraulic lifts.

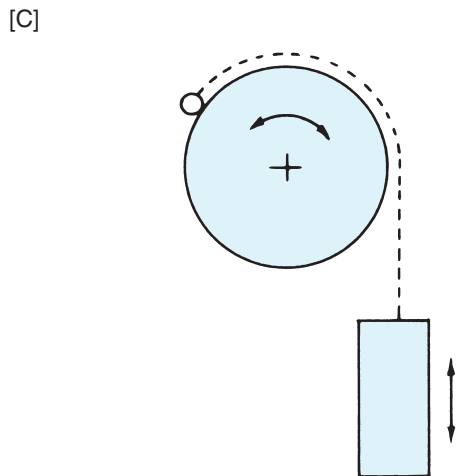

For suspension of a counterweight for the arm of drills or similar machine tool elements.

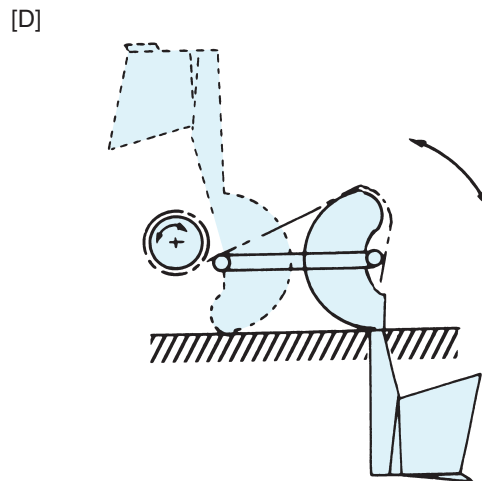

For transmitting reciprocating motion or lift.

GENERAL CAUTIONS

1. Use lengths of factory assembled chain. Do not build lengths from individual components.
2. Do not attempt to rework damaged chains by replacing only the components obviously faulty. The entire chain may be compromised and should be discarded.
3. Never electroplate assembled Leaf chain or its components. Plating could result in failure from hydrogen embrittlement.
4. Welding should not be performed on any chain or component. Welding spatter should never be allowed to come in contact with chain or components.
5. Leaf chains are manufactured exclusively from heat treated steels and, therefore, must not be annealed. If heating a chain with a cutting torch is absolutely necessary for removal, the chain should not be reused.
6. Joining chains together should only be done by the chain manufacturer.
7. The Minimum Ultimate Strength of a chain means the minimum load at which it will break when subjected to a destructive tensile test. It does not mean working load.
8. Chains from different manufacturers should not be used in the same application.

Specialty Chain

U.S. Tsubaki Specialty Chain

U.S. Tsubaki is the world leader in providing specialty chains for the most demanding applications. In addition to industry leading made-to-order capabilities, U.S. Tsubaki offers a number of “standard” specialty chains.

- **Lube-Free chain** — High quality lubricant is impregnated into the sintered metal bushings for applications where normal lubrication is not practical.
- **FX chain** — Increased clearance between pins and bushings allows for added chain flexibility with excellent durability.
- **Rollerless chain** — Designed and manufactured to withstand continued wearing.
- **Wrench chain** — Extra long pins serve as tension linkages to provide a secure hold for pipe wrenches.
- **Laminated Block chain** — Manufactured with 304 stainless steel, it directly replaces solid block chain in light load, low speed applications.
- **Agriculture chain** — With higher tensile strength, longer life, and smoother operation than malleable chains, U.S. Tsubaki offers MR and RF types for agriculture applications.



Lube-Free Chain



For use where normal lubrication is not practical, i.e., food processing equipment, packaging machines, printing and binding equipment, and textile machines.

High quality lubricant is impregnated into the sintered metal bushings. Joint movement between the pin and bushing releases the necessary volume of oil to the pin surface and other parts, thereby minimizing chain elongation and eliminating the risk of chain seizure from insufficient lubrication.

See our Drive Series LAMBDA® (page A-25) and Conveyor Series LAMBDA chains (page B-11) for additional specifications on other lube-free chains.

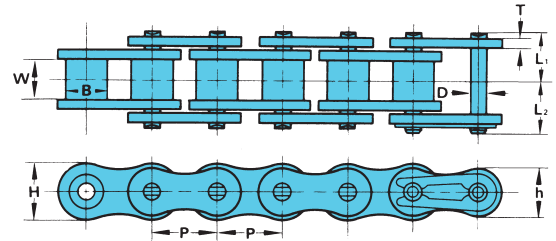

U.S. TSUBAKI Chain No.	Pitch P	Bushing Diameter B	Width Between Inner Link Plates W	Pin			Link Plate			Average Tensile Strength lbs.	Approx. Weight lbs./ft.
				D	L ₁	L ₂	T	H	h		
RS40SL	.500	.312	.297	.156	.325	.392	.060	.472	.409	3,300	.43
RS50SL	.625	.400	.359	.200	.406	.472	.080	.591	.512	5,200	.70
RS60SL	.750	.469	.485	.234	.506	.581	.094	.713	.614	7,400	1.03

FX Chain

FX CHAINS

U.S. Tsubaki FX chains feature excellent durability and flexibility for tough applications such as in concrete mixers, earth moving equipment, and mining machines.

1. FX chains are interchangeable with ASME/ANSI standard chains and can operate on the same ASME/ANSI standard sprocket.
2. Increased clearance between pins and bushings allows the chains to accommodate a 4 inch lateral side bow and an 8 degree twist per 4 feet of chain.

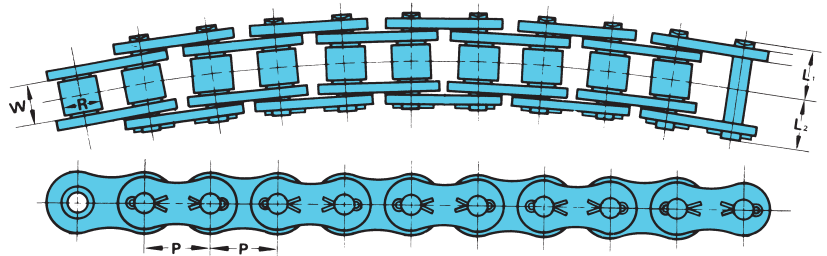

U.S. TSUBAKI Chain No.	Pitch P	Roller Diameter R	Width Between Roller Link Plates W	Pin		Average Tensile Strength lbs.	Approx. Weight lbs./ft.
				L ₁	L ₂		
RS100FX	1.250	.750	.750	.778	.900	24,000	2.51
RS120FX	1.500	.875	1.000	.980	1.138	34,000	3.69
RS140FX	1.750	1.000	1.000	1.059	1.248	46,000	5.00
RS160FX	2.000	1.125	1.250	1.254	1.451	58,000	6.53
RS180FX	2.250	1.406	1.406	1.404	1.671	72,000	8.69

Rollerless Chain

Rollerless chains are ideal for tension linkage applications and are designed and manufactured to withstand continual wearing action.

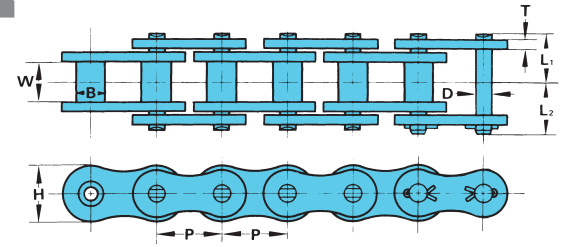

U.S. TSUBAKI	Pitch	Bushing Diameter	Width Between Inner Link Plates	Pin			Link Plate		Average Tensile Strength lbs.	Approx. Weight lbs./ft.
Chain No.	P	B	W	D	L ₁	L ₂	T	H		
RS65	.750	.330	.500	.234	.506	.581	.094	.713	9,800	.81
RS85	1.000	.448	.625	.312	.640	.758	.125	.949	17,200	1.41
RS105	1.250	.533	.750	.375	.778	.900	.156	1.185	25,500	2.08
RS125	1.500	.627	1.000	.437	.980	1.138	.187	1.425	36,300	3.04

Wrench Chain

U.S. Tsubaki Wrench chains have extra long pins extending beyond both sides of the chain. They serve as tension linkages for holding pipes securely in pipe wrenches.

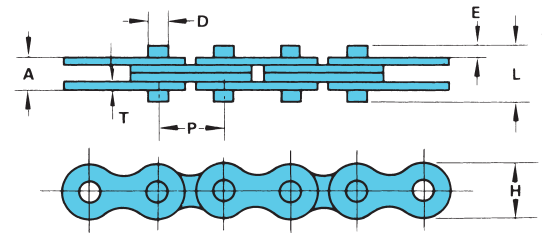

U.S. TSUBAKI	Pitch	Lacing	Pin			Link Plate		Width Over Link Plate	Average Tensile Strength lbs.	Approx. Weight lbs./ft.
Chain No.	P		D	L	E	T	H	A		
50WR	.625	2x2	.200	.559	.114	.080	.512	.331	6,750	.45
60WR	.750	2x2	.234	.787	.197	.094	.614	.394	9,000	.62

Laminated Block Chain

Laminated Block chain is used in light load, low speed applications. The chain is made entirely of 304 stainless steel. It is available in a variety of sizes, and it directly replaces Solid Block chain.

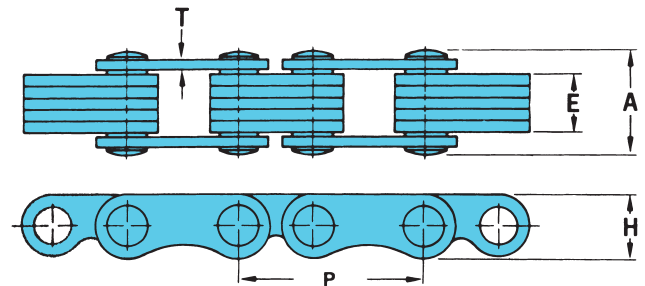

U.S. TSUBAKI Laminated Block Chain (304SS)	Pitch P	Block Width E	Link Plate T	Width A	Height H	Weight lbs./ft.
T502LSS	1.000	.188	.060	.375	.325	.3
T503LSS	1.000	.250	.060	.437	.325	.3
T504LSS	1.000	.312	.060	.562	.325	.4
T505LSS	1.000	.375	.060	.625	.325	.4
T506LSS	1.000	.500	.060	.750	.325	.5

Agriculture Chain

U.S. Tsubaki offers both MR type and RF type steel roller chains for agricultural applications.

MR type steel roller chains have been designed to replace malleable chains. These chains can be used with the existing sprockets for malleable chains.

They have higher tensile strength, longer life, and provide smoother operation for drives and conveyors than malleable chains. U.S. Tsubaki MR type steel roller chains with various attachments can also be used for material handling operations.



U.S. Tsubaki RF type steel roller chains have greater wear resistance and higher tensile strength than MR type steel roller chains.

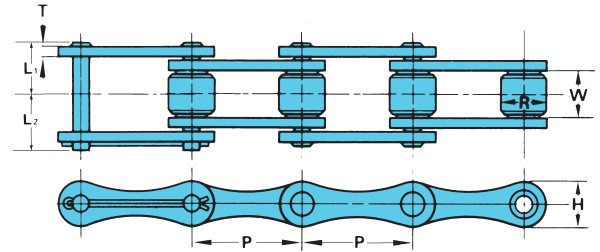

MR TYPE

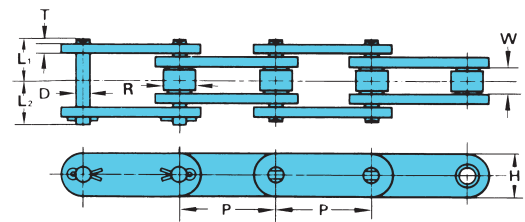

RF TYPE

U.S. TSUBAKI Chain No.	Pitch P	Roller Diameter R	Width Between Roller link Plates W	Pin			Link Plate		Min. Tensile Strength lbs.	Approx. Weight lbs./ft.
				D	L ₁	L ₂	T	H		
MR32	1.150	.450	.625	.175	.514	.569	.060	.500	1,980	.50
MR42	1.375	.562	.750	.275	.663	.750	.098	.750	6,600	1.08
MR52	1.500	.600	.875	.225	.724	.819	.098	.640	4,400	1.06
MR55	1.630	.700	.875	.225	.724	.819	.098	.650	6,380	1.10
MR45	1.630	.600	.875	.225	.724	.819	.098	.650	4,400	.97
MR62	1.650	.750	1.000	.225	.789	.817	.098	.660	6,380	1.26
CA550	1.630	.661	.795	.281	.683	.821	.106	.787	11,200	1.31
CA620	1.654	.696	.984	.281	.829	.951	.125	.787	11,200	1.60

See page B-28 for attachment specifications.

Chain Tools

Punches

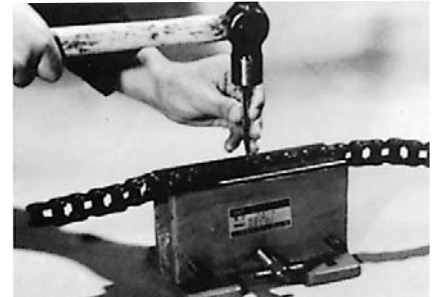

Chain No.	Primary Punch	Secondary Punch
RS40 ~ RS60	S-1	D-1
RS80 ~ RS120	S-2	D-2
RS140 ~ RS240	S-3	D-3

Chain No.	Riveting Punch
RS40	RV-1
RS50	RV-2
RS60	RV-3
RS80	RV-4

Chain Vises

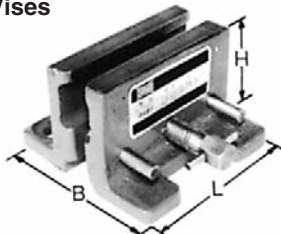

Model CV-1



Model CV-2



Model CV-3

Strands	Chain No.	RS40	RS50	RS60	RS80	RS100	RS120	RS140	RS160	RS180	RS200	RS240
1			CV-1									
2				CV-2				CV-3				
3										Not in Stock		

Model No.	L	H	B min. ~ max.
CV-1	3.94	2.56	3.70 ~ 4.53
CV-2	7.09	4.33	4.72 ~ 5.94
CV-3	7.87	6.69	7.09 ~ 8.66

indicates CV-1
 indicates CV-2
 indicates CV-3

Chain Breakers

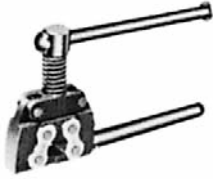

Model D



Model C

Model No.	D-35	D-60	D-120	CS - C3
Chain No.	RS25 ~ RS60	RS60 ~ RS100	RS120 ~ RS160	RS160 ~ RS240

Note: CS - C3 Made-To-Order.



Chain Pullers



P-35



P-60



P-80

Model No.	P-35	P-60	P-80
Chain No.	RS35 ~ RS60	RS40 ~ RS80	RS80 ~ RS240

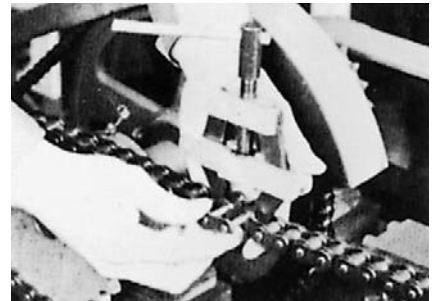

Engineering Information



Speed Ratio and Chain Wrap

The speed ratio of the roller chain can range up to 7:1 under normal operating conditions. However, a speed ratio of 10:1 is possible if the speed is very slow. Chain wrap on the small sprocket must be at least 120 degrees.

Distance Between Shafts

Sprockets can be separated by any distance as long as their teeth do not touch. Optimum distance is 30 to 50 times the pitch of the chain used except when there is a pulsating load. In such cases, the distance should be up to 20 times the pitch of the chain used.

Position

Roller chains are ideally installed horizontally. When chains are installed at angles approaching the vertical, they stretch quickly and may slip off the sprockets. In such cases the sprockets should be adjusted properly.

Slack

Generally, the slack of a roller chain should be on the lower side (see Fig. A). Adequate slack (SS') is 4% of the span for normal drives. In the following cases, the slack should be about 2% of the span.

- a. Vertical drive or close to vertical drive.
- b. Center distance between two shafts is greater than 3 ft.
- c. Chain is operated under heavy load and high frequency of on and off drive.
- d. Direction of the drive is often changed.

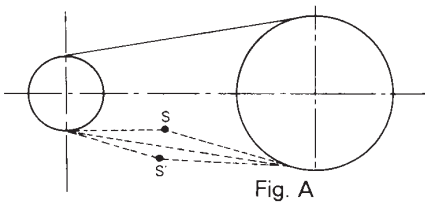

Position of Sprocket

The two shafts should be parallel and preferably in a horizontal position. Sprockets should be firmly installed. (See Figs. B and C) Use a straight edge to check that the two sprockets are installed along the same horizontal plane.

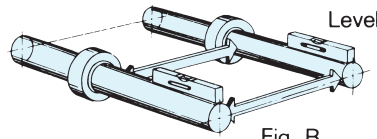

Fig. B

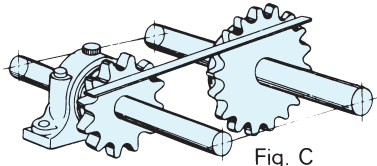

Fig. C

Arrangement

When designing roller chain drives, the centerline of both sprockets should be close to horizontal (see Figs. D and E). The angle of inclination can be up to 60 degrees as shown in Figs. F and G.

If installation is close to vertical, it is desirable to install an idler or a guide stopper to maintain smooth engagement of the chain and sprocket.

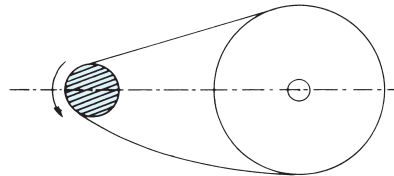

Fig. D

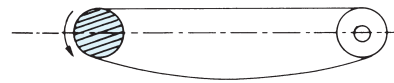

Fig. E

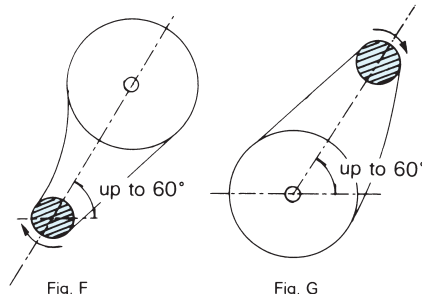

Fig. F

Fig. G

Attention should be paid to the following arrangements.

If the slack side is on the top, it is necessary to eliminate excessive chain slack.

A-1. When the center distance is short, chain slack should be adjusted by increasing the center distance.

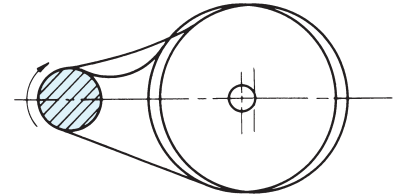

A-2. When the center distance is long, chain slack should be adjusted by installing an idler.

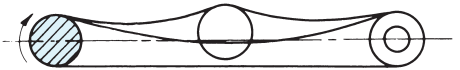

B. If vibration occurs due to high chain speed, install a guide.

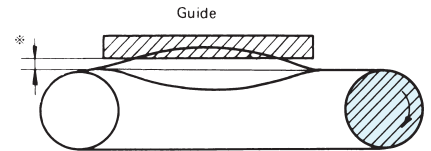

* Clearance between chain and guide should be 5/64" to 5/32"

C. If the centerline is vertical, install an idler which functions automatically to eliminate extra chain slack. If the driving shaft is on the lower side, an idler must be installed.

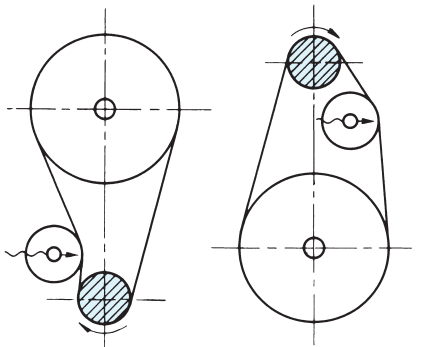

LUBRICATION

Lubrication Increases the Service Life

One of the most important factors in getting the best possible performance out of your roller chain is proper lubrication. No matter how well a transmission system is designed, if it is not properly lubricated, its service life will be shortened.

Lubrication

Wear between the pin and bushing causes the roller chain to stretch. These parts should, therefore, be well lubricated. The gap between the pin link plate and the roller link plate on the slack side of the chain should be filled with oil. This oil forms a film which minimizes wear on the pin and bushing, thus increasing the chain's service life. It also reduces noise and acts as a coolant when the chain runs at high speeds.

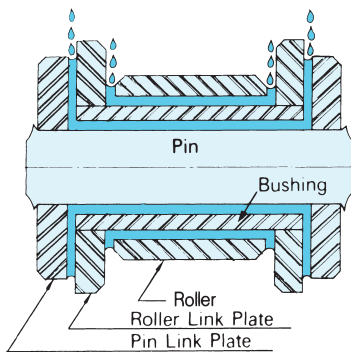

Suggested Lubricants

Only high quality oil should be used to lubricate the roller chain. Neither heavy oil nor grease is suitable. The viscosity of the oil used will depend on the chain size, chain speed and ambient temperature. The lubricants suggested for specific temperature ranges are given in the following table.

Lubricating System	A, B				C			
	14°F 32°F	32°F 104°F	104°F 122°F	122°F 140°F	14°F 32°F	32°F 104°F	104°F 122°F	122°F 140°F
Chain No.								
RS50 or less	SAE 10	SAE 20	SAE 30	SAE 40	SAE 10	SAE 20	SAE 30	SAE 40
RS60 and RS80	SAE 20	SAE 30	SAE 40	SAE 50				
RS100								
RS120 or more	SAE 30	SAE 40	SAE 50					

The following three lubricating systems are suggested:

System A

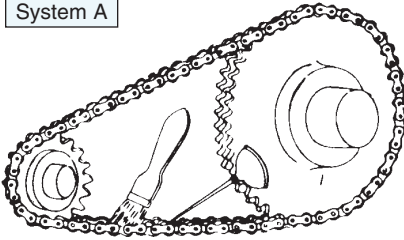

Manual Lubrication

Oil is applied with an oil filler or brush in the gap between the pin link and roller link on the slack side of the chain. It should be applied about every eight hours or as often as necessary to prevent the bearing area of the chain from becoming dry. Always turn off & lockout the power switch before lubricating or servicing a chain system.

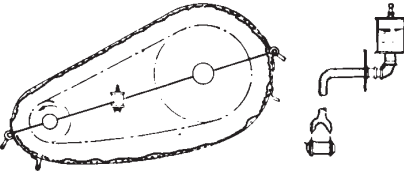

Drip Lubrication

A simple casing can be used. The oil is supplied by drip feed. Each strand of chain should ordinarily receive 5 to 20 drops of oil per minute, according to increases in the chain speed.

System B

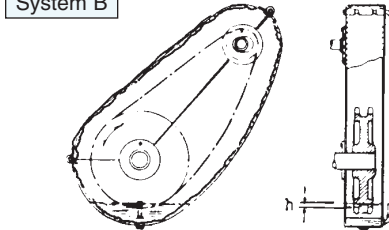

Oil Bath Lubrication

The chain is installed in a leak-free casing. The oil depth "h" should be 1/4 to 1/2 inch deep. If the oil is too deep, the oil will be adversely affected by the heat generated.

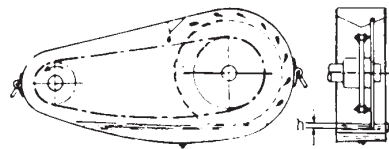

Lubrication by Slinger Disc

Install the slinger disc in a leak-free oil casing. Oil is splashed on the chain. The circumferential speed should be at least 700 ft./min. If the width of the chain is greater than 5 inches, attach slinger discs to both sides. The oil depth of "h" should be from 1/2 to 1 inch deep. The chain should not pass through the oil.

System C

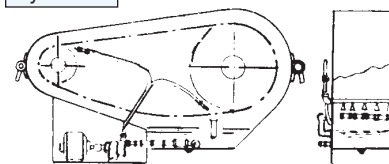

Lubrication Using a Pump

Use a leak-free casing. A pump is used to circulate the oil which is then cooled.

The number of supply holes should equal Z+1 where Z is the number of strands of chain. The amount of oil supplied to each hole is constant.

Chain Speed (ft./min.)	Chain Number			
	RS60 and under	RS80 RS100	RS120 RS140	RS160 and over
1,600 ~ 2,600	0.26 gal./min.	0.40 gal./min.	0.53 gal./min.	0.66 gal./min.
2,600 ~ 3,600	0.53 gal./min.	0.66 gal./min.	0.79 gal./min.	0.92 gal./min.
3,600 ~ 4,600	0.79 gal./min.	0.92 gal./min.	1.06 gal./min.	1.19 gal./min.

Regardless of the lubricating system used, the roller chain must be washed periodically with petroleum or gasoline. Examine the pin and bushing after removing the chain. Any damage or reddish-brown color on their surfaces indicate that the system is not being adequately lubricated.

TROUBLESHOOTING GUIDE

Problem	Possible Causes	What to Do
Excessive Noise	<ul style="list-style-type: none"> • Misalignment of sprockets • Loose casings or bearings • Too little or too much slack • Chain and/or sprocket wear • Inadequate lubrication or no lubrication • Chain pitch size too large 	<ul style="list-style-type: none"> • Realign sprockets and shafts • Tighten set-bolts • Adjust centers or idler take-up • Replace chain and/or sprocket • Lubricate properly • Check chain drive selection
Chain Vibration	<ul style="list-style-type: none"> • Resonance to the vibration cycle of machine to be installed • High load fluctuation 	<ul style="list-style-type: none"> • Change vibration cycle of chain or machine • Use torque converter or fluid coupling
Wear on inside of link plate and one side of sprocket teeth	<ul style="list-style-type: none"> • Misalignment 	<ul style="list-style-type: none"> • Realign sprockets and shafts
Chain climbs sprockets	<ul style="list-style-type: none"> • Excessive chain wear • Excessive chain slack • Heavy overload 	<ul style="list-style-type: none"> • Replace chain • Adjust centers or idler take-up • Reduce load or install stronger chain
Broken pins, bushings or rollers	<ul style="list-style-type: none"> • Chain speed too high for pitch and sprocket size • Heavy shock or suddenly applied loads • Material build-up in sprocket tooth pockets • Inadequate lubrication • Chain or sprocket corrosion 	<ul style="list-style-type: none"> • Use shorter pitch chain or install larger diameter sprockets • Reduce shock load or install stronger chain • Remove material build-up or install side gashed sprockets • Lubricate properly • Install anti-corrosive chain or sprockets
Chain clings to sprocket	<ul style="list-style-type: none"> • Center distance too big or high load fluctuation • Excessive chain slack • Excessive chain wear 	<ul style="list-style-type: none"> • Adjust the center distance or install idler take-up • Same as above • Replace chain
Chain gets stiff	<ul style="list-style-type: none"> • Misalignment • Inadequate lubrication • Corrosion • Excessive load • Material build-up in chain joint • Peening of link plate edges 	<ul style="list-style-type: none"> • Realign sprockets and shafts • Lubricate properly • Replace with anti-corrosive chain • Reduce load or replace with chain of suitable strength • Shield drive from foreign matter • Check for chain interference
Breakage of link plate	<ul style="list-style-type: none"> • Subjected to shock load • Vibration • Moment of load inertia is too big 	<ul style="list-style-type: none"> • Reduce shock (e.g., install a shock absorber) • Install a device to absorb vibration (e.g., tensioner idler wheel) • Chain section should be checked (increase number of strands or select next larger size chain)

U.S. TSUBAKI ENGINEERING INFORMATION

ASME/ANSI SPROCKET DIMENSIONS

A - DRIVE CHAINS

No. of Teeth	RS25 ¼" Pitch		RS35 ⅜" Pitch		RS40, RS41 ½" Pitch		RS50 ¾" Pitch		RS60 1" Pitch		RS80 1" Pitch	
	Pitch Dia.	* Outside Dia.	Pitch Dia.	* Outside Dia.	Pitch Dia.	* Outside Dia.	Pitch Dia.	* Outside Dia.	Pitch Dia.	* Outside Dia.	Pitch Dia.	* Outside Dia.
9	.731	.837	1.096	1.256	1.462	1.674	1.827	2.092	2.193	2.511	2.924	3.347
10	.809	.919	1.214	1.380	1.618	1.839	2.023	2.299	2.427	2.758	3.236	3.678
11	.887	1.002	1.331	1.502	1.775	2.003	2.219	2.504	2.662	3.004	3.549	4.006
12	.966	1.083	1.449	1.625	1.932	2.166	2.415	2.708	2.898	3.249	3.864	4.332
13	1.045	1.167	1.567	1.747	2.089	2.329	2.612	2.911	3.134	3.493	4.179	4.657
14	1.123	1.246	1.685	1.868	2.247	2.491	2.809	3.113	3.371	3.736	4.494	4.982
15	1.202	1.326	1.804	1.990	2.405	2.652	3.006	3.315	3.607	3.979	4.810	5.305
16	1.281	1.407	1.922	2.111	2.563	2.814	3.204	3.517	3.844	4.221	5.126	5.627
17	1.361	1.487	2.041	2.231	2.721	2.975	3.401	3.719	4.082	4.462	5.442	5.950
18	1.440	1.568	2.159	2.352	2.879	3.135	3.599	3.920	4.319	4.704	5.759	6.271
19	1.519	1.648	2.278	2.473	3.038	3.296	3.797	4.120	4.557	4.945	6.076	6.593
20	1.598	1.729	2.397	2.593	3.196	3.457	3.995	4.321	4.794	5.185	6.392	6.914
21	1.677	1.809	2.516	2.713	3.355	3.617	4.193	4.522	5.032	5.426	6.710	7.235
22	1.757	1.889	2.635	2.833	3.513	3.778	4.392	4.722	5.270	5.666	7.027	7.555
23	1.836	1.969	2.754	2.954	3.672	3.938	4.590	4.922	5.508	5.907	7.344	7.875
24	1.915	2.049	2.873	3.074	3.831	4.098	4.788	5.122	5.746	6.147	7.661	8.196
25	1.995	2.129	2.992	3.194	3.989	4.258	4.987	5.322	5.984	6.387	7.979	8.516
26	2.074	2.209	3.111	3.314	4.148	4.418	5.185	5.522	6.222	6.627	8.296	8.836
27	2.153	2.289	3.230	3.434	4.307	4.578	5.384	5.722	6.460	6.867	8.614	9.156
28	2.233	2.369	3.349	3.554	4.466	4.738	5.582	5.922	6.699	7.107	8.931	9.475
29	2.312	2.449	3.468	3.673	4.625	4.897	5.781	6.122	6.937	7.346	9.249	9.795
30	2.392	2.529	3.588	3.793	4.783	5.057	5.979	6.321	7.175	7.586	9.567	10.114
31	2.471	2.609	3.707	3.913	4.942	5.217	6.178	6.521	7.413	7.825	9.885	10.434
32	2.551	2.688	3.826	4.033	5.101	5.377	6.376	6.721	7.652	8.065	10.202	10.753
33	2.630	2.768	3.945	4.152	5.260	5.536	6.575	6.920	7.890	8.304	10.520	11.072
34	2.710	2.848	4.064	4.272	5.419	5.696	6.774	7.120	8.128	8.544	10.838	11.392
35	2.789	2.928	4.183	4.392	5.578	5.855	6.972	7.319	8.367	8.783	11.156	11.711
36	2.869	3.008	4.303	4.511	5.737	6.015	7.171	7.519	8.605	9.022	11.474	12.030
37	2.948	3.087	4.422	4.631	5.896	6.175	7.370	7.718	8.844	9.262	11.792	12.349
38	3.028	3.167	4.541	4.751	6.055	6.334	7.568	7.918	9.082	9.501	12.110	12.668
39	3.107	3.247	4.660	4.871	6.214	6.494	7.767	8.117	9.321	9.740	12.428	12.987
40	3.187	3.327	4.780	4.990	6.373	6.653	7.966	8.316	9.559	9.980	12.745	13.306
41	3.266	3.406	4.899	5.110	6.532	6.813	8.165	8.516	9.798	10.219	13.063	13.625
42	3.346	3.486	5.018	5.229	6.691	6.972	8.363	8.715	10.036	10.458	13.381	13.944
43	3.425	3.566	5.137	5.349	6.850	7.131	8.562	8.914	10.275	10.697	13.700	14.263
44	3.505	3.646	5.257	5.468	7.009	7.291	8.761	9.114	10.513	10.936	14.018	14.582
45	3.584	3.725	5.376	5.588	7.168	7.451	8.960	9.313	10.752	11.176	14.336	14.901
46	3.664	3.805	5.495	5.708	7.327	7.609	9.159	9.512	10.990	11.415	14.654	15.219
47	3.743	3.885	5.614	5.827	7.486	7.769	9.357	9.711	11.229	11.654	14.972	15.538
48	3.823	3.964	5.734	5.947	7.645	7.928	9.556	9.911	11.467	11.893	15.290	15.857
49	3.902	4.044	5.853	6.066	7.804	8.088	9.755	10.111	11.706	12.132	15.608	16.176
50	3.982	4.124	5.972	6.186	7.963	8.247	9.954	10.309	11.944	12.371	15.928	16.495
51	4.061	4.203	6.091	6.305	8.122	8.407	10.153	10.508	12.183	12.610	16.244	16.813
52	4.141	4.283	6.211	6.425	8.281	8.566	10.351	10.707	12.422	12.849	16.562	17.132
53	4.220	4.363	6.330	6.544	8.440	8.725	10.550	10.907	12.660	13.088	16.880	17.451
54	4.300	4.442	6.449	6.664	8.599	8.885	10.749	11.106	12.899	13.327	17.198	17.769
55	4.379	4.522	6.569	6.783	8.758	9.044	10.948	11.305	13.137	13.566	17.517	18.088
56	4.459	4.602	6.688	6.903	8.917	9.203	11.147	11.504	13.376	13.805	17.835	18.406
57	4.538	4.681	6.807	7.022	9.076	9.363	11.346	11.703	13.615	14.044	18.153	18.725
58	4.618	4.761	6.927	7.142	9.236	9.522	11.544	11.902	13.853	14.283	18.471	19.044
59	4.697	4.841	7.046	7.261	9.395	9.681	11.743	12.102	14.092	14.522	18.739	19.363
60	4.777	4.920	7.165	7.381	9.554	9.841	11.942	12.301	14.330	14.761	19.107	19.681
61	4.857	5.000	7.284	7.500	9.713	10.000	12.141	12.500	14.569	15.000	19.426	20.000
62	4.936	5.080	7.404	7.619	9.872	10.159	12.340	12.699	14.808	15.238	19.744	20.318
63	5.016	5.159	7.523	7.739	10.031	10.318	12.539	12.898	15.046	15.477	20.062	20.637

* Outside diameter dimensions are nominal.

Note: Bottom diameter = pitch diameter – chain roller diameter

No. of Teeth	RS25 ¼" Pitch		RS35 ⅜" Pitch		RS40, RS41 ½" Pitch		RS50 ¾" Pitch		RS60 1" Pitch		RS80 1" Pitch	
	Pitch Dia.	* Outside Dia.	Pitch Dia.	* Outside Dia.	Pitch Dia.	* Outside Dia.	Pitch Dia.	* Outside Dia.	Pitch Dia.	* Outside Dia.	Pitch Dia.	* Outside Dia.
64	5.095	5.239	7.642	7.858	10.190	10.478	12.738	13.097	15.285	15.716	20.380	20.955
65	5.175	5.319	7.762	7.978	10.349	10.637	12.936	13.296	15.524	15.955	20.698	21.274
66	5.254	5.398	7.881	8.097	10.508	10.796	13.135	13.495	15.762	16.194	21.016	21.593
67	5.334	5.478	8.000	8.217	10.667	10.956	13.334	13.694	16.001	16.433	21.335	21.911
68	5.413	5.558	8.120	8.336	10.826	11.115	13.533	13.893	16.240	16.672	21.653	22.230
69	5.493	5.637	8.239	8.456	10.986	11.274	13.732	14.092	16.478	16.911	21.971	22.548
70	5.572	5.717	8.358	8.575	11.145	11.434	13.931	14.292	16.717	17.150	22.289	22.867
71	5.652	5.796	8.478	8.694	11.304	11.593	14.130	14.491	16.956	17.388	22.607	23.185
72	5.732	5.876	8.597	8.814	11.463	11.752	14.328	14.690	17.194	17.628	22.926	23.504
73	5.811	5.956	8.716	8.933	11.622	11.911	14.527	14.889	17.433	17.866	23.244	23.822
74	5.891	6.035	8.836	9.053	11.781	12.071	14.726	15.088	17.672	18.105	23.562	24.141
75	5.970	6.115	8.955	9.172	11.940	12.229	14.925	15.287	17.910	18.344	23.880	24.459
76	6.050	6.195	9.074	9.292	12.099	12.389	15.124	15.486	18.149	18.583	24.198	24.778
77	6.129	6.274	9.194	9.411	12.258	12.548	15.323	15.685	18.387	18.822	24.517	25.096
78	6.209	6.354	9.313	9.531	12.417	12.708	15.522	15.884	18.626	19.061	24.835	25.415
79	6.288	6.433	9.432	9.650	12.577	12.867	15.721	16.083	18.865	19.299	25.153	25.733
80	6.368	6.513	9.552	9.770	12.736	13.026	15.920	16.282	19.104	19.539	25.471	26.052
81	6.448	6.593	9.671	9.889	12.895	13.185	16.118	16.481	19.342	19.777	25.790	26.370
82	6.527	6.672	9.790	10.008	13.054	13.345	16.317	16.681	19.581	20.016	26.108	26.689
83	6.607	6.752	9.910	10.128	13.213	13.504	16.516	16.879	19.820	20.255	26.426	27.007
84	6.686	6.832	10.029	10.247	13.372	13.663	16.715	17.079	20.058	20.494	26.744	27.326
85	6.766	6.911	10.148	10.367	13.531	13.822	16.914	17.277	20.297	20.733	27.063	27.644
86	6.845	6.991	10.268	10.486	13.690	13.981	17.113	17.476	20.536	20.971	27.381	27.962
87	6.925	7.070	10.387	10.605	13.849	14.141	17.312	17.676	20.774	21.210	27.699	28.281
88	7.004	7.150	10.506	10.725	14.009	14.299	17.511	17.874	21.013	21.449	28.017	28.599
89	7.084	7.230	10.626	10.844	14.168	14.459	17.710	18.074	21.252	21.688	28.335	28.918
90	7.164	7.309	10.745	10.964	14.327	14.618	17.909	18.272	21.490	21.927	28.654	29.236
91	7.243	7.389	10.864	11.083	14.486	14.777	18.107	18.471	21.729	22.165	28.972	29.554
92	7.323	7.468	10.984	11.202	14.645	14.937	18.306	18.671	21.968	22.404	29.290	29.873
93	7.402	7.548	11.103	11.322	14.804	15.096	18.505	18.869	22.206	22.643	29.608	30.191
94	7.482	7.628	11.223	11.441	14.963	15.255	18.704	19.069	22.445	22.882	29.927	30.510
95	7.561	7.707	11.342	11.561	15.122	15.414	18.903	19.267	22.684	23.121	30.245	30.828
96	7.641	7.787	11.461	11.680	15.282	15.573	19.102	19.466	22.922	23.359	30.563	31.146
97	7.720	7.866	11.581	11.799	15.441	15.733	19.301	19.666	23.161	23.598	30.881	31.465
98	7.800	7.946	11.700	11.919	15.600	15.892	19.500	19.864	23.400	23.837	31.200	31.783
99	7.880	8.026	11.819	12.038	15.759	16.051	19.699	20.064	23.638	24.076	31.518	32.102
100	7.959	8.105	11.939	12.158	15.918	16.210	19.898	20.262	23.877	24.315	31.836	32.420
101	8.039	8.185	12.058	12.277	16.077	16.370	20.097	20.462	24.116	24.554	32.154	32.739
102	8.118	8.264	12.177	12.396	16.236	16.529	20.295	20.661	24.355	24.793	32.473	33.058
103	8.198	8.344	12.297	12.516	16.395	16.688	20.494	20.860	24.593	25.032	32.791	33.376
104	8.277	8.424	12.416	12.635	16.555	16.847	20.693	21.059	24.832	25.271	33.109	33.695
105	8.357	8.503	12.535	12.755	16.714	17.006	20.892	21.258	25.071	25.510	33.428	34.013
106	8.437	8.583	12.655	12.874	16.873	17.166	21.091	21.457	25.309	25.749	33.746	34.332
107	8.516	8.662	12.774	12.994	17.032	17.325	21.290	21.656	25.548	25.987	34.064	34.650
108	8.596	8.742	12.893	13.113	17.191	17.484	21.489	21.854	25.787	26.226	34.382	34.968
109	8.675	8.822	13.013	13.232	17.350	17.643	21.688	22.054	26.025	26.465	34.701	35.287
110	8.755	8.901	13.132	13.352	17.509	17.803	21.887	22.253	26.264	26.704	35.019	35.605
111	8.834	8.981	13.251	13.471	17.669	17.962	22.086	22.452	26.503	26.943	35.337	35.924
112	8.914	9.060	13.371	13.591	17.828	18.122	22.285	22.651	26.742	27.182	35.655	36.243
113	8.994	9.140	13.490	13.710	17.987	18.280	22.484	22.850	26.980	27.421	35.974	36.561
114	9.073	9.220	13.609	13.830	18.146	18.440	22.682	23.049	27.219	27.660	36.292	36.879
115	9.153	9.299	13.729	13.948	18.305	18.597	22.881	23.246	27.458	27.896	36.610	37.194
116	9.232	9.379	13.848	14.068	18.464	18.757	23.080	23.447	27.696	28.136	36.929	37.515
117	9.312	9.458	13.968	14.187	18.623	18.917	23.279	23.647	27.935	28.376	37.247	37.835
118	9.391	9.538	14.087	14.307	18.783	19.077	23.478	23.846	28.174	28.615	37.565	38.155
119	9.471	9.662	14.206	14.427	18.942	19.235	23.677	24.045	28.413	28.853	37.883	38.471
120	9.550	9.679	14.326	14.545	19.101	19.394	23.876	24.243	28.651	29.091	38.202	38.789

* Outside diameter dimensions are nominal.

Note: Bottom diameter = pitch diameter – chain roller diameter

U.S. TSUBAKI ENGINEERING INFORMATION

ASME/ANSI SPROCKET DIMENSIONS

A - DRIVE CHAINS

No. of Teeth	RS100 1 1/4" Pitch		RS120 1 1/2" Pitch		RS140 1 3/4" Pitch		RS160 2" Pitch		RS200 2 1/2" Pitch		RS240 3" Pitch	
	Pitch Dia.	* Outside Dia.	Pitch Dia.	* Outside Dia.	Pitch Dia.	* Outside Dia.	Pitch Dia.	* Outside Dia.	Pitch Dia.	* Outside Dia.	Pitch Dia.	* Outside Dia.
9	3.655	4.184	4.386	5.021	5.117	5.858	5.848	6.695	7.310	8.367	8.771	10.044
10	4.045	4.597	4.854	5.516	5.663	6.436	6.472	7.355	8.090	9.195	9.708	11.034
11	4.437	5.007	5.324	6.008	6.212	7.010	7.099	8.011	8.872	10.015	10.649	12.018
12	4.830	5.415	5.796	6.498	6.762	7.581	7.727	8.664	9.660	10.830	11.591	12.996
13	5.223	5.821	6.268	6.986	7.313	8.150	8.357	9.314	10.447	11.642	12.536	13.971
14	5.617	6.227	6.741	7.472	7.864	8.718	8.988	9.963	11.235	12.455	13.482	14.943
15	6.012	6.631	7.215	7.957	8.417	9.283	9.620	10.609	12.025	13.262	14.429	15.912
16	6.407	7.034	7.689	8.441	8.970	9.848	10.252	11.255	12.815	14.067	15.377	16.881
17	6.803	7.437	8.163	8.924	9.524	10.411	10.885	11.899	13.605	14.872	16.327	17.847
18	7.198	7.839	8.638	9.407	10.078	10.975	11.518	12.543	14.397	15.677	17.276	18.813
19	7.594	8.241	9.113	9.889	10.632	11.537	12.151	13.185	15.190	16.482	18.227	19.779
20	7.991	8.642	9.589	10.370	11.187	12.099	12.785	13.828	15.982	17.285	19.177	20.742
21	8.387	9.043	10.064	10.851	11.742	12.660	13.419	14.470	16.775	18.087	20.129	21.705
22	8.783	9.444	10.540	11.332	12.297	13.221	14.053	15.110	17.567	18.887	21.080	22.665
23	9.180	9.844	11.016	11.813	12.852	13.782	14.688	15.751	18.360	19.687	22.032	23.628
24	9.577	10.245	11.492	12.294	13.407	14.343	15.323	16.392	19.152	20.490	22.984	24.588
25	9.973	10.645	11.968	12.774	13.963	14.903	15.958	17.032	19.947	21.290	23.936	25.548
26	10.370	11.045	12.444	13.254	14.518	15.463	16.593	17.671	20.740	22.090	24.889	26.508
27	10.767	11.444	12.921	13.733	15.074	16.022	17.228	18.311	21.535	22.890	25.841	27.468
28	11.164	11.844	13.397	14.213	15.630	16.582	17.863	18.951	22.330	23.687	26.794	28.425
29	11.561	12.244	13.874	14.692	16.186	17.141	18.498	19.590	23.122	24.487	27.747	29.385
30	11.958	12.643	14.350	15.172	16.742	17.700	19.134	20.229	23.917	25.285	28.700	30.342
31	12.356	13.043	14.827	15.651	17.298	18.259	19.769	20.868	24.712	26.085	29.654	31.302
32	12.753	13.442	15.303	16.130	17.854	18.818	20.405	21.506	25.505	26.882	30.607	32.259
33	13.150	13.841	15.780	16.609	18.410	19.377	21.040	22.145	26.300	27.680	31.560	33.219
34	13.547	14.240	16.257	17.088	18.966	19.936	21.676	22.784	27.095	28.480	32.514	34.176
35	13.945	14.639	16.734	17.566	19.523	20.494	22.312	23.422	27.890	29.277	33.467	35.133
36	14.342	15.038	17.211	18.045	20.079	21.052	22.947	24.060	28.685	30.075	34.421	36.090
37	14.740	15.437	17.687	18.524	20.635	21.611	23.583	24.698	29.480	30.872	35.375	37.047
38	15.137	15.835	18.164	19.002	21.192	22.169	24.219	25.336	30.275	31.670	36.329	38.004
39	15.534	16.234	18.641	19.481	21.748	22.728	24.855	25.975	31.070	32.467	37.283	38.961
40	15.932	16.633	19.118	19.959	22.305	23.286	25.491	26.613	31.865	33.265	38.237	39.918
41	16.329	17.032	19.595	20.438	22.861	23.844	26.127	27.251	32.660	34.062	39.191	40.875
42	16.727	17.430	20.072	20.916	23.418	24.402	26.763	27.888	33.455	34.860	40.145	41.832
43	17.124	17.829	20.549	21.394	23.974	24.960	27.399	28.526	34.250	35.657	41.099	42.789
44	17.522	18.227	21.026	21.873	24.531	25.518	28.035	29.164	35.045	36.455	42.053	43.746
45	17.919	18.626	21.503	22.351	25.087	26.076	28.671	29.802	35.840	37.252	43.007	44.703
46	18.317	19.024	21.980	22.829	25.644	26.634	29.307	30.439	36.635	38.047	43.961	45.657
47	18.715	19.423	22.458	23.308	26.201	27.192	29.943	31.077	37.430	38.845	44.915	46.614
48	19.112	19.821	22.935	23.786	26.757	27.750	30.580	31.714	38.225	39.642	45.869	47.571
49	19.510	20.219	23.412	24.264	27.314	28.308	31.216	32.352	39.020	40.440	46.824	48.528
50	19.908	20.618	23.889	24.742	27.871	28.865	31.852	32.989	39.815	41.237	47.778	49.485
51	20.305	21.017	24.366	25.220	28.427	29.423	32.488	33.626	40.610	42.032	48.732	50.439
52	20.703	21.415	24.843	25.698	28.984	29.980	33.124	34.263	41.405	42.830	49.687	51.396
53	21.100	21.813	25.320	26.176	29.541	30.538	33.761	34.901	42.200	43.627	50.641	52.353
54	21.498	22.212	25.798	26.654	30.097	31.096	34.397	35.539	42.996	44.422	51.595	53.307
55	21.896	22.610	26.275	27.132	30.654	31.654	35.033	36.176	43.792	45.220	52.550	54.264
56	22.293	23.008	26.752	27.610	31.211	32.211	35.669	36.813	44.587	46.015	53.504	55.221
57	22.691	23.407	27.229	28.088	31.768	32.769	36.306	37.451	45.382	46.812	54.458	56.175
58	23.089	23.805	27.707	28.566	32.324	33.327	36.942	38.088	46.177	47.610	55.413	57.132
59	23.486	24.203	28.184	29.044	32.881	33.885	37.578	38.725	46.972	48.407	56.368	58.089
60	23.884	24.601	28.661	29.522	33.438	34.442	38.215	39.362	47.767	49.202	57.322	59.043
61	24.282	25.000	29.138	30.000	33.995	35.000	38.851	39.999	48.565	50.000	58.277	60.000
62	24.680	25.397	29.616	30.477	34.551	35.557	39.487	40.636	49.360	50.795	59.231	60.954
63	25.077	25.796	30.093	30.955	35.108	36.114	40.124	41.274	50.155	51.592	60.185	61.911

* Outside diameter dimensions are nominal.

Note: Bottom diameter = pitch diameter – chain roller diameter

No. of Teeth	RS100 1¼" Pitch		RS120 1½" Pitch		RS140 1¾" Pitch		RS160 2" Pitch		RS200 2½" Pitch		RS240 3" Pitch	
	Pitch Dia.	* Outside Dia.	Pitch Dia.	* Outside Dia.	Pitch Dia.	* Outside Dia.	Pitch Dia.	* Outside Dia.	Pitch Dia.	* Outside Dia.	Pitch Dia.	* Outside Dia.
64	25.475	26.194	30.570	31.433	35.665	36.672	40.760	41.911	50.950	52.387	61.140	62.868
65	25.873	26.593	31.047	31.911	36.222	37.229	41.396	42.548	51.745	53.185	62.095	63.822
66	26.271	26.991	31.525	32.389	36.779	37.787	42.033	43.185	52.540	53.982	63.049	64.779
67	26.668	27.389	32.002	32.867	37.336	38.345	42.669	43.822	53.337	54.777	64.004	65.733
68	27.066	27.787	32.479	33.345	37.892	38.902	43.306	44.459	54.132	55.575	64.958	66.690
69	27.464	28.185	32.957	33.822	38.449	39.459	43.942	45.096	54.927	56.370	65.913	67.644
70	27.862	28.584	33.434	34.301	39.006	40.017	44.578	45.734	55.722	57.167	66.868	68.601
71	28.259	28.981	33.911	34.778	39.563	40.574	45.215	46.370	56.517	57.962	67.822	69.555
72	28.657	29.380	34.388	35.256	40.120	41.132	45.851	47.008	57.315	58.760	68.777	70.512
73	29.055	29.778	34.866	35.733	40.677	41.689	46.488	47.644	58.110	59.555	69.731	71.466
74	29.453	30.176	35.343	36.212	41.234	42.247	47.124	48.282	58.905	60.352	70.686	72.423
75	29.850	30.574	35.820	36.689	41.790	42.803	47.760	48.918	59.700	61.147	71.641	73.377
76	30.248	30.973	36.298	37.167	42.347	43.362	48.397	49.556	60.495	61.945	72.595	74.334
77	30.646	31.370	36.775	37.644	42.904	43.918	49.033	50.192	61.292	62.741	73.550	75.288
78	31.044	31.769	37.252	38.123	43.461	44.476	49.670	50.830	62.087	63.537	74.505	76.245
79	31.441	32.166	37.730	38.600	44.018	45.033	50.306	51.466	62.882	64.332	75.459	77.199
80	31.839	32.565	38.207	39.078	44.575	45.591	50.943	52.104	63.677	65.130	76.414	78.156
81	32.237	32.963	38.684	39.555	45.132	46.148	51.579	52.740	64.475	65.925	77.369	79.110
82	32.635	33.361	39.162	40.034	45.689	46.706	52.216	53.378	65.270	66.722	78.323	80.067
83	33.033	33.759	39.639	40.511	46.246	47.262	52.852	54.014	66.065	67.517	79.278	81.021
84	33.430	34.158	40.116	40.989	46.803	47.821	53.489	54.652	66.860	68.315	80.233	81.978
85	33.828	34.555	40.594	41.466	47.359	48.377	54.125	55.288	67.657	69.110	81.188	82.932
86	34.226	34.953	41.071	41.943	47.916	48.934	54.761	55.924	68.452	69.905	82.142	83.886
87	34.624	35.351	41.548	42.422	48.473	49.492	55.398	56.562	69.247	70.702	83.097	84.843
88	35.022	35.749	42.026	42.899	49.030	50.048	56.034	57.198	70.042	71.497	84.052	85.797
89	35.419	36.148	42.503	43.377	49.587	50.607	56.671	57.836	70.837	72.295	85.006	86.754
90	35.817	36.545	42.981	43.854	50.144	51.163	57.307	58.472	71.635	73.090	85.961	87.708
91	36.215	36.943	43.458	44.331	50.701	51.720	57.944	59.108	72.430	73.885	86.916	88.665
92	36.613	37.341	43.935	44.810	51.258	52.278	58.580	59.746	73.225	74.682	87.871	89.619
93	37.011	37.739	44.413	45.287	51.814	52.834	59.216	60.382	74.020	75.477	88.825	90.576
94	37.408	38.138	44.890	45.765	52.371	53.393	59.853	61.020	74.815	76.275	89.780	91.530
95	37.806	38.535	45.367	46.242	52.928	53.949	60.489	61.656	75.612	77.070	90.735	92.484
96	38.204	38.933	45.845	46.719	53.485	54.506	61.126	62.292	76.407	77.865	91.690	93.441
97	38.602	39.331	46.322	47.198	54.042	55.064	61.762	62.930	77.202	78.662	92.645	94.395
98	39.000	39.729	46.800	47.675	54.499	55.620	62.399	63.566	77.997	79.457	93.599	95.352
99	39.397	40.128	47.277	48.153	55.156	56.179	63.035	64.204	78.795	80.255	94.554	96.306
100	39.795	40.525	47.754	48.630	55.713	56.735	63.672	64.840	79.590	81.050	95.509	97.263
101	40.193	40.924	48.232	49.109	56.270	57.294	64.309	65.478	80.385	81.847	96.464	98.217
102	40.591	41.322	48.709	49.586	56.827	57.851	64.945	66.115	81.182	82.642	97.418	99.171
103	40.989	41.720	49.187	50.064	57.384	58.408	65.582	66.752	81.977	83.440	98.373	100.128
104	41.387	42.118	49.664	50.542	57.941	58.966	66.218	67.389	82.772	84.235	99.328	101.082
105	41.784	42.517	50.141	51.020	58.498	59.523	66.855	68.027	83.567	85.030	100.283	102.039
106	42.182	42.915	50.619	51.498	59.055	60.081	67.492	68.664	84.365	85.827	101.238	102.993
107	42.580	43.312	51.096	51.975	59.612	60.637	68.128	69.299	85.160	86.622	102.192	103.947
108	42.978	43.710	51.574	52.452	60.169	61.194	68.765	69.936	85.955	87.420	103.147	104.904
109	43.376	44.108	52.051	52.930	60.726	61.751	69.401	70.573	86.752	88.215	104.102	105.858
110	43.774	44.506	52.528	53.408	61.283	62.309	70.038	71.210	87.547	89.012	105.056	106.815
111	44.171	44.905	53.006	53.886	61.840	62.867	70.674	71.848	88.342	89.807	106.011	107.769
112	44.569	45.304	53.483	54.364	62.397	63.425	71.311	72.486	89.137	90.602	106.967	108.723
113	44.967	45.701	53.960	54.841	62.954	63.982	71.948	73.122	89.935	91.400	107.921	109.680
114	45.365	46.099	54.438	55.319	63.511	64.539	72.584	73.759	90.730	92.195	108.876	110.634
115	45.763	46.493	54.915	55.792	64.068	65.090	73.220	74.388	91.525	92.992	109.831	111.591
116	46.161	46.893	55.393	56.272	64.625	65.651	73.857	75.030	92.322	93.787	110.786	112.545
117	46.558	47.293	55.870	56.752	65.182	66.210	74.494	75.669	93.117	94.582	111.740	113.499
118	46.956	47.691	56.348	57.230	65.739	66.768	75.130	76.306	93.912	95.380	112.695	114.456
119	47.354	48.089	56.825	57.707	66.296	67.325	75.767	76.943	94.707	96.175	113.650	115.410
120	47.752	48.486	57.302	58.183	66.853	67.880	76.403	77.577	95.502	96.970	114.605	116.364

* Outside diameter dimensions are nominal.

Note: Bottom diameter = pitch diameter – chain roller diameter

U.S. TSUBAKI ENGINEERING INFORMATION

PITCH CONVERSION TABLE — NO. OF PITCHES CONVERTED INTO FEET

No. of Pitches	Chain No.												Length of Pitches
	RS25 ¼"	RS35 ⅜"	RS40, RS41 ½"	RS50 ⅝"	RS60 ¾"	RS80 1"	RS100 1¼"	RS120 1½"	RS140 1¾"	RS160 2"	RS200 2½"	RS240 3"	
	Chain Length (ft.)												
1	0.0208	0.0313	0.0417	0.0521	0.0625	0.0833	0.1042	0.1250	0.1458	0.1667	0.2083	0.2500	1
2	0.0416	0.0625	0.0833	0.1042	0.1250	0.1667	0.2083	0.2500	0.2917	0.3333	0.4147	0.5000	2
3	0.0625	0.0938	0.1250	0.1563	0.1875	0.2500	0.3125	0.3750	0.4375	0.5000	0.6250	0.7500	3
4	0.0833	0.1250	0.1667	0.2083	0.2500	0.3333	0.4167	0.5000	0.5833	0.6667	0.8333	1.0000	4
5	0.1041	0.1563	0.2083	0.2604	0.3125	0.4167	0.5208	0.6250	0.7222	0.8333	1.0417	1.2500	5
6	0.1250	0.1875	0.2500	0.3125	0.3750	0.5000	0.6250	0.7500	0.8750	1.0000	1.2500	1.5000	6
7	0.1458	0.2188	0.2917	0.3646	0.4375	0.5833	0.7992	0.8750	1.0208	1.1667	1.4583	1.7500	7
8	0.1666	0.2500	0.3333	0.4167	0.5000	0.6667	0.8333	1.0000	1.1667	1.3333	1.6667	2.0000	8
9	0.1875	0.2813	0.3750	0.4688	0.5625	0.7500	0.9375	1.1250	1.3125	1.5000	1.8750	2.2500	9
10	0.2083	0.3125	0.4167	0.5208	0.6250	0.8333	1.0417	1.2500	1.4583	1.6667	2.0833	2.5000	10
11	0.2292	0.3438	0.4584	0.5729	0.6875	0.9167	1.1458	1.3750	1.6041	1.8333	2.2917	2.7500	11
12	0.2500	0.3750	0.5000	0.6250	0.7500	1.0000	1.2500	1.5000	1.7500	2.0000	2.5000	3.0000	12
13	0.2708	0.4063	0.5417	0.6771	0.8125	1.0833	1.3542	1.6250	1.8958	2.1667	2.7083	3.2500	13
14	0.2916	0.4375	0.5833	0.7292	0.8750	1.1667	1.4583	1.7500	2.0417	2.3333	2.9167	3.5000	14
15	0.3125	0.4688	0.6250	0.7813	0.9375	1.2500	1.5625	1.8750	2.1875	2.5000	3.1250	3.7500	15
16	0.3333	0.5000	0.6667	0.8333	1.0000	1.3333	1.6667	2.0000	2.3333	2.6667	3.3333	4.0000	16
17	0.3542	0.5313	0.7084	0.8854	1.0625	1.4167	1.7708	2.1250	2.4791	2.8333	3.5417	4.2500	17
18	0.3750	0.5625	0.7500	0.9375	1.1250	1.5000	1.8750	2.2500	2.7250	3.0000	3.7500	4.5000	18
19	0.3958	0.5938	0.7917	0.9896	1.1875	1.5833	1.9792	2.3750	2.7708	3.1667	3.9583	4.7500	19
20	0.4166	0.6250	0.8333	1.0417	1.2500	1.6667	2.0833	2.5000	2.9167	3.3333	4.1667	5.0000	20
21	0.4375	0.6563	0.8750	1.0938	1.3125	1.7500	2.1875	2.6250	3.0625	3.5000	4.3750	5.2500	21
22	0.4583	0.6875	0.9167	1.1458	1.3750	1.8333	2.2917	2.7500	3.2083	3.6667	4.5833	5.5000	22
23	0.4792	0.7188	0.9584	1.1979	1.4375	1.9166	2.3958	2.8750	3.3541	3.8333	4.7917	5.7500	23
24	0.5000	0.7500	1.0000	1.2500	1.5000	2.0000	2.5000	3.0000	3.5000	4.0000	5.0000	6.0000	24
25	0.5208	0.7813	1.0417	1.3021	1.5625	2.0833	2.6042	3.1250	3.6458	4.1667	5.2083	6.2500	25
26	0.5416	0.8125	1.0833	1.3541	1.6250	2.1667	2.7083	3.2500	3.7917	4.3333	5.4167	6.5000	26
27	0.5625	0.8438	1.1250	1.4062	1.6875	2.2500	2.8125	3.3750	3.9375	4.5000	5.6250	6.7500	27
28	0.5833	0.8750	1.1667	1.4583	1.7600	2.3333	2.9167	3.5000	4.0833	4.6667	5.8333	7.0000	28
29	0.6024	0.9063	1.2084	1.5104	1.8125	2.4167	3.0208	3.6250	4.2291	4.8333	6.0417	7.2500	29
30	0.6250	0.9375	1.2500	1.5625	1.8750	2.5000	3.1250	3.7500	4.3750	5.0000	6.2500	7.5000	30
31	0.6458	0.9688	1.2917	1.6164	1.9375	2.5833	3.2292	3.8750	4.5208	5.1667	6.4583	7.7500	31
32	0.6667	1.0000	1.3333	1.6667	2.0000	2.6667	3.3333	4.0000	4.6667	5.3333	6.6667	8.0000	32
33	0.6875	1.0313	1.3750	1.7188	2.0625	2.7500	3.4375	4.1250	4.8125	5.5000	6.8750	8.2500	33
34	0.7083	1.0625	1.4167	1.7708	2.1250	2.8333	3.5417	4.2500	4.9583	5.6667	7.0833	8.5000	34
35	0.7292	1.0938	1.4584	1.8229	2.1875	2.9167	3.6458	4.3750	5.1041	5.8333	7.2917	8.7500	35
36	0.7500	1.1250	1.5000	1.8750	2.2500	3.0000	3.7500	4.5000	5.2500	6.0000	7.5000	9.0000	36
37	0.7708	1.1563	1.5417	1.9271	2.3125	3.0833	3.8542	4.6250	5.3958	6.1667	7.7083	9.2500	37
38	0.7916	1.1875	1.5833	1.9791	2.3750	3.1667	3.9583	4.7500	5.5417	6.3333	7.9167	9.5000	38
39	0.8125	1.2188	1.6250	2.0312	2.4375	3.2500	4.0625	4.8750	5.6875	6.5000	8.1250	9.7500	39
40	0.8333	1.2500	1.6667	2.0833	2.5000	3.3333	4.1667	5.0000	5.8333	6.6667	8.3333	10.0000	40
41	0.8542	1.2813	1.7084	2.1354	2.5625	3.4167	4.2709	5.1250	5.9791	6.8333	8.5417	10.2500	41
42	0.8750	1.3125	1.7500	2.1875	2.6250	3.5000	4.3750	5.2500	6.1250	7.0000	8.7500	10.5000	42
43	0.8958	1.3438	1.7917	2.2396	2.6875	3.5833	4.4792	5.3750	6.2708	7.1667	8.9583	10.7500	43
44	0.9166	1.3750	1.8333	2.2916	2.7500	3.6667	4.5833	5.5000	6.4167	7.3333	9.1667	11.0000	44
45	0.9375	1.4063	1.8750	2.3437	2.8125	3.7500	4.6875	5.6250	6.5625	7.5000	9.3750	11.2500	45
46	0.9583	1.4375	1.9167	2.3958	2.8750	3.8333	4.7917	5.7500	6.7083	7.6667	9.5833	11.5000	46
47	0.9792	1.4688	1.9584	2.4479	2.9375	3.9167	4.8959	5.8750	6.8541	7.8333	9.7917	11.7500	47
48	1.0000	1.5000	2.0000	2.5000	3.0000	4.0000	5.0000	6.0000	7.0000	8.0000	10.0000	12.0000	48
49	1.0208	1.5313	2.0417	2.5521	3.0625	4.0833	5.1042	6.1250	7.1458	8.1667	10.2083	12.2500	49
50	1.0416	1.5625	2.0833	2.6042	3.1250	4.1667	5.2083	6.2500	7.2917	8.3333	10.4167	12.5000	50

A - DRIVE CHAINS

PITCH CONVERSION TABLE — NO. OF PITCHES CONVERTED INTO FEET

No. of Pitches	Chain No.												No. of Pitches
	RS25 ¼"	RS35 ⅜"	RS40, RS41 ½"	RS50 ⅝"	RS60 ¾"	RS80 1"	RS100 1¼"	RS120 1½"	RS140 1¾"	RS160 2"	RS200 2½"	RS240 3"	
	Chain Length (ft.)												
51	1.0625	1.5938	2.1250	2.6563	3.1875	4.2500	5.3125	6.3750	7.4375	8.5000	10.6250	12.7500	51
52	1.0833	1.6250	2.1667	2.7083	3.2500	4.3333	5.4167	6.5000	7.5833	8.6667	10.8333	13.0000	52
53	1.1042	1.6563	2.2084	2.7604	3.3125	4.4167	5.5209	6.6250	7.7291	8.8333	11.0417	13.2500	53
54	1.1250	1.6875	2.2500	2.8125	3.3750	4.5000	5.6250	6.7500	7.8750	9.0000	11.2500	13.5000	54
55	1.1458	1.7188	2.2917	2.8647	3.4375	4.5833	5.7292	6.8750	8.0208	9.1667	11.4583	13.7500	55
56	1.1666	1.7500	2.3333	2.9167	3.5000	4.6667	5.8333	7.0000	8.1667	9.3333	11.6667	14.0000	56
57	1.1375	1.7813	2.3750	2.9688	3.5625	4.7500	5.9375	7.1250	8.3125	9.5000	11.8750	14.2500	57
58	1.2083	1.8125	2.4167	3.0208	3.6250	4.8333	6.0417	7.2500	8.4583	9.6667	12.0833	14.5000	58
59	1.2292	1.8438	2.4584	3.0729	3.6875	4.9166	6.1459	7.3750	8.6041	9.8333	12.1917	14.7500	59
60	1.2500	1.8750	2.5000	3.1250	3.7500	5.0000	6.2500	7.5000	8.7500	10.0000	12.5000	15.0000	60
61	1.2708	1.9063	2.5417	3.1771	3.8125	5.0833	6.3542	7.6250	8.8958	10.1667	12.7083	15.2500	61
62	1.2916	1.9375	2.5833	3.2292	3.8750	5.1667	6.5583	7.7500	9.0417	10.3333	12.9167	15.5000	62
63	1.3125	1.9688	2.6250	3.2813	3.9375	5.2500	6.6625	7.8750	9.1875	10.5000	13.1350	15.7500	63
64	1.3333	2.0000	2.6667	3.3333	4.0000	5.3333	6.7667	8.0000	9.3333	10.6667	13.3333	16.0000	64
65	1.3542	2.0313	2.7084	3.3854	4.0625	5.4167	6.8709	8.1250	9.4791	10.8333	13.5417	16.2500	65
66	1.3750	2.0625	2.7500	3.4375	4.1250	5.5000	6.9750	8.2500	9.6250	11.0000	13.7500	16.5000	66
67	1.3958	2.0938	2.7917	3.4897	4.1875	5.5833	7.0792	8.3750	9.7708	11.1667	13.9583	16.7500	67
68	1.4166	2.1250	2.8333	3.5417	4.2500	5.6667	7.1833	8.5000	9.9167	11.3333	14.1667	17.0000	68
69	1.4375	2.1563	2.8750	3.5938	4.3125	5.7500	7.2875	8.6250	10.0625	11.5000	14.3750	17.2500	69
70	1.4583	2.1875	2.9167	3.6458	4.3750	5.8333	7.3917	8.7500	10.2083	11.6667	14.5833	17.5000	70
71	1.4792	2.2188	2.9584	3.6979	4.4375	5.9167	7.3950	8.8750	10.3541	11.8333	14.7917	17.7500	71
72	1.5000	2.2500	3.0000	3.7500	4.5000	6.0000	7.5000	9.0000	10.5000	12.0000	15.0000	18.0000	72
73	1.5208	2.2813	3.0417	3.8021	4.5625	6.0833	7.6042	9.1250	10.6458	12.1667	15.2083	18.2500	73
74	1.5416	2.3125	3.0833	3.8541	4.6250	6.1667	7.7083	9.2500	10.7917	12.3333	15.4167	18.5000	74
75	1.5525	2.3438	3.1250	3.9062	4.6875	6.2500	7.8125	9.3750	10.9375	12.5000	15.6250	18.7500	75
76	1.5831	2.3750	3.1667	3.9583	4.7500	6.3333	7.9167	9.5000	11.0833	12.6667	15.8333	19.0000	76
77	1.6039	2.4063	3.2084	4.0104	4.8125	6.4167	8.0209	9.6250	11.2291	12.8333	16.0417	19.2500	77
78	1.6247	2.4375	3.2500	4.0625	4.8750	6.5000	8.1250	9.7500	11.3750	13.0000	16.2500	19.5000	78
79	1.6456	2.4688	3.2917	4.1146	4.9375	6.5833	8.2282	9.8750	11.5208	13.1667	16.4583	19.7500	79
80	1.6664	2.5000	3.3333	4.1667	5.0000	6.6667	8.3333	10.0000	11.6667	13.3333	16.6667	20.0000	80
81	1.6872	2.5313	3.3750	4.2188	5.0625	6.7500	8.4375	10.1250	11.8125	13.5000	16.8750	20.2500	81
82	1.7081	2.5625	3.4167	4.2700	5.1250	6.8333	8.5417	10.2500	11.9583	13.6667	17.0833	20.5000	82
83	1.7289	2.5938	3.4584	4.3230	5.1875	6.9167	8.6459	10.3750	12.1041	13.8333	17.2917	20.7500	83
84	1.7497	2.6250	3.5000	4.3750	5.2500	7.0000	8.7500	10.5000	12.2500	14.0000	17.5000	21.0000	84
85	1.7706	2.6563	3.5417	4.4271	5.3125	7.0833	8.8542	10.6250	12.3958	14.1667	17.7083	21.2500	85
86	1.7914	2.6875	3.5833	4.4792	5.3750	7.1667	8.9583	10.7500	12.5417	14.3333	17.9167	21.5000	86
87	1.8122	2.7188	3.6250	4.5313	5.4375	7.2500	9.0625	10.8750	12.6875	14.5000	18.1250	21.7500	87
88	1.8330	2.7500	3.6667	4.5834	5.5000	7.3333	9.1667	11.0000	12.8333	14.6667	18.3333	22.0000	88
89	1.8539	2.7813	3.7084	4.6355	5.5625	7.4167	9.2709	11.1250	12.9791	14.8333	18.5417	22.2500	89
90	1.8747	2.8125	3.7500	4.6875	5.6250	7.5000	9.3750	11.2500	13.1250	15.0000	18.7500	22.5000	90
91	1.8955	2.8438	3.7917	4.7396	5.6875	7.5833	9.4792	11.3750	13.2708	15.1667	18.9583	22.7500	91
92	1.9164	2.8750	3.8333	4.7917	5.7500	7.6667	9.5833	11.5000	13.4167	15.3333	19.1667	23.0000	92
93	1.9372	2.9063	3.8750	4.8438	5.8125	7.7500	9.6875	11.6250	13.5625	15.5000	19.3750	23.2500	93
94	1.9580	2.9375	3.9167	4.8958	5.8750	7.8333	9.7917	11.7500	13.7083	15.6667	19.5833	23.5000	94
95	1.9789	2.9688	3.9584	4.9479	5.9375	7.9167	9.8959	11.8750	13.8541	15.8333	19.7917	23.7500	95
96	1.9997	3.0000	4.0000	5.0000	6.0000	8.0000	10.0000	12.0000	14.0000	16.0000	20.0000	24.0000	96
97	2.0205	3.0313	4.0417	5.0521	6.0625	8.0833	10.1042	12.1250	14.1458	16.1667	20.2083	24.2500	97
98	2.0413	3.0625	4.0833	5.1042	6.1250	8.1667	10.2083	12.2500	14.2917	16.3333	20.4167	24.5000	98
99	2.0622	3.0938	4.1250	5.1563	6.1875	8.2500	10.3125	12.3750	14.4375	16.5000	20.6250	24.7500	99
100	2.0830	3.1250	4.1667	5.2083	6.2500	8.3333	10.4167	12.5000	14.5833	16.6667	20.8333	25.0000	100

WARNING

USE CARE TO PREVENT INJURY COMPLY WITH FOLLOWING TO AVOID SERIOUS PERSONAL INJURY:

1. Guards must be provided on all chain and sprocket installations in accordance with provisions of ANSI/ASME B15.1 — 2000 “Safety Standards for Mechanical Power Transmission Apparatus,” and ANSI/ASME B20.1 — 2006 “Safety Standards for Conveyors and Related Equipment,” or other applicable safety standards. When revisions of these standards are published, the updated edition shall apply.
2. Always lock out the power switch before installing, removing, lubricating or servicing a chain system.
3. When connecting or disconnecting chain:
 - a. Eye protection is required. Wear safety glasses, protective clothing, gloves and safety shoes.
 - b. Support the chain to prevent uncontrolled movement of chain and parts.
 - c. Use of pressing equipment is suggested. Tools must be in good condition and properly used.
 - d. Do not attempt to connect or disconnect chain unless you understand chain construction, including the correct direction for pin/rivet removal or insertion.
 - e. Do not attempt to rework damaged chains by replacing only the components obviously faulty. The entire chain may be compromised, and it should be discarded.
4. Other cautions:
 - a. **Alterations and Repairs** to chains should be made only by qualified personnel with parts and components authorized by U.S. Tsubaki.
 - b. **Electroplating of Assembled Chains** is not condoned. Plating of assembled chains could result in failure from hydrogen embrittlement.
 - c. **Inspect Chains** for shipment damage before installation. During operation, all chain systems should be inspected on a regular schedule. Visually check for worn, damaged and broken parts caused by improper installation or maintenance, abnormal stress, temperature, humidity, abrasion or corrosion, possible interference with other system components and improper lubrication. (For correct lubrication procedures and systems, see the Engineering Section.)
 - d. **Heating Chain** with a cutting torch is not suggested unless absolutely necessary for removal. If cut in such a manner, it should not be reused.
 - e. **Welding** should not be performed on any chain or component.
 - f. **Average Ultimate Strength** of a chain means the average load at which it will break when subjected to a destructive tensile test. *It does not mean working load.* For complete information, contact U.S. Tsubaki Engineering.
 - g. **Product Dimensions** in this catalog are subject to changes and are intended for general reference only. For exact current dimensions, request certified prints from U.S. Tsubaki.

