



TIMKEN
Where You Turn

Weatherly Index: 310/322-340
Catalog number: 7564
Effective date: 2010

Supersedes BSAC 2006 dated 2006

1990 and Newer Bearing and Seal Application Catalog

1990 et nouveau Catalogue d'application de roulements et de joints

Catálogo de aplicaciones de rodamientos y retenes 1990 y posteriores



For Automotive and Light Truck
Pour les automobiles et camions légers
Para automóviles y camiones ligeros

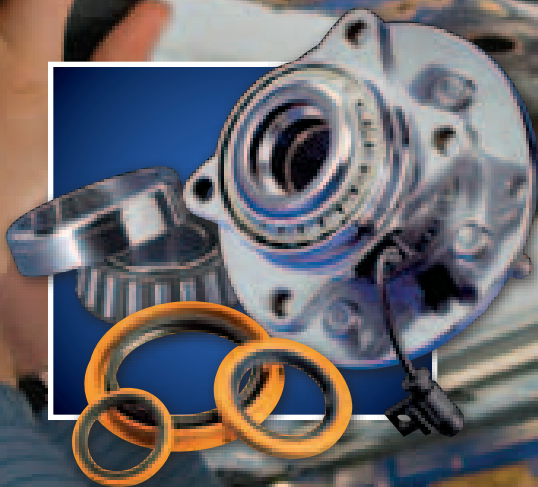

BSAC 2010

Featuring An Expanded Hub Unit Bearing / Bearing Module Technology Section

INTRODUCTION

Original equipment (OE) quality is what you get with every aftermarket hub unit bearing, bearing and seal sold by Timken. Vehicle manufacturers from around the world choose the Timken® brand because of its reputation for quality. You too can choose Timken with the same confidence vehicle manufacturers have had for more than a century.

An expanded Hub Unit Bearing Technology Section is included in this edition. As a leader in hub unit bearing technology for OE automotive manufacturers, Timken is also a leader in the automotive aftermarket for this product line.

If you have comments regarding this catalog, please complete the postage paid card found in the back of this catalog or send an e-mail to auto.am@timken.com.

Every reasonable effort has been made to ensure the accuracy of the information contained in this writing, but no liability is accepted for errors, omissions or for any other reason.

INTRODUCTION

En achetant un joint, un moyeu ou un roulement de rechange vendu par Timken, vous bénéficiez de la qualité des produits d'origine. Des constructeurs automobiles des quatre coins du monde ont choisi Timken, car ce nom est synonyme de qualité et ce, depuis plus d'un siècle. Comme eux, faites confiance à Timken.

Cette édition inclut également une liste complète de roulements pour moyeu. Déjà leader dans le domaine des technologies de

roulements pour les constructeurs automobiles, Timken est à la tête du marché des pièces de rechange pour cette gamme de produits.

Pour tout commentaire sur ce catalogue, renvoyez-nous la carte port payé incluse à la fin du catalogue ou envoyez-nous un courrier électronique à l'adresse suivante : auto.am@timken.com.

Malgré le soin apporté à l'exactitude des informations contenues dans ce document, Timken ne saurait en aucun cas être tenu pour responsable des erreurs ou omissions, ni en aucune autre façon.

INTRODUCCIÓN

Calidad de Equipo Original (OE) es lo que usted obtiene en cada ensamble de maza, rodamiento y retén de repuesto de Timken. Los fabricantes de vehículos en todo el mundo eligen la marca Timken por su reputación de calidad. Usted también puede elegir a Timken con la misma confianza con la que lo han hecho los fabricantes por más de un siglo.

En esta edición se incluye una extensa sección de Tecnología en Ensamblajes de Maza. Así como es líder en la tecnología de mazas para fabricantes de Equipo Original, Timken también es líder en esta línea de productos para el mercado de repuesto automotriz.

Si tiene algún comentario sobre este catálogo, por favor llene la tarjeta con porte pagado que se encuentra en la parte posterior o envíe un correo a auto.am@timken.com.

Se realizó todo el esfuerzo razonable para asegurar la precisión de la información contenida en este catálogo, sin embargo, no nos hacemos responsables por errores, omisiones u otras razones.

Contact Info (Customer Service / Service à la Clientèle):

USA: Phone: 866-9-TIMKEN (984-6536) | Fax: 877-TIMKEN-9 (846-5369)

Canada: English: 866-527-5973 | Français: 866-527-5974 | Fax: 866-372-5094
After Hours Service / Après les heures normales de travail: 416-453-6520

Online catalog: www.timkeninfo.com

TABLE OF CONTENTS

Introduction / Introducción	i
How To Use This Catalog / Comment Utiliser Ce Catalogue / Cómo Usar Este Catálogo	v
Setting the Pace for Automotive Aftermarket	vi
Prendre les devants pour le marché des pièces et accessoires d'automobile	vii
Marcando el camino para el Mercado de Repuesto Automotriz	viii
Application Indexes	ix
Manufacturer / Model to Page Number	ix
Model to Manufacturer to Page Number	xvii
Manufacturer to Model to Page Number	xxvii
Abbreviation Key	xxxvii
Applications	1
Hub Unit Bearing / Bearing Module Technology Section	449
Keys to Choosing the Right Hub Unit Bearing / Bearing Module	450
Hub Unit Bearing Generations: Ball Bearing Type	451
Hub Unit Bearing Generations: Tapered Roller Bearing Type	452
Cross Reference	453
FM to Timken	454
SKF to Timken	461
Buyer's Guide	467
Diagrams and Specifications	485
Photos and Installation Skill Levels	523
Removing and Installing a Hub Unit Bearing	602
Removiendo E Instalando Un Ensemble De Maza	604
Checking a Hub Unit Bearing	606
Revisando Un Ensemble De Maza	608

continued on next page

TABLE OF CONTENTS *continued*

Removing a Hub Unit Bearing and Steering Knuckle	610
Bearing Removal and Installation	612
Installing a Hub Unit Bearing and Steering Knuckle	614
Wheel Bearing Replacement	616
Seal and Shaft Installation Procedures	618
Rear Wheel Repair Package Bearings	620
Trailer Wheel Bearing Kits	622
Milemate®	624
MileMate®: French Canadian	626
MileMate®: Spanish	627
Driveline Center Support Bearings	628
Superseded and Obsolete Part Numbers	629
Non-Cancellable, Non-Returnable Part Numbers	630
Notes	631
Comment Card	637
Set Interchange and Milemate®	639

HOW TO USE THIS CATALOG

See the section 'Application Index Model to Page Number' beginning on page ix, to find the page number where your vehicle is listed.

Vehicles are arranged alphabetically by make and model.

The product quantity (if more than one) necessary to do a complete repair is contained in brackets following the part number.

Helpful Information:

- The model year of a vehicle can be identified by the tenth digit from the left in the Vehicle Identification Number (VIN) on the dash, looking through the windshield or on the doorjamb.
- The vehicle engine type can be determined from the decal under the hood or by using the eighth digit from the left in the VIN.
- The type of braking system (ABS or non-ABS, front or 4-wheel) can be found through actual inspection of the system, or in the case of General Motors, the decal located in the trunk or the glove box.

COMMENT UTILISER CE CATALOGUE

Pour connaître le numéro de la page répertoriant votre véhicule, consultez la section Modèles d'index d'application et leur numéro de page, commençant à la page ix.

Les véhicules sont classés par ordre alphabétique, par marque et par modèle.

Les quantités requises (si plus d'un) pour une réparation complète sont indiquées entre crochets après le numéro de la pièce.

Information utile :

- Pour identifier la marque, le modèle et l'année du véhicule. Vous trouverez cette dernière information dans le Numéro d'identification du véhicule automobile, placé sur le tableau de bord, sur le pare-brise ou sur le montant de la portière.
- La cylindrée du moteur est indiquée sur l'autocollant placé sous le capot. Vous pouvez aussi consulter la partie gauche du Numéro d'identification du véhicule automobile, qui indique la cylindrée.
- Vous connaîtrez le type du système de freinage (ABS ou non, freinage avant ou aux quatre roues) en inspectant le système, ou (dans le cas de véhicules General Motors) en consultant l'étiquette placée dans le coffre ou la boîte à gants, qui indique les codes des freins.

CÓMO USAR ESTE CATÁLOGO

Vea la sección "Índice de Aplicaciones por Modelo y Número de Página" a partir de la página ix, para encontrar el número de página en que se encuentra enlistado el modelo de su vehículo.

Los vehículos se encuentran ordenados alfabéticamente por fabricante y modelo. La cantidad de piezas necesarias para una completa reparación (si son más de una) se indica entre paréntesis después del número de parte.

La cantidad de piezas necesarias para una completa reparación (si son más de una) se indica entre paréntesis después del número de parte.

Información útil:

- El año del modelo del vehículo puede identificarse a partir del décimo dígito de la izquierda del Número de Identificación del Vehículo (VIN, por sus siglas en inglés) que se encuentra en una etiqueta en el tablero, en el parabrisas o en el marco de la puerta.
- El tipo de motor del vehículo puede identificarse en la calcomanía que se encuentra debajo de la cajuela o con el octavo dígito de la izquierda en el VIN.
- Puede encontrar el tipo de sistema de frenos (ABS, no ABS, delantero o en las 4 ruedas) inspeccionando el propio sistema, o en el caso de General Motors, se encuentra una calcomanía en la guantera o en la cajuela, en la que se especifica el tipo de frenos.

SETTING THE PACE FOR AUTOMOTIVE AFTERMARKET

TIMKEN – WHERE YOU TURN

Timken is indeed where customers turn for original equipment (OE) replacement hub unit bearings, bearings and seals, but it is also where customers turn for quality and innovation.

QUALITY

Quality is the cornerstone of our reputation and is central to the ability of each of our businesses to achieve its mission. Each associate is committed to fully satisfying customer requirements and to continually improve everything we do to create value in our products and services.

INNOVATION IN:

Manufacturing

With more than 50 manufacturing plants, we continue to offer products that extend beyond the bearing itself to the environment around the bearing.

Hub Unit Bearings

OE market strengths are transferred to our aftermarket hub unit bearings, offering customers a full line of quality replacement parts including SENSOR-PAC™, UNIPAC™ and UNIPAC-PLUS™. Timken hub unit bearings are pre-set, pre-greased and pre-sealed, which helps make installation easier.

Seals

While Timken is known for its top-quality bearings, the company also has an impressive history of designing top-quality seals. Integral to bearing performance, Timken is proud of its numerous patented seals, which are made in some of the world's most advanced manufacturing plants.

Steel

Timken provides customers around the world with high-quality steel. Capitalizing on the synergy between our bearing and steel businesses, we use our expertise to select bearing materials that meet the most demanding application requirements and help extend bearing life.

Technology

When people think of Timken, they often think of advanced technology. There are understandable reasons for that. Timken engineers and scientists at our 9 global technology centers continue to develop new friction management solutions.



PRENDRE LES DEVANT POUR LE MARCHÉ DES PIÈCES ET ACCESSOIRES D'AUTOMOBILE

TIMKEN – QUAND ÇA TOURNE

Par le fait même, Timken est le partenaire de choix des clients souhaitant obtenir des moyeux, des joints et des roulements de rechange. Cela dit, chez Timken, nous savons que nos clients recherchent également la qualité et l'innovation.

QUALITÉ

La qualité est la pierre angulaire de notre réputation. Elle est au centre de toutes nos activités, qui ne sauraient remplir leurs objectifs sans elle. Chaque collaborateur s'engage à respecter pleinement les exigences de ses clients tout en apportant continuellement des améliorations aux efforts de Timken, afin d'augmenter la valeur de ses produits et services.

LES CIBLES DE L'INNOVATION :

Fabrication

Forte de ses quelque 50 usines, l'entreprise Timken, loin de s'arrêter au roulement en lui-même, continue de proposer des produits propres à l'environnement du roulement.

Moyeux

Toutes les qualités du marché de l'équipement d'origine se retrouvent également dans les moyeux de rechange que nous proposons. Nos clients peuvent accéder à toute une gamme de pièces de rechange de qualité, qui comprend les pièces SENSOR-PAC™, UNIPAC™ et UNIPACPLUS™. Les moyeux Timken sont installés, graissés et scellés à l'avance, de manière à faciliter l'installation.

Joints

Certes, l'entreprise Timken est en premier lieu reconnue pour ses roulements de grande qualité. Cependant, ses performances en matière de conception de joints ont toujours

été impressionnantes. Chez Timken, nous sommes fiers de présenter nos nombreux joints brevetés, qui jouent un rôle crucial dans les performances des roulements et sont fabriqués dans des usines à la fine pointe de la technologie mondiale.

Acier

Timken fournit des aciers de grande qualité à des clients dans le monde entier. Grâce à la synergie entre nos activités d'acier et de roulements, nous mettons à profit notre expertise pour sélectionner des matériaux qui répondent aux conditions d'utilisation les plus exigeantes et aident à prolonger la durée de vie des roulements.

Technologies

Le nom de Timken est souvent associé à une avancée technologique. Cette association de pensée est tout à fait compréhensible. En effet, les scientifiques et ingénieurs rassemblés dans les 9 Centres technologiques mondiaux de Timken travaillent sans cesse au développement de nouvelles solutions de gestion des frictions.



MARCANDO EL CAMINO PARA EL MERCADO DE REPUESTO AUTOMOTRIZ

TIMKEN – PRESENTE EN TODO MOVIMIENTO

Timken es definitivamente adonde acuden los clientes para reemplazar mazas, rodamientos y sellos de equipo original (OE), y también adonde acuden por calidad e innovación.

CALIDAD

La calidad es la piedra angular de nuestra reputación y es fundamental para que cada una de nuestras divisiones cumpla con su misión. Todos los empleados estamos comprometidos a satisfacer por completo los requerimientos de los clientes y a mejorar continuamente en todo lo que hacemos para crear valor en nuestros productos y servicios.

INNOVACIÓN EN:

Fabricación

Con más de 50 plantas, seguimos ofreciendo productos que van más allá de los rodamientos y se ocupan del entorno que los rodea.

Unidades de rodamientos de mazas

Los beneficios de equipo original (OE) se transfieren a nuestras unidades de mazas, lo que ofrece a nuestros clientes una línea completa de partes de repuesto de alta calidad como SENSOR-PAC™, UNIPAC™ y UNIPACPLUS™. Las unidades de maza de Timken están preajustadas, preengrasadas y preselladas, lo que facilita su instalación.

Retenes

Si bien Timken es reconocida por la gran calidad de sus rodamientos, también cuenta con una admirable trayectoria en el diseño de retenes de alta calidad. Como parte integral en el

desempeño de los rodamientos, Timken se enorgullece de sus numerosos retenes patentados y que se fabrican en algunas de las plantas más avanzadas del mundo.

Acero

Timken provee acero de alta calidad a clientes de todo el mundo. Aprovechando la sinergia entre nuestros negocios de rodamientos y de acero, usamos nuestra experiencia para seleccionar materiales para los rodamientos que cumplan con los requisitos de las aplicaciones más exigentes y contribuyan a prolongar su vida útil.

Tecnología

Cuando se piensa en Timken, por lo general se piensa en tecnología de avanzada. Y es comprensible, pues los ingenieros y científicos de nuestros 9 centros globales de tecnología continúan desarrollando nuevas soluciones para el manejo de la fricción.



MANUFACTURER / MODEL TO PAGE NUMBER

Manufacturer / Model	Page
Acura	
Integra, Legend, NSX, RSX, TSX, Vigor, 2.2CL, 2.3CL, 2.5TL, 3.0CL, 3.2CL, 3.2TL, 3.5RL	1
Acura SUV	
MDX	6
RDX, SLX	7
Alfa Romeo	
Spider, 164	8
Aston Martin	9
Audi	
A3, A4, A6, A8, Cabriolet, RS4, RS6, S4, S5, S6, S8, TT, V8 Quattro, Allroad Quattro	10
Coupe Quattro	14
80, 90, 100, 200, FWD, Quattro	15
Audi SUV	
Allroad Quattro	17
Q7	18
Avanti II	19
Bentley	
Continental, Eight, Mulsanne, Turbo R	20
BMW	
Mini Cooper	20
1 Series	20
3 Series	21
4 Series	23
5 Series	24
6 Series	27
7 Series	27
8 Series	29
BMW SUV	
X3, X5, X6	30

Manufacturer / Model	Page
Buick FWD	
Century	31
Electra, LeSabre, Park Avenue	32
Allure, LaCrosse	33
Lucerne	34
Regal	34
Riviera, Reatta	35
Skylark	36
Buick RWD	
LeSabre	37
Roadmaster Estate Wagon, Roadmaster Sedan	38
Buick Minivan	
Terraza	40
Buick SUV	
Enclave	41
Rainier	41
Rendezvous	42
Cadillac FWD	
Allante	43
DeVille, Fleetwood	44
DTS	45
Eldorado	46
Seville	47
Cadillac RWD	
Commercial Chassis/Limousine, DeVille, Fleetwood	48
Catera	49
CTS Sedan	49
STS	50
XLR	51

MANUFACTURER / MODEL TO PAGE NUMBER *continued*

Manufacturer / Model	Page
Cadillac SUV, Truck	
Escalade, Escalade ESV, Escalade EXT	52
SRX	54
Chevrolet FWD	
Aveo, Aveo 5	54
Beretta, Cavalier, Corsica	55
Celebrity	57
Cobalt, Optra	58
Impala, Lumina, Monte Carlo	58
Malibu, Fleet Classic (Fleet Vehicle)	60
Chevrolet RWD	
Caprice (Thru 1993)	62
Camaro, IROC, Z-28	63
Caprice, Impala (From 1994)	65
Corvette	66
Chevrolet Import (See also GEO)	
Metro, Prizm, Sprint	68
Chevrolet Import SUV	
Tracker	69
Chevrolet/GMC Lt Truck	
Acadia	71
Astro/Safari	71
Colorado/Canyon	74
Trailblazer/Envoy	75
Equinox	76
HHR	76
Chevrolet Minivan	
Lumina APV, Venture	77

Manufacturer / Model	Page
Chevrolet/GMC Lt Truck	
S10 Blazer/S15 Jimmy, S10 Pickup/S15 Sonoma, Syclone/Typhoon	78
SSR	82
Uplander	83
Chevrolet/GMC 1/2 ton Truck	
Avalanche	84
Blazer/Jimmy, C-10/15, K-10/15, Silverado/Sierra, Silverado/Sierra HD, Suburban, Tahoe/Yukon	85
Express/Savana, G10/G15	91
Chevrolet/GMC 3/4 ton Truck	
Avalanche	93
C-20/25, K-20/25, Silverado/Sierra, Suburban, Silverado 2500 HD, V-20/25, Yukon XL 2500	95
G20/G25, Express/Savana	100
Chevrolet/GMC 1 ton Truck	
C-30/35, K-30/35, Silverado/Sierra	103
Express/Savana, G30/G35, P30/P35	108
Chevrolet/GMC 1-1/2, 2, 2-1/2 ton Truck	
50, 60, 70, 4500, 5500, 6500, 7500	110
Chrysler FWD	
Cirrus, Sebring	117
300M, Concorde, Daytona, Dynasty, Imperial, Laser, LeBaron, LHS, New Yorker	119
Neon	121
Chrysler RWD	
Crossfire	121
Prowler	121
300	122
Chrysler Import	
TC Maserati	123
Chrysler CUV	
Pacifica	123

MANUFACTURER / MODEL TO PAGE NUMBER *continued*

Manufacturer / Model	Page
Chrysler Minivan, Truck (See also Plymouth)	
Aspen	124
PT Cruiser	125
Town, Country Van, Grand Voyager, Voyager from 2000	126
Daewoo	
Lanos, Leganza, Nubira	128
Daihatsu	
Charade	129
Daihatsu SUV	
Rocky	130
Dodge FWD	
Daytona, Dynasty, Shadow, Spirit	130
Avenger	132
Caliber	134
Omni	134
Intrepid	135
Monaco	136
Neon, SX 2.0	136
Stratus	138
Dodge RWD	
Challenger, Charger, Magnum (New Style)	140
Viper	140
Dodge Import	
Colt, Colt Vista, Stealth, 2000 GTX	142
Dodge Minivan	
Caravan, Grand Caravan	145
Dodge Lt Truck, SUV	
Ram 50	147
Dakota, Durango, Nitro	150
Dodge 1/2 ton Truck	
B150, B1500 VANS, D150 PICKUP, Ram 1500 PICKUP, Ram 1500 VAN, Ramcharger, W150 Pickup	152

Manufacturer / Model	Page
Dodge 3/4 ton Truck	
Pickup, Van, 250 Series, 2500 Series, Sprinter 2500	158
Dodge 1 ton Truck	
Motor Home, Pickup, Van, 350 Series, 3500 Series, Sprinter 2500	164
Dodge 1-1/2, 2. 2-1/2 ton Truck	
RAM4500, RAM5500	170
Eagle	
Premier, Summit, Talon, Vision, Vista, 2000 GTX	170
Ferrari	
F40, Testarossa, 328GT, 348	174
Ford FWD	
Contour	174
Escort	176
Focus	178
Freestyle	177
Fusion	178
Probe	179
Taurus	180
Tempo	182
Ford AWD	
Five Hundred	182
Freestyle	183
Taurus	183
Tempo	183
Ford RWD	
Country Squire, Crown Victoria, LTD	185
Mustang	186
Thunderbird	189
Ford Import	
Aspire	190
Festiva	191

MANUFACTURER / MODEL TO PAGE NUMBER *continued*

Manufacturer / Model	Page
Ford Lt Truck, SUV	
Aerostar, Bronco II, Explorer, Explorer Sport Trac, Ranger	193
Edge	198
Escape, Escape Hybrid	198
Flex	199
Ford Minivan	
Freestar, Windstar	200
Ford Full Size SUV	
Bronco	201
Excursion	203
Expedition	205
Ford 1/2 ton Truck	
Econoline, E150, F100, F150	206
Ford 3/4 ton Truck	
Econoline, E250, F250	211
Ford 1 ton Truck	
Econoline, E350, F350	217
Ford 1 1/2, 2 1/2 ton Truck	
Motor Home Chassis, F53, F59, 400, 450, 550, 600, 700 Series	222
Geo (See also Chevrolet Import)	
Metro, Prizm, Storm	227
Geo Import SUV	
Tracker	229
GMC Truck	
400, 4000, 4500 (Class 4), 500, 5000, 5500 (Class 5), 6000, 6500 (Class 6), 7000, 7500 (Class 7)	110
Grumman	
Postal Vehicle	235

Manufacturer / Model	Page
Honda	
Accord	235
Accord Hybrid	237
Civic, Civic Hybrid	237
CRX	239
Del Sol	240
Fit	241
Insight	241
Prelude	242
S2000	243
Honda Minivan, SUV, Truck	
CR-V	244
Element	246
Odyssey	247
Passport	248
Pilot	250
Ridgeline	250
Hummer	
Hummer, H1, H2	251
H3	253
Hyundai FWD	
Accent, Azera, Elantra, Excel, Scoupe, Sonata, Tiburon, XG300, XG350	253
Genesis	256
Hyundai Minivan, SUV, Truck	
Entourage	257
Sante Fe	257
Tucson	258
Veracruz	258
Infiniti FWD	
G20, I30, I35	258
Infiniti RWD	
G35, G37, J30, M30, M35, M45, Q45	260

MANUFACTURER / MODEL TO PAGE NUMBER *continued*

Manufacturer / Model	Page
Infiniti SUV	
EX35	262
FX35, FX45	262
QX4	263
QX56	264
International Truck	265
Isotta Fraschini	265
Isuzu FWD	
Impulse, Stylus	265
Isuzu Minivan, SUV, Truck	
Amigo, Ascender, Axiom, Hombre, Oasis, Pickup, Rodeo, Rodeo Sport, Trooper, VehiCROSS	267
Jaguar	274
Jeep	
Liberty	275
Compass, Patriot	276
Cherokee, Commander, Grand Cherokee	277
Sahara, TJ, Wrangler	281
Wagoneer series	284
Comanche	287
Kia	
Amanti, Magentis, Optima, Rio, Rondo, Sedona, Sephia, Spectra	290
Kia SUV	
Borrego	293
Sorento	293
Sportage	294
Laforza	294
Lamborghini	295
Lexus FWD	
ES250, ES300, ES330, ES350	295
Lexus RWD	
GS300, GS350, GS400, GS430, GS450H, GS460, IS250, IS300, IS350, IS F, LS400, LS430, LS460, LS600H, SC300, SC400, SC430	296

Manufacturer / Model	Page
Lexus SUV	
GX470, LX450, LX470, LX570, RX300, RX330, RX350	298
RX400H	301
Lincoln FWD	
Continental	301
MKS	302
Zephyr, MKZ	302
Lincoln RWD	
Continental, LS, Mark Series, Town Car	303
Lincoln SUV, Truck	
Aviator, Blackwood, Mark LT, Navigator	304
MKX	307
Maserati	307
Mazda FWD	
Mazda3, Mazda5, Mazda6, Millenia, MX3, MX6, Protege, 323, 626	308
Mazda RWD	
MX-5 Miata, RX-7, RX-8, 626, 929	312
Mazda SUV, Truck	
B2200, B2300, B2500, B2600, B3000, B4000, CX-7, CX-9, MPV, Navajo, Tribute	314
Mercedes Benz	
100 Series	319
200 Series	319
300 Series	320
400 Series	321
500 Series	321
600 Series	322
Mercedes Benz SUV	
G500, ML Series	323

MANUFACTURER / MODEL TO PAGE NUMBER *continued*

Manufacturer / Model	Page
Mercury FWD	
Capri	324
Cougar	325
Mystique	325
Sable	326
Tracer	326
Mercury AWD	
Milan	329
Montego	329
Topaz	329
Mercury RWD	
Grand Marquis, Marauder	331
Cougar	332
Mercury SUV	
Mariner, Mariner Hybrid	334
Mountaineer	334
Mercury Minivan	
Monterey	338
Villager	337
Merkur	
Scorpio, XR4Ti	338
Mitsubishi FWD	
Diamante, Eclipse, Expo, Galant, Galant Sigma, Lancer, Mirage, Precis, Tredia, 3000GT	338
Mitsubishi Truck, Minivan, SUV	
Endeavor, Mighty Max, Montero, Montero Sport, Outlander, Raider PU, Van	343
Nissan FWD	
Altima, Axxess, Maxima, NX, Pulsar, Sentra, Stanza, Versa	347
Nissan RWD	
240SX, 240Z, 300ZX, 350Z	351

Manufacturer / Model	Page
Nissan AWD/FWD, CUV, Minivan, SUV	
Murano, Rogue, Quest	353
Nissan 4WD/RWD, SUV, Truck	
Armada, D21, Frontier, Pathfinder, Titan, Xterra, X-Trail	354
Oldsmobile FWD	
Achieva, Alero, Cutlass Calais, Cutlass Supreme	358
Aurora	360
Cutlass Ciera, Cutlass Cruiser	360
Eighty-Eight, LSS, Ninety-Eight, Touring Sedan	362
Intrigue	363
Toronado	363
Oldsmobile RWD	
Cruiser Wagon, Custom Cruiser, Eighty-Eight, Ninety -Eight	364
Oldsmobile Minivan, SUV	
Bravada	365
Silhouette	367
Peugeot	368
Plymouth FWD	
Acclaim, Sundance	369
Breeze	371
Horizon	372
Neon	373
Plymouth RWD	
Prowler	374
Plymouth Import	
Colt, Laser	375
Plymouth Minivan (See also Chrysler)	
Grand Voyager, Voyager	378

MANUFACTURER / MODEL TO PAGE NUMBER *continued*

Manufacturer / Model	Page
Pontiac FWD	
Bonneville	380
G5, Pursuit	381
G6	381
Grand Am	382
Grand Prix	384
Sunbird	385
Sunfire	386
Pontiac AWD, FWD	
6000	387
Vibe	389
G8	390
Pontiac RWD	
Grand AM, Grand Prix, GTO	390
Firebird	391
Solstice	393
Pontiac Import	
Firefly (Canada), Optima	393
LeMans	394
Pontiac SUV	
Aztek	395
Torrent	396
Pontiac Minivan	
Montana, Trans Sport	397
Montana SV6	398
Porsche RWD	
911, 928, 944, 968, Boxter, Carrera, Cayman	399
Porsche SUV	
Cayenne	401
Rolls Royce	401

Manufacturer / Model	Page
Rover SUV	
Defender 90, Defender 110, Discovery, Freelander, LR3, Range Rover	402
Saab	
9-2X, 9-3, 9-5, 9-7X, 900, 9000	403
Saturn	
Astra, Aura, Ion, L Series, S Series	405
Sky	407
Saturn Minivan, SUV	
Outlook	407
Relay	407
Vue	408
Scion	
xA, xB, tC	409
Sterling	410
Subaru AWD	
Impreza, Justy, Legacy, Loyale, Outback, SVX, XT	411
Subaru SUV, Truck	
B9 Tribeca, Baja, Forester	414
Suzuki FWD	
Aerio, Esteem, Forenza, Reno, Swift, SX4, Verona	416
Suzuki SUV	
Grand Vitara, Samurai, Sidekick, Vitara, X90, XL7	418
Toyota FWD	
Avalon, Camry, Celica, Corolla, Echo, Matrix, Paseo, Prius, Tercel, Yaris	421
Toyota RWD	
Cressida, MR2, Supra	427
Toyota Minivan, SUV, Truck	
Highlander, Landcruiser, Pickup, Previa, RAV4, Sequoia, Sienna, Tacoma, Tundra, T100, 4Runner	430

MANUFACTURER / MODEL TO PAGE NUMBER *continued*

Manufacturer / Model	Page
Volkswagen	
Cabrio, Cabriolet, Corrado, EOS, Fox, Golf, GTI, Jetta, New Beetle, Passat, R32, Rabbit	437
Phaeton	441
EuroVan, Van, Vanagon	441
Volkswagen SUV	
Touareg	443
Volvo	443
Volvo SUV	
XC90	446
Yugo	447

MODEL TO MANUFACTURER TO PAGE NUMBER

Model	Manufacturer	Page
50	Chevrolet	110
50	GMC	230
60	Chevrolet	110
60	GMC	230
70	Chevrolet	110
70	GMC	230
164	Alfa Romeo	8
240	Volvo	443
260	Volvo	443
300	Chrysler	122
323	Mazda	308
328	Ferrari	174
348	Ferrari	174
405	Peugeot	368
505	Peugeot	368
604	Peugeot	368
740	Volvo	443
760	Volvo	443
780	Volvo	443
825	Sterling	410
827	Sterling	410
850	Volvo	443
900	Saab	403
911	Porsche	399
928	Porsche	399
929	Mazda	312
940	Volvo	443
944	Porsche	399
960	Volvo	443
968	Porsche	399
4500	Chevrolet	110
4500	GMC	230
5000	Chevrolet	110
5000	GMC	230
5500	Chevrolet	110
5500	GMC	230
6000	Chevrolet	110
6000	GMC	230
6000	Pontiac	387
6500	Chevrolet	110
6500	GMC	230
7000	Chevrolet	110

Model	Manufacturer	Page
7000	GMC	230
9000	Saab	403
9-3	Saab	403
9-5	Saab	403
100 Series	Mercedes Benz	319
100s	Audi	15
128i	BMW	20
135i	BMW	20
2.2CL	Acura	1
2.3CL	Acura	1
2.5TL	Acura	1
200 Series	Mercedes Benz	319
2000 GTX	Dodge	142
2000 GTX	Eagle	170
200s	Audi	15
228i	Maserati	307
240SX	Nissan	351
3.0CL	Acura	1
3.2CL	Acura	1
3.2TL	Acura	1
3.5RL	Acura	1
300 Series	Mercedes Benz	320
3000GT	Mitsubishi	338
300M	Chrysler	119
300ZX	Nissan	351
318i	BMW	21
318is	BMW	21
318ti	BMW	21
320i	BMW	21
323Ci	BMW	21
323i	BMW	21
323is	BMW	21
325Ci	BMW	21
325i	BMW	21
325is	BMW	21
325iX	BMW	21
325xi	BMW	21
328Ci	BMW	21
328i	BMW	21
328is	BMW	21
328xi	BMW	21
330Ci	BMW	21

MODEL TO MANUFACTURER TO PAGE NUMBER *continued*

Model	Manufacturer	Page
330i	BMW	21
330xi	BMW	21
335d	BMW	21
335i	BMW	21
335xi	BMW	21
350Z	Nissan	351
400 Series	Mercedes Benz	321
430i	Maserati	307
4Runner	Toyota	430
500 Series	Mercedes Benz	321
525i	BMW	24
525iT	BMW	24
525xi	BMW	24
528i	BMW	24
528xi	BMW	24
530i	BMW	24
530xi	BMW	24
535i	BMW	24
535xi	BMW	24
540i	BMW	24
545i	BMW	24
550i	BMW	24
600 Series	Mercedes Benz	322
626 FWD	Mazda	308
626 RWD	Mazda	312
645Ci	BMW	27
650i	BMW	27
735i	BMW	27
735iL	BMW	27
740i	BMW	27
740iL	BMW	27
745i	BMW	27
745Li	BMW	27
750i	BMW	27
750iL	BMW	27
750Li	BMW	27
760i	BMW	27
760Li	BMW	27
80s	Audi	15
840Ci	BMW	29
850Ci	BMW	29
850CSi	BMW	29

Model	Manufacturer	Page
850i	BMW	29
90s	Audi	15
9-2X	Saab	403
9-7X	Saab	403
A3	Audi	10
A4	Audi	10
A6	Audi	10
A8	Audi	10
Acadia	Chevrolet	71
Accent	Hyundai	253
Acclaim	Plymouth	369
Accord	Honda	235
Accord Hybrid	Honda	237
Achieva	Oldsmobile	358
Aerio	Suzuki	416
Aerostar	Ford	193
Alero	Oldsmobile	358
Allante	Cadillac	43
Allroad Quattro	Audi	17
Allure	Buick	33
Altima	Nissan	347
Amanti	Kia	290
Amigo	Isuzu	267
Armada	Nissan	354
Ascender	Isuzu	267
Aspen	Chrysler	124
Aspire	Ford	190
Aston Martin	Aston Martin	9
Astra	Saturn	405
Astro	Chevrolet	71
Aura	Saturn	405
Aurora	Oldsmobile	360
Avalanche 1500	Chevrolet	84
Avalanche 2500	Chevrolet	93
Avalon	Toyota	421
Avanti	Avanti	19
Avanti II	Avanti	19
Avenger	Dodge	132
Aveo	Chevrolet	54
Aveo5	Chevrolet	54
Aviator	Lincoln	304
Axiom	Isuzu	267

MODEL TO MANUFACTURER TO PAGE NUMBER *continued*

Model	Manufacturer	Page
Axxess	Nissan	347
Azera	Hyundai	253
Aztek	Pontiac	395
B150	Dodge	152
B1500	Dodge	152
B2200	Mazda	314
B2300	Mazda	314
B250	Dodge	158
B2500	Dodge	158
B2500	Mazda	314
B2600	Mazda	314
B3000	Mazda	314
B350	Dodge	164
B3500	Dodge	164
B4000	Mazda	314
B9 Tribeca	Subaru	414
Baja	Subaru	414
Beretta	Chevrolet	55
Blackwood	Lincoln	304
Blazer	Chevrolet	85
Bonneville	Pontiac	380
Borrego	Kia	293
Boxster	Porsche	399
Bravada	Oldsmobile	365
Breeze	Plymouth	371
Bronco	Ford	201
Bronco II	Ford	193
Bus	Volkswagen	441
C1500	Chevrolet	85
C30	Volvo	443
C70	Volvo	443
Cabrio	Volkswagen	437
Cabriolet	Audi	10
Cabriolet	Volkswagen	437
Caliber	Dodge	134
Camaro	Chevrolet	63
Camry	Toyota	421
Camry Solara	Toyota	421
Canyon	GMC	74
Capri	Mercury	324
Caprice RWD (From 1994)	Chevrolet	65
Caprice RWD (Thru 1993)	Chevrolet	62

Model	Manufacturer	Page
Caravan	Dodge	145
Carrera	Porsche	399
Catera	Cadillac	49
Cavalier	Chevrolet	55
Cayenne	Porsche	401
Cayman	Porsche	399
Celebrity	Chevrolet	57
Celica	Toyota	421
Century	Buick	31
Challenger	Dodge	140
Charade	Daihatsu	129
Charger	Dodge	140
Cherokee	Jeep	277
Cirrus	Chrysler	117
Civic	Honda	237
Civic Hybrid	Honda	237
Cobalt	Chevrolet	58
Cobra	Ford	186
Colorado	Chevrolet	74
Colt	Dodge	142
Colt	Plymouth	375
Comanche	Jeep	287
Commander	Jeep	277
Commercial Chassis	Cadillac	48
Compass	Jeep	276
Concorde	Chrysler	119
Continental	Bentley	20
Continental FWD	Lincoln	301
Continental RWD	Lincoln	303
Contour	Ford	174
Corniche	Rolls Royce	401
Corolla	Toyota	421
Corolla FX	Toyota	421
Corrado	Volkswagen	437
Corsica	Chevrolet	55
Corvette	Chevrolet	66
Cougar FWD	Mercury	325
Cougar RWD	Mercury	332
Country Squire	Ford	185
Coupe	Audi	14
Coupe Quattro	Audi	14
Cressida	Toyota	427

MODEL TO MANUFACTURER TO PAGE NUMBER *continued*

Model	Manufacturer	Page
Crossfire	Chrysler	121
Crown Victoria	Ford	185
Cruiser Wagon	Oldsmobile	364
CR-V	Honda truck	244
CRX	Honda	239
CTS	Cadillac	49
Cutlass Calais	Oldsmobile	358
Cutlass Ciera	Oldsmobile	360
Cutlass Cruiser	Oldsmobile	360
Cutlass Supreme	Oldsmobile	358
CX-7	Mazda	314
CX-9	Mazda	314
D150	Dodge	152
D21	Nissan	354
D250	Dodge	158
D350	Dodge	164
Dakota	Dodge	150
Daytona	Chrysler	119
Daytona	Dodge	130
Defender 110	Land Rover	402
Defender 90	Land Rover	402
Del Sol	Honda	240
DeVille FWD	Cadillac	44
DeVille RWD	Cadillac	48
Diamante	Mitsubishi	338
Discovery	Land Rover	402
DTS	Cadillac	45
Durango	Dodge	150
Dynasty	Chrysler	119
Dynasty	Dodge	130
E-150	Ford	206
E-150 Econoline	Ford	206
E-250	Ford	211
E-250 Econoline	Ford	211
E-350	Ford	217
E-350 Econoline	Ford	217
E-450 Super Duty	Ford	222
E-550 Super Duty	Ford	222
Echo	Toyota	421
Eclipse	Mitsubishi	338
Edge	Ford	198
Eight	Bentley	20

Model	Manufacturer	Page
Eighty-Eight FWD	Oldsmobile	362
Eighty-Eight RWD	Oldsmobile	364
Elantra	Hyundai	253
Eldorado	Cadillac	46
Electra	Buick	32
Element	Honda truck	246
Enclave	Buick	41
Endeavor	Mitsubishi	343
Entourage	Hyundai	257
Envoy	GMC	75
EOS	Volkswagen	437
Equinox	Chevrolet	76
ES250	Lexus	295
ES300	Lexus	295
ES330	Lexus	295
ES350	Lexus	295
Escalade	Cadillac	52
Escape	Ford	198
Escort	Ford	176
Estate Wagon	Buick	37
Esteem	Suzuki	416
EuroVan	Volkswagen	441
EX35	Infiniti	262
Excel	Hyundai	253
Excursion	Ford	203
Expedition	Ford	205
Explorer	Ford	193
Explorer Sport Trac	Ford	193
Expo	Mitsubishi	338
Express 1500	Chevrolet	91
Express 2500	Chevrolet	100
Express 3500	Chevrolet	108
F-150	Ford	206
F-250	Ford	211
F-250 Super Duty	Ford	211
F-350	Ford	217
F-350 Super Duty	Ford	217
F40	Ferrari	174
F-450 Super Duty	Ford	222
F53	Ford	222
F-550 Super Duty	Ford	222
F59	Ford	222

MODEL TO MANUFACTURER TO PAGE NUMBER *continued*

Model	Manufacturer	Page
Festiva	Ford	191
Firebird	Pontiac	391
Firefly (Canada)	Pontiac	393
Fit	Honda	241
Five Hundred	Ford	182
Fleetwood FWD	Cadillac	44
Fleetwood RWD	Cadillac	48
Flex	Ford	199
Focus	Ford	178
Forenza	Suzuki	416
Forester	Subaru	414
Fox	Volkswagen	437
Fraschini	Isotta Fraschini	265
Freelander	Land Rover	402
Freestar	Ford	200
Freestyle AWD	Ford	183
Freestyle FWD	Ford	177
Frontier	Nissan	354
Fusion	Ford	178
FX35	Infiniti	262
FX45	Infiniti	262
G10	Chevrolet	91
G15	GMC	91
G20	Chevrolet	100
G20	Infiniti	258
G25	GMC	100
G30	Chevrolet	108
G35	GMC	108
G35	Infiniti	260
G37	Infiniti	260
G5	Pontiac	381
G500	Mercedes Benz	323
G55	Mercedes Benz	323
G6	Pontiac	381
G8	Pontiac	390
Galant	Mitsubishi	338
Galant Sigma	Mitsubishi	338
Genesis	Hyundai	256
Golf	Volkswagen	437
Grand Am	Pontiac	382
Grand Caravan	Dodge	145
Grand Cherokee	Jeep	277

Model	Manufacturer	Page
Grand Marquis	Mercury	331
Grand Prix	Pontiac	384
Grand Vitara	Suzuki	418
Grand Voyager	Chrysler	126
Grand Voyager	Plymouth	378
GS300	Lexus	296
GS350	Lexus	296
GS400	Lexus	296
GS430	Lexus	296
GS450H	Lexus	296
GS460	Lexus	296
GT	Ford	186
GTI	Volkswagen	437
GTO	Pontiac	390
GX470	Lexus	298
H1	Hummer	251
H2	Hummer	251
H3	Hummer	253
HHR	Chevrolet	76
Highlander	Toyota	430
Hombre	Isuzu	267
Horizon	Plymouth	372
Hummer	Hummer	251
I30	Infiniti	258
I35	Infiniti	258
Impala FWD	Chevrolet	58
Impala RWD	Chevrolet	65
Imperial	Chrysler	119
Impreza	Subaru	411
Impulse	Isuzu	265
Insight	Honda	241
Integra	Acura	1
International Truck	International	265
Intrepid	Dodge	135
Intrigue	Oldsmobile	363
Ion	Saturn	405
IROC	Chevrolet	63
IS F	Lexus	296
IS250	Lexus	296
IS300	Lexus	296
IS350	Lexus	296
J30	Infiniti	260

MODEL TO MANUFACTURER TO PAGE NUMBER *continued*

Model	Manufacturer	Page
Jetta	Volkswagen	437
Jimmy	GMC	85
Justy	Subaru	411
K1500	Chevrolet	85
L Series	Saturn	405
LaCrosse	Buick	33
Laforza	Laforza	294
Lamborghini	Lamborghini	295
Lancer	Mitsubishi	338
Landcruiser	Toyota	430
Lanos	Daewoo	128
Laser	Plymouth	375
LeBaron	Chrysler	119
Legacy	Subaru	411
Leganza	Daewoo	128
Legend	Acura	1
LeMans	Pontiac	394
LeSabre FWD	Buick	32
LeSabre RWD	Buick	37
LHS	Chrysler	119
Liberty	Jeep	275
Loyale	Subaru	411
LR2	Land Rover	402
LR3	Land Rover	402
LS	Lincoln	303
LS400	Lexus	296
LS430	Lexus	296
LS460	Lexus	296
LS600H	Lexus	296
LSS	Oldsmobile	362
LTD	Ford	185
Lucerne	Buick	34
Lumina	Chevrolet	58
Lumina APV	Chevrolet	77
LX450	Lexus	298
LX470	Lexus	298
LX570	Lexus	298
M3	BMW	21
M30	Infiniti	260
M35	Infiniti	260
M45	Infiniti	260
M5	BMW	24

Model	Manufacturer	Page
M6	BMW	27
Mach 1	Ford	186
Magentis	Kia	290
Magnum	Dodge	140
Malibu	Chevrolet	60
Malibu Fleet Classic	Chevrolet	60
Marauder	Mercury	331
Mariner	Mercury	334
Mariner Hybrid	Mercury	334
Mark LT	Lincoln	304
Mark Series	Lincoln	303
Marquis	Mercury	331
Matrix	Toyota	421
Maxima FWD	Nissan	347
Maxima RWD	Nissan	351
Mazda3	Mazda	308
Mazda5	Mazda	308
Mazda6	Mazda	308
MDX	Acura	6
Metro	Chevrolet	68
Metro	Geo	227
Mighty Max	Mitsubishi	343
Milan	Mercury	329
Millenia	Mazda	308
Mini Cooper	BMW	20
Mirage	Mitsubishi	338
MKS	Lincoln	302
MKX	Lincoln	307
MKZ	Lincoln	302
ML Series	Mercedes Benz	323
Monaco	Dodge	136
Montana	Pontiac	397
Montana SV6	Pontiac	398
Monte Carlo	Chevrolet	58
Montego	Mercury	329
Monterey	Mercury	338
Montero	Mitsubishi	343
Montero Sport	Mitsubishi	343
Mountaineer	Mercury	334
MPV	Mazda	314
MR2	Toyota	427
Mulsanne	Bentley	20

MODEL TO MANUFACTURER TO PAGE NUMBER *continued*

Model	Manufacturer	Page
Murano	Nissan	353
Mustang	Ford	186
MX3	Mazda	308
MX-5 Miata	Mazda	312
MX6	Mazda	308
Mystique	Mercury	325
Navajo	Mazda	314
Navigator	Lincoln	304
Neon	Chrysler	121
Neon	Dodge	136
Neon	Plymouth	373
New Beetle	Volkswagen	437
New Yorker	Chrysler	119
Ninety-Eight FWD	Oldsmobile	362
Ninety-Eight RWD	Oldsmobile	364
Nitro	Dodge	150
NSX	Acura	1
Nubira	Daewoo	128
NX	Nissan	347
Oasis	Isuzu	267
Odyssey	Honda truck	247
Omni	Dodge	134
Optima	Kia	290
Optima	Pontiac	393
Optra	Chevrolet	58
Outback	Subaru	411
Outlander	Mitsubishi	343
Outlook	Saturn	407
P30	Chevrolet	108
P35	GMC	108
Pacifica	Chrysler	123
Park Avenue	Buick	32
Paseo	Toyota	421
Passat	Volkswagen	437
Passport	Honda truck	248
Pathfinder	Nissan	354
Patriot	Jeep	276
Phaeton	Volkswagen	441
Pickup	Isuzu	267
Pickup	Toyota	430
Pilot	Honda truck	250
Postal Vehicle	Grumman	235

Model	Manufacturer	Page
Precis	Mitsubishi	338
Prelude	Honda	242
Premier	Eagle	170
Previa	Toyota	430
Prius	Toyota	421
Prizm	Chevrolet	68
Prizm	Geo	227
Probe	Ford	179
Protégé	Mazda	308
Prowler	Chrysler	121
Prowler	Plymouth	374
PT Cruiser	Chrysler	125
Pulsar	Nissan	347
Pursuit	Pontiac	381
Q45	Infiniti	260
Q7	Audi	18
Quest	Nissan	353
QX4	Infiniti	263
QX56	Infiniti	264
R32	Volkswagen	437
Rabbit	Volkswagen	437
Raider PU	Mitsubishi	343
Rainier	Buick	41
Ram 1500	Dodge	152
Ram 2500	Dodge	158
Ram 3500	Dodge	164
RAM 4500	Dodge	170
Ram 50	Dodge	147
RAM 5500	Dodge	170
Ramcharger	Dodge	152
Range Rover	Land Rover	402
Ranger	Ford	193
RAV4	Toyota	430
RDX	Acura	7
Reatta	Buick	35
Regal	Buick	34
Relay	Saturn	407
Rendezvous	Buick	42
Ridgeline	Honda truck	250
Rio	Kia	290
Riviera	Buick	35
Roadmaster	Buick	38

MODEL TO MANUFACTURER TO PAGE NUMBER *continued*

Model	Manufacturer	Page
Rocky	Daihatsu	130
Rodeo	Isuzu	267
Rodeo Sport	Isuzu	267
Rogue	Nissan	353
Rondo	Kia	290
RS4	Audi	10
RS6	Audi	10
RSX	Acura	1
RX300	Lexus	298
RX330	Lexus	298
RX350	Lexus	298
RX400H	Lexus	301
RX-7	Mazda	312
RX-8	Mazda	312
S Series	Saturn	405
S10 Blazer	Chevrolet	78
S10 Pickup	Chevrolet	78
S15 Jimmy	GMC	78
S15 Sonoma	GMC	78
S2000	Honda	243
S4	Audi	10
S40	Volvo	443
S5	Audi	10
S6	Audi	10
S60	Volvo	443
S8	Audi	10
S80	Volvo	443
Sable	Mercury	326
Safari	GMC	71
Sahara	Jeep	281
Samurai	Suzuki	418
Sante Fe	Hyundai	257
Savana 1500	GMC	91
Savana 2500	GMC	100
Savana 3500	GMC	108
SC300	Lexus	296
SC400	Lexus	296
SC430	Lexus	296
Scion tC	Scion	409
Scion xA	Scion	409
Scion xB	Scion	409
Scorpio	Mercur	338

Model	Manufacturer	Page
Scoupe	Hyundai	253
Sebring	Chrysler	117
Sedona	Kia	290
Sentra	Nissan	347
Sephia	Kia	290
Sequoia	Toyota	430
Seville	Cadillac	47
Shadow	Dodge	130
Shelby	Ford	186
Sidekick	Suzuki	418
Sienna	Toyota	430
Sierra 1500	GMC	85
Sierra 2500	GMC	95
Sierra 3500	GMC	103
Silhouette	Oldsmobile	367
Silver	Rolls Royce	401
Silverado 1500	Chevrolet	85
Silverado 2500	Chevrolet	95
Silverado 3500	Chevrolet	103
Sky	Saturn	407
Skylark	Buick	36
SLX	Acura	7
Solstice	Pontiac	393
Sonata	Hyundai	253
Sorento	Kia	293
Spectra	Kia	290
Spider	Alfa Romeo	8
Spirit	Dodge	130
Sportage	Kia	294
Sprint	Chevrolet	68
Sprinter 2500	Dodge	158
Sprinter 3500	Dodge	164
Spyder	Maserati	307
SRX	Cadillac	54
SSR	Chevrolet	82
Stanza	Nissan	347
Stealth	Dodge	142
Storm	Geo	227
Stratus	Dodge	138
STS	Cadillac	50
Stylus	Isuzu	265
S-Type	Jaguar	274

MODEL TO MANUFACTURER TO PAGE NUMBER *continued*

Model	Manufacturer	Page
Suburban 1500	Chevrolet	85
Suburban 1500	GMC	85
Suburban 2500	Chevrolet	95
Suburban 2500	GMC	95
Summit	Eagle	170
Sunbird	Pontiac	385
Sundance	Plymouth	369
Sunfire	Pontiac	386
Super V8	Jaguar	274
Supra	Toyota	427
SVX	Subaru	411
Swift	Suzuki	416
SX 2.0	Dodge	136
SX4	Suzuki	416
Syclone	Chevrolet	78
T100	Toyota	430
Tacoma	Toyota	430
Tahoe	Chevrolet	85
Talon	Eagle	170
Taurus AWD	Ford	183
Taurus FWD	Ford	180
TC Maserati	Chrysler	123
Tempo AWD	Ford	183
Tempo FWD	Ford	182
Tercel	Toyota	421
Tercel Wagon 4WD	Toyota	421
Terraza	Buick	40
Testarossa	Ferrari	174
Thunderbird	Ford	189
Tiburon	Hyundai	253
Titan	Nissan	354
TJ	Jeep	281
Topaz	Mercury	330
Toronado	Oldsmobile	363
Torrent	Pontiac	396
Touareg	Volkswagen	443
Touring Sedan	Oldsmobile	362
Town & Country	Chrysler	126
Town Car	Lincoln	303
Tracer	Mercury	328
Tracker	Chevrolet	69
Tracker	Geo	229

Model	Manufacturer	Page
Trailblazer	Chevrolet	75
TransSport	Pontiac	397
Tribute	Mazda	314
Trooper	Isuzu	267
TSX	Acura	1
TT	Audi	10
Tucson	Hyundai	258
Tundra	Toyota	430
Turbo R	Bentley	20
Typhoon	GMC	78
Uplander	Chevrolet	83
V50	Volvo	443
V70	Volvo	443
V8 Quattro	Audi	10
Van	Mitsubishi	343
Van	Volkswagen	441
Vanden Plas	Jaguar	274
VehiCROSS	Isuzu	267
Venture	Chevrolet	77
Veracruz	Hyundai	258
Verona	Suzuki	416
Versa	Nissan	347
Vibe	Pontiac	389
Vigor	Acura	1
Villager	Mercury	337
Viper	Dodge	140
Vision	Eagle	170
Vista	Eagle	170
Vitara	Suzuki	418
Voyager	Chrysler	126
Voyager	Plymouth	378
Vue	Saturn	408
W150	Dodge	152
W250	Dodge	158
W350	Dodge	164
Wagoneer	Jeep	284
Windstar	Ford	200
Wrangler	Jeep	281
X3	BMW	30
X5	BMW	30
X6	BMW	30
X90	Suzuki	418

MODEL TO MANUFACTURER TO PAGE NUMBER *continued*

Model	Manufacturer	Page
XC70	Volvo	443
XC90	Volvo	446
XG300	Hyundai	253
XG350	Hyundai	253
XJ12	Jaguar	274
XJ6	Jaguar	274
XJ8	Jaguar	274
XJR	Jaguar	274
XJS	Jaguar	274
XK8	Jaguar	274
XL7	Suzuki	418
XLR	Cadillac	51
XR4Ti	Merkur	338
XT	Subaru	411
Xterra	Nissan	354
X-Trail	Nissan	354
X-Type	Jaguar	274
Yaris	Toyota	421
Yugo	Yugo	447
Yukon	GMC	85
Yukon XL 2500	GMC	95
Z-28	Chevrolet	63
Z3	BMW	21
Z4	BMW	23
Z8	BMW	29
Zephyr	Lincoln	302

MANUFACTURER TO MODEL TO PAGE NUMBER

Manufacturer	Model	Page
Acura	2.2CL	1
Acura	2.3CL	1
Acura	2.5TL	1
Acura	3.0CL	1
Acura	3.2CL	1
Acura	3.2TL	1
Acura	3.5RL	1
Acura	Integra	1
Acura	Legend	1
Acura	MDX	6
Acura	NSX	1
Acura	RDX	7
Acura	RSX	1
Acura	SLX	7
Acura	TSX	1
Acura	Vigor	1
Alfa Romeo	164	8
Alfa Romeo	Spider	8
Aston Martin	Aston Martin	9
Audi	100s	15
Audi	200s	15
Audi	80s	15
Audi	90s	15
Audi	A3	10
Audi	A4	10
Audi	A6	10
Audi	A8	10
Audi	Allroad Quattro	17
Audi	Cabriolet	10
Audi	Coupe	14
Audi	Coupe Quattro	14
Audi	Q7	18
Audi	RS4	10
Audi	RS6	10
Audi	S4	10
Audi	S5	10
Audi	S6	10
Audi	S8	10
Audi	TT	10
Audi	V8 Quattro	10
Avanti	Avanti	19
Avanti	Avanti II	19

Manufacturer	Model	Page
Bentley	Continental	20
Bentley	Eight	20
Bentley	Mulsanne	20
Bentley	Turbo R	20
BMW	128i	20
BMW	135i	20
BMW	318i	21
BMW	318is	21
BMW	318ti	21
BMW	320i	21
BMW	323Ci	21
BMW	323i	21
BMW	323is	21
BMW	325Ci	21
BMW	325i	21
BMW	325is	21
BMW	325iX	21
BMW	325xi	21
BMW	328Ci	21
BMW	328i	21
BMW	328is	21
BMW	328xi	21
BMW	330Ci	21
BMW	330i	21
BMW	330xi	21
BMW	335d	21
BMW	335i	21
BMW	335xi	21
BMW	525i	24
BMW	525iT	24
BMW	525xi	24
BMW	528i	24
BMW	528xi	24
BMW	530i	24
BMW	530xi	24
BMW	535i	24
BMW	535xi	24
BMW	540i	24
BMW	545i	24
BMW	550i	24
BMW	645Ci	27
BMW	650i	27

MANUFACTURER TO MODEL TO PAGE NUMBER *continued*

Manufacturer	Model	Page
BMW	735i	27
BMW	735iL	27
BMW	740i	27
BMW	740iL	27
BMW	745i	27
BMW	745Li	27
BMW	750i	27
BMW	750iL	27
BMW	750Li	27
BMW	760i	27
BMW	760Li	27
BMW	840Ci	29
BMW	850Ci	29
BMW	850CSi	29
BMW	850i	29
BMW	M3	21
BMW	M5	24
BMW	M6	27
BMW	Mini Cooper	20
BMW	X3	30
BMW	X5	30
BMW	X6	30
BMW	Z3	21
BMW	Z4	23
BMW	Z8	29
Buick	Allure	33
Buick	Century	31
Buick	Electra	32
Buick	Enclave	41
Buick	Estate Wagon	37
Buick	LaCrosse	33
Buick	LeSabre FWD	32
Buick	LeSabre RWD	37
Buick	Lucerne	34
Buick	Park Avenue	32
Buick	Rainier	41
Buick	Reatta	35
Buick	Regal	34
Buick	Rendezvous	42
Buick	Riviera	35
Buick	Roadmaster	38
Buick	Skylark	36

Manufacturer	Model	Page
Buick	Terraza	40
Cadillac	Allante	43
Cadillac	Catera	49
Cadillac	Commercial Chassis	48
Cadillac	CTS	49
Cadillac	DeVille FWD	44
Cadillac	DeVille RWD	48
Cadillac	DTS	45
Cadillac	Eldorado	46
Cadillac	Escalade	52
Cadillac	Fleetwood FWD	44
Cadillac	Fleetwood RWD	48
Cadillac	Seville	47
Cadillac	SRX	54
Cadillac	STS	50
Cadillac	XLR	51
Chevrolet	50	110
Chevrolet	60	110
Chevrolet	70	110
Chevrolet	4500	110
Chevrolet	5000	110
Chevrolet	5500	110
Chevrolet	6000	110
Chevrolet	6500	110
Chevrolet	7000	110
Chevrolet	Acadia	71
Chevrolet	Astro	71
Chevrolet	Avalanche 1500	84
Chevrolet	Avalanche 2500	93
Chevrolet	Aveo	54
Chevrolet	Aveo5	54
Chevrolet	Beretta	55
Chevrolet	Blazer	85
Chevrolet	C1500	85
Chevrolet	Camaro	63
Chevrolet	Caprice RWD (From 1994)	65
Chevrolet	Caprice RWD (Thru 1993)	62
Chevrolet	Cavalier	55
Chevrolet	Celebrity	57
Chevrolet	Cobalt	58
Chevrolet	Colorado	74
Chevrolet	Corsica	55

MANUFACTURER TO MODEL TO PAGE NUMBER *continued*

Manufacturer	Model	Page
Chevrolet	Corvette	66
Chevrolet	Equinox	76
Chevrolet	Express 1500	91
Chevrolet	Express 2500	100
Chevrolet	Express 3500	108
Chevrolet	G10	91
Chevrolet	G20	100
Chevrolet	G30	108
Chevrolet	HHR	76
Chevrolet	Impala FWD	58
Chevrolet	Impala RWD	65
Chevrolet	IROC	63
Chevrolet	K1500	85
Chevrolet	Lumina	58
Chevrolet	Lumina APV	77
Chevrolet	Malibu	60
Chevrolet	Malibu Fleet Classic	60
Chevrolet	Metro	68
Chevrolet	Monte Carlo	58
Chevrolet	Optra	58
Chevrolet	P30	108
Chevrolet	Prizm	68
Chevrolet	S10 Blazer	78
Chevrolet	S10 Pickup	78
Chevrolet	Silverado 1500	85
Chevrolet	Silverado 2500	95
Chevrolet	Silverado 3500	103
Chevrolet	Sprint	68
Chevrolet	SSR	82
Chevrolet	Suburban 1500	85
Chevrolet	Suburban 2500	95
Chevrolet	Syclone	78
Chevrolet	Tahoe	85
Chevrolet	Tracker	69
Chevrolet	Trailblazer	75
Chevrolet	Uplander	83
Chevrolet	Venture	77
Chevrolet	Z-28	63
Chrysler	300	122
Chrysler	300M	119
Chrysler	Aspen	124
Chrysler	Cirrus	117

Manufacturer	Model	Page
Chrysler	Concorde	119
Chrysler	Crossfire	121
Chrysler	Daytona	119
Chrysler	Dynasty	119
Chrysler	Grand Voyager	126
Chrysler	Imperial	119
Chrysler	LeBaron	119
Chrysler	LHS	119
Chrysler	Neon	121
Chrysler	New Yorker	119
Chrysler	Pacifica	123
Chrysler	Prowler	121
Chrysler	PT Cruiser	125
Chrysler	Sebring	117
Chrysler	TC Maserati	123
Chrysler	Town & Country	126
Chrysler	Voyager	126
Daewoo	Lanos	128
Daewoo	Leganza	128
Daewoo	Nubira	128
Daihatsu	Charade	129
Daihatsu	Rocky	130
Dodge	2000 GTX	142
Dodge	Avenger	132
Dodge	B150	152
Dodge	B1500	152
Dodge	B250	158
Dodge	B2500	158
Dodge	B350	164
Dodge	B3500	164
Dodge	Caliber	134
Dodge	Caravan	145
Dodge	Challenger	140
Dodge	Charger	140
Dodge	Colt	142
Dodge	D150	152
Dodge	D250	158
Dodge	D350	164
Dodge	Dakota	150
Dodge	Daytona	130
Dodge	Durango	150
Dodge	Dynasty	130

MANUFACTURER TO MODEL TO PAGE NUMBER *continued*

Manufacturer	Model	Page
Dodge	Grand Caravan	145
Dodge	Intrepid	135
Dodge	Magnum	140
Dodge	Monaco	136
Dodge	Neon	136
Dodge	Nitro	150
Dodge	Omni	134
Dodge	Ram 1500	152
Dodge	Ram 2500	158
Dodge	Ram 3500	164
Dodge	RAM 4500	170
Dodge	Ram 50	147
Dodge	RAM 5500	170
Dodge	Ramcharger	152
Dodge	Shadow	130
Dodge	Spirit	130
Dodge	Sprinter 2500	158
Dodge	Sprinter 3500	164
Dodge	Stealth	142
Dodge	Stratus	138
Dodge	SX 2.0	136
Dodge	Viper	140
Dodge	W150	152
Dodge	W250	158
Dodge	W350	164
Eagle	2000 GTX	170
Eagle	Premier	170
Eagle	Summit	170
Eagle	Talon	170
Eagle	Vision	170
Eagle	Vista	170
Ferrari	328	174
Ferrari	348	174
Ferrari	F40	174
Ferrari	Testarossa	174
Ford	Aerostar	193
Ford	Aspire	190
Ford	Bronco	201
Ford	Bronco II	193
Ford	Cobra	186
Ford	Contour	174
Ford	Country Squire	185

Manufacturer	Model	Page
Ford	Crown Victoria	185
Ford	E-150	206
Ford	E-150 Econoline	206
Ford	E-250	211
Ford	E-250 Econoline	211
Ford	E-350	217
Ford	E-350 Econoline	217
Ford	E-450 Super Duty	222
Ford	E-550 Super Duty	222
Ford	Edge	198
Ford	Escape	198
Ford	Escort	176
Ford	Excursion	203
Ford	Expedition	205
Ford	Explorer	193
Ford	Explorer Sport Trac	193
Ford	F-150	206
Ford	F-250	211
Ford	F-250 Super Duty	211
Ford	F-350	217
Ford	F-350 Super Duty	217
Ford	F-450 Super Duty	222
Ford	F53	222
Ford	F-550 Super Duty	222
Ford	F59	222
Ford	Festiva	191
Ford	Five Hundred	182
Ford	Flex	199
Ford	Focus	178
Ford	Freestar	200
Ford	Freestyle AWD	183
Ford	Freestyle FWD	177
Ford	Fusion	178
Ford	GT	186
Ford	LTD	185
Ford	Mach 1	186
Ford	Mustang	186
Ford	Probe	179
Ford	Ranger	193
Ford	Shelby	186
Ford	Taurus AWD	183
Ford	Taurus FWD	180

MANUFACTURER TO MODEL TO PAGE NUMBER *continued*

Manufacturer	Model	Page
Ford	Tempo AWD	183
Ford	Tempo FWD	182
Ford	Thunderbird	189
Ford	Windstar	200
Geo	Metro	227
Geo	Prizm	227
Geo	Storm	227
Geo	Tracker	229
GMC	50	230
GMC	60	230
GMC	70	230
GMC	4500	230
GMC	5000	230
GMC	5500	230
GMC	6000	230
GMC	6500	230
GMC	7000	230
GMC	Canyon	74
GMC	Envoy	75
GMC	G15	91
GMC	G25	100
GMC	G35	108
GMC	Jimmy	85
GMC	P35	108
GMC	S15 Jimmy	78
GMC	S15 Sonoma	78
GMC	Safari	71
GMC	Savana 1500	91
GMC	Savana 2500	100
GMC	Savana 3500	108
GMC	Sierra 1500	85
GMC	Sierra 2500	95
GMC	Sierra 3500	103
GMC	Suburban 1500	85
GMC	Suburban 2500	95
GMC	Typhoon	78
GMC	Yukon	85
GMC	Yukon XL 2500	95
Grumman	Postal Vehicle	235
Honda	Accord	235
Honda	Accord Hybrid	237
Honda	Civic	237

Manufacturer	Model	Page
Honda	Civic Hybrid	237
Honda	CRX	239
Honda	Del Sol	240
Honda	Fit	241
Honda	Insight	241
Honda	Prelude	242
Honda	S2000	243
Honda truck	CR-V	244
Honda truck	Element	246
Honda truck	Odyssey	247
Honda truck	Passport	248
Honda truck	Pilot	250
Honda truck	Ridgeline	250
Hummer	H1	251
Hummer	H2	251
Hummer	H3	253
Hummer	Hummer	251
Hyundai	Accent	253
Hyundai	Azera	253
Hyundai	Elantra	253
Hyundai	Entourage	257
Hyundai	Excel	253
Hyundai	Genesis	256
Hyundai	Sante Fe	257
Hyundai	Scoupe	253
Hyundai	Sonata	253
Hyundai	Tiburon	253
Hyundai	Tucson	258
Hyundai	Veracruz	258
Hyundai	XG300	253
Hyundai	XG350	253
Infiniti	EX35	262
Infiniti	FX35	262
Infiniti	FX45	262
Infiniti	G20	258
Infiniti	G35	260
Infiniti	G37	260
Infiniti	I30	258
Infiniti	I35	258
Infiniti	J30	260
Infiniti	M30	260
Infiniti	M35	260

MANUFACTURER TO MODEL TO PAGE NUMBER *continued*

Manufacturer	Model	Page
Infiniti	M45	260
Infiniti	Q45	260
Infiniti	QX4	263
Infiniti	QX56	264
International	International Truck	265
Isotta Fraschini	Fraschini	265
Isuzu	Amigo	267
Isuzu	Ascender	267
Isuzu	Axiom	267
Isuzu	Hombre	267
Isuzu	Impulse	265
Isuzu	Oasis	267
Isuzu	Pickup	267
Isuzu	Rodeo	267
Isuzu	Rodeo Sport	267
Isuzu	Stylus	265
Isuzu	Trooper	267
Isuzu	VehiCROSS	267
Jaguar	S-Type	274
Jaguar	Super V8	274
Jaguar	Vanden Plas	274
Jaguar	XJ12	274
Jaguar	XJ6	274
Jaguar	XJ8	274
Jaguar	XJR	274
Jaguar	XJS	274
Jaguar	XK8	274
Jaguar	X-Type	274
Jeep	Cherokee	277
Jeep	Comanche	287
Jeep	Commander	277
Jeep	Compass	276
Jeep	Grand Cherokee	277
Jeep	Liberty	275
Jeep	Patriot	276
Jeep	Sahara	281
Jeep	TJ	281
Jeep	Wagoneer	284
Jeep	Wrangler	281
Kia	Amanti	290
Kia	Borrego	293
Kia	Magentis	290

Manufacturer	Model	Page
Kia	Optima	290
Kia	Rio	290
Kia	Rondo	290
Kia	Sedona	290
Kia	Sephia	290
Kia	Sorento	293
Kia	Spectra	290
Kia	Sportage	294
Laforza	Laforza	294
Lamborghini	Lamborghini	295
Land Rover	Defender 110	402
Land Rover	Defender 90	402
Land Rover	Discovery	402
Land Rover	Freelander	402
Land Rover	LR2	402
Land Rover	LR3	402
Land Rover	Range Rover	402
Lexus	ES250	295
Lexus	ES300	295
Lexus	ES330	295
Lexus	ES350	295
Lexus	GS300	296
Lexus	GS350	296
Lexus	GS400	296
Lexus	GS430	296
Lexus	GS450H	296
Lexus	GS460	296
Lexus	GX470	298
Lexus	IS F	296
Lexus	IS250	296
Lexus	IS300	296
Lexus	IS350	296
Lexus	LS400	296
Lexus	LS430	296
Lexus	LS460	296
Lexus	LS600H	296
Lexus	LX450	298
Lexus	LX470	298
Lexus	LX570	298
Lexus	RX300	298
Lexus	RX330	298
Lexus	RX350	298

MANUFACTURER TO MODEL TO PAGE NUMBER *continued*

Manufacturer	Model	Page
Lexus	RX400H	301
Lexus	SC300	296
Lexus	SC400	296
Lexus	SC430	296
Lincoln	Aviator	304
Lincoln	Blackwood	304
Lincoln	Continental FWD	301
Lincoln	Continental RWD	303
Lincoln	LS	303
Lincoln	Mark LT	304
Lincoln	Mark Series	303
Lincoln	MKS	302
Lincoln	MKX	307
Lincoln	MKZ	302
Lincoln	Navigator	304
Lincoln	Town Car	303
Lincoln	Zephyr	302
Maserati	228i	307
Maserati	430i	307
Maserati	Spyder	307
Mazda	323	308
Mazda	929	312
Mazda	626 FWD	308
Mazda	626 RWD	312
Mazda	B2200	314
Mazda	B2300	314
Mazda	B2500	314
Mazda	B2600	314
Mazda	B3000	314
Mazda	B4000	314
Mazda	CX-7	314
Mazda	CX-9	314
Mazda	Mazda3	308
Mazda	Mazda5	308
Mazda	Mazda6	308
Mazda	Millenia	308
Mazda	MPV	314
Mazda	MX3	308
Mazda	MX-5 Miata	312
Mazda	MX6	308
Mazda	Navajo	314
Mazda	Protégé	308

Manufacturer	Model	Page
Mazda	RX-7	312
Mazda	RX-8	312
Mazda	Tribute	314
Mercedes Benz	100 Series	319
Mercedes Benz	200 Series	319
Mercedes Benz	300 Series	320
Mercedes Benz	400 Series	321
Mercedes Benz	500 Series	321
Mercedes Benz	600 Series	322
Mercedes Benz	G500	323
Mercedes Benz	G55	323
Mercedes Benz	ML Series	323
Mercury	Capri	324
Mercury	Cougar FWD	325
Mercury	Cougar RWD	332
Mercury	Grand Marquis	331
Mercury	Marauder	331
Mercury	Mariner	334
Mercury	Mariner Hybrid	334
Mercury	Marquis	331
Mercury	Milan	329
Mercury	Montego	329
Mercury	Monterey	338
Mercury	Mountaineer	334
Mercury	Mystique	325
Mercury	Sable	326
Mercury	Topaz	330
Mercury	Tracer	328
Mercury	Villager	337
Merkur	Scorpio	338
Merkur	XR4Ti	338
Mitsubishi	3000GT	338
Mitsubishi	Diamante	338
Mitsubishi	Eclipse	338
Mitsubishi	Endeavor	343
Mitsubishi	Expo	338
Mitsubishi	Galant	338
Mitsubishi	Galant Sigma	338
Mitsubishi	Lancer	338
Mitsubishi	Mighty Max	343
Mitsubishi	Mirage	338
Mitsubishi	Montero	343

MANUFACTURER TO MODEL TO PAGE NUMBER *continued*

Manufacturer	Model	Page
Mitsubishi	Montero Sport	343
Mitsubishi	Outlander	343
Mitsubishi	Precis	338
Mitsubishi	Raider PU	343
Mitsubishi	Van	343
Nissan	240SX	351
Nissan	300ZX	351
Nissan	350Z	351
Nissan	Altima	347
Nissan	Armada	354
Nissan	Axxess	347
Nissan	D21	354
Nissan	Frontier	354
Nissan	Maxima FWD	347
Nissan	Maxima RWD	351
Nissan	Murano	353
Nissan	NX	347
Nissan	Pathfinder	354
Nissan	Pulsar	347
Nissan	Quest	353
Nissan	Rogue	353
Nissan	Sentra	347
Nissan	Stanza	347
Nissan	Titan	354
Nissan	Versa	347
Nissan	Xterra	354
Nissan	X-Trail	354
Oldsmobile	Achieva	358
Oldsmobile	Alero	358
Oldsmobile	Aurora	360
Oldsmobile	Bravada	365
Oldsmobile	Cruiser Wagon	364
Oldsmobile	Cutlass Calais	358
Oldsmobile	Cutlass Ciera	360
Oldsmobile	Cutlass Cruiser	360
Oldsmobile	Cutlass Supreme	358
Oldsmobile	Eighty-Eight FWD	362
Oldsmobile	Eighty-Eight RWD	364
Oldsmobile	Intrigue	363
Oldsmobile	LSS	362
Oldsmobile	Ninety-Eight FWD	362
Oldsmobile	Ninety-Eight RWD	364

Manufacturer	Model	Page
Oldsmobile	Silhouette	367
Oldsmobile	Toronado	363
Oldsmobile	Touring Sedan	362
Peugeot	405	368
Peugeot	505	368
Peugeot	604	368
Plymouth	Acclaim	369
Plymouth	Breeze	371
Plymouth	Colt	375
Plymouth	Grand Voyager	378
Plymouth	Horizon	372
Plymouth	Laser	375
Plymouth	Neon	373
Plymouth	Prowler	374
Plymouth	Sundance	369
Plymouth	Voyager	378
Pontiac	6000	387
Pontiac	Aztek	395
Pontiac	Bonneville	380
Pontiac	Firebird	391
Pontiac	Firefly (Canada)	393
Pontiac	G5	381
Pontiac	G6	381
Pontiac	G8	390
Pontiac	Grand Am	382
Pontiac	Grand Prix	384
Pontiac	GTO	390
Pontiac	LeMans	394
Pontiac	Montana	397
Pontiac	Montana SV6	398
Pontiac	Optima	393
Pontiac	Pursuit	381
Pontiac	Solstice	393
Pontiac	Sunbird	385
Pontiac	Sunfire	386
Pontiac	Torrent	396
Pontiac	TransSport	397
Pontiac	Vibe	389
Porsche	911	399
Porsche	928	399
Porsche	944	399
Porsche	968	399

MANUFACTURER TO MODEL TO PAGE NUMBER *continued*

Manufacturer	Model	Page
Porsche	Boxster	399
Porsche	Carrera	399
Porsche	Cayenne	401
Porsche	Cayman	399
Rolls Royce	Corniche	401
Rolls Royce	Silver	401
Saab	900	403
Saab	9000	403
Saab	9-3	403
Saab	9-5	403
Saab	9-2X	403
Saab	9-7X	403
Saturn	Astra	405
Saturn	Aura	405
Saturn	Ion	405
Saturn	L Series	405
Saturn	Outlook	407
Saturn	Relay	407
Saturn	S Series	405
Saturn	Sky	407
Saturn	Vue	408
Scion	Scion tC	409
Scion	Scion xA	409
Scion	Scion xB	409
Sterling	825	410
Sterling	827	410
Subaru	B9 Tribeca	414
Subaru	Baja	414
Subaru	Forester	414
Subaru	Impreza	411
Subaru	Justy	411
Subaru	Legacy	411
Subaru	Loyale	411
Subaru	Outback	411
Subaru	SVX	411
Subaru	XT	411
Suzuki	Aerio	416
Suzuki	Esteem	416
Suzuki	Forenza	416
Suzuki	Grand Vitara	418
Suzuki	Samurai	418
Suzuki	Sidekick	418

Manufacturer	Model	Page
Suzuki	Swift	416
Suzuki	SX4	416
Suzuki	Verona	416
Suzuki	Vitara	418
Suzuki	X90	418
Suzuki	XL7	418
Toyota	4Runner	430
Toyota	Avalon	421
Toyota	Camry	421
Toyota	Camry Solara	421
Toyota	Celica	421
Toyota	Corolla	421
Toyota	Corolla FX	421
Toyota	Cressida	427
Toyota	Echo	421
Toyota	Highlander	430
Toyota	Landcruiser	430
Toyota	Matrix	421
Toyota	MR2	427
Toyota	Paseo	421
Toyota	Pickup	430
Toyota	Previa	430
Toyota	Prius	421
Toyota	RAV4	430
Toyota	Sequoia	430
Toyota	Sienna	430
Toyota	Supra	427
Toyota	T100	430
Toyota	Tacoma	430
Toyota	Tercel	421
Toyota	Tercel Wagon 4WD	421
Toyota	Tundra	430
Toyota	Yaris	421
Volkswagen	Bus	441
Volkswagen	Cabrio	437
Volkswagen	Cabriolet	437
Volkswagen	Corrado	437
Volkswagen	EOS	437
Volkswagen	EuroVan	441
Volkswagen	Fox	437
Volkswagen	Golf	437
Volkswagen	GTI	437

MANUFACTURER TO MODEL TO PAGE NUMBER *continued*

Manufacturer	Model	Page
Volkswagen	Jetta	437
Volkswagen	New Beetle	437
Volkswagen	Passat	437
Volkswagen	Phaeton	441
Volkswagen	R32	437
Volkswagen	Rabbit	437
Volkswagen	Touareg	443
Volkswagen	Van	441
Volvo	240	443
Volvo	260	443
Volvo	740	443
Volvo	760	443
Volvo	780	443
Volvo	850	443
Volvo	940	443
Volvo	960	443
Volvo	C30	443
Volvo	C70	443
Volvo	S40	443
Volvo	S60	443
Volvo	S80	443
Volvo	V50	443
Volvo	V70	443
Volvo	XC70	443
Volvo	XC90	446
Yugo	Yugo	447

ABBREVIATION KEY

Abbreviation	Stands For...	Abbreviation	Stands For...	Abbreviation	Stands For...
2Dr	2 Door	Dsl	Diesel	O/S	Output Shaft
2WD	Two Wheel Drive	Elec	Electric	OD	Outside Diameter
4Dr	4 Door	Exc	Except	OE	Original Equipment
4WD	Four Wheel Drive	Exh	Exhaust	OHV	Overhead Valve
A/C	Air Conditioning	Ext	Extension	Opt	Optional
A/T	Automatic Transmission	Flg	Flange	Pass	Passenger
ABS	Antilock Brake System	Frt	Front	Pc	Piece
Acc	Accessory	FWD	Front Wheel Drive	Prod	Production
Amp	Amperage	GVW	Gross Vehicle Weight	PTFE	Tetrafluoro-Ethylene Propylene
Assy	Assembly	GVWR	Gross Vehicle Weight Rating	RG	Ring Gear
ATX	Automatic Transaxle	H/D	Heavy Duty	RH	Right Hand
Auto	Automatic	Harmnc	Harmonic	Rlr	Roller
AWD	All Wheel Drive	HD	Heavy Duty	Rpr	Repair
Bbl	Barrel	HO	High Output	Rr	Rear
Brg	Bearing	Hsg	Housing	RWD	Rear Wheel Drive
Brks	Brakes	Hyd	Hydraulic	Ser	Series
C/S	Counter Shaft	I/S	Input Shaft	Shft	Shaft
Carb	Carburetor	ID	Inside Diameter	Slvs	Sleeves
cc	Cubic Centimeters	Incl	Include	SOHC	Single Overhead Cam
Ch	Chassis	Indep	Independent	Spd	Speed
Chry	Chrysler	Inter	Intermediate	SRW	Single Rear Wheel
CID	Cubic Inch Displacement	IRS	Independent Rear Suspension	Std	Standard
Cl	Clutch	L	Liter	Susp	Suspension
Comm	Commercial	L/D	Light Duty	Taprd	Tapered
Conv	Converter	lb	Pound	Trans	Transmission
Cyl	Cylinder	LH	Left Hand	Turbo	Turbocharger
Dbl	Double	Limo	Limousine	VIN	Vehicle Identification Number
Dia	Diameter	M/T	Manual Transmission	W/	With
Diaph	Diaphragm	Man	Manual	W/O	Without
Diff	Differential	mm	Millimeter	WD	Wheel Drive
DOHC	Dual Overhead Cam	Mtg	Mounting	Whl	Wheel
Dr	Door	Ndl	Needle	Whls	Wheels
DRW	Dual Rear Wheel	O/D	Overdrive		

Mfg./Year Model & Location Part No. Mfg./Year Model & Location Part No.

ACURA - Integra, Legend, NSX, RSX, TSX, Vigor, 2.2CL, 2.3CL, 2.5TL, 3.0CL, 3.2CL, 3.2TL, 3.5RL**FRONT WHEEL****FWD**

2009-2004	3.2TL	
Ball Bearing		510073[2]
2008-2004	TSX	
Ball Bearing		510073[2]
2006-2002	RSX	
Ball Bearing		510039[2]
2004-1996	3.5RL	
Ball Bearing		510011[2]
2003-2001	3.2CL	
Ball Bearing		510050[2]
2003-1999	3.2TL	
Ball Bearing		510050[2]
2001-1994	Integra	
Ball Bearing		510030[2]
1999-1998	2.3CL	
Bearing Module		513098[2]
1999-1997	3.0CL	
Bearing Module		510038[2]
1998-1996	3.2TL	
Ball Bearing		510011[2]
1998-1995	2.5TL	
Bearing Module		510038[2]
1997	2.2CL	
Bearing Module		513098[2]
1995-1991	Legend	
Ball Bearing		510011[2]
1994-1992	Vigor	
Bearing Module		513093[2]
1993-1990	Integra	
Ball Bearing		513241[2]
1990	Legend	
Ball Bearing		513052[2]

RWD

2005-1991	NSX	
Bearing Module		513099[2]

AWD

2008-2005	3.5RL	
Hub Unit Bearing		HA590147[2] ²⁵

REAR WHEEL**FWD**

2009-2004	3.2TL	
Hub Unit Bearing		512188[2]
2008-2004	TSX	
Hub Unit Bearing		HA590019[2] ²⁵
2006-2002	RSX	
Hub Unit Bearing		HA590005[2]
2004-1996	3.5RL	
Hub Unit Bearing		512123[2]
2003-2001	3.2CL	
Hub Unit Bearing		512173[2]
2003-1999	3.2TL	
Hub Unit Bearing		512179[2]
2001-1994	Integra (ABS)	
Hub Unit Bearing		513105[2]
1999-1998	2.3CL	
Hub Unit Bearing		512172[2]

REAR WHEEL (cont.)**FWD (cont.)**

1999-1997	3.0CL	
Hub Unit Bearing		512172[2]
1998-1996	3.2TL	
Hub Unit Bearing		512121[2]
1998-1995	2.5TL	
Hub Unit Bearing		512120[2]
1997	2.2CL	
Hub Unit Bearing		512172[2]
1996-1994	Integra (Non-ABS)	
Hub Unit Bearing		513105[2]
1995-1991	Legend	
Hub Unit Bearing		512008[2]
1994-1992	Vigor	
Hub Unit Bearing		512031[2]
1993-1990	Integra (ABS)	
Hub Unit Bearing		513105[2]
1993-1990	Integra (Non-ABS)	
Hub Unit Bearing		513033[2]
1990	Legend	
Hub Unit Bearing		513049[2]

RWD

2005-1991	NSX	
Bearing Module		511012[2]
Seal		710293[2]

AWD

2008-2005	3.5RL	
Hub Unit Bearing		HA590146[2] ²⁵

REAR AXLE**Differential**

1995	Legend	
Cone/Cup		NP484279-NP905784[2]
1994-1992	Vigor	
Seal		710147[2]
Bearing Assy		32009XM[2]

Pinion

1995	Legend	
Cone/Cup (Inner)		NP929079-NP030857
Cone/Cup (Outer)		NP463799-NP235899
1994-1992	Vigor	
Seal (Inner)		710242
Bearing Assy (Inner)		33208
Seal (Outer)		710250
Bearing Assy (Outer)		32008XM

CLUTCH**Pilot Bearing**

2001-1990	(4 Cyl.)	
Ball Bearing		102CC

²⁵New Item, Check For Availability

Mfg./Year	Model & Location	Part No.	Mfg./Year	Model & Location	Part No.
ACURA - Integra, Legend, NSX, RSX, TSX, Vigor, 2.2CL, 2.3CL, 2.5TL, 3.0CL, 3.2CL, 3.2TL, 3.5RL (cont.)					

CLUTCH

Release Bearing

2001-1994	Integra GSR GSRL Type R	
	Bearing Assy	614072
2001-1994	Integra RS GS LS LSSPL	
	Bearing Assy	614068
2000-1991	NSX	
	Bearing Assy	614138
1999-1998	2.3CL	
	Bearing Assy	614068
1997	2.2CL	
	Bearing Assy	614068
1995-1991	Legend	
	Bearing Assy	614138
1994-1992	Vigor	
	Bearing Assy	614139
1993-1990	Integra	
	Bearing Assy	614104
1990	Legend	
	Bearing Assy	614068

6-SPEED MANUAL TRANSMISSION

Selector Shaft Seal/Man. Shaft

2005-1991		
	Seal	710299

4-SPEED AUTOMATIC TRANSAXLE

Differential

2004-1996	3.5RL	
	Bearing Assy	32009XM[2]
2001-1990	Integra	
	Ball Bearing	208[2]
2000-1991	NSX	
	Bearing Assy	32011XM[2]
1999-1998	2.3CL	
	Bearing Assy (LH)	30208M[2]
1999-1996	3.2TL	
	Bearing Assy	32009XM[2]
1998-1995	2.5TL	
	Bearing Assy	32009XM[2]
1997	2.2CL (A6VA)	
	Bearing Assy (LH)	30208M[2]
1995-1991	Legend	
	Bearing Assy	32009XM[2]
1994-1992	Vigor	
	Bearing Assy	32009XM[2]
1990	Legend	
	Bearing Assy	30208M[2]

Torque Converter / Frt Pump

2004-1999	3.2TL	
	Seal	417486
2004-1996	3.5RL	
	Seal	710238
2004-1991	NSX (MR9A)	
	Seal	710238
2001	3.2CL	
	Seal	350609
2001-1990	Integra	
	Seal	350609

4-SPEED AUTOMATIC TRANSAXLE (cont.)

Torque Converter / Frt Pump (cont.)

1999-1998	2.3CL	
	Seal	350609
1999-1997	3.0CL	
	Seal	350609
1998-1996	3.2TL	
	Seal	350609
1998-1995	2.5TL	
	Seal	350609
1997	2.2CL	
	Seal	350609
1995-1991	Legend	
	Seal	710238
1994-1992	Vigor	
	Seal	350609
1990	Legend	
	Seal	350609

Output Shaft

2008-1996	3.5RL	
	Seal (RH)	710260
	Repair Sleeve (RH)	KWK99177
	Seal (LH)	225545
	Repair Sleeve (LH)	KWK99215
2005-1991	NSX (MR9A)	
	Seal (LH)	224068
	Seal (RH)	710291
2001-1994	Integra	
	Seal (RH)	1036
	Repair Sleeve (RH)	KWK99157
	Seal (LH)	223543
	Repair Sleeve (LH)	KWK99139
1999-1998	2.3CL	
	Seal (RH)	224066
	Repair Sleeve (RH)	KWK99157
	Seal Viton (LH)	224026
	Repair Sleeve (LH)	KWK99157
1999-1997	3.0CL	
	Seal (RH)	710110
	Repair Sleeve (RH)	KWK99134
	Seal Viton (LH)	224026
	Repair Sleeve (LH)	KWK99157
1999-1996	3.2TL	
	Seal (RH)	225545
	Repair Sleeve (RH)	KWK99215
	Seal (LH)	223805
	Repair Sleeve (LH)	KWK99147
1998-1995	2.5TL	
	Seal (RH)	710173
	Repair Sleeve (RH)	KWK99157
	Seal (LH)	350609
	Repair Sleeve (LH)	KWK99170
1997	2.2CL	
	Seal (RH)	224066
	Repair Sleeve (RH)	KWK99157
	Seal (LH)	712551
	Repair Sleeve (LH)	KWK99157

Mfg./Year	Model & Location	Part No.	Mfg./Year	Model & Location	Part No.
-----------	------------------	----------	-----------	------------------	----------

ACURA - Integra, Legend, NSX, RSX, TSX, Vigor, 2.2CL, 2.3CL, 2.5TL, 3.0CL, 3.2CL, 3.2TL, 3.5RL (cont.)

**4-SPEED AUTOMATIC TRANSAXLE
(cont.)**

Output Shaft (cont.)

1995-1991	Legend	
	Seal (RH)	710260
	Repair Sleeve (RH)	KWK99177
	Seal (LH)	225545
	Repair Sleeve (LH)	KWK99215
1994-1992	Vigor	
	Seal Viton (RH)	224026
	Repair Sleeve (RH)	KWK99157
	Seal (LH)	710173
	Repair Sleeve (LH)	KWK99196
1993-1990	Integra	
	Seal (RH)	1036
	Repair Sleeve (RH)	KWK99157
	Seal (LH)	223805
	Repair Sleeve (LH)	KWK99157
1990	Legend	
	Seal Viton	224026[2]
	Repair Sleeve	KWK99157[2]

Pinion

2001-1996	3.5RL	
	Seal (Frt)	221207
	Bearing Assy (Rr)	32207M
1998-1996	3.2TL	
	Seal (Frt)	221207
	Bearing Assy (Rr)	32207M
1998-1995	2.5TL	
	Seal (Frt)	710242
	Bearing Assy (Frt)	33208
	Bearing Assy (Rr)	32009XM
1995-1991	Legend	
	Seal (Frt)	221207
	Bearing Assy (Rr)	32207M
1994-1992	Vigor	
	Seal (Frt)	710242
	Bearing Assy (Frt)	33208
	Bearing Assy (Rr)	32008XM

Extension Housing

1998-1995	2.5TL	
	Bearing Assy	32008XM

Manual Shaft

2005-1990		
	Seal	221207
	Repair Sleeve	KWK99049

5-SPEED AUTOMATIC TRANSAXLE

Differential

2001-2000	3.2TL	
	Bearing Assy	32009XM[2]

5-SPEED AUTOMATIC TRANSAXLE

Torque Converter

2006-2002	RSX (MRMA)	
	Seal	350609
2003-2001	3.2CL (MGFA)	
	Seal	350609
2003-2001	3.2TL (B7WA)	
	Seal	350609
2000	3.2TL (M7WA)	
	Seal	350609

Output Shaft

2008-2007	TL	
	Seal (LH)	710199
	Repair Sleeve (LH)	KWK99139
2008-2004	TSX (MCTA)	
	Seal (RH)	710217
	Repair Sleeve (RH)	KWK99139
2006-2002	RSX (MRMA)	
	Seal (LH)	710300
	Repair Sleeve (LH)	KWK99157
2003-2001	3.2CL (MGFA)	
	Seal (LH)	710199
	Repair Sleeve (LH)	KWK99139
	Seal Viton (RH)	224026
	Repair Sleeve (RH)	KWK99157
2003-2001	3.2TL (B7WA)	
	Seal (LH)	710199
	Repair Sleeve (LH)	KWK99139
	Seal Viton (RH)	224026
	Repair Sleeve (RH)	KWK99157
2000	3.2TL (M7WA)	
	Seal Viton (RH)	224026
	Repair Sleeve (RH)	KWK99157
	Seal (LH)	710199
	Repair Sleeve (LH)	KWK99139

Manual Shaft

2005-1991		
	Seal	221207
	Repair Sleeve	KWK99049

5-SPEED MANUAL TRANSAXLE

Differential

2006-2002	RSX, TSX	
	Ball Bearing	208[2]
2001-1990	Integra	
	Ball Bearing	208[2]
1999-1998	2.3CL	
	Bearing Assy (LH)	33108[2]
	Bearing Assy (RH)	32008XM[2]
1997	2.2CL	
	Bearing Assy (LH)	33108[2]
	Bearing Assy (RH)	32008XM[2]
1996-1991	NSX	
	Bearing Assy (RH)	32011XM[2]
1994-1992	Vigor (L3A3)	
	Cone/Cup (LH)	XAA32008X-Y32008X[2]
	Bearing Assy (RH)	32010X[2]

Mfg./Year Model & Location Part No. Mfg./Year Model & Location Part No.

ACURA - Integra, Legend, NSX, RSX, TSX, Vigor, 2.2CL, 2.3CL, 2.5TL, 3.0CL, 3.2CL, 3.2TL, 3.5RL (cont.)

5-SPEED MANUAL TRANSAXLE (cont.)

Differential (cont.)

1990 Legend (C3P4, G3T4)
 Cone/Cup (LH) XAA32008X-Y32008X[2]
 Bearing Assy (RH) 32010X[2]

Input Shaft

2001-1990 Integra
 Seal 222830
 Repair Sleeve KWK99111

1997 2.2CL
 Seal 222830
 Repair Sleeve KWK99111

1994-1992 Vigor (L3A3)
 Seal 222830
 Repair Sleeve KWK99111

1994-1991 NSX
 Seal 223235
 Repair Sleeve KWK99128

1993-1991 Legend (K4A6)
 Seal 710157
 Repair Sleeve KWK99103

1990 Legend (C3P4, G3T4)
 Seal 710157
 Repair Sleeve KWK99103

Output Shaft

2004-2002 RSX, TSX
 Seal (LH) 224068
 Seal (RH) 710291

2001-1994 Integra
 Seal (LH) 223543
 Repair Sleeve (LH) KWK99139
 Seal (RH) 224045
 Repair Sleeve (RH) KWK99157

1999-1998 2.3CL
 Seal (LH) 2007N
 Repair Sleeve (LH) KWK99139
 Seal (RH) 3459S
 Repair Sleeve (RH) KWK99157

1997 2.2CL
 Seal (LH) 2007N
 Repair Sleeve (LH) KWK99139
 Seal (RH) 3459S
 Repair Sleeve KWK99157

1996-1991 NSX
 Seal (LH) 710291
 Repair Sleeve (LH) KWK99162
 Seal (RH) 224068
 Repair Sleeve (RH) KWK99157

1995-1991 Legend
 Seal (LH) 224520
 Repair Sleeve (LH) KWK99177
 Seal (RH) 225545
 Repair Sleeve (RH) KWK99215

1994-1992 Vigor
 Seal (LH) 710173
 Repair Sleeve (LH) KWK99196
 Seal (RH) 224025
 Repair Sleeve (RH) KWK99157

5-SPEED MANUAL TRANSAXLE (cont.)

Output Shaft (cont.)

1993-1990 Integra
 Seal (LH) 224025
 Repair Sleeve KWK99157

1990 Legend
 Seal 712551[2]
 Repair Sleeve KWK99157[2]

Pinion

1995-1991 Legend (K4A6)
 Seal (Frnt) 225775

1994-1992 Vigor (L3A3)
 Seal (Frnt) 710242
 Bearing Assy (Frnt) 33208
 Bearing Assy (Rr) 32008XM

Selector Shaft Seal/Man. Shaft

1999-1998 2.3CL
 Seal (Top) 221603
 Repair Sleeve KWK99058
 Seal (Side) 221607
 Repair Sleeve KWK99058

1997 2.2CL
 Seal (Top) 221603
 Repair Sleeve KWK99058
 Seal (Side) 221607
 Repair Sleeve KWK99058

1994-1992 Vigor
 Seal (Top) 710249
 Repair Sleeve (Top) KWK99078
 Seal (Side) 221607
 Repair Sleeve (Side) KWK99058

Extension Housing

1994-1992 Vigor
 Seal 224025
 Repair Sleeve KWK99157

6-SPEED MANUAL TRANSAXLE

Input Shaft

2004-1997 NSX
 Seal 223235
 Repair Sleeve KWK99128

Output Shaft

2004-1997 NSX
 Seal (LH) 710291
 Seal (RH) 224068

Differential

2002-1997 NSX
 Bearing Assy (RH) 32011XM
 Bearing Assy (LH) 33208

Mfg./Year	Model & Location	Part No.	Mfg./Year	Model & Location	Part No.
-----------	------------------	----------	-----------	------------------	----------

ACURA - Integra, Legend, NSX, RSX, TSX, Vigor, 2.2CL, 2.3CL, 2.5TL, 3.0CL, 3.2CL, 3.2TL, 3.5RL (cont.)

POWER STEERING

Pump Shaft

1999-1991	2.2CL, 2.3CL, 3.2TL, Legend	
Seal		221920
1994-1992	Vigor	
Seal		222028
1991	Integra	
Seal		221620
1990		
Seal		221620

OIL PUMP

6 Cylinder

2008-2007	3.2L, 3.5L	
Seal		711181
2008-1996	3.5L	
Seal		711181
2007-1996	3.2TL	
Seal		711181
2005-1991	3.0L, 3.2L	
Seal		711181
2003-2001	3.2CL	
Seal		711181
1999-1998	2.3CL	
Seal Viton		712009
Repair Sleeve		KWK99106
1999-1997	3.0CL	
Seal		711181
1997	2.2CL	
Seal Viton		712009
Repair Sleeve		KWK99106
1995-1990	2.5L, 2.7L, 3.2L	
Seal		711181

CAMSHAFT SEAL

4 Cylinder

2001-1994	1.8L (DOHC)	
Seal		222743
2001-1994	1.8L VTEC	
Seal		1989
1999-1998	2.3CL	
Seal		712008
1997	2.2CL	
Seal		712008
1993-1990	Integra RS LS LSSP GS GSL	
Seal		222743

5 Cylinder

1998-1995	2.5TL	
Seal		1989
1994-1992	Vigor	
Seal		1989

6 Cylinder

2008	TL	
Seal		710451[2]
Repair Sleeve		KWK99147
2008-2005	RL	
Seal		710451[2]

CAMSHAFT SEAL (cont.)

6 Cylinder (cont.)

2007-1999	3.2TL	
Seal		710451
Repair Sleeve		KWK99147[2]
2004-1996	3.5RL	
Seal		3771
2004-1991	NSX	
Seal		1989[2]
Repair Sleeve		KWK99112[2]
2003-2001	3.2CL	
Seal		710451
Repair Sleeve		KWK99147[2]
1999-1997	3.0CL	
Seal		710451
1998-1996	3.2TL	
Seal		3771
1995-1991	Legend	
Seal		3771
1990	Legend	
Seal Viton		713771

CRANKSHAFT FRONT SEAL

4 Cylinder

2009-2004	TSX	
Seal Viton		228008
2001-1990	Integra	
Seal		223802
Repair Sleeve		KWK99147
1999-1998	2.3CL	
Seal		224015
Repair Sleeve		KWK99157
1997	2.2CL	
Seal		224015
Repair Sleeve		KWK99157

5 Cylinder

1998-1995	2.5TL	
Seal		224015
Repair Sleeve		KWK99157
1994-1992	Vigor	
Seal		224015
Repair Sleeve		KWK99157

6 Cylinder

2007-1996	3.2TL	
Seal		1181
Repair Sleeve		KWK99163
2004-1996	3.5RL	
Seal		1181
Repair Sleeve		KWK99163
2004-1991	NSX	
Seal		1181
Repair Sleeve		KWK99169
1999-1997	3.0CL	
Seal		1181
Repair Sleeve		KWK99162
1995-1990	Legend	
Seal		1181
Repair Sleeve		KWK99162

Mfg./Year Model & Location Part No. Mfg./Year Model & Location Part No.

ACURA - Integra, Legend, NSX, RSX, TSX, Vigor, 2.2CL, 2.3CL, 2.5TL, 3.0CL, 3.2CL, 3.2TL, 3.5RL (cont.)

CRANKSHAFT REAR SEAL

4 Cylinder

2008-2004	TSX	
Seal Viton	228008
Repair Sleeve	KWK99315
2006-2002	RSX	
Seal Viton	228008
Repair Sleeve	KWK99315
2001-1990	Integra	
Seal	228015
Repair Sleeve	KWK99315
1999-1997	CL	
Seal	228015
Repair Sleeve	KWK99315

5 Cylinder

1998-1995	2.5TL	
Seal	228015
Repair Sleeve	KWK99315
1994-1992	Vigor	
Seal	228015
Repair Sleeve	KWK99315

6 Cylinder

2008	TL	
Seal Viton	228008
Repair Sleeve	KWK99315
2008-1996	3.5RL	
Seal Viton	228008
Repair Sleeve	KWK99315
2008-1996	TL	
Seal Viton	228008
Repair Sleeve	KWK99315

CRANKSHAFT REAR SEAL (cont.)

6 Cylinder (cont.)

2005-1991	NSX	
Seal Viton	228008
Repair Sleeve	KWK99315
2003-2001	3.2CL	
Seal Viton	228008
Repair Sleeve	KWK99315
1999-1997	3.0CL	
Seal Viton	228008
Repair Sleeve	KWK99315
1995-1990	Legend	
Seal Viton	228008
Repair Sleeve	KWK99315

ACURA - SUV - MDX

FRONT WHEEL

AWD

2008-2007		
Hub Unit Bearing	HA590228[2] ²⁵
2006-2003		
Ball Bearing	510085[2]
2002-2001		
Ball Bearing	510011[2]

REAR WHEEL

AWD

2008-2007		
Hub Unit Bearing	HA590229[2] ²⁵
2006-2003		
Ball Bearing	511036[2] ²⁵
2002-2001		
Ball Bearing	510039[2]

5-SPEED AUTOMATIC TRANSAXLE

Torque Converter

2004-2003	(MDKA)	
Seal	710238
2002-2001	(BGHA, MGHA)	
Seal	350609

Output Shaft

2008-2003		
Seal (LH)	710199
Repair Sleeve	KWK99139
2002		
Repair Sleeve (RH)	KWK99157
Seal (LH)	710217
Repair Sleeve	KWK99139
Seal (RH)	710300
2001		
Seal (LH)	710199
Repair Sleeve (LH)	KWK99139
Seal (RH)	710300
Repair Sleeve (RH)	KWK99157

²⁵New Item, Check For Availability

Mfg./Year Model & Location Part No. Mfg./Year Model & Location Part No.

ACURA - SUV - MDX (cont.)

5-SPEED AUTOMATIC TRANSAXLE

Manual Shaft

2006-2001
 Seal 221207
 Repair Sleeve KWK99049

OIL PUMP

6 Cylinder

2006-2001 3471cc/3.5L
 Seal 711181

CAMSHAFT SEAL

6 Cylinder

2006-2001 3471cc/3.5L
 Seal 710451

CRANKSHAFT REAR SEAL

6 Cylinder

2006-2001 3471cc/3.5L
 Seal Viton 228008
 Repair Sleeve KWK99315

ACURA - SUV - RDX

FRONT WHEEL

AWD

2008-2007
 Bearing Assy WB000012[2]²⁵

REAR WHEEL

AWD

2008-2007
 Hub Unit Bearing HA590204[2]²⁵

ACURA - SUV - SLX

FRONT WHEEL

4WD

1999-1996
 Seal (Inner) 710168[2]
 Bearing Assy (Inner) 32009XM[2]
 Bearing Assy (Outer) 32008XM[2]

REAR WHEEL

4WD

1999-1996
 Seal (Inner) 225230[2]
 Ball Bearing (Inner) 511016[2]
 Seal (Outer) 473179[2]

4WD FRONT AXLE

Axle Shaft

1999-1996
 Seal 710516[2]
 Ball Bearing 106CC[2]

4WD FRONT AXLE

Differential

1999-1996
 Set SET45[2]

Pinion

1999-1996
 Seal 474133
 Bearing Assy (Inner) 32307
 Bearing Assy (Outer) 30306M

REAR AXLE

Differential

1999-1996
 Bearing Assy 30210M[2]

Pinion

1999-1996
 Seal 710248
 Bearing Assy (Inner) 32307
 Bearing Assy (Outer) 32332C

²⁵New Item, Check For Availability

Mfg./Year Model & Location Part No. Mfg./Year Model & Location Part No.

ACURA - SUV - SLX (cont.)

TRANSFER CASE

Input Shaft

1999-1998
Seal 224250
1997-1996
Seal 710247
Repair Sleeve KWK99149

4-SPEED AUTOMATIC TRANSMISSION

Torque Converter

1999-1996
Seal 3227
Repair Sleeve KWK99174

Rear Seal/Ext. Housing

1999-1996
Seal 3459S

Selector Shaft Seal/Man. Shaft

1999-1996
Seal 8792S

POWER STEERING

Pump Shaft

1999-1996
Seal Viton 222036

CAMSHAFT SEAL

6 Cylinder

1999-1998 3496cc/3.5L
Seal 1981[4]
Repair Sleeve KWK99114[4]
1997-1996 3165cc/3.2L
Seal 1981[2]
Repair Sleeve KWK99114[2]

CRANKSHAFT FRONT SEAL

6 Cylinder

1999-1996 3165cc/3.2, 3494cc/3.5L
Seal 224025
Repair Sleeve KWK99157

CRANKSHAFT REAR SEAL

6 Cylinder

1999-1996 3165cc/3.2, 3494cc/3.5L
Seal 710060
Repair Sleeve KWK99364

ALFA ROMEO - Spider, 164

FRONT WHEEL

RWD

1994-1990 Spider
Seal (Inner) 224100[2]
Bearing Assy (Inner) 30206M[2]
Bearing Assy (Outer) 32303[2]

REAR WHEEL

RWD

1994-1990 Spider
Seal 223035[2]
Ball Bearing 88107[2]

REAR AXLE

Differential

1994-1990 Spider 2000
Cone/Cup 28150-28300[2]
1993-1991 164
Bearing Assy 32009XM[2]

Pinion

1994-1990 Spider 2000
Cone/Cup (Inner) HM89446-HM89410
Cone/Cup (Outer) M88048-M88010

4-SPEED AUTOMATIC TRANSMISSION

Torque Converter

1990 (ZF4HP22)
Seal 224052
Repair Sleeve KWK99157

Mfg./Year Model & Location Part No. Mfg./Year Model & Location Part No.

ALFA ROMEO - Spider, 164 (cont.)

4-SPEED AUTOMATIC TRANSMISSION

Rear Seal/Ext. Housing

1990 (ZF4HP22)
Seal 3459S

CLUTCH

Release Bearing

1994-1990 Spider 2000
Bearing Assy 614100

4-SPEED AUTOMATIC TRANSAXLE

Differential

1995-1991 (ZF4HP18Q)
Cone/Cup (RH) LM300849-LM300811
Cone/Cup (LH) LM806649-LM806610

CRANKSHAFT FRONT SEAL

4 Cylinder

1994-1990 1962cc/2.0L
Seal 223520
Repair Sleeve KWK99139

6 Cylinder

1995-1991 2959cc/3.0L
Seal 223520
Repair Sleeve KWK99139

CRANKSHAFT REAR SEAL

4 Cylinder

1994-1990 1962cc/2.0L
Seal 228480
Repair Sleeve KWK99328

6 Cylinder

1995-1991 2959cc/3.0L
Seal 228480
Repair Sleeve KWK99328

ASTON MARTIN - ALL

FRONT WHEEL

RWD

1994-1990 Virage
Set (Inner) SET17[2]
Set (Outer) SET8[2]
1992-1990 Lagonda
Set (Inner) SET17[2]
Set (Outer) SET8[2]

REAR WHEEL

RWD

1993-1990 Virage
Bearing Assy JXC25469C[2]
1990 Lagonda
Set SET37[2]

REAR AXLE

Axle Shaft

1993-1990 DBS, Lagonda, Vantage, Virage,
Volante, V8
Set SET17[2]

Differential

1993 Lagonda, Vantage, Virage,
Volante, V8
Cone/Cup 25577C-25523[2]
1992-1990 DBS, Lagonda, Vantage, Virage,
Volante, V8
Cone/Cup 25577-25523[2]

Mfg./Year Model & Location Part No. Mfg./Year Model & Location Part No.

ASTON MARTIN - ALL (cont.)

REAR AXLE

Pinion

1992-1990	Virage	
	Cone/Cup (Inner)	HM89446-HM89410
	Cone/Cup (Outer)	M88043-M88010
1992-1990	Vantage	
	Cone/Cup (Inner)	HM89446-HM89410
	Cone/Cup (Outer)	M88043-M88010
1990	Lagonda	
	Cone/Cup (Inner)	HM89446-HM89410
	Cone/Cup (Outer)	M88043-M88010
1990	V8	
	Cone/Cup (Inner)	HM89446-HM89410
	Cone/Cup (Outer)	M88043-M88010
1990	Volante	
	Cone/Cup (Inner)	HM89446-HM89410
	Cone/Cup (Outer)	M88043-M88010

3-SPEED AUTOMATIC TRANSMISSION

Torque Converter

1993-1990	(A727)	
	Seal	331227H
	Repair Sleeve	KWK99187

Rear Seal/Ext. Housing

1993-1990	(A727)	
	Seal	7300S
	Ball Bearing	207XLO[2]
	Seal Kit	5206 ⁶⁴

4-SPEED AUTOMATIC TRANSMISSION

Torque Converter

1997	(4L80E)	
	Seal	4598
	Repair Sleeve	KWK99199

Rear Seal/Ext. Housing

1997	(4L80E)	
	Seal	9449
	Seal Kit	5208 ⁶⁴

4-SPEED AUTOMATIC TRANSMISSION

Selector Shaft Seal/Man. Shaft

1997	(4L80E)	
	Seal	8792S

Output Shaft

1997	(4L80E)	
	Seal	4934

AUDI - A3, A4, A6, A8, Cabriolet, RS4, RS6, S4, S5, S6, S8, TT, V8 Quattro, Allroad Quattro

FRONT WHEEL

FWD

2009	A3	
	Hub Unit Bearing	513262[2] ²⁵
2009-2008	TT	
	Hub Unit Bearing	HA590106[2] ²⁵
2008-2006	A3	
	Hub Unit Bearing	HA590198[2] ²⁵
2008-2002	A4	
	Bearing Module	512305[2] ²⁵
2008-2000	A6	
	Ball Bearing	510020[2]
2006-2000	TT	
	Ball Bearing	510003[2]

FRONT WHEEL (cont.)

FWD (cont.)

2001-1996	A4	
	Ball Bearing	510019[2]
1999-1997	A8	
	Ball Bearing	510019[2]
1999-1995	A6	
	Ball Bearing	510019[2]
1998-1994	Cabriolet	
	Ball Bearing	510020[2]

²⁵New Item, Check For Availability

⁶⁴Seal & Bushing Kit

AUDI - A3, A4, A6, A8, Cabriolet, RS4, RS6, S4, S5, S6, S8, TT, V8 Quattro, Allroad Quattro (cont.)**FRONT WHEEL****AWD**

2009-2008	TT	
Hub Unit Bearing	HA590106[2] ²⁵
2009-2006	A3	
Hub Unit Bearing	513262[2] ²⁵
2009-2004	A8, S8	
Bearing Module	BM500012[2] ²⁵
2009-2002	A6, S6	
Bearing Module	BM500012[2] ²⁵
2008	R8	
Ball Bearing	510020[2]
2008-2007	RS4	
Bearing Module	512305[2] ²⁵
2008-2004	S4	
Bearing Module	512305[2] ²⁵
2008-2003	A4	
Bearing Module	512305[2] ²⁵
2006-2000	TT	
Ball Bearing	510003[2]
2005-2001	Allroad Quattro	
Ball Bearing	510019[2]
2004-2000	S6	
Bearing Module	512305[2] ²⁵
2003-1997	A8, S8	
Ball Bearing	510019[2]
2002-1996	A4	
Ball Bearing	510069[2]
2000-1996	S4	
Ball Bearing	510019[2]
1994-1992	V8	
Ball Bearing	510019[2]
1991-1990	V8	
Ball Bearing	510020[2]

REAR WHEEL**FWD**

2009-2008	TT	
Hub Unit Bearing	512319[2] ²⁵
2009-2006	A3	
Hub Unit Bearing	HA590159[2] ²⁵
2008-2003	A4	
Hub Unit Bearing	512231[2]
2006	A6	
Bearing Module	BM500012[2] ²⁵
2006-2005	A4 Cabriolet (from VIN#8H5006847)(w/o quattro)	
Hub Unit Bearing	512231[2]
2006-2000	TT	
Hub Unit Bearing	512012[2]
2005-2002	A4	
Hub Unit Bearing	512231[2]
2001-1996	A4	
Seal (Inner)	1962[2]
Set (Inner)	SET8[2]
Set (Outer)	SET2[2]
1998-1994	Cabriolet	
Seal (Inner)	1962[2]
Set (Inner)	SET8[2]
Set (Outer)	SET2[2]

REAR WHEEL (cont.)**FWD (cont.)**

1997-1995	A6	
Seal (Inner)	1962[2]
Set (Inner)	SET8[2]
Set (Outer)	SET2[2]
Ball Bearing	510020[2]

AWD

2009-2008	RS4	
Ball Bearing	510019[2]
2009-2008	TT	
Hub Unit Bearing	HA590106[2] ²⁵
2009-2007	A6, S6	
Bearing Module	BM500012[2] ²⁵
2009-2004	A8, S8	
Bearing Module	BM500012[2] ²⁵
2008	R8	
Bearing Module	BM500012[2] ²⁵
2008-2007	S4	
Ball Bearing	510019[2]
2008-2002	A4 Quattro	
Ball Bearing	510019[2]
2008-2000	A6 Quattro Sedan V8	
Ball Bearing	510020[2]
2007-2002	S4	
Ball Bearing	510020[2]
2006	A6 Quattro Wagon	
Ball Bearing	510020[2]
2006-2005	S4	
Hub Unit Bearing	512231[2]
2006-2000	TT	
Ball Bearing	510003[2]
2006-1995	A6 Quattro Sedan V6	
Ball Bearing	510019[2]
2005-2001	Allroad Quattro	
Ball Bearing	510020[2]
2004-1998	A6 Quattro Wagon	
Ball Bearing	510020[2]
2004-1995	RS6, S6	
Ball Bearing	510019[2]
2001-1998	A4 Quattro	
Ball Bearing	510020[2]
1997-1996	A4	
Ball Bearing	510019[2]
1994-1990	V8	
Ball Bearing	510019[2]

REAR AXLE**Differential**

2004-2002	A4, A6, A8, TT Quattro Models	
Cone/Cup (LH)	LM300849-LM300811
2001-1995	A4, A6, A8, TT Quattro Models	
Cone/Cup (LH)	LM300849-LM300811
Seal (RH)	224520
Set (RH)	SET45
Repair Sleeve (RH)	KWK99177

²⁵New Item, Check For Availability

Mfg./Year Model & Location Part No. Mfg./Year Model & Location Part No.

AUDI - A3, A4, A6, A8, Cabriolet, RS4, RS6, S4, S5, S6, S8, TT, V8 Quattro, Allroad Quattro (cont.)

REAR AXLE (cont.)

Differential (cont.)

1994-1990 V8 Quattro
 Seal (RH) 224520
 Set (LH) SET37
 Set (RH) SET45
 Repair Sleeve (RH) KWK99177

Pinion

2005-1990
 Cone/Cup (Inner) HM801346X-HM801310
 Cone/Cup (Outer) M88048-M88010

CLUTCH - 4 CYLINDER

Pilot Bearing

2002-1997 1781cc/1.8L (DOHC)
 Ndle Bearing F85265

CLUTCH - 6 CYLINDER

Pilot Bearing

2002-1994 2671cc/2.7L, 2771cc/2.8L,
 2976cc/3.0L
 Bearing Only F212285

CLUTCH - 8 CYLINDER

Pilot Bearing

2002-1990 3562cc/3.6L, 4172cc/4.2L
 Bearing Only F212285

CLUTCH - 4 CYLINDER

Release Bearing

2002-2000 1781cc./1.8L (220mm Cl.)
 Bearing Assy 614111
 2002-1997 1781cc./1.8L (228mm Cl.)
 Bearing Assy 614073

CLUTCH - 6 CYLINDER

Release Bearing

2002-1994 2671cc/2.7L, 2771cc/2.8L,
 2976cc/3.0L
 Bearing Assy 614073

CLUTCH - 8 CYLINDER

Release Bearing

1991-1990 3562cc/3.6L
 Bearing Assy 614073

3-SPEED AUTOMATIC TRANSAXLE

Differential

1991-1990 (VW 003, 087)
 Cone/Cup LM300849-LM300811[2]
 1990 (VW 089)
 Cone/Cup LM29749-LM29710[2]

3-SPEED AUTOMATIC TRANSAXLE

Torque Converter

1991-1990 (VW 087, 089)
 Seal 3083
 Repair Sleeve KWK99169

Output Shaft

1991-1990 (VW 003, 087, 089)
 Seal 224520[2]
 Repair Sleeve KWK99177[2]

Pinion

1991-1990 (VW 087)
 Seal (Frt) 1012N
 Cone/Cup (Frt) M86649-M86610
 Seal (Rr) 222820
 Cone/Cup (Rr) M88048-M88010
 Repair Sleeve KWK99177
 1990 (VW 089)
 Seal (Frt) 239146
 Cone/Cup (Frt) M86649-M86610
 Seal (Rr) 222535
 Cone/Cup (Rr) M86649-M86610
 Repair Sleeve KWK99098

4-SPEED AUTOMATIC TRANSAXLE

Differential

1998-1992
 Cone/Cup (LH) LM806649-LM806610
 Cone/Cup (RH) LM300849-LM300811
 1998-1991 (VW 097)
 Cone/Cup LM503349A-LM503310[2]
 1994-1991
 Cone/Cup LM300849-LM300811[2]

Torque Converter / Frt Pump

1998-1992
 Seal 225110
 Repair Sleeve KWK99177
 1994-1991
 Seal 225110
 Repair Sleeve KWK99177

Output Shaft

1994-1991
 Seal 225010[2]
 Repair Sleeve KWK99196[2]

Pinion

1998-1991 (VW 097)
 Bearing Assy (Frt) 513185
 Cone/Cup (Rr) LM29749-LM29710

AUDI - A3, A4, A6, A8, Cabriolet, RS4, RS6, S4, S5, S6, S8, TT, V8 Quattro, Allroad Quattro (cont.)**5-SPEED AUTOMATIC TRANSAXLE****Torque Converter**

2002-1996
 Seal 224052
 Repair Sleeve KWK99157

Output Shaft

2006-1996
 Seal 223510[2]
 Repair Sleeve KWK99139

6-SPEED AUTOMATIC TRANSAXLE**Output Shaft**

2008-2004
 Seal 223510
 Repair Sleeve KWK99139

5-SPEED MANUAL TRANSAXLE**Differential**

2001-1990
 Set (LH) SET45
 Cone/Cup (RH) LM300849-LM300811

Input Shaft

2001-1990
 Seal 222540
 Repair Sleeve KWK99098

CAMSHAFT SEAL**4 Cylinder**

2006-1997 1781cc/1.8L (DOHC)
 Seal 3476S[2]
 Repair Sleeve KWK99128[2]

6 Cylinder

2005-1994 2671cc/2.7L, 2771cc/2.8L,
 2976cc/3.0L
 Seal 3476S[4]
 Repair Sleeve KWK99128[4]

8 Cylinder

2006-1997 4172cc/4.2L
 Seal Viton 1108
 Repair Sleeve KWK99139
 1996-1990 3562cc/3.6L, 4172cc/4.2L
 Seal 3476S[4]
 Repair Sleeve KWK99128[4]

CRANKSHAFT FRONT SEAL**4 Cylinder**

2006-1997 1781cc/1.8L (DOHC)
 Seal 3476S
 Repair Sleeve KWK99128

CRANKSHAFT FRONT SEAL**6 Cylinder**

2005-1994 2671cc/2.7L, 2771cc/2.8L,
 2976cc/3.0L
 Seal Viton 1108
 Repair Sleeve KWK99139

8 Cylinder

2006-1997 4172cc/4.2L
 Seal Viton 1108
 Repair Sleeve KWK99139
 1994-1990 3562cc/3.6L, 4172cc/4.2L
 Seal Viton 1108
 Repair Sleeve KWK99139

CRANKSHAFT REAR SEAL**4 Cylinder**

2006-1997 1781cc/1.8L
 Seal 716102
 Repair Sleeve KWK99333

6 Cylinder

2005-1994 2671cc/2.7L, 2771cc/2.8L
 Seal 716102
 Repair Sleeve KWK99333

8 Cylinder

2005-1990 3562cc/3.6L, 4172cc/4.2L
 Seal 716102
 Repair Sleeve KWK99333

Mfg./Year	Model & Location	Part No.	Mfg./Year	Model & Location	Part No.
-----------	------------------	----------	-----------	------------------	----------

AUDI - Coupe Quattro

FRONT WHEEL

AWD

1991-1990 Coupe Quattro
Ball Bearing 510020[2]

REAR WHEEL

AWD

1991-1990 Coupe Quattro
Ball Bearing 510020[2]

REAR AXLE

Differential

1992-1990
Set (LH) SET37
Set (RH) SET45

Pinion

1992-1990
Cone/Cup (Inner) HM801346X-HM801310
Cone/Cup (Outer) M88048-M88010

CLUTCH

Pilot Bearing

1991-1990 Coupe Quattro
Ball Bearing 202FF

Release Bearing

1991-1990 Coupe Quattro
Bearing Assy 614073

3-SPEED AUTOMATIC TRANSAXLE

Differential

1991-1990 (VW 003, 087)
Cone/Cup LM300849-LM300811[2]
1990 (VW 089)
Cone/Cup LM29749-LM29710[2]

Torque Converter

1991-1990 (VW 087, 089)
Seal 3083
Repair Sleeve KWK99169

Output Shaft

1991-1990 (VW 003, 087, 089)
Seal 224520[2]
Repair Sleeve KWK99177[2]

3-SPEED AUTOMATIC TRANSAXLE

Pinion

1991-1990 (VW 087)
Seal (Frt) 1012N
Cone/Cup (Frt) M86649-M86610
Seal (Rr) 222820
Cone/Cup (Rr) M88048-M88010
Repair Sleeve KWK99177
1990 (VW 089)
Seal (Frt) 239146
Cone/Cup (Frt) M86649-M86610
Seal (Rr) 222535
Cone/Cup (Rr) M86649-M86610
Repair Sleeve KWK99098

4-SPEED AUTOMATIC TRANSAXLE

Differential

1994-1991
Cone/Cup LM300849-LM300811[2]

Torque Converter / Frt Pump

1994-1991
Seal 225110
Repair Sleeve KWK99177

Output Shaft

1994-1991
Seal 225010[2]
Repair Sleeve KWK99196[2]

Pinion

1998-1991
Bearing Assy (Frt) 513185
Cone/Cup (Rr) LM29749-LM29710

5-SPEED MANUAL TRANSAXLE

Input Shaft

2001-1990
Seal 222540
Repair Sleeve KWK99098

Output Shaft

2001-1990
Seal 224520[2]
Repair Sleeve KWK99177[2]

CRANKSHAFT FRONT SEAL

5 Cylinder

1991-1990 1986cc/2.0L, 2144cc/2.2L,
2226cc/2.2L, 2309cc/2.3L
Seal Viton 1108
Repair Sleeve KWK99139

Mfg./Year	Model & Location	Part No.	Mfg./Year	Model & Location	Part No.
-----------	------------------	----------	-----------	------------------	----------

AUDI - Coupe Quattro (cont.)**CRANKSHAFT REAR SEAL****5 Cylinder**

1991-1990	1986cc/2.0L, 2144cc/2.2L, 2226cc/2.2L, 2309cc/2.3L	
Seal		716102
Repair Sleeve		KWK99333

AUDI - 80, 90, 100, 200, FWD & Quattro**FRONT WHEEL****FWD**

1995-1990	90	
Set		SET39[2]
1994-1992	100	
Ball Bearing		510019[2]
1992-1990	80	
Set		SET39[2]
1991	100	
Ball Bearing		510019[2]
1990	100 (3 Spd.)	
Ball Bearing		513242[2]
1990	100 (5 Spd.)	
Ball Bearing		510020[2]

AWD

1995-1990	90	
Ball Bearing		510019[2]
1994-1990	100	
Ball Bearing		510019[2]
1992-1990	80	
Ball Bearing		510020[2]
1991-1990	200 (M/T)(Turbo)	
Ball Bearing		510020[2]

REAR WHEEL**AWD**

1995-1990	90	
Ball Bearing		510020[2]
1995-1990	80, 90 (Rear ~ Disc Brakes)	
Seal (Inner)		1962[2]
Set (Inner)		SET8[2]
Set (Outer)		SET2[2]
1994-1990	100	
Ball Bearing		510019[2]
1994-1990	100	
Seal (Inner)		1962[2]
Set (Inner)		SET8[2]
Set (Outer)		SET2[2]
1992-1990	80	
Ball Bearing		510020[2]
1991-1990	200 (Turbo)	
Ball Bearing		510019[2]

FRONT AXLE**Differential**

1993-1990	100 Quattro	
Set (LH)		SET45
Cone/Cup (RH)		LM300849-LM300811
1993-1990	90 Quattro	
Set (LH)		SET45
Cone/Cup (RH)		LM300849-LM300811
1992-1990	80 Quattro	
Set (LH)		SET45
Cone/Cup (RH)		LM300849-LM300811
1991	100 (A/T)	
Cone/Cup		LM503349-LM503310[2]
1991	80 (A/T)	
Cone/Cup		LM503349-LM503310[2]
1991	80 (M/T)	
Set (LH)		SET45
Cone/Cup (RH)		LM300849-LM300811
1991	90 (A/T)	
Cone/Cup		LM503349-LM503310[2]
1991-1990	200 (Turbo)	
Set (LH)		SET45
Cone/Cup (RH)		LM300849-LM300811
1991-1990	200 (Turbo) Quattro	
Set (LH)		SET45
Cone/Cup (RH)		LM300849-LM300811
1990	80 (A/T)	
Cone/Cup		LM300849-LM300811[2]
1990	80 (M/T)	
Set (LH)		SET45
Cone/Cup (RH)		LM300849-LM300811
1990	90 (A/T)	
Cone/Cup		LM300849-LM300811[2]

Pinion

1991	100 (A/T)	
Cone/Cup (Inner)		LM29749-LM29710
Cone/Cup (Outer)		LM78349-LM78310A
1991	80 (A/T)	
Cone/Cup (Inner)		LM29749-LM29710
Cone/Cup (Outer)		LM78349-LM78310A
1991	90 (A/T)	
Cone/Cup (Inner)		LM29749-LM29710
Cone/Cup (Outer)		LM78349-LM78310A
1991-1990	80 (M/T)	
Cone/Cup (Inner)		JLM104942A-JLM104914
1990	100 (A/T)	
Cone/Cup (Inner)		M86649-M86610
Cone/Cup (Outer)		M86649-M86610

Mfg./Year Model & Location Part No. Mfg./Year Model & Location Part No.

AUDI - 80, 90, 100, 200, FWD & Quattro (cont.)

FRONT AXLE (cont.)

Pinion (cont.)

1990	80 (A/T)	
	Cone/Cup (Inner)	M86649-M86610
	Cone/Cup (Outer)	M86649-M86610
1990	90 (A/T)	
	Cone/Cup (Inner)	M86649-M86610
	Cone/Cup (Outer)	M86649-M86610

REAR AXLE

Differential

1992-1990		
	Set (LH)	SET37
	Set (RH)	SET45

Pinion

1994-1990		
	Seal	223843
	Cone/Cup (Inner)	HM801346X-HM801310
	Cone/Cup (Outer)	M88048-M88010

CLUTCH

Pilot Bearing

1990	(4 Cyl.)	
	Bushing	PB23
1990	(5 Cyl.)	
	Ndle Bearing	F85706

Release Bearing

1995-1990	90	
	Bearing Assy	614073
1994-1990	100	
	Bearing Assy	614073
1992-1990	80	
	Bearing Assy	614073
1991-1990	200 (Turbo)	
	Bearing Assy	614073

3-SPEED AUTOMATIC TRANSAXLE

Differential

1991-1990	(VW 003, 087)	
	Cone/Cup	LM300849-LM300811[2]
1990	(VW 089)	
	Cone/Cup	LM29749-LM29710[2]

Torque Converter

1991-1990	(VW 087, 089)	
	Seal	3083
	Repair Sleeve	KWK99169

Output Shaft

1991-1990	(VW 003, 087, 089)	
	Seal	224520[2]
	Repair Sleeve	KWK99177[2]

3-SPEED AUTOMATIC TRANSAXLE

Pinion

1991-1990	(VW 087)	
	Seal (Frt)	1012N
	Cone/Cup (Frt)	M86649-M86610
	Seal (Rr)	222820
	Cone/Cup (Rr)	M88048-M88010
	Repair Sleeve	KWK99177
1990	(VW 089)	
	Seal (Frt)	239146
	Cone/Cup (Frt)	M86649-M86610
	Seal (Rr)	222535
	Cone/Cup (Rr)	M86649-M86610
	Repair Sleeve	KWK99098

4-SPEED AUTOMATIC TRANSAXLE

Differential

1998-1992	(ZF 4HP 18)	
	Cone/Cup (LH)	LM806649-LM806610
	Cone/Cup (RH)	LM300849-LM300811
1998-1991	(VW 097)	
	Cone/Cup	LM503349A-LM503310[2]
1994-1991	(VW 095)	
	Cone/Cup	LM300849-LM300811[2]

Torque Converter / Frt Pump

1998-1992	(ZF 4HP 18)	
	Seal	225110
	Repair Sleeve	KWK99177
1994-1991	(VW 095)	
	Seal	225110
	Repair Sleeve	KWK99177

Output Shaft

1994-1991	(VW 095)	
	Seal	225010[2]
	Repair Sleeve	KWK99196[2]

Pinion

1998-1991	(VW 097)	
	Bearing Assy (Frt)	513185
	Cone/Cup (Rr)	LM29749-LM29710

5-SPEED MANUAL TRANSAXLE

Differential

2001-1990		
	Set (LH)	SET45
	Cone/Cup (RH)	LM300849-LM300811

Input Shaft

2001-1990		
	Seal	222540
	Repair Sleeve	KWK99098

Mfg./Year Model & Location Part No. Mfg./Year Model & Location Part No.

AUDI - 80, 90, 100, 200, FWD & Quattro (cont.)**5-SPEED MANUAL TRANSAXLE****Output Shaft**

2001-1990

Seal 224520[2]
Repair Sleeve KWK99177[2]**CAMSHAFT SEAL****6 Cylinder**

1995-1992 2771cc/2.8L

Seal 3476S
Repair Sleeve KWK99128**CRANKSHAFT FRONT SEAL****4 Cylinder**

1990 1983cc/2.0L

Seal 3476S
Repair Sleeve KWK99128**5 Cylinder**1997-1990 1986cc/2.0L, 2144cc/2.1L,
2226cc/2.2L, 2309cc/2.3LSeal Viton 1108
Repair Sleeve KWK99139**6 Cylinder**

1995-1992 2671cc/2.7L, 2771cc/2.8L

Seal Viton 1108
Repair Sleeve KWK99139**CRANKSHAFT REAR SEAL****4 Cylinder**

1990 1983cc/2.0L

Seal 716102
Repair Sleeve KWK99333**CRANKSHAFT REAR SEAL****5 Cylinder**

1997-1990 2226cc/2.2L, 2309cc/2.3L

Seal 716102
Repair Sleeve KWK99333**6 Cylinder**

2000-1992 2671cc/2.7L, 2771cc/2.8L

Seal 716102
Repair Sleeve KWK99333**AUDI - SUV - Allroad Quattro****FRONT WHEEL****AWD**

2005-2001

Ball Bearing 510019[2]

REAR WHEEL**AWD**

2005-2001

Ball Bearing 510020[2]

REAR AXLE**Differential**

2005-2001

Seal (RH) 224520
Cone/Cup (LH) LM300849-LM300811
Set (RH) SET45
Repair Sleeve KWK99177[2]**Pinion**

2005-2001

Cone/Cup (Inner) HM801346X-HM801310
Cone/Cup (Outer) M88048-M88010**CLUTCH - 6 CYLINDER****Pilot Bearing**

2005-2001 2671cc/2.7L

Bearing Only F212285

Mfg./Year Model & Location Part No. Mfg./Year Model & Location Part No.

AUDI - SUV - Allroad Quattro (cont.)

CLUTCH - 6 CYLINDER

Release Bearing

2005-2001 2671cc./2.7L (240mm Cl.)
 Bearing Assy 614073

5-SPEED AUTOMATIC TRANSAXLE

Torque Converter

2005-2001 (5HP24A, ZF5HP19)
 Seal 224052
 Repair Sleeve KWK99157

CAMSHAFT SEAL

6 Cylinder

2005-2001 2671cc/2.7L
 Seal 3476S[4]
 Repair Sleeve KWK99128[4]

8 Cylinder

2005-2003 4172cc/4.2L
 Seal 3476S
 Repair Sleeve KWK99128

CRANKSHAFT FRONT SEAL

6 Cylinder

2005-2001 2671cc/2.7L
 Seal Viton 1108
 Repair Sleeve KWK99139

8 Cylinder

2005-2003 4172cc/4.2L
 Seal Viton 1108
 Repair Sleeve KWK99139

CRANKSHAFT REAR SEAL

6 Cylinder

2005-2001 2671cc/2.7L
 Seal 716102
 Repair Sleeve KWK99333

8 Cylinder

2005-2003 4172cc/4.2L
 Seal 716102
 Repair Sleeve KWK99333

AUDI - SUV - Q7

FRONT WHEEL

AWD

2009-2007
 Ball Bearing 510082[2]²⁵

REAR WHEEL

AWD

2009-2007
 Ball Bearing 510082[2]²⁵

²⁵New Item, Check For Availability

AVANTI II - Avanti**FRONT WHEEL****RWD**

2007-2005	
Hub Unit Bearing	HA590017[2] ²⁵
2004-2001	
Hub Unit Bearing	513090[2]
1991-1990	
Seal (Inner)	205017[2]
Set (Inner)	SET6[2]
Set (Outer)	SET3[2]

REAR WHEEL**RWD**

2007-2005	
Seal	8835S[2]
Cylindrical Bearing	6408[2]
Bearing & Seal Kit	TRP1559TV[2] ¹⁹
2004-2001	
Seal	8660S[2]
Cylindrical Bearing	5707[2]
Bearing & Seal Kit	TRP1563TAV[2] ¹⁹
1991-1990	
Seal	8660S[2]
Cylindrical Bearing	5707[2]
Bearing & Seal Kit	TRP1563TAV[2] ¹⁹

REAR AXLE**Axle Shaft**

2007-2005	(7.5" R.G.)(Indep. Rr. Susp.)
Ndle Bearing	FC66998[2]
Seal Viton	714569[2]
2007-2005	(8.8" R.G.)(Indep. Rr. Susp.)
Ndle Bearing	FC66998[2]

Differential Rebuild Kit

2007-2005	(7.5" R.G.)(Indep. Rr. Susp.)
Kit	DRK315
1990	(8.5" R.G.)
Kit	DRK321

Differential

2007-2001	(7.5", 8.8" R.G.)
Cone/Cup	LM501349-LM501314[2]
1991-1990	(7.5", 8.8" R.G.)
Cone/Cup (Inner)	M802048-M802011
Cone/Cup (Outer)	M88048-M88010

Pinion

2007-2001	(7.5", 8.8" R.G.)
Seal Viton	3604
Cone/Cup (Inner)	M802048-M802011
Cone/Cup (Outer)	M88048-M88010
1991-1990	(7.5", 8.8" R.G.)
Seal Viton	3604
Cone/Cup (Inner)	M802048-M802011
Cone/Cup (Outer)	M88048-M88010

REAR AXLE (cont.)**Pinion (cont.)**

1990	
Seal (RC On)	2043
Cone/Cup (Inner) (RC On)	M802048-M802011
Cone/Cup (Outer) (RC On)	M88048-M88010
Seal (To RC)	8610
Cone/Cup (Inner) (To RC)	HM89249-HM89210
Cone/Cup (Outer) (To RC)	M86649-M86610

CRANKSHAFT FRONT SEAL**8 Cylinder**

1990	305/5.0L, 350/5.7L
Seal	9845
Repair Sleeve	KWK99176

CRANKSHAFT REAR SEAL**8 Cylinder**

1990	305/5.0L
Seal Viton	4359V
Seal PTFE H/D	5274A
Repair Sleeve	KWK99364

¹⁹Opt. Axle Rpr Brg. Replaces O.E. Brg & Seal²⁵New Item, Check For Availability

Mfg./Year Model & Location Part No. Mfg./Year Model & Location Part No.

BENTLEY - Continental, Eight, Mulsanne, Turbo R

FRONT WHEEL

RWD

1992-1990
 Cone/Cup (Inner) LM29749-LM29710[2]
 Set (Outer) SET4[2]

REAR WHEEL

RWD

1992-1990
 Cone/Cup (Inner) 18790-18720[2]
 Cone/Cup (Outer) 18690-18620[2]

REAR AXLE

Differential

1992-1990
 Cone/Cup (LH) 25590-25520
 Cone/Cup (RH) 368A-362A

REAR AXLE

Pinion

1992-1990
 Cone/Cup (Inner) HM903249-HM903210
 Cone/Cup (Outer) HM88649-HM88610

BMW - Mini Cooper - Mini

FRONT WHEEL

FWD

2008-2002
 Hub Unit Bearing 513226[2]²⁵

REAR WHEEL

FWD

2008-2002
 Hub Unit Bearing HA590161[2]²⁵

BMW - 1000 & 2000 Series - 128i, 135i

FRONT WHEEL

RWD

2008 128i
 Hub Unit Bearing HA590162[2]²⁵
 2008 135i
 Hub Unit Bearing HA590162[2]²⁵

CRANKSHAFT REAR SEAL

6 Cylinder

2008 3.0L (DOHC)
 Seal Viton 229005

²⁵New Item, Check For Availability

Mfg./Year	Model & Location	Part No.	Mfg./Year	Model & Location	Part No.
BMW - 3 Series - 318i, 318is, 318ti, 320i, 323ci, 323i, 323is, 325ci, 325i, 325is, 325ix, 328i, 328is, 328ci, 328xi, 330i, 330ci, 330xi, 335xi, M3, Z3					

FRONT WHEEL**RWD**

2009-2006	Hub Unit Bearing	HA590162[2] ²⁵
2006-2001 (Exc. 325xi & 330xi)	Hub Unit Bearing	513125[2]
2000-1998 323	Hub Unit Bearing	HA590308[2]
2000-1996 328 Ser.	Hub Unit Bearing	513125[2]
2000-1996 M3, Z3	Hub Unit Bearing	513125[2]
1999-1996 318i	Hub Unit Bearing	513125[2]
1995-1992	Hub Unit Bearing	513125[2]
1991-1990 M3	Hub Unit Bearing	513094[2]
1991-1990 318i, 318is, 325, 325e, 325es, 325i, 325is	Hub Unit Bearing	513111[2]

AWD

2008-2006	Ball Bearing	510081[2]
2005-2001 325xi & 330xi	Ball Bearing	510080[2]
1991-1990 325iX	Ball Bearing	513106[2]

REAR WHEEL**RWD**

2009-2001 3.0L, 3.2L	Ball Bearing	511026[2]
2008-2001 2.5L	Ball Bearing	513106[2]
2000-1990 318i, 318is, 323i, 323is, 323ci, 325, 325e, 325es, 325i, 325is, 325ix, 325ci, 328i, 328is, 328ci	Ball Bearing	513106[2]
1999-1997 Z3	Ball Bearing (6 Cyl.)	513106[2]
	Ball Bearing (4 Cyl.)	513113[2]
1999-1995 318ti	Ball Bearing	513113[2]
1999-1994 M3	Ball Bearing	511026[2]
1991-1990 M3	Ball Bearing	513113[2]

AWD

2008-2007 328 Ser.	Ball Bearing	513106[2]
2006-2001	Ball Bearing	511026[2]
1991-1990	Ball Bearing	513106[2]

FRONT AXLE**Differential**

1991-1990 325iX	Seal	473823[2]
	Cone/Cup	LM29749-LM29710[2]
	Repair Sleeve	KWK99139[2]

Pinion

1991-1990 325iX	Cone/Cup (Inner)	M88048-M88010
	Cone/Cup (Outer)	M86649-M86610

REAR AXLE**Differential**

2008-1990 M3, 323 Ser, 325 Ser, 328 Ser, 330i, 330xi	Seal	473823[2]
	Cone/Cup	LM503349A-LM503310[2]
	Repair Sleeve	KWK99139[2]
2002-1991 Z3, 318 Ser, 323 Ser	Seal	239146[2]
	Set	SET45[2]

Pinion

2008-1990 M3, 323 Ser, 325 Ser, 328 Ser, 330i, 330xi	Seal	1979
	Cone/Cup (Inner)	HM89449-HM89410
	Cone/Cup (Outer)	HM88542-HM88510
	Repair Sleeve	KWK99177
2005-1991 Z3, 318 Ser., 323 Ser.	Seal	1992
	Cone/Cup (Inner)	HM89446-HM89410
	Cone/Cup (Outer)	M86649-M86610
	Repair Sleeve	KWK99157

TRANSFER CASE**Input Shaft**

1991-1990 (A95)	Seal (M/T)	710310
	Repair Sleeve (M/T)	KWK99128
	Ball Bearing (A/T,M/T)	109TB

Front Output Shaft

1991-1990 (A95)	Seal	1172S
	Repair Sleeve	KWK99139

Rear Output Shaft

1991-1990 (A95)	Ball Bearing (Center)	107WB[2]
	Ball Bearing (Rr)	105CB[2]

²⁵New Item, Check For Availability

Mfg./Year	Model & Location	Part No.	Mfg./Year	Model & Location	Part No.
BMW - 3 Series - 318i, 318is, 318ti, 320i, 323ci, 323i, 323is, 325ci, 325i, 325is, 325ix, 328i, 328is, 328ci, 328xi, 330i, 330ci, 330xi, 335xi, M3, Z3 (cont.)					

4-SPEED AUTOMATIC TRANSMISSION

Torque Converter

2000-1990 (4L30E)	
Seal	3227
Repair Sleeve	KWK99174
1993-1990 (ZF4HP22)	
Seal	224052
Repair Sleeve	KWK99157

Rear Seal/Ext. Housing

2000-1990 (4L30E)	
Seal	710432
1993-1990 (ZF4HP22)	
Seal	710140

Selector Shaft Seal/Man. Shaft

2000-1990 (4L30E)	
Seal	8792S

5-SPEED AUTOMATIC TRANSMISSION

Torque Converter

2005-2001 (ZF5HP19)	
Seal	224510
Repair Sleeve	KWK99177
1999-1995 (ZF5HP18)	
Seal	224052
Repair Sleeve	KWK99157

Rear Seal/Ext. Housing

2005-1995 (ZF5HP18)(ZF5HP19)	
Seal	710140

Selector Shaft Seal/Man. Shaft

2005-1996 (5L40E)	
Seal	8792S

CLUTCH - 4 CYLINDER

Pilot Bearing

2000-1991 1796cc/1.8L, 1895cc/1.9L	
Ball Bearing	102CC
1994-1990 1766cc/1.8L, 1796cc/1.8L, 1990cc/2.0L, 2302cc/2.3L	
Ball Bearing	201CC

CLUTCH - 6 CYLINDER

Pilot Bearing

2003-1996 2494cc/2.5L, 2793cc/2.8L, 2990cc/3.0L, 3152cc/3.2L, 3245cc/3.2L	
Ball Bearing	102CC
1995-1990 2494cc/2.5L, 2693cc/2.7L, 2788cc/2.8L, 2985cc/3.0L, 2990cc/3.0L	
Ball Bearing	201CC

CLUTCH - 4 CYLINDER

Release Bearing

1999-1990 1766cc/1.8L, 1796cc/1.8L, 1895cc/1.9L, 1990cc/2.0L, 2302cc/2.3L	
Bearing Assy	614105

CLUTCH - 6 CYLINDER

Release Bearing

2002-1990 2494cc/2.5L, 2693cc/2.7L, 2788cc/2.8L, 2793cc/2.8L, 2985cc/3.0L, 2990cc/3.0L	
Bearing Assy	614105

5-SPEED MANUAL TRANSMISSION

Front Input Shaft

1996 (ZF S5 31)	
Seal	470672
1992-1991 (Getrag 245)	
Seal	223010
Repair Sleeve	KWK99114
1992-1990 (Getrag 240, 260)	
Seal	223535
Repair Sleeve	KWK99139
1991-1990 (Getrag 265)	
Seal	223010
Ball Bearing	306L[2]
Repair Sleeve	KWK99114

Countershaft

1991-1990	
Ball Bearing (Frt)	305AG[2]

Rear Output Shaft

1996 (ZF S5 31)	
Seal	224010
1992-1990	
Seal	473677
1991-1990 (Getrag 260)	
Seal	473677
Ball Bearing	306L[2]

A/C COMPRESSOR

1991-1990 (Nippondenso 10P15)(Axial)	
Ball Bearing	5000KFF[2]

ALTERNATOR

1994-1990 (Bosch 80, 105, 115, 140 Amp.)	
Ball Bearing (Rear End)	201CC[2]
1994-1990 (Bosch 80, 105, 115, 140 Amp.)	
Ball Bearing (Drive End)	303CC[2]
1993-1990 (Bosch 45, 65, 90 Amp.)	
Ball Bearing (Rear End)	201S[2]

Mfg./Year Model & Location Part No. Mfg./Year Model & Location Part No.

BMW - 3 Series - 318i, 318is, 318ti, 320i, 323ci, 323i, 323is, 325ci, 325i, 325is, 325ix, 328i, 328is, 328ci, 328xi, 330i, 330ci, 330xi, 335xi, M3, Z3 (cont.)

DRIVESHAFT SUPPORT

2007-1990 (1.1811 30mm I.D.)
Ball Bearing 106CC[2]

AUXILIARY SHAFT

6 Cylinder

2005-1990 2494cc/2.5L , 2494cc/2.5L (DOHC), 2693cc/2.7L, 2793cc/2.8L (DOHC), 2979cc/3.0L (DOHC)
Seal 223802
Repair Sleeve KWK99147

CRANKSHAFT FRONT SEAL

4 Cylinder

1999-1996 19895CC/1.9L (DOHC)
Seal Viton 229005
Repair Sleeve KWK99354
1995-1991 1766cc/1.8L
Seal Viton 229005
Repair Sleeve KWK99354
1991-1990 2.3L (DOHC)
Seal Viton 229005
Repair Sleeve KWK99354

6 Cylinder

2006-1994 2494cc/2.5L , 2494cc/2.5L (DOHC), 2693cc/2.7L, 2793cc/2.8L (DOHC), 2979cc/3.0L (DOHC)
Seal Viton 716484
Repair Sleeve KWK99189
2000-1996 3.2L
Seal Viton 229005
Repair Sleeve KWK99393

CRANKSHAFT REAR SEAL

4 Cylinder

1999-1990
Seal Viton 229005
Repair Sleeve KWK99354

6 Cylinder

2009-1990 2494cc/2.5L, 2693cc/2.7L, 2793cc/2.8L, 2990cc/3.0L
Seal Viton 229005
Repair Sleeve KWK99354
2005-1996 3152cc/3.2L
Seal Viton 229005

BMW - 4 Series - Z4

FRONT WHEEL

RWD

2008-2003 Z4
Hub Unit Bearing HA590308[2]

REAR WHEEL

RWD

2008-2003 Z4
Ball Bearing 513106[2]

REAR AXLE

Differential

2008-2003
Cone/Cup LM503349A-LM503310[2]

REAR AXLE

Pinion

2008-2003
Seal 1979
Cone/Cup (Inner) HM89449-HM89410
Cone/Cup (Outer) HM88542-HM88510

5-SPEED AUTOMATIC TRANSMISSION

Torque Converter

2005-2003 (ZF5HP19)
Seal 224510
Repair Sleeve KWK99177

Mfg./Year Model & Location Part No. Mfg./Year Model & Location Part No.

BMW - 4 Series - Z4 (cont.)

5-SPEED AUTOMATIC TRANSMISSION

Rear Seal/Ext. Housing

2007-2006 (A6HP19Z)
Seal 710140

Selector Shaft Seal/Man. Shaft

2005-2003 (5L40E)
Seal 8792S

AUXILIARY SHAFT

6 Cylinder

2007-2003 2494cc/2.5L (DOHC),
2979cc/3.0L (DOHC)
Seal 223802
Repair Sleeve KWK99147

CRANKSHAFT FRONT SEAL

6 Cylinder

2004-2003 2492cc/2.5L, 2959cc/3.0L
Seal Viton 716484
Repair Sleeve KWK99189

CRANKSHAFT REAR SEAL

6 Cylinder

2008-2003 2494cc/2.5L (DOHC),
2979cc/3.0L (DOHC),
2996cc/3.0L (DOHC)
Seal Viton 229005
Repair Sleeve KWK99354

BMW - 5 Series - 525i, 525iT, 525xi, 528i, 528xi, 530i, 530xi, 535i, 535xi, 540i, 545i, 550i, M5, X5

FRONT WHEEL

RWD

2009-2006 M5
Hub Unit Bearing HA590163[2]²⁵
2005-1997 525i, 528i, 530i, 540i
Hub Unit Bearing HA593427[2]
1995-1992 (Exc. M5)
Hub Unit Bearing 513125[2]
1993-1991 M5
Hub Unit Bearing 513096[2]
1991 525i, 535i
Hub Unit Bearing (To
3/31/91) 513096[2]
Hub Unit Bearing
(From 4/1/91) 513125[2]
1990
Hub Unit Bearing 513096[2]

REAR WHEEL

RWD

2009-2006 (Exc. M5 & Wagon)
Hub Unit Bearing 512225[2]
Bearing Module BM500010[2]²⁵
2005-1997
Hub Unit Bearing 512225[2]
1995-1992 525i
Ball Bearing (Wagon) 513180[2]
Ball Bearing (Sedan) 511020[2]
1995-1990 (Exc. 525i)
Ball Bearing 513180[2]
1993 525iT (Wagon)
Ball Bearing 513180[2]

REAR WHEEL (cont.)

RWD (cont.)

1991-1990 525i Sedan
Ball Bearing 511020[2]

AWD

2009-2006 528xi
Bearing Module BM500010[2]²⁵
Hub Unit Bearing 512225[2]

REAR AXLE

Differential

2005-2001 525i, 530i
Seal 473823[2]
Cone/Cup LM503349A-LM503310[2]
Repair Sleeve KWK99139[2]
2003-1997 M5, 528i, 540i
Seal 1012N[2]
Cone/Cup JLM104948-JLM104910[2]
Repair Sleeve KWK99177[2]
1995-1991 M5, 540i
Seal 1012N[2]
Cone/Cup JLM104948-JLM104910[2]
Repair Sleeve KWK99177[2]
1995-1990 524td, 525i, 528e, 528i, 530i,
533i, 535i, 535is
Seal 473823[2]
Cone/Cup LM503349A-LM503310[2]
Repair Sleeve KWK99139[2]

²⁵New Item, Check For Availability

Mfg./Year	Model & Location	Part No.	Mfg./Year	Model & Location	Part No.
BMW - 5 Series - 525i, 525iT, 525xi, 528i, 528xi, 530i, 530xi, 535i, 535xi, 540i, 545i, 550i, M5, X5 (cont.)					

REAR AXLE**Pinion**

2008-2001	525i, 530i	
Seal	1979
Cone/Cup (Inner)	HM89449-HM89410
Cone/Cup (Outer)	HM88542-HM88510
Repair Sleeve	KWK99177
2008-1997	M5, 528i, 540i	
Seal	223520
Cone/Cup (Inner)	HM803149-HM803110
Cone/Cup (Outer)	HM89448-HM89410
Repair Sleeve	KWK99139
1995-1991	M5, 540i	
Seal	223520
Cone/Cup (Inner)	HM803149-HM803110
Cone/Cup (Outer)	HM89448-HM89410
Repair Sleeve	KWK99139
1995-1990	524td, 525i, 528e, 528i, 530i, 533i, 535i, 535is	
Seal	1979
Cone/Cup (Inner)	HM89449-HM89410
Cone/Cup (Outer)	HM88542-HM88510
Repair Sleeve	KWK99177

4-SPEED AUTOMATIC TRANSMISSION**Torque Converter**

1997-1991	(4L30E)	
Seal	3227
Repair Sleeve	KWK99174
1993-1990	(ZF4HP22)	
Seal	224052
Repair Sleeve	KWK99157

Rear Seal/Ext. Housing

1999-1991	(4L30E)	
Seal	710437
1993-1990	(ZF4HP22)	
Seal	710140

Selector Shaft Seal/Man. Shaft

1999-1991	(4L30E)	
Seal	8792S

5-SPEED AUTOMATIC TRANSMISSION**Torque Converter**

2004-2002	(ZF5HP19)	
Seal	224510
Repair Sleeve	KWK99177
2003-1997	(ZF5HP24)	
Seal	224052
Repair Sleeve	KWK99157
1995-1994	(ZF5HP18)(ZF5HP30)	
Seal	224052
Repair Sleeve	KWK99157

5-SPEED AUTOMATIC TRANSMISSION**Rear Seal/Ext. Housing**

2004-1994	(ZF5HP18)(ZF5HP19)	
Seal	710140[2]

Selector Shaft Seal/Man. Shaft

2000	(5L40E)	
Seal	8792S

CLUTCH - 6 CYLINDER**Pilot Bearing**

1995-1990	2494cc/2.5L, 2693cc/2.7L, 2788cc/2.8L, 2985cc/3.0L, 2990cc/3.0L	
Ball Bearing	201CC

CLUTCH - 8 CYLINDER**Pilot Bearing**

1995-1994	2997cc/3.0L	
Ball Bearing	201CC

CLUTCH - 6 CYLINDER**Release Bearing**

2002-1990		
Bearing Assy	614105

5-SPEED MANUAL TRANSMISSION**Front Input Shaft**

1995-1991	(ZF S5 31)	
Seal	470672
1993-1990	(Getrag 260, 280)	
Seal	223535
Repair Sleeve	KWK99139

Rear Output Shaft

1995-1991	(ZF S5 31)	
Seal	224010
1993-1990	(Getrag 260, 280)	
Seal	473677

6-SPEED MANUAL TRANSMISSION**Front Input Shaft**

1995		
Seal	710360
Repair Sleeve	KWK99139

Rear Output Shaft

1995		
Seal Viton	710279

Mfg./Year	Model & Location	Part No.	Mfg./Year	Model & Location	Part No.
BMW - 5 Series - 525i, 525iT, 525xi, 528i, 528xi, 530i, 530xi, 535i, 535xi, 540i, 545i, 550i, M5, X5 (cont.)					

ALTERNATOR

1994-1990	(Bosch 80, 105, 115, 140 Amp.)	
	Ball Bearing (Drive End)	303CC[2]
1994-1990	(Bosch 80, 105, 115, 140 Amp.)	
	Ball Bearing (Rear End)	201CC[2]

DRIVESHAFT SUPPORT

1995-1990	(1.1811 30mm I.D.)	
	Ball Bearing	106CC[2]

POWER STEERING

Pump Shaft

1993-1990		
	Seal	222820

AUXILIARY SHAFT

6 Cylinder

2005-1991	2494cc/2.5L, 2793cc/2.8L, 2979cc/3.0L	
	Seal	223802
	Repair Sleeve	KWK99147

CRANKSHAFT FRONT SEAL

6 Cylinder

2005-1994	2494cc/2.5L, 2793cc/2.8L, 2979cc/3.0L	
	Seal Viton	716484
	Repair Sleeve	KWK99189
1993-1991	3535cc/3.5L (DOHC)	
	Seal	224462
1993-1990	3210cc/3.2L, 3430cc/3.5L	
	Seal	224250
	Repair Sleeve	KWK99166
1993-1990	2443cc/2.4L (Diesel) 2494cc/2.5L, 2693cc/2.7L	
	Seal Viton	716484
	Repair Sleeve	KWK99189

8 Cylinder

2005-1994	2997cc/3.0, 3982cc/4.0L, 4398cc/4.4L	
	Seal Viton	716484
	Repair Sleeve	KWK99189
2003-2000	4941cc/5.0L	
	Seal Viton	716484

CRANKSHAFT REAR SEAL

6 Cylinder

2008-1994	2494cc/2.5L, 2793cc/2.8L, 2979cc/3.0L	
	Seal Viton	229005
	Repair Sleeve	KWK99354
1993-1990	2443cc/2.4L (Diesel) 2494cc/2.5L, 2693cc/2.7L, 2788cc/2.8L, 3210cc/3.2L, 3430cc/3.4L, 3453cc/3.5L, 3535cc/3.5L	
	Seal Viton	229005
	Repair Sleeve	KWK99354

8 Cylinder

2008-2006	4.8L	
	Seal	231003
2005-1994	2997cc/3.0L, 3982cc/4.0L, 4398cc/4.4L	
	Seal	231003
	Repair Sleeve	KWK99393
2003-2000	4941cc/5.0L	
	Seal	231003
	Repair Sleeve	KWK99393

Mfg./Year	Model & Location	Part No.	Mfg./Year	Model & Location	Part No.
-----------	------------------	----------	-----------	------------------	----------

BMW - 6 Series - 645Ci, 650i, M6**FRONT WHEEL****RWD**

2009-2006 M6
Hub Unit Bearing HA590163[2]²⁵

REAR WHEEL**RWD**

2009-2006 (Exc. M6)
Bearing Module BM500010[2]²⁵
2009-2006 M6
Bearing Module BM500001[2]²⁵
2005-2004
Bearing Module BM500010[2]²⁵

REAR AXLE**Pinion**

2008-1990
Seal 223520
Cone/Cup (Inner) HM803149-HM803110
Cone/Cup (Outer) HM89448-HM89410
Repair Sleeve KWK99139

CRANKSHAFT FRONT SEAL**8 Cylinder**

2005-2004 4398cc/4.4L (DOHC)
Seal Viton 716484
Repair Sleeve KWK99189

CRANKSHAFT REAR SEAL**8 Cylinder**

2008-2006 4837cc/4.8L (DOHC)
Seal 231003
2005-2004 4398cc/4.4L (DOHC)
Seal 231003
Repair Sleeve KWK99393

BMW - 7 Series - 735i, 735il, 740i, 740il, 745i, 745Li, 750i, 750iL, 750Li, 760i, 760Li**FRONT WHEEL****RWD**

2009-2002
Hub Unit Bearing 513173[2]
2001-1995
Hub Unit Bearing HA592519[2]
1994-1992
Hub Unit Bearing 513125[2]
1991-1990
Hub Unit Bearing 513096[2]

REAR WHEEL**RWD**

2009-2002 745i, IL 760Li
Bearing Module BM500010[2]²⁵
2001-1995
Ball Bearing 511026[2]
1994-1990
Ball Bearing 513180[2]

REAR AXLE**Differential**

2001-1990 L7, 740i, 740il, 750il
Seal 1012N[2]
Cone/Cup JLM104948-JLM104910[2]
Repair Sleeve KWK99177[2]
1992-1990 733i, 735i, 735il
Seal 473823[2]
Cone/Cup LM503349A-LM503310[2]
Repair Sleeve KWK99139[2]

REAR AXLE**Pinion**

2007-1990 L7, 740i, 740il, 750il
Seal 223520
Cone/Cup (Inner) HM803149-HM803110
Cone/Cup (Outer) HM89448-HM89410
Repair Sleeve KWK99139
1992-1990 733i, 735i, 735il
Seal 1979
Cone/Cup (Inner) HM89449-HM89410
Cone/Cup (Outer) HM88542-HM88510
Repair Sleeve KWK99177

4-SPEED AUTOMATIC TRANSMISSION**Torque Converter**

1992-1990 (ZF 4HP 22, ZF 4HP 24)
Seal 224052
Repair Sleeve KWK99157

Rear Seal/Ext. Housing

1992-1990 (ZF 4HP 22, ZF 4HP 24)
Seal 710140

5-SPEED AUTOMATIC TRANSMISSION**Torque Converter**

2001-1993 (ZF5HP24)(ZF5HP30)
Seal 224052
Repair Sleeve KWK99157

²⁵New Item, Check For Availability

Mfg./Year Model & Location Part No. Mfg./Year Model & Location Part No.

BMW - 7 Series - 735i, 735il, 740i, 740il, 745i, 745Li, 750i, 750iL, 750Li, 760i, 760Li (cont.)

CLUTCH - 6 CYLINDER

Pilot Bearing

1992-1990
Ball Bearing 201CC

Release Bearing

1992-1990
Bearing Assy 614105

5-SPEED MANUAL TRANSMISSION

Front Input Shaft

1992-1990 (Getrag 260)
Seal 223535
Repair Sleeve KWK99139

Rear Output Shaft

1992-1990 (Getrag 260)
Seal 473677

ALTERNATOR

1994-1990 (Bosch 80, 115, 140 Amp.)
Ball Bearing (Drive End) 303CC
1994-1990 (Bosch 80, 115, 140 Amp.)
Ball Bearing (Rear End) 201CC
1993-1990 (Bosch 65, 90 Amp.)
Ball Bearing (Rear End) 201S

DRIVESHAFT SUPPORT

1997-1990 (1.1811 30mm I.D.)
Ball Bearing 106CC[2]

AUXILIARY SHAFT

12 Cylinder

2001-1990 4988cc/5.0L, 5379cc/5.4L
Seal 222820
Repair Sleeve KWK99111

CRANKSHAFT FRONT SEAL

6 Cylinder

1992-1990 3210cc/3.2L, 3430cc/3.5L
Seal 224250
Repair Sleeve KWK99166

8 Cylinder

2005-1993 3982cc/4.0L, 4398cc/4.4L
Seal Viton 716484
Repair Sleeve KWK99189

12 Cylinder

2007-2003 5972cc/6.0L
Seal Viton 716484
Repair Sleeve KWK99189
2001-1990 4988cc/5.0L, 5379cc/5.4L
Seal (Lower) 225530
Repair Sleeve (Lower) KWK99215
Seal (Upper) 222820
Repair Sleeve (Upper) KWK99111

CRANKSHAFT REAR SEAL

6 Cylinder

1992-1990 3210cc/3.2L, 3430cc/3.5L
Seal Viton 229005
Repair Sleeve KWK99354

8 Cylinder

2008-2006 4.8L
Seal 231003
2005-1993 3982cc/4.0L, 4398cc/4.4L
Seal 231003
Repair Sleeve KWK99393

12 Cylinder

2007-2003 5972cc/6.0L
Seal 231003
Repair Sleeve KWK99393
2001-1990 4988cc/5.0L, 5379cc/5.4L
Seal 231003
Repair Sleeve KWK99393

Mfg./Year Model & Location Part No. Mfg./Year Model & Location Part No.

BMW - 8 Series - 840ci, 850ci, 850csi, 850i, Z8 Roadster**FRONT WHEEL****RWD**

2003-2000	Z8 Roadster	
	Hub Unit Bearing	HA593427[2]
1997-1993		
	Hub Unit Bearing	513125[2]
1992		
	Hub Unit Bearing	
	(From 4/1/92)	513125[2]
	Hub Unit Bearing (To	
	3/31/92)	513096[2]
1991		
	Hub Unit Bearing	513096[2]

REAR WHEEL**RWD**

2003-1991	Z8 Roadster	
	Ball Bearing	511026[2]

REAR AXLE**Differential**

1997-1991		
	Seal	1012N[2]
	Cone/Cup	JLM104948-JLM104910[2]
	Repair Sleeve	KWK99177[2]

Pinion

1997-1991		
	Seal	223520
	Cone/Cup (Inner)	HM803149-HM803110
	Cone/Cup (Outer)	HM89448-HM89410
	Repair Sleeve	KWK99139

4-SPEED AUTOMATIC TRANSMISSION**Torque Converter**

1994-1991	(ZF 4HP 22, ZF 4HP 24)	
	Seal	224052
	Repair Sleeve	KWK99157

Rear Seal/Ext. Housing

1994-1991	(ZF 4HP 22, ZF 4HP 24)	
	Seal	710140

5-SPEED AUTOMATIC TRANSMISSION**Torque Converter**

1997-1994	(ZF5HP24)(ZF5HP30)	
	Seal	224052
	Repair Sleeve	KWK99157

6-SPEED MANUAL TRANSMISSION**Front Input Shaft**

1997-1991		
	Seal	710360
	Repair Sleeve	KWK99139

6-SPEED MANUAL TRANSMISSION**Rear Output Shaft**

1997-1991		
	Seal Viton	710279

ALTERNATOR

1997-1991	(Bosch 140 Amp.)	
	Ball Bearing (Drive End)	303CC
1997-1991	(Bosch 140 Amp.)	
	Ball Bearing (Rear End)	201CC

CRANKSHAFT FRONT SEAL**8 Cylinder**

2003-2000	4941cc/5.0L	
	Seal Viton	716484
	Repair Sleeve	KWK99189
1997-1994	3982cc/4.0L, 4398cc/4.4L	
	Seal Viton	716484
	Repair Sleeve	KWK99189

12 Cylinder

1997-1991	4988cc/5.0L, 5379cc/5.4L, 5576/5.6L	
	Seal (Lower)	225530
	Repair Sleeve (Lower)	KWK99215
	Seal (Upper)	222820
	Repair Sleeve (Upper)	KWK99111

CRANKSHAFT REAR SEAL**8 Cylinder**

2003-2000	4837cc/4.8L, 4941/5.0L	
	Seal	231003
	Repair Sleeve	KWK99393
1997-1994	3982cc/4.0L, 4398cc/4.4L	
	Seal	231003
	Repair Sleeve	KWK99393

12 Cylinder

1997-1991	4988cc/5.0L, 5379cc/5.4L, 5576/5.6L	
	Seal	231003
	Repair Sleeve	KWK99393

BMW - SUV - X3, X5, X6

FRONT WHEEL

AWD

2009-2004	X3	
Ball Bearing	510081[2]
2009-2001	X5	
Ball Bearing	510081[2]
2000	X5	
Ball Bearing (From	4/00) 510081[2]
Ball Bearing (To 4/00)	510080[2]

REAR WHEEL

AWD

2009-2004	X3	
Ball Bearing	511026[2]
2009-2000	X5	
Bearing Module	BM500010[2] ²⁵

REAR AXLE

Axle Shaft

2008		
Seal	473823
Repair Sleeve	KWK99139

Differential

2008-2000		
Cone/Cup	LM503349A-LM503310[2]

Pinion

2008-2000		
Seal	1979
Cone/Cup (Inner)	HM89449-HM89410
Cone/Cup (Outer)	HM88542-HM88510

5-SPEED AUTOMATIC TRANSMISSION

Torque Converter

2003-2000	(ZF5HP24)	
Seal	224052
Repair Sleeve	KWK99157

Selector Shaft Seal/Man. Shaft

2006-2000	(5L40E)	
Seal	8792S

DRIVESHAFT SUPPORT

2007-2000		
Ball Bearing	106CC

AUXILIARY SHAFT

6 Cylinder

2007-2001	2494cc/2.5L (DOHC), 2979cc/3.0L (DOHC), 2996cc/3.0L (DOHC)	
Seal	223802
Repair Sleeve	KWK99354

CRANKSHAFT FRONT SEAL

6 Cylinder

2009-2001	2494cc/2.5L (DOHC), 2979cc/3.0L (DOHC), 2996cc/3.0L (DOHC)	
Seal Viton	716484
Repair Sleeve	KWK99189

8 Cylinder

2009-2000	4398cc/4.4L (DOHC), 4598cc/4.6L (DOHC)	
Seal	231003
Repair Sleeve	KWK99393

CRANKSHAFT REAR SEAL

6 Cylinder

2009-2001	2494cc/2.5L (DOHC), 2979cc/3.0L (DOHC), 2996cc/3.0L (DOHC)	
Seal Viton	229005
Repair Sleeve	KWK99354

8 Cylinder

2009-2000	4398cc/4.4L (DOHC), 4598cc/4.6L (DOHC), 4799/4.8L (DOHC)	
Seal	231003
Repair Sleeve	KWK99393

²⁵New Item, Check For Availability

BUICK - FRONT DRIVE - Century**FRONT WHEEL****FWD**

2005 (Non-ABS)	
Hub Unit Bearing	HA590085[2] ⁸⁴
2005-2003 (ABS)	
Hub Unit Bearing	513179[2] ⁷³
2003 (Non-ABS)	
Hub Unit Bearing	513160[2] ⁸³
Hub Unit Bearing	HA590085[2] ⁸⁴
2002-1997 (ABS)	
Hub Unit Bearing	513121[2] ⁷²
1996-1994	
Hub Unit Bearing	513087[2] ⁴⁵
1993-1990	
Hub Unit Bearing	513016K[2] ⁶¹
Seal Kit	5698[2] ¹²

REAR WHEEL**FWD**

2005-2004 (ABS)	
Hub Unit Bearing	512237[2] ⁸⁴
2005-2003 (Non-ABS)	
Hub Unit Bearing	512221[2]
2003-1997 (ABS)	
Hub Unit Bearing	512151[2]
1996-1994	
Hub Unit Bearing	512078[2]
1993-1990	
Hub Unit Bearing	513018[2]

3-SPEED AUTOMATIC TRANSAXLE**Torque Converter**

1996-1990	
Seal	4072N

Output Shaft

1996-1994	
Seal (LH)	3543
Repair Sleeve (LH)	KWK99139
Seal (RH)	3543
Repair Sleeve (RH)	KWK99139
1993-1990	
Seal (LH)	3543
Repair Sleeve (LH)	KWK99139
Seal (RH)	3543
Repair Sleeve (RH)	KWK99139

Manual Shaft

1996-1990	
Seal	8792S
Repair Sleeve	KWK99049

4-SPEED AUTOMATIC TRANSAXLE**Torque Converter / Frt Pump**

2005-1990	
Seal	4072N

4-SPEED AUTOMATIC TRANSAXLE**Output Shaft**

2005-1997 (4T65 E)	
Seal (LH) (Yellow)	100165
Repair Sleeve (LH)	KWK99139
Seal (RH) (Green)	3543
Repair Sleeve (RH)	KWK99139
1996-1990	
Seal (LH)	710096
Repair Sleeve (LH)	KWK99139
Seal (RH)	3543
Repair Sleeve (RH)	KWK99139

Manual Shaft

2005-1990	
Seal	8792S
Repair Sleeve	KWK99049

ALTERNATOR

2001-1990	
Ball Bearing (Drive End)	203FF
Ball Bearing (Rear End)	100CCAB

POWER STEERING**Pump Shaft**

2002-1992	
Seal	70135
1991-1990	
Seal	221925

CRANKSHAFT FRONT SEAL**4 Cylinder**

1996-1993 134/2.2L	
Seal	9845
Repair Sleeve	KWK99176
1992-1990 151/2.5L	
Seal	9845
Repair Sleeve	KWK99176

6 Cylinder

2005-1994 3.1L	
Seal	9845
Repair Sleeve	KWK99176
Harmnc Balancer Slvs	88176
1993-1990 204/3.3L	
Seal Viton	710162
Repair Sleeve	KWK99193

CRANKSHAFT REAR SEAL**4 Cylinder**

1996-1993 134/2.2L	
Seal	4307V
Seal PTFE H/D Optiona	5273
Repair Sleeve Optional	KWK99298
1992-1990 151/2.5L	
Seal	3698

¹²Opt = Seal & O-Ring. Incl w/ Hub Unit. ⁴⁵Brg Flg Mtg Holes Non-Threaded. ⁶¹Kit = Seal,
Hub Nut, & Brg Unit ⁷²Steel Wire Clip. Brg Flg Mtg Holes Threaded. ⁷³Plastic Wire Clip.
⁸³Deplete Inventory ⁸⁴Reorder

Mfg./Year Model & Location Part No. Mfg./Year Model & Location Part No.

BUICK - FRONT DRIVE - Century (cont.)

CRANKSHAFT REAR SEAL

6 Cylinder

2005-1994	189/3.1L	
Seal	4307V
Seal PTFE H/D Optiona	5273
Repair Sleeve Optional	KWK99298
1993-1990	204/3.3L	
Seal Viton	320691
Repair Sleeve	KWK99328

BUICK - FRONT DRIVE - Electra, LeSabre, Park Avenue

FRONT WHEEL

FWD

2005-2001	LeSabre (2nd Design)	
Hub Unit Bearing	513179[2] ⁷³
2005-2001	Park Avenue (2nd Design)	
Hub Unit Bearing	513179[2] ⁷³
2001-2000	LeSabre (1st Design)	
Hub Unit Bearing	513121[2] ⁷²
2001-1997	Park Avenue (1st Design)	
Hub Unit Bearing	513121[2] ⁷²
1999-1994	LeSabre (ABS)	
Hub Unit Bearing	513087[2] ⁴⁵
1996-1994	Park Avenue	
Hub Unit Bearing	513087[2] ⁴⁵
1993-1992	LeSabre (ABS)	
Hub Unit Bearing	513087[2] ⁴⁵
1993-1992	Park Avenue	
Hub Unit Bearing	513087[2] ⁴⁵
1992	LeSabre (Non-ABS)	
Hub Unit Bearing	513088[2]
1991-1990		
Hub Unit Bearing	513016K[2] ⁶¹
Seal Kit	5698[2] ¹²

REAR WHEEL

FWD

2005-2000	LeSabre	
Hub Unit Bearing	512003[2]
2005-1997	Park Avenue	
Hub Unit Bearing	512003[2]
1999-1997	LeSabre (ABS)	
Hub Unit Bearing	513062[2]
1996-1991	(ABS)	
Hub Unit Bearing	513062[2]
1992-1990	(Non-ABS)	
Hub Unit Bearing	513018[2]
1990	(ABS)	
Hub Unit Bearing	513041[2]

4-SPEED AUTOMATIC TRANSAXLE

Torque Converter / Frt Pump

2005-1994	(4T60E, 4T65E)	
Seal	4072N
1993-1990	LeSabre	
Seal	4072N
1993-1990	Electra Park Ave	
Seal	4072N

Output Shaft

2005-1998	(4T65 E)	
Seal (LH) (Yellow)	100165
Repair Sleeve (LH)	KWK99193
Seal (RH) (Green)	3543
Repair Sleeve (RH)	KWK99193
1997-1994	(4T60E)	
Seal (LH)	710096
Repair Sleeve (LH)	KWK99193
Seal (RH)	3543
Repair Sleeve (RH)	KWK99193
1993-1990		
Seal (LH)	710096
Seal (RH)	3543

Manual Shaft

2005-1991	(4T65 E)	
Seal	8792S

ALTERNATOR

2001-1990	Electra, LeSabre, Electra Park Avenue, Park Avenue	
Ball Bearing (Drive End)	203FF
Ball Bearing (Rear End)	100CCAB

POWER STEERING

Pump Shaft

2002-1992		
Seal	7013S
1991-1990	(integral reservoir)	
Seal	221925
Ball Bearing	203FF[2]
1991-1990	(remote reservoir)	
Seal	7013S

CRANKSHAFT FRONT SEAL

6 Cylinder

2005-1990	3.0L, 3.8L	
Seal Viton	710162
Repair Sleeve	KWK99193

¹²Opt = Seal & O-Ring. Incl w/ Hub Unit. ⁴⁵Brg Flg Mtg Holes Non-Threaded. ⁶¹Kit = Seal, Hub Nut, & Brg Unit ⁷²Steel Wire Clip. Brg Flg Mtg Holes Threaded. ⁷³Plastic Wire Clip.

BUICK - FRONT DRIVE - Electra, LeSabre, Park Avenue (cont.)

CRANKSHAFT REAR SEAL

6 Cylinder

2005-1991	3.8L	
Seal Viton		320691
Repair Sleeve		KWK99328
Seal PTFE H/D		5291
1990	3.8L	
Seal		5591

BUICK - FRONT DRIVE - Allure, LaCrosse

FRONT WHEEL

FWD

2009-2005	(ABS)	
Hub Unit Bearing		HA590093[2] ⁴⁰
2008-2005	(Non-ABS)	
Hub Unit Bearing		HA590085[2] ⁸⁴

REAR WHEEL

FWD

2009-2005	(ABS)	
Hub Unit Bearing		HA590092[2]
2009-2005	(Non-ABS)	
Hub Unit Bearing		HA590074[2]

4-SPEED AUTOMATIC TRANSAXLE

Torque Converter / Frt Pump

2008-2005	(4T65 E)	
Seal		4072N

Output Shaft

2008-2005	(4T65 E)	
Seal (LH) (Yellow)		100165
Repair Sleeve (LH)		KWK99193
Seal (RH) (Green)		3543
Repair Sleeve (RH)		KWK99139

Manual Shaft

2008-2005	(4T65 E)	
Seal		8792S
Repair Sleeve		KWK99050

CRANKSHAFT FRONT SEAL

6 Cylinder

2009-2005	3.8L	
Seal Viton		710162
Repair Sleeve		KWK99193

8 Cylinder

2009-2008	5.3L	
Seal Viton		100470
Repair Sleeve		KWK99210

CRANKSHAFT REAR SEAL

6 Cylinder

2009-2008	5.3L	
Seal		100085
2009-2005	3.8L	
Seal Viton		320691
Seal PTFE H/D		5291
Repair Sleeve		KWK99328

8 Cylinder

2008	5.3L	
Seal		100085

⁴⁰5 Stud.

⁸⁴Reorder

Mfg./Year Model & Location Part No. Mfg./Year Model & Location Part No.

BUICK - FRONT DRIVE - Lucerne

FRONT WHEEL

FWD

2009-2006
Hub Unit Bearing HA590093[2]⁴⁰

REAR WHEEL

FWD

2009-2006
Hub Unit Bearing HA590149[2]²⁵

4-SPEED AUTOMATIC TRANSAXLE

Torque Converter / Frt Pump

2008-2006 (4T65 E)
Seal 4072N
2006 (4T80 E)
Seal 224840

Output Shaft

2008-2006 (4T65 E)
Seal (LH) (Yellow) 100165
Repair Sleeve (LH) KWK99193
Seal (RH) (Green) 3543
Repair Sleeve (RH) KWK99193
2006 (4T80 E)
Seal (LH) 714679
Repair Sleeve (LH) KWK99160
Seal (RH) 4674N
Repair Sleeve (RH) KWK99160

CAMSHAFT SEAL

8 Cylinder

2007-2006 4.6L (DOHC)
Seal Viton 710261

CRANKSHAFT FRONT SEAL

6 Cylinder

2008-2006 3.8L
Seal Viton 710162
Repair Sleeve KWK99193

CRANKSHAFT REAR SEAL

6 Cylinder

2008-2006 3.8L
Seal Viton 320691
Seal PTFE H/D 5291
Repair Sleeve KWK99328

8 Cylinder

2009-2006 4.6L (DOHC)
Seal Viton 710262

BUICK - FRONT DRIVE - Regal

FRONT WHEEL

FWD

2004-2003 (Non-ABS)
Hub Unit Bearing 513160[2]⁸³
Hub Unit Bearing HA590085[2]⁸⁴
2004-2001 (ABS)
Hub Unit Bearing 513179[2]⁷³
2001-1997 (ABS)
Hub Unit Bearing 513121[2]⁷²
1996-1990
Hub Unit Bearing 513044[2]

REAR WHEEL

FWD

2004-2003 (ABS)(Disc)
Hub Unit Bearing 512237[2]⁸⁴
2004-2003 (Non-ABS)
Hub Unit Bearing 512221[2]
2002-1999 (Disc)
Hub Unit Bearing 512150[2]⁸³
Hub Unit Bearing 512237[2]⁸⁴

REAR WHEEL (cont.)

FWD (cont.)

1998-1997 (ABS)(4 Whl. Disc)
Hub Unit Bearing 512150[2]⁸³
Hub Unit Bearing 512237[2]⁸⁴
1996 (1st Design)
Hub Unit Bearing 512004[2]¹¹
1996 (2nd Design)
Hub Unit Bearing 512151[2]¹⁰
1995-1992 (ABS)
Hub Unit Bearing 512004[2]
1993-1990 (Non-ABS)(Disc)
Hub Unit Bearing 513018[2]
1991-1990 (ABS)
Hub Unit Bearing 513042[2]

4-SPEED AUTOMATIC TRANSAXLE

Torque Converter / Frt Pump

2004-1990 (4T60E, 4T65E)
Seal 4072N

¹⁰Dia. Of Bolt At Strut & Knuckle = 14mm.
⁴⁰5 Stud. Item, Check For Availability

¹¹Dia. Of Bolt At Strut & Knuckle = 16mm.
⁷²Steel Wire Clip. Brg Flg Mtg Holes Threaded.

²⁵New

⁷³Plastic Wire Clip. ⁸³Deplete Inventory

⁸⁴Reorder

Mfg./Year	Model & Location	Part No.	Mfg./Year	Model & Location	Part No.
-----------	------------------	----------	-----------	------------------	----------

BUICK - FRONT DRIVE - Regal (cont.)**4-SPEED AUTOMATIC TRANSAXLE****Output Shaft**

2004-1997 (4T65 E)	
Seal (LH) (Yellow)	100165
Repair Sleeve (LH)	KWK99139
Seal (RH) (Green)	3543
Repair Sleeve (RH)	KWK99139
2000-1993 (4T60E)	
Seal (LH)	710096
Repair Sleeve (LH)	KWK99139
Seal (RH)	3543
Repair Sleeve (RH)	KWK99139
1998-1990	
Seal (LH)	710096
Repair Sleeve (LH)	KWK99139
Seal (RH)	3543
Repair Sleeve (RH)	KWK99139

Manual Shaft

2004-1990	
Seal	8792S

ALTERNATOR

1994-1993	
Ball Bearing (Drive End)	203FF
Ball Bearing (Rear End)	100CCAB

POWER STEERING**Pump Shaft**

2002-1992	
Seal	7013S
1991-1990 (remote reservoir)	
Seal	7013S

CRANKSHAFT FRONT SEAL**6 Cylinder**

2004-1990 3.8L	
Seal Viton	710162
Repair Sleeve	KWK99193

CRANKSHAFT FRONT SEAL (cont.)**6 Cylinder (cont.)**

1996-1990 189/3.1L	
Seal	9845
Repair Sleeve	KWK99176

CRANKSHAFT REAR SEAL**6 Cylinder**

2004-1990 3.8L	
Seal Viton	320691
Repair Sleeve	KWK99328
Seal PTFE H/D	5291
1996-1990 189/3.1L	
Seal	4307V
Seal PTFE H/D	5273
Repair Sleeve	KWK99298

BUICK - FRONT DRIVE - Riviera, Reatta**FRONT WHEEL****FWD**

1999-1997	
Hub Unit Bearing	513121[2] ⁷²
1996-1992	
Hub Unit Bearing	513087[2] ⁴⁵
1991-1990	
Hub Unit Bearing	513059[2]

REAR WHEEL**FWD**

1999-1991	
Hub Unit Bearing	512003[2]
1990 (ABS)	
Hub Unit Bearing	513041[2]

REAR WHEEL (cont.)**FWD (cont.)**

1990 (Non-ABS)	
Hub Unit Bearing	513018[2]

4-SPEED AUTOMATIC TRANSAXLE**Torque Converter / Frt Pump**

1999-1990 (4T60E, 4T65E)	
Seal	4072N

⁴⁵Brg Flg Mtg Holes Non-Threaded.⁷²Steel Wire Clip. Brg Flg Mtg Holes Threaded.

Mfg./Year Model & Location Part No. Mfg./Year Model & Location Part No.

BUICK - FRONT DRIVE - Riviera, Reatta (cont.)

4-SPEED AUTOMATIC TRANSAXLE

Output Shaft

1999-1997	
Seal (LH) (Yellow)	100165
Seal (RH) (Green)	3543
1996-1995	
Seal (LH)	100165
Seal (RH)	710096
1993-1990	
Seal (LH)	710096
Seal (RH)	3543

Manual Shaft

1999-1990	
Seal	8792S

ALTERNATOR

1999-1990	
Ball Bearing (Drive End)	203FF
Ball Bearing (Rear End)	100CCAB

POWER STEERING

Pump Shaft

1999-1992	
Seal	7013S
Ball Bearing	203FF[2]
1991-1990	
Seal	221925
Ball Bearing	203FF[2]

CRANKSHAFT FRONT SEAL

6 Cylinder

1999-1990 231/3.8L	
Seal Viton	710162
Repair Sleeve	KWK99193

CRANKSHAFT REAR SEAL

6 Cylinder

1999-1990 231/3.8L	
Seal Viton	320691
Repair Sleeve	KWK99328

BUICK - FRONT DRIVE - Skylark

FRONT WHEEL

FWD

1998-1990	
Hub Unit Bearing	513017K[2] ⁶¹
Seal Kit	5697[2] ¹²

REAR WHEEL

FWD

1998-1991 (ABS)	
Hub Unit Bearing	512001[2]
1991-1990 (Non-ABS)	
Hub Unit Bearing	513012[2]

CLUTCH

Release Bearing

1991-1990 4 Cyl. Quad4 (5 Spd.)	
Bearing Assy	614069

3-SPEED AUTOMATIC TRANSAXLE

Torque Converter

1995-1990	
Seal	4072N

3-SPEED AUTOMATIC TRANSAXLE

Output Shaft

1995-1990	
Seal	3543[2]
Repair Sleeve	KWK99139[2]

Manual Shaft

1995-1990	
Seal	8792S

4-SPEED AUTOMATIC TRANSAXLE

Torque Converter / Frt Pump

1998-1994	
Seal	4072N

Output Shaft

1998-1994	
Seal (LH)	710096
Repair Sleeve (LH)	KWK99139
Seal (RH)	3543
Repair Sleeve (RH)	KWK99139

¹²Opt = Seal & O-Ring. Incl w/ Hub Unit.

⁶¹Kit = Seal, Hub Nut, & Brg Unit

BUICK - FRONT DRIVE - Skylark (cont.)

4-SPEED AUTOMATIC TRANSAXLE

Manual Shaft

1998-1994
Seal8792S

4-SPEED MANUAL TRANSAXLE

Output Shaft

1998-1995
Seal (LH) 710096
Repair Sleeve (LH) KWK99139
Seal (RH)3543
Repair Sleeve (RH)KWK99139

ALTERNATOR

1998-1990
Ball Bearing (Drive End)203FF
Ball Bearing (Rear End)100CCAB

CAMSHAFT SEAL

4 Cylinder

1997-1996 146/2.4L
Seal (Frt) 223605

CRANKSHAFT FRONT SEAL

4 Cylinder

1998-1996 146/2.4L
Seal Viton 320259
Repair Sleeve KWK99199
1995-1990 138/2.3L
Seal Viton 320259
Repair Sleeve KWK99199
1991-1990 151/2.5L
Seal9845
Repair Sleeve KWK99176

6 Cylinder

1998-1994 189/3.1L
Seal9845
Repair Sleeve KWK99176
1993-1990 204/3.3L
Seal Viton 710162
Repair Sleeve KWK99193

CRANKSHAFT REAR SEAL

4 Cylinder

1998-1996 146/2.4L
Seal40375
1995-1990 138/2.3L
Seal40375
1991-1990 151/2.5L
Seal3698

6 Cylinder

1998-1994 189/3.1L
Seal4307V
Seal PTFE H/D 5273
Repair Sleeve KWK99298
1993-1990 204/3.3L
Seal Viton 320691
Repair Sleeve KWK99328

BUICK - REAR DRIVE - LeSabre

FRONT WHEEL

RWD

1990
Seal (Inner)8871[2]
Set (Inner) SET6[2]
Set (Outer) SET3[2]

REAR WHEEL

RWD

1990 LeSabre
Seal8660S[2]
Cylindrical Bearing 5707[2]
Bearing & Seal Kit TRP1563TAV[2]¹⁹

¹⁹Opt. Axle Rpr Brg. Replaces O.E. Brg & Seal

Mfg./Year Model & Location Part No. Mfg./Year Model & Location Part No.

BUICK - REAR DRIVE - LeSabre (cont.)

REAR AXLE

Differential Rebuild Kit

1990 (8.5" R.G.)
 KitDRK321

Differential

1990 (7.5", 8.5" R.G.)
 Cone/Cup LM501349-LM501314[2]

Pinion

1990 LeSabre
 Seal2043
 Cone/Cup (Inner) M802048-M802011
 Cone/Cup (Outer) M88048-M88010[2]

4-SPEED AUTOMATIC TRANSMISSION

Torque Converter

1990 LeSabre
 Seal3227
 Repair Sleeve KWK99174

Rear Seal/Ext. Housing

1990 LeSabre
 Seal (Rr)9613S

Selector Shaft Seal/Man. Shaft

1990 LeSabre
 Seal8792S

GENERATOR / ALTERNATOR

1990
 Ball Bearing (Drive End) 203F
 Ball Bearing (Rear End) MNJ471S

POWER STEERING

Pump Shaft

1990
 Seal7013S

Worm Shaft

1990
 Seal222025

CRANKSHAFT FRONT SEAL

8 Cylinder

1990 307/5.0L
 Seal472082
 Repair Sleeve KWK99199

CRANKSHAFT REAR SEAL

8 Cylinder

1990 307/5.0L
 Seal Rope5095

BUICK - REAR DRIVE - Roadmaster Estate Wagon, Roadmaster Sedan

FRONT WHEEL

RWD

1996-1991
 Seal (Inner)4739[2]
 Set (Inner) SET6[2]
 Set (Outer) SET3[2]

REAR WHEEL

RWD

1996-1991 (Sedan)
 Seal (Inner)8660S[2]
 Cylindrical Bearing
 (Inner)5707[2]
 Bearing & Seal Kit TRP1563TAV[2]¹⁹
 1996-1991 (Wagon)
 Seal (Inner)8835S[2]
 Cylindrical Bearing 6408[2]
 Bearing & Seal Kit TRP1559TV[2]¹⁹

¹⁹Opt. Axle Rpr Brg. Replaces O.E. Brg & Seal

BUICK - REAR DRIVE - Roadmaster Estate Wagon, Roadmaster Sedan (cont.)

REAR AXLE

Differential Rebuild Kit

1996-1991
 KitDRK321

Differential

1996-1991
 Cone/Cup LM501349-LM501314[2]

Pinion

1996-1991
 Seal2043
 Cone/Cup (Inner) M802048-M802011
 Cone/Cup (Outer) M88048-M88010

4-SPEED AUTOMATIC TRANSMISSION

Torque Converter

1996-1991
 Seal3227
 Repair Sleeve KWK99174

Rear Seal/Ext. Housing

1996-1991
 Seal9613S
 Seal Kit 5200⁶⁴

Selector Shaft Seal/Man. Shaft

1996-1991
 Seal8792S

A/C COMPRESSOR

1996-1991
 Ball Bearing907257[2]
 1996-1991
 Ball Bearing (Frt Head) S128

GENERATOR / ALTERNATOR

1996-1991
 Ball Bearing (Drive End)203FF
 Ball Bearing (Rear End)100CCAB

POWER STEERING

Pitman Shaft

1996-1991
 Seal KitPSK1²⁴

Pump Shaft

1996-1991
 Seal480821

Worm Shaft

1996-1991
 Seal222025

CRANKSHAFT FRONT SEAL

8 Cylinder

1996-1992 350/5.7L
 Seal9845
 Repair Sleeve KWK99176
 1992-1991 305/5.0L
 Seal9845
 Repair Sleeve KWK99176

CRANKSHAFT REAR SEAL

8 Cylinder

1996-1992 350/5.7L
 Seal Viton 4359V
 Seal PTFE H/D 5274
 Repair Sleeve KWK99364
 1992-1991 305/5.0L
 Seal Viton 4359V
 Seal PTFE H/D 5274
 Repair Sleeve KWK99364

²⁴Opt. Kit = Seals 5683 & 5684. Not Sold Separately

⁶⁴Seal & Bushing Kit

Mfg./Year Model & Location Part No. Mfg./Year Model & Location Part No.

BUICK - Minivan - Terraza

FRONT WHEEL

FWD

2007-2006
 Hub Unit Bearing HA590157[2]²⁵
 2005
 Hub Unit Bearing HA590093[2]⁴⁰

AWD

2006
 Hub Unit Bearing HA590157[2]²⁵
 2005
 Hub Unit Bearing HA590093[2]⁴⁰

REAR WHEEL

FWD

2007
 Hub Unit Bearing HA590116[2]²⁵
 2006
 Hub Unit Bearing HA590158[2]²⁵
 2005 (Exc. Indep. Rr.
 Susp.)(Rectangular Flange)
 Hub Unit Bearing HA590092[2]
 2005 (Indep. Rr. Susp.)(Triangular
 Flange)
 Hub Unit Bearing HA590091[2]

AWD

2006
 Hub Unit Bearing HA590157[2]²⁵
 2005
 Hub Unit Bearing HA590093[2]⁴⁰

TRANSFER CASE

Input Shaft

2006-2005
 Cone/Cup LM503349-LM503310

Front Output Shaft

2006-2005
 Bearing Assy 32006[2]

Mainshaft

2006-2005
 Bearing Assy 32006[2]

4-SPEED AUTOMATIC TRANSAXLE

Torque Converter / Frt Pump

2006-2005 (4T65 E)
 Seal 4072N

4-SPEED AUTOMATIC TRANSAXLE

Output Shaft

2007-2005 (4T65 E)
 Seal (LH) (Yellow) 100165
 Repair Sleeve (LH) KWK99139
 Seal (RH) (Green) 3543
 Repair Sleeve (LH) KWK99139

Manual Shaft

2007-2005 (4T65 E)
 Seal 8792S

CRANKSHAFT FRONT SEAL

6 Cylinder

2006 3.9L
 Seal 9845
 Repair Sleeve KWK99176
 Harmnc Balancer Slvs 88176
 2006-2005 3.5L
 Seal 9845
 Repair Sleeve KWK99176
 Harmnc Balancer Slvs 88176

CRANKSHAFT REAR SEAL

6 Cylinder

2007-2005 3.5L
 Seal 4307V
 Seal PTFE H/D 5273
 Repair Sleeve KWK99298
 2006 3.9L
 Seal 4307V
 Seal PTFE H/D 5273
 Repair Sleeve KWK99298

²⁵New Item, Check For Availability

⁴⁰5 Stud.

Mfg./Year	Model & Location	Part No.	Mfg./Year	Model & Location	Part No.
-----------	------------------	----------	-----------	------------------	----------

BUICK - SUV - Enclave**FRONT WHEEL****FWD**

2009-2008

Hub Unit Bearing HA590227[2]²⁵**AWD**

2009-2008

Hub Unit Bearing HA590227[2]²⁵**REAR WHEEL****FWD**

2009-2008

Hub Unit Bearing HA590227[2]²⁵**REAR WHEEL****AWD**

2009-2008

Hub Unit Bearing HA590227[2]²⁵**BUICK - SUV - Rainier****FRONT WHEEL****RWD**

2007-2004

Hub Unit Bearing 513188[2]

AWD

2007-2004

Hub Unit Bearing 513188[2]

REAR WHEEL**RWD**

2007-2004

Seal 4762N[2]

Cylindrical Bearing 513067[2]¹⁹Bearing & Seal Kit TRP59047[2]¹⁹**AWD**

2007-2004

Seal 4762N[2]

Cylindrical Bearing 513067[2]¹⁹Bearing & Seal Kit TRP59047[2]¹⁹**FRONT AXLE****Differential Rebuild Kit**

2007-2004

Kit DRK320A

4WD FRONT AXLE**Axle Shaft**

2007-2004

Seal 710491[2]

Differential

2007-2004

Set SET11[2]

4WD FRONT AXLE**Pinion**

2007-2004

Seal 8611N

Cone/Cup (Inner) M88048S-M88010

Cone/Cup (Outer) M86649-M86610

Repair Sleeve KWK99152

REAR AXLE**Differential Rebuild Kit**

2007-2004 (7.5" R.G., 7.625" R.G.)

Kit DRK320C

2007-2004 (8" R.G.)

Kit DRK320D

2007-2004 (8.625" RG)

Kit DRK321C

Differential

2007-2004 (8.625" R.G.)

Set SET36[2]

2005-2004 (7.5" R.G., 7.625" R.G.)

Cone/Cup LM501349-LM501314[2]

Pinion

2007-2004 (8.625" R.G.)

Seal 710506

Cone/Cup (Inner) NP457992-NP926068

Cone/Cup (Outer) M86649-M86610

2005-2004 (7.5" R.G., 7.625" R.G.)

Seal 710506

Cone/Cup (Inner) HM89249-HM89210

Cone/Cup (Outer) M86649-M86610

4-SPEED AUTOMATIC TRANSMISSION**Torque Converter**

2006-2004 (4L60E)

Seal 3227

¹⁹Opt. Axle Rpr Brg. Replaces O.E. Brg & Seal²⁵New Item, Check For Availability

Mfg./Year Model & Location Part No. Mfg./Year Model & Location Part No.

BUICK - SUV - Rainier (cont.)

4-SPEED AUTOMATIC TRANSMISSION

Rear Seal/Ext. Housing

2006-2004 (4L60E)
 Seal9613S
 Seal Kit5200⁶⁴

Selector Shaft Seal/Man. Shaft

2007-2004 (4L60E)
 Seal8792S

CRANKSHAFT FRONT SEAL

8 Cylinder

2007-2004 325/ 5.3L
 Seal Viton100470

CRANKSHAFT REAR SEAL

8 Cylinder

2007-2004 325/ 5.3L
 Seal100085

BUICK - SUV - Rendezvous

FRONT WHEEL

FWD

2007-2003 (Non-ABS)
 Hub Unit BearingHA590048[2]⁸³
 Hub Unit BearingHA590085[2]⁸⁴
 2007-2002 (ABS)
 Hub Unit Bearing513187[2]

AWD

2006-2002 (ABS)
 Hub Unit Bearing513187[2]

REAR WHEEL

FWD

2007-2003 (Non-ABS)(Disc)
 Hub Unit Bearing512236[2]
 2007-2002 (ABS)(Disc)
 Hub Unit Bearing512222[2]

AWD

2006-2002
 Hub Unit Bearing513121[2]⁷²

TRANSFER CASE

Input Shaft

2006-2002
 Cone/CupLM503349-LM503310

Front Output Shaft

2006-2002
 Bearing Assy32006[2]

TRANSFER CASE

Mainshaft

2006-2002
 Bearing Assy32006[2]

4-SPEED AUTOMATIC TRANSAXLE

Torque Converter / Frt Pump

2007-2002 (4T65 E)
 Seal4072N

Output Shaft

2007-2002 (4T65 E)
 Seal (LH) (Yellow)100165
 Repair Sleeve (LH)KWK99139
 Seal (RH) (Green)3543
 Repair Sleeve (RH)KWK99139

Manual Shaft

2007-2002 (4T65 E)
 Seal8792S
 Repair SleeveKWK99050

POWER STEERING

Pump Shaft

2002
 Seal7013S

⁶⁴Seal & Bushing Kit

⁷²Steel Wire Clip. Brg Flg Mtg Holes Threaded.

⁸³Deplete Inventory

⁸⁴Reorder

Mfg./Year Model & Location Part No. Mfg./Year Model & Location Part No.

BUICK - SUV - Rendezvous (cont.)**CRANKSHAFT FRONT SEAL****6 Cylinder**

2007-2006	3.5L	
Seal	9845
Repair Sleeve	KWK99176
Harmnc Balancer Slvs	88176
2005-2002	207/3.4L	
Seal	9845
Repair Sleeve	KWK99176

CRANKSHAFT REAR SEAL**6 Cylinder**

2007-2006	3.5L	
Seal	4307V
Seal PTFE H/D	5273
Repair Sleeve	KWK99298

CRANKSHAFT REAR SEAL (cont.)**6 Cylinder (cont.)**

2005-2002	3.4L	
Seal	4307V
Seal PTFE H/D	5273
Repair Sleeve	KWK99298

CADILLAC - FRONT DRIVE - Allante**FRONT WHEEL****FWD**

1993		
Hub Unit Bearing	513087[2] ⁴⁵
1992-1990		
Hub Unit Bearing	513059[2]

REAR WHEEL**FWD**

1993		
Hub Unit Bearing	512006[2]
1992-1991		
Hub Unit Bearing	512003[2]
1990		
Hub Unit Bearing	513041[2]

4-SPEED AUTOMATIC TRANSAXLE**Torque Converter / Frt Pump**

1993		
Seal	224840
Repair Sleeve	KWK99189
1992-1990		
Seal	4072N

Output Shaft

1993		
Seal (LH)	714679
Repair Sleeve (LH)	KWK99160
Seal (RH)	4674N
Repair Sleeve (RH)	KWK99160
1992-1990		
Seal (LH)	710096
Repair Sleeve (LH)	KWK99139
Seal (RH)	3543
Repair Sleeve (RH)	KWK99139

4-SPEED AUTOMATIC TRANSAXLE**Manual Shaft**

1993-1990		
Seal	8792S

A/C COMPRESSOR

1993-1990	(Frigidaire R4)(Harrison DA6, V5, HR6)	
Ball Bearing	907257[2]

ALTERNATOR

1991-1990		
Ball Bearing (Drive End)	203FF
Ball Bearing (Rear End)	100CCAB

POWER STEERING**Pump Shaft**

1993-1992		
Seal	7013S
1991-1990		
Seal	221925

Worm Shaft

1990		
Seal	222510

CRANKSHAFT FRONT SEAL**8 Cylinder**

1993	281/4.6L	
Seal Viton	710263
Repair Sleeve	KWK99199
1992-1990	273/4.5L	
Seal	471424
Repair Sleeve	KWK99199

⁴⁵Brg Flg Mtg Holes Non-Threaded.

Mfg./Year Model & Location Part No. Mfg./Year Model & Location Part No.

CADILLAC - FRONT DRIVE - Allante (cont.)

CRANKSHAFT REAR SEAL

8 Cylinder

1993	281/4.6L	
Seal Viton	710262
1992-1990	273/4.5L	
Seal Viton	710075

CADILLAC - FRONT DRIVE - DeVille, Fleetwood

FRONT WHEEL

FWD

2005-2001	(2nd Design)	
Hub Unit Bearing	513179[2] ⁷³
2001-1997	(1st Design)(Exc. H/D Suspension, Hearse/Limo)	
Hub Unit Bearing	513121[2] ⁷²
1996-1994		
Hub Unit Bearing	513087[2] ⁴⁵
1993-1992	(ABS)	
Hub Unit Bearing	513087[2] ⁴⁵
1993-1992	(Non-ABS)	
Hub Unit Bearing	513088[2]
1993-1990	(J55 H/D Brks.)	
Hub Unit Bearing	513063[2]
Hub Unit Bearing	513016K[2] ⁶¹

REAR WHEEL

FWD

2005-2000	(Exc. H/D Suspension, Hearse/Limo)	
Hub Unit Bearing	512003[2]
2002-1997	(H/D Suspension, Hearse/Limo)	
Cone	JXC25469CA[2] ⁰⁹
1999-1994	(Exc. H/D Suspension, Hearse/Limo)	
Hub Unit Bearing	512006[2]
1993-1991	(ABS)	
Hub Unit Bearing	513062[2]
1993-1990	(J55 H/D Brks.)	
Hub Unit Bearing	512005[2]
1993-1990	(Non-ABS)	
Hub Unit Bearing	513018[2]
1990	(ABS)	
Hub Unit Bearing	513041[2]

4-SPEED AUTOMATIC TRANSAXLE

Torque Converter / Frt Pump

2005-1993	(4T80 E)	
Seal	224840
Repair Sleeve	KWK99189
1995-1990	(4T60E)	
Seal	4072N
1990	(THM440 T4)	
Seal	4072N

4-SPEED AUTOMATIC TRANSAXLE

Output Shaft

2005-1993	(4T80 E)	
Seal (LH)	714679
Seal (RH)	4674N
1995-1990	(4T60E)	
Seal (LH)	710096
Repair Sleeve (LH)	KWK99139
Seal (RH)	3543
Repair Sleeve (RH)	KWK99139
1990	(THM440 T4)	
Seal (LH)	710096
Repair Sleeve (LH)	KWK99139
Seal (RH)	3543
Repair Sleeve (RH)	KWK99139

Manual Shaft

2005-1990		
Seal	8792S

A/C COMPRESSOR

2002-1990	(Frigidaire R4)(Harrison DA6, V5, HR6)	
Ball Bearing	907257[2]

ALTERNATOR

1993-1990		
Ball Bearing (Drive End)	203FF
Ball Bearing (Rear End)	100CCAB

POWER STEERING

Pump Shaft

1993-1992		
Seal	7013S
1991-1990		
Seal	221925
Ball Bearing	203FF[2]

CAMSHAFT SEAL

8 Cylinder

2002-1994	281/4.6L	
Seal Viton	710261

CRANKSHAFT FRONT SEAL

8 Cylinder

2005-2003	279/4.6L (DOHC)	
Seal Viton	710261

⁰⁹Use Assembly 90UA7 ⁴⁵Brg Flg Mtg Holes Non-Threaded. ⁶¹Kit = Seal, Hub Nut, & Brg Unit
⁷²Steel Wire Clip. Brg Flg Mtg Holes Threaded. ⁷³Plastic Wire Clip.

Mfg./Year Model & Location Part No. Mfg./Year Model & Location Part No.

CADILLAC - FRONT DRIVE - DeVille, Fleetwood (cont.)

CRANKSHAFT FRONT SEAL (cont.)

8 Cylinder (cont.)

2002-1994	281/4.6L	
Seal Viton		710263
Repair Sleeve		KWK99199
1995-1991	300/4.9L	
Seal		471424
Repair Sleeve		KWK99199
1990	273/4.5L	
Seal		471424
Repair Sleeve		KWK99199

CRANKSHAFT REAR SEAL (cont.)

8 Cylinder (cont.)

1990	273/4.5L	
Seal Viton		710075

CRANKSHAFT REAR SEAL

8 Cylinder

2005-2003	4.6L/279 DOHC	
Seal Viton		710262
2002-1994	281/4.6L	
Seal Viton		710262
1995-1991	300/4.9L	
Seal Viton		710075

CADILLAC - FRONT DRIVE - DTS

FRONT WHEEL

FWD

2008-2006		
Hub Unit Bearing		HA590093[2] ⁴⁰

REAR WHEEL

FWD

2008-2006		
Hub Unit Bearing		HA590149[2] ²⁵

4-SPEED AUTOMATIC TRANSAXLE

Torque Converter / Frt Pump

2006	(4T80 E)	
Seal		224840

Output Shaft

2009-2006	(4T80 E)	
Seal (LH)		714679
Seal (RH)		4674N

Manual Shaft

2008-2006	(4T80 E)	
Seal		8792S

CRANKSHAFT REAR SEAL

8 Cylinder

2008-2006	4.6L	
Seal Viton		710262

²⁵New Item, Check For Availability

⁴⁰5 Stud.

Mfg./Year Model & Location Part No. Mfg./Year Model & Location Part No.

CADILLAC - FRONT DRIVE - Eldorado

FRONT WHEEL

FWD

2002-2001 (2nd Design)	
Hub Unit Bearing	513179[2] ⁷³
2001-1997 (1st Design)	
Hub Unit Bearing	513121[2] ⁷²
1996-1992	
Hub Unit Bearing	513087[2] ⁴⁵
1991-1990	
Hub Unit Bearing	513059[2]

REAR WHEEL

FWD

2002-1993	
Hub Unit Bearing	512006[2]
1992-1991	
Hub Unit Bearing	512003[2]
1990 (ABS)	
Hub Unit Bearing	513041[2]
1990 (Non-ABS)	
Hub Unit Bearing	513018[2]

4-SPEED AUTOMATIC TRANSAXLE

Torque Converter / Frt Pump

2002-1993 (4T80 E)	
Seal	224840
Repair Sleeve	KWK99189
1995-1990 (4T60E)	
Seal	4072N
1990 (THM440)	
Seal	4072N

Output Shaft

2002-1993 (4T80)	
Seal (LH)	714679
Seal (RH)	4674N
1995-1990 (4T60E)	
Seal (LH)	710096
Repair Sleeve (LH)	KWK99139
Seal (RH)	3543
Repair Sleeve (RH)	KWK99139
1990 (THM440)	
Seal (LH)	710096
Repair Sleeve (LH)	KWK99139
Seal (RH)	3543
Repair Sleeve (RH)	KWK99139

Manual Shaft

2002-1990	
Seal	8792S

A/C COMPRESSOR

2002-1990 (Frigidaire R4)(Harrison DA6, V5, HR6)	
Ball Bearing	907257[2]

ALTERNATOR

1991-1990	
Ball Bearing (Drive End)	203FF
Ball Bearing (Rear End)	100CCAB

POWER STEERING

Pitman Shaft

1990	
Seal Kit	PSK1 ²⁴

Pump Shaft

2001-1994 281/4.6L	
Ball Bearing	203FF[2]
1993-1991 281/4.6L	
Seal	7013S
1993-1991 299/4.9L	
Seal	480821
1990	
Seal	221925
Ball Bearing	203FF[2]

Worm Shaft

1991-1990	
Seal	222025

CRANKSHAFT FRONT SEAL

8 Cylinder

2002-1993 281/4.6L	
Seal Viton	710263
Repair Sleeve	KWK99199
1993-1991 300/4.9L	
Seal	471424
Repair Sleeve	KWK99199
1990 273/4.5L	
Seal	471424
Repair Sleeve	KWK99199

CRANKSHAFT REAR SEAL

8 Cylinder

2002-1993 281/4.6L	
Seal Viton	710262
1993-1991 300/4.9L	
Seal Viton	710075
1990 273/4.5L	
Seal Viton	710075

²⁴Opt. Kit = Seals 5683 & 5684. Not Sold Separately

⁴⁵Brg Flg Mtg Holes Non-Threaded.

⁷²Steel Wire Clip. Brg Flg Mtg Holes Threaded.

⁷³Plastic Wire Clip.

CADILLAC - FRONT DRIVE - Seville**FRONT WHEEL****FWD**

2004-2001	
Hub Unit Bearing	513179[2] ⁷³
2001-1997	
Hub Unit Bearing	513121[2] ⁷²
1996-1992	
Hub Unit Bearing	513087[2] ⁴⁵
1991-1990	
Hub Unit Bearing	513059[2]

REAR WHEEL**FWD**

2004-1998	
Hub Unit Bearing	512003[2]
1997-1993	
Hub Unit Bearing	512006[2]
1992-1991	
Hub Unit Bearing	512003[2]
1990 (ABS)	
Hub Unit Bearing	513041[2]
1990 (Non-ABS)	
Hub Unit Bearing	513018[2]

4-SPEED AUTOMATIC TRANSAXLE**Torque Converter / Frt Pump**

2004-1993 (4T80 E)	
Seal	224840
Repair Sleeve	KWK99189
1995-1990 (4T60E)	
Seal	4072N
1992-1990 (THM440)	
Seal	4072N

Output Shaft

2004-1993 (4T80 E)	
Seal (LH)	714679
Seal (RH)	4674N
1995-1990 (4T60E)	
Seal (LH)	710096
Repair Sleeve (LH)	KWK99139
Seal (RH)	3543
Repair Sleeve (RH)	KWK99139
1992-1990 (THM440)	
Seal (LH)	710096
Repair Sleeve (LH)	KWK99139
Seal (RH)	3543
Repair Sleeve (RH)	KWK99139

Manual Shaft

2004-1990	
Seal	8792S

A/C COMPRESSOR

2002-1990 (Frigidaire R4)(Harrison DA6, V5, HR6)	
Ball Bearing	907257[2]

ALTERNATOR

1991-1990	
Ball Bearing (Drive End)	203FF
Ball Bearing (Rear End)	100CCAB

POWER STEERING**Pump Shaft**

2001-1994	
Ball Bearing	203FF[2]
1993-1991 281/4.6L	
Seal	7013S
1993-1991 299/4.9L	
Seal	480821
1990	
Seal	221925
Ball Bearing	203FF[2]

CAMSHAFT SEAL**8 Cylinder**

2001-1994 281/4.6L	
Seal Viton	710261

CRANKSHAFT FRONT SEAL**8 Cylinder**

2002-1993 281/4.6L	
Seal Viton	710263
Repair Sleeve	KWK99199
1993-1991 300/4.9L	
Seal	471424
Repair Sleeve	KWK99199
1990 273/4.5L	
Seal	471424
Repair Sleeve	KWK99199

CRANKSHAFT REAR SEAL**8 Cylinder**

2004-1993 4.6L (DOHC)	
Seal Viton	710262
1993-1991 300/4.9L	
Seal Viton	710075
1990 273/4.5L	
Seal Viton	710075

⁴⁵Brg Flg Mtg Holes Non-Threaded.
Wire Clip.⁷²Steel Wire Clip. Brg Flg Mtg Holes Threaded.⁷³Plastic

Mfg./Year Model & Location Part No. Mfg./Year Model & Location Part No.

CADILLAC - REAR DRIVE - Comm. Chassis/Limousine, DeVille, Fleetwood

REAR WHEEL

RWD

1992-1990 (11" Brks.)
 Seal8660S[2]
 Cylindrical Bearing5707[2]
 Bearing & Seal KitTRP1563TAV[2]¹⁹

REAR AXLE

Differential Rebuild Kit

1996-1991 (9.5" R.G.)
 KitDRK324
 1990 (7.5" R.G.)
 KitDRK320

Differential

1996-1991 (9.5" R.G.)
 Cone/CupJLM506849-JLM506811[2]
 1996-1990 (7.50", 8.50" R.G.)
 Cone/CupLM501349-LM501314[2]

Pinion

1996-1991 (9.5" R.G.)
 Seal3896
 Cone/Cup (Inner)HM804846-HM804810
 Cone/Cup (Outer)HM88649-HM88610
 1996-1990 (8.5" R.G.)
 Seal2043
 Cone/Cup (Inner)M802048-M802011
 Cone/Cup (Outer)M88048-M88010
 1990 (7.5" R.G.)
 Seal8610
 Cone/Cup (Inner)HM89249-HM89210
 Cone/Cup (Outer)M86649-M86610

3-SPEED AUTOMATIC TRANSMISSION

Torque Converter

1990 (THM200, 2004R)
 Seal3227
 Repair SleeveKWK99174

Rear Seal/Ext. Housing

1990 (THM200, 2004R)
 Seal9613S

Selector Shaft Seal/Man. Shaft

1996-1990
 Seal8792S

4-SPEED AUTOMATIC TRANSMISSION

Torque Converter

1996-1990 (4L60E, 4L60E, 4L60/MD8)
 Seal3227
 Repair SleeveKWK99174
 1990 (THM200 4R)
 Seal3227
 Repair SleeveKWK99174

4-SPEED AUTOMATIC TRANSMISSION

Rear Seal/Ext. Housing

1996-1990 (4L60E, 4L60E, 4L60/MD8)
 Seal9613S
 1990 (THM200 4R)
 Seal9613S

Selector Shaft Seal/Man. Shaft

1996-1990
 Seal8792S

ALTERNATOR

1991-1990
 Ball Bearing (Drive End)203FF
 Ball Bearing (Rear End)100CCAB

CRANKSHAFT FRONT SEAL

8 Cylinder

1996-1990 350/5.7L
 Seal9845
 Repair SleeveKWK99176
 1992-1991 305/5.0L
 Seal9845
 Repair SleeveKWK99176
 1990 307/5.0L
 Seal472082
 Repair SleeveKWK99199

CRANKSHAFT REAR SEAL

8 Cylinder

1996-1990 305/5.0L, 350/5.7L
 Seal Viton4359V
 Seal PTFE H/D5274
 Repair SleeveKWK99364
 1990 307/5.0L
 Seal Rope5095

¹⁹Opt. Axle Rpr Brg. Replaces O.E. Brg & Seal

Mfg./Year Model & Location Part No. Mfg./Year Model & Location Part No.

CADILLAC - REAR DRIVE - Catera

FRONT WHEEL

RWD

2001-1997
Hub Unit Bearing HA596467[2]

REAR WHEEL

RWD

2001-1997
Seal 6712NA[2]
Ball Bearing 510052[2]

4-SPEED AUTOMATIC TRANSMISSION

Torque Converter

2001-1997 (4L30E)
Seal 6712NA
Repair Sleeve KWK99187

Rear Seal/Ext. Housing

2001-1997 (4L30E)
Seal 3459S

Selector Shaft Seal/Man. Shaft

2001-1997 (4L30E)
Seal 8792S

ALTERNATOR

2001-1997
Ball Bearing (Drive End) 203FF
Ball Bearing (Rear End) 100CCAB

CAMSHAFT SEAL

6 Cylinder

2001-1997
Seal 714436

CRANKSHAFT FRONT SEAL

6 Cylinder

2001-1997
Seal 223750

CRANKSHAFT REAR SEAL

6 Cylinder

2001-1997 (DOHC)
Seal Viton 710237

CADILLAC - REAR DRIVE - CTS Sedan

FRONT WHEEL

RWD

2009-2008
Hub Unit Bearing HA590260[2]²⁵
2007-2004 CTS V
Hub Unit Bearing HA590077[2]
2007-2003 CTS
Hub Unit Bearing 513186[2]

AWD

2009-2008
Hub Unit Bearing HA590260[2]²⁵

REAR WHEEL

RWD

2008
Hub Unit Bearing HA590260[2]²⁵

REAR WHEEL (cont.)

RWD (cont.)

2007-2004 CTS V
Hub Unit Bearing HA590082[2]
2007-2003 CTS
Hub Unit Bearing 512223[2]

REAR AXLE

Pinion

2004
Cone/Cup (Inner) NP922169-NP233028[2]

5-SPEED AUTOMATIC TRANSMISSION

Selector Shaft Seal/Man. Shaft

2007-2003 (5L40E)
Seal 8792S

²⁵New Item, Check For Availability

Mfg./Year Model & Location Part No. Mfg./Year Model & Location Part No.

CADILLAC - REAR DRIVE - CTS Sedan (cont.)

6-SPEED MANUAL TRANSMISSION

Main Shaft

2006-2004
Cone/Cup (Frnt) LM12749-LM12711[2]

Front Countershaft

2006-2004
Cone/Cup (Frnt) LM48548-LM48510[2]
Bearing Assy (Rr) 32008XM[2]

Rear Countershaft

2006-2004
Cone/Cup LM12749-LM12711[2]

CAMSHAFT SEAL

6 Cylinder

2004-2003 3.2L/3175 DOHC
Seal 714436[2]

CRANKSHAFT FRONT SEAL

6 Cylinder

2004-2003 3.2L/3175 DOHC
Seal 223802

8 Cylinder

2007-2006 6.0L
Seal Viton 100470
2005-2004 346/5.7L
Seal Viton 100470

CRANKSHAFT REAR SEAL

6 Cylinder

2007-2005 2.8L/2792 DOHC
Seal Viton 710237
2004-2003 3.2L/3175 DOHC
Seal Viton 710237

CRANKSHAFT REAR SEAL

8 Cylinder

2007-2004 350 /5.7L, 364 /6.0L
Seal 100085

CADILLAC - REAR DRIVE - STS

FRONT WHEEL

RWD

2009-2006 STS V
Hub Unit Bearing HA590167[2]²⁵
2009-2005 STS (Exc. Performance Pkg)
Hub Unit Bearing 513186[2]
2009-2005 STS (Performance Pkg)(H/D)
Hub Unit Bearing HA590077[2]
2007-2005 STS (Performance Pkg)(Exc.
H/D)
Hub Unit Bearing HA590049[2]²⁵

AWD

2009-2005 STS (Exc. H/D)
Hub Unit Bearing HA590049[2]²⁵
2009-2005 STS (H/D)
Hub Unit Bearing HA590077[2]

REAR WHEEL

RWD

2009-2005 STS (Exc. H/D)
Hub Unit Bearing 512223[2]
2009-2005 STS (H/D)
Hub Unit Bearing HA590079[2]

5-SPEED AUTOMATIC TRANSMISSION

Selector Shaft Seal/Man. Shaft

2008-2005 (5L40E)
Seal 8792S

²⁵New Item, Check For Availability

Mfg./Year Model & Location Part No. Mfg./Year Model & Location Part No.

CADILLAC - REAR DRIVE - STS (cont.)

6- SPEED AUTOMATIC TRANSMISSION

Rear Seal/Ext. Housing

2009-2006 (6L80)
Seal 710533

6-SPEED AUTOMATIC TRANSMISSION

Selector Shaft Seal/Man. Shaft

2008-2006 (6L80)
Seal 8792S

6-SPEED MANUAL TRANSMISSION

Main Shaft

2006
Cone/Cup (Frnt) LM12749-LM12711[2]

Front Countershaft

2006
Cone/Cup (Frnt) LM48548-LM48510[2]
Bearing Assy (Rr) 32008XM[2]

Rear Countershaft

2006
Cone/Cup LM12749-LM12711[2]

CRANKSHAFT REAR SEAL

8 Cylinder

2008-2005 4.4L , 4.6L
Seal Viton 710262

CADILLAC - REAR DRIVE - XLR

FRONT WHEEL

RWD

2008-2004
Hub Unit Bearing 513139[2]

REAR WHEEL

RWD

2008-2004
Hub Unit Bearing 512153[2]

REAR AXLE

Differential

2006-2004
Cone/Cup 387A-382A[2]

5-SPEED AUTOMATIC TRANSMISSION

Selector Shaft Seal/Man. Shaft

2008-2004 (5L50E)
Seal 8792S

6- SPEED AUTOMATIC TRANSMISSION

Rear Seal/Ext. Housing

2009-2006 (6L80)
Seal 710533

6-SPEED AUTOMATIC TRANSMISSION

Selector Shaft Seal/Man. Shaft

2008-2006 (6L80)
Seal 8792S

CRANKSHAFT REAR SEAL

8 Cylinder

2008-2004 4.4L , 4.6L
Seal Viton 710262

CADILLAC - SUV, Truck - Escalade, Escalade ESV, Escalade EXT

FRONT WHEEL

RWD

2009-2007	
Hub Unit Bearing	SP450303[2] ²⁵
2006	
Hub Unit Bearing	SP500300[2] ²⁵
2005-2002	
Hub Unit Bearing	SP550305[2] ⁸³
Hub Unit Bearing	SP450301[2] ⁸⁴
2000-1999	
Hub Unit Bearing	SP550300[2] ⁹⁶
Hub Unit Bearing	SP550307[2] ⁸⁵

4WD

2002	
Hub Unit Bearing	SP500300[2] ²⁵
2000-1999	
Hub Unit Bearing (RH)	SP550300[2] ⁹⁶
Hub Unit Bearing (RH)	SP550307[2] ⁸⁵
Hub Unit Bearing (LH)	SP550301[2] ⁹⁶
Hub Unit Bearing (LH)	SP550307[2] ⁸⁵
Sensor Kit (RH)	SK550300[2] ³⁹
Sensor Kit (LH)	SK550301[2] ³⁹

AWD

2009-2007	
Hub Unit Bearing	SP500301[2] ²⁵
2006	
Hub Unit Bearing	SP500300[2] ²⁵
Hub Unit Bearing	SP550307[2] ⁸⁵
2005-2002	
Hub Unit Bearing	SP500300[2] ²⁵

REAR WHEEL

RWD

2009-1999	
Seal	4762N[2]
Cylindrical Bearing	513067[2]
Bearing & Seal Kit	TRP59047[2] ¹⁹

4WD

2002-1999	
Seal	4762N
Cylindrical Bearing	513067[2]
Bearing & Seal Kit	TRP59047[2] ¹⁹

AWD

2009-2002	
Seal	4762N
Cylindrical Bearing	513067[2]
Bearing & Seal Kit	TRP59047[2] ¹⁹

4WD FRONT AXLE

Axle Shaft

2002-1999	(8.25" R.G.)
Ndle Bearing (Inner)	B2010[2]
Ndle Bearing (Outer)	SCH208[2]
Ndle Bearing	SCH78[2]

4WD FRONT AXLE

Differential

2006-2002	(Under 7500 GVW)
Cone/Cup	LM501349-LM501314[2]
2000-1999	(Over 7500 GVW)
Set	SET42[2]

Pinion

2008-2003	
Seal	710536
Cone/Cup (Inner)	NP544520-NP099285
Cone/Cup (Outer)	M88048-M88010
2002-1999	
Seal	710536
Cone/Cup (Inner)	NP457992-NP926068
Cone/Cup (Outer)	M88048-M88010

REAR AXLE

Differential Rebuild Kit

2007-2002	(8.625" R.G.)
Kit	DRK321C
2006-2002	(9.5" R.G.)
Kit	DRK324B
2000-1999	(8.625" RG)
Kit	DRK321C

Differential

2006-2002	(8.625" R.G.)
Set	SET36[2]
2006-2002	(9.5" R.G.)
Set	SET42[2]
2000	(2nd Design)
Set	SET36[2]
2000-1999	(1st Design)
Cone/Cup	LM501349-LM501314[2]

Pinion

2008-2002	(8.625" R.G.)
Seal	710506
Cone/Cup (Inner)	NP544520-NP099285
Cone/Cup (Outer)	M88048-M88010
2006-2002	(9.5" R.G.)
Seal	710507
Cone/Cup (Inner)	HM804846-HM804810
Cone/Cup (Outer)	HM88649-HM88610
2000-1999	(8.625" R.G.)
Seal	710506
Cone/Cup (Inner)	NP457992-NP926068
Cone/Cup (Outer)	M88048-M88010

TRANSFER CASE REBUILD KIT

2000-1999	(New Process 243)
Kit	TCRK241D[2] ¹⁶

¹⁶Obsolete ¹⁹Opt. Axle Rpr Brg. Replaces O.E. Brg & Seal ²⁵New Item, Check For Availability
³⁹Opt. Kit = Cable, Screw, Grease. ⁸³Deplete Inventory ⁸⁴Reorder ⁸⁵6
⁵² Stud ~ Reorder ~ SP550307 Will Service Both Sides. ⁹⁶6 Stud ~ Deplete Inventory.

Mfg./Year	Model & Location	Part No.	Mfg./Year	Model & Location	Part No.
CADILLAC - SUV, Truck - Escalade, Escalade ESV, Escalade EXT (cont.)					

TRANSFER CASE**Input Shaft**

2008-2003	(Borg Warner)	
Ndle Bearing (Pilot)	BK3026
Ball Bearing	211TB
Ball Bearing	109TB[2]
2002-1999	(New Process 149)	
Ndle Bearing (Rr)	B5020[2]
Ball Bearing (Rr)	N5210KLB
Ball Bearing (Frt)	110CB
Seal	472636
2000-1999	(New Process 243)	
Seal (O.E.)	3173
Ball Bearing	110L
Seal (Opt)	710928
Repair Sleeve	KWK99193
Ndle Bearing (Pilot)	FC66561

Front Output Shaft

2008-2003	(Borg Warner)	
Ball Bearing	109TB[2]
Ball Bearing	211TB
2002-1999	(New Process 149)	
Seal	710495 ²⁵
Ball Bearing	110CB
2000-1999	(New Process 243)	
Seal	3946
Ball Bearing	207
Repair Sleeve	KWK99187
Ndle Bearing (Pilot)	J2416

Rear Output Shaft

2008-2003	(Borg Warner)	
Seal	4503N
Ball Bearing	209LO
2002-1999	(New Process 149)	
Seal	710496
Ndle Bearing (Pilot)	B5020[2]
Ball Bearing	N5210KLB
2000-1999	(New Process 243)	
Seal	4333N
Ball Bearing	207
Ndle Bearing (Pilot)	B5020

Oil Pump Housing

2000-1999	(New Process 243)	
Seal	341022
Repair Sleeve	KWK99225

4-SPEED AUTOMATIC TRANSMISSION**Torque Converter**

2006-1999	(4L60, 4L60E, 4L65E)	
Seal	3227
Repair Sleeve	KWK99174
2002-1999	(4L80E)	
Seal	4598
Repair Sleeve	KWK99199

4-SPEED AUTOMATIC TRANSMISSION**Rear Seal/Ext. Housing**

2006-2002	(4L60E, 4L80E)	
Seal	4934
Seal Kit	5200 ⁶⁴
2002-1999	(4L80E)(Booted)	
Seal	4333N
2002-1999	(4L80E)(Exc. Booted)	
Seal	9449
Seal Kit	5208 ⁶⁴
2000-1999	(4L60E, 4L80E)	
Seal	4934

Selector Shaft Seal/Man. Shaft

2008-1999	
Seal8792S

Output Shaft

2009-2007	(6L80)	
Seal	710533
2006-1999	(4L80E)	
Seal	4934

A/C COMPRESSOR

2002-1999	(Frigidaire R4)	
Ball Bearing (Frt Head)	S128[2]
2002-1999	(Frigidaire R4)	
Ball Bearing	907257[2]

ALTERNATOR

2000-1999		
Ball Bearing (Rear End)	100CCAB

POWER STEERING**Pump Shaft**

2002-1999		
Seal	7013S

CRANKSHAFT FRONT SEAL**8 Cylinder**

2009-2007	6.2L Gas	
Seal Viton	100470
Repair Sleeve	KWK99210
2006-2002	325/5.3L, 364/6.0L	
Seal Viton	100470
2000-1999	350/5.7L	
Seal	9845
Repair Sleeve	KWK99176

CRANKSHAFT REAR SEAL**8 Cylinder**

2009-2007		
Seal Viton	4359V
2009-2002	325/5.3L, 364/6.0L	
Seal	100085
2000-1999	350/5.7L	
Seal Viton	4359V

²⁵New Item, Check For Availability⁶⁴Seal & Bushing Kit

Mfg./Year Model & Location Part No. Mfg./Year Model & Location Part No.

CADILLAC - SUV, Truck - SRX

FRONT WHEEL

RWD

2009-2004
Hub Unit Bearing HA590077[2]

AWD

2009-2004
Hub Unit Bearing HA590078[2]

REAR WHEEL

RWD

2009-2004
Hub Unit Bearing HA590079[2]

AWD

2009-2004
Hub Unit Bearing HA590079[2]

TRANSFER CASE

Input Shaft

2005-2004
Ball Bearing 110CB

Front Output Shaft

2009-2004
Seal 714503
Ball Bearing (Frt) 109TB
Ball Bearing (Rr) 206WB

Rear Output Shaft

2005-2004 (Borg Warner)
Seal 4503N

5-SPEED AUTOMATIC TRANSMISSION

Selector Shaft Seal/Man. Shaft

2008-2004 (5L40E)
Seal 8792S

CRANKSHAFT REAR SEAL

8 Cylinder

2009-2004 4.6L (DOHC)
Seal Viton 710262

CHEVROLET - FRONT DRIVE - Aveo, Aveo5

FRONT WHEEL

FWD

2008-2004
Set SET35[2]

REAR WHEEL

FWD

2008-2004
Ball Bearing WB000022[2]²⁵

CRANKSHAFT FRONT SEAL

4 Cylinder

2009-2004 1.6 L
Seal 223606

CRANKSHAFT REAR SEAL

4 Cylinder

2009-2004 1.6L
Seal Viton 228008

²⁵New Item, Check For Availability

Mfg./Year Model & Location Part No. Mfg./Year Model & Location Part No.

CHEVROLET - FRONT DRIVE - Beretta, Cavalier, Corsica**FRONT WHEEL****FWD**

2005-1997	
Hub Unit Bearing	513017K[2] ⁶¹
1996-1990	
Hub Unit Bearing	513017K[2] ⁶¹
Seal Kit	5697[2] ¹²

REAR WHEEL**FWD**

2005-2004 (ABS)	
Hub Unit Bearing	512001[2]
2005-2004 (Non-ABS)	
Hub Unit Bearing	513012[2]
2003-1992	
Hub Unit Bearing	512001[2]
1991-1990	
Hub Unit Bearing	513012[2]

CLUTCH - 4 CYLINDER**Release Bearing**

2001-1995	
Hyd. Bearing Assy	619006
1994-1993 138/2.3L	
Hyd. Bearing Assy	619005
1994-1990 (Isuzu)	
Bearing Assy	614108
1992-1990 (Muncie)	
Bearing Assy	614069

CLUTCH - 6 CYLINDER**Release Bearing**

1996-1993 189/3.1L	
Hyd. Bearing Assy	619005
1992-1990 (Muncie)	
Bearing Assy	614069

3-SPEED AUTOMATIC TRANSAXLE**Torque Converter**

2002-1990 (THM125C)	
Seal	4072N
Repair Sleeve	KWK99172

Output Shaft

2000-1990	
Seal (LH)	3543[2]
Repair Sleeve (LH)	KWK99139
Seal Kit (LH)	5690 ¹⁸
Seal (RH)	3543
Repair Sleeve (RH)	KWK99139
Seal Kit (RH)	5690 ¹⁸

Manual Shaft

2002-1990	
Seal	8792S

4-SPEED AUTOMATIC TRANSAXLE**Differential**

2005-2000 Cavalier	
Cone/Cup	LM501349-LM501310[2]

Torque Converter / Frt Pump

2005-1994 (4T40E, 4T45E, 4T60E)	
Seal	4072N
Repair Sleeve	KWK99172

Output Shaft

2005-1995 (4T40E)	
Seal	SL260001[2] ²⁵
1996-1994 (4T60E)	
Seal (LH)	710096
Repair Sleeve (RH)	KWK99139
Seal (RH)	3543
Repair Sleeve (RH)	KWK99139

Manual Shaft

2005-1994	
Seal	8792S

4-SPEED MANUAL TRANSAXLE**Output Shaft**

2003-2000	
Seal (LH)	100165
Seal (RH)	3543

5-SPEED MANUAL TRANSAXLE**Differential**

2005-2000 (Opel)	
Set	SET45
Cone/Cup	LM501349-LM501310 ⁵⁵
1999-1990 (Isuzu)	
Bearing Assy	32008XM[2]
1994-1990 (Exc. Isuzu)	
Set	SET11[2]

Input Shaft

2005-2000 (Opel)	
Seal	222835
Repair Sleeve	KWK99111
1999-1995 (Isuzu)	
Seal (Frt)	222835
Ball Bearing (Frt)	306VVL[2]
Repair Sleeve	KWK99111
1994-1990 (Isuzu)	
Seal (Frt)	222835
Bearing Assy (Frt)	32206M[2]
Repair Sleeve	KWK99111
Bearing Assy (Rr)	30306M[2]
1992-1990 (Exc. Isuzu)	
Ball Bearing (Frt)	305DD[2]

¹²Opt = Seal & O-Ring. Incl w/ Hub Unit. ¹⁸Opt. = Brg, Slv, Hardware, Hsg. ²⁵New Item,
 Check For Availability ⁵⁵Opt. Set Components ⁶¹Kit = Seal, Hub Nut, & Brg Unit

Mfg./Year Model & Location Part No. Mfg./Year Model & Location Part No.

CHEVROLET - FRONT DRIVE - Beretta, Cavalier, Corsica (cont.)

5-SPEED MANUAL TRANSAXLE

Output Shaft

2005-2000	
Seal	3543
Repair Sleeve	KWK99138
Ball Bearing	306VV/L
1999-1990	
Seal (LH)	3543
Set (LH)	SET5[2]
Repair Sleeve (LH)	KWK99139
Seal (RH)	3543
Bearing Assy (RH)	32206M[2]
Repair Sleeve (RH)	KWK99139

Selector Shaft Seal/Man. Shaft

1999-1990 (Isuzu)	
Seal	710243
Repair Sleeve	KWK99058

ALTERNATOR

1990	
Ball Bearing (Drive End)	203FF
1990	
Ball Bearing (Rear End)	MNJ471S

POWER STEERING

Pump Shaft

2002-1992	
Seal	7013S
1991-1990	
Seal	221925

CAMSHAFT SEAL

4 Cylinder

2002-1996 146/2.4L	
Seal Viton	713771
Repair Sleeve	KWK99139
1995-1990 138/2.3L (DOHC)	
Seal Viton	713771
Repair Sleeve	KWK99139

CRANKSHAFT FRONT SEAL

4 Cylinder

2002-1996 2.4L (DOHC)	
Seal Viton	320259
Repair Sleeve	KWK99199
2002-1992 2.2L (OHV)	
Seal	9845
Repair Sleeve	KWK99176
Harmnc Balancer Slvs	88176
1995-1990 2.3L (DOHC)	
Seal Viton	320259
Repair Sleeve	KWK99199

6 Cylinder

1996-1990 189/3.1L	
Seal	9845
Repair Sleeve	KWK99176
Harmnc Balancer Slvs	88176

CRANKSHAFT REAR SEAL

4 Cylinder

2005-2002 134/2.2L (DOHC)	
Seal Viton	710237
2002-1996 2.4L (DOHC)	
Seal	40375
2002-1990 134/2.2L (OHV)	
Seal	4307V
Seal PTFE H/D	5273
Repair Sleeve	KWK99298
1995-1990 138/2.3L (DOHC)	
Seal	40375

6 Cylinder

1996-1990 189/3.1L	
Seal	4307V
Seal PTFE H/D	5273
Repair Sleeve	KWK99298

CHEVROLET - FRONT DRIVE - Celebrity**FRONT WHEEL****FWD**

1990	(JA2, JA3, JA8, Brks.)	
Hub Unit Bearing	513016K[2] ⁶¹
Seal Kit	5698[2] ¹²

REAR WHEEL**FWD**

1990		
Hub Unit Bearing	513018[2]

CLUTCH**Release Bearing**

1990	(Muncie)	
Bearing Assy	614069
1990	(Isuzu)	
Bearing Assy	614108

3-SPEED AUTOMATIC TRANSAXLE**Torque Converter**

1990		
Seal	4072N

Output Shaft

1990	(THM125)	
Seal	3543[2]
Repair Sleeve	KWK99139[2]

Manual Shaft

1990	(THM125)	
Seal	8792S
Repair Sleeve	KWK99049

4-SPEED AUTOMATIC TRANSAXLE**Torque Converter / Frt Pump**

1990		
Seal	4072N

Output Shaft

1990		
Seal (LH)	710096
Repair Sleeve (LH)	KWK99139
Seal (RH)	3543
Repair Sleeve (RH)	KWK99139

Manual Shaft

1990		
Seal	8792S
Repair Sleeve	KWK99049

ALTERNATOR

1990		
Ball Bearing (Drive End)	203FF
1990		
Ball Bearing (Rear End)	100CCAB

CRANKSHAFT FRONT SEAL**4 Cylinder**

1990	151/2.5L	
Seal	9845
Repair Sleeve	KWK99176

6 Cylinder

1990	189/3.1L	
Seal	9845
Repair Sleeve	KWK99176
Harmnc Balancer Slvs	88176

CRANKSHAFT REAR SEAL**4 Cylinder**

1990	151/2.5L	
Seal	3698

6 Cylinder

1990	191/3.1L	
Seal	4307V
Seal PTFE H/D	5273
Repair Sleeve	KWK99298

¹²Opt = Seal & O-Ring. Incl w/ Hub Unit.⁶¹Kit = Seal, Hub Nut, & Brg Unit

Mfg./Year Model & Location Part No. Mfg./Year Model & Location Part No.

CHEVROLET - FRONT DRIVE - Cobalt, Optra

FRONT WHEEL

FWD

2009-2005 (ABS)(Non-Sport Suspension)
 Hub Unit BearingHA590068[2]
 2009-2005 (Non-ABS)(Non-Sport
 Suspension)
 Hub Unit BearingHA590069[2]
 2009-2005 (Sport Suspension)
 Hub Unit BearingHA590086[2]

REAR WHEEL

FWD

2009-2005 (ABS)(Drum)
 Hub Unit BearingHA590066[2]
 2009-2005 (Disc)
 Hub Unit BearingHA590088[2]
 2009-2005 (Non-ABS)(Drum)
 Hub Unit BearingHA590067[2]

4-SPEED AUTOMATIC TRANSAXLE

Torque Converter / Frt Pump

2008-2005 (4T45E)
 Seal4072N
 Repair SleeveKWK99172

Output Shaft

2007-2005 (4T45E)
 SealSL260001[2]²⁵

Manual Shaft

2008-2005
 Seal8792S

CRANKSHAFT FRONT SEAL

4 Cylinder

2006-2005 2.0L (DOHC)
 Seal9845
 Repair SleeveKWK99176
 2006-2005 2.2L (DOHC)
 Seal9845
 Repair SleeveKWK99176

CRANKSHAFT REAR SEAL

4 Cylinder

2009-2005 2.0L (DOHC)
 Seal Viton710237
 2009-2005 2.2L, 2.4L
 Seal Viton710237

CHEVROLET - FRONT DRIVE - Impala, Lumina, Monte Carlo

FRONT WHEEL

FWD

2009-2006 (ABS)
 Hub Unit BearingHA590093[2]⁴⁰
 2009-2006 (Non-ABS)
 Hub Unit BearingHA590085[2]⁸⁴
 2005-2002 Impala, Monte Carlo (ABS)
 Hub Unit Bearing513179[2]⁷³
 2005-2000 Impala, Monte Carlo (Non-ABS)
 Hub Unit Bearing513160[2]⁸³
 Hub Unit BearingHA590085[2]⁸⁴
 2001-2000 Impala, Monte Carlo (ABS)
 Hub Unit Bearing513121[2]⁷²
 2001-1990 Lumina
 Hub Unit Bearing
 (ABS, Non-ABS)513044[2]
 1999-1995 Monte Carlo
 Hub Unit Bearing
 (ABS, Non-ABS)513044[2]

REAR WHEEL

FWD

2009-2006 (ABS)
 Hub Unit BearingHA590092[2]
 2007-2006 (Non-ABS)
 Hub Unit BearingHA590074[2]
 2005-2000 Impala, Monte Carlo (ABS)
 Hub Unit Bearing512237[2]⁸⁴
 2005-2000 Impala, Monte Carlo (Non-ABS)
 Hub Unit Bearing512221[2]
 2002-2000 Impala (Drum Brks.)
 Hub Unit Bearing513018[2]
 2001-2000 Lumina (ABS)
 Hub Unit Bearing512151[2]
 2001-2000 Lumina (Non-ABS)
 Hub Unit Bearing513018[2]
 1999-1997 (ABS)
 Hub Unit Bearing512151[2]
 1999-1990 (Non-ABS)
 Hub Unit Bearing513018[2]
 1996-1992 (ABS)
 Hub Unit Bearing512004[2]

²⁵New Item, Check For Availability ⁴⁰5 Stud. ⁷²Steel Wire Clip. Brg Flg Mtg Holes Threaded.

⁷³Plastic Wire Clip. ⁸³Deplete Inventory ⁸⁴Reorder

CHEVROLET - FRONT DRIVE - Impala, Lumina, Monte Carlo (cont.)**3-SPEED AUTOMATIC TRANSAXLE****Torque Converter**

1993-1990	
Seal	4072N[2]
Repair Sleeve	KWK99062

Output Shaft

1993-1990	
Seal	3543[2]
Repair Sleeve	KWK99139[2]

Manual Shaft

1993-1990	
Seal	8792S

4-SPEED AUTOMATIC TRANSAXLE**Torque Converter / Frt Pump**

2008-1990 (4T60E, 4T65E)	
Seal	4072N
Repair Sleeve	KWK99172

Output Shaft

2008-1997 (4T65 E)	
Seal (LH) (Yellow)	100165
Repair Sleeve (LH)	KWK99139
Seal (RH) (Green)	3543
Repair Sleeve (RH)	KWK99139
1999-1990 (4T60E)	
Seal (LH)	710096
Repair Sleeve (LH)	KWK99139
Seal (RH)	3543
Repair Sleeve (RH)	KWK99139

Manual Shaft

2008-1990	
Seal	8792S

5-SPEED MANUAL TRANSAXLE**Differential**

1992-1991	
Set	SET11[2]

Input Shaft

2003-2000	
Seal	222835
Repair Sleeve	KWK99111
1992-1991	
Ball Bearing	305DD[2]

5-SPEED MANUAL TRANSAXLE**Output Shaft**

1992-1991	
Seal (LH)	2003N[2]
Set (LH)	SET5[2]
Repair Sleeve (LH)	KWK99146
Seal (RH)	2003N[2]
Cone/Cup (RH)	LM503349A-LM503310[2]
Repair Sleeve (RH)	KWK99146

Selector Shaft Seal/Man. Shaft

1992-1991	
Seal	3667[2]

A/C COMPRESSOR

2002-1990 (Harrison V5)	
Ball Bearing	907257[2]

ALTERNATOR

1998	
Ball Bearing (Rear End)	100CCAB
1992-1991	
Ball Bearing (Drive End)	203FF

POWER STEERING**Pump Shaft**

2002-1992	
Seal	7013S
1991-1990	
Ball Bearing	203FF[2]

CAMSHAFT SEAL**6 Cylinder**

1997-1991 201/3.4L (DOHC)	
Seal Viton	474241V
Repair Sleeve	KWK99166

CRANKSHAFT FRONT SEAL**4 Cylinder**

1993 134/2.2L	
Seal	9845
Repair Sleeve	KWK99176
Harmnc Balancer Slvs	88176
1992-1990 151/2.5L	
Seal	9845
Repair Sleeve	KWK99176
Harmnc Balancer Slvs	88176

6 Cylinder

2009-2006 3.5L	
Seal	9845
Repair Sleeve	KWK99176
Harmnc Balancer Slvs	88176
2006 3.9L	
Seal	9845
Repair Sleeve	KWK99176
Harmnc Balancer Slvs	88176

Mfg./Year Model & Location Part No. Mfg./Year Model & Location Part No.

CHEVROLET - FRONT DRIVE - Impala, Lumina, Monte Carlo (cont.)

CRANKSHAFT FRONT SEAL (cont.)

6 Cylinder (cont.)

2005-2000	201/3.4L OHV	
Seal	9845
Repair Sleeve	KWK99176
Harmnc Balancer Slvs	88176
2005-1998	3800/3.8L	
Seal Viton	710162
Repair Sleeve	KWK99193
2001-1990	191/3.1L	
Seal	9845
Repair Sleeve	KWK99176
Harmnc Balancer Slvs	88176
1997-1991	201/3.4L (DOHC)	
Seal	9845
Repair Sleeve	KWK99176
Harmnc Balancer Slvs	88176

8 Cylinder

2009-2006	5.3L	
Seal Viton	100470

CRANKSHAFT REAR SEAL

4 Cylinder

1993	134/2.2L	
Seal	4307V
Seal PTFE H/D	5273
Repair Sleeve	KWK99298
1992-1990	151/2.5L	
Seal	3698

6 Cylinder

2009-2006	3.5L	
Seal	4307V
Seal PTFE H/D	5273
Repair Sleeve	KWK99298
2009-2006	3.9L	
Seal	4307V
Seal PTFE H/D	5273
Repair Sleeve	KWK99298
2005-2000	201/3.4L OHV	
Seal	4307V
Seal PTFE H/D	5273
Repair Sleeve	KWK99298

CRANKSHAFT REAR SEAL (cont.)

6 Cylinder (cont.)

2005-1998	3.8L	
Seal Viton	320691
Repair Sleeve	KWK99328
2001-1990	191/3.1L	
Seal	4307V
Seal PTFE H/D	5273
Repair Sleeve	KWK99298
1997-1991	201/3.4L (DOHC)	
Seal	4307V
Seal PTFE H/D	5273
Repair Sleeve	KWK99298

8 Cylinder

2009-2006	5.3L	
Seal	100085

CHEVROLET - FRONT DRIVE - Malibu, Fleet Classic (Fleet Vehicle)

FRONT WHEEL

FWD

2009-2004	Malibu	
Hub Unit Bearing		
(ABS)	HA590070[2]
Hub Unit Bearing		
(Non-ABS)	HA590071[2]
2005-2004	Classic	
Hub Unit Bearing		
(ABS)	513137[2]
2003-1997		
Hub Unit Bearing		
(ABS)	513137[2]
Hub Unit Bearing		

(Non-ABS)	513160[2] ⁸³
Hub Unit Bearing		
(Non-ABS)	HA590085[2] ⁸⁴

REAR WHEEL

FWD

2009-2008		
Hub Unit Bearing	HA590080[2]
2007-2004	(Disc ~ Rear Wheel)	
Hub Unit Bearing	HA590080[2]
2007-2004	(Drum ~ Rear Wheel)	
Hub Unit Bearing		
(ABS)	HA590080[2]
Hub Unit Bearing		
(Non-ABS)	HA590081[2]

⁸³Deplete Inventory ⁸⁴Reorder

Mfg./Year Model & Location Part No. Mfg./Year Model & Location Part No.

CHEVROLET - FRONT DRIVE - Malibu, Fleet Classic (Fleet Vehicle) (cont.)**REAR WHEEL (cont.)****FWD (cont.)**

2005-2002 (N Body Code)	
Hub Unit Bearing	512152[2]
2001-1997	
Hub Unit Bearing	512003[2]

4-SPEED AUTOMATIC TRANSAXLE**Torque Converter / Frt Pump**

2008-1997 (4T40E, 4T45E, 4T65E)	
Seal	4072N
Repair Sleeve	KWK99172

Output Shaft

2008-2006 (4T65 E)	
Seal (LH) (Yellow)	100165
Repair Sleeve (LH)	KWK99139
Seal (RH) (Green)	3543
Repair Sleeve (RH)	KWK99139
2006-1997 (4T40E, 4T45E)	
Seal	SL260001[2] ²⁵

Manual Shaft

2008-1997	
Seal	8792S
Repair Sleeve	KWK99049

A/C COMPRESSOR

2002-1997 (Harrison V5)	
Ball Bearing	907257[2]

POWER STEERING**Pump Shaft**

2002-1997	
Seal	7013S

CRANKSHAFT FRONT SEAL**4 Cylinder**

1999-1997 146/2.4L	
Seal Viton	320259
Repair Sleeve	KWK99199

6 Cylinder

2008-2004 213/3.5L	
Seal	9845
Repair Sleeve	KWK99176
Harmnc Balancer Slvs	88176
2007-2006 237/3.9L	
Seal	9845
Repair Sleeve	KWK99176
Harmnc Balancer Slvs	88176
2003-1997 191/3.1L	
Seal	9845
Repair Sleeve	KWK99176
Harmnc Balancer Slvs	88176

CRANKSHAFT REAR SEAL**4 Cylinder**

2009-2004 2.2L, 2.4L	
Seal Viton	710237
1999-1997 146/2.4L	
Seal	40375

6 Cylinder

2008-2004 213/3.5L	
Seal	4307V
Seal PTFE H/D	5273
Repair Sleeve	KWK99298
2006 237/3.9L	
Seal	4307V
Seal PTFE H/D	5273
Repair Sleeve	KWK99298
2003-1997 191/3.1L	
Seal	4307V
Seal PTFE H/D	5273
Repair Sleeve	KWK99298

²⁵New Item, Check For Availability

Mfg./Year Model & Location Part No. Mfg./Year Model & Location Part No.

CHEVROLET - REAR DRIVE - Caprice

FRONT WHEEL

RWD

1993-1990
 Seal (Inner)8871[2]
 Set (Inner) SET6[2]
 Set (Outer) SET3[2]

REAR WHEEL

RWD

1993-1990 (Chevrolet C Axle)(7.5", 7.75",
 8.5" R.G.)
 Seal8660S[2]
 Cylindrical Bearing 5707[2]
 Bearing & Seal Kit TRP1563TAV[2]¹⁹
 1993-1990 (Police, Taxi)(Wagons)(Pontiac P
 Axle)(Limited Slip
 Differential)(8.5", 8.75",
 8.875" R.G.)
 Seal8835S[2]
 Cylindrical Bearing6408[2]
 Bearing & Seal Kit TRP1559TV[2]¹⁹

REAR AXLE

Differential Rebuild Kit

1993-1990 (7.5" R.G., 7.625" R.G.)
 KitDRK320

Differential

1993-1990 (7.5" R.G., 7.625" R.G.)
 Cone/Cup LM501349-LM501314[2]

Pinion

1993-1990 (7.5" R.G., 7.625" R.G.)
 Seal8610
 Cone/Cup (Inner)HM89249-HM89210
 Cone/Cup (Outer) M86649-M86610
 1993-1990 (8.5", 8.75", 8.875" R.G.)
 Seal2043
 Cone/Cup (Inner) M802048-M802011
 Cone/Cup (Outer) M88048-M88010

3-SPEED AUTOMATIC TRANSMISSION

Torque Converter

1991-1990 (THM200)
 Seal3227[2]
 Repair SleeveKWK99174
 1990 (HM3L80)
 Seal 6712NA[2]

Rear Seal/Ext. Housing

1991-1990 (THM200, 350)
 Seal9613S[2]
 Seal Kit5200⁶⁴
 Repair SleeveKWK99149

3-SPEED AUTOMATIC TRANSMISSION

Selector Shaft Seal/Man. Shaft

1991-1990 (THM200)
 Seal8792S[2]

4-SPEED AUTOMATIC TRANSMISSION

Torque Converter

1993-1990 (4L60, 4L60E, 4L65E)
 Seal3227[2]
 1993-1990 (THM700 R4)
 Seal3227[2]

Rear Seal/Ext. Housing

1993-1990 (4L60, 4L60E, 4L65E)
 Seal9613S[2]
 1993-1990 (THM700 R4)
 Seal9613S[2]

Selector Shaft Seal/Man. Shaft

1993-1990 (4L60, 4L60E, 4L65E)
 Seal8792S[2]
 1993-1990 (THM700 R4)
 Seal8792S[2]

ALTERNATOR

1993-1990 (Delco 120, 124 Amp.)
 Ball Bearing (Drive End)203FF
 Ball Bearing (Rear End)100CCAB

CRANKSHAFT FRONT SEAL

6 Cylinder

1993-1990 262/4.3L
 Seal9845
 Repair SleeveKWK99176

8 Cylinder

1993-1990 350/5.7L
 Seal9845
 Repair SleeveKWK99176
 1993-1990 305/5.0L
 Seal9845
 Repair SleeveKWK99176
 1990 307/5.0L
 Seal Viton320259
 Repair SleeveKWK99199

CRANKSHAFT REAR SEAL

6 Cylinder

1993-1990 262/4.3L
 Seal Viton4359V
 Seal PTFE H/D5274
 Repair SleeveKWK99364

8 Cylinder

1993-1990 305/5.0L
 Seal5092
 1993-1990 350/5.7L code (L), (V)
 Seal5092

¹⁹Opt. Axle Rpr Brg. Replaces O.E. Brg & Seal

⁶⁴Seal & Bushing Kit

Mfg./Year Model & Location Part No. Mfg./Year Model & Location Part No.

CHEVROLET - REAR DRIVE - Caprice (cont.)**CRANKSHAFT REAR SEAL (cont.)****8 Cylinder (cont.)**

1990 307/5.0L
Seal5092

CHEVROLET - REAR DRIVE - Camaro, IROC, Z-28**FRONT WHEEL****RWD**

2002-1993
Hub Unit Bearing 513090[2]
1992-1990 (Exc. IROC, Z28)
Seal (Inner)8871[2]
Set (Inner) SET6[2]
Set (Outer) SET34[2]
1992-1990 (IROC, Z28)
Seal (Inner)8871[2]
Set (Inner) SET6[2]
Set (Outer) SET3[2]

REAR WHEEL**RWD**

2002-1991 (7.5" R.G., 7.625" R.G.)
Seal8660S[2]
Cylindrical Bearing 5707[2]
Bearing & Seal Kit TRP1563TAV[2]⁹³
1990 (7.75" R.G.)
Seal (LH) 224255[2]
Set (LH) SET9[2]
Seal (RH) 710179[2]
Set (RH) SET9[2]
1990 (Exc. 7.75" R.G.)
Seal8660S[2]
Cylindrical Bearing 5707[2]
Bearing & Seal Kit TRP1563TAV[2]⁹³₁₉

REAR AXLE**Differential Rebuild Kit**

2002-1999 (10 Bolt Hsg. Cover)(7.5" ,
7.625" R.G.)
Kit DRK320C
1998-1990 (10 Bolt Hsg. Cover)(7.5" ,
7.625" R.G.)
KitDRK320
1993-1990 (7.75" R.G.)
KitDRK326

Differential

2002-1990 (7.5" , 7.625" , 8.5" R.G.)
Cone/Cup LM501349-LM501314[2]
1990 (7.75" R.G.)
Cone/Cup LM102949-LM102911[2]

REAR AXLE**Pinion**

2002-1999 (7.5" R.G., 7.625" R.G.)
Seal8610
Seal (2nd Design) 710474²⁵
Cone/Cup (Inner)HM89249-HM89210
Cone/Cup (Outer) M86649-M86610
1998-1990 (7.5" R.G., 7.625" R.G.)
Seal8610
Cone/Cup (Inner)HM89249-HM89210
Cone/Cup (Outer) M86649-M86610
1990 (7.75" R.G.)
Seal7457N
Cone/Cup (Inner)HM89446-HM89410
Cone/Cup (Outer) M86649-M86610

3-SPEED AUTOMATIC TRANSMISSION**Selector Shaft Seal/Man. Shaft**

1992-1990
Seal8792S[2]

4-SPEED AUTOMATIC TRANSMISSION**Torque Converter**

2002-1990 (THM700)(4L60 E)
Seal3227[2]
Repair SleeveKWK99174

Rear Seal/Ext. Housing

2002-1990 (THM700)(4L60 E)
Seal9613S[2]
Seal Kit5200⁶⁴

Selector Shaft Seal/Man. Shaft

2002-1990
Seal8792S

CLUTCH**Pilot Bearing**

2002-1993 (8 Cyl.)
Ball Bearing 57080
2002-1990 (6 Cyl.)
Bushing H/D PB652HD
1992 8 Cyl. 5.0L LB9
Ball Bearing 57080
1992 8 Cyl. Exc. 5.0L LB9
Bushing H/D PB656HD
1991-1990 (8 Cyl.)
Bushing H/D PB656HD

¹⁹Opt. Axle Rpr Brg. Replaces O.E. Brg & Seal
Bushing Kit ⁹³Non-Traction Control.

²⁵New Item, Check For Availability

⁶⁴Seal &

Mfg./Year Model & Location Part No. Mfg./Year Model & Location Part No.

CHEVROLET - REAR DRIVE - Camaro, IROC, Z-28 (cont.)

CLUTCH - 6 CYLINDER

Release Bearing

2002-1995 3800/3.8L
 Bearing Assy 614174
 1995-1990 (w/o 3800/3.8L)
 Bearing Assy 614083

CLUTCH - 8 CYLINDER

Release Bearing

2002-1998
 Bearing Assy 614174
 1997-1993
 Bearing Assy 614116
 1992-1990
 Bearing Assy 614083

5-SPEED MANUAL TRANSMISSION

Transmission Rebuild Kit

2002-1990 (Borg Warner /Tremec-T5)
 KitTRK5W

Front Input Shaft

2002-1990 (Borg Warner /Tremec-T5)
 Seal 7412S
 Set SET5
 Repair SleeveKWK99125

Front Countershaft

2002-1990 (Borg Warner /Tremec-T5)
 Cone/Cup (Frnt) LM67048-LM67010BCE[2]
 Set (Rr) SET6[2]
 Ndle Bearing ThrustNTA1423[2]

Mainshaft Pilot

2002-1990 (Borg Warner /Tremec-T5)
 Ndle Bearing QBR23549[15]

Rear Output Shaft

2002-1990 (Borg Warner /Tremec-T5)
 Seal9613S[2]
 Cone/Cup25877-25821[2]
 Seal Kit 5200⁶⁴

6-SPEED MANUAL TRANSMISSION

Transmission Rebuild Kit

2002-1993 (Borg Warner /Tremec-T56)
 KitTRK56

Front Input Shaft

2002-1993 (Borg Warner /Tremec-T56)
 Seal 7412S
 Cone/Cup M88048-M88010[2]
 Repair SleeveKWK99125

6-SPEED MANUAL TRANSMISSION

Center Counter Shaft

2002-1993 (Borg Warner /Tremec-T56)
 Set (Frnt) SET5[2]
 Bearing Assy (Rr)32008XM[2]

Rear Output Shaft

2002-1993 (Borg Warner /Tremec-T56)
 Seal9613S
 Set SET16[2]
 Seal Kit 5200⁶⁴

A/C COMPRESSOR

2002-1990
 Ball Bearing907257[2]
 1995-1990
 Ball Bearing (Frnt Head) S128[2]

ALTERNATOR

2001-1990
 Ball Bearing (Rear End) 100CCAB

POWER STEERING

Pump Shaft

2002-1990
 Seal7013S[2]

CRANKSHAFT FRONT SEAL

6 Cylinder

2002-1995 3800/3.8L
 Seal Viton 710162
 Repair SleeveKWK99193
 1995-1993 201/3.4L
 Seal 9845
 Repair SleeveKWK99176
 1992-1990 191/3.1L
 Seal 9845
 Repair SleeveKWK99176

8 Cylinder

2002-1998 350/5.7L
 Seal Viton 100470
 1997-1990 350/5.7L
 Seal 9845
 Repair SleeveKWK99176
 1992-1990 305/5.0L
 Seal 9845
 Repair SleeveKWK99176

CRANKSHAFT REAR SEAL

6 Cylinder

2002-1995 3800/3.8L
 Seal Viton 320691
 Repair SleeveKWK99328
 1995-1993 201/3.4L
 Seal4307V
 Seal PTFE H/D 5273
 Repair SleeveKWK99298

⁶⁴Seal & Bushing Kit

Mfg./Year Model & Location Part No. Mfg./Year Model & Location Part No.

CHEVROLET - REAR DRIVE - Camaro, IROC, Z-28 (cont.)**CRANKSHAFT REAR SEAL (cont.)****6 Cylinder (cont.)**

1992-1990 191/3.1L
 Seal4307V
 Seal PTFE H/D 5273
 Repair SleeveKWK99298

8 Cylinder

2002-1998 346/5.7L (GEN III)
 Seal 100085
 1997-1990 350/5.7L
 Seal Viton 4359V
 Seal PTFE H/D 5274
 Repair SleeveKWK99364
 1992-1990 305/5.0L
 Seal Viton 4359V
 Seal PTFE H/D 5274
 Repair SleeveKWK99364

CHEVROLET - REAR DRIVE - Caprice, Impala**FRONT WHEEL****RWD**

1996-1994
 Seal (Inner)4739[2]
 Set (Inner) SET6[2]
 Set (Outer) SET3[2]

REAR WHEEL**RWD**

1996-1994 (Sedan)
 Seal8660S[2]
 Cylindrical Bearing 5707[2]
 Bearing & Seal Kit TRP1563TAV[2]¹⁹
 1996-1994 (Wagon)
 Seal8835S[2]
 Cylindrical Bearing 6408[2]
 Bearing & Seal KitTRP1559TV[2]¹⁹

REAR AXLE**Differential Rebuild Kit**

1996-1994 (7.625" R.G.)
 KitDRK320

Differential

1996-1994
 Cone/Cup LM501349-LM501314[2]

Pinion

1996-1994 (7.5" R.G., 7.625" R.G.)
 Seal8610
 Cone/Cup (Inner) HM89249-HM89210
 Cone/Cup (Outer) M86649-M86610

REAR AXLE (cont.)**Pinion (cont.)**

1996-1994 (8.5", 8.75", 8.875" R.G.)
 Seal2043
 Cone/Cup (Inner) M802048-M802011
 Cone/Cup (Outer) M88048-M88010

4-SPEED AUTOMATIC TRANSMISSION**Torque Converter**

1996-1994
 Seal3227
 Repair SleeveKWK99174

Rear Seal/Ext. Housing

1996-1994
 Seal9613S
 Repair SleeveKWK99149

Selector Shaft Seal/Man. Shaft

1996-1994
 Seal8792S
 Repair SleeveKWK99050

CRANKSHAFT FRONT SEAL**8 Cylinder**

1996-1994 265/4.3L
 Seal9845
 Repair SleeveKWK99176
 1996-1994 350/5.7L
 Seal9845
 Repair SleeveKWK99176

¹⁹Opt. Axle Rpr Brg. Replaces O.E. Brg & Seal

Mfg./Year Model & Location Part No. Mfg./Year Model & Location Part No.

CHEVROLET - REAR DRIVE - Caprice, Impala (cont.)

CRANKSHAFT REAR SEAL

8 Cylinder

1996-1994	265/4.3L	
Seal Viton		4359V
Seal PTFE H/D		5274
Repair Sleeve		KWK99364
1996-1994	350/5.7L	
Seal Viton		4359V
Seal PTFE H/D		5274
Repair Sleeve		KWK99364

CHEVROLET - REAR DRIVE - Corvette

FRONT WHEEL

RWD

2008-1997		
Hub Unit Bearing		513139[2]
1996-1991		
Hub Unit Bearing		513085[2]
1990		
Hub Unit Bearing		513019[2]

REAR WHEEL

RWD

2008-1997		
Hub Unit Bearing		512153[2]
1996-1990		
Hub Unit Bearing		513020[2]

REAR AXLE

Differential Rebuild Kit

1999-1990	(Dana/Spicer 36ICA Axle)	
Kit		DRK338
1999-1990	(Dana/Spicer 44ICA Axle)	
Kit		DRK339A

Differential

2005-1997		
Cone/Cup		387A-382A[2]
1996-1990	(A/T)	
Seal		3543[2]
Cone/Cup		LM501349-LM501314[2]
Repair Sleeve		KWK99139[2]
1996-1990	(M/T)	
Seal Viton		473227V[2]
Set		SET36[2]
Repair Sleeve		KWK99150

Pinion

2002-1997		
Cone/Cup (Inner)		NP201062-NP101912
Cone/Cup (Outer)		NP568415-NP908986

REAR AXLE (cont.)

Pinion (cont.)

1996-1990	(A/T)	
Seal Viton		5778V
Cone/Cup (Inner)		HM88649-HM88610
Cone/Cup (Outer)		M86647-M86610
Repair Sleeve		KWK99155
1996-1990	(M/T)	
Seal		9316
Cone/Cup (Inner)		M802048-M802011
Cone/Cup (Outer)		M88048-M88010
Repair Sleeve		KWK99187

4-SPEED AUTOMATIC TRANSMISSION

Torque Converter

2006-1990	(THM700)(4L60 E)	
Seal		3227
Repair Sleeve		KWK99174

Rear Seal/Ext. Housing

2006-1990	(THM700)(4L60 E)	
Seal		9613S
Seal Kit		5200 ⁶⁴

Selector Shaft Seal/Man. Shaft

2005-1990	(THM700)(4L60 E)	
Seal		8792S

6- SPEED AUTOMATIC TRANSMISSION

Rear Seal/Ext. Housing

2008-2006	(6L80)	
Seal		710533

6-SPEED AUTOMATIC TRANSMISSION

Selector Shaft Seal/Man. Shaft

2008-2006	(6L80)	
Seal		8792S

⁶⁴Seal & Bushing Kit

Mfg./Year	Model & Location	Part No.	Mfg./Year	Model & Location	Part No.
CHEVROLET - REAR DRIVE - Corvette (cont.)					

CLUTCH**Pilot Bearing**

2001-1990	
Ball Bearing	57080

CLUTCH - 8 CYLINDER**Release Bearing**

1996-1994	
Bearing Assy	614166 ¹⁶
1993-1990	
Bearing Assy	614117

6-SPEED MANUAL TRANSMISSION**Front Input Shaft Pocket**

2003-1997	(Borg Warner /Tremec-T56)
Set	SET16[2]

Main Shaft

2003-1997	(Borg Warner /Tremec-T56)
Seal (Frt)	7412S
Cone/Cup (Frt)	M88048-M88010[2]
Cone/Cup (Rr)	25572-25520[2]

Countershaft

2003-1997	(Borg Warner /Tremec-T56)
Set (Frt)	SET5[2]
Bearing Assy (Middle)	32008XM[2]

Rear Output Shaft

2003-1997	(Borg Warner /Tremec-T56)
Seal	9613S
Set	SET16[2]
Seal Kit	5200 ⁶⁴
1996-1990	(ZF S6-40)
Seal	9613S[2]
Seal Kit	5200 ⁶⁴

A/C COMPRESSOR

2002-1990	
Ball Bearing	907257[2]
2001-1990	
Ball Bearing (Frt Head)	S128

ALTERNATOR

1991-1990	
Ball Bearing (Rear End)	100CCAB
1991-1990	
Ball Bearing (Drive End)	203FF

POWER STEERING**Pitman Shaft**

1992-1990	(800 Gear)(4 bolt side cover)
Seal Kit	PSK1 ²⁴

POWER STEERING**Pump Shaft**

2001-1990	
Seal	221925
Ball Bearing	203FF[2]

Worm Shaft

1992-1990	
Seal	222025

CRANKSHAFT FRONT SEAL**8 Cylinder**

2008-2005	364/6.0L, 376/6.2L, 427/7.0L
Seal Viton	100470
Repair Sleeve	KWK99210
2004-1997	350/5.7L
Seal Viton	100470
Repair Sleeve	KWK99210
1996-1990	350/5.7L (OHV) (P)
Seal	9845
Repair Sleeve	KWK99176
Harmnc Balancer Slvs	88176
1995-1990	350/5.7L (DOHC) (ZR-1)
Seal	710173
Repair Sleeve	KWK99196

CRANKSHAFT REAR SEAL**8 Cylinder**

2009-1997	5.7L, 6.0L, 6.2L, 7.0L
Seal	100085
1996-1990	350/5.7L
Seal Viton	4359V
Seal PTFE H/D	5274
Repair Sleeve	KWK99364

¹⁶Obsolete²⁴Opt. Kit = Seals 5683 & 5684. Not Sold Separately⁶⁴Seal & Bushing Kit

Mfg./Year Model & Location Part No. Mfg./Year Model & Location Part No.

CHEVROLET Import - (See also GEO 1990 through 1997) - Metro, Prizm, Sprint

FRONT WHEEL

FWD

2002-1998	Prizm (ABS)	
Seal (Inner)	1993[2]
Ball Bearing (Inner)	510007[2]
Seal (Outer)	4898[2]
2002-1998	Prizm (Non-ABS)	
Seal (Inner)	1993[2]
Ball Bearing (Inner)	510007[2]
Seal (Outer)	4898[2]
Hub Unit Bearing	518507[2] ⁰⁶
Seal Kit	5696[2] ¹²
2001-1998	Metro	
Seal (Inner)	710394[2]
Ball Bearing (Inner)	510001[2]
Seal (Outer)	710175[2]

REAR WHEEL

FWD

2002-1998	Prizm (ABS)	
Hub Unit Bearing	512184[2]
2002-1998	Prizm (Non-ABS)	
Hub Unit Bearing	512018[2]
2001-1998	Metro (ABS)	
Hub Unit Bearing	512204[2]
2001-1998	Metro (Non-ABS)	
Ball Bearing (Inner)	205F[2]
Ball Bearing (Outer)	204F[2]

CLUTCH

Pilot Bearing

2001-1998	1324cc/1.3L	
Ball Bearing	200CC
2000-1990	3 Cyl.1.0	
Ball Bearing	200CC

Release Bearing

2002-1998	Prizm	
Bearing Assy	614152
2000-1998	Metro	
Bearing Assy	614082

3-SPEED AUTOMATIC TRANSAXLE

Differential

2001-1998	(Aisin A210)	
Ball Bearing	207[2]

Torque Converter

2001-1998	(Aisin A210)	
Seal	223830
Repair Sleeve	KWK99147

3-SPEED AUTOMATIC TRANSAXLE

Output Shaft

2001-1998	(Aisin A210)	
Seal	223540[2]
Repair Sleeve	KWK99139[2]

Manual Shaft

2001-1998	(Aisin A210)	
Seal	710116

4-SPEED AUTOMATIC TRANSAXLE

Differential

2002-1998	(Aisin)	
Seal	710416[2]

Torque Converter / Frt Pump

2002-1998	(Aisin)	
Seal	223830
Repair Sleeve	KWK99147

Output Shaft

2002-1998	(Aisin)	
Seal (LH)	710109
Seal (RH)	710110

Manual Shaft

2002-1998	(Aisin)	
Seal	221207
Repair Sleeve	KWK99049

5-SPEED MANUAL TRANSAXLE

Differential

2001-1998	Suzuki MX1	
Ball Bearing (LH)	207S
Ball Bearing (RH)	107WB

Input Shaft

2002-1998	(Aisin)	
Seal	320603
Ball Bearing	101SS[2]
Repair Sleeve	KWK99098
2001-1998	(Suzuki MX1)	
Bearing Assy (LH)	32204[2]
Seal (RH)	222030
Bearing Assy (RH)	32004WB[2]
Repair Sleeve	KWK99098

Output Shaft

2002-1998	(Aisin)	
Seal (LH)	710109
Seal (RH)	710110
2001-1998	(Suzuki MX1)	
Seal (LH)	223552
Repair Sleeve (LH)	KWK99139
Seal (RH)	223535
Repair Sleeve (RH)	KWK99139

⁰⁶Kit = 2 Seals, Studded Spindle, Bearing, Plate

¹²Opt = Seal & O-Ring. Incl w/ Hub Unit.

Mfg./Year Model & Location Part No. Mfg./Year Model & Location Part No.

CHEVROLET Import - (See also GEO 1990 through 1997) - Metro, Prizm, Sprint (cont.)

5-SPEED MANUAL TRANSAXLE

Selector Shaft Seal/Man. Shaft

2002-1990 (Aisin)
 Seal 1015N
 Repair Sleeve KWK99082

POWER STEERING

Pitman Shaft

2002-1998 Prizm
 Seal 221510

Pump Shaft

2002-1998 Prizm
 Seal 710412

Worm Shaft

2002-1998 Prizm
 Seal 222630

CAMSHAFT SEAL

3 Cylinder

2000-1998 993cc/1.0L
 Seal 710310
 Repair Sleeve KWK99128

4 Cylinder

2001-1998 1324cc/1.3L
 Seal 710310
 Repair Sleeve KWK99128

CRANKSHAFT FRONT SEAL

3 Cylinder

2000-1998 993cc/1.0L
 Seal 710310
 Repair Sleeve KWK99128

CRANKSHAFT FRONT SEAL

4 Cylinder

2002-1998 1.8L (DOHC)
 Seal 223800
 2001-1998 1324cc/1.3L
 Seal 710310
 Repair Sleeve KWK99128

CRANKSHAFT REAR SEAL

3 Cylinder

2000-1998 993cc/1.0L
 Seal 710334

4 Cylinder

2002-1998 1.8L (DOHC)
 Seal 3698
 2001-1998 1324cc/1.3L
 Seal 710334

CHEVROLET - Import SUV - Tracker

FRONT WHEEL

RWD

2004-2001
 Hub Unit Bearing 513193[2]
 2000-1998
 Seal (Inner) 710240[2]
 Bearing Assy (Inner) 517009[2]
 Seal (Outer) 710239[2]

4WD

2004-2001
 Hub Unit Bearing 513193[2]
 2000-1998
 Seal (Inner) 710240[2]
 Bearing Assy (Inner) 517009[2]
 Seal (Outer) 710239[2]

REAR WHEEL

RWD

2004-1998
 Seal (Inner) 710522[2]
 Seal (Outer) 710193[2]
 Ball Bearing 511024[2]

FRONT AXLE

Steering Knuckle

2004-1998
 Seal (Inner) 710255
 Seal (Outer) 710256

CHEVROLET - Import SUV - Tracker (cont.)

4WD FRONT AXLE

Differential

2004-1998
Cone/Cup 17887-17831[2]

Pinion

2004-1998
Bearing Assy (Inner) 30307M
Seal Viton (Outer) 350572
Bearing Assy (Outer) 30306M
Repair Sleeve KWK99147

REAR AXLE

Differential

2004-1998
Cone/Cup 17887-17831[2]

Pinion

2004-1998
Seal Viton 350572
Bearing Assy (Inner) 30307M
Bearing Assy (Outer) 30306M
Repair Sleeve KWK99147

TRANSFER CASE

Input Shaft

2004-1998
Seal 223540
Ball Bearing 207[2]
Repair Sleeve KWK99139

Front Output Shaft

2004-1998
Ball Bearing (Inner) 306L[2]
Seal (Outer) 1213N
Ball Bearing (Outer) RW122[2]
Repair Sleeve KWK99157

Rear Output Shaft

2002-1998
Seal 1213N
Ball Bearing RW122[2]
Repair Sleeve KWK99157

3-SPEED AUTOMATIC TRANSMISSION

Torque Converter

1998 (3L30)
Seal 6712NA
Repair Sleeve KWK99187

Rear Seal/Ext. Housing

1998 (3L30)
Seal 710343
Seal Kit 5200⁶⁴

3-SPEED AUTOMATIC TRANSMISSION

Selector Shaft Seal/Man. Shaft

1998-1990 (3L30)
Seal 8792S

4-SPEED AUTOMATIC TRANSMISSION

Torque Converter

2004-1998 (0372LE)
Seal 223605

Rear Seal/Ext. Housing

2004-1998 (0372LE)
Seal 710319

Selector Shaft Seal/Man. Shaft

2004-1998 (0372LE)
Seal 221207

CLUTCH

Release Bearing

2000-1998
Bearing Assy 614056

5-SPEED MANUAL TRANSMISSION

Front Input Shaft

2002-1998
Seal 222535
Repair Sleeve KWK99098

Rear Output Shaft

2002-1998
Seal 455134
Repair Sleeve KWK99098

ALTERNATOR

2001-1998 (Nippondenso)
Ball Bearing (Drive End) 303CC

POWER STEERING

Pump Shaft

2001-1998
Seal 221730

CAMSHAFT SEAL

4 Cylinder

2000-1998 1.6L
Seal 710310
Repair Sleeve KWK99128

CRANKSHAFT FRONT SEAL

4 Cylinder

2003-1999 2.0L (DOHC)
Seal 710521
Repair Sleeve KWK99128

⁶⁴Seal & Bushing Kit

Mfg./Year Model & Location Part No. Mfg./Year Model & Location Part No.

CHEVROLET - Import SUV - Tracker (cont.)**CRANKSHAFT FRONT SEAL (cont.)****4 Cylinder (cont.)**

2000-1998 1.6L
 Seal 710310
 Repair Sleeve KWK99128

6 Cylinder

2004-2001 2492cc/2.5L (DOHC)
 Seal 710521
 Repair Sleeve KWK99177

CRANKSHAFT REAR SEAL**4 Cylinder**

2003-1999 2.0L (DOHC)
 Seal 710520
 2000-1998 1.6L
 Seal 710334

CRANKSHAFT REAR SEAL**6 Cylinder**

2004-2001 2492cc/2.5L (DOHC)
 Seal 710520

CHEVROLET/GMC - Lt Truck - Acadia**FRONT WHEEL****FWD**

2008-2007
 Hub Unit Bearing HA590227[2]²⁵

AWD

2008-2007
 Hub Unit Bearing HA590227[2]²⁵

REAR WHEEL**FWD**

2008-2007
 Hub Unit Bearing HA590227[2]²⁵

REAR WHEEL**AWD**

2008-2007
 Hub Unit Bearing HA590227[2]²⁵

CHEVROLET/GMC - Lt Truck - Astro / Safari**FRONT WHEEL****RWD**

2005-2003
 Hub Unit Bearing HA590307[2]
 2002-1991
 Seal (Inner) 4739[2]
 Set (Inner) SET6[2]
 Set (Outer) SET3[2]
 1990
 Seal (Inner) 8871[2]
 Set (Inner) SET6[2]
 Set (Outer) SET3[2]

FRONT WHEEL**AWD**

2005-2003
 Hub Unit Bearing (RH) SP550309²⁵
 Hub Unit Bearing (LH) SP550310⁷⁸
 2002-1995 (ABS)
 Hub Unit Bearing SP550308[2]⁸⁴
 1994-1990
 Hub Unit Bearing 515005[2]

REAR WHEEL**RWD**

2005-2003
 Seal 4762N[2]
 Cylindrical Bearing 513067[2]
 Bearing & Seal Kit TRP59047[2]¹⁹

¹⁹Opt. Axle Rpr Brg. Replaces O.E. Brg & Seal
 New Item. ⁸⁴Reorder

²⁵New Item, Check For Availability

⁷⁸6 Stud,

Mfg./Year	Model & Location	Part No.	Mfg./Year	Model & Location	Part No.
-----------	------------------	----------	-----------	------------------	----------

CHEVROLET/GMC - Lt Truck - Astro / Safari (cont.)

REAR WHEEL (cont.)

RWD (cont.)

2002-1990	
Seal Viton	4795V[2]
Cylindrical Bearing	513023[2]
Bearing & Seal Kit (Non-ABS)	TRP57509[2] ¹⁹

4WD FRONT AXLE

Axle Shaft

2005-1997	
Seal	710491[2]
Ndle Bearing	HK4012[2]
1996-1990	
Seal	223255[2]
Ndle Bearing	B2010[2]

Differential Rebuild Kit

2005-1990	
Kit	DRK320A

Differential

2005-1990	
Set	SET11[2]

Pinion

2005-1990	
Seal	8611N
Cone/Cup (Inner) (O.E.)	M88048S-M88010
Cone/Cup (Outer)	M86649-M86610

REAR AXLE

Differential Rebuild Kit

2005-1999	(7.5" R.G., 7.625" R.G.)
Kit	DRK320C
1998-1990	(7.5" R.G., 7.625" R.G.)
Kit	DRK320

Differential

2005-2004	
Cone/Cup	LM501349-LM501314[2]
2003-2002	
Set (8.5" R.G.)	SET36[2]
Cone/Cup (Exc. 8.5" R.G.)	LM501349-LM501314[2]
2001-1990	
Cone/Cup	LM501349-LM501314[2]

Pinion

2005-2001	(7.625" R.G.)
Seal	8516N
Cone/Cup (Inner)	HM89249-HM89210
Cone/Cup (Outer)	M86649-M86610
2004-1997	(8.5" R.G.)
Seal	710506
Cone/Cup (Inner)	NP457992-NP926068
Cone/Cup (Outer)	M88048S-M88010
Repair Sleeve	KWK99193

REAR AXLE (cont.)

Pinion (cont.)

2000	(7.625" R.G.)
Seal (1st Design 1.5" I.D.)	8610
Seal (2nd Design 1.687" I.D.)	8516N
Cone/Cup (Inner)	HM89249-HM89210
Cone/Cup (Outer)	M86649-M86610
1999-1990	(7.5" R.G.)
Seal	8610
Cone/Cup (Inner)	HM89249-HM89210
Cone/Cup (Outer)	M86649-M86610

TRANSFER CASE REBUILD KIT

2002-1999	
Kit	TCRK233[2] ¹⁶
1998-1990	
Kit	TCRK1372[2]

TRANSFER CASE

Input Shaft

2005-1999	(New Process 136C)
Ball Bearing	110CB
Ball Bearing (Frt)	207
Seal	472636
2002-1999	(New Process 246)
Ndle Bearing	FC66561[2]
1998-1990	
Seal (O.E.)	710062
Ball Bearing	109TB
Repair Sleeve	KWK99175
Ndle Bearing (Pilot)	SCH1310

Front Output Shaft

2005-1999	(New Process 136C)
Ball Bearing (Frt)	207
Ball Bearing	110CB
1998-1990	
Seal	714503
Ball Bearing	207
Ndle Bearing (Pilot)	JH1612

Rear Output Shaft

2005-1999	(New Process 136C)
Seal	710496
Ndle Bearing (Frt)	J2416
2002-1999	(New Process 246)
Ndle Bearing	B5020[2]
1998-1990	(Warner 4472)(booted)
Seal	4503N
Ball Bearing	208SL[2]
1998-1990	(Warner 4472)(w/o boot)
Seal	714503
Ball Bearing	208SL[2]

¹⁶Obsolete ¹⁹Opt. Axle Rpr Brg. Replaces O.E. Brg & Seal

CHEVROLET/GMC - Lt Truck - Astro / Safari (cont.)**4-SPEED AUTOMATIC TRANSMISSION****Torque Converter**

2005-1993	(4L60, 4L60E, 4L65E)	
Seal	3227
Repair Sleeve	KWK99174
1992-1990		
Seal	3227[2]
Repair Sleeve	KWK99174

Rear Seal/Ext. Housing

2005-1990		
Seal (Non-Booted)	4583
Seal (Booted)	4934
Seal Kit Opt Seal &		
Bushing	5200 ⁶⁴

Selector Shaft Seal/Man. Shaft

2005-1990	(THM700)(4L60 E)	
Seal	8792S
Repair Sleeve	KWK99050

A/C COMPRESSOR

2002-1990		
Ball Bearing	907257[2]
2002-1990		
Ball Bearing (Frt Head)	S128

POWER STEERING**Pitman Shaft**

2001-1990		
Seal Kit	PSK1 ²⁴

Pump Shaft

2001-1994		
Seal	7013S
1993-1990	(integral reservoir)	
Seal	221925
Ball Bearing	203FF[2]
1993-1990	(remote reservoir)	
Seal	7013S

Worm Shaft

2001-1990		
Seal	222025

CRANKSHAFT FRONT SEAL**4 Cylinder**

1990	151/2.5L	
Seal	9845
Repair Sleeve	KWK99176
Harmnc Balancer Slvs	88176

6 Cylinder

2005-1990	262/4.3L	
Seal	9845
Repair Sleeve	KWK99176
Harmnc Balancer Slvs	88176

CRANKSHAFT REAR SEAL**4 Cylinder**

1990	151/2.5L	
Seal	3698
Repair Sleeve	KWK99300

6 Cylinder

2005-1997	4.3L	
Seal Viton	4359V
Seal PTFE H/D	5274
Repair Sleeve	KWK99364
1996-1990	262/4.3L	
Seal Viton	4359V
Seal PTFE H/D	5274
Repair Sleeve	KWK99364

²⁴Opt. Kit = Seals 5683 & 5684. Not Sold Separately⁶⁴Seal & Bushing Kit

Mfg./Year	Model & Location	Part No.	Mfg./Year	Model & Location	Part No.
CHEVROLET/GMC - Lt Truck - Colorado/Canyon					

FRONT WHEEL

RWD

2009
 Hub Unit Bearing
 Sensor Part Of Knuckle HA590300[2]⁰²

2008-2004 (Z71 Pkg.)
 Hub Unit Bearing (RH) HA590053⁰²
 Hub Unit Bearing (LH) HA590061⁰²
 Sensor Kit (RH) SK590053
 Sensor Kit (LH) SK590061

2008-2004 (Z85 Pkg.)
 Hub Unit Bearing (RH) HA590062⁰²
 Hub Unit Bearing (LH) HA590058⁰²
 Sensor Kit (LH) SK590058
 Sensor Kit (RH) SK590062

2008-2004 (ZQ8 Pkg.)
 Hub Unit Bearing (RH) HA590059⁰²
 Hub Unit Bearing (LH) HA590054⁰²
 Sensor Kit (LH) SK590054
 Sensor Kit (RH) SK590059

4WD

2009
 Hub Unit Bearing
 Sensor Part Of Knuckle HA590304[2]⁰²

2008-2004
 Hub Unit Bearing (RH) HA590023⁰²
 Hub Unit Bearing (LH) HA590060⁰²
 Sensor Kit (RH) SK590053
 Sensor Kit (LH) SK590061

REAR WHEEL

RWD

2008-2004
 Seal 4762N[2]
 Cylindrical Bearing 513067[2]
 Bearing & Seal Kit TRP59047[2]¹⁹

4WD FRONT AXLE

Differential

2006-2004
 Cone/Cup LM501349-LM501314[2]

Pinion

2008-2004
 Seal 710549
 Cone/Cup (Inner) HM89249-HM89210
 Cone/Cup (Outer) M86649-M86610

REAR AXLE

Differential Rebuild Kit

2007-2004 (8" R.G.)
 Kit DRK320D

Differential

2006-2004
 Set SET36[2]

REAR AXLE

Pinion

2008-2004
 Seal 710474²⁵
 Cone/Cup (Inner) HM89249-HM89210
 Cone/Cup (Outer) M86649-M86610

TRANSFER CASE

Front Output Shaft

2008-2004
 Seal Viton 4813V
 Ball Bearing (New
 Process 231C, 233C) 206WB
 Ball Bearing (New
 Process 236) 207

4-SPEED AUTOMATIC TRANSMISSION

Torque Converter

2006-2004 (4L60E)
 Seal 3227

Rear Seal/Ext. Housing

2006-2004 (4L60E)
 Seal 9613S

Selector Shaft Seal/Man. Shaft

2008-2004 (4L60E)
 Seal 8792S

⁰²Does Not Come w/ Sensor Cable.
 Check For Availability

¹⁹Opt. Axle Rpr Brg. Replaces O.E. Brg & Seal

²⁵New Item,

Mfg./Year Model & Location Part No. Mfg./Year Model & Location Part No.

CHEVROLET/GMC - Lt Truck - Trailblazer/Envoy**FRONT WHEEL****RWD**

2009-2002
Hub Unit Bearing 513188[2]

4WD

2009-2002
Hub Unit Bearing 513188[2]

REAR WHEEL**RWD**

2009-2002
Seal 4762N[2]
Cylindrical Bearing 513067[2]
Bearing & Seal Kit TRP59047[2]¹⁹

4WD FRONT AXLE**Axle Shaft**

2008-2002 (7.25" R.G.)
Seal 710491[2]
Ndle Bearing (Outer) SCH208[2]
Ndle Bearing (Pilot) SCH78[2]
2004-2002 (7.25" R.G.)(1.5" O.D.)
Ndle Bearing B2010[2]
2004-2002 (7.25" R.G.)(1.85" O.D.)
Ndle Bearing HK4012[2]

Differential Rebuild Kit

2005-2002
Kit DRK320A

Differential

2006-2002
Set SET11[2]

Pinion

2008 (7.25" R.G.)
Seal 710547
2007-2002 (7.25" R.G.)
Seal 8611N
Cone/Cup (Inner) M88048S-M88010
Cone/Cup (Outer) M86649-M86610

REAR AXLE**Differential Rebuild Kit**

2007-2002 (8.5", 8.625" R.G.)
Kit DRK321C
2005-2002 (7.5" R.G., 7.625" R.G.)
Kit DRK320C

Differential

2007-2002 (8.5", 8.625" R.G.)
Set SET36[2]
2005-2002 (7.5" R.G., 7.625" R.G.)
Cone/Cup LM501349-LM501314[2]

REAR AXLE**Pinion**

2008-2002 (8.5", 8.625" R.G.)(113" W/B)
Seal 710474²⁵
Cone/Cup (Inner) NP457992-NP926068
Cone/Cup (Outer) M86649-M86610
2008-2002 (8.5", 8.625" R.G.)(129" W/B)
Seal 710506
Cone/Cup (Inner) NP544520-NP099285
Cone/Cup (Outer) M88048-M88010
2005-2002 (7.5" R.G., 7.625" R.G.)
Seal 8610
Cone/Cup (Inner) HM89249-HM89210
Cone/Cup (Outer) M86649-M86610

TRANSFER CASE**Input Shaft**

2008-2002 (New Process 233C)
Seal 3173
Seal (Opt) 710928
Repair Sleeve KWK99193

Front Output Shaft

2008-2002 (New Process 233C)
Seal Viton 4813V

4-SPEED AUTOMATIC TRANSMISSION**Torque Converter**

2006-2002 (4L60E)
Seal 3227

Rear Seal/Ext. Housing

2006-2002 (4L60E)
Seal 9613S

Selector Shaft Seal/Man. Shaft

2008-2006 (4L60E, 4L70E)
Seal 8792S
2005-2002 (4L60E)
Seal 8792S

CRANKSHAFT FRONT SEAL**6 Cylinder**

2000-1998 262/4.3L
Seal 9845

8 Cylinder

2008-2003 325/5.3L, 364/6.0L
Seal Viton 100470
Repair Sleeve KWK99210

CRANKSHAFT REAR SEAL**8 Cylinder**

2009-2003 5.3L, 6.0L
Seal 100085

¹⁹Opt. Axle Rpr Brg. Replaces O.E. Brg & Seal²⁵New Item, Check For Availability

Mfg./Year Model & Location Part No. Mfg./Year Model & Location Part No.

CHEVROLET/GMC - Lt Truck - Equinox

FRONT WHEEL

FWD

2009-2007
 Hub Unit Bearing HA590262[2]²⁵
 2006-2005 (ABS)
 Hub Unit Bearing 513189[2]
 2006-2005 (Non-ABS)
 Hub Unit Bearing 513190[2]

AWD

2009-2007
 Hub Unit Bearing HA590262[2]²⁵
 2006-2005 (ABS)
 Hub Unit Bearing 513189[2]
 2006-2005 (Non-ABS)
 Hub Unit Bearing 513190[2]

REAR WHEEL

FWD

2009-2007
 Hub Unit Bearing HA590264[2]²⁵
 2006-2005 (ABS)
 Hub Unit Bearing 512229[2]
 2006-2005 (Non-ABS)
 Hub Unit Bearing 512230[2]

AWD

2009-2007
 Hub Unit Bearing HA590264[2]²⁵
 2006-2005
 Hub Unit Bearing 512229[2]

5-SPEED AUTOMATIC TRANSMISSION

Selector Shaft Seal/Man. Shaft

2007-2005 (AF33)
 Seal 221207

5-SPEED AUTOMATIC TRANSAXLE

Output Shaft

2009-2005 (AF33)
 Seal 4764

CRANKSHAFT FRONT SEAL

6 Cylinder

2009-2005 207/3.4L
 Seal 9845
 Repair Sleeve KWK99176

CRANKSHAFT REAR SEAL

6 Cylinder

2009-2005 207/3.4L
 Seal 4307V
 Seal PTFE H/D 5273
 Repair Sleeve KWK99298

CHEVROLET/GMC - Lt Truck - HHR

FRONT WHEEL

FWD

2008-2006 (ABS)
 Hub Unit Bearing HA590086[2]
 2008-2006 (Non-ABS)
 Hub Unit Bearing HA590087[2]

REAR WHEEL

FWD

2008-2006 (ABS)
 Hub Unit Bearing HA590088[2]
 2008-2006 (Non-ABS)
 Hub Unit Bearing HA590089[2]

4-SPEED AUTOMATIC TRANSAXLE

Torque Converter / Frt Pump

2009-2006 (4T45E)
 Seal 4072N
 Repair Sleeve KWK99172

Output Shaft

2009-2006 (4T45E)
 Seal SL260001[2]²⁵

Manual Shaft

2009-2006 (4T45E)
 Seal 8792S

²⁵New Item, Check For Availability

Mfg./Year	Model & Location	Part No.	Mfg./Year	Model & Location	Part No.
CHEVROLET/GMC - Lt Truck - HHR (cont.)					

CRANKSHAFT REAR SEAL**4 Cylinder**

2009-2006	2.0L, 2.2L, 2.4L	
Seal Viton		710237

CHEVROLET/GMC - Lt Truck - Lumina APV, Venture**FRONT WHEEL****FWD**

2005-2003	(Non-ABS)	
Hub Unit Bearing		513160[2] ⁸³
Hub Unit Bearing		HA590085[2] ⁸⁴
2005-2002	(FWD)(ABS)	
Hub Unit Bearing		513179[2] ⁷³
2004-2002		
Hub Unit Bearing		513187[2]
2001		
Hub Unit Bearing		513121[2] ⁷²
Hub Unit Bearing		513179[2] ⁷³
2000-1997	(ABS)	
Hub Unit Bearing		513121[2] ⁷²
1996-1992		
Hub Unit Bearing		513087[2] ⁴⁵
1991-1990		
Hub Unit Bearing		513016K[2] ⁶¹
Seal Kit		5698[2] ¹²

REAR WHEEL**FWD**

2005-1997	(Disc)	
Hub Unit Bearing		512150[2] ⁸³
Hub Unit Bearing		512237[2] ⁸⁴
2005-1997	(Drum)	
Hub Unit Bearing		512078[2] ²⁷
1996-1992		
Hub Unit Bearing		512078[2]
1991-1990		
Hub Unit Bearing		513018[2]

AWD

2005-2002		
Hub Unit Bearing		513121[2] ⁷²

3-SPEED AUTOMATIC TRANSAXLE**Torque Converter**

1996-1990	(THM125C)	
Seal		4072N[2]
Repair Sleeve		KWK99172

Output Shaft

1995-1990	(THM125C)	
Seal		3543[2]
Repair Sleeve		KWK99139[2]
Seal Kit		5690[2] ¹⁸

3-SPEED AUTOMATIC TRANSAXLE**Manual Shaft**

1996-1990	(THM125C)	
Seal		8792S[2]

4-SPEED AUTOMATIC TRANSAXLE**Torque Converter / Frt Pump**

2005-1990	(4T60E, 4T65E)	
Seal		4072N
Repair Sleeve		KWK99172

Output Shaft

2005-1999	(4T65 E)	
Seal (LH)		100165
Repair Sleeve (LH)		KWK99139
Seal (RH)		3543
Repair Sleeve (RH)		KWK99138
1998-1992	(4T60E)	
Seal (LH)		710096
Repair Sleeve (LH)		KWK99139
Seal (RH)		3543
Repair Sleeve (RH)		KWK99138

Manual Shaft

2005-1990	(4T60E, 4T65E)	
Seal		8792S

A/C COMPRESSOR

2002-1990		
Ball Bearing		907257[2]
Ball Bearing (Frt Head)		S128

ALTERNATOR

1999-1992	(Delco 140 Amp.)	
Ball Bearing (Rear End)		100CCAB

POWER STEERING**Pump Shaft**

2002-1996		
Seal		7013S
1995-1990	(integral reservoir)	
Ball Bearing		203FF[2]
1995-1990	(remote reservoir)	
Seal		7013S

¹²Opt = Seal & O-Ring. Incl w/ Hub Unit. ¹⁸Opt. = Brg, Slv, Hardware, Hsg. ²⁷Domestic Vehicles Only ⁴⁵Brg Flg Mtg Holes Non-Threaded. ⁶¹Kit = Seal, Hub Nut, & Brg Unit

⁷²Steel Wire Clip. Brg Flg Mtg Holes Threaded. ⁷³Plastic Wire Clip. ⁸³Deplete Inventory ⁸⁴Reorder

Mfg./Year Model & Location Part No. Mfg./Year Model & Location Part No.

CHEVROLET/GMC - Lt Truck - Lumina APV, Venture (cont.)

CRANKSHAFT FRONT SEAL

6 Cylinder

2005-1996	201/3.4L	
Seal		9845
Repair Sleeve		KWK99176
Harmnc Balancer Slvs		88176
1995-1992	231/3.8L	
Seal Viton		710162
Repair Sleeve		KWK99193
1995-1990	191/3.1L	
Seal		9845
Repair Sleeve		KWK99176
Harmnc Balancer Slvs		88176

CRANKSHAFT REAR SEAL

6 Cylinder

2005-1996	201/3.4L	
Seal		4307V
Seal PTFE H/D		5273
Repair Sleeve		KWK99298

CRANKSHAFT REAR SEAL (cont.)

6 Cylinder (cont.)

1995-1992	231/3.8L	
Seal Viton		320691
Repair Sleeve		KWK99328
1995-1990	189/3.1L	
Seal		4307V
Seal PTFE H/D		5273
Repair Sleeve		KWK99298

CHEVROLET/GMC - Lt Truck - S10 Blazer/S15 Jimmy, S10 Pickup/S15 Sonoma, Syclone/Typhoon

FRONT WHEEL

RWD

2005-1998	Blazer/Jimmy	
Hub Unit Bearing		SP450300[2] ⁴⁰
Sensor Kit		SK450300[2] ³⁹
2003-1998	S10/Sonoma	
Seal (Inner)		4739[2]
Set (Inner)		SET6[2]
Set (Outer)		SET34[2]
1997-1991		
Seal (Inner)		4739[2]
Set (Inner)		SET6[2]
Set (Outer)		SET34[2]
1990		
Seal (Inner)		8871[2]
Set (Inner)		SET6[2]
Set (Outer)		SET34[2]

4WD

2005-1998		
Hub Unit Bearing		513124[2]
1997		
Hub Unit Bearing		513061[2]
1996-1994		
Hub Unit Bearing		513061[2]
1993-1992	Blazer/Jimmy	
Hub Unit Bearing		513061[2]
1993-1991	Pickup	
Hub Unit Bearing		513013[2]
1991	Blazer/Jimmy 2Dr.	
Hub Unit Bearing		513013[2]
1991	Blazer/Jimmy 4 Dr.	
Hub Unit Bearing		513061[2]
1990		
Hub Unit Bearing		513013[2]

AWD

1997		
Hub Unit Bearing		513124[2]
1992-1991	Syclone, Typhoon	
Hub Unit Bearing		513061[2]

REAR WHEEL

RWD

2005-1992	(Exc. Extended Cab)	
Seal (Axle Code K)(Mf		
In Canada)		8660S[2]
Seal (Axle Code C)(Mf		
In U.S.A.)		710166[2]
Cylindrical Bearing		5707[2]
Bearing & Seal Kit		TRP1563TAV[2] ¹⁹
2004-1995	(Extended Cab)	
Seal (Limited Slip		
Differential)(8.5" R.G.)		4762N[2]
Cylindrical Bearing		
(Limited Slip		
Differential)(8.5" R.G.)		513067[2]
Bearing & Seal Kit		
(Limited Slip		
Differential)(8.5" R.G.)		TRP59047[2] ¹⁹
Seal (Exc. Limited Slip		
Differential)(8.5" R.G.)		8835S[2]
Cylindrical Bearing		
(Exc. Limited Slip		
Differential)(8.5" R.G.)		6408[2]
Bearing & Seal Kit		
(Exc. Limited Slip		
Differential)(8.5" R.G.)		TRP1559TV[2] ¹⁹

¹⁹Opt. Axle Rpr Brg. Replaces O.E. Brg & Seal

³⁹Opt. Kit = Cable, Screw, Grease.

⁴⁰5 Stud.

CHEVROLET/GMC - Lt Truck - S10 Blazer/S15 Jimmy, S10 Pickup/S15 Sonoma, Syclone/Typhoon (cont.)**REAR WHEEL (cont.)****RWD (cont.)**

2001-1999 Blazer/Jimmy	
Seal Viton (Limited Slip Differential)(7.6" R.G.)	4795V[2]
Cylindrical Bearing (Limited Slip Differential)(7.6" R.G.)	513023[2]
1991 (4 Dr.)(7.625" R.G.)	
Seal	710166[2]
Cylindrical Bearing	5707[2]
Bearing & Seal Kit	TRP1563TAV[2] ¹⁹
1991 (7.625" R.G.)	
Seal	8660S[2]
Cylindrical Bearing	5707[2]
Bearing & Seal Kit	TRP1563TAV[2] ¹⁹
1990	
Seal	8660S[2]
Cylindrical Bearing	5707[2]
Bearing & Seal Kit	TRP1563TAV[2] ¹⁹

4WD

2005-1992 (Exc. Extended Cab)	
Seal (Axle Code K)(Mf In Canada)	8660S[2]
Seal (Axle Code C)(Mf In U.S.A.)	710166[2]
Cylindrical Bearing	5707[2]
Bearing & Seal Kit	TRP1563TAV[2] ¹⁹
2004-1995 (Extended Cab)	
Seal (Limited Slip Differential)(8.5" R.G.)	4762N[2]
Cylindrical Bearing (Limited Slip Differential)(8.5" R.G.)	513067[2]
Bearing & Seal Kit (Limited Slip Differential)(8.5" R.G.)	TRP59047[2] ¹⁹
Seal (Exc. Limited Slip Differential)(8.5" R.G.)	8835S[2]
Cylindrical Bearing (Exc. Limited Slip Differential)(8.5" R.G.)	6408[2]
Bearing & Seal Kit (Exc. Limited Slip Differential)(8.5" R.G.)	TRP1559TV[2] ¹⁹
2001-1999 Blazer/Jimmy	
Seal Viton (Limited Slip Differential)(7.6" R.G.)	4795V[2]
Cylindrical Bearing (Limited Slip Differential)(7.6" R.G.)	513023[2]
1991 (4 Dr.)(7.625" R.G.)	
Seal	710166[2]
Cylindrical Bearing	5707[2]
Bearing & Seal Kit	TRP1563TAV[2] ¹⁹
1991 (7.625" R.G.)	
Seal	8660S[2]
Cylindrical Bearing	5707[2]
Bearing & Seal Kit	TRP1563TAV[2] ¹⁹

REAR WHEEL (cont.)**4WD (cont.)**

1990	
Seal	8660S[2]
Cylindrical Bearing	5707[2]
Bearing & Seal Kit	TRP1563TAV[2] ¹⁹
AWD	
1993-1992 Syclone, Typhoon	
Seal (Axle Code K)(Mf In Canada)	8660S[2]
Seal (Axle Code C)(Mf In U.S.A.)	710166[2]
Cylindrical Bearing	5707[2]
Bearing & Seal Kit	TRP1563TAV[2] ¹⁹
1991 Syclone, Typhoon	
Seal	8660S[2]
Cylindrical Bearing	5707[2]
Bearing & Seal Kit	TRP1563TAV[2] ¹⁹

4WD FRONT AXLE**Axle Shaft**

2005-1998	
Seal	710491[2]
Ndle Bearing	B2010[2]
1996-1990	
Seal	223255[2]
Ndle Bearing	B2010[2]

Differential Rebuild Kit

2005-1990 (7.25" R.G.)	
Kit	DRK320A

Differential

2004-1990 (7.25" R.G.)	
Set	SET11[2]

Pinion

2005-1990 (7.25" R.G.)	
Seal	8611N
Cone/Cup (Inner)	M88048S-M88010
Cone/Cup (Outer)	M86649-M86610

REAR AXLE**Differential Rebuild Kit**

2005-1999 (7.5" R.G., 7.625" R.G.)	
Kit	DRK320C
2004-2003 (8.625" R.G.)	
Kit	DRK321C
1998-1990 (7.5" R.G., 7.625" R.G.)	
Kit	DRK320

Differential

2005-2001 (7.5" R.G., 7.625" R.G.)	
Cone/Cup	LM501349-LM501314[2]
2004-2001 (8.5", 8.625" R.G.)	
Set	SET36[2]

¹⁹Opt. Axle Rpr Brg. Replaces O.E. Brg & Seal

Mfg./Year	Model & Location	Part No.	Mfg./Year	Model & Location	Part No.
CHEVROLET/GMC - Lt Truck - S10 Blazer/S15 Jimmy, S10 Pickup/S15 Sonoma, Cyclone/Typhoon (cont.)					

REAR AXLE (cont.)

Differential (cont.)

2000	(8.5" R.G.)
Cone/Cup (1st Design)	LM501349-LM501314[2]
Set (2nd Design)	SET36[2]
1999-1990	
Cone/Cup	LM501349-LM501314[2]

Pinion

2005-2004	(8.5", 8.625" R.G.)
Seal	710506
Cone/Cup (Inner)	NP457992-NP926068
Cone/Cup (Outer)	M88048-M88010
2005-1999	(7.5" R.G., 7.625" R.G.)
Seal (1.5" ID)	8610
Seal (1.6")	710474 ²⁵
Cone/Cup (Inner)	HM89249-HM89210
Cone/Cup (Outer)	M86649-M86610
Repair Sleeve	KWK99152
2003-1997	(8.5" R.G.)(2nd Design)
Seal	710506
Cone/Cup (Inner)	NP457992-NP926068
Cone/Cup (Outer)	M88048-M88010
Repair Sleeve	KWK99212
1998-1990	(7.5" R.G., 7.625" R.G.)
Seal	8610
Cone/Cup (Inner)	HM89249-HM89210
Cone/Cup (Outer)	M86649-M86610
Repair Sleeve	KWK99152
1997-1990	(8.5" R.G.)(1st Design)
Seal	2043
Cone/Cup (Inner)	M802048-M802011
Cone/Cup (Outer)	M88048-M88010
Repair Sleeve	KWK99193

TRANSFER CASE REBUILD KIT

2002-1998	(New Process 236)(Opt. code NP8)(Elec. shift)
Kit	TCRK236[2]
2002-1992	(New Process 233C)(Opt. code NP1)(Elec. shift)
Kit	TCRK233[2] ¹⁶
1997-1990	(New Process 231C)(floor shift)
Kit	TCRK231A[2] ¹⁶

TRANSFER CASE

Input Shaft

2005-1998	(New Process 236)(Opt. code NP8)(Elec. shift)
Ball Bearing	110CB
Ndle Bearing (Pilot)	FC66561
Seal	472636
2005-1994	(New Process 231, 233)
Seal (O.E.)	3173
Ball Bearing	110L
Seal (Opt)	710298
Repair Sleeve	KWK99193
Ndle Bearing (Pilot)	FC66561

TRANSFER CASE (cont.)

Input Shaft (cont.)

1993-1991	(New Process 231, 233)
Seal (O.E.)	3173
Ball Bearing	N5210KLB
Seal (Opt)	710298
Repair Sleeve	KWK99193
Ndle Bearing (Pilot)	FC66561
1990	(New Process 231C)(floor shift)
Seal (O.E.)	3173
Ball Bearing	N5210KLB
Seal (Opt)	710298
Repair Sleeve	KWK99193
Ndle Bearing (Pilot)	SCH1810

Front Output Shaft

2005-1995	(New Process 231, 233)
Seal Viton	4813V
Ball Bearing	206WB
Repair Sleeve	KWK99155
Ndle Bearing (Pilot)	J2416
2002-1998	(New Process 236)(Opt. code NP8)(Elec. shift)
Ball Bearing	207
Ndle Bearing (Pilot)	J2416
1994-1990	(New Process 231, 233)
Seal	710046
Ball Bearing	206WB
Repair Sleeve	KWK99155
Ndle Bearing (Pilot)	J2416

Rear Output Shaft

2002-1994	(New Process 231, 233)
Seal	4333N
Ball Bearing	206WB
Seal Kit	5200 ⁶⁴
Ndle Bearing (Pilot)	B5020
1993-1991	(New Process 231, 233)(ext cab)
Seal	9449
Ball Bearing	207
Seal Kit	5208 ⁶⁴
Ndle Bearing (Pilot)	B5020
1993-1990	(New Process 231)(Std. cab)
Seal	9613S
Ball Bearing	206WB
Seal Kit	5200 ⁶⁴
Ndle Bearing (Pilot)	B5020

4-SPEED AUTOMATIC TRANSMISSION

Torque Converter

2005-1990	
Seal	3227[2]
Repair Sleeve	KWK99174

¹⁶Obsolete

²⁵New Item, Check For Availability

⁶⁴Seal & Bushing Kit

CHEVROLET/GMC - Lt Truck - S10 Blazer/S15 Jimmy, S10 Pickup/S15 Sonoma, Syclone/Typhoon (cont.)**4-SPEED AUTOMATIC TRANSMISSION****Rear Seal/Ext. Housing**

2008-1997	(4L60, 4L60E, THM700R4)	
Seal	4934
1996-1990	(4L60, 4L60E, 4L65E)	
Seal	9613S[2]
Repair Sleeve	KWK99149
Seal Kit	5200 ⁶⁴

Selector Shaft Seal/Man. Shaft

2005-1990		
Seal	8792S[2]
Repair Sleeve	KWK99050

CLUTCH**Pilot Bearing**

2002-1994	133/2.2L (Gas)	
Bushing H/D	PB652HD
2002-1990	262/4.3L	
Ball Bearing	57080
1993-1990	151/2.5L	
Bushing H/D	PB656HD
1993-1990	173/2.8L	
Bushing H/D	PB652HD

CLUTCH - 4 CYLINDER**Release Bearing**

2000-1996	133/2.2L (Gas)	
Bearing Assy	614174
1995-1994	133/2.2L (Gas)	
Bearing Assy	614083
1993-1990	151/2.5L	
Bearing Assy	614083

CLUTCH - 6 CYLINDER**Release Bearing**

2000-1996	262/4.3L	
Bearing Assy	614174
1995-1990	262/4.3L	
Bearing Assy	614083
1993-1990	173/2.8L	
Bearing Assy	614083

5-SPEED MANUAL TRANSMISSION**Transmission Rebuild Kit**

2001-1996	(New Venture M50)	
Kit	TRK235E ⁴¹
1995-1990	(Warner T5 World Class)	
Kit	TRK5W

Front Input Shaft

2005-1995	(New Venture M50)(4WD)	
Seal	4529N
2005-1995	(New Venture MW2)(2WD)	
Seal	223020
Ball Bearing	306VVL[2]

5-SPEED MANUAL TRANSMISSION**(cont.)****Front Input Shaft (cont.)**

1995-1990	(Warner)	
Seal	7412S
Set	SET5[2]
Repair Sleeve	KWK99125
1994-1990	(Hydramatic 5 Spd. (4WD))	
Seal	4529N

Rear Output Shaft

2005-1995	(New Venture M50)(4WD)	
Seal	4530
2005-1995	(New Venture MW2)(2WD)	
Seal	416288
Ball Bearing	306L[2]
1995-1990	(Warner)	
Seal	9613S
Repair Sleeve	KWK99149
Seal Kit	5200 ⁶⁴
1994-1990	(Hydramatic 5 Spd. (4WD))	
Seal	4532N

A/C COMPRESSOR

2002-1990		
Ball Bearing	907257[2]
Ball Bearing (Frt Head)	S128

DRIVESHAFT SUPPORT

2001-1990		
Ball Bearing	88107[2]
Hanger Bearing Assy	HB88107A[2]

POWER STEERING**Pitman Shaft**

1996-1990		
Seal Kit	PSK1 ²⁴

Pump Shaft

2002-1994		
Seal	7013S
1993-1990	(integral reservoir)	
Ball Bearing	203FF[2]
1993-1990	(remote reservoir)	
Seal	7013S

Worm Shaft

1996-1990		
Seal	222025

MANUAL STEERING**Pitman Shaft**

1993-1990		
Seal	251511

²⁴Opt. Kit = Seals 5683 & 5684. Not Sold Separately Bushing Kit⁴¹Contains Larger C/S Brgs⁶⁴Seal &

Mfg./Year Model & Location Part No. Mfg./Year Model & Location Part No.

CHEVROLET/GMC - Lt Truck - S10 Blazer/S15 Jimmy, S10 Pickup/S15 Sonoma, Cyclone/Typhoon (cont.)

MANUAL STEERING

Worm Shaft

1993-1990
 Seal480821
 Ball Bearing 8537[2] ¹⁶

CRANKSHAFT FRONT SEAL

4 Cylinder

2003-1994 133/2.2L (Gas)
 Seal9845
 Repair SleeveKWK99176
 Harmnc Balancer Slvs 88176
 1993-1990 151/2.5L
 Seal9845
 Repair SleeveKWK99176
 Harmnc Balancer Slvs 88176

6 Cylinder

2005-1990 262/4.3L
 Seal9845
 Repair SleeveKWK99176
 Harmnc Balancer Slvs 88176
 1993-1990 173/2.8L
 Seal9845
 Repair SleeveKWK99176

CRANKSHAFT REAR SEAL

4 Cylinder

2003-1994 133/2.2L (Gas)
 Seal4307V
 Seal PTFE H/D 5273
 Repair SleeveKWK99298
 1997-1990 2.5L
 Seal3698

CRANKSHAFT REAR SEAL (cont.)

4 Cylinder (cont.)

1993-1990 151/2.5L
 Seal3698

6 Cylinder

2005-1990 262/4.3L
 Seal Viton 4359V
 Seal PTFE H/D 5274
 Repair SleeveKWK99364
 1993-1990 173/2.8L
 Seal4307V
 Seal PTFE H/D 5273
 Repair SleeveKWK99298

CHEVROLET/GMC - Lt Truck - SSR

FRONT WHEEL

RWD

2006-2003
 Hub Unit Bearing 513188[2]

REAR WHEEL

RWD

2006-2003
 Seal4762N[2]
 Cylindrical Bearing 513067[2]
 Bearing & Seal KitTRP59047[2] ¹⁹

REAR AXLE

Differential Rebuild Kit

2006-2003 (8.625" R.G.)
 Kit DRK321C

REAR AXLE

Differential

2006-2005 (A/T)
 Set SET36[2]
 2006-2005 (M/T)
 Set SET42[2]
 2004-2003
 Set SET36[2]

Pinion

2006-2005 (A/T)
 Seal 710506
 Cone/Cup (Inner) NP544520-NP099285
 Cone/Cup (Outer) M88048-M88010
 2006-2005 (M/T)
 Cone/Cup (Inner) HM804846-HM804810
 Cone/Cup (Outer) HM88649-HM88610

¹⁶Obsolete ¹⁹Opt. Axle Rpr Brg. Replaces O.E. Brg & Seal

Mfg./Year Model & Location Part No. Mfg./Year Model & Location Part No.

CHEVROLET/GMC - Lt Truck - SSR (cont.)**REAR AXLE (cont.)****Pinion (cont.)**

2004-2003
 Seal 710506
 Cone/Cup (Inner) NP544520-NP099285
 Cone/Cup (Outer) M88048-M88010

4-SPEED AUTOMATIC TRANSMISSION**Torque Converter**

2006-2003 (4L60E, 4L65E)
 Seal 3227

Rear Seal/Ext. Housing

2006-2003 (4L60E, 4L65E)
 Seal 9613S

Selector Shaft Seal/Man. Shaft

2006-2003 (4L60E, 4L65E)
 Seal 8792S

CRANKSHAFT FRONT SEAL**8 Cylinder**

2006-2003 325/5.3L, 364/6.0L
 Seal Viton 100470
 Repair Sleeve KWK99210

CRANKSHAFT REAR SEAL**8 Cylinder**

2006-2003 325/5.3L, 364/6.0L
 Seal Viton 100470

CHEVROLET/GMC - Lt Truck - Uplander**FRONT WHEEL****FWD**

2008-2006
 Hub Unit Bearing HA590157[2]²⁵
 2005
 Hub Unit Bearing HA590093[2]⁴⁰

AWD

2006
 Hub Unit Bearing HA590157[2]²⁵
 2005
 Hub Unit Bearing HA590093[2]⁴⁰

REAR WHEEL**FWD**

2008-2006 (Exc. Indep. Rr. Susp.)
 Hub Unit Bearing HA590158[2]²⁵
 2006 (Indep. Rr. Susp.)
 Hub Unit Bearing HA590116[2]²⁵
 2005 (Exc. Indep. Rr. Susp.)
 Hub Unit Bearing HA590092[2]
 2005 (Indep. Rr. Susp.)
 Hub Unit Bearing HA590091[2]

REAR WHEEL**AWD**

2006
 Hub Unit Bearing HA590157[2]²⁵
 2005
 Hub Unit Bearing HA590093[2]⁴⁰

4-SPEED AUTOMATIC TRANSAXLE**Torque Converter / Frt Pump**

2008-2005 (4T65 E)
 Seal 4072N
 Repair Sleeve KWK99172

Output Shaft

2008-2005 (4T65 E)
 Seal (LH) 100165
 Repair Sleeve (LH) KWK99139
 Seal (RH) 3543
 Repair Sleeve (RH) KWK99139

Manual Shaft

2008-2005 (4T65 E)
 Seal 8792S

²⁵New Item, Check For Availability⁴⁰5 Stud.

Mfg./Year Model & Location Part No. Mfg./Year Model & Location Part No.

CHEVROLET/GMC - Lt Truck - Uplander (cont.)

CRANKSHAFT FRONT SEAL

6 Cylinder

2008-2005 213/3.5L, 237/3.9L
 Seal9845
 Repair SleeveKWK99176
 Harmnc Balancer Slvs 88176

CRANKSHAFT REAR SEAL

6 Cylinder

2008-2005 213/3.5L, 237/3.9L
 Seal4307V
 Seal PTFE H/D 5273
 Repair SleeveKWK99298

CHEVROLET/GMC TRUCK - 1/2 TON - Avalanche

FRONT WHEEL

RWD

2009-2007
 Hub Unit BearingSP450303[2]²⁵
 2006-2002
 Hub Unit BearingSP550305[2]⁸³
 Hub Unit BearingSP450301[2]⁸⁴

4WD

2009-2007
 Hub Unit BearingSP500301[2]²⁵
 2006-2002
 Hub Unit BearingSP500300[2]²⁵

REAR WHEEL

RWD

2009-2002
 Seal4762N[2]
 Cylindrical Bearing 513067[2]
 Bearing & Seal KitTRP59047[2]¹⁹

4WD

2009-2002
 Seal4762N[2]
 Cylindrical Bearing 513067[2]
 Bearing & Seal KitTRP59047[2]¹⁹

4WD FRONT AXLE

Differential

2006-2002
 Cone/CupLM501349-LM501314[2]

4WD FRONT AXLE

Pinion

2008-2007
 Seal710536
 Cone/Cup (Inner)NP457992-NP926068
 Cone/Cup (Outer) M88048-M88010
 2006-2002
 Seal710281
 Cone/Cup (Inner)NP457992-NP926068
 Cone/Cup (Outer) M88048-M88010

Differential: Output Shaft

2007-2002
 Seal710475[2]²⁵

REAR AXLE

Differential Rebuild Kit

2007-2002 (8.625" R.G.)
 Kit DRK321C
 2004-2002 (9.5" R.G.)
 KitDRK324B

Differential

2006-2002 (8.5", 8.625" R.G.)
 Set SET36[2]
 2005-2002 (9.5" R.G.)
 Set SET42[2]

Pinion

2008-2003 (8.625" R.G.)
 Seal710506
 Cone/Cup (Inner)NP544520-NP099285
 Cone/Cup (Outer) M88048-M88010
 2004-2003 (9.5" R.G.)
 Seal710507
 Cone/Cup (Inner) HM804846-HM804810
 Cone/Cup (Outer)HM88649-HM88610
 2002 (8.5" R.G.)
 Cone/Cup (Inner)NP457992-NP926068
 Cone/Cup (Outer) M88048-M88010

¹⁹Opt. Axle Rpr Brg. Replaces O.E. Brg & Seal Inventory ⁸⁴Reorder

²⁵New Item, Check For Availability

⁸³Deplete

Mfg./Year	Model & Location	Part No.	Mfg./Year	Model & Location	Part No.
CHEVROLET/GMC TRUCK - 1/2 TON - Avalanche (cont.)					

TRANSFER CASE**Input Shaft**

2007-2002 (New Process 246)	
Seal	472636
Ball Bearing	207
Ball Bearing	110CB
Ndle Bearing	B5020[2]
Ndle Bearing (Pilot)	FC66561

Front Output Shaft

2007-2002 (New Process 246)	
Seal	710495 ²⁵
Ball Bearing	207
Ball Bearing	110CB
Ndle Bearing (Pilot)	J2416

Rear Output Shaft

2006-2002 (New Process 246)	
Seal	710496
Ndle Bearing (Pilot)	B5020[2]

Oil Pump Housing

2006-2002 (New Process 246)	
Seal	341022

4-SPEED AUTOMATIC TRANSMISSION**Torque Converter**

2006-2002 (4L60E, 4L70E)	
Seal	3227

Rear Seal/Ext. Housing

2006-2002 (4L60E, 4L70E)	
Seal	9613S

Selector Shaft Seal/Man. Shaft

2008-2002 (4L60E, 4L70E)	
Seal	8792S
Repair Sleeve	KWK99050

CRANKSHAFT FRONT SEAL**8 Cylinder**

2009-2002 325/5.3L, 364/6.0L	
Seal Viton	100470
Repair Sleeve	KWK99210

CRANKSHAFT REAR SEAL**8 Cylinder**

2009-2002 325/5.3L, 364/6.0L	
Seal	100085

CHEVROLET/GMC TRUCK - 1/2 TON - Blazer/Jimmy (Full Size), C-10/15, K-10/15, R-10/15, Silverado/Sierra, Silverado/Sierra HD, Suburban, Tahoe/Yukon, V-10/15

FRONT WHEEL**RWD**

2009-2007 New Style	
Hub Unit Bearing	SP450303[2] ²⁵
2007-2001 Classic Style (Crew Cab/HD Brakes)	
Hub Unit Bearing	SP580310[2] ⁸⁴
2006-1999 Classic Style (Without Crew Cab/HD Brakes)	
Hub Unit Bearing	SP450301[2] ⁸⁴

FRONT WHEEL (cont.)**RWD (cont.)**

1999-1995 Old Style C Series (Diesel)	
Seal (Inner)	4740[2]
Set (Inner)	SET45[2]
Cone/Cup (Outer)	15103S-15243[2]
1999-1995 Old Style C Series (Gas)	
Seal (Inner)	4739[2]
Set (Inner)	SET5[2]
Set (Outer)	SET3[2]
1999-1992 Suburban/Tahoe/Yukon	
Seal (Inner)	4739[2]
Set (Inner)	SET5[2]
Set (Outer)	SET3[2]

²⁵New Item, Check For Availability⁸⁴Reorder

Mfg./Year	Model & Location	Part No.	Mfg./Year	Model & Location	Part No.
CHEVROLET/GMC TRUCK - 1/2 TON - Blazer/Jimmy (Full Size), C-10/15, K-10/15, R-10/15, Silverado/Sierra, Silverado/Sierra HD, Suburban, Tahoe/Yukon, V-10/15 (cont.)					

FRONT WHEEL (cont.)

RWD (cont.)

1994-1990	C1500 (H/D)	
Seal (Inner)	4739[2]
Set (Inner)	SET5[2]
Set (Outer)	SET3[2]
1991-1990	C1500 (L/D)	
Seal (Inner)	4739[2]
Set (Inner)	SET6[2]
Set (Outer)	SET3[2]
1990	R Series	
Seal	8871[2]
Set (Inner)	SET5[2]
Set (Outer)	SET3[2]

4WD

2009-2007	Classic Style	
Hub Unit Bearing	SP500301[2] ²⁵
2007-2001	Classic Style (Crew Cab/HD Brakes)	
Hub Unit Bearing	SP580304[2] ⁸³
Hub Unit Bearing	SP580310[2] ⁸⁴
2006-1999	(4-Wheel ABS)	
Hub Unit Bearing	SP500300[2] ²⁵
1999-1996	(2-Wheel ABS)	
Hub Unit Bearing (LH)	SP580303[2] ⁹⁵
Hub Unit Bearing (RH)	SP580302[2] ⁹⁵
1999-1995	(4-Wheel ABS)	
Hub Unit Bearing	SP550307[2] ⁸⁵
Sensor Kit	SK550301[2] ³⁹
1994-1992		
Seal	710106[2]
Hub Unit Bearing	515001[2] ⁹⁰
1991-1990	(Exc. Extended Cab)(L/D Suspension)	
Seal	710106[2]
Hub Unit Bearing	515002[2] ²⁹
1991-1990	(Extended Cab)(F44 H/D Suspension)	
Seal	710106[2]
Hub Unit Bearing	515001[2] ⁹⁰

AWD

2007		
Hub Unit Bearing	SP500301[2] ²⁵
2006-2001		
Hub Unit Bearing	SP500300[2] ²⁵

REAR WHEEL

RWD

2009-2007		
Seal	4762N[2]
Cylindrical Bearing	513067[2]
Bearing & Seal Kit	TRP59047[2] ¹⁹
2006-2001	(Exc. Quadrateer)(9.5" R.G.)	
Seal	710105[2]
Cylindrical Bearing	R1561TV[2]
Bearing & Seal Kit	TGM1561R[2] ¹⁹

REAR WHEEL (cont.)

RWD (cont.)

2006-1999	Classic Style (Exc. Quadrateer)(Exc. 9.5" R.G.)	
Seal	4762N[2]
Cylindrical Bearing	513067[2]
Bearing & Seal Kit	TRP59047[2] ¹⁹
2005-2002	Quadrateer (Exc. Crew Cab)	
Hub Unit Bearing	HA590003[2] ⁷⁸
1999-1990	(9.5" R.G.)	
Seal	710105[2]
Cylindrical Bearing	R1561TV[2]
Bearing & Seal Kit	TGM1561R[2] ¹⁹
1999-1990	Old Style	
Seal	4762N[2]
Cylindrical Bearing	513067[2]
Bearing & Seal Kit	TRP59047[2] ¹⁹

4WD

2009-2007		
Seal	4762N[2]
Cylindrical Bearing	513067[2]
Bearing & Seal Kit	TRP59047[2] ¹⁹
2006-2001	(Exc. Quadrateer)(9.5" R.G.)	
Seal	710105[2]
Cylindrical Bearing	R1561TV[2]
Bearing & Seal Kit	TGM1561R[2] ¹⁹
2006-1999	Classic Style (Exc. Quadrateer)(Exc. 9.5" R.G.)	
Seal	4762N[2]
Cylindrical Bearing	513067[2]
Bearing & Seal Kit	TRP59047[2] ¹⁹
1999-1990	(9.5" R.G.)	
Seal	710105[2]
Cylindrical Bearing	R1561TV[2]
Bearing & Seal Kit	TGM1561R[2] ¹⁹
1999-1990	Old Style	
Seal	4762N[2]
Cylindrical Bearing	513067[2]
Bearing & Seal Kit	TRP59047[2] ¹⁹

AWD

2006-2001	(4-Wheel ABS)	
Hub Unit Bearing	SP500300[2] ²⁵
2006-1999	Classic Style (Exc. Quadrateer)(Exc. 9.5" R.G.)	
Seal	4762N[2]
Cylindrical Bearing	513067[2]
Bearing & Seal Kit	TRP59047[2] ¹⁹
2005		
Seal	710105[2]
Cylindrical Bearing	R1561TV[2]
Bearing & Seal Kit	TGM1561R[2] ¹⁹

¹⁹Opt. Axle Rpr Brg. Replaces O.E. Brg & Seal ²⁵New Item, Check For Availability ²⁹Seal Not Serviceable. ³⁹Opt. Kit = Cable, Screw, Grease. ⁷⁸6 Stud, New Item. ⁸³Deplete Inventory

⁸⁴Reorder ⁸⁵6 Stud ~ Reorder ~ SP550307 Will Service Both Sides. ⁹⁰6 Stud. ⁹⁵8 Stud.

Mfg./Year	Model & Location	Part No.	Mfg./Year	Model & Location	Part No.
CHEVROLET/GMC TRUCK - 1/2 TON - Blazer/Jimmy (Full Size), C-10/15, K-10/15, R-10/15, Silverado/Sierra, Silverado/Sierra HD, Suburban, Tahoe/Yukon, V-10/15 (cont.)					

4WD FRONT AXLE**Axle Shaft**

2007-2005 (9.25" R.G.)	
Seal	450094[2]
Repair Sleeve	KWK99193[2]
2002-1999 (8.25" R.G.)	
Seal	710475[2] ²⁵
Ndle Bearing (Inner)	B2010[2]
Ndle Bearing (Outer)	SCH208[2]
1998 (8.25" R.G.)	
Ndle Bearing (Inner)	B2010[2]
Ndle Bearing (Outer)	B2012[2]
1997 (8.25" R.G.)	
Seal	710101[2]
Ndle Bearing (Inner)	
(1st Design)	B2012[2]
Ndle Bearing (Inner)	
(2nd Design)	B2010[2]
Ndle Bearing (Outer)	B2012[2]
1996-1990 (8.25" R.G.)	
Seal	710101[2]
Ndle Bearing (Inner)	B2012[2]
Ndle Bearing (Outer)	B2012[2]
1991-1990 (8.5" R.G.)	
Seal	5131[2]

Differential Rebuild Kit

2004-1997 (8.5" R.G.)	
Kit	DRK321
2001-1990 (Limited Slip Differential)(8.5" R.G.)	
Kit	DRK321D
1997-1990 (8.25" R.G.)	
Kit	DRK321A
1996-1990 (8.5" R.G.)	
Kit	DRK321

Differential

2006 (Crew Cab)	
Set	SET42[2]
2006 (Exc. 4 Dr. Crew Cab)	
Cone/Cup	LM501349-LM501314[2]
2005-1990 (8.5", 8.25" R.G.)	
Cone/Cup	LM501349-LM501314[2]
2004-1990 (7.25" R.G.)	
Set	SET11[2]

Pinion

2008-2005 (9.25" R.G.)	
Seal	710536
2008-2000 (8.25" R.G.)	
Seal	710536
Cone/Cup (Inner)	NP457992-NP926068
Cone/Cup (Outer)	M88048-M88010
2007-2001 (9.5" R.G.)	
Seal	710507

4WD FRONT AXLE (cont.)**Pinion (cont.)**

2006-2003 (Crew Cab)	
Seal	710281
Cone/Cup (Inner)	HM88649-HM88610
Cone/Cup (Outer)	HM804846-HM804810
2006-2003 (Exc. 4 Dr. Crew Cab)	
Seal	710281
Cone/Cup (Inner)	NP544520-NP099285
Cone/Cup (Outer)	M88048-M88010
2004-1990 (7.25" R.G.)	
Seal	710281
Cone/Cup (Inner)	M88048S-M88010
Cone/Cup (Outer)	M86649-M86610
1999-1990 (K Series)(8.25" R.G.)	
Seal	710281
Cone/Cup (Inner)	M802048-M802011
Cone/Cup (Outer)	M88048-M88010
Repair Sleeve	KWK99193
1991-1990 (V Series)(8.25" R.G.)	
Seal	8622
Cone/Cup (Inner)	M802048-M802011
Cone/Cup (Outer)	M88048-M88010
Repair Sleeve	KWK99193

Spindle Kit

1991-1990	
Bearing & Seal Kit	SBK1[2] ³³

Spindle

1991-1990	
Seal (Inner)	722108[2]
Ndle Bearing (Inner)	B2110[2]
Seal (Outer)	722109[2]

Differential: Output Shaft

2007-1999 (Exc. H/D)	
Seal	710475[2] ²⁵

REAR AXLE**Differential Rebuild Kit**

2007-2002 (8.625" R.G.)	
Kit	DRK321C
2007-1998 (9.5" R.G.)	
Kit	DRK324B
2000-1997 (8.5" R.G.)	
Kit	DRK321
1997-1990 (9.5" R.G.)(14 Bolt Rr End)	
Kit	DRK324
1996-1990 (8.5" R.G.)	
Kit	DRK321

Differential

2006-2001 (8.625" R.G.)	
Set	SET36[2]
2005-1990 (14 Bolt Cover)(9.5" R.G.)	
Set	SET42[2]

²⁵New Item, Check For Availability³³Opt. Kit = Brg B2110, Seals 722108 & 722109.

Mfg./Year	Model & Location	Part No.	Mfg./Year	Model & Location	Part No.
CHEVROLET/GMC TRUCK - 1/2 TON - Blazer/Jimmy (Full Size), C-10/15, K-10/15, R-10/15, Silverado/Sierra, Silverado/Sierra HD, Suburban, Tahoe/Yukon, V-10/15 (cont.)					

REAR AXLE (cont.)

Differential (cont.)

2000	(8.625" R.G.)	
Cone/Cup (1st Design)	LM501349-LM501314[2]
Set (2nd Design)	SET36[2]
1999-1990	(8.125", 8.5", 8.625" R.G.)	
Cone/Cup	LM501349-LM501314[2]

Pinion

2007-2001	(8.625" R.G.)	
Seal	710506
Cone/Cup (Inner)	NP544520-NP099285
Cone/Cup (Outer)	M88048-M88010
2007-1998	(9.5" R.G.)	
Seal	710507
Cone/Cup (Inner)	HM804846-HM804810
Cone/Cup (Outer)	HM88649-HM88610
Repair Sleeve	KWK99193
2000-1998	(8.5", 8.625" R.G.)	
Seal	710506
Cone/Cup (Inner)	NP457992-NP926068
Cone/Cup (Outer)	M88048-M88010
Repair Sleeve	KWK99193
1997	(8.5", 8.625" R.G.)	
Seal (2nd Design)	710506
Seal (1st Design)	2043
Cone/Cup (Inner) (2nd Design)	NP457992-NP926068
Cone/Cup (Inner) (1st Design)	M802048-M802011
Cone/Cup (Outer) (All)	M88048-M88010
1997-1990	(9.5" R.G.)	
Seal (1st Design)	3896
Seal (2nd Design)	710507
Cone/Cup (Inner)	HM804846-HM804810
Cone/Cup (Outer)	HM88649-HM88610
Repair Sleeve	KWK99193
1996-1990	(8.5" R.G.)	
Seal	2043
Cone/Cup (Inner)	M802048-M802011
Cone/Cup (Outer)	M88048-M88010

TRANSFER CASE REBUILD KIT

2000-1994	(New Process 241C)	
Kit	TCRK241D[2] ¹⁶
2000-1994	(New Process 243)	
Kit	TCRK243[2] ¹⁶
1993-1990	(New Process 241C)	
Kit	TCRK241[2]

TRANSFER CASE

Input Shaft

2007-1999	(New Process 246, 261C)	
Ndle Bearing	FC66561[2]
Seal	472636

TRANSFER CASE (cont.)

Input Shaft (cont.)

2005-1998	(New Process 136C)	
Seal	472636
Ndle Bearing (Pilot)	FC66561
Ball Bearing	110CB
Ball Bearing (Frt)	207
2005-1998	(New Process 236C)	
Seal	472636
Ndle Bearing (Pilot)	FC66561
Ndle Bearing (Rr)	B5020[2]
Ball Bearing	110CB
Ball Bearing (Frt)	207
2005-1991	(New Process 233C)	
Seal (Rr)	4333N
Ndle Bearing (Pilot)	FC66561
Ball Bearing (Frt)	206WB
Ball Bearing	110L

Front Output Shaft

2008-2003	(149, 241C, 243C, 261C, 263C)	
Seal	710495 ²⁵
Ndle Bearing	J2416
Ball Bearing	207
2005-1998	(226, 236, 246)	
Seal	710495 ²⁵
Ndle Bearing	J2416
2005-1995	(New Process 136C)	
Ndle Bearing	J2416
Ball Bearing	207
2005-1990	(New Process 233C)	
Ndle Bearing	J2416
Ball Bearing	206WB
Seal Viton	4813V
1997-1990		
Seal	3946
Repair Sleeve	KWK99187

Rear Output Shaft

2005-1998	(New Process 136C)	
Seal	710496
Ball Bearing	110CB
2005-1998	(New Process 236C)	
Seal	710496
Ndle Bearing (Pilot)	B5020[2]
Ball Bearing	110CB
2005-1991	(New Process 233C)	
Seal	4333N
2002-1999	(New Process 246)	
Ndle Bearing	B5020[2]
1999-1992	(New Process 241, 243)(2nd Design)	
Seal	4333N
Ball Bearing	207[2]
Ndle Bearing (Pilot)	B5020

¹⁶Obsolete ²⁵New Item, Check For Availability

Mfg./Year	Model & Location	Part No.	Mfg./Year	Model & Location	Part No.
CHEVROLET/GMC TRUCK - 1/2 TON - Blazer/Jimmy (Full Size), C-10/15, K-10/15, R-10/15, Silverado/Sierra, Silverado/Sierra HD, Suburban, Tahoe/Yukon, V-10/15 (cont.)					

TRANSFER CASE (cont.)**Rear Output Shaft (cont.)**

1991	(New Process 241)	
Seal (1st Design)	9449
Ball Bearing (1st Design)	1207L
Seal (2nd Design)	4333N
Ball Bearing	207
Seal Kit (1st Design)	5208 ⁶⁴
Ndle Bearing (Pilot)	B5020
1990	(New Process 241)	
Seal	9449
Ball Bearing	1207L[2]
Seal Kit	5208 ⁶⁴
Ndle Bearing (Pilot)	B5020

Oil Pump Housing

2005-1990	(New Process 233C, 236C)	
Seal	341022

3-SPEED AUTOMATIC TRANSMISSION**Torque Converter**

1990		
Seal	6712NA[2]
Repair Sleeve	KWK99187

Rear Seal/Ext. Housing

1990	(w/o THM350)	
Seal	9449
Seal Kit	5208 ⁶⁴

Selector Shaft Seal/Man. Shaft

1990		
Seal	8792S

4-SPEED AUTOMATIC TRANSMISSION**Torque Converter**

2006-1991	(4L80E)	
Seal	4598
Repair Sleeve	KWK99199
2006-1990	(THM700)(4L60 E)	
Seal	3227[2]
Repair Sleeve	KWK99174

Rear Seal/Ext. Housing

2006-1991	(4L80E)(Booted)	
Seal	4333N
2006-1991	(4L80E)(Exc. Booted)	
Seal	9449
Seal Kit	5208 ⁶⁴
2006-1990	(4L60, 4L60E, 4L65E)	
Seal	9613S[2]
Repair Sleeve	KWK99149
Seal Kit	5200 ⁶⁴

4-SPEED AUTOMATIC TRANSMISSION**Selector Shaft Seal/Man. Shaft**

2008-1990	(4L60, 4L60E, 4L65E, 4L70E, 4L80E, 4L85E)	
Seal	8792S
Repair Sleeve	KWK99050

6- SPEED AUTOMATIC TRANSMISSION**Rear Seal/Ext. Housing**

2008	(6L80)	
Seal	710533

CLUTCH - 6 CYLINDER**Pilot Bearing**

2002-1999	262/4.3L	
Ball Bearing	302CC
1998-1990	262/4.3L	
Ball Bearing	57080

CLUTCH - 8 CYLINDER**Pilot Bearing**

2002-2001	294/4.8L	
Ball Bearing	302CC
2000-1990	293/4.8, 305/5.0, 350/5.7, 379/6.2 (Diesel), 395/6.5 (Diesel), 454/7.4	
Ball Bearing	57080

CLUTCH - 6 CYLINDER**Release Bearing**

2002-1996	262/4.3L	
Bearing Assy	614174
1995-1990	262/4.3L (w/o cable activation)	
Bearing Assy	614109

CLUTCH - 8 CYLINDER**Release Bearing**

2002-1996	293/4.8, 305/5.0, 350/5.7	
Bearing Assy	614174
1995-1990	305/5.0 (w/o cable Cl.) 350/5.7, 379/6.2, 395/6.5, 454/7.4	
Bearing Assy	614109

4-SPEED MANUAL TRANSMISSION**Input Shaft**

1991-1990	(Muncie)(M20)(CH465)(2nd Design)	
Seal	481181N
Ball Bearing	211FFLE[2]
Repair Sleeve	KWK99162

⁶⁴Seal & Bushing Kit

Mfg./Year	Model & Location	Part No.	Mfg./Year	Model & Location	Part No.
CHEVROLET/GMC TRUCK - 1/2 TON - Blazer/Jimmy (Full Size), C-10/15, K-10/15, R-10/15, Silverado/Sierra, Silverado/Sierra HD, Suburban, Tahoe/Yukon, V-10/15 (cont.)					

4-SPEED MANUAL TRANSMISSION

(cont.)

Input Shaft (cont.)

1990	(Muncie M20, CH465)(1st Design)	
Seal	481181N
Ball Bearing	N1211L[2]
Repair Sleeve	KWK99162

Rear Output Shaft

1991-1990	(Muncie M20, CH465)	
Seal	410085
Ball Bearing	308FFL[2]

5-SPEED MANUAL TRANSMISSION

Transmission Rebuild Kit

2003-1995	(New Venture 3500)	
Kit	TRK235B
1998-1996	(New Venture 4500)	
Kit	TRK4500GMI
1995-1991	(New Venture 4500)	
Kit	TRK4500GM

Front Input Shaft

2007-1991	(New Process 3500)	
Seal	4529N
Ball Bearing	307FFLS[2]
Repair Sleeve	KWK99138
2000-1999	(New Process 4500)	
Seal	714655
Cone/Cup	M802048CP-NP728109[2]
1998-1991	(New Process 4500)	
Seal	714655[2]
Cone/Cup	M802048CP-M802011AP[2]
Repair Sleeve	KWK99133
1991-1990	(Getrag)	
Seal	4529N
Repair Sleeve	KWK99133

Front Countershaft

2007-1991	(New Process 3500)	
Ndle Bearing	FC68336[2]
2000-1991	(New Process 4500)	
Cone/Cup	LM102949CP-LM102910P[2]

Rear Countershaft

2000-1991	(New Process 4500)	
Cone/Cup	LM501349HP-LM501310P[2]

Rear Output Shaft

2007-1996	(New Process 3500)(2WD)	
Seal	4528N
Ball Bearing	307FF5[2]
2007-1991	(New Process 3500)(4WD)	
Seal	4532N
Ball Bearing	307FF5[2]

5-SPEED MANUAL TRANSMISSION

(cont.)

Rear Output Shaft (cont.)

2001-1996	(Getrag MG5)(New Venture Gear M50)	
Seal	410085
Ball Bearing	307FFLS[2]
Repair Sleeve	KWK99146
2000-1991	(New Process 4500)	
Seal	714654
Cone/Cup	M804049-M804010[2]
Repair Sleeve	KWK99199
1995-1992	(Getrag)(4WD)(MG5)	
Seal	410085
Ball Bearing	307FF[2]
Repair Sleeve	KWK99146
1995-1990	(Getrag MG5)(4WD)	
Seal	2692
Ball Bearing	307FF[2]
Repair Sleeve	KWK99187
1991-1990	(Getrag)(4WD)(MG5)	
Seal	4532N
Repair Sleeve	KWK99146

Extension Housing

1999-1991	(New Process 4500)(2WD)	
Ndle Bearing	B5020

A/C COMPRESSOR

2002-1990		
Ball Bearing	907257[2]
Ball Bearing (Frt Head)	S128

DRIVESHAFT SUPPORT

2007-1990	(Spicer 1280, 1310, 1330)(1.3780" Brg. I.D.)	
Ball Bearing	88107[2]
Hanger Bearing Assy	HB88107A[2]
1991-1990	(Spicer 1410)(4WD)(1.5748" Brg. I.D.)	
Hanger Bearing Assy	HB108[2]

POWER STEERING

Pitman Shaft

2000-1990		
Seal Kit	PSK1 ²⁴

Pump Shaft

2000-1990		
Seal	7013S[2]
Ball Bearing	8537[2] ¹⁶

¹⁶Obsolete ²⁴Opt. Kit = Seals 5683 & 5684. Not Sold Separately

Mfg./Year	Model & Location	Part No.	Mfg./Year	Model & Location	Part No.
CHEVROLET/GMC TRUCK - 1/2 TON - Blazer/Jimmy (Full Size), C-10/15, K-10/15, R-10/15, Silverado/Sierra, Silverado/Sierra HD, Suburban, Tahoe/Yukon, V-10/15 (cont.)					

CRANKSHAFT FRONT SEAL**6 Cylinder**

2007-1999	4.3 V6	
Seal	9845
Repair Sleeve	KWK99176
Harmnc Balancer Slvs	88176
2006-1999	4.8L	
Seal Viton	100470
1998-1990	4.3 V6	
Seal	9845
Repair Sleeve	KWK99176
Harmnc Balancer Slvs	88176

8 Cylinder

2008-1999	293/4.8L, 325/5.3L, 364/6.0L, 378/6.2L	
Seal Viton	100470
Repair Sleeve	KWK99210
2000-1990	283/4.6L, 307/5.0L, 327/5.4L, 350/5.7L, 4006/6.6L (GAS)	
Seal	9845
Repair Sleeve	KWK99176
1999-1990	379/6.2L (Diesel) 395/6.5L (Diesel), 454/7.4L (GAS)	
Seal	3945
Repair Sleeve	KWK99233

CRANKSHAFT REAR SEAL**6 Cylinder**

2009-1999	4.3 V6	
Seal Viton	4359V
Seal PTFE H/D	5274
Repair Sleeve	KWK99364
1998-1990	262/4.3L	
Seal Viton	4359V
Seal PTFE H/D	5274
Repair Sleeve	KWK99364

CRANKSHAFT REAR SEAL**8 Cylinder**

2009-2007	6.2L Gas	
Seal	100085
2009-1999	293/4.8L, 325/5.3L, 364/6.0L	
Seal	100085
2000-1990	305/5.0L, 350/5.7L	
Seal Viton	4359V
Seal PTFE H/D	5274
Repair Sleeve	KWK99364
1999-1992	379/6.2L (Diesel) 395/6.5L (Diesel) 395/6.5L (Turbo Diesel)	
Seal Viton	710258
Repair Sleeve	KWK99452
1991-1990	(379/6.2L Diesel)	
Seal	5163
1990	(454/7.4L)	
Seal	5072

CHEVROLET/GMC TRUCK - 1/2 TON - G10/G15, Express/Savana**FRONT WHEEL****RWD**

2009-2003		
Hub Unit Bearing	SP450301[2] ⁸⁴
2002-1993		
Seal (Inner)	4739[2]
Set (Inner)	SET5[2]
Set (Outer)	SET3[2]
1992-1990		
Seal (Inner)	8871[2]
Set (Inner)	SET5[2]
Set (Outer)	SET3[2]

FRONT WHEEL**AWD**

2009-2003		
Hub Unit Bearing	SP500300[2] ²⁵

REAR WHEEL**RWD**

2009-1996		
Seal	4762N[2]
Cylindrical Bearing	513067[2]
Bearing & Seal Kit	TRP59047[2] ¹⁹
1995-1990		
Seal	8835S[2]
Cylindrical Bearing	6408[2]
Bearing & Seal Kit	TRP1559TV[2] ¹⁹

¹⁹Opt. Axle Rpr Brg. Replaces O.E. Brg & Seal²⁵New Item, Check For Availability⁸⁴Reorder

Mfg./Year	Model & Location	Part No.	Mfg./Year	Model & Location	Part No.
CHEVROLET/GMC TRUCK - 1/2 TON - G10/G15, Express/Savana (cont.)					

REAR WHEEL

AWD

- 2009-2003
- Seal 4762N[2]
- Cylindrical Bearing 513067[2]
- Bearing & Seal Kit TRP59047[2]¹⁹

4WD FRONT AXLE

Axle Shaft

- 2008-2003
- Seal 710491[2]

Differential

- 2006-2003
- Set SET11[2]

Pinion

- 2008-2003
- Seal 710547
- Cone/Cup (Inner) M86649-M86610
- Cone/Cup (Outer) M86649-M86610

REAR AXLE

Differential Rebuild Kit

- 2007-2006 (8.625" R.G.)
- Kit DRK321C
- 2005-1998 (9.5" R.G.)
- Kit DRK324B
- 2002-1997 (8.5" R.G.)
- Kit DRK321C
- 1997-1990 (9.5" R.G.)
- Kit DRK324
- 1996-1990 (8.5" R.G.)
- Kit DRK321

Differential

- 2006-2001 (8.625" R.G.)
- Set SET36[2]
- 2005-1993 (9.5" R.G.)
- Set SET42[2]
- 2000 (8.625" R.G.)(1st Design)
- Cone/Cup LM501349-LM501310[2]
- 2000 (8.625" R.G.)(2nd Design)
- Set SET36[2]
- 1999-1990 (8.5", 8.625" R.G.)
- Cone/Cup LM501349-LM501314[2]

Pinion

- 2007-2001 (8.625" R.G.)
- Seal 710506
- Cone/Cup (Inner) NP544520-NP099285
- Cone/Cup (Outer) M88048-M88010
- Repair Sleeve KWK99193
- 2005-1998 (9.5" R.G.)
- Seal 710507
- Cone/Cup (Inner) HM804846-HM804810
- Cone/Cup (Outer) HM88649-HM88610
- Repair Sleeve KWK99193

REAR AXLE (cont.)

Pinion (cont.)

- 2002-1997 (8.5", 8.625" R.G.)
- Seal 710506
- Cone/Cup (Inner) NP457992-NP926068
- Cone/Cup (Outer) M88048-M88010
- Repair Sleeve KWK99193
- 1997-1993 (9.5" R.G.)
- Seal 3896
- Cone/Cup (Inner) HM804846-HM804810
- Cone/Cup (Outer) HM88649-HM88610
- Repair Sleeve KWK99193
- 1996-1990 (8.5" R.G.)
- Seal 2043
- Cone/Cup (Inner) M802048-M802011
- Cone/Cup (Outer) M88048-M88010
- Repair Sleeve KWK99193

TRANSFER CASE

Front Output Shaft

- 2009-2003
- Seal 4503N

3-SPEED AUTOMATIC TRANSMISSION

Torque Converter

- 1992-1990
- Seal 6712NA[2]
- Repair Sleeve KWK99187

Rear Seal/Ext. Housing

- 1990
- Seal 9449
- Seal Kit 5208⁶⁴

Selector Shaft Seal/Man. Shaft

- 1990
- Seal 8792S

4-SPEED AUTOMATIC TRANSMISSION

Torque Converter

- 2008-1990 (4L60, 4L60E, THM700R4)
- Seal 3227[2]
- Repair Sleeve KWK99174
- 2006-1991 (4L80E)
- Seal 4598
- Repair Sleeve KWK99199

Rear Seal/Ext. Housing

- 2006-1991 (4L80E)(Booted)
- Seal 4333N
- 2006-1991 (4L80E)(Exc. Booted)
- Seal 9449
- Seal Kit 5208⁶⁴
- 2006-1990 (4L60, 4L60E, 4L65E)
- Seal 9613S[2]
- Repair Sleeve KWK99149
- Seal Kit 5200⁶⁴

¹⁹Opt. Axle Rpr Brg. Replaces O.E. Brg & Seal

⁶⁴Seal & Bushing Kit

Mfg./Year	Model & Location	Part No.	Mfg./Year	Model & Location	Part No.
CHEVROLET/GMC TRUCK - 1/2 TON - G10/G15, Express/Savana (cont.)					

4-SPEED AUTOMATIC TRANSMISSION**Selector Shaft Seal/Man. Shaft**

2008-1990	
Seal	8792S
Repair Sleeve	KWK99050

CLUTCH - 6 CYLINDER**Pilot Bearing**

2000-1990	
Ball Bearing	57080

CLUTCH - 8 CYLINDER**Pilot Bearing**

2002-1990	
Ball Bearing	57080

CLUTCH**Release Bearing**

2000-1990	(Hyd. Mechanism)
Bearing Assy	614174

DRIVESHAFT SUPPORT

1990	
Ball Bearing	88107[2]
Hanger Bearing Assy	HB88107A[2]

POWER STEERING**Pitman Shaft**

2000-1990	
Seal Kit	PSK1 ²⁴

Pump Shaft

2000-1990	
Seal	7013S[2]
Ball Bearing	8537[2] ¹⁶

CRANKSHAFT FRONT SEAL**6 Cylinder**

2009-1990	194/3.2L, 230/3.8L, 250/4.1L, 262/4.3L, 292/4.8L
Seal	9845
Repair Sleeve	KWK99176
Harmnc Balancer Slvs	88176

CRANKSHAFT FRONT SEAL**8 Cylinder**

2008-2003	325/ 5.3L
Seal Viton	100470
Repair Sleeve	KWK99210
2002-1990	307/5.0L, 350/5.7L, 400/6.6L
Seal	9845
Repair Sleeve	KWK99176

CRANKSHAFT REAR SEAL**6 Cylinder**

2009-1990	4.3L
Seal Viton	4359V
Seal PTFE H/D	5274
Repair Sleeve	KWK99364

8 Cylinder

2009-2003	5.3L
Seal	100085
2002-1990	305/5.0L, 350/5.7L
Seal Viton	4359V
Seal PTFE H/D	5274
Repair Sleeve	KWK99364

CHEVROLET/GMC TRUCK - 3/4 TON - Avalanche**FRONT WHEEL****RWD**

2005-2004	
Hub Unit Bearing	SP580306[2] ⁸³
Hub Unit Bearing	SP580310[2] ⁸⁴

FRONT WHEEL**4WD**

2006-2002	
Hub Unit Bearing	SP580304[2] ⁸³
Hub Unit Bearing	SP580310[2] ⁸⁴

¹⁶Obsolete
⁸⁴Reorder

²⁴Opt. Kit = Seals 5683 & 5684. Not Sold Separately

⁸³Deplete Inventory

CHEVROLET/GMC TRUCK - 3/4 TON - Avalanche (cont.)

REAR WHEEL

RWD

- 2005-2004 (10.5", 11.5" R.G.)
 - Seal SL260002[2]²⁵
 - Cone/Cup (Inner) 387AS-382A[2]
 - Set (Outer) SET38[2]
- 2005-2004 (9.5" R.G.)
 - Seal 710105[2]
 - Cylindrical Bearing R1561TV[2]¹⁹
 - Bearing & Seal Kit TGM1561R[2]¹⁹

4WD

- 2006-2003 (10.5", 11.5" R.G.)
 - Seal SL260002[2]²⁵
 - Cone/Cup (Inner) 387AS-382A[2]
 - Set (Outer) SET38[2]
- 2006-2002 (9.5" R.G.)
 - Seal 710105
 - Cylindrical Bearing R1561TV[2]¹⁹
 - Bearing & Seal Kit TGM1561R[2]¹⁹

4WD FRONT AXLE

Differential Rebuild Kit

- 2006-2003
 - Kit DRK324A

Differential

- 2006-2003 (9.25" R.G.)
 - Set SET42[2]

Pinion

- 2006-2002 (9.25" R.G.)
 - Seal 710281
 - Cone/Cup (Inner) HM804846-HM804810
 - Cone/Cup (Outer) HM88649-HM88610

REAR AXLE

Differential Rebuild Kit

- 2004-2002 (9.5" R.G.)
 - Kit DRK324B

Differential

- 2006-2002 (10.5" R.G.)
 - Set SET38[2]
- 2005-2003 (9.5" R.G.)
 - Set SET42[2]
- 2005-2002 (10.5" R.G.)(H/D)
 - Cone/Cup 387AS-382A[2]

REAR AXLE

Pinion

- 2006-2002 (10.5" R.G.)
 - Seal 710508
 - Cone/Cup (Inner) HM903249-HM903210
 - Cone/Cup (Outer) (L/D) NP457992-NP926068
 - Cone/Cup (Outer) (H/D) NP544520-NP099285
 - Cylindrical Bearing (Pilot) R1581TV
- 2004-2003 (9.5" R.G.)
 - Seal 710507
 - Cone/Cup (Inner) HM804846-HM804810
 - Cone/Cup (Outer) HM88649-HM88610

TRANSFER CASE

Input Shaft

- 2006-2002 (New Process 246)
 - Seal 472636
 - Ball Bearing 207
 - Ball Bearing 110CB
 - Ndle Bearing B5020[2]
 - Ndle Bearing (Pilot) FC66561

Front Output Shaft

- 2006-2002 (New Process 246)
 - Seal 710495²⁵
 - Ball Bearing 207
 - Ball Bearing 110CB
 - Ndle Bearing (Pilot) J2416

Rear Output Shaft

- 2006-2002 (New Process 246)
 - Seal 710496
 - Ndle Bearing (Pilot) B5020[2]

Oil Pump Housing

- 2006-2002 (New Process 246)
 - Seal 341022

4-SPEED AUTOMATIC TRANSMISSION

Torque Converter

- 2006-2002 (4L80E)
 - Seal 4598

Rear Seal/Ext. Housing

- 2006-2002 (4L80E)(Booted)
 - Seal 4333N
- 2006-2002 (4L80E)(Exc. Booted)
 - Seal 9449

Selector Shaft Seal/Man. Shaft

- 2006-2002 (4L85E)
 - Seal 8792S
 - Repair Sleeve KWK99050

¹⁹Opt. Axle Rpr Brg. Replaces O.E. Brg & Seal

²⁵New Item, Check For Availability

CHEVROLET/GMC TRUCK - 3/4 TON - C-20/25, K-20/25, R-20/25, Silverado/Sierra, Suburban, Silverado 2500 HD, V-20/25, Yukon XL 2500**FRONT WHEEL****RWD**

2009-2008 (SRW)	
Hub Unit Bearing	SP580312[2] ²⁵
2007-2006 Classic Style	
Hub Unit Bearing	SP580305[2] ⁸³
Hub Unit Bearing	SP580310[2] ⁸⁴
2005-2001 Classic Style Silverado/Sierra (2" Body Raise)(H/D Series)	
Hub Unit Bearing	SP580305[2] ⁸³
Hub Unit Bearing	SP580310[2] ⁸⁴
2005-2001 Classic Style Silverado/Sierra, Suburban, Yukon XL (Exc. 2" Body Raise)	
Hub Unit Bearing	SP580306[2] ⁸³
Hub Unit Bearing	SP580310[2] ⁸⁴
2000-1999 Classic Style Silverado/Sierra, Suburban, Tahoe, Yukon, Yukon XL	
Hub Unit Bearing	SP580307[2] ⁸³
Hub Unit Bearing	HA590352[2] ⁸⁴
2000-1992 Old Style C (7200 GVW)	
Seal (Inner)	4739[2]
Set (Inner)	SET5[2]
Set (Outer)	SET3[2]
2000-1992 Old Style C (8600 GVW)	
Seal (Inner)	4740[2]
Set (Inner)	SET45[2]
Cone/Cup (Outer)	15103S-15243[2]
1991-1990 (8600 GVW)	
Seal (Inner)	8974S[2]
Set (Inner)	SET45[2]
Cone/Cup (Outer)	15103S-15243[2]
1991-1990 (7200 GVW)	
Seal (Inner)	4739[2]
Set (Inner)	SET5[2]
Set (Outer)	SET3[2]

4WD

2009-2008 (SRW)	
Hub Unit Bearing	SP580312[2] ²⁵
2007-1999 Classic Style Silverado/Sierra, Suburban, Tahoe, Yukon, Yukon XL	
Hub Unit Bearing	SP580304[2] ⁸³
Hub Unit Bearing	SP580310[2] ⁸⁴
2000-1996 Old Style C/K Series	
Hub Unit Bearing (RH)	SP580302 ⁹⁵
Hub Unit Bearing (LH)	SP580303 ⁹⁵
Sensor Kit (RH)	SK580302 ³⁹
Sensor Kit (LH)	SK580303 ³⁹
Seal	710103[2]
2000-1995 Old Style C/K Series	
Seal (RH)	710103[2]
Hub Unit Bearing (RH)	SP550300 ⁹⁶
Hub Unit Bearing (LH)	SP550301 ⁹⁶
Hub Unit Bearing (RH)	SP550307 ⁸⁵
Hub Unit Bearing (LH)	SP550307 ⁸⁵
Sensor Kit	SK550301[2] ³⁹

FRONT WHEEL (cont.)**4WD (cont.)**

1995 Pickup, Suburban, Tahoe (8 Stud Wheel)(ABS)	
Hub Unit Bearing (LH)	SP580301 ⁹⁵
Hub Unit Bearing (RH)	SP580300 ⁹⁵
Sensor Kit (RH)	SK580300 ³⁹
Sensor Kit (LH)	SK580301 ³⁹
Seal	710103[2]
1994-1992 Pickup, Suburban (8600 GVW)(8 Stud Wheel)	
Hub Unit Bearing	HA591339[2] ⁸⁷
1994-1990 Pickup, Suburban (6 Stud Wheel)	
Hub Unit Bearing	515001[2] ⁹⁰
1993-1990 (Exc. Hub Assembly)	
Seal (Inner) (1st Design)	416273[2]
Cone/Cup (Inner) (1st Design)	368A-362A[2]
Seal (Inner) (2nd Design)	471271[2]
Cone/Cup (Inner) (2nd Design)	LM104949-JLM104910[2]
Set (Outer)	SET45[2]
1991-1990 Pickup, Suburban (8600 GVW)(8 Stud Wheel)(Non-ABS)	
Hub Unit Bearing	HA591339[2] ⁸⁷

REAR WHEEL**RWD**

2009-1999 (10.5", 11.5" R.G.)	
Seal	SL260002[2] ²⁵
Cone/Cup (Inner)	387AS-382A[2]
Set (Outer)	SET38[2]
2005-2003 QuadraSteer	
Hub Unit Bearing	HA590004[2] ⁷⁵
2005-1990 C Series, Yukon XL, Silverado/Sierra, Suburban (9.5" R.G.)	
Seal	710105[2]
Cylindrical Bearing	R1561TV[2]
Bearing & Seal Kit	TGM1561R[2] ¹⁹
2000-1990 (Drum ~ Rear Wheel)(10.5" R.G.)	
Seal	2081[2]
Cone/Cup (Inner)	387AS-382A[2]
Set (Outer)	SET38[2]
Repair Sleeve	KWK99282[2]
1991-1990 R Series (9.5" R.G.)	
Seal	3747[2]
Cylindrical Bearing	R1561TV[2]
Bearing & Seal Kit	TGM1561R[2] ¹⁹

4WD

2009-1999 (10.5", 11.5" R.G.)	
Seal	SL260002[2] ²⁵
Cone/Cup (Inner)	387AS-382A[2]
Set (Outer)	SET38[2]

¹⁹Opt. Axle Rpr Brg. Replaces O.E. Brg & Seal Cable, Screw, Grease. ⁷⁵8 Stud, New Item. ⁸³Deplete Inventory ⁸⁴Reorder Stud ~ Reorder ~ SP550307 Will Service Both Sides. ⁹⁵8 Stud. ⁹⁶6 Stud ~ Deplete Inventory.

²⁵New Item, Check For Availability ³⁹Opt. Kit = ⁸⁵6 ⁸⁷Hub Unit Only. W/O Rotor

⁹⁰6 Stud.

Mfg./Year	Model & Location	Part No.	Mfg./Year	Model & Location	Part No.
CHEVROLET/GMC TRUCK - 3/4 TON - C-20/25, K-20/25, R-20/25,					
Silverado/Sierra, Suburban, Silverado 2500 HD, V-20/25, Yukon XL 2500 (cont.)					

REAR WHEEL (cont.)

4WD (cont.)

2008-1990	K Series, Yukon XL, Silverado/Sierra, Suburban (9.5" R.G.)	
Seal	710105[2]
Cylindrical Bearing	R1561TV[2]
Bearing & Seal Kit	TGM1561R[2] ¹⁹
2005-2003	Quadrasteer	
Hub Unit Bearing	HA590004[2] ⁷⁵
1999-1990	(10.5" R.G.)	
Seal	2081[2]
Cone/Cup (Inner)	387AS-382A[2]
Set (Outer)	SET38[2]
1991-1990	V Series (9.5" R.G.)	
Seal	3747[2]
Cylindrical Bearing	R1561TV[2]
Bearing & Seal Kit	TGM1561R[2] ¹⁹

4WD FRONT AXLE

Differential Rebuild Kit

2004-1997	(8.5" R.G.)	
Kit	DRK321C
2002-1990	(9.25" R.G.)	
Kit	DRK324A
1996-1990	(8.5" R.G.)	
Kit	DRK321

Differential

2006-1990	(9.25" R.G.)	
Seal	450094[2]
Set	SET42[2]
2000-1990	(8.25", 8.5" R.G.)(GM Axle)	
Cone/Cup	LM501349-LM501314[2]

Pinion

2008-2001	(9.25" R.G.)	
Seal	710536
Cone/Cup (Inner)	HM804846-HM804810
Cone/Cup (Outer)	HM88649-HM88610
2000-1990		
Seal (8.25" & 9.25" R.G.)	710281
Seal (8.5" R.G.)	8622
Cone/Cup (Inner)	M802048-M802011
Cone/Cup (Outer)	M88048-M88010
Cone (Outer) (8.25" R.G.)(Opt.)	M88048A
Cone/Cup (Inner)	HM804846-HM804810
Cone/Cup (Outer)	HM88649-HM88610

4WD FRONT AXLE

Spindle Kit

1991-1990	
Bearing & Seal Kit SBK1[2] ³³

Spindle

1991-1990	
Seal (Inner) 722108[2]
Ndle Bearing (Inner) B2110[2]
Seal (Outer) 722109[2]

Differential: Output Shaft

2007-1999	
Seal 710497[2] ²⁵

REAR AXLE

Differential Rebuild Kit

2007-1998	(9.5" R.G.)(14 Bolt Rr End)	
Kit	DRK324B
2007-1997	(10.5" R.G.)	
Kit	DRK325B
2004-1997	(8.5" R.G.)	
Kit	DRK321C
1997-1990	(9.5" R.G.)	
Kit	DRK324
1996-1990	(10.5" R.G.)(2nd Design)(Prod. From Early 1988 On)	
Kit	DRK325A
1996-1990	(8.5" R.G.)	
Kit	DRK321

Differential

2006-1990	(9.5" R.G.)	
Set	SET42[2]
2006-1990	(10.5" R.G.)	
Cone/Cup	387AS-382A[2]
2000-1990	(8.5" R.G.)	
Cone/Cup	LM501349-LM501314[2]

Pinion

2007-2005	(10.5" R.G.)(H/D)	
Seal	710508
Cone/Cup (Inner)	HM807046-HM807010
Cone/Cup (Outer)	NP457992-NP926068
Cylindrical Bearing	R1581TV[2]
2007-1998	(9.5" R.G.)	
Seal	710507
Cone/Cup (Inner)	HM804846-HM804810
Cone/Cup (Outer)	HM88649-HM88610
2004-2003	(10.5", 11.5" R.G.)	
Seal	710508
Cone/Cup (Inner)	HM903249-HM903210
Cone/Cup (Outer)	NP544520-NP099285
Cylindrical Bearing	R1581TV[2]

¹⁹Opt. Axle Rpr Brg. Replaces O.E. Brg & Seal Brg B2110, Seals 722108 & 722109.

²⁵New Item, Check For Availability

³³Opt. Kit =

⁷⁵8 Stud, New Item.

Mfg./Year	Model & Location	Part No.	Mfg./Year	Model & Location	Part No.
CHEVROLET/GMC TRUCK - 3/4 TON - C-20/25, K-20/25, R-20/25,					
Silverado/Sierra, Suburban, Silverado 2500 HD, V-20/25, Yukon XL 2500 (cont.)					

REAR AXLE (cont.)**Pinion (cont.)**

2002-1997	(8.5", 8.625" R.G.)	
Seal	710506
Cone/Cup (Inner)	NP457992-NP926068
Cone/Cup (Outer)	M88048-M88010
Repair Sleeve	KWK99193
2002-1990	(10.5" R.G.)	
Seal	2286
Cone/Cup (Inner)	HM903249-HM903210
Cone/Cup (Outer)	M802048-M802011
Cylindrical Bearing	R1581TV[2]
1997-1990	(9.5" R.G.)	
Seal	3896
Cone/Cup (Inner)	HM804846-HM804810
Cone/Cup (Outer)	HM88649-HM88610

TRANSFER CASE REBUILD KIT

2000-1994	(New Process 241C)	
Kit	TCRK241D ¹⁶
2000-1994	(New Process 243C)	
Kit	TCRK243 ¹⁶
1993-1990	(New Process 241C)	
Kit	TCRK241D ¹⁶

TRANSFER CASE**Input Shaft**

2007-2003	(New Process 246)	
Seal	472636
2007-1999	(New Process 261C)	
Seal	472636
2000-1995	(New Process 241, 243)	
Seal (O.E.)	3173
Ball Bearing	110L
Seal (Opt)	710928
Repair Sleeve	KWK99193
Ndle Bearing (Pilot)	FC66561
1994	(New Process 241)(1st Design)	
Seal (O.E.)	3173
Ball Bearing	N5210KLB
Seal (Opt)	710298
Repair Sleeve	KWK99193
Ndle Bearing (Pilot)	FC66561
1994	(New Process 241)(2nd Design)	
Seal (O.E.)	3173
Ball Bearing	110L
Seal (Opt)	710298
Repair Sleeve	KWK99193
Ndle Bearing (Pilot)	FC66561
1993-1991	(New Process 241)	
Seal (O.E.)	3173
Ball Bearing	N5210KLB
Seal (Opt)	710298
Repair Sleeve	KWK99193
Ndle Bearing (Pilot)	FC66561
1990	(New Process 241)	
Seal (O.E.)	3173
Ball Bearing	N5210KLB
Seal (Opt)	710298
Repair Sleeve	KWK99193
Ndle Bearing (Pilot)	SCH1810

Front Output Shaft

2007-1998	(New Process 241, 243)	
Seal	710495 ²⁵
Ball Bearing	207
Ndle Bearing (Pilot)	J2416
Repair Sleeve	KWK99187
1997-1990	(New Process 241, 243)	
Seal	3946
Ball Bearing	207
Repair Sleeve	KWK99187
Ndle Bearing (Pilot)	J2416

Rear Output Shaft

2000-1991	(New Process 241, 243)	
Seal	4333N
Ball Bearing	207
Ndle Bearing (Pilot)	B5020
1991	(New Process 241)	
Seal (2nd Design)	4333N
Seal (1st Design)	9449
Ball Bearing	207
Ndle Bearing (Pilot)	B5020
1990	(New Process 241)	
Seal	9449
Ball Bearing	207[2]
Seal Kit	5208 ⁶⁴
Ndle Bearing (Pilot)	B5020[2]

Oil Pump Housing

2000-1990	(New Process 208, 241, 243)	
Seal	341022
Repair Sleeve	KWK99225

3-SPEED AUTOMATIC TRANSMISSION**Torque Converter**

1990		
Seal	6712NA[2]
Repair Sleeve	KWK99187

Rear Seal/Ext. Housing

1990	(THM400)(1.890" Shaft)	
Seal	9449[2]
Seal Kit	5208 ⁶⁴

Selector Shaft Seal/Man. Shaft

1990		
Seal	8792S[2]

4-SPEED AUTOMATIC TRANSMISSION**Torque Converter**

2006-1993	(4L60, 4L60E, 4L65E)	
Seal	3227
Repair Sleeve	KWK99174
2006-1991	(4L80E)(THMR2)	
Seal	4598
Repair Sleeve	KWK99199
1992-1990	(THM700)(4L60 E)	
Seal	3227[2]
Repair Sleeve	KWK99174

¹⁶Obsolete²⁵New Item, Check For Availability⁶⁴Seal & Bushing Kit

Mfg./Year	Model & Location	Part No.	Mfg./Year	Model & Location	Part No.
CHEVROLET/GMC TRUCK - 3/4 TON - C-20/25, K-20/25, R-20/25,					
Silverado/Sierra, Suburban, Silverado 2500 HD, V-20/25, Yukon XL 2500 (cont.)					

4-SPEED AUTOMATIC TRANSMISSION

Rear Seal/Ext. Housing

2006-1993 (4L60, 4L60E, 4L65E)	
Seal	9613S
2006-1991 (4L80E)(THMR2)(Booted)	
Seal	4333N
2006-1991 (4L80E)(THMR2)(Exc. Booted)	
Seal	9449
Seal Kit	5208 ⁶⁴
1992-1990 (THM700 R4)	
Seal	9613S[2]
Repair Sleeve	KWK99149
Seal Kit	5200 ⁶⁴

Selector Shaft Seal/Man. Shaft

2009-1990	
Seal	8792S
Repair Sleeve	KWK99050

5-SPEED AUTOMATIC TRANSMISSION

Rear Seal/Ext. Housing

2007-2001 (Allison 1000, 1000/M74)	
Seal	415988

Selector Shaft Seal/Man. Shaft

2007-2001 (Allison 1000, 1000/M74)	
Seal	8792S
Repair Sleeve	KWK99050

6-SPEED AUTOMATIC TRANSMISSION

Selector Shaft Seal/Man. Shaft

2009-2007 (6L90)	
Seal	8792S

CLUTCH

Pilot Bearing

2002-2001 346/6.0, 496/8.1	
Ball Bearing	302CC
2000-1994 (Gas)	
Ball Bearing	57080
2000-1990 (Diesel)(TurboDiesel)	
Ball Bearing	57080
1993-1990 (Gas)	
Bushing H/D	PB656HD

CLUTCH - 6 CYLINDER

Release Bearing

1995-1990 (Hyd.)	
Bearing Assy	614109

CLUTCH - 8 CYLINDER

Release Bearing

2002-1996	
Bearing Assy	614174
1995-1990 (w/o cable Cl.)	
Bearing Assy	614109

4-SPEED MANUAL TRANSMISSION

Input Shaft

1991 (CH465)	
Seal	481181N
Ball Bearing	211FFLE[2]
Repair Sleeve	KWK99162
1990 (CH465)(1st Design)	
Seal	481181N
Ball Bearing	N1211L[2]
Repair Sleeve	KWK99162
1990 (CH465)(2nd Design)	
Seal	481181N
Ball Bearing	211FFLE[2]
Repair Sleeve	KWK99162

Rear Output Shaft

1991-1990 (CH465)	
Seal	410085
Ball Bearing	308FFL[2]

5-SPEED MANUAL TRANSMISSION

Transmission Rebuild Kit

2002-1996 (New Venture 4500)	
Kit	TRK4500GMI
1999-1991 (New Venture 3500)	
Kit	TRK235B
1995-1991 (New Venture 4500)	
Kit	TRK4500GM

Front Input Shaft

2007-1999 (New Process 4500, 4500HD)	
Seal	714655
Cone/Cup	M802048CP-NP728109[2]
Repair Sleeve	KWK99133
1998-1991 (New Process 3500)	
Seal	4529N
Ball Bearing	307FFLS[2]
Repair Sleeve	KWK99138
1998-1991 (New Process 4500)	
Seal	714655
Cone/Cup	M802048CP-M802011AP[2]
Repair Sleeve	KWK99133
1991-1990 (Getrag MG5)(4WD)	
Seal	4529N
Repair Sleeve	KWK99138
1991-1990 (Getrag)(4WD)	
Seal	4529N
Repair Sleeve	KWK99133

Front Countershaft

2007-1991 (New Process 4500)	
Cone/Cup	LM102949CP-LM102910P[2]

⁶⁴Seal & Bushing Kit

Mfg./Year	Model & Location	Part No.	Mfg./Year	Model & Location	Part No.
-----------	------------------	----------	-----------	------------------	----------

**CHEVROLET/GMC TRUCK - 3/4 TON - C-20/25, K-20/25, R-20/25,
Silverado/Sierra, Suburban, Silverado 2500 HD, V-20/25, Yukon XL 2500 (cont.)**

5-SPEED MANUAL TRANSMISSION

Rear Countershaft

2007-1991 (New Process 4500)
Cone/Cup LM501349HP-LM501310P[2]

Rear Output Shaft

2007-1991 (New Process 4500)
Seal 714654
Cone/Cup M804049-M804010[2]
2004-2001 (New Process 4500HD)
Seal 714670
Cone/Cup M804049-M804010[2]
1998-1996 (New Process 3500)(4WD)
Seal 4528N
Ball Bearing 307FFTB[2]
1998-1991 (New Process 3500)(4WD)
Seal 4532N
Ball Bearing 307FFTB[2]
1995-1991 (N.P.3500 # C320844)(4WD)
Seal 4530
Ball Bearing 307FFTB[2]
1995-1991 (N.P.3500 Exc. #
C320844)(4WD)
Seal 4528N
Ball Bearing 307FFTB[2]
1991-1990 (Getrag)
Seal 4530

Extension Housing

2007-1991 (New Process 4500)(2WD)
Ndlle Bearing B5020[2]

A/C COMPRESSOR

2002-1990
Ball Bearing 907257[2]
Ball Bearing (Frt Head) S128

ALTERNATOR

2002-1990 (Delco 100, 124, 140, 145
Amp.)
Ball Bearing (Rear End) 100CCAB
1991-1990 (Delco 56, 66, 78 Amp.)
Ball Bearing (Drive End) 203FF
1991-1990 (Delco 37, 42, 55, 56, 61, 63,
66, 78 Amp.)
Ball Bearing (Rear End) MNJ471S

DRIVESHAFT SUPPORT

2007-1990 (1.378" 35mm Brg. I.D.)
Ball Bearing 88107[2]
Hanger Bearing Assy HB88107A[2]
2000-1991 (1.57" 40mm Brg. I.D.)(6.625
Flg Mtg Base)
Hanger Bearing Assy HB88508A

POWER STEERING

Pitman Shaft

1991-1990
Seal (Inner) 471413
Seal (Outer) 7412S
Seal Kit PSK1²⁴

Pump Shaft

2002-1990
Seal 480821

Worm Shaft

1991-1990
Seal 222025

CRANKSHAFT FRONT SEAL

6 Cylinder

1995-1990 250/4.1L, 262/4.3L, 292/4.8L
Seal 9845
Repair Sleeve KWK99176
Harmnc Balancer Slvs 88176

8 Cylinder

2008-1999 294/4.8L, 325/5.3L, 364/6.0L
Seal Viton 100470
Repair Sleeve KWK99210
2004-2001 402/6.6L (Diesel)
Seal 3945
Repair Sleeve KWK99233
Harmnc Balancer Slvs 88233
2000-1990 379/6.2L (Diesel) 395/6.5L
(Diesel), 454/7.4L (GAS)
Seal 3945
Repair Sleeve KWK99233
2000-1990 283/4.6L, 307/5.0L, 327/5.4L,
350/5.7L, 4006/6.6L (GAS)
Seal 9845
Repair Sleeve KWK99176

CRANKSHAFT REAR SEAL

6 Cylinder

1995-1990
Seal Viton 4359V
Seal PTFE H/D 5274
Repair Sleeve KWK99364

8 Cylinder

2009-2001 402/6.6L (Diesel)
Seal Viton 710258
Repair Sleeve KWK99452
2009-1999 293/4.8L, 325/5.3L, 364/6.0L
Seal 100085
2000-1992 379/6.2L (Diesel), 395/6.5L
(Diesel)
Seal Viton 710258
Repair Sleeve KWK99452
2000-1991 (454/7.4L)
Seal Viton 2261
Repair Sleeve KWK99435

²⁴Opt. Kit = Seals 5683 & 5684. Not Sold Separately

Mfg./Year Model & Location Part No. Mfg./Year Model & Location Part No.

CHEVROLET/GMC TRUCK - 3/4 TON - C-20/25, K-20/25, R-20/25, Silverado/Sierra, Suburban, Silverado 2500 HD, V-20/25, Yukon XL 2500 (cont.)

CRANKSHAFT REAR SEAL (cont.)

8 Cylinder (cont.)

2000-1990	305/5.0L, 350/5.7L	
Seal Viton	4359V
Seal PTFE H/D	5274
Repair Sleeve	KWK99364
1991-1990	(379/6.2L Diesel)	
Seal	5163

CHEVROLET/GMC TRUCK - 3/4 TON - G20/G25, Express/Savana

FRONT WHEEL

RWD

2009-2006		
Hub Unit Bearing	HA590352[2] ⁸⁴
2005-2003	(7300 GVWR)	
Hub Unit Bearing	SP550305[2] ⁸³
Hub Unit Bearing	SP450301[2] ⁸⁴
2005-2003	(8500 & 8600 GVWR)	
Hub Unit Bearing	HA590352[2] ⁸⁴
2002-1996	(H/D Brks.)	
Seal (Inner)	4740[2]
Set (Inner)	SET45[2]
Cone/Cup (Outer)	15103S-15243[2]
2002-1991	(L/D)	
Seal (Inner)	4739[2]
Set (Inner)	SET5[2]
Set (Outer)	SET3[2]
1995-1990	(H/D Brks.)	
Seal (Inner)	8974S[2]
Set (Inner)	SET45[2]
Cone/Cup (Outer)	1779-1729X[2]
1990	(JB5 L/D Brks.)	
Seal (Inner)	8871[2]
Set (Inner)	SET5[2]
Set (Outer)	SET3[2]

REAR WHEEL

RWD

2009-2003	(9.5" R.G.)	
Seal	710105[2]
Cylindrical Bearing	R1561 TV[2]
Bearing & Seal Kit	TGM1561R[2] ¹⁹
2009-1999	(10.5", 11.5" R.G.)	
Seal	SL260002[2] ²⁵
Cone/Cup (Inner)	387AS-382A[2]
Set (Outer)	SET38[2]
2002-1990	(9.5" R.G.)	
Seal	710105[2]
Cylindrical Bearing	R1561 TV[2]
Bearing & Seal Kit	TGM1561R[2] ¹⁹
2002-1990	(10.5" R.G.)	
Seal (Inner)	2081[2]
Cone/Cup (Inner)	387AS-382A[2]
Set (Outer)	SET38[2]
1995-1990	(8.5" R.G.)	
Seal	8835S[2]
Cylindrical Bearing	6408[2]
Bearing & Seal Kit	TRP1559TV[2] ¹⁹

4WD FRONT AXLE

Axle Shaft

2005-2003		
Seal	710491[2]

Differential Rebuild Kit

2005	(7.25" R.G.)	
Kit	DRK320A

Differential

2006-2003		
Set	SET11[2]

Pinion

2006-2003		
Seal	710547
Seal (5.3L)	710532
Cone/Cup (Inner)	M86649-M86610
Cone/Cup (Outer)	M86649-M86610

REAR AXLE

Differential Rebuild Kit

2004-1997	(8.5" R.G.)	
Kit	DRK321C
2002-1998	(9.5" R.G.)	
Kit	DRK324B
2002-1990	(10.5" R.G.)	
Kit	DRK325B
1997-1990	(10.5" R.G.)(2nd Design)	
Kit	DRK325A
1997-1990	(9.5" R.G.)	
Kit	DRK324
1996-1990	(8.5" R.G.)	
Kit	DRK321

Differential

2008-2003	(Dana/Spicer 60 Axle)	
Cone/Cup	NP197868-NP802507[2]
2005-2003	(10.5" R.G.)	
Cone/Cup	469-453X[2]
2005-1993	(9.5" R.G.)	
Set	SET42[2]
2004-2001	(8.625" R.G.)	
Set	SET36[2]

¹⁹Opt. Axle Rpr Brg. Replaces O.E. Brg & Seal Inventory

²⁵New Item, Check For Availability

⁸³Deplete

⁸⁴Reorder

Mfg./Year	Model & Location	Part No.	Mfg./Year	Model & Location	Part No.
CHEVROLET/GMC TRUCK - 3/4 TON - G20/G25, Express/Savana (cont.)					

REAR AXLE (cont.)**Differential (cont.)**

2002-1990	(10.5" R.G.)	
Cone/Cup		387AS-382A[2]
2000	(8.625" R.G.)(1st Design)	
Cone/Cup		LM501349-LM501314[2]
2000	(8.625" R.G.)(2nd Design)	
Set		SET36[2]
1999-1997	(8.5" R.G.)	
Cone/Cup		LM501349-LM501314[2]
1995-1990	(8.125", 8.5" R.G.)	
Cone/Cup		LM501349-LM501314[2]

Pinion

2008-2006	(10.5" R.G.)(H/D)	
Seal		710508
Cone/Cup (Inner)		HM807046-HM807010
Cone/Cup (Outer)		HM88542-HM88510
2008-2003	(Dana/Spicer 60 Axle)	
Seal		100712V
Cone/Cup (Inner)		HM803146-HM803110
Cone/Cup (Outer)		HM88542-HM88510
2006-2003	(9.75" R.G.)	
Cone/Cup (Inner)		HM803146-HM803110
Cone/Cup (Outer)		HM88542-HM88510
2004-2003	(10.5" R.G.)	
Seal		710508
Cone/Cup (Inner)		HM903249-HM903210
Cone/Cup (Outer)		NP544520-NP099285
Cylindrical Bearing		R1581TV[2]
2002-2000	(10.5" R.G.)	
Seal		710508
Cone/Cup (Inner)		HM903249-HM903210
Cone/Cup (Outer)		NP457992-NP926068
Cylindrical Bearing		R1581TV[2]
2002-1998	(9.5" R.G.)	
Seal		710507
Cone/Cup (Inner)		HM804846-HM804810
Cone/Cup (Outer)		HM88649-HM88610
2002-1997	(8.5" R.G.)	
Seal		710506
Cone/Cup (Inner)		NP457992-NP926068
Cone/Cup (Outer)		M88048-M88010
1999-1990	(10.5" R.G.)	
Seal		710508
Cone/Cup (Inner)		HM903249-HM903210
Cone/Cup (Outer)		M802048-M802011
Cylindrical Bearing		R1581TV[2]
1997-1990	(9.5" R.G.)	
Seal		3896
Cone/Cup (Inner)		HM804846-HM804810
Cone/Cup (Outer)		HM88649-HM88610
1996-1990	(8.5", 8.75" R.G.)	
Seal		2043
Cone/Cup (Inner)		M802048-M802011
Cone/Cup (Outer)		M88048-M88010

3-SPEED AUTOMATIC TRANSMISSION**Torque Converter**

1995-1990	(THM700)(4L60 E)	
Seal		3227
Repair Sleeve		KWK99174

3-SPEED AUTOMATIC TRANSMISSION (cont.)**Torque Converter (cont.)**

1992-1990		
Seal		6712NA[2]
Repair Sleeve		KWK99187

Rear Seal/Ext. Housing

1995-1990		
Seal		9613S
Repair Sleeve		KWK99149
Seal Kit		5200 ⁶⁴

Selector Shaft Seal/Man. Shaft

1990		
Seal		8792S

4-SPEED AUTOMATIC TRANSMISSION**Torque Converter**

2006-1991	(4L80E)	
Seal		4598
Repair Sleeve		KWK99199
2006-1990	(THM700)(4L60 E)	
Seal		3227[2]
Repair Sleeve		KWK99174

Rear Seal/Ext. Housing

2008-1991	(4L80E)(Booted)	
Seal		4333N
2008-1991	(4L80E)(Exc. Booted)	
Seal		9449
Seal Kit		5208 ⁶⁴
2006-1990	(4L60, 4L60E, 4L65E)	
Seal		9613S[2]
Repair Sleeve		KWK99149
Seal Kit		5200 ⁶⁴

Selector Shaft Seal/Man. Shaft

2008-1990		
Seal		8792S
Repair Sleeve		KWK99050

CLUTCH**Pilot Bearing**

2000-1994	(Gas)	
Ball Bearing		57080
2000-1990	(Diesel)(TurboDiesel)	
Ball Bearing		57080
1993-1990	(Gas)	
Bushing H/D		PB656HD

Release Bearing

2002-1990	(Hyd. Mechanism)	
Bearing Assy		614174

⁶⁴Seal & Bushing Kit

Mfg./Year Model & Location Part No. Mfg./Year Model & Location Part No.
CHEVROLET/GMC TRUCK - 3/4 TON - G20/G25, Express/Savana (cont.)

4-SPEED MANUAL TRANSMISSION

Input Shaft

1990 (New Process MY6)
 Seal 7412S
 Repair Sleeve KWK99125

Rear Output Shaft

1990 (New Process)
 Seal 9613S
 Ball Bearing 308LOE[2]
 Repair Sleeve KWK99149
 Seal Kit 5200⁶⁴

A/C COMPRESSOR

2002-1990
 Ball Bearing 907257[2]
 Ball Bearing (Frt Head) S128

ALTERNATOR

2002-1990 (Delco 100, 124, 140, 145 Amp.)
 Ball Bearing (Rear End) 100CCAB
 1991-1990 (Delco 56, 66, 78 Amp.)
 Ball Bearing (Drive End) 203FF
 1991-1990 (Delco 37, 42, 55, 56, 61, 63, 66, 78 Amp.)
 Ball Bearing (Rear End) MNJ471S

DRIVESHAFT SUPPORT

1994-1990 (1.378" 35mm Brg. I.D.)
 Ball Bearing 88107[2]
 Hanger Bearing Assy HB88107A[2]
 1991-1990 (1.57" 40mm Brg. I.D.)
 Hanger Bearing Assy HB108[2]

POWER STEERING

Pitman Shaft

2000-1990
 Seal Kit PSK1²⁴
 Seal (Inner) 471413
 Seal (Outer) 7412S

Pump Shaft

2000-1990
 Seal 7013S[2]
 Ball Bearing 8537[2]¹⁶

Worm Shaft

1991-1990 Exc. P Ser.
 Seal 222025

MANUAL STEERING

Pitman Shaft

1990
 Seal 313842

MANUAL STEERING

Worm Shaft

1990
 Seal 7013S
 Ball Bearing 8537[2]¹⁶

CRANKSHAFT FRONT SEAL

6 Cylinder

2005-1990 230/3.8L, 250/4.1L, 262/4.3L, 292/4.8L
 Seal 9845
 Repair Sleeve KWK99176
 Harmnc Balancer Slvs 88176

8 Cylinder

2008-2003 294/4.8L, 325/5.3L, 364/6.0L
 Seal Viton 100470
 Repair Sleeve KWK99210
 2002-1990 379/6.2L (Diesel) 395/6.5L (Diesel) 395/6.5L (Turbo Diesel)
 Seal 3945
 Repair Sleeve KWK99233
 Harmnc Balancer Slvs 88233
 2002-1990 283/4.6L, 307/5.0L, 327/5.4L, 350/5.7L, 4006/6.6L (GAS)
 Seal 9845
 Repair Sleeve KWK99176
 Harmnc Balancer Slvs 88176

CRANKSHAFT REAR SEAL

6 Cylinder

2005-1999 262/4.3L
 Seal Viton 4359V
 Seal 5512
 Repair Sleeve KWK99364
 1998-1990
 Seal Viton 4359V

8 Cylinder

2009-2003 292/4.8L, 325/5.3L, 364/6.0L
 Seal 100085
 2006-1992 (Diesel)
 Seal Viton 710258
 Repair Sleeve KWK99452
 2002-1990 305/5.0L, 350/5.7L
 Seal Viton 4359V
 Seal PTFE H/D 5274
 Repair Sleeve KWK99364
 1991-1990 (Diesel)
 Seal 5163

¹⁶Obsolete

²⁴Opt. Kit = Seals 5683 & 5684. Not Sold Separately

⁶⁴Seal & Bushing Kit

Mfg./Year Model & Location Part No. Mfg./Year Model & Location Part No.

**CHEVROLET/GMC TRUCK - 1 TON - C-30/35, K-30/35, R-30/35,
Silverado/Sierra, V-30/35****FRONT WHEEL****RWD**

2009-2008 (DRW)	
Hub Unit Bearing	SP580313[2] ²⁵
2007-2001 Classic Style Silverado/Sierra	
Hub Unit Bearing	SP580308[2] ¹⁶
Hub Unit Bearing	SP580311[2] ⁵⁸
2002-1992 Old Style	
Seal (Inner) (15,000 GVWR)	5682[2]
Cone/Cup (Inner) (15,000 GVWR)	26884-26822[2]
Seal (Inner) (Exc. 15,000 GVWR)	4740[2]
Set (Inner) (Exc. 15,000 GVWR)	SET45[2]
Cone/Cup (Outer)	15103S-15243[2]
1991-1990	
Seal (Inner)	8974S[2]
Set (Inner)	SET45[2]
Cone/Cup (Outer)	15103S-15243[2]
1990 (Disc ~ Front Wheel)	
Seal (Inner)	8974S[2]
Set (Inner)	SET45[2]
Cone/Cup (Outer)	15103S-15243[2]

4WD

2008 (DRW)	
Hub Unit Bearing	SP580313[2] ²⁵
2007-2004 Classic Style Silverado/Sierra (SRW)(9900 GVWR)	
Hub Unit Bearing	SP580304[2] ⁸³
Hub Unit Bearing	SP580310[2] ⁸⁴
2007-2001 Classic Style Silverado/Sierra (DRW)	
Hub Unit Bearing	SP580309[2] ¹⁶
Hub Unit Bearing	SP580311[2] ⁵⁸
2000-1996 (ABS)	
Seal	710103[2]
Hub Unit Bearing (RH)	SP580302[2] ⁸⁷
Sensor Kit (RH)	SK580302[2] ³⁹
Hub Unit Bearing (LH)	SP580303[2] ⁸⁷
Sensor Kit (LH)	SK580303[2] ³⁹
1995 (ABS)	
Hub Unit Bearing (RH)	SP580300[2] ⁹⁵
Sensor Kit (RH)	SK580300[2] ³⁹
Hub Unit Bearing (LH)	SP580301[2] ⁹⁵
Sensor Kit (LH)	SK580301[2] ³⁹
Seal	710103[2]
1994-1990	
Hub Unit Bearing	HA591339[2] ⁸⁷
Seal	710103[2]

REAR WHEEL**RWD**

2009-2001 (10.5", 11.5" R.G.)	
Seal	SL260002[2] ²⁵
Cone/Cup (Inner) (10.5" R.G.)	387AS-382A[2]
Set (Outer) (10.5" R.G.)	SET38[2]
Cone/Cup (Inner) (11.5" R.G.)	NP706218-NP910345[2]
Cone/Cup (Outer) (11.5" R.G.)	NP145100-NP913325[2]
2000-1990	
Seal (Inner)	2081[2]
Cone/Cup (Inner) (10.5" R.G.)	387AS-382A[2]
Set (Outer) (10.5" R.G.)	SET38[2]
Cone/Cup (Inner) (11.5" R.G.)	NP706218-NP910345[2]
Cone/Cup (Outer) (11.5" R.G.)	NP145100-NP913325[2]
1991-1990 (9.5" R.G.)	
Seal	2081[2]
Cylindrical Bearing	R1561TV[2]
Bearing & Seal Kit	TGM1561R[2] ¹⁹

4WD

2009-2001 (10.5", 11.5" R.G.)	
Seal	SL260002[2] ²⁵
Cone/Cup (Inner) (10.5" R.G.)	387AS-382A[2]
Set (Outer) (10.5" R.G.)	SET38[2]
Cone/Cup (Inner) (11.5" R.G.)	NP706218-NP910345[2]
Cone/Cup (Outer) (11.5" R.G.)	NP145100-NP913325[2]
2000-1990	
Seal (Inner)	2081[2]
Cone/Cup (Inner) (10.5" R.G.)	387AS-382A[2]
Set (Outer) (10.5" R.G.)	SET38[2]
Cone/Cup (Inner) (11.5" R.G.)	NP706218-NP910345[2]
Cone/Cup (Outer) (11.5" R.G.)	NP145100-NP913325[2]
1991-1990 (9.5" R.G.)	
Seal	2081[2]
Cylindrical Bearing	R1561TV[2]
Bearing & Seal Kit	TGM1561R[2] ¹⁹

FRONT AXLE**Differential Rebuild Kit**

2004-1990 (9.25" R.G.)	
Kit	DRK324A

¹⁶Obsolete ¹⁹Opt. Axle Rpr Brg. Replaces O.E. Brg & Seal ²⁵New Item, Check For Availability
³⁹Opt. Kit = Cable, Screw, Grease. ⁵⁸Replaces SP580308 and SP580309 ⁸³Deplete Inventory
⁸⁴Reorder ⁸⁷Hub Unit Only. W/O Rotor ⁹⁵8 Stud.

Mfg./Year	Model & Location	Part No.	Mfg./Year	Model & Location	Part No.
CHEVROLET/GMC TRUCK - 1 TON - C-30/35, K-30/35, R-30/35, Silverado/Sierra, V-30/35 (cont.)					

FRONT AXLE

Differential

2006-1990 (9.25" R.G.)	
Seal	450094[2]
Set	SET42[2]
1991-1990 (Dana/Spicer 60 F Axle)	
Cone/Cup	387A-382S[2]

Pinion

2008-1999 (9.25" R.G.)	
Seal	710536
Cone/Cup (Inner)	HM804846-HM804810
Cone/Cup (Outer)	HM88649-HM88610
1998-1997 (9.25" R.G.)	
Seal	710281
Cone/Cup (Inner)	HM804846-HM804810
Cone/Cup (Outer)	HM88649-HM88610
1996-1990 (9.25" R.G.)	
Seal	710281
Cone/Cup (Inner)	HM804846-HM804810
Cone/Cup (Outer)	HM88649-HM88610
1991-1990 (Dana/Spicer 60 F Axle)	
Seal	9316
Cone/Cup (Inner)	HM803146-HM803110
Cone/Cup (Outer)	HM88542-HM88510

Spindle Kit

1991-1990 (Dana/Spicer 60 F Axle)	
Bearing & Seal Kit	SBK3[2] ³⁵

Spindle

1991-1990 (Dana/Spicer 60 F Axle)	
Seal (Inner)	710044[2]
Ndle Bearing (Inner)	B2414[2]
Seal (Outer)	710045[2]

Steering Knuckle

1991-1990 (Dana/Spicer 60 F Axle)	
Seal (Upper)	710304[2]
Cone/Cup (Upper)	23100-23256[2]
Seal (Lower)	710304[2]
Cone/Cup (Lower)	23100-23256[2]

4WD FRONT AXLE

Differential: Output Shaft

2007-1999	
Seal	710497[2] ²⁵

REAR AXLE

Differential Rebuild Kit

2003-2001 (11.5" R.G.)	
Kit	DRK327
2003-1997 (10.5" R.G.)	
Kit	DRK325B
2003-1997 (9.5" R.G.)	
Kit	DRK324B

REAR AXLE (cont.)

Differential Rebuild Kit (cont.)

1996-1990 (10.5" R.G.)(2nd Design)(Prod. From Mid 1988 On)	
Kit	DRK325A
1996-1990 (9.5" R.G.)	
Kit	DRK324
1996-1990 (Dana/Spicer 70 H/D Axle)	
Kit	DRK332HD
1991-1990 (Dana/Spicer 60H/D Axle)	
Kit	DRK331
1990 (Dana/Spicer 70U Axle)	
Kit	DRK332U

Differential

2006-1990 (10.5" R.G.)	
Cone/Cup	387AS-382A[2]
2005-2001 (11.5" R.G.)	
Cone/Cup	3984-3920[2]
2002-1990 (Dana/Spicer 70H/D, 70-3H/D, 80 Axle)	
Cone/Cup	469-453X[2]
1999-1990 (9.5" R.G.)	
Set	SET42[2]
1995-1990 (Isuzu R040 Axle)	
Cone/Cup	29590-29522[2]
1991-1990 (Rockwell C100 Axle)	
Cone/Cup	395-394A[2]
1990 (Dana/Spicer 60H/D, 70B, 70U Axle)	
Cone/Cup	387A-382S[2]

Pinion

2007-1997 (11.5" R.G.)	
Seal	710508
Cone/Cup (Inner)	HM807046-HM807010
Cone/Cup (Outer)	M802048-M802011
2006-2005 (10.5" R.G.)	
Seal	710508
Cone/Cup (Inner)	HM807046-HM807010
Cone/Cup (Outer)	NP457992-NP926068
Cylindrical Bearing	R1581TV[2]
2004-2003 (10.5" R.G.)	
Seal	710508
Cone/Cup (Inner)	HM903249-HM903210
Cone/Cup (Outer)	NP544520-NP099285
Cylindrical Bearing	R1581TV[2]
2004-2003 (10.5" R.G.)(H/D)	
Seal	710508
Cone/Cup (Inner)	HM903249-HM903210
Cone/Cup (Outer)	NP544520-NP099285
Cylindrical Bearing	R1581TV[2]
2002-2000 (10.5" R.G.)	
Seal	710508
Cone/Cup (Inner)	HM903249-HM903210
Cone/Cup (Outer)	NP457992-NP926068
Cylindrical Bearing	R1581TV[2]

²⁵New Item, Check For Availability

³⁵Opt. Kit = Brg B2414, Seals 710044 & 710045

Mfg./Year	Model & Location	Part No.	Mfg./Year	Model & Location	Part No.
CHEVROLET/GMC TRUCK - 1 TON - C-30/35, K-30/35, R-30/35, Silverado/Sierra, V-30/35 (cont.)					

REAR AXLE (cont.)**Pinion (cont.)**

2000-1990	(Dana/Spicer 80 Axle)	
Seal Viton	4525V
Cone/Cup (Inner)	HM807046-HM807010
Cone/Cup (Outer)	M802048-M802011
1999-1998	(10.5" R.G.)	
Seal	710508
Cone/Cup (Inner)	HM903249-HM903210
Cone/Cup (Outer)	M802048-M802011
Cylindrical Bearing	R1581TV[2]
1999-1998	(9.5" R.G.)	
Seal	710507
Cone/Cup (Inner)	HM804846-HM804810
Cone/Cup (Outer)	HM88649-HM88610
1999-1990	(Isuzu R040 Axle)	
Seal	710268
Bearing Assy (Inner)	30309M
Bearing Assy (Outer)	30309M
1997	(10.5" R.G.)	
Seal (1st Design)	2286
Seal (2nd Design)	710508
Cone/Cup (Inner)	HM903249-HM903210
Cone/Cup (Outer)	M802048-M802011
Cylindrical Bearing	R1581TV[2]
1997-1990	(9.5" R.G.)	
Seal	3896
Cone/Cup (Inner)	HM804846-HM804810
Cone/Cup (Outer)	HM88649-HM88610
1997-1990	(Dana/Spicer 70B, 70H/D, 70-3H/D Axle)	
Seal	9316
Cone/Cup (Inner)	HM807040-HM807010
Cone/Cup (Outer)	HM88542-HM88510
1996-1990	(10.5" R.G.)	
Seal	2286
Cone/Cup (Inner)	HM903249-HM903210
Cone/Cup (Outer)	M802048-M802011
Cylindrical Bearing	R1581TV[2]
1994-1990	(Dana/Spicer 70U Axle)	
Seal	9316
Cone/Cup (Inner)	HM803149-HM803110
Cone/Cup (Outer)	HM88542-HM88510
1991-1990	(Rockwell C100 Axle)	
Seal	475080N
Cone/Cup (Inner)	M903345-M903310
Cone/Cup (Outer)	44143-44348
1990	(Dana/Spicer 60H/D Axle)	
Seal	9316
Cone/Cup (Inner)	HM803146-HM803110
Cone/Cup (Outer)	HM88542-HM88510

TRANSFER CASE REBUILD KIT

2002-1990	(Warner 4401, 4470)	
Kit	TCRK4470
2002-1990	(Warner 1370)	
Kit	TCRK1356
1990	(New Process 205)(T400)(late SM465)	
Kit	TCRK205GDMD

TRANSFER CASE REBUILD KIT (cont.)

1990	(New Process 205)(THM350)(early SM465)	
Kit	TCRK205G

TRANSFER CASE**Input Shaft**

2007-2001	(New Process 261C, 263C)	
Seal (Exc. Engine code U and G)	472636
2002-1990	(Warner 1370, 4401, 4470)	
Seal (O.E.)	714503
Ball Bearing	110CB
Ndle Bearing (Pilot)	BK3026
1990	(New Process 205)(T400)(late SM465)	
Seal (O.E.)	3173
Ball Bearing	1210L
Repair Sleeve (Opt)	KWK99193
Seal (Opt)	710298
Ndle Bearing (Pilot)	QAR29523

Front Output Shaft

2007-2001	(New Process 261C, 231C)	
Seal	710495 ²⁵
2002-1990	(Warner 1370, 4401, 4470)	
Seal	714503
Ball Bearing	207
Ndle Bearing (Pilot)	B2012
1990	(New Process 203, 205)	
Seal	710005
Ball Bearing	307L
Repair Sleeve	KWK99174
Ndle Bearing (Pilot)	M28161

Rear Output Shaft

2002-1990	(Warner 4470)	
Seal (Exc. Boot)	714503
Seal (Booted)	4503N
Ball Bearing	208
2002-1990	(Warner 1370, 4401)	
Seal (Exc. Boot)	714503
Seal (Booted)	4503N
Ball Bearing	207
1990	(New Process 205)	
Seal	473468
Ball Bearing	307L[2]
Repair Sleeve	KWK99212
Ndle Bearing (Pilot)	B3216

Idler Shaft

1990	(New Process 205)	
Cone/Cup	2793-2720[2]

Oil Pump Housing

2002-1990	(Warner 4470)	
Ndle Bearing	B3012

²⁵New Item, Check For Availability

Mfg./Year	Model & Location	Part No.	Mfg./Year	Model & Location	Part No.
CHEVROLET/GMC TRUCK - 1 TON - C-30/35, K-30/35, R-30/35, Silverado/Sierra, V-30/35 (cont.)					

TRANSFER CASE

Selector Shaft Seal/Man. Shaft

2002-1990	(Warner 1370, 4401, 4470)	
Seal	330385
1990	(New Process 205)	
Seal	2287
Repair Sleeve	KWK99076

3-SPEED AUTOMATIC TRANSMISSION

Torque Converter

1990		
Seal	6712NA[2]
Repair Sleeve	KWK99187

Selector Shaft Seal/Man. Shaft

1990		
Seal	8792S

4-SPEED AUTOMATIC TRANSMISSION

Torque Converter

2006-1991	(4L80E)	
Seal	4598
Repair Sleeve	KWK99199
2002-1990	(THM700)(4L60 E)	
Seal	3227[2]
Repair Sleeve	KWK99174

Rear Seal/Ext. Housing

2006-1991	(4L80E)(THMR2)	
Seal	9449
Seal Kit	5208 ⁶⁴
2006-1991	(4L80E)(THMR2)(Booted)	
Seal	4333N
2002-1990	(THM700)(4L60 E)	
Seal	9613S[2]
Repair Sleeve	KWK99149
Seal Kit	5200 ⁶⁴

Selector Shaft Seal/Man. Shaft

2008-1990		
Seal	8792S
Repair Sleeve	KWK99050

5-SPEED AUTOMATIC TRANSMISSION

Rear Seal/Ext. Housing

2007-2001	(Allison 1000, 1000/M74)	
Seal	415988

Selector Shaft Seal/Man. Shaft

2007-2001	(Allison 1000, 1000/M74)	
Seal	8792S
Repair Sleeve	KWK99050

6-SPEED AUTOMATIC TRANSMISSION

Selector Shaft Seal/Man. Shaft

2009-2007	(6L90)	
Seal	8792S

CLUTCH

Pilot Bearing

2001-1990		
Ball Bearing	57080

CLUTCH - 8 CYLINDER

Release Bearing

2000-1996		
Bearing Assy	614174
1995-1990	(w/o cable Cl.)	
Bearing Assy	614109

4-SPEED MANUAL TRANSMISSION

Input Shaft

1991-1990	(Muncie)(M20)(CH465)(2nd Design)	
Seal	481181N
Ball Bearing	211FFLE[2]
Repair Sleeve	KWK99162
1990	(Muncie M20, CH465)(1st Design)	
Seal	481181N
Ball Bearing	N1211L[2]
Repair Sleeve	KWK99162

Rear Output Shaft

1991-1990	(Muncie M20, CH465)	
Seal	410085
Ball Bearing	1308SL[2]

5-SPEED MANUAL TRANSMISSION

Transmission Rebuild Kit

2002-1996	(New Venture 4500)	
Kit	TRK4500GMI
1995-1991	(New Venture 4500)	
Kit	TRK4500GM

Front Input Shaft

2007-1999	(New Process 4500)	
Seal	714655
Cone/Cup	M802048CP-NP728109[2]
Repair Sleeve	KWK99133
1998-1991	(New Process 4500)	
Seal	714655[2]
Cone/Cup	M802048CP-M802011AP[2]
Repair Sleeve	KWK99133
1993-1991	(New Process 3500)	
Seal	4529N
Ball Bearing	307FFLS[2]
Repair Sleeve	KWK99138

⁶⁴Seal & Bushing Kit

Mfg./Year Model & Location Part No. Mfg./Year Model & Location Part No.

**CHEVROLET/GMC TRUCK - 1 TON - C-30/35, K-30/35, R-30/35,
Silverado/Sierra, V-30/35 (cont.)****5-SPEED MANUAL TRANSMISSION****Front Countershaft**

2007-1991 (New Process 4500)
Cone/Cup LM102949CP-LM102910P[2]

Rear Countershaft

2007-1991 (New Process 4500)
Cone/Cup LM501349HP-LM501310P[2]

Rear Output Shaft

2007-1991 (N. P. 4500 w/o 15,000
GVWR)
Seal 714654
Cone/Cup M804049-M804010[2]

2001-1991 (New Process 4500)(15,000
GVWR)
Seal 415449
Cone/Cup M804049-M804010[2]

1993-1991 (N.P.3500 # C320844)(4WD)
Seal 4530
Ball Bearing 307FFTB[2]

1993-1991 (N.P.3500 Exc. #
C320844)(4WD)
Seal 4528N
Ball Bearing 307FFTB[2]

1993-1991 (New Process 3500)(4WD)
Seal 4532N
Ball Bearing 307FFTB[2]

DRIVESHAFT SUPPORT

2002-2001 (Spicer 1480)(1.5748" 40mm
Brg. I.D.)
Hanger Bearing Assy HB88508AA

2002-1990 (Spicer 1280, 1310,
1330)(1.3780" Brg. I.D.)
Ball Bearing 88107[2]
Hanger Bearing Assy HB88107A[2]

2000-1990 (Spicer 1410)(1.5748" 40mm
Brg. I.D. 2.25" height)
Hanger Bearing Assy HB88508A[2]

POWER STEERING**Pitman Shaft**

1991-1990 Exc. C/K Ser.
Seal (Inner) 471413
Seal (Outer) 7412S
Seal Kit PSK1²⁴

Pump Shaft

2001-1990
Seal 480821

Worm Shaft

1991-1990 Exc. P Ser.
Seal 222025
Ndle Bearing SCE148[2]

CRANKSHAFT FRONT SEAL**8 Cylinder**

2008-2001 364/6.0L
Seal Viton 100470
Repair Sleeve KWK99210

2004-2001 400/6.6L (Diesel)
Seal 3945
Repair Sleeve KWK99233
Harmnc Balancer Slvs 88233

2000-1990 379/6.2L (Diesel) 395/6.5L
(Diesel), 454/7.4L (GAS)
Seal 3945
Repair Sleeve KWK99233
Harmnc Balancer Slvs 88233

2000-1990 283/4.6L, 307/5.0L, 327/5.4L,
350/5.7L, 4006/6.6L (GAS)
Seal 9845
Repair Sleeve KWK99176
Harmnc Balancer Slvs 88176

CRANKSHAFT REAR SEAL**8 Cylinder**

2009-2001 364/6.0L
Seal 100085

2009-2001 6.5L Diesel, 6.6L Diesel
Seal Viton 710258
Repair Sleeve KWK99452

2000-1992 (Diesel)
Seal Viton 710258
Repair Sleeve KWK99452

2000-1991 (454/7.4L)
Seal Viton 2261
Repair Sleeve KWK99435

2000-1990 (w/o 454 & Diesel)
Seal Viton 4359V
Seal PTFE H/D 5274
Repair Sleeve KWK99364

1991-1990 (Diesel)
Seal 5163

1990 (454/7.4L)
Seal 5072

²⁴Opt. Kit = Seals 5683 & 5684. Not Sold Separately

Mfg./Year Model & Location Part No. Mfg./Year Model & Location Part No.
CHEVROLET/GMC TRUCK - 1 TON - G30/G35, P30/P35, Express/Savana

FRONT WHEEL

RWD

2009	Hub Unit Bearing	HA590352[2]	⁸⁴
2008-2006	Hub Unit Bearing	HA590353[2]	
2005-2003	Hub Unit Bearing	HA590352[2]	⁸⁴
2002-1992	Express, G Series, Savanna		
	Seal (Inner)	4740[2]	
	Set (Inner)	SET45[2]	
	Cone/Cup (Outer)	15103S-15243[2]	
1999-1991	P Series (Exc. I Beam Axle)		
	Seal (Inner)	4740[2]	
	Set (Inner)	SET45[2]	
	Cone/Cup (Outer)	15103S-15243[2]	
1999-1990	P Series (I Beam Axle)		
	Seal (Inner)	5682[2]	
	Cone/Cup (Inner)	26884-26823[2]	
	Cone/Cup (Outer)	15103S-15243[2]	
1991-1990	G30/G35 (Disc Brks.)		
	Seal (Inner)	8974S[2]	
	Set (Inner)	SET45[2]	
	Cone/Cup (Outer)	15103S-15243[2]	
1990	P Series (Exc. I Beam Axle)		
	Seal (Inner)	8974S[2]	
	Set (Inner)	SET45[2]	
	Cone/Cup (Outer)	15103S-15243[2]	

REAR WHEEL

RWD

2009-2001	(10.5", 11.5" R.G.)		
	Seal	SL260002[2]	²⁵
	Cone/Cup (Inner)		
	(10.5" R.G.)	387AS-382A[2]	
	Set (Outer) (10.5" R.G.)	SET38[2]	
	Cone/Cup (Inner)		
	(11.5" R.G.)	NP706218-NP910345[2]	
	Cone/Cup (Outer)		
	(11.5" R.G.)	NP145100-NP913325[2]	
2000-1990			
	Seal	2081[2]	
	Cone/Cup (Inner) (Exc. DRW)		
	DRW	387AS-382A[2]	
	Set (Outer) (Exc. DRW)	SET38[2]	
	Cone/Cup (Inner)		
	(DRW)	NP706218-NP910345[2]	
	Cone/Cup (Outer)		
	(DRW)	NP145100-NP913325[2]	
1999-1997	P Series Motor Home		
	Seal (Inner)	6358[2]	
	Cone/Cup (Inner)	39590-39520[2]	
	Cone/Cup (Outer)	JLM506849-JLM506810[2]	
1996-1990	P Series Motor Home		
	Seal (Inner)	6358[2]	
	Cone/Cup (Inner)	395CS-394CS[2]	
	Cone/Cup (Outer)	387A-382A[2]	
1991-1990	(9.5" R.G.)		
	Seal (Inner)	3747[2]	
	Cylindrical Bearing		
	(Inner)	R1561TV[2]	
	Bearing & Seal Kit	TGM1561R[2]	¹⁹

4WD FRONT AXLE

Differential

2006-2003	Set	SET111[2]
------------------	-----	-----------

Pinion

2006-2003	Cone/Cup (Inner)	M86649-M86610
	Cone/Cup (Outer)	M86649-M86610

REAR AXLE

Differential Rebuild Kit

2007-1998	(10.5" R.G.)	
	Kit	DRK325B
1997-1990	(10.5" R.G.)	
	Kit	DRK325A

Differential

2006-2003	(10.5" R.G.)	
	Cone/Cup	469-453X[2]
2002-1992	(10.5" R.G.)	
	Cone/Cup	387AS-382A[2]
1996-1990	(9.5" R.G.)	
	Set	SET42[2]
1991-1990	(10.5" R.G.)(DRW & 7.4L)	
	Cone/Cup	469-453X[2]
1990	(9.5", 9.75" R.G.)(10.5" R.G.)	
	or 6.2L(DRW & Spicer)	
	Cone/Cup	387A-382S[2]

Pinion

2008-2003	(10.5" R.G.)	
	Seal	710508
	Cone/Cup (Inner)	HM807040-HM807010
	Cone/Cup (Outer)	HM88542-HM88510
2006	(9.75" R.G.)	
	Cone/Cup (Inner)	HM803146-HM803110
	Cone/Cup (Outer)	HM88542-HM88510
2002-1998	(10.5" R.G.)	
	Seal	710505
	Cone/Cup (Inner)	HM903249-HM903210
	Cone/Cup (Outer)	M802048-M802011
	Cylindrical Bearing	R1581TV[2]
1997-1996	(10.5" R.G.)	
	Seal	2286
	Cone/Cup (Inner)	HM903249-HM903210
	Cone/Cup (Outer)	M802048-M802011
	Cylindrical Bearing	R1581TV[2]
1995-1991	(10.5" R.G.)(Exc. Spicer Axle)	
	Seal	2286
	Cone/Cup (Inner)	HM903249-HM903210
	Cone/Cup (Outer)	M802048-M802011
	Cylindrical Bearing	R1581TV[2]
1995-1990	(9.5" R.G.)	
	Seal	3896
	Cone/Cup (Inner)	HM804846-HM804810
	Cone/Cup (Outer)	HM88649-HM88610
	Repair Sleeve	KWK99193

¹⁹Opt. Axle Rpr Brg. Replaces O.E. Brg & Seal

²⁵New Item, Check For Availability

⁸⁴Reorder

**CHEVROLET/GMC TRUCK - 1 TON - G30/G35, P30/P35, Express/Savana
(cont.)****REAR AXLE (cont.)****Pinion (cont.)**

1991-1990 (10.5" R.G.)(Spicer Axle)	
Seal	9316
Cone/Cup (Outer)	HM88542-HM88510
Cone/Cup (Inner)	HM807040-HM807010
Cone/Cup	HM803149-HM803110[2]
Repair Sleeve	KWK99187
1991-1990 (9.75" R.G.)	
Seal	9316
Cone/Cup (Inner)	HM803146-HM803110
Cone/Cup (Outer)	HM88542-HM88510
Repair Sleeve	KWK99187

3-SPEED AUTOMATIC TRANSMISSION**Torque Converter**

1995-1990 (THM700)(4L60 E)	
Seal	3227
Repair Sleeve	KWK99174
1992-1990 (w/o THM700)	
Seal	6712NA[2]
Repair Sleeve	KWK99187

Rear Seal/Ext. Housing

1995-1990 (w/o 4L80E, THM400, THM475)	
Seal	9613S
Repair Sleeve	KWK99149
Seal Kit	5200 ⁶⁴

Selector Shaft Seal/Man. Shaft

1990	
Seal	8792S

4-SPEED AUTOMATIC TRANSMISSION**Torque Converter**

2006-1991 (4L80E)	
Seal	4598
Repair Sleeve	KWK99199
2006-1990 (THM700)(4L60 E)	
Seal	3227
Repair Sleeve	KWK99174

Rear Seal/Ext. Housing

2008-1991 (4L80E)(Booted)	
Seal	4333N
2008-1991 (4L80E)(Exc. Booted)	
Seal	9449
Seal Kit	5208 ⁶⁴
2008-1990 (4L60, 4L60E)	
Seal	9613S
Repair Sleeve	KWK99149
Seal Kit	5200 ⁶⁴

4-SPEED AUTOMATIC TRANSMISSION**Selector Shaft Seal/Man. Shaft**

2006-1990	
Seal	8792S
Repair Sleeve	KWK99050

CLUTCH**Pilot Bearing**

2002-2001 364/6.0L, 496/8.1L	
Ball Bearing	203FF
2002-1990 (w/o 364/ 6.0L, 496/ 8.1L)	
Ball Bearing	57080
2002-1990 (Diesel)(TurboDiesel)	
Ball Bearing	57080

Release Bearing

2000-1990 (Hyd. Mechanism)	
Bearing Assy	614174

4-SPEED MANUAL TRANSMISSION**Input Shaft**

1990 (New Process MY6)	
Seal	7412S
Repair Sleeve	KWK99125

Rear Output Shaft

1990 (New Process)	
Seal	9613S
Ball Bearing	308LOE[2]
Repair Sleeve	KWK99149
Seal Kit	5200 ⁶⁴

DRIVESHAFT SUPPORT

1999-1991	
Hanger Bearing Assy	HB88508A[2]
1991-1990	
Ball Bearing	88107[2]
Hanger Bearing Assy	HB88107A[2]

POWER STEERING**Pitman Shaft**

2000-1990	
Seal Kit	PSK1 ²⁴
Seal (Inner)	471413
Seal (Outer)	7412S

Pump Shaft

2000-1990	
Seal	7013S[2]
Ball Bearing	8537[2] ¹⁶

Worm Shaft

1996-1990	
Seal	222025

¹⁶Obsolete²⁴Opt. Kit = Seals 5683 & 5684. Not Sold Separately⁶⁴Seal & Bushing Kit

Mfg./Year Model & Location Part No. Mfg./Year Model & Location Part No.

CHEVROLET/GMC TRUCK - 1 TON - G30/G35, P30/P35, Express/Savana
(cont.)

MANUAL STEERING

Pitman Shaft

1990
 Seal 313842

Worm Shaft

1990
 Seal 7013S
 Ball Bearing 8537[2]¹⁶

CRANKSHAFT FRONT SEAL

6 Cylinder

1999-1990
 Seal 9845
 Repair Sleeve KWK99176
 Harmnc Balancer Slvs 88176

8 Cylinder

2008-2003 294/4.8L, 325/5.3L, 364/6.0L
 Seal Viton 100470
 Repair Sleeve KWK99210
 2002-1990 379/6.2L (Diesel) 395/6.5L
 (Diesel), 454/7.4L (GAS)
 Seal 3945
 Repair Sleeve KWK99233
 Harmnc Balancer Slvs 88233
 2002-1990 283/4.6L, 307/5.0L, 327/5.4L,
 350/5.7L, 4006/6.6L (GAS)
 Seal 9845
 Repair Sleeve KWK99176
 Harmnc Balancer Slvs 88176

CRANKSHAFT REAR SEAL

6 Cylinder

1999-1990
 Seal Viton 4359V
 Seal PTFE H/D 5274
 Repair Sleeve KWK99364

CRANKSHAFT REAR SEAL

8 Cylinder

2009-2003 292/4.8L, 364/6.0L
 Seal 100085
 2006 6.6L (Diesel)
 Seal Viton 710258
 2002-1992 (Diesel)
 Seal Viton 710258
 Repair Sleeve KWK99452
 2002-1990 305/5.0L, 350/5.7L
 Seal Viton 4359V
 Seal PTFE H/D 5274
 Repair Sleeve KWK99364
 2000-1992 (454/7.4L)
 Seal Viton 2261
 Repair Sleeve KWK99435
 1991-1990 (Diesel)
 Seal 5163
 1991-1990 (454/7.4L)
 Seal 5072

CHEVROLET/GMC TRUCK - 1-1/2, 2, 2-1/2 TON - 50, 60, 70, 4500, 5500, 6500, 7500

FRONT WHEEL

FWD

1998-1997 (12,000 lb. Axle W7R042HD)
 Seal Viton (Inner) 370212A[2]⁵⁷
 Cone/Cup (Inner) JF7049A-JF7010[2]
 Cone/Cup (Outer) JM205149-JM205110[2]
 1998-1997 (W6R042)
 Seal Viton (Inner) 370199A[2]⁵⁷
 Cone/Cup (Inner) JM205149-JM205110[2]
 Bearing Assy (Outer) 32207M[2]
 1998-1997 (W7R042M)
 Seal (Inner) 370211A[2]⁵⁷
 Bearing Assy (Inner) 32208M[2]

FRONT WHEEL (cont.)

FWD (cont.)

1997-1993 (9,000 lb. Axle B7T042)
 Seal (Outer) 370211A[2]⁵⁷
 Bearing Assy (Outer) 33208[2]
 Bearing Assy (Inner) 33212[2]
 1997-1990 (11,000 lb. Axle C6H042,
 C7H042, C7H064,
 W7R042HD)
 Seal (Inner) 370211A[2]⁵⁷
 Bearing Assy (Outer) 33208[2]

¹⁶Obsolete ⁵⁷Oil Bath Seal

Mfg./Year	Model & Location	Part No.	Mfg./Year	Model & Location	Part No.
CHEVROLET/GMC TRUCK - 1-1/2, 2, 2-1/2 TON - 50, 60, 70, 4500, 5500, 6500, 7500 (cont.)					

FRONT WHEEL (cont.)**FWD (cont.)**

1997-1990	(14,500 lb. Axle)	
	Seal Viton (Inner)	370212A[2] ⁵⁷
	Cone/Cup (Inner)	JF7049A-JF7010[2]
	Cone/Cup (Outer)	JM205149A-JM205110[2]
1997-1990	(16,000 lb. Axle C6H042, C7H042, C7H064)	
	Seal (Inner)	370182A[2] ⁵⁷
	Cone/Cup (Inner)	6461A-6420[2]
	Cone/Cup (Outer)	557S-552A[2]
1997-1990	(8,000 lb. Axle B7T042, C5H042, C6H042, C7H042, C7H064, P6S042)	
	Seal Viton (Inner)	370199A[2] ⁵⁷
	Cone/Cup (Inner)	JM205149A-JM205110[2]
	Bearing Assy (Outer)	32207M[2]
1997-1990	(W5S042)	
	Seal (Inner)	710087[2]
	Bearing Assy (Inner)	513046[2]
	Bearing Assy (Outer)	513045[2] ^Z
1996-1992	(12,000 lb. Axle C6H042, C7H042, C7H064)	
	Seal (Inner)	370211A[2] ⁵⁷
	Cone/Cup (Inner)	JF7049A-JF7010[2]
	Bearing Assy (Outer)	33208[2]
1996-1990	(W7R042M Air Brks. Z06 Axle)	
	Seal (Inner)	710084[2]
	Cone/Cup (Inner)	H414245X-H414210[2]
	Bearing Assy (Outer)	513047[2] ^Z
1996-1990	(H/D W7R042)	
	Seal (Inner)	710084[2]
	Cone/Cup (Inner)	H414245X-H414210[2]
	Bearing Assy (Outer)	513047[2] ^Z
1996-1990	(W7R042M Hyd.Brks. Z05 Axle)	
	Seal (Inner)	710088[2]
	Cone/Cup (Inner)	HM212047-HM212011[2]
	Cone/Cup (Outer)	4388-4335[2]
1994-1990	(W7R042T)	
	Seal (Inner)	710088[2]
	Cone/Cup (Inner)	H414245X-H414210[2]
	Bearing Assy (Outer)	513047[2] ^Z
1991	(12,000 lb. Axle Early C6H042, C7H042, C7H064)	
	Seal (Inner)	370211A[2] ⁵⁷
	Cone/Cup (Inner)	JF7049A-JF7010[2]
	Bearing Assy (Outer)	33208[2]
1991	(12,000 lb. Axle Late C6H042, C7H042, C7H064)	
	Seal Viton (Inner)	370212A[2] ⁵⁷
	Cone/Cup (Inner)	JF7049A-JF7010[2]
	Bearing Assy (Outer)	33208[2]
1991-1990	(9,000 lb. Axle B6P042, C6D042)	
	Seal (Inner)	370011A[2] ⁵⁷
	Cone/Cup (Inner)	HM212047-HM212011[2]
	Cone/Cup (Outer)	45282-45220[2]

FRONT WHEEL (cont.)**FWD (cont.)**

1991-1990	(9,000 lb. Axle C7D064)	
	Seal (Inner)	370018A[2] ⁵⁷
	Cone/Cup (Inner)	39581-39520[2]
	Cone/Cup (Outer)	26878-26820[2]
1991-1990	(7,000 lb. Axle F070, B6P042, C5D042, C6D042, C7D042, C7D064, P4T042, P6T042)	
	Seal (Inner)	8976S[2]
	Cone/Cup (Inner)	45284-45220[2]
	Seal (Outer)	370145A[2] ⁵⁷
	Cone/Cup (Outer)	2796-2720[2]
1990	(14,000 lb. Axle C6H042, C7H042, C7H064)	
	Seal Viton (Inner)	370212A[2] ⁵⁷
	Cone/Cup (Inner)	JF7049A-JF7010[2]
	Cone/Cup (Outer)	JM205149A-JM205110[2]
1990	(12,000 lb. Axle B6P042, C6D042, P6T042, S7T042)	
	Seal (Inner)	370011A[2] ⁵⁷
	Cone/Cup (Inner)	HM212047-HM212011[2]
	Cone/Cup (Outer)	45282-45220[2]
1990	(5,000 lb. Axle F050, C5D042, C6D042, C7D042, P4T042)	
	Seal (Inner)	8975S[2]
	Cone/Cup (Inner)	3578A-3525[2]
	Cone/Cup (Outer)	15103S-15243[2]
1990	(5,500 lb. Axle F055, C5D042, C6D042, C7D042, P4T042)	
	Seal (Inner)	8975S[2]
	Cone/Cup (Inner)	3578A-3525[2]
	Cone/Cup (Outer)	15103S-15243[2]

REAR WHEEL**RWD**

1998-1997	(Spicer S150S)(W6R042)	
	Seal (Inner)	370008A[2] ⁵⁷
	Cone/Cup (Inner)	HM212047-HM212011[2]
	Cone/Cup (Outer)	45282-45220[2]
1998-1990	W5S042	
	Seal (Inner)	710085[2]
	Bearing Assy (Inner)	32215[2]
	Seal (Outer)	710086[2]
	Bearing Assy (Outer)	32213M[2]
1997-1990	(Eaton 21065, 22065, 23070, 23085, 23105, 26085 Axle)(B7T042, C6H042, C7H042)	
	Seal (Inner)	370003A[2] ⁵⁷
	Cone/Cup (Inner)	594A-592A[2]
	Cone/Cup (Outer)	580-572[2]
1997-1990	(Eaton 23105 Axle)(C5H042)	
	Seal (Inner)	370023A[2] ⁵⁷
	Cone/Cup (Inner)	594A-592A[2]
	Cone/Cup (Outer)	47686-47620[2]

^ZNon-Cancellable/Non-Returnable⁵⁷Oil Bath Seal

Mfg./Year	Model & Location	Part No.	Mfg./Year	Model & Location	Part No.
CHEVROLET/GMC TRUCK - 1-1/2, 2, 2-1/2 TON - 50, 60, 70, 4500, 5500, 6500, 7500 (cont.)					

REAR WHEEL (cont.)

RWD (cont.)

<p>1997-1990 (Eaton DS341, DT341, DS402 Axle)(C7H064) Seal (Inner)370023A[2]⁵⁷ Cone/Cup (Inner)594A-592A[2] Cone/Cup (Outer)47686-47620[2]</p> <p>1997-1990 (Rockwell 23160 Axle)(C6H042, C7H042) Seal (Inner)370003A[2]⁵⁷ Cone/Cup (Inner)594A-592A[2] Cone/Cup (Outer)580-572[2]</p> <p>1997-1990 (Rockwell SL100, SQ100P Axle)(C7H064) Seal (Inner)370023A[2]⁵⁷ Cone/Cup (Inner)594-592A[2] Cone/Cup (Outer)47686-47620[2]</p> <p>1997-1990 (Eaton 15040 Axle)(B7T042, C6H042, C7H042, P4T042, P6S042) Seal (Inner)370008A[2]⁵⁷ Cone/Cup (Inner)33287-33462[2] Cone/Cup (Outer)3982-3920[2]</p> <p>1997-1990 (Eaton 15040 Axle)(C5D042, C5H042, P4T042) Seal (Inner)370008A[2]⁵⁷ Cone/Cup (Inner)33287-33462[2] Cone/Cup (Outer)3982-3920[2]</p> <p>1996-1991 (Eaton 19050 B7T042, P6S042) Seal (Inner)370024A[2]⁵⁷ Cone/Cup (Inner)47686-47620[2] Cone/Cup (Outer)39590-39520[2]</p> <p>1996-1990 (W6R042) Seal (Inner)710085[2] Bearing Assy (Inner)32215[2] Seal (Outer)710086[2] Bearing Assy (Outer)32213M[2]</p> <p>1996-1990 (Eaton 19050, 19055 Axle)(C5D042, C6H042, C7H042) Seal (Inner)370023A[2]⁵⁷ Cone/Cup (Inner)47686-47620[2] Cone/Cup (Outer)39590-39520[2]</p> <p>1994-1990 (W7R042HD, W7R042T) Seal (Inner)710089[2] Bearing Assy (Inner)32219M[2] Seal (Outer)710090[2] Bearing Assy (Outer)32218M[2]</p> <p>1994-1990 (W7R042M) Seal (Inner)710278[2] Bearing Assy (Inner)32216[2] Seal (Outer)710277[2] Bearing Assy (Outer)32215[2]</p>

REAR WHEEL (cont.)

RWD (cont.)

<p>1992-1990 50, 60, 70 Ser. (17500 lb. H175, T175 Axle)(B6P042, C6D042, C7D042, C7D064, P6T04) Seal (Inner)370009A[2]⁵⁷ Cone/Cup (Inner)495AX-493[2] Seal (Outer)6864S[2] Cone/Cup (Outer)39590-39520[2]</p> <p>1992-1990 50, 60, 70 Ser. (19000 lb. Axle) Seal (Inner)370023A[2]⁵⁷ Cone/Cup (Inner)594A-592A[2] Cone/Cup (Outer)47686-47620[2]</p> <p>1991-1990 40, 50, 60 Ser. (H110, 11000 lb. Axle)(B6P042, C6D042, P6T042) Seal (Inner)370046A[2]⁵⁷ Cone/Cup (Inner)3984-3920[2] Cone/Cup (Outer)28682-28622A[2]</p> <p>1991-1990 40, 50, 60 Ser. (H135, 13500 lb. Axle)(B6P042, C6D042, P6T042) Seal (Inner)370046A[2]⁵⁷ Cone/Cup (Inner)3984-3920[2] Cone/Cup (Outer)28682-28622A[2]</p> <p>1991-1990 (Eaton 17121, 17221 Axle)(B6P042, C6D042, P6T042) Seal (Inner)370023A[2]⁵⁷ Cone/Cup (Inner)47686-47620[2] Cone/Cup (Outer)39590-39520[2]</p> <p>1991-1990 50, 60 Ser. (15000 lb. H150, T150 Axle)(B6P042, C6D042, P6T042) Seal (Inner)370009A[2]⁵⁷ Cone/Cup (Inner)33287-33472[2] Seal (Outer)6864S[2] Cone/Cup (Outer)3982-3925[2]</p>

SINGLE REAR AXLE

Differential Rebuild Kit

<p>1997-1990 (Eaton 26085P, 26085T Axles) KitDRK72A</p> <p>1997-1990 (Eaton 19050T, 19055D, 19055S, 19055T Axles) KitDRK23D</p> <p>1997-1990 (Eaton 15040T Axle) KitDRK24</p> <p>1994-1990 (Dana/Spicer M185T, M190T, M220T Axles) KitDRK214</p> <p>1991-1990 (Eaton 17401 Axle) KitDRK23B</p> <p>1991-1990 (Eaton 16121 Axle) KitDRK23B</p>
--

⁵⁷Oil Bath Seal

Mfg./Year	Model & Location	Part No.	Mfg./Year	Model & Location	Part No.
CHEVROLET/GMC TRUCK - 1-1/2, 2, 2-1/2 TON - 50, 60, 70, 4500, 5500, 6500, 7500 (cont.)					

SINGLE REAR AXLE**Differential**

1997-1990 (Eaton 15040T Axle)	
Cone/Cup (LH)	498-493
Cone/Cup (RH)	33275-33472
1997-1990 (Eaton 26085P, 26085T Axles)	
Cone/Cup (LH)	68450-68712
Cone/Cup (RH)	42346-42584
1997-1990 (Rockwell 23160 Axle)	
Bearing Assy (LH)	32021X
Bearing Assy (RH)	32021X
1997-1990 (Eaton 19050T, 19055D, 19055S, 19055T Axles)	
Cone/Cup (LH)	42381-42584
Cone/Cup (RH)	495A-493
1997-1990 (Eaton 15040S Axle)	
Cone/Cup (LH)	3994-3920
Cone/Cup (RH)	497-493
1997-1990 (Eaton 21065S, 23070S, 23105S Axles)	
Cone/Cup (LH)	598-592A
Cone/Cup (RH)	497-493
1997-1990 (Eaton 21065T Axle)	
Cone/Cup (LH)	56425-56650
Cone/Cup (RH)	497-493
1997-1990 (Eaton 23070P, 23070T Axles)	
Cone/Cup (LH)	56425-56650
Cone/Cup (RH)	497-493
1997-1990 (Eaton 17200, 17220, 17221, 17800, 17801, 18221, 7800 Axles)	
Cone/Cup (LH)	56425-56650
Cone/Cup (RH)	497-493
1995-1990 (Isuzu R065 Axle)	
Cone/Cup (LH)	3984-3920
Cone/Cup (RH)	3984-3920
1995-1990 (Isuzu R077 Axle)	
Bearing Assy (LH)	30214
Bearing Assy (RH)	30214
1994-1990 (Isuzu R094 Axle)	
Bearing Assy (LH)	32216
Bearing Assy (RH)	32216
1994-1990 (Dana/Spicer M185T, M190S, M190T, M220T Axles)	
Cone/Cup (LH)	JM822049-JM822010
Cone/Cup (RH)	JM716649-JM716610
1991-1990 (Eaton 17401 Axle)	
Cone/Cup (LH)	567-563
Cone/Cup (RH)	3994-3920
1991-1990 (Eaton 16121 Axle)	
Cone/Cup (LH)	567-563
Cone/Cup (RH)	3994-3920

SINGLE REAR AXLE**Pinion**

1997-1990 (Eaton 23070P, 23070T Axles)	
Cone/Cup (Inner)	78215C-78551
Seal (Outer)	712937[2]
Cone/Cup (Outer)	72212C-72487
Cylindrical Bearing	MUB5207UM[2]
1997-1990 (Eaton 26085P, 26085T Axles)	
Cone/Cup (Inner)	78215C-78551
Seal (Outer)	712937[2]
Cone/Cup (Outer)	72212C-72487
Cylindrical Bearing	MUS1308UM[2]
1997-1990 (Rockwell 23160 Axle)	
Cone/Cup (Inner)	9278-9220
Seal (Outer)	417987N[2]
Cone/Cup (Outer)	HM813843-HM813810
1997-1990 (Eaton 19050S Axle)	
Cone/Cup (Inner)	72200C-72487
Seal (Outer)	9773R[2]
Cone/Cup (Outer)	HM903249-HM903210
Cylindrical Bearing	RUB1570UM[2]
1997-1990 (Eaton 19050T, 19055D, 19055S, 19055T Axle)(2.375" Pinion Shaft)	
Cone/Cup (Inner)	55175C-55437
Seal (Outer)	9773R[2]
Cone/Cup (Outer)	55175C-55437
Cylindrical Bearing	MUS1307UM[2]
1997-1990 (Eaton 15040S Axle)	
Cone/Cup (Inner)	55175C-55437
Seal (Outer)	9773R[2]
Cone/Cup (Outer)	HM903249-HM903210
Cylindrical Bearing	MUB1305UDM[2]
1997-1990 (Eaton 15040T Axle)	
Cone/Cup (Inner)	HM903249-HM903210
Seal Kit (Outer)	722250S[2] ²⁰
Cone/Cup (Outer)	HM903249-HM903210
Cylindrical Bearing	MU1305TDM[2]
1997-1990 (Eaton 21065S Axle)	
Cone/Cup (Inner)	78215C-78551
Seal (Outer)	9773R[2]
Cone/Cup (Outer)	55200C-55437
Cylindrical Bearing	MUS1308UM[2]
1997-1990 (Eaton 21065T Axle)	
Cone/Cup (Inner)	72200C-72487
Seal (Outer)	9773R[2]
Cone/Cup (Outer)	55200C-55437
Cylindrical Bearing	MUS1307UM[2]
1997-1990 (Eaton 23070S, 23105S Axles)	
Cone/Cup (Inner)	H913842-H913810
Seal (Outer)	712937[2]
Cone/Cup (Outer)	72212C-72487
Cylindrical Bearing	MUS1308UM[2]
1995-1990 (Isuzu R065, R077 Axles)	
Bearing Assy (Inner)	30310
Seal (Outer)	710276[2]
Bearing Assy (Outer)	30309M
1994-1990 (Eaton 1504T Axle)	
Cone/Cup (Inner)	HM903249-HM903210
Cone/Cup (Outer)	HM903249-HM903210

²⁰Seal Kit

Mfg./Year	Model & Location	Part No.	Mfg./Year	Model & Location	Part No.
CHEVROLET/GMC TRUCK - 1-1/2, 2, 2-1/2 TON - 50, 60, 70, 4500, 5500, 6500, 7500 (cont.)					

SINGLE REAR AXLE (cont.)

Pinion (cont.)

1994-1990	(Isuzu R094 Axle)	
	Bearing Assy (Inner)	30310
	Seal (Outer)	710275[2]
	Bearing Assy (Outer)	30311
1994-1990	(Isuzu R105 Axle)	
	Bearing Assy (Inner)	30312
	Seal (Outer)	710275[2]
	Cone/Cup (Outer)	580-572
1994-1990	(Dana/Spicer M185T, M190S, M190T, M220T Axles)	
	Cone/Cup (Inner)	72225C-72487
	Seal (Outer)	477163N[2]
	Cone/Cup (Outer)	55200C-55437
	Cylindrical Bearing	MUS1308UM
1994-1990	(15,000 lb. 1 Spd. Axle)	
	Cone/Cup (Inner)	HM803149-HM803110
	Cone/Cup (Outer)	HM803149-HM803110
1994-1990	(15,000 lb. 2 Spd. Axle)	
	Cone/Cup (Inner)	HM903249-HM903210
	Cone/Cup (Outer)	HM903249-HM903210
1992-1990	(11,000 lb. Axle)	
	Cone/Cup (Inner)	M903345-M903310
	Cone/Cup (Outer)	44143-44348
1992-1990	(13,500 lb. Axle)	
	Cone/Cup (Inner)	HM803146-HM803110
	Cone/Cup (Outer)	44143-44348
1992-1990	(17,000 lb. 1 Spd. Axle)	
	Cone/Cup (Inner)	55200C-55437
	Cone/Cup (Outer)	HM804846-HM804810
1992-1990	(17,000 lb. 2 Spd. Axle)	
	Cone/Cup (Inner)	55175C-55437
	Cone/Cup (Outer)	55175C-55437
1992-1990	(Eaton 34RT Axle)	
	Cone/Cup (Inner)	55200C-55437
	Cone/Cup (Outer)	55200C-55437
1992-1990	(R S SLHR Axle)	
	Cone/Cup (Inner)	72200C-72487
	Cone/Cup (Outer)	72188C-72487
1991-1990	(Eaton 16121, 17401 Axles)(2.625" Pinion Shaft)	
	Cone/Cup (Inner)	HM903249-HM903210
	Seal (Outer)	712625[2]
	Cone/Cup (Outer)	HM903249-HM903210
	Cylindrical Bearing	MUS1307UM
1991-1990	(Eaton 16121, 17401 Axles)(2.375" Pinion Shaft)	
	Cone/Cup (Inner)	HM903249-HM903210
	Seal (Outer)	712375[2]
	Cone/Cup (Outer)	HM903249-HM903210
	Cylindrical Bearing	MUS1307UM
1991-1990	(379/6.2L Diesel)	
	Seal	5163
1991-1990	(454/7.4L)	
	Seal	5072

TANDEM REAR AXLE - FRONTMOST AXL

Differential Rebuild Kit

1997-1990	(Eaton DS341 Axle)	
	Kit	DRK196

TANDEM REAR AXLE - FRONTMOST AXL (cont.)

Differential Rebuild Kit (cont.)

1997-1990	(Eaton DT341, DT381, DS402, DT402 Axles)	
	Kit	DRK207

Differential

1997-1990	(Rockwell SL100P, SQ100P Axles)	
	Cone/Cup (LH)	JM716649-JM716610
	Cone/Cup (RH)	JM716649-JM716610
1997-1990	(Eaton DS341 Axle)	
	Cone/Cup (LH)	497-493
	Cone/Cup (RH)	567-563
1997-1990	(Eaton DT341, DT381, DS402, DT402 Axles)	
	Cone/Cup (LH)	497-493
	Cone/Cup (RH)	56425-56650

Pinion

1997-1990	(Rockwell SL100P, SQ100P Axles)	
	Cone/Cup (Inner)	72212C-72487
	Cone/Cup (Outer)	72212C-72487
	Cylindrical Bearing	RU1570UM
1997-1990	(Eaton DS341 Axle)	
	Seal	9773R
	Cone/Cup (Inner)	55200C-55437
	Cone/Cup (Outer)	55200C-55437
	Cylindrical Bearing	MUS1307UM
1997-1990	(Eaton DT341, DT381, DS402, DT402 Axles)	
	Cone/Cup (Inner)	72218C-72487
	Cone/Cup (Outer)	HM807049-HM807010
	Cylindrical Bearing	MUS1307UM

Through Shaft - Input Shaft

1997-1990	(Eaton DS341, DT341, DT381, DS402, DT402 Axles)	
	Seal	475012N[2]
	Cone/Cup	3979-JM511910[2]

Through Shaft - Output Shaft

1997-1990	(Eaton DS341, DT341, DT381, DS402, DT402 Axles)	
	Cone/Cup (Inner)	29675-29620[2]
	Seal (Outer)	475003N[2]
	Ball Bearing (Outer)	MA1209EL[2]

TANDEM REAR AXLE - REARMOST AXLE

Differential Rebuild Kit

1997-1990	(Eaton DT341, DS402, DT402 Axles)	
	Kit	DRK207
1997-1990	(Eaton DS341 Axle)	
	Kit	DRK196

Mfg./Year	Model & Location	Part No.	Mfg./Year	Model & Location	Part No.
CHEVROLET/GMC TRUCK - 1-1/2, 2, 2-1/2 TON - 50, 60, 70, 4500, 5500, 6500, 7500 (cont.)					

TANDEM REAR AXLE - REARMOST AXLE

Differential

1997-1990	(Rockwell SL100P, SQ100P Axles)	
	Cone/Cup (LH)	JM716649-JM716610
	Cone/Cup (RH)	JM716649-JM716610
1997-1990	(Eaton DT341, DS402, DT402 Axles)	
	Cone/Cup (LH)	497-493
	Cone/Cup (RH)	56425-56650
1997-1990	(Eaton DS341 Axle)	
	Cone/Cup (LH)	497-493
	Cone/Cup (RH)	567-563

Pinion

1997-1990	(Rockwell SL100P, SQ100P Axles)	
	Seal	3905
	Cone/Cup (Inner)	72212C-72487
	Cone/Cup (Outer)	72212C-72487
	Cylindrical Bearing	RU1570UM
1997-1990	(Eaton DT341, DS402, DT402 Axles)	
	Cone/Cup (Inner)	72218C-72487
	Cone/Cup (Outer)	HM807049-HM807010
	Cylindrical Bearing (Pilot)	MUS1307UM
1997-1990	(Eaton DS341 Axle)	
	Seal	9773R
	Cone/Cup (Inner)	55200C-55437
	Cone/Cup (Outer)	55200C-55437
	Cylindrical Bearing	MUS1307UM

CLUTCH

Pilot Bearing

1997-1990	403 (6.6)(3208 Caterpillar Diesel)	
	Ball Bearing	305DD
1994-1990	5.8, 6.1, 6.5, 8.4 (Diesel)	
	Ball Bearing	205FF
1991-1990	350, 366, 427 (Gas)	
	Ball Bearing	205FF
1991-1990	4 53, 8.2 L (Detroit Diesel)	
	Ball Bearing	205FF

Release Bearing

1997-1995	7.1 (Turbo Diesel)(335mm Cl.)	
	Bearing Assy	613011
1997-1995	7.1 (Turbo Diesel)(380mm Cl.)	
	Bearing Only	613014
1997-1990	366 (6.0) (Spicer 13" Cl.)	
	Bearing Assy	614057
1997-1990	427 (7.0) (Spicer 13" Cl.)	
	Bearing Assy	614057
1997-1990	366 (6.0) (14" Cl.)	
	Bearing Assy	614098
1997-1990	500 (8.2)(Diesel)(Turbo Diesel)(14" Cl.)	
	Bearing Assy	614098

CLUTCH (cont.)

Release Bearing (cont.)

1997-1990	427 (7.0) (14" Cl.)	
	Bearing Assy	614098
1996-1990	403 (6.6)(Turbo Diesel)(14" Cl.)	
	Bearing Assy	614098
1996-1990	403 (6.6)(Turbo Diesel)(Spicer 13" Cl.)	
	Bearing Assy	614057
1994-1990	8.4 (Turbo Diesel)(355mm Cl.)	
	Bearing Only	613009
1994-1990	8.4 (Turbo Diesel)(355mm Cl.)	
	Bearing Only	613009
1994-1990	6.5 (Turbo Diesel)(330mm Cl.)	
	Bearing Assy	614018 ⁴²
1994-1990	5.8 (Turbo Diesel)(355mm Cl.)	
	Bearing Only	613009
1994-1990	6.5 (Turbo Diesel)(355mm Cl.)	
	Bearing Only	613009
1994-1990	8.4 (Turbo Diesel)(380mm Cl.)	
	Bearing Only	613009
1991-1990	500 (8.2)(Diesel)(Turbo Diesel)(14" Cl.)(1.5" spline)	
	Bearing Assy	614024
1991-1990	500 (8.2)(Detroit Diesel)(Lipe flywheel)	
	Bearing Only	GE2505C
1991-1990	500 (8.2)(Detroit Diesel)(flat flywheel)	
	Bearing Assy	614065
1991-1990	500 (8.2)(Diesel)(Turbo Diesel)(14" Cl.)(1.75" spline)	
	Bearing Assy	614065
1991-1990	454 (7.4) (14" Cl.)	
	Bearing Assy	614024
1991-1990	VT225 (14" Cl.)	
	Bearing Assy	614024
1991-1990	292 (4.8)(12" Cl.)	
	Bearing Assy	614018 ⁴²
1991-1990	(3208 Caterpillar Diesel)	
	Bearing Assy	614024
1991-1990	432 (7.2)(14" single Disc Cl.)	
	Bearing Assy	614024
1991-1990	350 (5.7)(12" Cl.)	
	Bearing Assy	614018 ⁴²
1991-1990	350 (5.7)(13" Cl.)	
	Bearing Only	CA02135C
1991-1990	366 (6.0) (13" Cl.)	
	Bearing Only	CA02135C
1990	6.5 (Diesel)(Turbo Diesel)(330mm Cl.)	
	Bearing Only	613009
1990	427 (7.0) (14" Cl.) FS6106A	
	Bearing Assy	614097
1990	500 (8.2)(Diesel)(Turbo Diesel)(14" Cl.)	
	Bearing Assy	614097
1990	427 (7.0) (Spicer 14" Cl.)	
	Bearing Assy	614096
1990	500 (8.2)(Diesel)(Turbo Diesel)(14" Spicer 5xxx Cl.)	
	Bearing Assy	614096

⁴²Self-Aligning Brg

Mfg./Year	Model & Location	Part No.	Mfg./Year	Model & Location	Part No.
CHEVROLET/GMC TRUCK - 1-1/2, 2, 2-1/2 TON - 50, 60, 70, 4500, 5500, 6500, 7500 (cont.)					

CLUTCH (cont.)

Release Bearing (cont.)

1990	636/10.4L (Diesel)(Turbo Diesel)(14" Cl.)(1.75" spline)	
	Bearing Assy	614065
1990	427 (7.0)	
	Bearing Only	CA02135C
1990	427 (7.0) (14" single plate Cl.)	
	Bearing Assy	614024
1990	500 (8.2)(Diesel)(Turbo Diesel)(14" Spicer 4054 Cl.)	
	Bearing Only	CA02135C
1990	500 (8.2)(Diesel)(Turbo Diesel)(14" push type Cl.)	
	Bearing Only	GE2505C
1990	636/10.4L (Diesel)(Turbo Diesel)(14" single plate Cl.)	
	Bearing Assy	614024

DRIVESHAFT SUPPORT

1997-1990	(Spicer 1480)(1.5748" 40mm Brg. I.D.)	
	Hanger Bearing Assy	HB88508AA[2]
1997-1990	(Spicer 1760)(2.3622" 60mm Brg. I.D.)	
	Hanger Bearing Assy	HB88512AHD[2]
1997-1990	(Spicer 1710)(1.9685" 50mm Brg. I.D.)	
	Hanger Bearing Assy	HB88510[2]
1997-1990	(Spicer 1550, 1610, 1650)(1.7717" 45mm Brg. I.D.)(end yoke style)	
	Ball Bearing	88509[2]
	Hanger Bearing Assy	HB88509A[2]
1997-1990	(Spicer 1550, 1610, 1650)(1.7717" 45mm Brg. I.D.)(slip yoke style)	
	Ball Bearing	88509[2]
	Hanger Bearing Assy	HB88509[2]
1996-1990	(Cleveland 055)(1.5748" 40mm Brg. I.D. 2.250" height)	
	Hanger Bearing Assy	HB88508AB[2]
1991-1990	(Spicer 1310, 1350)(1.5748" 40mm Brg. I.D.)	
	Ball Bearing	88508[2]
	Hanger Bearing Assy	HB88508C[2]
1990	(Rockwell 68WB)(1.9685" Brg. I.D.)	
	Hanger Bearing Assy	HB88510[2]
1990	(Spicer 1410)(1.3780" 35mm Brg. I.D.)	
	Ball Bearing	88107[2]
	Hanger Bearing Assy	HB88107A[2]
1990	(Rockwell 58WB)(1.7717" 45mm Brg. I.D.)	
	Ball Bearing	88509[2]
	Hanger Bearing Assy	HB88509B[2]

CRANKSHAFT FRONT SEAL

6 Cylinder

1994-1990	6494cc/6.5L (Turbo Diesel)	
	Seal Viton	710350
	Repair Sleeve	KWK99235

8 Cylinder

1996-1990	366/6.0L, 427/7.0L	
	Seal	3945
	Repair Sleeve	KWK99233

CRANKSHAFT REAR SEAL

6 Cylinder

1994-1990	6494cc/6.5L (Turbo Diesel)	
	Seal Viton	710349
	Repair Sleeve	KWK99413

8 Cylinder

1996-1990	366/6.0L, 427/7.0L	
	Seal Viton	2261
	Repair Sleeve	KWK99435

Mfg./Year	Model & Location	Part No.	Mfg./Year	Model & Location	Part No.
CHRYSLER - FRONT DRIVE - Cirrus, Sebring					

FRONT WHEEL**FWD**

2008-2007	Sebring (ABS)	
	Hub Unit Bearing	HA590219[2] ²⁵
2008-2007	Sebring (Non-ABS)	
	Hub Unit Bearing	HA590214[2] ²⁵
2006-1995	Sebring (Convertible)(Sedan)	
	Hub Unit Bearing	513138[2]
2005-1995	Sebring (Coupe)	
	Hub Unit Bearing	513157[2]
2000-1995	Cirrus	
	Hub Unit Bearing	513138[2]

REAR WHEEL**FWD**

2008-2007	Sebring (Disc)	
	Hub Unit Bearing	HA590216[2] ²⁵
2008-2007	Sebring (Drum)	
	Hub Unit Bearing	HA590221[2] ²⁵
2006-2005	Sebring (Sedan)(Non-ABS)	
	Hub Unit Bearing	512154[2]
2006-2001	Sebring (Sedan)(ABS)	
	Hub Unit Bearing	512220[2]
2006-1998	Sebring (Convertible)(ABS)	
	Hub Unit Bearing	512220[2]
2005-2001	Sebring (Coupe)(ABS)	
	Hub Unit Bearing	HA590306[2]
	Bearing Module (Opt)	512136[2]
2005-2001	Sebring (Coupe)(Non-ABS)	
	Bearing Module	512136[2]
2004-2003	Sebring (Sedan)(Non-ABS)	
	Hub Unit Bearing	512154[2]
2000-1999	Cirrus (Non-ABS)	
	Hub Unit Bearing	512154[2]
2000-1998	Cirrus (ABS)	
	Hub Unit Bearing	512220[2]
2000-1997	Sebring (Coupe)(Non-ABS)	
	Bearing Module	512136[2]
2000-1996	Sebring (Convertible)(Non-ABS)	
	Hub Unit Bearing	512154[2]
2000-1996	Sebring (Coupe)(ABS)	
	Hub Unit Bearing	HA590306[2]
	Bearing Module (Opt)	512136[2]
1998-1995	Cirrus (Non-ABS)	
	Hub Unit Bearing	512154[2]
1997-1996	Sebring (Convertible)(ABS)	
	Hub Unit Bearing	512133[2]
1997-1995	Cirrus (ABS)	
	Hub Unit Bearing	512133[2]
1995	Sebring (Coupe)(ABS)	
	Hub Unit Bearing	512133[2]
1995	Sebring (Coupe)(Non-ABS)	
	Hub Unit Bearing	512154[2]

CLUTCH**Release Bearing**

2000-1995	(4 Cyl.)	
	Bearing Assy	614121
1998-1995	(6 Cyl.)	
	Bearing Assy	614092

4-SPEED AUTOMATIC TRANSAXLE**Differential**

2006-1997	(A604 41TE)(Prod. from mid 1997 on)	
	Seal (LH)	3459S
	Cone/Cup (LH)	NP889967-NP714580
	Seal (RH)	3459S
	Cone/Cup (RH)	NP952605-JL69310P
2006-1993	(42LE)	
	Set	SET36[2]
1997-1996	(A604 41TE)(Prod. thru mid 1997)	
	Cone/Cup (LH)	NP889967-NP714580
	Cone/Cup (RH)	JL69348-JL69310
1995	(A604 41TE)	
	Cone/Cup	JL69348-JL69310[2]

Torque Converter / Frt Pump

2006-1995		
	Seal	331228H
	Repair Sleeve	KWK99149

Transfer Shaft

2006-2002	(40TE, 41TE)	
	Cone/Cup (Inner)	NP853895-NP352518[2]
	Cone/Cup (Outer)	NP716862-LM501310[2]
2001-1996	(A604, 41TE)	
	Cone/Cup (Inner)	NP853895-NP352518[2]
	Set (Outer)	SET45[2]
1995	(A604, 41TE)	
	Cone/Cup (Inner)	13687-13623X[2]
	Set (Outer)	SET45[2]

Output Shaft

2008-1995	(41TE)	
	Seal	3459S[2]
	Repair Sleeve	KWK99147[2]
2006-2001	(40TE, 41TE)	
	Cone/Cup (Outer)	NP117885-LM300811[2]
	Cone/Cup (Inner)	NP952605-JL69310P[2]
2000-1997	(A604 41TE)(Prod. from mid 1997 on)	
	Cone/Cup (Outer)	LM300848-LM300811[2]
	Cone/Cup (Inner)	NP952605-JL69310P[2]
1997-1995	(A604 41TE)(Prod. thru mid 1997)	
	Cone/Cup (Outer)	LM300848-LM300811[2]
	Cone/Cup (Inner)	JL69348-JL69310[2]

Manual Shaft

2008-2007	(40TES, 41TES)	
	Seal	8609
2006-1995	(40TE, 41TE)	
	Seal	8609

²⁵New Item, Check For Availability

CHRYSLER - FRONT DRIVE - Cirrus, Sebring (cont.)

5-SPEED MANUAL TRANSAXLE

Differential

2003-1995	(A578)	
Seal		3459S[2]
Set		SET11[2]
Repair Sleeve		KWK99157[2]

Input Shaft

2003-1995	(A578)	
Seal (Frt)		3732S
Set (Frt)		SET4[2]
Repair Sleeve		KWK99106
Set (Rr)		SET5[2]

Selector Shaft Seal/Man. Shaft

2003-1995	(A578)	
Seal		3816

OIL PUMP

4 Cylinder

2005-2001	2350/2.4L (SOHC)	
Seal		222025
Repair Sleeve		KWK99078

CAMSHAFT SEAL

4 Cylinder

2006-1995	122/2.0L (DOHC), 148/2.4L (DOHC)	
Seal Viton		320249[2]
Repair Sleeve		KWK99139[2]
2005-2001	2350cc/2.4L (SOHC)	
Seal		3771[2]
Repair Sleeve		KWK99139[2]

6 Cylinder

2005-2001	181/3.0L	
Seal		3771[2]
Repair Sleeve		KWK99139[2]
2000-1995	2497cc/2.5L	
Seal (Frt)		223010[2]
Repair Sleeve (Frt)		KWK99114[2]
Seal (Rr)		710302[2]
Repair Sleeve (Rr)		KWK99114

CRANKSHAFT FRONT SEAL

4 Cylinder

2006-1995	148/2.4L (DOHC)	
Seal Viton		320348
Repair Sleeve		KWK99128
2005-2001	2350cc/2.4L (SOHC)	
Seal		224460
2000-1995	122/2.0L (SOHC)	
Seal Viton		320348
Repair Sleeve		KWK99128

CRANKSHAFT FRONT SEAL

6 Cylinder

2008-2007	213/3.5L	
Seal		3638
Repair Sleeve		KWK99112
2008-2001	167/2.7L (DOHC)	
Seal		710469
2005-2001	181/3.0L	
Seal		223750
2000-1995	2497cc/2.5L	
Seal		223750

CRANKSHAFT REAR SEAL

4 Cylinder

2006-2001	2429cc/2.4L (DOHC)	
Seal Viton		710056
Seal PTFE H/D		5279
2005-2001	2350/2.4L (SOHC)	
Seal Viton		710235
2000-1995	122/2.0L, 148/2.4L	
Seal Viton		710056
Seal PTFE H/D		5279

6 Cylinder

2008-2007	215/3.5L	
Seal Viton		710056
Seal PTFE H/D		5279
2008-2001	167/2.7L (DOHC)	
Seal Viton		710056
Seal PTFE H/D		5279
2005-2001	181/3.0L	
Seal Viton		710056
Seal PTFE H/D		5279
2000-1995	2497cc/2.5L	
Seal Viton		710056
Seal PTFE H/D		5279

Mfg./Year Model & Location Part No. Mfg./Year Model & Location Part No.

CHRYSLER - FRONT DRIVE - 300M, Concorde, Daytona, Dynasty, Imperial, LeBaron, LHS, New Yorker**FRONT WHEEL****FWD**

2004-2001	Concorde	
	Hub Unit Bearing	513089[2]
2004-1998	300M	
	Hub Unit Bearing	
	(Speed Sensor on CV)	513089[2]
2001-1994	LHS	
	Hub Unit Bearing	
	(Speed Sensor on CV)	513089[2]
2000-1998	Concorde	
	Hub Unit Bearing	513089[2]
1997-1993	Concorde	
	Hub Unit Bearing	513089[2]
1996-1994	New Yorker	
	Hub Unit Bearing	513089[2]
1995-1994	LeBaron	
	Hub Unit Bearing	513075[2]
1993-1991	Daytona, Dynasty, Imperial, LeBaron, New Yorker	
	Hub Unit Bearing	513075[2]
1990	Daytona, Dynasty, LeBaron (Exc. Turbo)	
	Seal	5604[2] ⁵⁶
	Ball Bearing (Opt)	513006[2]
	Hub Unit Bearing (4 Stud)	518501[2] ⁶²
	Hub Unit Bearing (5 Lug Whl.)	518502[2] ⁶³
1990	Imperial, New Yorker	
	Seal	5604[2] ⁵⁶
	Hub Unit Bearing	513075[2]
1990	LeBaron (Turbo)	
	Seal	5604[2] ⁵⁶
	Hub Unit Bearing	513075[2]

REAR WHEEL**FWD**

2004-1999	300M	
	Hub Unit Bearing	512029[2]
2004-1993	Concorde	
	Hub Unit Bearing	512029[2]
2001-1994	LHS, New Yorker	
	Hub Unit Bearing	512029[2]
1995-1994	LeBaron	
	Seal (Inner)	4099
	Set (Inner)	SET46[2]
	Cone/Cup (Outer) (O.E.)	LM12749F-LM12711[2]
	Set (Outer) (Opt. Non-Polymer Set)	SET16[2]
1993-1990		
	Seal (Inner)	4099[2]
	Set (Inner)	SET46[2]
	Cone/Cup (Outer) (O.E.)	LM12749F-LM12711[2]
	Set (Outer) (Opt. Non-Polymer Set)	SET16[2]

CLUTCH**Release Bearing**

1995-1991	3.0L	
	Bearing Assy	614092
1993-1990	(4 Cyl.)	
	Bearing Assy	614092

3-SPEED AUTOMATIC TRANSAXLE**Differential**

1995-1990	(A413, A470, 31TH)	
	Seal	3459S[2]
	Repair Sleeve (Opt)	KWK99157[2]
	Set	SET11[2]

Input Shaft

1995-1990	(A413, A470, 31TH)	
	Seal	331228H
	Repair Sleeve	KWK99149

Transfer Shaft

1995-1990	(A413, A470, 31TH)	
	Set	SET11[2]

Output Shaft

1995-1990	(A413, A470, 31TH)	
	Seal	3459S[2]
	Set	SET17[2]
	Repair Sleeve	KWK99157[2]

Manual Shaft

1995-1990	(A413, A470, 31TH)	
	Seal	8609

4-SPEED AUTOMATIC TRANSAXLE**Differential**

2004-1993	(A606, 42LE)	
	Seal	3459S[2]
	Repair Sleeve	KWK99157[2]
	Set	SET36[2]
1995-1990	(A604 41TE)	
	Seal	3459S[2]
	Set	SET11[2]
	Repair Sleeve	KWK99157[2]

Torque Converter / Frt Pump

2004-1993	(41TE, 42LE)	
	Seal	331228H
	Repair Sleeve	KWK99149

⁵⁶Opt. Kit = Seal 3948 & Sleeve ⁶²Kit = Plate, Gasket, 3 Bolts, Studded Spindle, Seal, & Bearing⁶³Kit = Plate, Gasket, 3 Bolts, Studded Spindle, Seal, & Bearing

Mfg./Year Model & Location Part No. Mfg./Year Model & Location Part No.

CHRYSLER - FRONT DRIVE - 300M, Concorde, Daytona, Dynasty, Imperial, LeBaron, LHS, New Yorker (cont.)

4-SPEED AUTOMATIC TRANSAXLE

Transfer Shaft

- 2004-2000 (A606, 42LE)
 - Seal (Outer) 4889
 - Cone/Cup (Outer) 26131H-NP941813[2]
 - Seal (Inner) 4990
 - Cone/Cup (Inner) M802048CP-M802011AP
- 1999-1993 (A606, 42LE)
 - Seal (Outer) 4889
 - Cone/Cup (Outer) 26131H-26334[2]
 - Seal (Inner) 4990
 - Cone/Cup (Inner) M802048CP-M802011AP[2]
- 1995-1993 (41TE)
 - Cone/Cup (Inner) 13687-13623X[2]
 - Set (Outer) SET45[2]

Output Shaft

- 2004-2001 (A606, 42LE)
 - Cone/Cup (Outer) NP952605-JL69310P[2]
 - Cone/Cup (Inner) NP117885-LM300811[2]
 - Seal (LH) 4738N
 - Seal (RH) 4748N
- 2000-1997 (A606 42LE)(Prod. from mid 1997 on)
 - Cone/Cup (Outer) NP952605-JL69310P[2]
 - Cone/Cup (Inner) LM300848-LM300811[2]
 - Seal (LH) 4738N
 - Seal (RH) 4748N

Manual Shaft

- 2004-1990 (A604 41TE)
 - Seal 8609[2]

5-SPEED MANUAL TRANSAXLE

Differential

- 1993-1990 (A465, A520, A523, A525, A543, A555, A568)
 - Seal 3459S[2]
 - Set SET11[2]
 - Repair Sleeve KWK99157[2]

Input Shaft

- 1992-1990 (A465, A520, A523, A525, A543, A555, A568)
 - Seal (Frt) 3732S
 - Set (Frt) SET4
 - Repair Sleeve (Frt) KWK99106
 - Set (Rr) SET5

Selector Shaft Seal/Man. Shaft

- 1995-1990 (A465, A520, A523, A525, A543, A555, A568)
 - Seal 3816

CAMSHAFT SEAL

4 Cylinder

- 1994-1990 153/2.5L
 - Seal 3655S
 - Repair Sleeve KWK99139
- 1990 122/2.0L, 135/2.2L
 - Seal 3655S
 - Repair Sleeve KWK99139

6 Cylinder

- 2004-1998 3200cc/3.2L (SOHC), 3518cc/3.5L (SOHC)
 - Seal 714655[2]
 - Repair Sleeve KWK99112[2]
- 1997-1993 215/3.5L
 - Seal 714655[2]
 - Repair Sleeve KWK99112[2]
- 1995-1994 181/3.0L
 - Seal 3771[2]
 - Repair Sleeve KWK99139[2]

CRANKSHAFT FRONT SEAL

4 Cylinder

- 1994-1990 135/2.2L, 153/2.5L
 - Seal 3638
 - Repair Sleeve KWK99112

6 Cylinder

- 2004-1998 167/2.7L (DOHC)
 - Seal 710469
- 2004-1994 215/3.5L
 - Repair Sleeve KWK99139
- 2001-1998 197/3.2L
 - Seal 1987S
 - Repair Sleeve KWK99139
- 1997-1990 201/3.3L, 230/3.8L
 - Seal 3638
 - Repair Sleeve KWK99112
- 1995-1990 181/3.0L
 - Seal 223750

CRANKSHAFT REAR SEAL

4 Cylinder

- 1994-1990 135/2.2L, 153/2.5L
 - Seal Viton 710056
 - Seal PTFE H/D 5279
 - Seal Kit 5279A²⁰

6 Cylinder

- 2004-1990
 - Seal Viton 710056
 - Seal PTFE H/D 5279

²⁰Seal Kit

Mfg./Year Model & Location Part No. Mfg./Year Model & Location Part No.

CHRYSLER - FRONT DRIVE - Neon (See also Dodge)**FRONT WHEEL****FWD**

2002

Set SET49[2]

2001-2000

Ball Bearing 510057[2]

REAR WHEEL**FWD**

2002-2000

Hub Unit Bearing 512167[2]

CHRYSLER - REAR DRIVE - Crossfire**FRONT WHEEL****RWD**

2008-2004

Seal SL260011[2]

Set (Inner) SET17[2]

Set (Outer) SET12[2]

REAR WHEEL**RWD**

2008-2004

Ball Bearing 513130[2]

REAR AXLE**Pinion**

2005-2004

Cone/Cup (Inner) NP443760-NP564799

CHRYSLER - REAR DRIVE - Prowler (See also Plymouth)**FRONT WHEEL****RWD**

2002-2001

Hub Unit Bearing 513123[2]

REAR WHEEL**RWD**

2002-2001

Hub Unit Bearing 513089[2]

4-SPEED AUTOMATIC TRANSAXLE**Differential**

2002-2001 (A606, 42LE)

Seal 3459S[2]

Set SET36[2]

Repair Sleeve KWK99157[2]

Torque Converter / Frt Pump

2002-2001 (A606, 42LE)

Seal 331228H

Repair Sleeve KWK99149

4-SPEED AUTOMATIC TRANSAXLE**Transfer Shaft**

2002-2001 (A606, 42LE)

Seal (Outer) 4889

Cone/Cup (Outer) 26131H-NP941813

Seal (Inner) 4890

Cone/Cup (Inner) M802048CP-M802011AP

Output Shaft

2002-2001 (A606, 42LE)

Cone/Cup (Outer) NP952605-JL69310P[2]

Cone/Cup (Inner) NP117885-LM300811[2]

Seal (LH) 4738N

Seal (RH) 4748N

Manual Shaft

2002-2001 (A606, 42LE)

Seal 8609[2]

Mfg./Year Model & Location Part No. Mfg./Year Model & Location Part No.

CHRYSLER - REAR DRIVE - Prowler (See also Plymouth) (cont.)

CAMSHAFT SEAL

6 Cylinder

2002-2001 215/3.5L
 Seal 714655[2]
 Repair Sleeve KWK99112[2]

CRANKSHAFT FRONT SEAL

6 Cylinder

2002-2001 215/3.5L
 Seal 3638
 Repair Sleeve KWK99112

CRANKSHAFT REAR SEAL

6 Cylinder

2002-2001 215/3.5L
 Seal Viton 710056
 Seal PTFE H/D 5279

CHRYSLER - REAR DRIVE - 300 Series (2005-on)

FRONT WHEEL

RWD

2008-2005
 Hub Unit Bearing HA590030[2]²⁵

AWD

2009-2005
 Hub Unit Bearing HA590142[2]²⁵

REAR WHEEL

RWD

2008-2005 300
 Hub Unit Bearing HA590142[2]²⁵

AWD

2009-2005
 Hub Unit Bearing HA590142[2]²⁵

4WD FRONT AXLE

Differential

2006-2005
 Cone/Cup (LH) LM503349-LM503310

Pinion

2006-2005
 Cone/Cup (Inner) M88043-M88010
 Cone/Cup (Outer) M88043-M88010

REAR AXLE

Pinion

2006-2005
 Cone/Cup (Inner) NP443760-NP564799

4-SPEED AUTOMATIC TRANSMISSION

Torque Converter

2007-2005 (42RLE)
 Seal 331228H
 Repair Sleeve KWK99149

4-SPEED AUTOMATIC TRANSMISSION

Rear Seal/Ext. Housing

2007-2005 (42RLE)
 Seal 7300S
 Seal Kit 5206⁶⁴

CAMSHAFT SEAL

6 Cylinder

2006-2005 167/2.7L (DOHC), 215/3.5L (SOHC)
 Seal 714655

CRANKSHAFT FRONT SEAL

6 Cylinder

2008-2005 167/2.7L (DOHC)
 Seal 710469
 2008-2005 215/3.5L (SOHC)
 Seal 1987S
 Repair Sleeve KWK99138

CRANKSHAFT REAR SEAL

6 Cylinder

2008-2005 2.7L, 3.5L
 Seal Viton 710056
 Seal PTFE H/D 5279

²⁵New Item, Check For Availability

⁶⁴Seal & Bushing Kit

Mfg./Year Model & Location Part No. Mfg./Year Model & Location Part No.

CHRYSLER - Import - TC Maserati**FRONT WHEEL****FWD**

1991-1990 TC Maserati	
Seal	5604[2] ⁵⁶
Ball Bearing (Opt)	513006[2]
Hub Unit Bearing (4 Lug Whl.)	518501[2] ⁶²
Hub Unit Bearing (5 Lug Whl.)	518502[2] ⁶³

REAR WHEEL**FWD**

1991-1990 TC Maserati	
Seal (Inner)	4099[2]
Set (Inner)	SET45[2]
Set (Outer)	SET16[2]

3-SPEED AUTOMATIC TRANSAXLE**Manual Shaft**

1991-1990	
Seal	8609

CRANKSHAFT FRONT SEAL**4 Cylinder**

1990 135/2.2L	
Seal	3638
Repair Sleeve	KWK99112

6 Cylinder

1991-1990 181/3.0L	
Seal	223750

CHRYSLER - CUV - Pacifica**FRONT WHEEL****FWD**

2008-2007	
Hub Unit Bearing	HA590217[2] ²⁵
2006-2004	
Hub Unit Bearing	HA590208[2]

AWD

2008-2007	
Hub Unit Bearing	HA590217[2] ²⁵
2006-2004	
Hub Unit Bearing	HA590208[2]

REAR WHEEL**FWD**

2008-2007	
Hub Unit Bearing	HA590274[2] ²⁵
2006-2004	
Hub Unit Bearing	HA590209[2]

AWD

2008-2007	
Hub Unit Bearing	HA590274[2] ²⁵
2006-2004	
Hub Unit Bearing	HA590209[2]

TRANSFER CASE**Input Shaft**

2005-2004	
Seal	710501

TRANSFER CASE**Front Output Shaft**

2005-2004	
Seal	3459S
Repair Sleeve	KWK99157
Ball Bearing	106WB

4-SPEED AUTOMATIC TRANSMISSION**Torque Converter**

2008-2004	
Seal	331228H
Repair Sleeve	KWK99149

4-SPEED AUTOMATIC TRANSAXLE**Differential**

2008-2004 (41TE)	
Cone/Cup (LH)	NP889967-NP714580[2]
Cone/Cup (RH)	NP952605-JL69310P[2]

Transfer Shaft

2008-2004 (41TE)	
Cone/Cup (LH)	NP853895-NP352518[2]
Cone/Cup (RH)	NP716862-LM501310[2]

²⁵New Item, Check For Availability
Bolts, Studded Spindle, Seal, & Bearing⁵⁶Opt. Kit = Seal 3948 & Sleeve⁶²Kit = Plate, Gasket, 3⁶³Kit = Plate, Gasket, 3 Bolts, Studded Spindle, Seal, & Bearing

Mfg./Year Model & Location Part No. Mfg./Year Model & Location Part No.

CHRYSLER - CUV - Pacifica (cont.)

4-SPEED AUTOMATIC TRANSAXLE

Output Shaft

2008-2004 (41TE)
 Cone/Cup (LH)NP117885-LM300811[2]
 Cone/Cup (RH)NP952605-JL69310P[2]
 Seal3459S[2]
 Repair SleeveKWK99157[2]

Manual Shaft

2008-2004 (41AE, 41TE)
 Seal8609

CAMSHAFT SEAL

6 Cylinder

2006-2004 215/3.5L
 Seal714655

CRANKSHAFT FRONT SEAL

6 Cylinder

2008-2004 215/3.5L, 230/3.8
 Seal3638
 Repair SleeveKWK99112

CRANKSHAFT REAR SEAL

6 Cylinder

2007-2004 215/3.5L, 230/3.8
 Seal Viton710056
 Seal PTFE H/D5279

CHRYSLER - Minivan, Truck - Aspen

FRONT WHEEL

RWD

2009-2007
 Hub Unit BearingHA590244[2]²⁵

4WD

2009-2007
 Hub Unit BearingHA590244[2]²⁵

REAR WHEEL

RWD

2009-2007
 Cylindrical Bearing6410[2]
 SealSL260004[2]²⁵

4WD

2009-2007
 Cylindrical Bearing6410[2]
 SealSL260004[2]²⁵

4WD FRONT AXLE

Axle Shaft

2008-2007 (8" R.G.)
 Seal710489²⁵

REAR AXLE

Differential Rebuild Kit

2007 (8.25" R.G.)
 KitDRK303B²⁵

REAR AXLE (cont.)

Differential Rebuild Kit (cont.)

2007 (9.25" R.G.)
 KitDRK304A²⁵

Pinion

2008-2007 (8.25" R.G.)
 Seal710480
 Cone/Cup (Inner)M802048-M802011
 Cone/Cup (Outer)M86649-M86610

TRANSFER CASE

Front Output Shaft

2008-2007 (New Process 244HD)
 Seal3946
 Repair SleeveKWK99187

²⁵New Item, Check For Availability

Mfg./Year Model & Location Part No. Mfg./Year Model & Location Part No.

CHRYSLER - Minivan, Truck - PT Cruiser**FRONT WHEEL****FWD**

2008-2002

Set (Tapered Rlr. Brg.)SET49[2]
Ball Bearing (Opt) 510058[2]

2001

Ball Bearing510057[2]

REAR WHEEL**FWD**

2008-2003

Hub Unit Bearing 512167[2]

2002-2001 (RW Disc)

Hub Unit Bearing 512168[2]

2002-2001 (RW Drum)

Hub Unit Bearing 512167[2]

CLUTCH**Release Bearing**

2004-2001

Bearing Assy614121

4-SPEED AUTOMATIC TRANSAXLE**Differential**

2004-2001 (A604)

Cone/Cup (LH) NP889967-NP714580

Cone/Cup (RH)NP952605-JL69310P

Transfer Shaft

2004-2001 (A604)

Cone/Cup (LH) NP853895-NP352518[2]

Cone/Cup (RH) NP716862-LM501310[2]

Output Shaft

2008-2001 (40TE, 41TE)

Seal 3459S[2]

Cone/Cup (LH)NP117885-LM300811[2]

Cone/Cup (RH)NP952605-JL69310P[2]

Repair SleeveKWK99157[2]

Manual Shaft

2007-2001 (40TE, 41TE)

Seal8609

5-SPEED MANUAL TRANSAXLE**Differential**

2004-2001 (A578)

Seal 3459S[2]

Set SET11[2]

Repair SleeveKWK99157

5-SPEED MANUAL TRANSAXLE**Input Shaft**

2004-2001 (A578)

Seal3732S

Set (Frnt) SET4

Set (Rr) SET5

Repair SleeveKWK99106

Selector Shaft Seal/Man. Shaft

2007-2001 (A578)

Seal3816

CAMSHAFT SEAL**4 Cylinder**

2008-2001 148/2.4L

Seal Viton 320249

Repair SleeveKWK99139

CRANKSHAFT FRONT SEAL**4 Cylinder**

2008-2001 148/2.4L

Seal Viton 320348

Repair SleeveKWK99128

CRANKSHAFT REAR SEAL**4 Cylinder**

2008-2001 148/2.4L

Seal Viton710056

Seal PTFE H/D 5279

Mfg./Year	Model & Location	Part No.	Mfg./Year	Model & Location	Part No.
CHRYSLER - Minivan, Truck - Town & Country Van, Grand Voyager, Voyager from 2000 (See also Plymouth)					

FRONT WHEEL

FWD

2008	Hub Unit Bearing	HA590243[2] ²⁵
2007-2001	Hub Unit Bearing	513123[2]
2000-1996 (14" Whl.)	Hub Unit Bearing	513122[2]
2000-1996 (15", 16", 17" Whl.)	Hub Unit Bearing	513123[2]
1995-1991 (14" Whl.)	Hub Unit Bearing	513075[2]
1995-1990 (15" Whl.)	Hub Unit Bearing	513074[2] ⁴⁴
1990 (14" Whl.)	Seal	5604[2] ⁵⁶
	Ball Bearing	513006[2]
	Hub Unit Bearing (4 Stud)	518501[2] ⁶²
	Hub Unit Bearing (5 Lug Whl.)	518502[2] ⁶³

REAR WHEEL

FWD

2009-2008	Hub Unit Bearing	HA590317[2] ²⁵
2007-2001 (ABS)	Hub Unit Bearing	512169[2]
2007-2001 (Non-ABS)	Hub Unit Bearing	512170[2]
2000-1996 (14" Whl.)	Hub Unit Bearing	512155[2]
2000-1996 (15", 16", 17" Whl.)	Hub Unit Bearing	512156[2]
1995-1990	Seal (Inner)	4249[2]
	Set (Inner)	SET17[2]
	Cone/Cup (Outer) (O.E.)	LM12749F-LM12711[2]
	Set (Outer) (Opt. Non-Polymer Set)	SET16[2]

AWD

2004-1997 (15", 16", 17" Whl.)	Hub Unit Bearing	512157[2]
1995-1992	Hub Unit Bearing	512125[2]

AWD REAR AXLE

Differential

2000-1994	Cone/Cup	JL69349H-JL69310[2]
------------------	----------------	---------------------

Pinion

2000-1994	Set (Inner)	SET45
	Set (Outer)	SET17

TRANSFER CASE

Input Shaft

2004-1992	Seal	710501
------------------	------------	--------

Front Output Shaft

2004-1992	Seal	3459S
	Ball Bearing	106WB[2]
	Repair Sleeve	KWK99157

3-SPEED AUTOMATIC TRANSAXLE

Differential

2002-1997 (A404 31TH)(Prod. from mid 1997 on)	Cone/Cup (LH)	NP889967-NP714580
	Cone/Cup (RH)	NP952605-JL69310P
1997-1996 (A404 31TH)(Prod. thru mid 1997)	Cone/Cup (LH)	JL69348-JL69310
	Cone/Cup (RH)	NP889967-NP714580
1995-1992 (A404 31TH)	Cone/Cup	JL69349CP-JL69310P[2]
1991-1990 (A404)	Cone/Cup	JL69349H-JL69310[2]
1991-1990 (A413)	Seal	3459S[2]
	Set	SET11[2]
	Repair Sleeve	KWK99157

Torque Converter

1998-1990	Seal	331228H
	Repair Sleeve	KWK99149

Transfer Shaft

2002-1997 (A404 31TH)(Prod. from mid 1997 on)	Cone/Cup (LH)	NP952605-JL69310P[2]
	Cone/Cup (RH)	NP952605-JL69310P[2]
1997-1992 (A404 31TH)(Prod. thru mid 1997)	Cone/Cup (LH)	JL69349CP-JL69310P[2]
	Cone/Cup (RH)	JL69349CP-JL69310P[2]
1991-1990 (A404, 31TH)	Cone/Cup (LH)	JL69349H-JL69310[2]
	Cone/Cup (RH)	JL69349H-JL69310[2]
1991-1990 (A413)	Set	SET11[2]

²⁵New Item, Check For Availability ⁴⁴Brg Flg Mtg Holes Threaded. ⁵⁶Opt. Kit = Seal 3948 & Sleeve ⁶²Kit = Plate, Gasket, 3 Bolts, Studded Spindle, Seal, & Bearing ⁶³Kit = Plate, Gasket, 3 Bolts, Studded Spindle, Seal, & Bearing

Mfg./Year Model & Location Part No. Mfg./Year Model & Location Part No.

CHRYSLER - Minivan, Truck - Town & Country Van, Grand Voyager, Voyager from 2000 (See also Plymouth) (cont.)**3-SPEED AUTOMATIC TRANSAXLE****Output Shaft**

2002-1990 (A404, 31TH)
 Cone/Cup (LH) L68149P-L68111P[2]
 Cone/Cup (RH) L68149P-L68111P[2]

Manual Shaft

2002-1990
 Seal 8609

4-SPEED AUTOMATIC TRANSAXLE**Differential**

2004-1997 (A604 41TE)(AWD)(Prod. from mid 1997 on)
 Cone/Cup (LH) NP889967-NP714580
 Cone (RH) LM503349
 2004-1997 (A604 41TE)(Prod. from mid 1997 on)
 Cone/Cup (LH) NP889967-NP714580
 Cone/Cup (RH) NP952605-JL69310P
 1999-1993 (A606, 42LE)
 Set SET36[2]
 1997 (A604 41TE)(AWD)(Prod. thru mid 1997)
 Cone/Cup (LH) NP889967-NP714580
 Cone/Cup (RH) JL69348-JL69310
 1997-1995 (A604 41TE)(Prod. thru mid 1997)
 Cone/Cup (LH) NP889967-NP714580
 Cone/Cup (RH) JL69348-JL69310
 1995-1992 (A604 41TE)
 Cone/Cup JL69348-JL69310
 1995-1991 (A604 41TE)(AWD)
 Cone/Cup (LH) JL69348-JL69310
 Cone (RH) LM503349
 1991-1990 (A604, A670)
 Set SET11[2]

Torque Converter / Frt Pump

2002-1990
 Seal 331228H
 Repair Sleeve KWK99149

Transfer Shaft

2004-2002 (A604 41TE)(AWD)
 Cone/Cup (LH) NP853895-NP352518[2]
 Cone/Cup (RH) NP716862-LM501310[2]
 2001-1996 (A604 41TE)(AWD)
 Cone/Cup (LH) NP853895-NP352518[2]
 Set (RH) SET45[2]
 1995-1992 (A604 41TE)(AWD)
 Cone/Cup (LH) 13687-13623X[2]
 Set (RH) SET45[2]
 1991-1990 (A604, A670)
 Set SET11[2]

4-SPEED AUTOMATIC TRANSAXLE**Output Shaft**

2004-2001 (A604 41TE)
 Cone/Cup (RH) NP952605-JL69310P[2]
 Cone/Cup (LH) NP117885-LM300911[2]
 Seal 3459S[2]
 2000-1997 (A604 41TE)(incl. AWD)(Prod. from mid 1997 on)
 Cone/Cup (RH) NP952605-JL69310P[2]
 Cone/Cup (LH) LM300848-LM300911[2]
 Seal 3459S[2]
 1997-1992 (A604 41TE)(incl. AWD)(Prod. thru mid 1997)
 Cone/Cup (RH) JL69348-JL69310[2]
 Cone/Cup (LH) LM300848-LM300911[2]
 Seal 3459S[2]
 1991-1990 (A604, A670)
 Seal 3459S[2]
 Set SET17[2]

Manual Shaft

2007-1990
 Seal 8609

POWER STEERING**Pump Shaft**

1995-1990
 Seal 7013S

Worm Shaft

1992-1990
 Seal 7188S

CAMSHAFT SEAL**4 Cylinder**

2003-2000 148/2.4L (DOHC)
 Seal Viton 320249[2]
 Repair Sleeve KWK99139[2]

6 Cylinder

2000 2972cc/3.0L
 Seal 3771[2]
 Repair Sleeve KWK99139

INTERMEDIATE SHAFT**6 Cylinder**

2002-1990 201/3.3L, 230/3.8L
 Seal 3655S
 Repair Sleeve KWK99139

CRANKSHAFT FRONT SEAL**4 Cylinder**

2003-2000 148/2.4L (DOHC)
 Seal Viton 320348
 Repair Sleeve KWK99112

Mfg./Year Model & Location Part No. Mfg./Year Model & Location Part No.

CHRYSLER - Minivan, Truck - Town & Country Van, Grand Voyager, Voyager from 2000 (See also Plymouth) (cont.)

CRANKSHAFT FRONT SEAL

6 Cylinder

2008-2003	201/3.3L, 230/3.8L	
Seal	3638
Repair Sleeve	KWK99112
2002-1990	201/3.3L, 230/3.8L	
Seal	3638
Repair Sleeve	KWK99112
2000	2972cc/3.0L	
Seal	223750

CRANKSHAFT REAR SEAL

6 Cylinder

2008-1990	181/3.0L, 201/3.3L, 231/3.8L	
Seal Viton	710056
Seal PTFE H/D	5279

CRANKSHAFT REAR SEAL

4 Cylinder

2003-2000	148/2.4L (DOHC)	
Seal Viton	710056

DAEWOO - Lanos, Leganza, Nubira

FRONT WHEEL

FWD

2002-1999	Lanos, Nubria	
Ball Bearing	513113[2]
2002-1999	Leganza	
Ball Bearing	510065[2]

REAR WHEEL

FWD

2002-1999	Lanos (Non-ABS)	
Seal (Inner)	471498[2]
Set (Inner)	SET8[2]
Set (Outer)	SET1[2]
2002-1999	Leganza	
Hub Unit Bearing	512159[2]
2002-1999	Nubria	
Seal (Inner)	471498[2]
Set (Inner)	SET8[2]
Set (Outer)	SET1[2]

4-SPEED AUTOMATIC TRANSAXLE

Torque Converter / Frt Pump

2002-1998		
Seal	223830
Repair Sleeve	KWK99147
2002-1998	(4T40E)	
Seal	4072N

Output Shaft

2002-1998	(42LE)	
Seal	3543[2]
Repair Sleeve	KWK99139[2]

4-SPEED AUTOMATIC TRANSAXLE

Manual Shaft

2002-1998	(4T40E)	
Seal	8792S
2002-1998	(Aisin 50-42LE)	
Seal	221207
Repair Sleeve	KWK99049

CRANKSHAFT FRONT SEAL

2002-1998	(DOHC)	
Seal Viton	710237
Repair Sleeve	KWK99354

Mfg./Year	Model & Location	Part No.	Mfg./Year	Model & Location	Part No.
-----------	------------------	----------	-----------	------------------	----------

DAIHATSU - Charade**FRONT WHEEL****FWD**

1992-1990 Charade (From 1/1/89)
 Ball Bearing 510012[2]

REAR WHEEL**FWD**

1992-1990
 Ball Bearing (Inner) 205F[2]
 Ball Bearing (Outer) 303BB[2]

CLUTCH**Release Bearing**

1992-1990
 Bearing Assy 614110

3-SPEED AUTOMATIC TRANSAXLE**Differential**

1992-1990 (Aisin A210)
 Ball Bearing 207S[2]

Torque Converter

1992-1990 (Aisin A210)
 Seal 223830
 Repair Sleeve KWK99147

Output Shaft

1992-1990 (Aisin A210)
 Seal 223540[2]
 Repair Sleeve KWK99139[2]

Manual Shaft

1992-1990 (Aisin A210)
 Seal 710116

MANUAL STEERING**Pitman Shaft**

1992-1990
 Ball Bearing 202AG[2]

CAMSHAFT SEAL**3 Cylinder**

1992-1990 993cc/1.0L
 Seal 712008
 Repair Sleeve KWK99111

4 Cylinder

1992-1990 1295cc/1.3L
 Seal 223800

CRANKSHAFT FRONT SEAL**3 Cylinder**

1992-1990 993cc/1.0L
 Seal 223420

CRANKSHAFT FRONT SEAL**4 Cylinder**

1992-1990 1295cc/1.3L
 Seal 223420

CRANKSHAFT REAR SEAL**3 Cylinder**

1992-1990 993cc/1.0L
 Seal 710271

4 Cylinder

1992-1990 1295cc/1.3L
 Seal 228009
 Repair Sleeve KWK99313

Mfg./Year Model & Location Part No. Mfg./Year Model & Location Part No.

DAIHATSU - SUV - Rocky

FRONT WHEEL

4WD

1992-1990
 Seal (Inner) 224200S[2]
 Bearing Assy (Inner) 32007X[2]
 Seal (Outer) 225535[2]

REAR WHEEL

4WD

1992-1990
 Seal (Inner) 225208[2]
 Ball Bearing (Inner) 511022[2]
 Seal (Outer) 225008[2]

4WD FRONT AXLE

Differential

1992-1990
 Cone/Cup 16150-16282[2]

Pinion

1992-1990
 Bearing Assy (Inner) 30306M
 Seal (Outer) 710269
 Bearing Assy (Outer) 30305C

REAR AXLE

Differential

1992-1990
 Bearing Assy 30208M[2]

Pinion

1992-1990
 Bearing Assy (Inner) 30307M
 Seal (Outer) 710270
 Bearing Assy (Outer) 30306M
 Repair Sleeve KWK99177

3-SPEED AUTOMATIC TRANSMISSION

Rear Seal/Ext. Housing

1992-1990 (Aisin A210)
 Repair Sleeve KWK99139[2]
 Seal 223540[2]

Selector Shaft Seal/Man. Shaft

1992-1990 (Aisin A210)
 Seal 710116

CLUTCH

Pilot Bearing

1992-1990 Rocky
 Ball Bearing 101SS

Release Bearing

1992-1990
 Bearing Assy 614145

CRANKSHAFT FRONT SEAL

4 Cylinder

1992-1990 1589cc/1.6L
 Seal 223420

CRANKSHAFT REAR SEAL

4 Cylinder

1992-1990 1589cc/1.6L
 Seal 228009
 Repair Sleeve KWK99313

DODGE - FRONT DRIVE - Daytona, Dynasty, Shadow, Spirit

FRONT WHEEL

FWD

1995-1991
 Hub Unit Bearing 513075[2]

FRONT WHEEL (cont.)

FWD (cont.)

1990
 Seal 5604[2]⁵⁶
 Ball Bearing (Opt) 513006[2]
 Hub Unit Bearing (4
 Stud) 518501[2]⁶²
 Lug Whl.) 518502[2]⁶³

⁵⁶Opt. Kit = Seal 3948 & Sleeve ⁶²Kit = Plate, Gasket, 3 Bolts, Studded Spindle, Seal, & Bearing

⁶³Kit = Plate, Gasket, 3 Bolts, Studded Spindle, Seal, & Bearing

DODGE - FRONT DRIVE - Daytona, Dynasty, Shadow, Spirit (cont.)**FRONT WHEEL (cont.)****FWD (cont.)**

1990	Daytona	
Seal	5604[2] ⁵⁶
Ball Bearing (Opt)	513006[2]
Hub Unit Bearing (14" Whl.)	518502[2] ⁶³
Hub Unit Bearing (15", 16" Whl.)	513075[2]
1990	Dynasty	
Hub Unit Bearing	513075[2]

REAR WHEEL**FWD**

1995-1990		
Seal (Inner)	4099[2]
Set (Inner)	SET46[2]
Cone/Cup (Outer) (O.E.)	LM12749F-LM12711[2]
Set (Outer) (Opt. Non-Polymer Set)	SET16[2]

CLUTCH**Release Bearing**

1995-1991	6 Cyl. 3.0, 3.2	
Bearing Assy	614092
1994-1990	(4 Cyl.)	
Bearing Assy	614092

3-SPEED AUTOMATIC TRANSAXLE**Differential**

1995-1990	(A404, A413, A470, A670, 31TH)	
Seal	3459S[2]
Set	SET11[2]
Repair Sleeve (Opt)	KWK99157[2]

Torque Converter

1995-1990		
Seal	331228H[2]
Repair Sleeve	KWK99149

Output Shaft

2001-1992	(31TH)	
Seal	3459S[2]
Repair Sleeve	KWK99157
1991-1990	(A404, A413, A470, A670, 31TH)	
Seal	3459S[2]
Set	SET17[2]
Repair Sleeve	KWK99157[2]

3-SPEED AUTOMATIC TRANSAXLE**Manual Shaft**

1995-1990	(A404, A413, A470, A670, 31TH)	
Seal	8609

4-SPEED AUTOMATIC TRANSAXLE**Torque Converter / Frt Pump**

1995-1990	(A604, 41TE, 42LE)	
Seal	331228H
Repair Sleeve	KWK99149

Output Shaft

1996-1990	(A604 41TE)	
Seal	3459S[2]
Set	SET17[2]
Repair Sleeve	KWK99157[2]

Manual Shaft

1995-1990	(A604, 41TE)	
Seal	8609

5-SPEED MANUAL TRANSAXLE**Differential**

1995-1990	(A465, A520, A523, A525, A543, A555, A568)	
Seal	3459S[2]
Set	SET11[2]
Repair Sleeve	KWK99157[2]

Input Shaft

1995-1990	(A465, A520, A523, A525, A543, A555, A568)	
Seal (Frt)	3732S
Set (Frt)	SET4
Set (Rr)	SET5
Repair Sleeve	KWK99106

Selector Shaft Seal/Man. Shaft

1995-1990	(A465, A520, A523, A525, A543, A555, A568)	
Seal	3816

CAMSHAFT SEAL**4 Cylinder**

2004-2001	2350cc/2.4L (SOHC)	
Seal	3771[2]
Repair Sleeve	KWK99139[2]
1995-1990	135/2.2L, 153/2.5L	
Seal	3655S
Repair Sleeve	KWK99139
1993-1991	135/2.2L	
Seal	223801
Repair Sleeve	KWK99147

⁵⁶Opt. Kit = Seal 3948 & Sleeve⁶³Kit = Plate, Gasket, 3 Bolts, Studded Spindle, Seal, & Bearing

Mfg./Year Model & Location Part No. Mfg./Year Model & Location Part No.

DODGE - FRONT DRIVE - Daytona, Dynasty, Shadow, Spirit (cont.)

CAMSHAFT SEAL

6 Cylinder

1995-1990 2972cc/3.0L
 Seal3771
 Repair SleeveKWK99139

CRANKSHAFT FRONT SEAL

4 Cylinder

1995-1990 153/2.5L
 Seal3638
 Repair SleeveKWK99112

6 Cylinder

1994-1990 181/3.0L
 Seal223750
 1993-1990 201/3.3L
 Seal3638
 Repair SleeveKWK99112

CRANKSHAFT REAR SEAL

4 Cylinder

1995-1990 135/2.2L, 153/2.5L
 Seal Viton710056
 Seal PTFE H/D5279

6 Cylinder

1995-1990 181/3.0L, 201/3.3L
 Seal Viton710056
 Seal PTFE H/D5279

DODGE - FRONT DRIVE - Avenger

FRONT WHEEL

FWD

2008 (ABS)
 Hub Unit BearingHA590219[2]²⁵
 2008 (Non-ABS)
 Hub Unit BearingHA590214[2]²⁵
 2000-1995
 Hub Unit Bearing513157[2]

AWD

2008 (ABS)
 Hub Unit BearingHA590219[2]²⁵

REAR WHEEL

FWD

2008 (RW Drum)
 Hub Unit BearingHA590221[2]²⁵
 2008 R/T
 Hub Unit BearingHA590216[2]²⁵
 2000-1995 (ABS, Non-ABS)
 Hub Unit BearingHA590306[2]
 Bearing Module (Opt)512136[2]

AWD

2008 R/T
 Hub Unit BearingHA590216[2]²⁵

CLUTCH

Release Bearing

2000-1995
 Bearing Assy614121

4-SPEED AUTOMATIC TRANSAXLE

Differential

2008-1997 (A604 41TE)(Prod. from mid 1997 on)
 Cone/Cup (LH)NP889967-NP714580
 Cone/Cup (RH)NP952605-JL69310P
 1997-1996 (A604 41TE)(Prod. thru mid 1997)
 Cone/Cup (LH)NP889967-NP714580
 Cone/Cup (RH)JL69348-JL69310
 1995 (A604 41TE)
 Cone/CupJL69348-JL69310[2]

Torque Converter / Frt Pump

2008-1995
 Seal331228H
 Repair SleeveKWK99149

²⁵New Item, Check For Availability

DODGE - FRONT DRIVE - Avenger (cont.)**4-SPEED AUTOMATIC TRANSAXLE****Transfer Shaft**

2008-1996	(A604, 41TE)	
Cone/Cup (Inner)	NP853895-NP352518[2]	
Set (Outer)	SET45[2]	
1995	(A604, 41TE)	
Cone/Cup (Inner)	13687-13623X[2]	
Set (Outer)	SET45[2]	

Output Shaft

2008	(40TES, 41TES)	
Seal	3459S[2]	
Repair Sleeve	KWK99157[2]	
2000-1997	(A604 41TE)(Prod. from mid 1997 on)	
Cone/Cup (Outer)	LM300848-LM300911[2]	
Cone/Cup (Inner)	NP952605-JL69310P[2]	
2000-1995	(A604 41TE)	
Seal	3459S[2]	
Repair Sleeve	KWK99157[2]	
1997-1995	(A604 41TE)(Prod. thru mid 1997)	
Cone/Cup (Outer)	LM300848-LM300811[2]	
Cone/Cup (Inner)	JL69348-JL69310[2]	

Manual Shaft

2008-1995	(41TE, 40TES, 41TES)	
Seal	8609	

5-SPEED MANUAL TRANSAXLE**Differential**

1999-1995	(A578)	
Seal	3459S[2]	
Set	SET11[2]	
Repair Sleeve	KWK99157[2]	

Output Shaft

1999-1995	(A578)	
Seal	3459S[2]	
Repair Sleeve	KWK99157[2]	

Selector Shaft Seal/Man. Shaft

1999-1995	(A578)	
Seal	3816	

CAMSHAFT SEAL**4 Cylinder**

1999-1995	122/2.0L	
Seal Viton	320249	
Repair Sleeve	KWK99139	

6 Cylinder

2000-1995	2497cc/2.5L	
Seal	3771[2]	
Repair Sleeve	KWK99139[2]	

CRANKSHAFT FRONT SEAL**4 Cylinder**

1999-1995	122/2.0L	
Seal Viton	320348	
Repair Sleeve	KWK99128	

6 Cylinder

2008	167/2.7L (DOHC)	
Seal	710469	
2008	215/3.5L (SOHC)	
Repair Sleeve	KWK99139	
2000-1995	2497cc/2.5L	
Seal	223750	
Repair Sleeve	KWK99147	

CRANKSHAFT REAR SEAL**4 Cylinder**

1999-1995	122/2.0L	
Seal Viton	710056	
Seal PTFE H/D	5279	

6 Cylinder

2008	167/2.7L (DOHC), 215/3.5L (SOHC)	
Seal Viton	710056	
Seal PTFE H/D	5279	
2000-1995	2497cc/2.5L	
Seal Viton	710056	
Seal PTFE H/D	5279	

Mfg./Year Model & Location Part No. Mfg./Year Model & Location Part No.

DODGE - FRONT DRIVE - Caliber

FRONT WHEEL

FWD

2008-2007
 Bearing Assy 510090[2]²⁵

AWD

2008-2007
 Bearing Assy 510090[2]²⁵

REAR WHEEL

FWD

2008-2007 (ABS)
 Hub Unit Bearing HA590216[2]²⁵
 2008-2007 (Non-ABS)
 Hub Unit Bearing HA590221[2]²⁵

REAR WHEEL

AWD

2008-2007
 Hub Unit Bearing HA590230[2]²⁵

DODGE - FRONT DRIVE - Omni

FRONT WHEEL

FWD

1990 Omni(Exc. Shelby)
 Seal 5604[2]⁵⁶
 Ball Bearing B39[2]
 Hub Unit Bearing 518500[2]⁶²

REAR WHEEL

FWD

1990
 Seal (Inner) 4099[2]
 Set (Inner) SET46[2]
 Cone/Cup (Outer)
 (O.E.) LM12749F-LM12711[2]
 Set (Outer) (Opt.
 Non-Polymer Set) SET16[2]

CLUTCH

Release Bearing

1990 (4 Cyl.)
 Bearing Assy 614092

3-SPEED AUTOMATIC TRANSAXLE

Differential

1990 (A404, A413, A470, A670,
 31TH)
 Seal 3459S[2]
 Set SET11[2]
 Repair Sleeve (Opt) KWK99157[2]

Torque Converter

1990
 Seal 331228H[2]
 Repair Sleeve KWK99149

3-SPEED AUTOMATIC TRANSAXLE

Output Shaft

1990 (A404, A413, A470, A670,
 31TH)
 Seal 3459S[2]
 Repair Sleeve KWK99157[2]
 Set SET17[2]

Manual Shaft

1990 (A404, A413, A470, A670,
 31TH)
 Seal 8609

4-SPEED AUTOMATIC TRANSAXLE

Torque Converter / Frt Pump

1990 (A604, 41TE, 42LE)
 Seal 331228H
 Repair Sleeve KWK99149

Output Shaft

1990 (A604 41TE)
 Set SET17[2]

Manual Shaft

1990 (A604, 41TE)
 Seal 8609

5-SPEED MANUAL TRANSAXLE

Differential

1990 (A465, A520, A523, A525,
 A543, A555, A568)
 Seal 3459S[2]
 Set SET11[2]
 Repair Sleeve KWK99157[2]

²⁵New Item, Check For Availability ⁵⁶Opt. Kit = Seal 3948 & Sleeve ⁶²Kit = Plate, Gasket, 3 Bolts, Studded Spindle, Seal, & Bearing

Mfg./Year	Model & Location	Part No.	Mfg./Year	Model & Location	Part No.
-----------	------------------	----------	-----------	------------------	----------

DODGE - FRONT DRIVE - Omni (cont.)**5-SPEED MANUAL TRANSAXLE****Input Shaft**

1990	(A465, A520, A523, A525, A543, A555, A568)	
Seal (Frnt)	3732S
Set (Frnt)	SET4[2]
Repair Sleeve	KWK99106
Set (Rr)	SET5[2]

Selector Shaft Seal/Man. Shaft

1990	(A465, A520, A523, A525, A543, A555, A568)	
Seal	3816

CRANKSHAFT FRONT SEAL**4 Cylinder**

1990	135/2.2L	
Seal Viton	710056
Seal PTFE H/D	5279

CRANKSHAFT REAR SEAL**4 Cylinder**

1990	135/2.2L	
Seal	3655S
Repair Sleeve	KWK99139

DODGE - FRONT DRIVE - Intrepid**FRONT WHEEL****FWD**

2004-1993		
Hub Unit Bearing		
(Speed Sensor on CV)	513089[2]

REAR WHEEL**FWD**

2004-1998	(ABS)	
Hub Unit Bearing	512029[2]
1997-1993	(ABS, Non-ABS)	
Hub Unit Bearing		
(Substitute ABS Unit)	512029[2]

4-SPEED AUTOMATIC TRANSAXLE**Differential**

2004-1993	(A606, 42LE)	
Set	SET36[2]

Torque Converter / Frt Pump

2002-1993	(A606, 42LE)	
Seal	331228H
Repair Sleeve	KWK99149

Transfer Shaft

2004-2000	(A606, 42LE)	
Cone/Cup (Inner) M802048CP-M802011AP[2]	
Cone/Cup (Outer) 26131H-NP941813[2]	
1999-1993	(A606, 42LE)	
Cone/Cup (Inner) M802048CP-M802011AP[2]	
Cone/Cup (Outer) 26131H-26334[2]	

4-SPEED AUTOMATIC TRANSAXLE**Output Shaft**

2004-1993	(42LE)	
Seal (LH)	4738N
Seal (RH)	4748N
2004-1993	(A606, 42LE)	
Cone/Cup (Outer) NP952605-JL69310P[2]	
Cone/Cup (Inner) NP114036-LM300811[2]	

CAMSHAFT SEAL**6 Cylinder**

2004-2000	215/3.5L	
Seal	714655[2]
Repair Sleeve	KWK99112[2]
2001-1998	3200cc/3.2L	
Seal	714655[2]
Repair Sleeve	KWK99112[2]
1997-1993	215/3.5L	
Seal	714655[2]
Repair Sleeve	KWK99112[2]

CRANKSHAFT FRONT SEAL**6 Cylinder**

2004-1998	167/2.7L (DOHC)	
Seal	710469
2004-1994	215/3.5L	
Repair Sleeve	KWK99139
2001-1998	197/3.2L	
Repair Sleeve	KWK99139
1997-1993	201/3.3L	
Seal	3638
Repair Sleeve	KWK99112

Mfg./Year Model & Location Part No. Mfg./Year Model & Location Part No.

DODGE - FRONT DRIVE - Intrepid (cont.)

CRANKSHAFT REAR SEAL

6 Cylinder

2004-2000	215/3.5L	
Seal Viton		710056
Seal PTFE H/D		5279
2004-1998	167/2.7L (DOHC)	
Seal Viton		710056
2001-1998	3200cc/3.2L	
Seal Viton		710056
1997-1993	201/3.3L, 215/3.5L	
Seal Viton		710056
Seal PTFE H/D		5279

DODGE - FRONT DRIVE - Monaco

FRONT WHEEL

FWD

1992-1990		
Ball Bearing		513144K[2]

REAR WHEEL

FWD

1991-1990	(Non-ABS)	
Hub Unit Bearing		513070[2]

4-SPEED AUTOMATIC TRANSAXLE

Torque Converter / Frt Pump

1992-1990		
Seal		320583
Repair Sleeve		KWK99157

Output Shaft

1992-1990	(ZF4HP 18)	
Seal (LH)		224462
Seal (RH)		710422 ¹⁶
1992-1990	(w/o ZF4HP 18)	
Seal		223543[2]
Repair Sleeve		KWK99139[2]

CRANKSHAFT FRONT SEAL

6 Cylinder

1992-1990	182/3.0L	
Seal Viton		710196
Repair Sleeve		KWK99157

CRANKSHAFT REAR SEAL

6 Cylinder

1992-1990	182/3.0L	
Seal		228010
Repair Sleeve		KWK99315

DODGE - FRONT DRIVE - Neon, SX 2.0

FRONT WHEEL

FWD

2005-2002		
Set		SET49[2]
2001-2000		
Ball Bearing		510057[2]
1999-1995		
Ball Bearing		510032[2]
Hub Unit Bearing (4		
Lug Whl.)		HA590181K[2] ⁶⁸
Hub Unit Bearing (5		
Lug Whl.)		HA590182K[2] ⁶⁸

REAR WHEEL

FWD

2005-2000	(ABS, Non-ABS)	
Hub Unit Bearing		512167[2]
1999-1998		
Hub Unit Bearing		512013[2]
1997-1995		
Hub Unit Bearing (4		
Lug Whl.)		512021[2]
Hub Unit Bearing (5		
Lug Whl.)		512023[2]

¹⁶Obsolete ⁶⁸Kit = Flg, Brg, & Snap Ring

DODGE - FRONT DRIVE - Neon, SX 2.0 (cont.)**4-SPEED AUTOMATIC TRANSMISSION****Torque Converter**

2006-2002	41TE	
Seal	331228H
Repair Sleeve	KWK99149

CLUTCH**Release Bearing**

2002-1995		
Bearing Assy	614121

5-SPEED MANUAL TRANSMISSION**Selector Shaft Seal/Man. Shaft**

2005-1995		
Seal	3816

3-SPEED AUTOMATIC TRANSAXLE**Differential**

2001-1997	(A404 31TH)(Prod. from mid 1997 on)	
Seal (LH)	3459S
Cone/Cup (LH)	NP889967-NP714580
Repair Sleeve	KWK99157
Seal (RH)	3459S
Cone/Cup (RH)	NP952605-JL69310P
Repair Sleeve	KWK99157
1997-1996	(A404 31TH)(Prod. thru mid 1997)	
Seal (LH)	3459S
Cone/Cup (LH)	NP889967-NP714580
Seal (RH)	3459S
Cone/Cup (RH)	JL69348-JL69310
1995	(A404 31TH)	
Seal	3459S[2]
Cone/Cup	JL69349CP-JL69310P[2]

Torque Converter

2002-1995		
Seal	331228H
Repair Sleeve	KWK99149

Transfer Shaft

2001-1997	(A404 31TH)(Prod. from mid 1997 on)	
Cone/Cup (LH)	NP952605-JL69310P[2]
Cone/Cup (RH)	NP952605-JL69310P[2]
1997-1995	(A404 31TH)(Prod. thru mid 1997)	
Cone/Cup (LH)	JL69349CP-JL69310P[2]
Cone/Cup (RH)	JL69349CP-JL69310P[2]

3-SPEED AUTOMATIC TRANSAXLE**Output Shaft**

2001-1995	(A404 31TH)	
Seal	3459S[2]
Repair Sleeve	KWK99157[2]
Cone/Cup	L68149P-L68111P[2]

Manual Shaft

2001-1995	(31TH)	
Seal	8609

4-SPEED AUTOMATIC TRANSAXLE**Differential**

2003-2002	(A604, 41TE)	
Cone/Cup (LH)	NP889967-NP714580[2]
Cone/Cup (RH)	NP952605-JL69310P[2]

Transfer Shaft

2003-2002	(A604, 41TE)	
Cone/Cup (LH)	NP853895-NP352518[2]
Cone/Cup (RH)	NP716862-LM501310[2]

Output Shaft

2003-2002	(A604, 41TE)	
Cone/Cup (LH)	NP117885-LM300811[2]
Cone/Cup (RH)	NP952605-JL69310P[2]
Seal	3459S[2]
Repair Sleeve	KWK99157[2]

Manual Shaft

2005-2002	(41TE)	
Seal	8609

5-SPEED MANUAL TRANSAXLE**Differential**

2002-1995		
Seal	3459S[2]
Set	SET11[2]
Repair Sleeve	KWK99157[2]

Output Shaft

2005-2002	(41TE)	
Seal	3459S[2]
Repair Sleeve	KWK99157[2]

CAMSHAFT SEAL**4 Cylinder**

2005-1995	122/2.0L	
Seal Viton	320249
Repair Sleeve	KWK99139

CRANKSHAFT FRONT SEAL**4 Cylinder**

2005-1995	122/2.0L, 148/2.4L	
Seal Viton	320348
Repair Sleeve	KWK99128

Mfg./Year Model & Location Part No. Mfg./Year Model & Location Part No.

DODGE - FRONT DRIVE - Neon, SX 2.0 (cont.)

CRANKSHAFT REAR SEAL

4 Cylinder

2005-2003	122/2.0L (SOHC), 148/2.4L (DOHC)	
Seal Viton	710056	
Seal PTFE H/D	5279	
2002-1995	1996cc/2.0L	
Seal Viton	710056	
Seal PTFE H/D	5279	

DODGE - FRONT DRIVE - Stratus

FRONT WHEEL

FWD

2006-2001	Stratus (Sedan)	
Hub Unit Bearing	513138[2]	
2005-2001	Stratus (Coupe)	
Hub Unit Bearing	513157[2]	
2000-1995		
Hub Unit Bearing	513138[2]	

REAR WHEEL

FWD

2006-1998	(Sedan)(ABS)	
Hub Unit Bearing	512220[2]	
2006-1995	(Sedan)(Non-ABS)	
Hub Unit Bearing	512154[2]	
2005-2001	(Coupe)	
Hub Unit Bearing	HA590306[2]	
Bearing Module (Opt)	512136[2]	
1997-1995	(Sedan)(ABS)	
Hub Unit Bearing	512133[2]	

CLUTCH

Release Bearing

2002-1995	(4 Cyl.)	
Bearing Assy	614121	

5-SPEED MANUAL TRANSMISSION

Selector Shaft Seal/Man. Shaft

2000-1995		
Seal	3816	

3-SPEED AUTOMATIC TRANSAXLE

Differential

2001-1997	(A404 31TH)(Prod. from mid 1997 on)	
Seal (LH)	3459S	
Cone/Cup (LH)	NP889967-NP714580	
Repair Sleeve	KWK99157	
Seal (RH)	3459S	
Cone/Cup (RH)	NP952605-JL69310P	
Repair Sleeve	KWK99157	
1997-1996	(A404 31TH)(Prod. thru mid 1997)	
Seal (LH)	3459S	
Cone/Cup (LH)	NP889967-NP714580	
Seal (RH)	3459S	
Cone/Cup (RH)	JL69348-JL69310	
1995	(A404 31TH)	
Seal	3459S[2]	
Cone/Cup	JL69349CP-JL69310P[2]	

Torque Converter

2001-1995	(A404 31TH)	
Seal	331228H	
Repair Sleeve	KWK99149	

Transfer Shaft

2001-1997	(A404 31TH)(Prod. from mid 1997 on)	
Cone/Cup (LH)	NP952605-JL69310P[2]	
Cone/Cup (RH)	NP952605-JL69310P[2]	
1997-1995	(A404 31TH)(Prod. thru mid 1997)	
Cone/Cup (LH)	JL69349CP-JL69310P[2]	
Cone/Cup (RH)	JL69349CP-JL69310P[2]	

Output Shaft

2001-1995	(A404 31TH)	
Seal	3459S[2]	
Repair Sleeve	KWK99157[2]	
Cone/Cup	L68149P-L68111P[2]	

Mfg./Year	Model & Location	Part No.	Mfg./Year	Model & Location	Part No.
-----------	------------------	----------	-----------	------------------	----------

DODGE - FRONT DRIVE - Stratus (cont.)**3-SPEED AUTOMATIC TRANSAXLE****Manual Shaft**

2001-1995 (A404 31TH)
Seal8609

4-SPEED AUTOMATIC TRANSAXLE**Differential**

2003-1997 (A604 41TE)(Prod. from mid 1997 on)
Cone/Cup (LH) NP889967-NP714580
Cone/Cup (RH) NP952605-JL69310P
1997-1996 (A604 41TE)(Prod. thru mid 1997)
Cone/Cup (LH) NP889967-NP714580
Cone/Cup (RH) JL69348-JL69310
1995 (A604 41TE)
Cone/Cup JL69348-JL69310[2]

Torque Convertor / Frt Pump

2003-1995 (41TE)
Seal331228H
Repair SleeveKWK99149

Input Shaft

2002 Stratus (Coupe)(2.4L)
Ndl Bearing B1616[2]

Transfer Shaft

2003-2002 (A604, 41TE)
Cone/Cup (Inner) NP853895-NP352518[2]
Cone/Cup (Outer) NP716862-LM501310[2]
2001-1996 (A604, 41TE)
Cone/Cup (Inner) NP853895-NP352518[2]
Set (Outer) SET45[2]
1995 (A604, 41TE)
Cone/Cup (Inner) 13687-13623X[2]
Set (Outer) SET45[2]

Output Shaft

2006-1995 (A604 41TE)
Seal3459S[2]
Repair SleeveKWK99157[2]
2005-2001 (F4A42 1, F4A51 2)
Seal Viton710259[2]

Manual Shaft

2006-1995 (40TE, 41TE)
Seal8609

5-SPEED MANUAL TRANSAXLE**Differential**

1998-1995
Set SET11

5-SPEED MANUAL TRANSAXLE**Output Shaft**

1998-1995
Seal3459S[2]
Repair SleeveKWK99157[2]

CAMSHAFT SEAL**4 Cylinder**

2006-1995 122/2.0L (SOHC), 148/2.4L (DOHC)
Seal Viton320249
Repair SleeveKWK99139
2005-2001 2350cc/2.4L (SOHC)
Seal3771

6 Cylinder

2005-2001 181/3.0L
Seal3771[2]
Repair SleeveKWK99139[2]
2000-1995 2497cc/2.5L
Seal3771[2]
Repair SleeveKWK99139[2]

CRANKSHAFT FRONT SEAL**4 Cylinder**

2006-1995 122/2.0L, 148/2.4L (DOHC)
Seal Viton320348
Repair SleeveKWK99128
2005-2001 2351cc/2.4L (SOHC)
Seal224460

6 Cylinder

2006-2001 167/2.7L (DOHC)
Seal710469
2005-2001 181/3.0L
Seal223750
2000-1995 2497cc/2.5L
Seal Viton320348

CRANKSHAFT REAR SEAL**4 Cylinder**

2006-1995 2429cc/2.4L (DOHC)
Seal Viton710056
Seal PTFE H/D5279
2005-2001 2350cc/2.4L (SOHC)
Seal710238
2000-1995 122/2.0L, 148/2.4L
Seal Viton710056
Seal PTFE H/D5279

6 Cylinder

2006-2001 167/2.7L, 181/3.0L
Seal Viton710056
Seal PTFE H/D5279
2000-1995 2497cc/2.5L
Seal Viton229005
Seal PTFE H/D5279

Mfg./Year Model & Location Part No. Mfg./Year Model & Location Part No.

DODGE - REAR DRIVE - Challenger, Charger, Magnum (New Style)

FRONT WHEEL

RWD

2009-2005
Hub Unit Bearing HA590030[2] ²⁵

AWD

2009-2005 Charger, Magnum
Hub Unit Bearing HA590142 ²⁵

REAR WHEEL

RWD

2009-2005
Hub Unit Bearing HA590142[2] ²⁵

AWD

2009-2005 Charger, Magnum
Hub Unit Bearing HA590142[2] ²⁵

4WD FRONT AXLE

Differential

2006-2005 Magnum
Cone/Cup LM503349-LM503310[2]

Pinion

2006-2005 Magnum
Cone/Cup (Inner) M88043-M88010
Cone/Cup (Outer) M88043-M88010

REAR AXLE

Pinion

2006-2005
Cone/Cup (Inner) NP443760-NP564799

4-SPEED AUTOMATIC TRANSMISSION

Torque Converter

2008-2005 (42RLE)
Seal 331228H
Repair Sleeve KWK99149

Rear Seal/Ext. Housing

2008-2005 (42RLE)
Seal Kit 5206 ⁶⁴

CAMSHAFT SEAL

6 Cylinder

2006-2005 215/3.5L
Seal 714655

CRANKSHAFT FRONT SEAL

6 Cylinder

2008-2005 167/2.7L (DOHC)
Seal 710469
2008-2005 215/3.5L (SOHC)
Repair Sleeve KWK99139
2006-2005 215/3.5L
Seal 3638

CRANKSHAFT REAR SEAL

6 Cylinder

2008-2005 167/2.7L (DOHC), 215/3.5L (SOHC)
Seal Viton 710056
Seal PTFE H/D 5279

DODGE - REAR DRIVE - Viper GTS Coupe, Viper RT/10

FRONT WHEEL

RWD

2008-1996
Hub Unit Bearing 513132[2]
1995-1992
Hub Unit Bearing 513109[2] ⁹⁰

REAR WHEEL

RWD

2008-1996
Hub Unit Bearing 513109[2] ⁹⁰
1995-1992
Hub Unit Bearing 513109[2] ⁹⁰

²⁵New Item, Check For Availability

⁶⁴Seal & Bushing Kit

⁹⁰6 Stud.

Mfg./Year	Model & Location	Part No.	Mfg./Year	Model & Location	Part No.
DODGE - REAR DRIVE - Viper GTS Coupe, Viper RT/10 (cont.)					

REAR AXLE**Axle Shaft**

2002-1992 (Spicer 44 Ser.)
Ndle Bearing B2412[2]

Differential Rebuild Kit

2000-1992 (Dana/Spicer 44 Axle)
Kit DRK339A

Differential

2006-1992 (Dana/Spicer 44 Axle)
Seal Viton 473227V[2]
Set SET36[2]

Pinion

2006-2001 (Dana/Spicer 44 Axle)
Seal Viton 100715V
Cone/Cup (Inner) M802048-M802011
Cone/Cup (Outer) M88048-M88010
2000-1992 (Dana/Spicer 44 Axle)
Seal 9316
Repair Sleeve KWK99187
Cone/Cup (Inner) M802048-M802011
Cone/Cup (Outer) M88048-M88010

CLUTCH**Pilot Bearing**

2002-1992
Ndle Bearing SCE1211

Release Bearing

2002-1992 8.0 V10
Bearing Assy 614061

6-SPEED MANUAL TRANSMISSION**Transmission Rebuild Kit**

2002-1992
Kit TRK56

Main Shaft

2002-1992 (Frt. main shaft)
Seal 7412S[2]
Cone/Cup M88048-M88010[2]
2002-1992 (Main shaft pocket)
Seal 7300S[2]
Set SET16[2]
2002-1992 (Rr. main shaft)
Cone/Cup 25572-25520[2]

Countershaft

2002-1992 (Frt. C/S)
Set SET5[2]
2002-1992 (Middle C/S)
Bearing Assy 32008XM[2]
2002-1992 (Rr. C/S)
Set SET16[2]

CRANKSHAFT FRONT SEAL**10 Cylinder**

2006-1994 488/8.0L, 505/8.3L
Seal Viton 471424V
Repair Sleeve KWK99199
Harmnc Balancer Slvs 88199

CRANKSHAFT REAR SEAL**10 Cylinder**

2002-1994 488/8.0L
Seal 328039

Mfg./Year Model & Location Part No. Mfg./Year Model & Location Part No.

DODGE - Import - Colt, Colt Vista, Stealth, 2000-GTX

FRONT WHEEL

FWD

1996-1991	Stealth (FWD)	
Seal (Inner)	710182[2]
Ball Bearing (Inner)	510034[2]
Seal (Outer)	710183[2]
1995-1993	Colt	
Seal (Inner)	8430S[2]
Ball Bearing (Inner)	510016[2]
Seal (Outer)	4898[2]
1992-1990	Colt	
Seal (Inner)	474134[2]
Set (Inner)	SET41[2]
Set (Outer)	SET41[2]
1991-1990	Colt Vista (FWD)	
Seal (Inner)	474134[2]
Set (Inner)	SET41[2]
Set (Outer)	SET41[2]
1990	2000 GTX (Canada only)	
Seal	225230[2]
Ball Bearing	513036[2]

4WD

1991-1990	Colt Vista	
Seal (Inner)	225450[2]
Ball Bearing (Inner)	513036[2]
Seal (Outer)	225230[2]

AWD

1996-1991	Stealth R/T	
Hub Unit Bearing	513133[2]

REAR WHEEL

FWD

1996-1991	Stealth (FWD)	
Hub Unit Bearing	512039[2]
1995-1993	Colt (ABS)	
Hub Unit Bearing	512033[2]
1995-1993	Colt (Non-ABS)	
Hub Unit Bearing	512148[2]
1992-1991	Colt (Rr. Drum)	
Seal (Inner)	1205N[2]
Bearing Assy (Inner)	516001WB[2]
Bearing Assy (Outer)	516001WB[2]
1991-1990	Colt Vista (FWD)	
Seal (Inner)	1196[2]
Set (Inner)	SET4[2]
Set (Outer)	SET1[2]
1990	2000 GTX (Canada only)	
Seal (Inner)	1196[2]
Set (Inner)	SET4[2]
Set (Outer)	SET1[2]
1990	Colt (2Dr.)(Disc)	
Seal (Inner)	1205N[2]
Bearing Assy (Inner)	516000[2]
Bearing Assy (Outer)	516000[2]
1990	Colt (2Dr.)(Drum)	
Seal (Inner)	1205N[2]
Bearing Assy (Inner)	516001WB[2]
Bearing Assy (Outer)	516001WB[2]

REAR WHEEL (cont.)

FWD (cont.)

1990	Colt (4Dr.)	
Seal (Inner)	1205N
Bearing Assy (Inner)	513029[2] ^z
Bearing Assy (Outer)	513029[2] ^z

4WD

1994-1992	Colt Wagon (4WD)	
Seal (Inner)	1205N[2]
Bearing Assy (Inner)	513029[2] ^z
Bearing Assy (Outer)	513029[2] ^z
1991-1990	Colt Wagon (4WD)	
Seal (Inner)	1205N[2]
Bearing Assy (Inner)	513029[2] ^z
Bearing Assy (Outer)	513029[2] ^z

AWD

1996-1991	Stealth R/T	
Seal (Inner)	710152[2]
Ball Bearing (Inner)	511014[2]
Ball Bearing (Outer)	511015[2]

REAR AXLE

Pinion

1996-1991	Stealth R/T (AWD)	
Seal	710207
Repair Sleeve	KWK99166
1991-1990	Colt Vista	
Seal	471747
Repair Sleeve	KWK99139
Bearing Assy (Inner)	32207M
Bearing Assy (Outer)	30305M

4-SPEED AUTOMATIC TRANSMISSION

Torque Converter

1994-1992		
Seal	320583
Repair Sleeve	KWK99157

CLUTCH

Release Bearing

1996-1991	Stealth R/T (AWD)	
Bearing Assy	614099
1996-1990	Stealth (w/o AWD)	
Bearing Assy	614126
1992-1990	Colt (FWD)(w/o (4WD)	
Bearing Assy	614126
1990	Colt Vista (FWD)	
Bearing Assy	614126

3-SPEED AUTOMATIC TRANSAXLE

Differential

1996-1990	(w/o KM172 0, KM172 5)	
Ball Bearing	207[2]
1990	(KM172 0, KM172 5)	
Bearing Assy	30207M[2]

^zNon-Cancellable/Non-Returnable

Mfg./Year	Model & Location	Part No.	Mfg./Year	Model & Location	Part No.
DODGE - Import - Colt, Colt Vista, Stealth, 2000-GTX (cont.)					

3-SPEED AUTOMATIC TRANSAXLE**Torque Converter**

1996-1990	
Seal	320583
Repair Sleeve	KWK99157

Output Shaft

1996-1990	
Seal	223543[2]
Repair Sleeve	KWK99139[2]

4-SPEED AUTOMATIC TRANSAXLE**Differential**

1996-1990	(F4A21 2, F4A22 2, F4A33 1, KM176 5)	
Ball Bearing		207[2]
1992-1990	(ZF4HP 18)	
Cone/Cup (LH)	LM806649-LM806610	
Cone/Cup (RH)	LM300849-LM300811	

Torque Converter / Frt Pump

1996-1990	(w/o ZF4HP 18, 41TE)
Seal	320583
Repair Sleeve	KWK99157
1992-1990	(ZF4HP 18)
Seal	224510
Repair Sleeve	KWK99177

Output Shaft

1996-1993	(F4A21 2, F4A22 2)	
Seal	223543[2]	
Repair Sleeve	KWK99139[2]	
1996-1993	(F4A33 1)	
Seal Viton	710259[2]	
1996-1992	(W4A32 1)	
Seal (LH)	223543	
Repair Sleeve	KWK99139	
Seal (RH)	710199	
Repair Sleeve	KWK99139	
1992-1990	(F4A21 2, F4A22 2, F4A33 1, KM176 5)	
Seal	223543[2]	
Repair Sleeve	KWK99139[2]	
1992-1990	(ZF4HP 18)	
Seal (LH)	224462	
Seal (RH)	710422 ¹⁶	

4-SPEED MANUAL TRANSAXLE**Differential**

1992-1990	(F4M21 1)	
Ball Bearing		207[2]

Input Shaft

1992-1990	(F4M21 1, KM200 0)
Seal Viton	712007
Repair Sleeve	KWK99098

4-SPEED MANUAL TRANSAXLE**Output Shaft**

1992-1990	(F4M21 1, KM200 0)
Seal	223543[2]
Bearing Assy	30206M[2]
Repair Sleeve	KWK99139[2]

Selector Shaft Seal/Man. Shaft

1992-1990	(KM160 2)
Seal	710222

5-SPEED MANUAL TRANSAXLE**Differential**

1996-1990	(KM182 2, F5M22 2, KM182 0, KM206 0, KM221 1)	
Bearing Assy		30207M[2]
1996-1990	(F5M21 1, F5M21 2, W5M31 2, W5M33 2, KM162 0, KM162 0, KM163 0, KM201 0)	
Ball Bearing		207[2]
1994-1991	(Getrag)	
Seal		710353[2]

Input Shaft

1996-1990	(F5M21 1, F5M21 2, F5M22 2, F5M33 2W5M31 2, W5M33 2)
Seal Viton	712007
Repair Sleeve	KWK99098
1994-1991	(Getrag)
Seal Viton	712007
Repair Sleeve	KWK99098
1991-1990	(KM182 2, KM182 0, KM221 1)
Seal Viton (Center)	712007
Ball Bearing (Center)	304WB[2]
Bearing Assy (Rr)	30304[2]
Repair Sleeve	KWK99098

Output Shaft

1996-1992	(W5M33 2)
Seal (LH)	223543
Repair Sleeve	KWK99139
Seal (RH)	710199
Repair Sleeve	KWK99139
1996-1990	(F5M21 1, F5M21 2, F5M22 2, KM201 0, KM206 0)
Seal	223543[2]
Bearing Assy	30206M[2]
Repair Sleeve	KWK99139[2]
1996-1990	(KM182 2, KM162 0, KM163 0, KM221 1, F5M31 2, F5M33 2)
Seal	223543[2]
Repair Sleeve	KWK99139[2]
1994-1993	(Getrag)
Seal Viton	710259[2]
1993-1992	(W5M31 2)
Seal (LH)	223543
Repair Sleeve (LH)	KWK99139
Seal (RH)	1981
Repair Sleeve (RH)	KWK99114

¹⁶Obsolete

Mfg./Year Model & Location Part No. Mfg./Year Model & Location Part No.

DODGE - Import - Colt, Colt Vista, Stealth, 2000-GTX (cont.)

5-SPEED MANUAL TRANSAXLE (cont.)

Output Shaft (cont.)

1992-1991 (Getrag)
 Seal 223543[2]
 Repair Sleeve KWK99139[2]

Selector Shaft Seal/Man. Shaft

1996-1990 (KM162 0)
 Seal 710222

6-SPEED MANUAL TRANSAXLE

Input Shaft

1996-1995 (Getrag)
 Seal Viton 712007
 Repair Sleeve KWK99098

Output Shaft

1996-1995 (Getrag)
 Seal Viton 710259[2]

DRIVESHAFT SUPPORT

1991-1990 Colt Vista (4WD)
 Hanger Bearing Assy HB25[2]

OIL PUMP

4 Cylinder

1994-1993 2351cc/ 2.4L
 Seal 222025
 Repair Sleeve KWK99078
 1991-1990 122/2.0L
 Seal 222025
 Repair Sleeve KWK99078
 1990 1597cc/1.6L (DOHC)
 Seal 222025
 Repair Sleeve KWK99078
 1990 1755cc/1.8L (SOHC)
 Seal 221710
 Repair Sleeve KWK99078

CAMSHAFT SEAL

4 Cylinder

1996-1990
 Seal 3771[2]
 Repair Sleeve KWK99139[2]

6 Cylinder

1996-1991 2972cc/3.0L
 Seal 3771[2]
 Repair Sleeve KWK99139[2]
 1996-1991 2972cc/3.0L (DOHC)
 Seal (Frt) 223010[2]
 Seal (Rr) 710302[2]
 Repair Sleeve KWK99114[4]

CRANKSHAFT FRONT SEAL

4 Cylinder

1996-1992 1834cc/1.8L
 Seal 223750
 Repair Sleeve KWK99145
 1996-1990 1595cc/1.6L (DOHC),
 1597cc/1.6L, 1755cc/1.8L,
 1997cc/2.0L, 2351cc/2.4L
 Seal 224460
 1995-1990 1468cc/1.5L
 Seal 223018
 Repair Sleeve KWK99114

6 Cylinder

1996-1991 181/3.0L
 Seal 223750

CRANKSHAFT REAR SEAL

4 Cylinder

1994-1993 1834cc/1.8L, 2351cc/2.4L
 Seal Viton 710235
 1994-1990 1468cc/1.5L
 Seal 227235
 1992-1990 1595cc/1.6L (DOHC),
 1834cc/1.8L, 1997cc/2.0L,
 2351cc/2.4L
 Seal Viton 228005
 Repair Sleeve KWK99315

6 Cylinder

1996-1991 2972cc/3.0L
 Seal Viton 710056
 Seal PTFE H/D 5279

DODGE - Minivan (See also Plymouth) - Caravan, Grand Caravan**FRONT WHEEL****FWD**

2008	
Hub Unit Bearing	HA590243[2] ²⁵
2007-2001	
Hub Unit Bearing	513123[2]
2000-1996 (14" Whl.)	
Hub Unit Bearing	513122[2]
2000-1996 (15", 16", 17" Whl.)	
Hub Unit Bearing	513123[2]
1995-1991 (14" Whl.)	
Hub Unit Bearing	513075[2]
1995-1990 (15" Whl.)	
Hub Unit Bearing	513074[2] ⁴⁴
1990 (14" Whl.)	
Seal	5604[2] ⁵⁶
Ball Bearing (Opt)	513006[2]
Hub Unit Bearing (4	
Stud)	518501[2] ⁶²
Hub Unit Bearing (5	
Lug Whl.)	518502[2] ⁶³

AWD

1993-1991 (14" Whl.)	
Hub Unit Bearing	513075[2]
1993-1991 (15" Whl.)	
Hub Unit Bearing	513074[2] ⁴⁴

REAR WHEEL**FWD**

2009-2008	
Hub Unit Bearing	HA590317[2] ²⁵
2007-2001 (ABS)	
Hub Unit Bearing	512169[2]
2007-2001 (Non-ABS)	
Hub Unit Bearing	512170[2]
2000-1996 (14" Whl.)	
Hub Unit Bearing	512155[2]
2000-1996 (15", 16", 17" Whl.)	
Hub Unit Bearing	512156[2]
1995-1990	
Seal (Inner)	4249[2]
Set (Inner)	SET17[2]
Set (Outer)	SET16[2]

AWD

2004-1997 (15", 16", 17" Whl.)	
Hub Unit Bearing	512157[2]
1993-1991	
Hub Unit Bearing	512125[2]

FRONT AXLE**Differential**

1999-1994 (AWD)	
Cone/Cup	JL69349H-JL69310[2]

FRONT AXLE**Pinion**

1999-1994 (AWD)	
Set (Inner)	SET45
Set (Outer)	SET17

AWD REAR AXLE**Differential**

2002-1994	
Cone/Cup	JL69349H-JL69310[2]

Pinion

2002-1994	
Set (Inner)	SET45
Set (Outer)	SET17

TRANSFER CASE**Input Shaft**

2004-1992	
Seal	710501

Front Output Shaft

2004-1991	
Seal	3459S
Repair Sleeve	KWK99157
Ball Bearing	106WB

CLUTCH**Release Bearing**

1994-1990 (4 Cyl.)	
Bearing Assy	614092

3-SPEED AUTOMATIC TRANSAXLE**Differential**

2003-1996 (A404 31TH)	
Seal (LH)	3459S
Cone/Cup (LH)	NP889967-NP714580
Seal (RH)	3459S
Cone/Cup (RH)	NP952605-JL69310P
Seal (RH)	3459S
Cone/Cup (RH) (Thru	
Mid 1997)	JL69348-JL69310
1995-1992 (A404 31TH)	
Seal	3459S[2]
Cone/Cup	JL69349CP-JL69310[2]
1991-1990 (A404)	
Seal	3459S[2]
Cone/Cup	JL69349H-JL69310[2]

Torque Converter

2002-1990	
Seal	331228H[2]
Repair Sleeve	KWK99149

²⁵New Item, Check For Availability ⁴⁴Brg Flg Mtg Holes Threaded. ⁵⁶Opt. Kit = Seal 3948 & Sleeve ⁶²Kit = Plate, Gasket, 3 Bolts, Studded Spindle, Seal, & Bearing ⁶³Kit = Plate, Gasket, 3 Bolts, Studded Spindle, Seal, & Bearing

Mfg./Year	Model & Location	Part No.	Mfg./Year	Model & Location	Part No.
DODGE - Minivan (See also Plymouth) - Caravan, Grand Caravan (cont.)					

3-SPEED AUTOMATIC TRANSAXLE

Transfer Shaft

- 2002-1997 (A404 31TH)(Prod. from mid 1997 on)
 - Cone/Cup (LH) NP952605-JL69310P[2]
 - Cone/Cup (RH) NP952605-JL69310P[2]
- 1997-1992 (A404 31TH)(Prod. thru mid 1997)
 - Cone/Cup (LH) JL69349CP-JL69310P[2]
 - Cone/Cup (RH) JL69349CP-JL69310P[2]
- 1991-1990 (A404)
 - Cone/Cup (LH) JL69349H-JL69310[2]
 - Cone/Cup (RH) JL69349H-JL69310[2]

Output Shaft

- 2002-1992 (A404 31TH)
 - Seal 3459S[2]
 - Cone/Cup L68149P-L68111P[2]
- 1991-1990 (A404 31TH, A413)
 - Seal 3459S[2]
 - Set SET17[2]

Manual Shaft

- 2002-1990
 - Seal 8609[2]

4-SPEED AUTOMATIC TRANSAXLE

Differential

- 2004-1997 (A604 41TE)(AWD)(Prod. from mid 1997 on)
 - Cone/Cup (LH) NP889967-NP714580
 - Cone/Cup (RH) LM503349-LM503310
- 2004-1997 (A604 41TE)(Prod. from mid 1997 on)
 - Cone/Cup (LH) NP889967-NP714580
 - Cone/Cup (RH) NP952605-JL69310P
- 1997 (A604 41TE)(AWD)(Prod. thru mid 1997)
 - Cone/Cup (LH) NP889967-NP714580
 - Cone/Cup (RH) JL69348-JL69310
- 1997-1996 (A604 41TE)(Prod. thru mid 1997)
 - Cone/Cup (LH) NP889967-NP714580
 - Cone/Cup (RH) JL69348-JL69310
- 1995-1994 (A604 41TE)(AWD)
 - Cone/Cup (LH) JL69349-JL69310
 - Cone/Cup (RH) LM503349-LM503310
- 1995-1990 (A604 41TE)
 - Set SET11[2]
 - Seal 3459S[2]
 - Repair Sleeve KWK99157[2]
- 1993-1991 (A604 41TE)(AWD)
 - Cone/Cup (LH) JL69348-JL69310
 - Cone (RH) LM503349

4-SPEED AUTOMATIC TRANSAXLE

Torque Converter / Frt Pump

- 2002-1990
 - Seal 331228H
 - Repair Sleeve KWK99149

Transfer Shaft

- 2004-2002 (A604, 41TE)
 - Cone/Cup (LH) NP853895-NP352518[2]
 - Cone/Cup (RH) NP716862-LM501310[2]
- 2001-1996 (A604, 41TE)
 - Cone/Cup (Inner) NP853895-NP352518[2]
 - Set (Outer) SET45[2]
- 1995-1991 (A604, 41TE)
 - Cone/Cup (Inner) 13687-13623X[2]
 - Set (Outer) SET45[2]

Output Shaft

- 2000-1997 (A604 41TE)(AWD)(Prod. from mid 1997 on)
 - Seal (Outer) 3459S[2]
 - Cone/Cup (Outer) LM300848-LM300911[2]
 - Cone/Cup (Inner) NP952605-JL69310P[2]
- 2000-1997 (A604 41TE)(Prod. from mid 1997 on)
 - Seal (Outer) 3459S[2]
 - Cone/Cup (Outer) LM300848-LM300911[2]
 - Cone/Cup (Inner) NP952605-JL69310P[2]
- 1997-1991 (A604 41TE)(AWD)(Prod. thru mid 1997)
 - Seal (Outer) 3459S[2]
 - Cone/Cup (Outer) LM300848-LM300811[2]
 - Cone/Cup (Inner) JL69348-JL69310[2]
- 1997-1991 (A604 41TE)(Prod. thru mid 1997)
 - Seal (Outer) 3459S[2]
 - Cone/Cup (Outer) LM300848-LM300811[2]
 - Cone/Cup (Inner) JL69348-JL69310[2]
- 1990 (A604, A670)
 - Seal 3459S[2]
 - Set SET17[2]

Manual Shaft

- 2007-1990
 - Seal 8609

5-SPEED MANUAL TRANSAXLE

Differential

- 1995-1990 (A465, A520, A523, A525, A555)
 - Seal 3459S[2]
 - Set SET11[2]
 - Repair Sleeve KWK99157[2]

Mfg./Year Model & Location Part No. Mfg./Year Model & Location Part No.

DODGE - Minivan (See also Plymouth) - Caravan, Grand Caravan (cont.)

5-SPEED MANUAL TRANSAXLE

Input Shaft

1995-1990 (A465, A520, A523, A525, A555)
 Seal (Frnt) 3732S[2]
 Set (Frnt) SET4[2]
 Set (Rr) SET5[2]

Selector Shaft Seal/Man. Shaft

2003-1990 (A465, A520, A523, A525, A555)
 Seal 3816[2]

CAMSHAFT SEAL

4 Cylinder

2006-1996 148/2.4L (DOHC)
 Seal Viton 320249[2]
 Repair Sleeve KWK99139[2]
 1995-1990 153/2.5L
 Seal 3655S
 Repair Sleeve KWK99139

6 Cylinder

2000-1990 181/3.0L
 Seal 3771[2]
 Repair Sleeve KWK99139[2]

CRANKSHAFT FRONT SEAL

4 Cylinder

2007-1996 148/2.4L
 Seal Viton 320348
 Repair Sleeve KWK99128
 1995-1990 153/2.5L
 Seal 3638
 Repair Sleeve KWK99112

6 Cylinder

2008-1990 201/3.3L, 230/3.8L
 Seal 3638
 Repair Sleeve KWK99112
 2000-1990 181/3.0L
 Seal 223750

CRANKSHAFT REAR SEAL

4 Cylinder

2007-1990 135/2.2L, 148/2.4L, 153/2.5L
 Seal Viton 710056
 Seal PTFE H/D 5279

6 Cylinder

2008-2001 201/3.3L, 230/3.8L
 Seal Viton 710056
 Seal PTFE H/D 5279
 2000-1990 181/3.0L, 201/3.3L, 231/3.8L
 Seal Viton 710056
 Seal PTFE H/D 5279

DODGE - Lt Truck, SUV - Ram 50

FRONT WHEEL

RWD

1993-1990
 Seal (Inner) 225010[2]
 Set (Inner) SET5[2]
 Set (Outer) SET3[2]

FRONT WHEEL

4WD

1993-1990
 Seal (Inner) 225875[2]
 Set (Inner) SET47[2]
 Set (Outer) SET47[2]

Mfg./Year Model & Location Part No. Mfg./Year Model & Location Part No.

DODGE - Lt Truck, SUV - Ram 50 (cont.)

REAR WHEEL

RWD

1993-1990
 Seal (Inner) 4989[2]
 Seal (Outer) 225110[2]
 Bearing Assy (Outer) 30208M[2]

4WD

1993-1990
 Seal (Inner) 4989[2]
 Seal (Outer) 225110[2]
 Bearing Assy (Outer) 30208M[2]

4WD FRONT AXLE

Differential

1993-1990 (4 Cyl.)
 Seal 710335[2]
 Cone/Cup 17887-17831[2]
1993-1990 (6 Cyl.)
 Seal 710151[2]
 Cone/Cup 17887-17831[2]

Pinion

1993-1990 (4 Cyl.)
 Seal 224255
 Cone/Cup (Outer) M86649-M86610
 Cone/Cup (Inner) HM89449-HM89410
1993-1990 (6 Cyl.)
 Seal 224570
 Cone/Cup (Outer) M88043-M88010
 Cone/Cup (Inner) HM89449-HM89410

Steering Knuckle

1993-1990
 Seal 710146[2]

REAR AXLE

Differential

1993-1990
 Cone/Cup 17887-17831[2]

Pinion

1993-1990 (4 Cyl.)
 Seal 224570
 Cone/Cup (Inner) HM89449-HM89410
 Cone/Cup (Outer) M88043-M88010
 Repair Sleeve KWK99177
1993-1990 (6 Cyl.)
 Seal 224570
 Cone/Cup (Inner) HM89249-HM89210
 Cone/Cup (Outer) M88043-M88010
 Repair Sleeve KWK99177

TRANSFER CASE

Input Shaft

1993-1990 (V4AC1 2, V5M21 2)
 Seal 1992
 Ball Bearing 5209W[2]
 Repair Sleeve KWK99177

Front Output Shaft

1993-1990
 Seal 223608
 Ball Bearing 306TB[2]
 Repair Sleeve KWK99146

Rear Output Shaft

1993-1990
 Seal 224052
 Ball Bearing 211TB[2]
 Repair Sleeve KWK99157

4-SPEED AUTOMATIC TRANSMISSION

Torque Converter

1993-1990 (A500)
 Seal 331228H

Selector Shaft Seal/Man. Shaft

1993-1990 (A500)
 Seal 8609

Output Shaft

1993-1990 (A500)
 Seal Kit 5206⁶⁴
 Repair Sleeve KWK99149

CLUTCH

Pilot Bearing

1992-1990 (6 Cyl.)
 Ball Bearing 203FF
1992-1990 (4 Cyl.)
 Ball Bearing 102CC

Release Bearing

1993-1990 Raider 4 Cyl. w/o 2.6 L. 4 Cyl.
 (Hyd. Mechanism)
 Bearing Assy 614016
1992-1990 Raider 6 Cyl.
 Bearing Assy 614107
1992-1990 50 Ser. Trucks 6 Cyl.
 Bearing Assy 614107
1992-1990 50 Ser. Trucks 4 Cyl.(w/o 2.6
 L. 4 Cyl.)(Hyd. Mechanism)
 Bearing Assy 614016
1991-1990 Dakota
 Bearing Assy 614054

⁶⁴Seal & Bushing Kit

DODGE - Lt Truck, SUV - Ram 50 (cont.)**5-SPEED MANUAL TRANSMISSION****Front Input Shaft**

1993-1990 (M1S5)	
Seal	223255
Repair Sleeve	KWK99128
1993-1990 (w/o KM119, M1S5)	
Seal	223014
Ball Bearing	307L[2]
Repair Sleeve	KWK99114

Rear Output Shaft

1993-1990 (KM145 8)	
Seal	223608
Ball Bearing	511014[2]

DRIVESHAFT SUPPORT

1995-1990 Power Ram 50	
Hanger Bearing Assy	HB30[2]
1992-1990 Ram 50	
Hanger Bearing Assy	HB22[2]

OIL PUMP**4 Cylinder**

1993-1990 2351cc/ 2.4L	
Seal	222025
Repair Sleeve	KWK99078

CAMSHAFT SEAL**4 Cylinder**

1993-1990 1997cc/2.0L, 2346cc/2.3L, 2350cc/2.4L	
Seal	3771
Repair Sleeve	KWK99139

6 Cylinder

1993-1990 2972cc/3.0L	
Seal	3771
Repair Sleeve	KWK99139

CRANKSHAFT FRONT SEAL**4 Cylinder**

1993-1990 2350/2.4L (SOHC)	
Seal	224460

6 Cylinder

1991-1990 2972cc/3.0L	
Seal	223750

CRANKSHAFT REAR SEAL**4 Cylinder**

1993-1990 1997cc/2.0L, 2346cc/2.3L, 2350cc/2.4L, 2555cc/2.6L	
Seal Viton	228005
Repair Sleeve	KWK99315

6 Cylinder

2008-2004 226/3.7L	
Seal	710471
1991-1990 2972cc/3.0L	
Seal Viton	710056
Seal PTFE H/D	5279

8 Cylinder

2003-1998 360/5.9L	
Seal Split	5106
2000-1990 318/5.2L	
Seal	5414

Mfg./Year Model & Location Part No. Mfg./Year Model & Location Part No.

DODGE - Lt Truck, SUV - Dakota, Durango, Nitro

FRONT WHEEL

RWD

2008-2007 Nitro	
Hub Unit Bearing	HA590245[2] ²⁵
2008-2006 Durango (4 Whl. ABS)	
Hub Unit Bearing	HA590244[2] ²⁵
2008-2005 Dakota (4 Whl. ABS)	
Hub Unit Bearing	HA590035[2]
2008-2005 Dakota (Rr. Whl. ABS)	
Hub Unit Bearing	HA590034[2] ²⁵
2005-2004 Durango (4 Whl. ABS)	
Hub Unit Bearing	HA590033[2] ²⁵
2004-1997 Dakota (4 Whl. ABS)	
Hub Unit Bearing	HA599406[2]
Set (Opt. Tapered Unit Brg.)	SET815[2]
2004-1997 Dakota (Rr. Whl. ABS)	
Hub Unit Bearing	HA599528[2]
Set (Opt. Tapered Unit Brg.)	SET815[2]
2003-1999 Durango (4 Whl. ABS)	
Hub Unit Bearing	HA599406[2]
Set (Opt. Tapered Unit Brg.)	SET815[2]
2003-1999 Durango (Rr. Whl. ABS)	
Hub Unit Bearing	HA599528[2]
Set (Opt. Tapered Unit Brg.)	SET815[2]
1996-1990 Dakota	
Seal (Inner)	3087[2]
Set (Inner)	SET11[2]
Set (Outer)	SET16[2]

4WD

2008-2007 Nitro	
Hub Unit Bearing	HA590245[2] ²⁵
2008-2006 Durango (4 Whl. ABS)	
Hub Unit Bearing	HA590244[2] ²⁵
2008-2005 Dakota (4 Whl. ABS)	
Hub Unit Bearing	HA590035[2]
2008-2005 Dakota (Rr. Whl. ABS)	
Hub Unit Bearing	HA590034[2] ²⁵
2005-2004 Durango (4 Whl. ABS)	
Hub Unit Bearing	HA590033[2] ²⁵
2004-1997 Dakota (4 Whl. ABS)	
Hub Unit Bearing (RH)	SP450100 ⁷⁸
Hub Unit Bearing (LH)	SP450101 ⁷⁸
Sensor Kit (RH)	SK450100 ³⁹
Sensor Kit (LH)	SK450101 ³⁹
2004-1997 Dakota (Rr. Whl. ABS)	
Hub Unit Bearing	HA599361[2]
2003-1998 Durango (4 Whl. ABS)	
Hub Unit Bearing (RH)	SP450100 ⁷⁸
Hub Unit Bearing (LH)	SP450101 ⁷⁸
Sensor Kit (RH)	SK450100 ³⁹
Sensor Kit (LH)	SK450101 ³⁹
2003-1998 Durango (Rr. Whl. ABS)	
Hub Unit Bearing	HA599361[2]
1996-1990 Dakota	
Hub Unit Bearing	513109[2] ⁹⁰
1990 Dakota	
Hub Unit Bearing	513082[2] ⁴⁰

REAR WHEEL

RWD

2009 Nitro	
Seal	SL260004[2] ²⁵
Cylindrical Bearing	6410[2]
2009-2004 Durango	
Seal	SL260004[2] ²⁵
Cylindrical Bearing	6410[2]
2008-2007 Nitro	
Seal	SL260010[2]
Cylindrical Bearing	6408[2]
2008-1990 Dakota	
Seal	8835S[2]
Cylindrical Bearing	6408[2]
Bearing & Seal Kit	TRP1559TV[2] ¹⁹
2003-1998 Durango	
Seal	8835S[2]
Cylindrical Bearing	6408[2]
Bearing & Seal Kit	TRP1559TV[2] ¹⁹

4WD

2009 Nitro	
Seal	SL260004[2] ²⁵
Cylindrical Bearing	6410[2]
2009-2004 Durango	
Seal	SL260004[2] ²⁵
Cylindrical Bearing	6410[2]
2008-2007 Nitro	
Seal	SL260010[2]
Cylindrical Bearing	6408[2]
2008-1990 Dakota	
Seal	8835S[2]
Cylindrical Bearing	6408[2]
Bearing & Seal Kit	TRP1559TV[2] ¹⁹
2003-1998 Durango	
Seal	8835S[2]
Cylindrical Bearing	6408[2]
Bearing & Seal Kit	TRP1559TV[2] ¹⁹

4WD FRONT AXLE

Axle Shaft

2008-2000 (8" R.G.)	
Seal	710489[2] ²⁵

Differential Rebuild Kit

2008-2000 (8" R.G.)	
Kit	DRK305 ²⁵
Kit	DRK305MK ²²
1999-1997 (Dana/Spicer 35 Axle)	
Kit	DRK335
Kit	DRK335MK
1996-1990 Dakota (7.25" R.G.)	
Kit	DRK302
Kit	DRK302MK ²²

¹⁹Opt. Axle Rpr Brg. Replaces O.E. Brg & Seal ²²Master Kit ²⁵New Item, Check For Availability
³⁹Opt. Kit = Cable, Screw, Grease. ⁴⁰5 Stud. ⁷⁸6 Stud, New Item. ⁹⁰6 Stud.

DODGE - Lt Truck, SUV - Dakota, Durango, Nitro (cont.)**4WD FRONT AXLE****Pinion**

2008-2000 (8" R.G.)	
Seal	710476
Cone/Cup (Inner)	M88048-M88010
Cone/Cup (Outer)	NP722065-NP013743
1999-1997 (Dana/Spicer 35 Axle)	
Seal Viton	714675
Repair Sleeve	KWK99181
Cone/Cup (Inner)	HM88648-HM88610
Cone/Cup (Outer)	M86649-M86610

Intermediate Shaft

1992-1990 (Chrysler 7.5" R.G.)	
Ndle Bearing (Pilot)	B2516
Ndle Bearing	B5020

REAR AXLE**Differential Rebuild Kit**

2008-2001 (9.25" R.G.)	
Kit	DRK304A ²⁵
2008-1990 (8.25" R.G.)	
Kit	DRK303
2000-1998 (9.25" R.G.)	
Kit	DRK304
1996-1990 (7.25" R.G.)	
Kit	DRK302

Differential

1996-1990 Dakota (7.25" R.G.)	
Set	SET45[2]

Pinion

2008-2004 (9.25" R.G.)	
Seal	710480
Cone/Cup (Inner)	NP524102-NP912904
Cone/Cup (Outer)	M88048-M88010
2008-2000 (8.25" R.G.)	
Seal	710480
Cone/Cup (Inner)	M802048-M802011
Cone/Cup (Outer)	M86649-M86610
1999-1997 (8.25" R.G.)	
Seal	8516N
Cone/Cup (Inner)	M802048-M802011
Cone/Cup (Outer)	M86649-M86610
Repair Sleeve	KWK99168
1998-1990 Dakota (7.25" R.G.)	
Seal	8516N
Cone/Cup (Inner)	HM88649-HM88610
Cone/Cup (Outer)	M86649-M86610

TRANSFER CASE REBUILD KIT

2008-2001 (233)	
Kit	TCRK233AA ²⁵
2008-2000 (242, 244)(BD50-8 I/S Brg)	
Kit	TCRK242EE ²⁵
2008-1994 (231)(6010n I/S Brg)	
Kit	TCRK231EE ²⁵
1999-1997 (242)(6010N I/S Brg)	
Kit	TCRK242DD ²⁵

TRANSFER CASE REBUILD KIT (cont.)

1993-1990 (231)(BD50-8 I/S Brg)	
Kit	TCRK231 ⁵¹

TRANSFER CASE**Input Shaft**

2000-1990 (New Process 231D, 231DHD)	
Repair Sleeve	KWK99193
Seal (Exc. 2.5L)	3173
Seal (Opt)	710928

Front Output Shaft

2008-1998 (New Process 242D)	
Seal	3946
Repair Sleeve	KWK99187
1997-1990 (New Process 231D, 231DHD)	
Seal	710046
Repair Sleeve	KWK99155

4-SPEED AUTOMATIC TRANSMISSION**Torque Converter**

2003-1999 (A500, 42RH, 46RE)	
Seal	331228H
Repair Sleeve	KWK99149
2002-1990 (A518, 46RH)	
Seal	331227H
Repair Sleeve	KWK99187
1993-1990 (A500)	
Seal	331228H
Repair Sleeve	KWK99149

Rear Seal/Ext. Housing

1993-1990 (A500)(2wd)	
Seal	7300S
Ball Bearing	207XLO[2]
Seal Kit	5206 ⁶⁴
1993-1990 (A500)(4WD)	
Seal	710058
Ball Bearing	207XLO[2]

Selector Shaft Seal/Man. Shaft

2003-1994 (42RE, 46RE)	
Seal	8609
1993-1990 (A500)	
Seal	8609

5-SPEED MANUAL TRANSMISSION**Transmission Rebuild Kit**

2002-1999 (New Venture 1500)	
Kit	TRK1500D
2002-1994 (New Venture 3500)	
Kit	TRK235C
1999-1992 (Aisin AX15)	
Kit	TRKFT420
1993-1990 (New Process A535, 2500)	
Kit	TRK535

²⁵New Item, Check For Availability⁵¹BD50-8 I/S Brg.⁶⁴Seal & Bushing Kit

Mfg./Year	Model & Location	Part No.	Mfg./Year	Model & Location	Part No.
-----------	------------------	----------	-----------	------------------	----------

DODGE - Lt Truck, SUV - Dakota, Durango, Nitro (cont.)

DRIVESHAFT SUPPORT

2001-1990		
Hanger Bearing Assy	HB88107A
Ball Bearing	88107

CRANKSHAFT FRONT SEAL

4 Cylinder

2002-1996	150/2.5L	
Seal	321460
Harmnc Balancer Slvs	88179
Repair Sleeve	KWK99179
1995-1990	153/2.5L	
Seal	3638
Repair Sleeve	KWK99112

6 Cylinder

2008-2004	226/3.7L	
Seal	710472
2003-1992	239/3.9L	
Seal Viton	713103
Harmnc Balancer Slvs	88218
Repair Sleeve	KWK99218

8 Cylinder

2007-2000	287/4.7L	
Seal	722108
2003-1992	318/5.2L, 360/5.9L	
Seal Viton	713103
Repair Sleeve	KWK99218

CRANKSHAFT FRONT SEAL (cont.)

8 Cylinder (cont.)

1991-1990	318/5.2L	
Seal	3103
Harmnc Balancer Slvs	88218
Repair Sleeve	KWK99218

CRANKSHAFT REAR SEAL

4 Cylinder

1995-1990	135/2.2L, 153/2.5L	
Seal Viton	710056
Seal PTFE H/D	5279

DODGE TRUCK - 1/2 TON - B150, B1500 VANS, D150 PICKUP, Ram 1500 PICKUP, Ram 1500 VAN, Ramcharger, W150 PICKUP

FRONT WHEEL

RWD

2008	RAM 1500 (Rr. Whl. ABS)	
Hub Unit Bearing (LH)	SP500101 ^{101 25}
Hub Unit Bearing (RH)	HA500100
2008-2007	RAM 1500 (4 Whl. ABS)	
Hub Unit Bearing	SP500101 ²⁵
2008-2006	Ram 1500 (Mega Cab)	
Hub Unit Bearing	SP550104[2] ²⁵
2007	RAM 1500 (Rr. Whl. ABS)(4.7L)	
Hub Unit Bearing	HA500100[2]
2007	RAM 1500 (Rr. Whl. ABS)(5.7L,3.7L)	
Hub Unit Bearing (LH)	SP500101 ^{101 25}
Hub Unit Bearing (RH)	HA500100
2006	RAM 1500 (4 Whl. ABS)(Exc. SRT)	
Hub Unit Bearing	SP500101[2] ²⁵
2006	RAM 1500 (Rr. Whl. ABS)(5.7L)	
Hub Unit Bearing (LH)	SP500101 ²⁵
Hub Unit Bearing (RH)	HA500100
2006	RAM 1500 (SRT)	
Hub Unit Bearing	SP500101[2] ²⁵
2006-2004	RAM 1500 (Rr. Whl. ABS)(4.7L,3.7L)	
Hub Unit Bearing	HA500100[2]

FRONT WHEEL (cont.)

RWD (cont.)

2005-2004	RAM 1500 (Rr. Whl. ABS)(5.7L)	
Hub Unit Bearing (LH)	SP500100 ^{101 40}
Hub Unit Bearing (RH)	HA500100
2005-2002	RAM 1500 Pickup (4 Whl. ABS)	
Hub Unit Bearing	SP500100[2] ⁴⁰
2003-2002	RAM 1500 Pickup (Rr. Whl. ABS)	
Hub Unit Bearing	HA500100[2]
2003-1999	RAM 1500 Van	
Seal (Inner)	3087[2]
Cone/Cup (Inner)	NP952605-JL69310P[2]
Set (Outer)	SET16[2]
2001-2000	RAM 1500 Pickup	
Hub Unit Bearing	HA590001[2]
Set (Opt. Tapered Unit Brg.)	SET815[2]
1999-1994	RAM 1500 Pickup	
Seal (Inner)	4739[2]
Set (Inner)	SET5[2]
Set (Outer)	SET3[2]

²⁵New Item, Check For Availability

⁴⁰5 Stud.

¹⁰¹Speed Sensor for Eng. Throttle Input

Mfg./Year Model & Location Part No. Mfg./Year Model & Location Part No.

DODGE TRUCK - 1/2 TON - B150, B1500 VANS, D150 PICKUP, Ram 1500 PICKUP, Ram 1500 VAN, Ramcharger, W150 PICKUP (cont.)**FRONT WHEEL (cont.)****RWD (cont.)**

1998-1994	B150, B1500	
Seal (Inner)	3087[2]
Cone/Cup (Inner)	NP952605-JL69310P[2]
Set (Outer)	SET16[2]
1993-1990	(5 Stud)	
Seal (Inner)	3087[2]
Set (Inner)	SET11[2]
Set (Outer)	SET16[2]
1993-1990	(8 Stud)	
Seal (Inner)	493291[2]
Set (Inner)	SET45[2]
Cone/Cup (Outer)	15101-15245[2]

4WD

2008	RAM 1500 (Rr. Whl. ABS)	
Hub Unit Bearing (LH)	SP500101 ^{101 25}
Hub Unit Bearing (RH)	HA500100
2008-2007	RAM 1500 Ser. (4 Whl. ABS)	
Hub Unit Bearing	SP500101[2] ²⁵
2008-2006	Ram 1500 (Mega Cab)	
Hub Unit Bearing	HA590166[2]
2007	RAM 1500 (Rr. Whl. ABS)(4.7L)	
Hub Unit Bearing	HA500100[2]
2007	RAM 1500 (Rr. Whl. ABS)(5.7L,3.7L)	
Hub Unit Bearing (LH)	SP500101 ^{101 25}
Hub Unit Bearing (RH)	HA500100
2006	RAM 1500 (Rr. Whl. ABS)(5.7L)	
Hub Unit Bearing (LH)	SP500101 ²⁵
Hub Unit Bearing (RH)	HA500100
2006-2004	RAM 1500 (Rr. Whl. ABS)(4.7L,3.7L)	
Hub Unit Bearing	HA500100[2]
2006-2002	RAM 1500 (4 Whl. ABS)	
Hub Unit Bearing	SP500100[2] ⁴⁰
2005-2004	RAM 1500 (Rr. Whl. ABS)(5.7L)	
Hub Unit Bearing (LH)	SP500100 ^{101 40}
Hub Unit Bearing (RH)	HA500100
2003-2002	RAM 1500 (Rr. Whl. ABS)	
Hub Unit Bearing	HA500100[2]
2001-2000	RAM 1500 Ser. (4 Whl. ABS)	
Hub Unit Bearing	SP550102[2] ⁴⁰
2001-2000	RAM 1500 Ser. (Rr. Whl. ABS)	
Hub Unit Bearing	HA599863[2]
1999-1997	RAM 1500 (4 Whl. ABS)	
Hub Unit Bearing (RH)	SP550100 ⁴⁰
Hub Unit Bearing (LH)	SP550101 ⁴⁰
Sensor Kit (RH)	SK550100 ³⁹
Sensor Kit (LH)	SK550101 ³⁹
1999-1994	RAM 1500 (Rr. Whl. ABS)	
Hub Unit Bearing	515006[2]
1993-1990	100/150 Ser. (Locking Hub)	
Seal (Inner)	4250[2]
Cone/Cup (Inner)	LM104949-JLM104910[2]
Set (Outer)	SET45[2]

REAR WHEEL**RWD**

2009-2007	Ram 1500 (Exc. H/D)	
Seal	SL260004[2] ²⁵
Cylindrical Bearing	6410[2]
2008-2006	(H/D Axle)	
Seal	710067[2]
Cylindrical Bearing	R1561TV[2]
2008-2006	Ram 1500 (Mega Cab)	
Cone/Cup (Inner)	28682-28622[2]
Set (Outer)	SET38[2]
2006-1990	Ram 1500 (Exc. H/D)	
Seal	8835S[2]
Cylindrical Bearing	6408[2]
Bearing & Seal Kit	TRP1559TV[2] ¹⁹
2002-1990	(H/D Axle)	
Seal	710067[2]
Cylindrical Bearing	R1561TV[2]
Bearing & Seal Kit	TF01561R[2] ¹⁹

4WD

2009-2007	Ram 1500 (Exc. H/D)	
Seal	SL260004 ²⁵
Cylindrical Bearing	6410[2]
2008-2006	(H/D Axle)	
Seal	710067[2]
Cylindrical Bearing	R1561TV[2]
2008-2006	Ram 1500 (Mega Cab)	
Cone/Cup (Inner)	28682-28622[2]
Set (Outer)	SET38[2]
2006-1990	Ram 1500 (Exc. H/D)	
Seal	8835S[2]
Cylindrical Bearing	6408[2]
Bearing & Seal Kit	TRP1559TV[2] ¹⁹
2002-1990	(H/D Axle)	
Seal	710067[2]
Cylindrical Bearing	R1561TV[2]
Bearing & Seal Kit	TF01561R[2] ¹⁹

4WD FRONT AXLE**Axle Shaft**

2008-2002	(C205F)	
Seal	710489 ²⁵
2001-1994	(Dana/Spicer 44-3F Axle)	
Seal (LH)	5131
Seal (RH)	710241
1998-1997	(Dana/Spicer 35IFS Axle)	
Seal	4857[2]
Cylindrical Bearing	5707[2]
1997-1990	(Dana/Spicer 44F-BJ Axle)	
Seal	5131[2]
Set	SET9[2]
Ndle Bearing (Pilot)	B228[2]
1996-1990	(7.25" R.G.)	
Seal	8660S[2]
Cylindrical Bearing	5707[2]
Ndle Bearing (Pilot)	B2516[2]

¹⁹Opt. Axle Rpr Brg. Replaces O.E. Brg & Seal
 Cable, Screw, Grease. ⁴⁰5 Stud. ¹⁰¹Speed Sensor for Eng. Throttle Input

²⁵New Item, Check For Availability

³⁹Opt. Kit =

Mfg./Year	Model & Location	Part No.	Mfg./Year	Model & Location	Part No.
DODGE TRUCK - 1/2 TON - B150, B1500 VANS, D150 PICKUP, Ram 1500 PICKUP, Ram 1500 VAN, Ramcharger, W150 PICKUP (cont.)					

4WD FRONT AXLE

Differential Rebuild Kit

2008-1994	(Dana/Spicer 44 Axle)	
Kit	DRK339C
1993-1990	(Dana/Spicer 44 Axle)	
Kit	DRK339B

Differential

2007-2000	(8" R.G.)	
Cone/Cup	LM102949-LM102911[2]
2001-1990	(Dana/Spicer 44 Axle)	
Cone/Cup	25590-25523[2]

Pinion

2008-2003	(8" R.G.)	
Seal	710476
Cone/Cup (Inner)	NP682887-NP307044
Cone/Cup (Outer)	NP270758-NP378971
Repair Sleeve	KWK99155
2008-2000	(Dana/Spicer M205 Axle)	
Seal Viton	714675
Cone/Cup (Inner)	NP722065-NP013743
Cone/Cup (Outer)	M88048-M88010
2008-1994	(Dana/Spicer 44 Axle)	
Seal	5778
Seal Viton (Opt)	5778V
Cone/Cup (Inner)	HM88649-HM88610
Cone/Cup (Outer)	02872-02820
Repair Sleeve	KWK99155
1993-1990	(Dana/Spicer 44 Axle)	
Seal	5778
Seal Viton (Opt)	5778V
Cone/Cup (Inner)	31594-31520
Cone/Cup (Outer)	02872-02820
Repair Sleeve	KWK99155

Spindle Kit

1993-1990	(Dana/Spicer 44 Axle)	
Bearing & Seal Kit	SBK1[2] ³³

Spindle

1993-1990	(Dana/Spicer 44 Axle)	
Seal (Inner)	722108[2]
Ndle Bearing (Inner)	B2110[2]
Seal (Outer)	722109[2]

Intermediate Shaft

1993-1990	(Spicer 44 Ser.)(Inter. shaft)	
Seal	710241[2]
Ndle Bearing	B5020[2]
Ndle Bearing (Pilot)	SCE108[2]

REAR AXLE

Differential Rebuild Kit

2008-2001	(9.25" R.G.)	
Kit	DRK304A ²⁵
2008-1990	(8.25", 8.375" R.G.)	
Kit	DRK303

REAR AXLE (cont.)

Differential Rebuild Kit (cont.)

2000-1990	(9.25" R.G.)	
Kit	DRK304
1998-1990	(7.25" R.G.)	
Kit	DRK302

Differential

2007-1990	(8.25", 8.375" R.G.)	
Set	SET36[2]
2007-1990	(9.25" R.G.)	
Cone/Cup	JLM704649-JLM704610[2]

Pinion

2008-2000	(9.25" R.G.)	
Seal	710481
Cone/Cup (Inner)	NP524102-NP912904
Cone/Cup (Outer)	M88048-M88010
Repair Sleeve	KWK99189
2003-2000	(8.25" R.G.)	
Seal	710480
Cone/Cup (Inner)	M802048-M802011
Cone/Cup (Outer)	M86649-M86610
1999-1997	(9.25" R.G.)	
Seal	5126
Cone/Cup (Inner)	NP524102-NP912904
Cone/Cup (Outer)	M88048-M88010
1999-1990	(8.25", 8.375" R.G.)	
Seal	8516N
Cone/Cup (Inner)	M802048-M802011
Cone/Cup (Outer)	M86649-M86610
1996-1990	(9.25" R.G.)	
Seal	5126
Cone/Cup (Inner)	M804048-M804010
Cone/Cup (Outer)	M88048-M88010
1993-1990	(10.5" R.G.)	
Seal Viton	719316

TRANSFER CASE REBUILD KIT

2003-1995	(New Process 241)	
Kit	TCRK241D ¹⁶
2003-1994	(New Process 231)	
Kit	TCRK231A ¹⁶
2003-1990	(New Process 205)	
Kit	TCRK205D
1994-1993	(New Process 241)	
Kit	TCRK241
1994-1990	(New Process 231)	
Kit	TCRK231 ⁵¹
1992-1990	(New Process 241)	
Kit	TCRK241A ¹⁶

TRANSFER CASE

Input Shaft

2007-2006	(New Process 246)	
Ball Bearing	110CB
Ndle Bearing (Rr)	B5020[2]
Ndle Bearing (Pilot)	FC66561

¹⁶Obsolete ²⁵New Item, Check For Availability
722109.

⁵¹BD50-8 I/S Brg.

³³Opt. Kit = Brg B2110, Seals 722108 &

Mfg./Year	Model & Location	Part No.	Mfg./Year	Model & Location	Part No.
-----------	------------------	----------	-----------	------------------	----------

DODGE TRUCK - 1/2 TON - B150, B1500 VANS, D150 PICKUP, Ram 1500 PICKUP, Ram 1500 VAN, Ramcharger, W150 PICKUP (cont.)

TRANSFER CASE (cont.)

Input Shaft (cont.)

2005-1994 (New Process 231, 241)	
Seal (O.E.)	3173
Ball Bearing	110L
Repair Sleeve	KWK99193
Ndle Bearing (Pilot)	FC66561
1993-1990 (New Process 241)	
Seal (O.E.)	3173
Ball Bearing	N5210KLB
Repair Sleeve	KWK99193
Ndle Bearing (Pilot)	SCH1810

Front Output Shaft

2007-2006 (New Process 243D)	
Ball Bearing (Frt)	111TB
2007-2006 (New Process 246)	
Ball Bearing	110CB
2005-2002 (New Process 241)	
Seal	3946
Repair Sleeve	KWK99187
Ball Bearing	207XLO
Ndle Bearing (Pilot)	J2416
2001-1994 (New Process 231)	
Seal	710046
Ball Bearing	206WB
Repair Sleeve	KWK99155
Ndle Bearing (Pilot)	J2416
1993-1990 (New Process 241)	
Seal	3946
Ball Bearing	207
Repair Sleeve	KWK99187
Ndle Bearing (Pilot)	J2416

Rear Output Shaft

2007-2006 (New Process 246)	
Seal	710496
Ndle Bearing (Rr)	B5020[2]
Ndle Bearing (Frt)	J2416
2005-2002 (New Process 241)	
Seal	4333N
Ball Bearing	207XLO
Repair Sleeve	KWK99187
2001-1994 (New Process 231)	
Seal	4333N
Ball Bearing	207
Ndle Bearing (Pilot)	B5020
1993-1990 (New Process 241)	
Seal	3946
Ball Bearing	207
Repair Sleeve	KWK99187
Ndle Bearing (Pilot)	B5020

Oil Pump Housing

2007-1990 (New Process)	
Seal	341022
Repair Sleeve	KWK99225

3-SPEED AUTOMATIC TRANSMISSION

Torque Converter

2003-1990 (A904, A998, A999, 31RH, 32RH, 36RH)	
Seal	331228H
Repair Sleeve	KWK99149
2000-1990 (A727, 36RH)	
Seal	331227H
Repair Sleeve	KWK99187

Rear Seal/Ext. Housing

2000-1990 (A727, 36RH)	
Seal	7300S
Ball Bearing	207XLO[2]
Seal Kit	5206 ⁶⁴
2000-1990 (A998, A999, 31RH, 32RH)	
Seal	2506
Ball Bearing	206LOE[2] ³⁸

Clutch Cam

1993-1990 (A727)	
Ndle Bearing	W585Q[12]

Selector Shaft Seal/Man. Shaft

2003-2001 (32RH, 36RH)	
Seal	8609
2000-1990	
Seal	8609

4-SPEED AUTOMATIC TRANSMISSION

Torque Converter

2002-1990 (A500, 42RH, 46RE)	
Seal	331228H
Repair Sleeve	KWK99149
2002-1990 (A518, 46RH)	
Seal	331227H
Repair Sleeve	KWK99187

Rear Seal/Ext. Housing

2002-1990 (2WD)	
Seal	7300S
Ball Bearing	207XLO[2]
Seal Kit	5206 ⁶⁴
2002-1990 (4WD)	
Seal	710058
Ball Bearing	207XLO[2]

Selector Shaft Seal/Man. Shaft

2003-1990	
Seal	8609

³⁸Reuse Snap Ring.

⁶⁴Seal & Bushing Kit

Mfg./Year	Model & Location	Part No.	Mfg./Year	Model & Location	Part No.
DODGE TRUCK - 1/2 TON - B150, B1500 VANS, D150 PICKUP, Ram 1500 PICKUP, Ram 1500 VAN, Ramcharger, W150 PICKUP (cont.)					

CLUTCH - 6 CYLINDER

Pilot Bearing

2001-1992	
Ndle Bearing	SCE1295
Ndle Bearing	FC69907
1991-1990	
Bushing H/D	PB286HD

CLUTCH - 8 CYLINDER

Pilot Bearing

2001-1992	
Ndle Bearing	SCE1295
Ndle Bearing	FC69907
1991-1990	
Bushing H/D	PB286HD

CLUTCH

Release Bearing

1998-1994 (4 Cyl.)	
Bearing Assy	614093
1998-1994 (8 Cyl.)	
Bearing Assy	614093
1998-1992 6 Cyl. (incl. Turbo Diesel)	
Bearing Assy	614093
1993-1992 (w/o Diesel)	
Bearing Assy	614093
1991-1990 100/150 Ser. (Hyd. Cl.)	
Bearing Assy	614054

4-SPEED MANUAL TRANSMISSION

Transmission Rebuild Kit

2002-1990 (New Process 435)	
Kit	TRK127G ⁵³
2000-1990 (New Process 435)	
Kit	TRK127B ⁵⁴

Input Shaft

1993-1990 (New Process 435)	
Seal	9376[2]
Ball Bearing	308L[2]
1990 (New Process A833)	
Seal	9376
Ball Bearing	308LOE[2]

Mainshaft Pilot

1993-1990 (New Process 435, 445)	
Ndle Bearing	Q15902[14]
1990 (New Process A833)	
Ndle Bearing	QBR23549[16]

4-SPEED MANUAL TRANSMISSION

Countershaft

1993-1990 (New Process 435, 436)	
Ndle Bearing (Frt)	BCE2416[2]
Ndle Bearing (Rr)	B3216[2]
Ndle Bearing Thrust	NTA2031[2]

Reverse Idler

1993-1990 (New Process 435, 436)	
Ndle Bearing	C407Q[2]

Rear Output Shaft

1993-1990 (New Process 435)	
Seal	8160S
Ball Bearing	308L[2]
1990 (New Process A833)	
Seal	7300S
Ball Bearing	308LOE[2]
Seal Kit	5206 ⁶⁴

5-SPEED MANUAL TRANSMISSION

Transmission Rebuild Kit

2003-1994 (New Venture 3500)	
Kit	TRK235C
2002-1992 (New Venture 4500)	
Kit	TRK4500D
1993-1990 (New Process A535)	
Kit	TRK535

Front Input Shaft

2003-1994 (New Process 3500)	
Seal	4529N
Ball Bearing	307FFLS[2]
Repair Sleeve	KWK99138
2003-1992 (New Process 4500)	
Seal	714655
Cone/Cup	M802048CP-M802011AP[2]
Repair Sleeve	KWK99133
1993-1992 (Aisin)	
Seal	223253
Repair Sleeve	KWK99128
1993-1990 (New Process A535, 2500)	
Seal	9376
Ball Bearing	307LI[2]
Repair Sleeve	KWK99106

Countershaft

2003-1994 (New Process 3500)	
Ndle Bearing	FC68336[2]
2003-1992 (New Process 4500)	
Cone/Cup (Frt)	LM102949CP-LM102910P[2]
Cone/Cup (Rr)	LM501349HP-LM501310P[2]
1993-1992 (Aisin AX15)	
Cylindrical Bearing (Frt)	MSN5305GTBV[2] ²⁵
1993-1990 (New Process A535, 2500)	
Cone/Cup (Frt)	LM67048-LM67010BCE[2]
Set (Rr)	SET2[2]

²⁵New Item, Check For Availability Kit

⁵³Ball I/S Brg.

⁵⁴Tapered I/S Brg.

⁶⁴Seal & Bushing

Mfg./Year	Model & Location	Part No.	Mfg./Year	Model & Location	Part No.
DODGE TRUCK - 1/2 TON - B150, B1500 VANS, D150 PICKUP, Ram 1500 PICKUP, Ram 1500 VAN, Ramcharger, W150 PICKUP (cont.)					

5-SPEED MANUAL TRANSMISSION**Mainshaft Pilot**

1993-1990 (New Process A535, 2500)	
Ndle Bearing	QBR23549[16]

Mainshaft 1st Speed Gear

1993-1990 (New Process A535, 2500)	
Ndle Bearing	FW455017[2]

Rear Output Shaft

2003-1994 (New Process 3500)(4WD)	
Seal	4532N
Ball Bearing	307FFTB[2]
2003-1994 (New Process 3500)(4WD)	
Seal	2465
Ball Bearing	307FFTB[2]
2003-1994 (New Process 4500)(2WD)	
Seal	2465
Cone/Cup	M804049-M804010[2]
2002-1992 (New Process 4500)(4WD)	
Seal	710058
Cone/Cup	M804049-M804010[2]
1993-1992 (Aisin)(2WD)	
Seal	710198
1993-1992 (Aisin)(4WD)	
Seal	1209N
1993-1992 (New Process 4500)(2WD)	
Seal	7300S
Cone/Cup	M804049-M804010[2]
1993-1990 (A535, NP2500)(2WD)	
Seal	2506
Ball Bearing	208[2]
1993-1990 (A535, NP2500)(4WD)	
Seal	710058
Ball Bearing	208[2]

Extension Housing

1993-1990 (New Process A535, 2500)	
Ball Bearing	1207L[2]

A/C COMPRESSOR

1993-1990 (Nippondenso)	
Ball Bearing	5000KFF[2]

DRIVESHAFT SUPPORT

2002-1994 (3.375" Threaded Bracket)	
Hanger Bearing Assy	HB88108D ²⁵
2001-1990 (1.378" 35mm Brg. I.D.)	
Ball Bearing	88107[2]
Hanger Bearing Assy	HB88107A[2]
Hanger Bearing Assy	HB88107B[2]

POWER STEERING**Pump Shaft**

1993-1990	
Seal	7013S

CAMSHAFT SEAL**4 Cylinder**

1995-1990 153/2.5L	
Seal	3655S
Repair Sleeve	KWK99139

CRANKSHAFT FRONT SEAL**6 Cylinder**

2008-2002 226/3.7L	
Seal	710472
2003-1992 239/3.9L	
Seal Viton	713103
Harmnc Balancer Slvs	88218
Repair Sleeve	KWK99218

8 Cylinder

2003-1992 318/5.2L, 360/5.9L	
Seal Viton	713103
Repair Sleeve	KWK99218
1991-1990 318/5.2L, 360/5.9L, 383/6.3L	
Seal	3103
Repair Sleeve	KWK99218

10 Cylinder

2006-2004 505/8.3L	
Seal Viton	471424V
Harmnc Balancer Slvs	88199
Repair Sleeve	KWK99199

CRANKSHAFT REAR SEAL**4 Cylinder**

2002-1996 150/2.5L	
Seal	3698

6 Cylinder

2006-2002 226/3.7L	
Seal	710471
2003-1990 239/3.9L	
Seal	5414

8 Cylinder

2006-2000 287/4.7L	
Seal	231004
2003-1990 360/5.9L	
Seal Split	5106
2003-1990 318/5.2L	
Seal	5414

²⁵New Item, Check For Availability

Mfg./Year	Model & Location	Part No.	Mfg./Year	Model & Location	Part No.
DODGE TRUCK - 3/4 TON - Pickup, Van, 250 Series, 2500 Series, Sprinter 2500					

FRONT WHEEL

RWD

2008-2006	Ram 2500 (4 Whl. ABS)	
	Hub Unit Bearing	SP550104[2] ²⁵
2007-2003	Sprinter 2500	
	Set (Inner)	SET45[2]
	Bearing Assy (Outer)	32305[2]
2005-2003	Ram 2500 (4 Whl. ABS)	
	Hub Unit Bearing	SP550103[2]
2003-1998	B2500 (4000 lb. Axle)(8 Stud)	
	Seal (Inner)	493291[2]
	Cone/Cup (Inner)	NP566582-NP980884[2]
	Cone/Cup (Outer)	NP244401-NP111741[2]
2003-1994	B2500 (3500 lb. Axle)	
	Seal (Inner)	3087[2]
	Cone/Cup (Inner)	NP952605-JL69310P[2]
	Set (Outer)	SET16[2]
2002-2000	Ram 2500 (4 Whl. ABS)	
	Hub Unit Bearing	HA590000[2]
	Set (Opt. Tapered Unit Brg.)	SET814[2]
1999-1994	R2500 (4000 lb. Axle)(8 Stud)	
	Seal (Inner)	4740[2]
	Set (Inner)	SET45[2]
	Cone/Cup	15101-15245[2]
1997-1994	B2500 (4000 lb. Axle)(8 Stud)	
	Seal (Inner)	493291[2]
	Set (Inner)	SET45[2]
	Cone/Cup (Outer)	15101-15245[2]
1993-1990	(3300 lb. Axle)(5 & 8 Stud)	
	Seal (Inner)	3087[2]
	Set (Inner)	SET11[2]
	Set (Outer)	SET16[2]
1993-1990	(3700 lb. Axle)(8 Stud)	
	Seal (Inner)	3087[2]
	Set (Inner)	SET45[2]
	Cone/Cup (Outer)	15101-15245[2]

4WD

2008-2006	Ram 2500 (4 Whl. ABS)	
	Hub Unit Bearing	HA590166[2]
2005-2003	Ram 2500 Pickup (SRW)(8 Stud)(ABS)	
	Hub Unit Bearing	HA590032[2]
2002-2000	Ram 2500 (4 Whl. ABS)	
	Hub Unit Bearing	HA590203[2]
2002-2000	Ram 2500 (Rr. Whl. ABS)	
	Hub Unit Bearing	HA590503[2] ²⁵
1999-1998	Ram 2500 (SRW)(4 Whl. ABS)	
	Hub Unit Bearing (RH)	SP580100 ⁹⁵
	Hub Unit Bearing (LH)	SP580101 ⁹⁵
	Sensor Kit (RH)	SK580100 ³⁹
	Sensor Kit (LH)	SK580101 ³⁹
1999-1994	Ram 2500 (7500 G.V.W.)(Exc. Rotor)	
	Hub Unit Bearing (Speed Sensor on CV)	HA597851[2]
1999-1994	Ram 2500 (H/D 8800 G.V.W.)(Exc. Rotor)	
	Hub Unit Bearing (Speed Sensor on CV)	HA590020[2]

FRONT WHEEL (cont.)

4WD (cont.)

1993-1990	(Dana/Spicer 44F-BJ Axle)	
	Seal (Inner)	4250[2]
	Cone/Cup (Inner)	LM104949-JLM104910[2]
	Set (Outer)	SET45[2]
1993-1990	(Dana/Spicer 60F Axle)	
	Seal (Inner)	415009[2]
	Cone/Cup (Inner)	387A-382A[2]
	Set (Outer)	SET38[2]

REAR WHEEL

RWD

2008-2003	Ram 2500	
	Cone/Cup (Inner)	28682-28622[2]
	Set (Outer)	SET38[2]
2007-2003	Sprinter 2500 (DRW)	
	Bearing Assy (Inner)	32011XM[2]
	Bearing Assy (Outer)	32210M[2]
	Seal (Inner)	710462[2]
2007-2003	Sprinter 2500 (SRW)	
	Bearing Assy	516010[2] ²⁵
2003-2002	B2500 (9.25" R.G.)(H/D Axle)	
	Seal	710067[2]
	Cylindrical Bearing	R1561TV[2]
	Bearing & Seal Kit	TF01561R[2] ¹⁹
2003-1995	B2500 (8.25" R.G.)(9.25" R.G.)(Exc. H/D Axle)	
	Seal	8835S[2]
	Cylindrical Bearing	6408[2]
	Bearing & Seal Kit	TRP1559TV[2] ¹⁹
2002-1994	R2500 (Spicer 60 Axle)(13x2.5" Brks.)	
	Seal (Inner)	417158[2]
	Cone/Cup (Inner)	28682-28622[2]
	Set (Outer)	SET38[2]
2002-1990	(9.25" R.G.)(H/D Axle)	
	Seal	710067[2]
	Cylindrical Bearing	R1561TV[2]
	Bearing & Seal Kit	TF01561R[2] ¹⁹
2002-1990	D200/250, W200/250 (9.25" R.G.)(Exc. H/D Axle)	
	Seal	8835S[2]
	Cylindrical Bearing	6408[2]
	Bearing & Seal Kit	TRP1559TV[2] ¹⁹
2001-1994	R2500 (Spicer 80)(13x3.5" Brks.)	
	Seal (Inner)	4250[2]
	Cone/Cup (Inner)	39585-39520[2]
	Cone/Cup (Outer)	JLM506849-JLM506810[2]
1994-1990	B200/250 (8.25", 8.375" R.G.)	
	Seal	8835S[2]
	Cylindrical Bearing	6408[2]
	Bearing & Seal Kit	TRP1559TV[2] ¹⁹
1993-1990	D250, W250 (Spicer 70)(12x3" Brks.)(9000 GVW)	
	Seal (Inner)	417158[2]
	Cone/Cup (Inner)	28682-28622[2]
	Set (Outer)	SET38[2]

¹⁹Opt. Axle Rpr Brg. Replaces O.E. Brg & Seal Cable, Screw, Grease. ⁹⁵8 Stud.

²⁵New Item, Check For Availability

³⁹Opt. Kit =

DODGE TRUCK - 3/4 TON - Pickup, Van, 250 Series, 2500 Series, Sprinter 2500 (cont.)**REAR WHEEL (cont.)****RWD (cont.)**

1993-1990	D200/250, W200/250 (Spicer 60H/D, 70, 71)(12x3" Brks.)(Exc. 9000 GVW)	
	Seal (Inner)	455086[2]
	Cone/Cup (Inner)	45291-45220[2]
	Set (Outer)	SET38[2]
1993-1990	D200/250, W200/250 (Spicer 60)(12x2.5" Brks.)	
	Seal (Inner)	4250[2]
	Set (Inner)	SET38[2]
	Set (Outer)	SET38[2]

4WD

2008-2003	Ram 2500	
	Cone/Cup (Inner)	28682-28622[2]
	Set (Outer)	SET38[2]
2007-2003	Sprinter 2500 (DRW)	
	Bearing Assy (Inner)	32011XM[2]
	Bearing Assy (Outer)	32210M[2]
	Seal (Inner)	710462[2]
2007-2003	Sprinter 2500 (SRW)	
	Bearing Assy	516010[2] ²⁵
2003-2002	B2500 (9.25" R.G.)(H/D Axle)	
	Seal	710067[2]
	Cylindrical Bearing	R1561TV[2]
	Bearing & Seal Kit	TF01561R[2] ¹⁹
2003-1995	B2500 (8.25" R.G.)(9.25" R.G.)(Exc. H/D Axle)	
	Seal	8835S[2]
	Cylindrical Bearing	6408[2]
	Bearing & Seal Kit	TRP1559TV[2] ¹⁹
2002-1994	R2500 (Spicer 60 Axle)(13x2.5" Brks.)	
	Seal (Inner)	417158[2]
	Cone/Cup (Inner)	28682-28622[2]
	Set (Outer)	SET38[2]
2002-1990	(9.25" R.G.)(H/D Axle)	
	Seal	710067[2]
	Cylindrical Bearing	R1561TV[2]
	Bearing & Seal Kit	TF01561R[2] ¹⁹
2002-1990	D200/250, W200/250 (9.25" R.G.)(Exc. H/D Axle)	
	Seal	8835S[2]
	Cylindrical Bearing	6408[2]
	Bearing & Seal Kit	TRP1559TV[2] ¹⁹
2001-1994	R2500 (Spicer 80)(13x3.5" Brks.)	
	Seal (Inner)	4250[2]
	Cone/Cup (Inner)	39585-39520[2]
	Cone/Cup (Outer)	JLM506849-JLM506810[2]
1994-1990	B200/250 (8.25", 8.375" R.G.)	
	Seal	8835S[2]
	Cylindrical Bearing	6408[2]
	Bearing & Seal Kit	TRP1559TV[2] ¹⁹

REAR WHEEL (cont.)**4WD (cont.)**

1993-1990	D250, W250 (Spicer 70)(12x3" Brks.)(9000 GVW)	
	Seal (Inner)	417158[2]
	Cone/Cup (Inner)	28682-28622[2]
	Set (Outer)	SET38[2]
1993-1990	D200/250, W200/250 (Spicer 60H/D, 70, 71)(12x3" Brks.)(Exc. 9000 GVW)	
	Seal (Inner)	455086[2]
	Cone/Cup (Inner)	45291-45220[2]
	Set (Outer)	SET38[2]
1993-1990	D200/250, W200/250 (Spicer 60)(12x2.5" Brks.)	
	Seal (Inner)	4250[2]
	Set (Inner)	SET38[2]
	Set (Outer)	SET38[2]

4WD FRONT AXLE**Axle Shaft**

1998-1994	(Dana/Spicer 44-3F Axle)	
	Seal (LH)	5131[2]
	Seal (RH)	710241[2]
1993-1990	(Dana/Spicer 44F-BJ Axle)	
	Seal	5131[2]
	Set	SET9[2]
	Ndle Bearing (Pilot)	B228[2]

Differential Rebuild Kit

2008-1994	(Dana/Spicer 44 Axle)	
	Kit	DRK339C
1999-1990	(Dana/Spicer 60F Axle)	
	Kit	DRK331
1993-1990	(Dana/Spicer 44-3CF, 44-3CFHD, 44F-BJ Axles)	
	Kit	DRK339B

Differential

2005-2003	(9.25" R.G.)	
	Set	SET42[2]
2002-1990	(Dana/Spicer 60F, 70F Axles)	
	Cone/Cup	387A-382S[2]
1997-1990	(Dana/Spicer 44-3CF, 44-3CFHD, 44F-BJ Axles)	
	Cone/Cup	25590-25523[2]

Pinion

2009-2003	(9.25" R.G.)	
	Seal	710558
	Cone/Cup (Inner)	HM804846-HM804810
	Cone/Cup (Outer)	HM88649-HM88610

¹⁹Opt. Axle Rpr Brg. Replaces O.E. Brg & Seal²⁵New Item, Check For Availability

DODGE TRUCK - 3/4 TON - Pickup, Van, 250 Series, 2500 Series, Sprinter 2500 (cont.)

4WD FRONT AXLE (cont.)

Pinion (cont.)

2002-1990	
Seal (Dana/Spicer 60)	9316
Seal Viton (Dana/Spice	
44 Axle)	5778V
Cone/Cup (Inner)	
(Dana/Spicer 60)	HM803146-HM803110
Cone/Cup (Outer)	
(Dana/Spicer 60)	HM88542-HM88510
Cone/Cup (Inner)	
(Dana/Spicer 44-3F	
Axle)	HM88649-HM88610
Cone/Cup (Inner)	
(Dana/Spicer 44F-BJ	
Axle)	31594-31520
Cone/Cup (Outer)	
(Dana/Spicer 44 Axle)	02872-02820

Spindle Kit

1997-1990 (Dana/Spicer 44F-BJ Axle)	
Bearing & Seal Kit	SBK1[2] ³³

Spindle

1998-1990 (Dana/Spicer 44F-BJ Axle)	
Seal (Inner)	722108[2]
Ndle Bearing (Inner)	B2110[2]
Seal (Outer)	722109[2]
1993-1990 (Dana/Spicer 60F Axle)	
Seal (Inner)	710044[2]
Ndle Bearing (Inner)	B2414[2]
Seal (Outer)	710045[2]

Steering Knuckle

1993-1990	
Seal (Upper)	710304[2]
Cone/Cup (Upper)	23100-23256[2]
Seal (Lower)	710385[2]
Cone/Cup (Lower)	23100-23256[2]

Intermediate Shaft

1993-1990 (Spicer 44FBJ)	
Seal	710241[2]
Ndle Bearing	B5020[2]
Ndle Bearing (Pilot)	SCE108[2]

REAR AXLE

Differential Rebuild Kit

2008-2001 (9.25" R.G.)	
Kit	DRK304A ²⁵
2008-1999 (8.25" R.G.)	
Kit	DRK303
2008-1994 (Dana/Spicer 60, 60HD Axles)	
Kit	DRK331A
2007-2003 (10.5" R.G.)	
Kit	DRK325B
2002-1994 (Dana/Spicer 80 Axle)	
Kit	DRK337

REAR AXLE (cont.)

Differential Rebuild Kit (cont.)

2002-1990 (Dana/Spicer 70U, 71 Axles)	
Kit	DRK332U
1998-1990 (8.25", 8.375" R.G.)	
Kit	DRK303
1998-1990 (9.25" R.G.)	
Kit	DRK304
1993-1990 (Dana/Spicer 60, 60HD Axles)	
Kit	DRK331

Differential

2005-2003 (10.5" R.G.)	
Cone/Cup	387AS-382A[2]
2005-2003 (11.5" R.G.)	
Cone/Cup	3984-3920[2]
2003-1990 (8.25", 8.375" R.G.)	
Set	SET36[2]
2003-1990 (9.25" R.G.)	
Cone/Cup	JLM704649-JLM704610[2]
2003-1990 (Dana/Spicer 60, 60HD, 70, 70U, 71 Axles)	
Cone/Cup	387A-382S[2]
2002-1994 (Dana/Spicer 80 Axle)	
Cone/Cup	469-453X[2]

Pinion

2009-2003	
Seal (10.5", 11.5" R.G.)	710508
Cone/Cup (Inner) (10.5" R.G.)	NP598002-NP284552
Cone/Cup (Inner) (11.5" R.G.)	HM807046-HM807010
Cone/Cup (Outer) (10.5", 11.5" R.G.)	NP457992-NP926068
2003-2000 (8.25" R.G.)	
Seal	710480
Cone/Cup (Inner)	M802048-M802011
Cone/Cup (Outer)	M86649-M86610
2003-2000 (9.25" R.G.)	
Seal	710481
Cone/Cup (Inner)	NP524102-NP912904
Cone/Cup (Outer)	M88048-M88010
2003-1990	
Seal (Dana/Spicer 60, 70 Series)	9316
Cone/Cup (Inner) (Dana/Spicer 60, 60HD)	HM803146-HM803110
Cone/Cup (Inner) (Dana/Spicer 70U, 71 Axles)	HM803149-HM803110
Cone/Cup (Outer) (Dana/Spicer 60, 60HD, 70U, 71 Axles)	HM88542-HM88510
2002-1994 (Dana/Spicer 80 Axle)	
Seal Viton	4525V
Cone/Cup (Inner)	HM807046-HM807010
Cone/Cup (Outer)	M802048-M802011

²⁵New Item, Check For Availability

³³Opt. Kit = Brg B2110, Seals 722108 & 722109.

Mfg./Year Model & Location Part No. Mfg./Year Model & Location Part No.

DODGE TRUCK - 3/4 TON - Pickup, Van, 250 Series, 2500 Series, Sprinter 2500 (cont.)**REAR AXLE (cont.)****Pinion (cont.)**

1999-1990 (8.25", 8.375" R.G.)	
Seal	8516N
Cone/Cup (Inner)	M802048-M802011
Cone/Cup (Outer)	M86649-M86610
1999-1990	
Seal (8.75", 9.25" R.G.)	5126
Cone/Cup (Inner) (8.75", 9.25" R.G.)	M804049-M804010
Cone/Cup (Outer) (8.75", 9.25" R.G.)	M88048-M88010

TRANSFER CASE REBUILD KIT

2002-1995 (New Process 241)	
Kit	TCRK241D ¹⁶
1997-1994 (New Process 231)	
Kit	TCRK231A ¹⁶
1994-1993 (New Process 241)	
Kit	TCRK241
1993-1990 (New Process 205)	
Kit	TCRK205D
1992-1990 (New Process 241)	
Kit	TCRK241A ¹⁶

TRANSFER CASE**Input Shaft**

2005-2003 (New Process 271, 273)	
Ball Bearing	211TB
2002-1993 (New Process 241)	
Seal (O.E.)	3173
Ball Bearing	110L
Seal (Opt)	710928
Repair Sleeve	KWK99193
Ndle Bearing (Pilot)	FC66561
1992-1990 (New Process 241)	
Seal (O.E.)	3173
Ball Bearing	N5210KLB[2]
Seal (Opt)	710928
Repair Sleeve	KWK99193
Ndle Bearing (Pilot)	SCH1810

Front Output Shaft

2005-2003 (New Process 271, 273)	
Ball Bearing	111TB
2002-1994 (New Process 241)	
Seal	3946
Ball Bearing	207XLO
Repair Sleeve	KWK99187
Ndle Bearing (Pilot)	J2416
1993-1990 (New Process 205)	
Seal	473313
Ball Bearing	307L
Repair Sleeve	KWK99174
Ndle Bearing (Pilot)	M28161
1993-1990 (New Process 241)	
Seal	3946
Ball Bearing	207
Repair Sleeve	KWK99187
Ndle Bearing (Pilot)	J2416

Rear Output Shaft

2002-1994 (New Process 241)	
Ball Bearing	207XLO
Repair Sleeve	KWK99187
Ndle Bearing (Pilot)	B5020
1993-1990 (New Process 241)	
Seal	3946
Ball Bearing	207
Repair Sleeve	KWK99187
Ndle Bearing (Pilot)	B5020
1993-1990 (New Process 205)	
Seal	473468
Ball Bearing	307L
Repair Sleeve	KWK99212
Ndle Bearing (Pilot)	B3216

Idler Shaft

1993-1990 (New Process 205)	
Cone/Cup	2793-2720[2]

Low Gear Roller

1993-1990 (New Process 208)	
Ndle Bearing	QBR23549[2]

Oil Pump Housing

2002-1990 (New Process 208, 241)	
Seal	341022
Repair Sleeve	KWK99225

Selector Shaft Seal/Man. Shaft

1993-1990 (New Process 205)	
Seal	2287[2]
Repair Sleeve	KWK99076[2]

3-SPEED AUTOMATIC TRANSMISSION**Torque Converter**

2000-1990 (A904, A998, A999, 31RH, 32RH)	
Seal	331228H
Repair Sleeve	KWK99149
2000-1990 (A727, 36RH)	
Seal	331227H
Repair Sleeve	KWK99187

Rear Seal/Ext. Housing

2000-1990 (A727, 36RH)	
Seal	7300S
Ball Bearing	207XLO[2]
Seal Kit	5206 ⁶⁴
2000-1990 (A998, A999, 31RH, 32RH)	
Seal	2506
Ball Bearing	206LOE[2] ³⁸

¹⁶Obsolete³⁸Reuse Snap Ring.⁶⁴Seal & Bushing Kit

Mfg./Year	Model & Location	Part No.	Mfg./Year	Model & Location	Part No.
DODGE TRUCK - 3/4 TON - Pickup, Van, 250 Series, 2500 Series, Sprinter 2500 (cont.)					

3-SPEED AUTOMATIC TRANSMISSION

Clutch Cam

1993-1990 (A727)
Ndle BearingW585Q[12]

Selector Shaft Seal/Man. Shaft

2000-1990
Seal8609

4-SPEED AUTOMATIC TRANSMISSION

Torque Converter

2002-1994 (46RH, 47RH)
Seal331227H
Repair SleeveKWK99187
2002-1990 (A500, 42RH, 46RE)
Seal331228H
Repair SleeveKWK99149
1993-1990 (A518)
Seal331227H
Repair SleeveKWK99187

Rear Seal/Ext. Housing

2002-1994 (42RH, 46RE, 46RH, 47RH)(2wd)
Seal7300S
Ball Bearing207XLO[2]
Seal Kit5206⁶⁴
2002-1994 (42RH, 46RE, 46RH, 47RH)(4WD)
Seal710058
Ball Bearing207XLO[2]
1993-1990 (A500, A518, 42RH)(2WD)
Seal7300S
Ball Bearing207XLO[2]
Seal Kit5206⁶⁴
1993-1990 (A500, A518, 42RH)(4WD)
Seal710058
Ball Bearing207XLO[2]

Selector Shaft Seal/Man. Shaft

2003-1990
Seal8609

CLUTCH

Pilot Bearing

2004-2000 3.7L, 3.9L, 5.2L, 5.7L, 5.9L, 8.3L (w/o Diesel)
Ndle BearingFC69907
2002-1990 359/5.9L (Diesel)
Ndle BearingSCE1211
1999-1994 5.2L, 5.9L (w/o Diesel)
Ball BearingS128
1998-1994 488/8.0L
Ndle BearingSCE1211
1996-1992 (8 Cyl.)
Ndle BearingSCE1295
1993-1992 239/3.9L
Ndle BearingSCE1295

CLUTCH (cont.)

Pilot Bearing (cont.)

1991-1990
Bushing H/DPB286HD

Release Bearing

2004-1990 (Cummins Turbo Diesel)(Getrag 5 Spd.)
Bearing Assy614070
2003-1992 (w/o Cummins Turbo Diesel, V10)
Bearing Assy614093
1998-1994 488/8.0L
Bearing Assy614114
1996-1994 (Cummins Turbo Diesel)(Getrag 5 Spd.)
Bearing Assy614114
1991-1990 (w/o Cummins Turbo Diesel)
Bearing Assy614054

4-SPEED MANUAL TRANSMISSION

Transmission Rebuild Kit

1993-1990 (New Process 435)
KitTRK127

Input Shaft

1993-1990 (New Process 435)
Seal9376[2]
Ball Bearing308L[2]
1990 (New Process A833)
Seal9376
Ball Bearing308LOE[2]

Mainshaft Pilot

1993-1990 (New Process 420, 435, 436, 445)
Ndle BearingQ15902[14]

Countershaft

1993-1990 (New Process 435)
Ndle Bearing (Frt)BCE2416[2]
Ndle Bearing (Rr)B3216[2]
Ndle Bearing ThrustNTA2031[2]

Reverse Idler

1993-1990 (New Process 435, 436)
Ndle BearingC407Q[2]

Rear Output Shaft

1993-1990 (New Process 435)
Seal8160S
Ball Bearing308L[2]
1990 (New Process A833)
Seal7300S
Ball Bearing308LOE[2]
Seal Kit5206⁶⁴

⁶⁴Seal & Bushing Kit

DODGE TRUCK - 3/4 TON - Pickup, Van, 250 Series, 2500 Series, Sprinter 2500 (cont.)**5-SPEED MANUAL TRANSMISSION****Transmission Rebuild Kit**

2004-1997	(New Venture 4500)	
Kit	TRK4500DNI
2000-1994	(New Process 3500)	
Kit	TRK235C
1996-1992	(New Venture 4500)	
Kit	TRK4500D

Front Input Shaft

2004-1992	(New Process 4500, 4500HD)	
Seal	714655
Cone/Cup	M802048CP-M802011AP[2]
Repair Sleeve	KWK99133
2000-1994	(New Process 3500)	
Seal	4529N
Ball Bearing	307FFLS[2]
Repair Sleeve	KWK99138
1993-1992	(Aisin)	
Seal	223253
Repair Sleeve	KWK99128
1993-1990	(New Process A535, 2500)	
Seal	9376
Ball Bearing	307LI[2]
Repair Sleeve	KWK99106

Countershaft

2004-1992	(New Process 4500)	
Cone/Cup (Frt)	LM102949CP-LM102910P[2]
Cone/Cup (Rr)	LM501349HP-LM501310P[2]
1993-1990	(New Process A535, 2500)	
Cone/Cup (Frt)	LM67048-LM67010BCE[2]
Set (Rr)	SET2[2]

Mainshaft Pilot

1993-1990	(New Process A535, 2500)	
Ndle Bearing	QBR23549[16]

Mainshaft 1st Speed Gear

1993-1990	(New Process A535, 2500)	
Ndle Bearing	FW455017[2]

Rear Output Shaft

2004-1994	(New Process 4500)(2WD)	
Seal	2465
Cone/Cup	M804049-M804010[2]
2003-1994	(New Process 4500HD)(2WD)	
Seal	4741
Cone/Cup	M804049-M804010[2]
2003-1992	(New Process 4500, 4500HD)(4WD)	
Seal	710058
Cone/Cup	M804049-M804010[2]
2000-1994	(New Process 3500)(4WD)	
Seal	4532N
Ball Bearing	307FFTB[2]
2000-1994	(New Process 3500)(4WD)	
Seal	2465
Ball Bearing	307FFTB[2]

5-SPEED MANUAL TRANSMISSION**(cont.)****Rear Output Shaft (cont.)**

1993-1992	(Aisin)(2WD)	
Seal	710198
1993-1992	(Aisin)(4WD)	
Seal	1209N
1993-1992	(New Process 4500)(2WD)	
Seal	7300S
Cone/Cup	M804049-M804010[2]
1993-1990	(New Process A536, 2500)(2WD)	
Seal	2506
Ball Bearing	208[2]
1993-1990	(New Process A536, 2500)(4WD)	
Seal	710058
Ball Bearing	208[2]

Extension Housing

1993-1990	(New Process 2500)	
Ball Bearing	1207L[2]
1993-1990	(New Process A535)	
Ball Bearing	207L[2]

DRIVESHAFT SUPPORT

2002-1994	(1.57" 40mm Brg. I.D.)	
Hanger Bearing Assy	HB88108D ²⁵
2002-1990	(Spicer 1280, 1310)(1.3780" Brg. I.D.)	
Ball Bearing	88107[2]
Hanger Bearing Assy	HB88107A[2]

CRANKSHAFT FRONT SEAL**6 Cylinder**

2007-1990	359/5.9L (Diesel)	
Seal	39803
Repair Sleeve	KWK99248
2001-1992	239/3.9L	
Seal Viton	713103
Repair Sleeve	KWK99218
Harmnc Balancer Slvs	88218
1991-1990	239/3.9L	
Seal	3103
Repair Sleeve	KWK99218
Harmnc Balancer Slvs	88218

8 Cylinder

2003-1992	318/5.2L, 360/5.9L	
Seal Viton	713103
Repair Sleeve	KWK99218
Harmnc Balancer Slvs	88218
1991-1990	318/5.2L, 360/5.9L, 383/6.3L	
Seal	3103
Repair Sleeve	KWK99218
Harmnc Balancer Slvs	88218

²⁵New Item, Check For Availability

Mfg./Year	Model & Location	Part No.	Mfg./Year	Model & Location	Part No.
DODGE TRUCK - 3/4 TON - Pickup, Van, 250 Series, 2500 Series, Sprinter 2500 (cont.)					

CRANKSHAFT FRONT SEAL

10 Cylinder

2003-1994	488/8.0L	
Seal Viton	471424V
Repair Sleeve	KWK99199
Harmnc Balancer Slvs	88199

CRANKSHAFT REAR SEAL

6 Cylinder

2008-1998	359/5.9L (Diesel)	
Seal	710473
2001-1990	239/3.9L	
Seal	5414
1993-1990	359/5.9L (Diesel)	
Seal	39805
Repair Sleeve	KWK99494

CRANKSHAFT REAR SEAL

8 Cylinder

2003-1990	360/5.9L	
Seal Split	5106
2003-1990	318/5.2L	
Seal	5414

DODGE TRUCK - 1 TON - Motor Home, Pickup, Van, 350 Series, 3500 Series, Sprinter 3500

FRONT WHEEL

RWD

2009-2006	RAM 3500	
Hub Unit Bearing	SP550104[2] ²⁵
2007-2003	Sprinter 3500	
Seal (Inner)	1989[2]
Set (Inner)	SET45[2]
Bearing Assy (Outer)	32305[2]
2005-2003	RAM 3500	
Hub Unit Bearing	SP550103[2]
2003-1998	B3500 (3600 lb. Axle)(8 Stud)	
Seal (Inner)	3087[2]
Set (Inner)	SET11[2]
Set (Outer)	SET16[2]
2003-1998	B3500 (4000 lb. Axle)(8 Stud)	
Seal (Inner)	493291[2]
Cone/Cup (Inner)	NP566582-NP980884[2]
Cone/Cup (Outer)	NP244401-NP111741[2]
2002-2000	RAM 3500	
Hub Unit Bearing	HA590000[2]
Set (Opt. Tapered Unit Brg.)	SET814[2]
1999-1994	RAM 3500 (Indp. Frt. Axle)	
Seal (Inner)	4740[2]
Set (Inner)	SET45[2]
Cone/Cup (Outer)	15101-15245[2]
1999-1994	RAM 3500 (Solid Frt. Axle)(DRW)(Non-ABS)	
Hub Unit Bearing	HA590018[2]
1997-1990	(4000 lb. Axle)(8 Stud)	
Seal (Inner)	493291[2]
Set (Inner)	SET45[2]
Cone/Cup (Outer)	15101-15245[2]
1997-1990	B Ser. (3600 lb. Axle)(8 Stud)	
Seal (Inner)	3087[2]
Set (Inner)	SET11[2]
Set (Outer)	SET16[2]

FRONT WHEEL (cont.)

RWD (cont.)

1993-1990	D350 (3300 lb. Axle)(5 Stud)	
Seal (Inner)	3087[2]
Set (Inner)	SET11[2]
Set (Outer)	SET16[2]

4WD

2009-2006	RAM 3500	
Hub Unit Bearing	HA590166[2]
2005-2003	RAM 3500	
Hub Unit Bearing	HA590032[2]
2002-2000	RAM 3500	
Hub Unit Bearing	HA590203[2]
1999-1998	RAM 3500 (DRW)(4 Whl. ABS)	
Hub Unit Bearing (LH)	SP580103
Hub Unit Bearing (RH)	SP580102
1999-1994	RAM 3500 (DRW)(Rr. Whl. ABS)	
Hub Unit Bearing	HA590018[2]
1993-1990	(Spicer 60F Axle)	
Seal (Inner)	415009[2]
Cone/Cup (Inner)	387A-382A[2]
Set (Outer)	SET38[2]
1990	(4000 lb. Axle)(8 Stud)	
Seal (Inner)	493291[2]
Set (Inner)	SET45[2]
Cone/Cup (Outer)	15101-15245[2]

REAR WHEEL

RWD

2008-2003	RAM 3500 (DRW)	
Seal (Inner)	710563[2]
Cone/Cup (Inner)	45291-45220[2]
Set (Outer)	SET38[2]

²⁵New Item, Check For Availability

DODGE TRUCK - 1 TON - Motor Home, Pickup, Van, 350 Series, 3500 Series, Sprinter 3500 (cont.)**REAR WHEEL (cont.)****RWD (cont.)**

2008-2003	RAM 3500 (SRW)	
	Cone/Cup (Inner)	28682-28622[2]
	Set (Outer)	SET38[2]
2007-2003	Sprinter 3500 (DRW)	
	Bearing Assy (Inner)	32011XM[2]
	Bearing Assy (Outer)	32210M[2]
	Seal (Inner)	710462[2]
2007-2003	Sprinter 3500 (SRW)	
	Bearing Assy	516010[2] ²⁵
2003-1995	B3500 (Dana/Spicer 60)(12"x2.5" Brks.)	
	Seal (Inner)	4250[2]
	Set	SET38[4]
2003-1995	B3500 (Dana/Spicer 60)(12"x3" Brks.)(9000 GVW)	
	Seal (Inner)	417158[2]
	Cone/Cup (Inner)	28682-28622[2]
	Set (Outer)	SET38[2]
2003-1990	B3500 (9.25" R.G.)(Exc. H/D Axle)	
	Seal	8835S[2]
	Cylindrical Bearing	6408[2]
	Bearing & Seal Kit	TRP1559TV[2] ¹⁹
2003-1990	B3500 (9.25" R.G.)(H/D Axle)	
	Seal	710067[2]
	Cylindrical Bearing	R1561TV[2]
	Bearing & Seal Kit	TF01561R[2] ¹⁹
2002-1995	RAM 3500	
	Seal (Inner)	455086[2]
	Cone/Cup (Inner)	45291-45220[2]
	Set (Outer)	SET38[2]
1994-1990	(Spicer 60 Axle)(12x2.5" Brks.)	
	Seal (Inner)	4250[2]
	Set	SET38[4]
1994-1990	(Spicer 60HD, 70 Axle)(12x3" Brks.)	
	Seal (Inner) (9000 lb. GVW)	417158[2]
	Cone/Cup (Inner) (9000 lb. GVW)	28682-28622[2]
	Seal (Inner) (Exc. 9000 lb. GVW)	455086[2]
	Cone/Cup (Inner) (Exc. 9000 lb. GVW)	45291-45220[2]
	Set (Outer)	SET38[2]

4WD

2008-2003	RAM 3500 (DRW)	
	Seal	710563[2]
	Cone/Cup (Inner)	45291-45220[2]
	Set (Outer)	SET38[2]
2008-2003	RAM 3500 (SRW)	
	Cone/Cup (Inner)	28682-28622[2]
	Set (Outer)	SET38[2]
2007-2003	Sprinter 3500 (DRW)	
	Bearing Assy (Inner)	32011XM[2]
	Bearing Assy (Outer)	32210M[2]
	Seal (Inner)	710462[2]
2007-2003	Sprinter 3500 (SRW)	
	Bearing Assy	516010[2] ²⁵

REAR WHEEL (cont.)**4WD (cont.)**

2003-1995	B3500 (Dana/Spicer 60)(12"x2.5" Brks.)	
	Seal (Inner)	4250[2]
	Set	SET38[4]
2003-1995	B3500 (Dana/Spicer 60)(12"x3" Brks.)(9000 GVW)	
	Seal (Inner)	417158[2]
	Cone/Cup (Inner)	28682-28622[2]
	Set (Outer)	SET38[2]
2003-1990	B3500 (9.25" R.G.)(Exc. H/D Axle)	
	Seal	8835S[2]
	Cylindrical Bearing	6408[2]
	Bearing & Seal Kit	TRP1559TV[2] ¹⁹
2003-1990	B3500 (9.25" R.G.)(H/D Axle)	
	Seal	710067[2]
	Cylindrical Bearing	R1561TV[2]
	Bearing & Seal Kit	TF01561R[2] ¹⁹
2002-1995	RAM 3500	
	Seal (Inner)	455086[2]
	Cone/Cup (Inner)	45291-45220[2]
	Set (Outer)	SET38[2]
1994-1990	(Spicer 60 Axle)(12x2.5" Brks.)	
	Seal (Inner)	4250[2]
	Set	SET38[4]
1994-1990	(Spicer 60HD, 70 Axle)(12x3" Brks.)	
	Seal (Inner) (9000 lb. GVW)	417158[2]
	Cone/Cup (Inner) (9000 lb. GVW)	28682-28622[2]
	Seal (Inner) (Exc. 9000 lb. GVW)	455086[2]
	Cone/Cup (Inner) (Exc. 9000 lb. GVW)	45291-45220[2]
	Set (Outer)	SET38[2]

4WD FRONT AXLE**Axle Shaft**

1993-1990	(Dana/Spicer 60F Axle)	
	Seal	470682[2]

Differential Rebuild Kit

2005-2002	(9.25" R.G.)	
	Kit	DRK324G
2002-1990	(Dana/Spicer 60 Axle)	
	Kit	DRK331
2002-1990	(Dana/Spicer 44 Axle)	
	Kit	DRK339B

Differential

2006-2003	(9.25" R.G.)	
	Set	SET42[2]
	Seal	450094[2]
	Repair Sleeve	KWK99193[2]
2002-1990	(Dana/Spicer 60F, 70F Axles)	
	Cone/Cup	387A-382S[2]

¹⁹Opt. Axle Rpr Brg. Replaces O.E. Brg & Seal²⁵New Item, Check For Availability

Mfg./Year	Model & Location	Part No.	Mfg./Year	Model & Location	Part No.
DODGE TRUCK - 1 TON - Motor Home, Pickup, Van, 350 Series, 3500 Series, Sprinter 3500 (cont.)					

4WD FRONT AXLE

Pinion

2009-2003 (9.25" R.G.)	
Seal	710558
Cone/Cup (Inner)	HM804846-HM804810
Cone/Cup (Outer)	HM88649-HM88610
2002-1990 (Dana/Spicer 60F Axle)	
Seal	9316
Cone/Cup (Inner)	HM803146-HM803110
Cone/Cup (Outer)	HM88542-HM88510

Spindle Kit

1993-1990 (Dana/Spicer 60F Axle)	
Bearing & Seal Kit	SBK3[2] ³⁵

Spindle

1993-1990 (Dana/Spicer 60F Axle)	
Seal (Inner)	710044[2]
Ndle Bearing (Inner)	B2414[2]
Seal (Outer)	710045[2]

REAR AXLE

Differential Rebuild Kit

2008-2001 (9.25" R.G.)	
Kit	DRK304A ²⁵
2002-1994 (Dana/Spicer 80 Axle)	
Kit	DRK337
2002-1990 (Dana/Spicer 60 Axle)	
Kit	DRK331
2000-1990 (9.25" R.G.)	
Kit	DRK304
1993-1990 (Dana/Spicer 70U, 71 Axles)	
Kit	DRK332U

Differential

2006-2003 (11.5" R.G.)	
Cone/Cup	3984-3920[2]
2003-1990 (9.25" R.G.)	
Cone/Cup	JLM704649-JLM704610[2]
2002-1994 (Dana/Spicer 80 Axle)	
Cone/Cup	469-453X[2]
2002-1990 (Dana/Spicer 60, 60HD, 70, 70U, 71 Axles)	
Cone/Cup	387A-382S[2]

Pinion

2009-2003 (11.5" R.G.)	
Seal	710508
Cone/Cup (Inner)	HM807046-HM807010
Cone/Cup (Outer)	NP457992-NP926068
2005-2003 (8.25" R.G.)	
Seal	710480
Cone/Cup (Inner)	M802048-M802011
Cone/Cup (Outer)	M86649-M86610
2003-2002 (Dana/Spicer 60 Axle)	
Seal	100712V
Cone/Cup (Inner)	HM803146-HM803110
Cone/Cup (Outer)	HM88542-HM88510

REAR AXLE (cont.)

Pinion (cont.)

2003-2000 (9.25" R.G.)	
Seal	710481
Cone/Cup (Inner)	NP524102-NP912904
Cone/Cup (Outer)	M88048-M88010
2002-1994 (Dana/Spicer 80 Axle)	
Seal Viton	4525V
Cone/Cup (Inner)	HM807046-HM807010
Cone/Cup (Outer)	M802048-M802011
Repair Sleeve	KWK99253
2001-1990 (Dana/Spicer 60, 60HD Axles)	
Seal Viton	719316
Cone/Cup (Inner)	HM803146-HM803110
Cone/Cup (Outer)	HM88542-HM88510
Repair Sleeve	KWK99187
1999-1990 (9.25" R.G.)	
Seal	5126
Cone/Cup (Inner)	M804049-M804010
Cone/Cup (Outer)	M88048-M88010
Repair Sleeve	KWK99187
1993-1990	
Seal (Dana/Spicer 70 Axle)(5380, 7270 Companion Yokes)	9316
Cone/Cup (Inner) (Dana/Spicer 70 Axle)	HM803149-HM803110
Cone/Cup (Inner) (5380, 7270 Companion Yokes)	HM807040-HM807010
Cone/Cup (Outer) (Dana/Spicer 70 Axle)(5380, 7270 Companion Yokes)	HM88542-HM88510

TRANSFER CASE REBUILD KIT

2002-1995 (New Process 241)	
Kit	TCRK241D ¹⁶
2002-1990 (New Process 205)	
Kit	TCRK205D
1994-1993 (New Process 241)	
Kit	TCRK241
1992-1990 (New Process 241)	
Kit	TCRK241A ¹⁶

TRANSFER CASE

Input Shaft

2005-2003 (New Process 271, 273)	
Ball Bearing	211TB
2002-1994 (New Process 241)	
Seal (O.E.)	3173
Ball Bearing	110L
Seal (Opt)	710928
Repair Sleeve	KWK99193
Ndle Bearing (Pilot)	FC66561

¹⁶Obsolete
710045

²⁵New Item, Check For Availability

³⁵Opt. Kit = Brg B2414, Seals 710044 &

Mfg./Year	Model & Location	Part No.	Mfg./Year	Model & Location	Part No.
DODGE TRUCK - 1 TON - Motor Home, Pickup, Van, 350 Series, 3500 Series, Sprinter 3500 (cont.)					

TRANSFER CASE (cont.)**Input Shaft (cont.)**

1993-1990 (New Process 205)	
Seal (M/T)	3173[2]
Seal (M/T, Opt)	710928
Repair Sleeve (M/T)	KWK99193
Ball Bearing (M/T)	1210L
Ndle Bearing (Pilot)	
(A/T,M/T)	QAR29523[15]
Seal (A/T)	473468[2]
Repair Sleeve (A/T)	KWK99212[2]
Ball Bearing (A/T)	1307L[2]

Front Output Shaft

2005-2003 (New Process 271, 273)	
Ball Bearing	111TB
2002-1994 (New Process 241)	
Seal	3946
1993-1990 (New Process 205)	
Seal	473468
Ball Bearing	307L
Repair Sleeve	KWK99174
Ndle Bearing (Pilot)	M28161

Rear Output Shaft

2002-1994 (New Process 241)	
Seal	4333N
Ball Bearing	207XLO
Ndle Bearing (Pilot)	B5020
1993-1990 (New Process 205)	
Seal	473468
Ball Bearing	307L
Repair Sleeve	KWK99212
Ndle Bearing (Pilot)	B3216

Idler Shaft

1993-1990 (New Process 205)	
Cone/Cup	2793-2720[2]

Low Gear Roller

1993-1990 (New Process 205)	
Ndle Bearing	QBR23549[2]

Oil Pump Housing

2002-1994 (New Process 241)	
Seal	341022
Repair Sleeve	KWK99225

Selector Shaft Seal/Man. Shaft

1993-1990 (New Process 205)	
Seal	2287[2]
Repair Sleeve	KWK99076

3-SPEED AUTOMATIC TRANSMISSION**Torque Converter**

2002-1990 (A727, 36RH)	
Seal	331227H
Repair Sleeve	KWK99187

3-SPEED AUTOMATIC TRANSMISSION (cont.)**Torque Converter (cont.)**

2000-1990 (A904, A998, A999, 31RH, 32RH)	
Seal	331228H
Repair Sleeve	KWK99149

Rear Seal/Ext. Housing

2002-1990 (A727, 36RH)	
Seal	7300S
Ball Bearing	207XLO[2]
Seal Kit	5206 ⁶⁴
2000-1990 (A998, A999, 31RH, 32RH)	
Seal	2506
Ball Bearing	206LOE[2] ³⁸

Clutch Cam

1993-1990 (A727)	
Ndle Bearing	W585Q[12]

Selector Shaft Seal/Man. Shaft

2000-1990	
Seal	8609

4-SPEED AUTOMATIC TRANSMISSION**Torque Converter**

2002-1990 (A500, 46RE)	
Seal	331228H
Repair Sleeve	KWK99149
2002-1990 (A518, 46RH, 47RH)	
Seal	331227H
Repair Sleeve	KWK99187

Rear Seal/Ext. Housing

2002-1990 (A500, A518, 46RE, 46RH, 47RH)(2 WD)	
Seal	7300S
Ball Bearing	207XLO[2]
Seal Kit	5206 ⁶⁴
2002-1990 (A500, A518, 46RE, 46RH, 47RH)(4 WD)	
Seal	710058
Ball Bearing	207XLO[2]

Selector Shaft Seal/Man. Shaft

2008-2004 (47RE, 48RE)	
Seal	8609
2003-1990 (A500, A518, 46RE, 46RH, 47RH)	
Seal	8609

³⁸Reuse Snap Ring.⁶⁴Seal & Bushing Kit

Mfg./Year	Model & Location	Part No.	Mfg./Year	Model & Location	Part No.
DODGE TRUCK - 1 TON - Motor Home, Pickup, Van, 350 Series, 3500 Series, Sprinter 3500 (cont.)					

CLUTCH

Pilot Bearing

2002-2000 (8 Cyl.)	
Ndle Bearing	FC69907
1997-1994 488/8.0L	
Ndle Bearing	SCE1211
1996-1992 (6 Cyl.)	
Ndle Bearing	SCE1295
1996-1992 (8 Cyl.)	
Ndle Bearing	SCE1295
1996-1990 (Cummins Turbo Diesel)	
Ndle Bearing	SCE1211
1991-1990	
Bushing H/D	PB286HD

Release Bearing

2002-1994 488/8.0L	
Bearing Assy	614114
2002-1994 5.9L (6 Cyl. Dsl.)	
Bearing Assy	614114
2002-1994 5.9L (V8 Gas)	
Bearing Assy	614093
1996-1994 (Cummins Turbo Diesel)(Getrag 5 Spd.)	
Bearing Assy	614114
1996-1992 (w/o Cummins Turbo Diesel and V10)	
Bearing Assy	614093
1993-1990 (Cummins Turbo Diesel)(Getrag 5 Spd.)	
Bearing Assy	614070
1991-1990 (w/o Cummins Turbo Diesel)	
Bearing Assy	614054

4-SPEED MANUAL TRANSMISSION

Transmission Rebuild Kit

1993-1990 (New Process 435)	
Kit (Ball Brg. I/S)	TRK127G ⁵³
1993-1990 (New Process 435)	
Kit (Tapered Brg. I/S)	TRK127B ⁵⁴

Input Shaft

1993-1990 (New Process 435)	
Seal	9376[2]
Ball Bearing	308L[2]
1990 (New Process A833)	
Seal	9376
Ball Bearing	308LOE[2]

Mainshaft Pilot

1993-1990 (New Process 420, 435, 445)	
Ndle Bearing	Q15902[14]

4-SPEED MANUAL TRANSMISSION

Countershaft

1993-1990 (New Process 435)	
Ndle Bearing (Frt)	BCE2416[2]
Ndle Bearing (Rr)	B3216[2]
Ndle Bearing Thrust	NTA2031[2]

Reverse Idler

1993-1990 (New Process 435)	
Ndle Bearing	C407Q[2]

Rear Output Shaft

1993-1990 (New Process 435)	
Seal	8160S
Ball Bearing	308L[2]

5-SPEED MANUAL TRANSMISSION

Transmission Rebuild Kit

2004-1997 (New Venture 4500)	
Kit	TRK4500DNI
2000-1994 (New Process 3500)	
Kit	TRK235C
1996-1990 (New Venture 4500)	
Kit	TRK4500DN
1991-1990 (Getrag G360)	
Kit	TRK261

Front Input Shaft

2004-1992 (New Process 4500)	
Seal	714655
Cone/Cup	M802048CP-M802011AP[2]
Repair Sleeve	KWK99133
2000-1994 (New Process 3500)	
Seal	4529N
Ball Bearing	307FFLS[2]
Repair Sleeve	KWK99138
1993-1992 (Aisin)	
Seal	223253
Repair Sleeve	KWK99128
1993-1990 (New Process A536, 2500)	
Seal	9376
Ball Bearing	307LI[2]
Repair Sleeve	KWK99106

Front Countershaft

2004-1992 (New Process 4500)	
Cone/Cup	LM102949CP-LM102910P[2]

Rear Countershaft

2004-1992 (New Process 4500)	
Cone/Cup	LM501349HP-LM501310P[2]

⁵³Ball I/S Brg.

⁵⁴Tapered I/S Brg.

Mfg./Year	Model & Location	Part No.	Mfg./Year	Model & Location	Part No.
-----------	------------------	----------	-----------	------------------	----------

DODGE TRUCK - 1 TON - Motor Home, Pickup, Van, 350 Series, 3500 Series, Sprinter 3500 (cont.)

5-SPEED MANUAL TRANSMISSION

Rear Output Shaft

2004-1994	(New Process 4500)(2WD)	
Seal	2465	
Cone/Cup	M804049-M804010[2]	
2004-1992	(New Process 4500)(4WD)	
Seal	710058	
Cone/Cup	M804049-M804010[2]	
2002-1994	(New Process 3500)(4WD)	
Seal	4532N	
Ball Bearing	307FFTB[2]	
2000-1994	(New Process 3500)(4WD)	
Seal	2465	
Ball Bearing	307FFTB[2]	
1993-1992	(Aisin)(2WD)	
Seal	710198	
1993-1992	(Aisin)(4WD)	
Seal	1209N	
1993-1992	(New Process 4500)(2WD)	
Seal	7300S	
Cone/Cup	M804049-M804010[2]	
1993-1990	(New Process A536, 2500)(2WD)	
Seal	2506	
Ball Bearing	208[2]	
1993-1990	(New Process A536, 2500)(4WD)	
Seal	710058	
Ball Bearing	208[2]	

DRIVESHAFT SUPPORT

2003-1994	(1.57" 40mm Brg. I.D. 3.248" centerline)	
Hanger Bearing Assy	HB88108D ²⁵	
2002-1999	(1.57" 40mm Brg. I.D. 2.284" centerline)	
Hanger Bearing Assy	HB88508AB	
1998-1990	(Spicer)(1.3780" Brg. I.D.)	
Ball Bearing	88107[2]	
Hanger Bearing Assy	HB88107A[2]	
Hanger Bearing Assy	HB88107B[2]	

CRANKSHAFT FRONT SEAL

6 Cylinder

2008-1994	359/5.9L (Diesel)	
Seal	39803	
Repair Sleeve	KWK99248	
1993-1990	359/5.9L (Diesel)	
Seal	39803	
Repair Sleeve	KWK99248	
1990	239/3.9L	
Seal	3103	
Harmnc Balancer Slvs	88218	

8 Cylinder

2003-1992	318/5.2L, 360/5.9L	
Seal Viton	713103	
Repair Sleeve	KWK99218	

CRANKSHAFT FRONT SEAL (cont.)

8 Cylinder (cont.)

1991-1990	318/5.2L, 360/5.9L, 383/6.3L	
Seal	3103	
Repair Sleeve	KWK99218	

10 Cylinder

2003-1994	488/8.0L	
Seal Viton	471424V	
Repair Sleeve	KWK99199	
Harmnc Balancer Slvs	88199	

CRANKSHAFT REAR SEAL

6 Cylinder

2008-1990	359/5.9L (Diesel)	
Seal	710473	
1990	239/3.9L	
Seal	5414	

8 Cylinder

2003-1990	360/5.9L	
Seal Split	5106	
2003-1990	318/5.2L	
Seal	5414	

²⁵New Item, Check For Availability

Mfg./Year Model & Location Part No. Mfg./Year Model & Location Part No.

DODGE TRUCK - 1-1/2, 2, 2-1/2 TON - RAM4500, RAM5500

FRONT WHEEL

RWD

2008 RAM4500, RAM5500
Hub Unit Bearing HA590273[2]²⁵

4WD

2008 RAM4500, RAM5500
Hub Unit Bearing HA590273[2]²⁵

EAGLE - Premier, Summit, Talon, Vision, Vista, 2000 GTX

FRONT WHEEL

FWD

1998-1995 Talon
Hub Unit Bearing 513157[2]
1997-1993 Vision
Hub Unit Bearing 513089[2]
1996-1993 Summit (Exc. Wagon)
Ball Bearing 510016[2]
Seal (Inner) 8430S[2]
Seal (Outer) 4898[2]
1996-1992 Summit Wagon
Seal (Inner) 225450[2]
Ball Bearing (Inner) 513036[2]
Seal (Outer) 225230[2]
1994-1990 Talon
Seal (Inner) 225450[2]
Ball Bearing (Inner) 513036[2]
Seal (Outer) 225230[2]
1993-1991 2000 GTX
Seal (Inner) 225450[2]
Ball Bearing (Inner) 513036[2]
Seal (Outer) 225230[2]
1992-1990 Summit
Seal 474134[2]
Set SET41[2]
1992-1990 Premier
Ball Bearing 513144K[2]
1992-1990 Vista
Seal (Inner) 225082[2]
Ball Bearing (Inner) 513036[2]
Seal (Outer) 225230[2]
1992-1990 Vista (Canada)
Seal 474134[2]
Set SET41[2]

4WD

1996-1993 Summit (Exc. Wagon)
Seal (Inner) 8430S[2]
Seal (Outer) 4898[2]
Ball Bearing 510016[2]
1996-1992 Summit Wagon
Seal (Inner) 225450[2]
Ball Bearing (Inner) 513036[2]
Seal (Outer) 225230[2]
1992 Summit (Exc. Wagon)
Seal 474134[2]
Set SET41[2]

FRONT WHEEL

AWD

1998-1995 Talon
Hub Unit Bearing 513157[2]
1994-1990 Talon
Seal (Inner) 225450[2]
Ball Bearing (Inner) 513036[2]
Seal (Outer) 225230[2]

REAR WHEEL

FWD

1998-1995 Talon
Hub Unit Bearing HA590306[2]
Bearing Module 512136[2]
1998-1993 Vision
Hub Unit Bearing 512029[2]
1996-1993 Summit (ABS)(Disc)
Hub Unit Bearing 512033[2]
1996-1993 Summit (Non-ABS)
Hub Unit Bearing 512148[2]
1996-1992 Summit Wagon (FWD)
Hub Unit Bearing 512040[2]
1994-1990 Talon (ABS)
Hub Unit Bearing 512011[2]⁸¹
1994-1990 Talon (Non-ABS)
Hub Unit Bearing 512010[2]
1993-1991 2000 GTX (Disc)
Hub Unit Bearing 512158[2]
1993-1991 2000 GTX (Drum)
Seal (Inner) 1196
Set (Inner) SET4[2]
Set (Outer) SET1[2]
1992-1991 Summit (Diamond Star Drum Brks.)
Hub Unit Bearing 512037[2]
1992-1991 Summit (Mitsubishi Drum Brks.)
Seal (Inner) 1205N[2]
Bearing Assy (Inner) 516001WB[2]
Bearing Assy (Outer) 516001WB[2]
1992-1990 Premier (Non-ABS)(Drum)
Hub Unit Bearing 513070[2]
1990 Summit (2 Dr.)(Disc)
Seal (Inner) 1205N[2]
Bearing Assy (Inner) 516000[2]
Bearing Assy (Outer) 516000[2]
1990 Summit (2 Dr.)(Drum)
Seal (Inner) 1205N[2]
Bearing Assy (Inner) 516001WB[2]
Bearing Assy (Outer) 516001WB[2]

²⁵New Item, Check For Availability

⁸¹Holes Exists For Tone Ring, Reuse Tone Ring.

Mfg./Year	Model & Location	Part No.	Mfg./Year	Model & Location	Part No.
EAGLE - Premier, Summit, Talon, Vision, Vista, 2000 GTX (cont.)					

REAR WHEEL (cont.)**FWD (cont.)**

1990	Summit (4 Dr.)	
	Seal (Inner)	1205N[2]
	Bearing Assy (Inner)	513029[2] ^z
	Bearing Assy (Outer)	513029[2] ^z

4WD

1996-1992	Summit Wagon	
	Ball Bearing	511013[2]

AWD

1998-1995	Talon	
	Bearing Module	512181[2]
1994-1990	Talon	
	Seal (Inner)	710152[2]
	Ball Bearing (Inner)	511014[2]
	Ball Bearing (Outer)	511015[2]

TRANSFER CASE**Front Output Shaft**

1998-1995	Talon	
	Seal	304505XX
	Set	SET6

CLUTCH**Release Bearing**

1998-1995	Talon (FWD)(w/o Turbo)	
	Bearing Assy	614121
1998-1991	Talon (AWD)	
	Bearing Assy	614099
1996-1993	Summit (AWD)	
	Bearing Assy	614099
1996-1990	Summit (FWD)	
	Bearing Assy	614126
1994-1990	Talon (FWD)	
	Bearing Assy	614126
1992-1990	Premier 3.0 V6	
	Bearing Assy	614092

3-SPEED AUTOMATIC TRANSAXLE**Differential**

1996-1990	(KM171, F3A21 2, KM171 5)	
	Ball Bearing	207[2]

Torque Converter

1996-1990	(F3A22, F3A21 3, KM171 5, KM171)	
	Seal	320583
	Repair Sleeve	KWK99157

Transfer Shaft

1996-1991	(F3A21 2)	
	Bearing Assy	30207M[2]
1990	(KM171, KM171 5)	
	Bearing Assy (Inner)	30206M[2]
	Bearing Assy (Outer)	30304[2]

3-SPEED AUTOMATIC TRANSAXLE**Transfer Gear**

1996-1990	(KM171, F3A21 2, KM171 5)	
	Ball Bearing (Inner)	207[2]
	Ball Bearing (Outer)	306L[2]

Transfer Idler

1996-1991	(F3A21 2)	
	Bearing Assy	30206M[2]

Output Shaft

1996-1990	(F3A22, F3A21 3, KM171 5, KM171)	
	Seal	223543[2]
	Repair Sleeve	KWK99139[2]

4-SPEED AUTOMATIC TRANSAXLE**Differential**

1998-1997	(A604 41TE)(AWD)(Prod. from mid 1997 on)	
	Cone/Cup (LH)	NP889967-NP714580
	Cone/Cup (RH)	NP952605-JL69310P
1998-1997	(A604 41TE)(Prod. from mid 1997 on)	
	Cone/Cup (LH)	NP889967-NP714580
	Cone/Cup (RH)	NP952605-JL69310P
1997	(A604 41TE)(AWD)(Prod. thru mid 1997)	
	Cone/Cup (LH)	NP889967-NP714580
	Cone/Cup (RH)	JL69348-JL69310
1997-1996	(A604 41TE)(Prod. thru mid 1997)	
	Cone/Cup (LH)	NP889967-NP714580
	Cone/Cup (RH)	JL69348-JL69310
1997-1993	(A606, 42LE)	
	Seal	3459S[2]
	Set	SET36
	Repair Sleeve	KWK99157[2]
1995-1994	(A604 41TE)(AWD)	
	Cone/Cup (LH)	JL69349-JL69310
	Cone/Cup (RH)	LM503349-LM503310
1995-1991	(A604 41TE)	
	Cone/Cup	JL69348-JL69310
1993-1991	(A604 41TE)(AWD)	
	Cone/Cup (LH)	JL69348-JL69310
	Cone (RH)	LM503349
1992-1990	(ZF 4 HP18)	
	Cone/Cup (LH)	LM806649-LM806610
	Cone/Cup (RH)	LM300849-LM300811
1991-1990	(A604, A670)	
	Set	SET11[2]

Torque Converter / Frt Pump

1998-1993	(41TE, 42LE)	
	Seal	331228H[2]
	Repair Sleeve	KWK99149
1998-1990	(F4A21 2, F4A22 2, F4A33 1, KM176 5, KM175 5, W4A32 1, W4A33 1)	
	Seal	320583
	Repair Sleeve	KWK99157

^zNon-Cancellable/Non-Returnable

EAGLE - Premier, Summit, Talon, Vision, Vista, 2000 GTX (cont.)

**4-SPEED AUTOMATIC TRANSAXLE
(cont.)**

Torque Converter / Frt Pump (cont.)

1992-1990 (ZF 4 HP18FL Premier)
Seal 224510
Repair Sleeve KWK99177

Transfer Shaft

1998-1996 (A604, 41TE)
Cone/Cup (Inner) NP853895-NP352518[2]
Set (Outer) SET45[2]
1998-1993 (A606, 42LE)
Cone/Cup (Outer) 26131H-26334[2]
Cone/Cup (Inner) M802048-M802011[2]
1995-1990 (A604, 41TE)
Cone/Cup (Inner) 13687-13623X[2]
Set (Outer) SET45[2]

Output Shaft

1998-1993 (F4A33 1)
Seal Viton 710259[2]
1998-1990 (W4A331)
Seal (LH) 223543
Repair Sleeve KWK99139
Seal (RH) 710199
Repair Sleeve KWK99139
1997-1993 (42LE)
Seal (LH) 4738N
Seal (RH) 4748N
1996-1990 (F4A21 2, F4A22 2)
Seal 223543[2]
Repair Sleeve KWK99139[2]
1992-1991 (F4A33 1)
Seal 223543[2]
1992-1990 (ZF 4 HP18FL Premier)
Seal (LH) 224462
Seal (RH) 710442

Pinion

1992-1990 (ZF 4 HP18FL Premier)
Seal Viton 710279
Repair Sleeve KWK99215

Extension Housing

1998-1990 (W4A32 1, W4A33 1)
Seal 710317
Repair Sleeve KWK99128

Manual Shaft

1998-1995 (41TE)
Seal 8609
1992-1990 (A604, A604 41TE, A670)
Seal 8609[2]

4-SPEED MANUAL TRANSAXLE

Differential

1992-1990 (F4M21 1)
Ball Bearing 207[2]

Input Shaft

1992-1990 (F4M21 1, KM200 0)
Seal Viton 712007[2]
Repair Sleeve KWK99098

Output Shaft

1992-1990 (F4M21 1, KM200 0)
Seal 223543[2]
Bearing Assy 30206M[2]
Repair Sleeve KWK99139[2]

Selector Shaft Seal/Man. Shaft

1992-1990 (F4M21 1, KM200 0)
Seal 710222[2]

5-SPEED MANUAL TRANSAXLE

Differential

1998-1995 (A578)
Seal 3459S[2]
Set SET11[2]
Repair Sleeve KWK99157[2]
1997-1990 (F5M21 1, F5M21 2, W5M31
2, W5M33 2, KM201 0,
KM215 0)
Ball Bearing 207[2]
1996-1990 (KM182 2, F5M22 2, KM182
0, KM206 0, KM206, KM221
1)
Bearing Assy 30207M[2]

Input Shaft

1997-1990 (KM206, F5M21 1, F5M21 1,
F5M21 2, F5M22 1, F5M22 2,
W5M31 2, W5M33 2, KM215
0)
Seal Viton 712007
Repair Sleeve KWK99098[2]
1991-1990 (KM182 2, KM182 0)
Seal Viton (Frt) 712007
Ball Bearing (Center) 304WB[2]
Bearing Assy (Rr) 30304[2]
Repair Sleeve KWK99098[2]
1990 (KM201 0, KM206 0)
Seal Viton (Frt) 712007[2]
Ball Bearing (Center) 304WB[2]
Ball Bearing (Rr) 108A[2]
Repair Sleeve KWK99098[2]

Countershaft

1990 (KM201 0, KM206 0)
Ball Bearing (Frt) RW122[2]
Ball Bearing (Rr) 108A[2]

Mfg./Year Model & Location Part No. Mfg./Year Model & Location Part No.

EAGLE - Premier, Summit, Talon, Vision, Vista, 2000 GTX (cont.)**5-SPEED MANUAL TRANSAXLE****Output Shaft**

1997-1993 (F5M33 2)	
Seal Viton	710259[2]
1997-1990 (W5M33 2)	
Seal (LH)	223543
Seal (RH)	710199
Repair Sleeve	KWK99139[2]
1996-1993 (F5M22 2)	
Seal	223543[2]
Repair Sleeve	KWK99139[2]
1996-1990 (F5M21 1, F5M21 2, F5M22 1, F5M22 2, KM201 0, KM206, KM206 0)	
Seal	223543[2]
Bearing Assy	30206M[2]
Repair Sleeve	KWK99139[2]
1993-1992 (W5M31 2)	
Seal (LH)	223543
Repair Sleeve (LH)	KWK99139
Seal (RH)	1981
Repair Sleeve (RH)	KWK99114
1992-1990 (F5M31 2, F5M33 1, KM215 0)	
Seal	223543[2]
Repair Sleeve	KWK99139[2]
1992-1990 (Renault UN1)	
Seal	224235[2]
1991-1990 (KM182 2, KM182 0)	
Seal	223543[2]
Repair Sleeve	KWK99139[2]

Pinion

1997-1990 (W5M33 2)	
Seal	223014
Repair Sleeve	KWK99114

Selector Shaft Seal/Man. Shaft

1998-1995 (A578)	
Seal	3816[2]
1996-1990 (F5M21 1, F5M21 2, F5M22 2, KM182 2, KM182 0, KM201 0, KM206 0)	
Seal	710222

Extension Housing

1993-1992 (W5M33 2)	
Seal	710317

OIL PUMP**4 Cylinder**

1998-1991 122/2.0L, 148/2.4L	
Seal	222025
Repair Sleeve	KWK99078
1994-1993 1755cc/1.8L (SOHC)	
Seal	221710
Repair Sleeve	KWK99068

CAMSHAFT SEAL**4 Cylinder**

1998-1995 122/2.0L (DOHC)	
Seal Viton	320249[2]
Repair Sleeve	KWK99139[2]
1998-1995 1997cc/2.0L (TURBO)	
Seal	3771
Repair Sleeve	KWK99139
1996-1990 1468cc/1.5L, 1755cc/1.8L, 1834cc/1.8L, 2351cc/2.4L	
Seal	3771
Repair Sleeve	KWK99139
1994-1990 1595cc/1.6L (DOHC), 1997cc/2.0L (DOHC)	
Seal	3771[2]
Repair Sleeve	KWK99139[2]

6 Cylinder

1997-1993 215/3.5L	
Seal	714655[2]
Repair Sleeve	KWK99112[2]

CRANKSHAFT FRONT SEAL**4 Cylinder**

1998-1994 122/2.0L (DOHC)	
Seal Viton	320348
Repair Sleeve	KWK99128
1996-1992 1834cc/1.8L	
Seal	223750
Repair Sleeve	KWK99145
1996-1990 1468cc/1.5L	
Seal	223018
Repair Sleeve	KWK99114
1996-1990 1595cc/1.6L (DOHC), 1597cc/1.6L, 1755cc/1.8L, 1997cc/2.0L, 2351cc/2.4L	
Seal	224460

6 Cylinder

1997-1993 201/3.3L	
Seal	3638
Repair Sleeve	KWK99112
1997-1993 3.5L	
Repair Sleeve	KWK99139
1992-1990 2970cc/3.0L	
Seal Viton	710196
Repair Sleeve	KWK99157

CRANKSHAFT REAR SEAL**4 Cylinder**

1998-1995 2.0L Turbo	
Seal Viton	710235
1998-1994 2.0L	
Seal Viton	710056
Seal PTFE H/D	5279
1998-1990 150/2.5L	
Seal	3698
Repair Sleeve	KWK99294
1996-1990 1468cc/1.5L, 1755cc/1.8L	
Seal	227235

Mfg./Year Model & Location Part No. Mfg./Year Model & Location Part No.

EAGLE - Premier, Summit, Talon, Vision, Vista, 2000 GTX (cont.)

CRANKSHAFT REAR SEAL (cont.)

4 Cylinder (cont.)

1996-1990 1595cc/1.6L (DOHC),
 1997cc/2.0L (DOHC),
 2351cc/2.4L
 Seal Viton 228005
 Repair Sleeve KWK99315

6 Cylinder

1997-1993 201/3.3L, 215/3.5L
 Seal Viton 710056
 Seal PTFE H/D 5279
 1992-1990 2970cc/3.0L
 Seal 228010
 Repair Sleeve KWK99315

FERRARI - F40, Testarossa, 328GT, 348

FRONT WHEEL

RWD

1995-1990 348
 Set (Inner) SET5[2]
 Set (Outer) SET16[2]
 1993-1990 Mondial
 Set (Inner) SET5[2]
 Set (Outer) SET16[2]
 1992-1990 F40
 Set (Inner) SET5[2]
 Set (Outer) SET16[2]
 1992-1990 Testarossa
 Set (Inner) SET5[2]
 Set (Outer) SET16[2]

REAR AXLE

Differential

1991-1990 (Exc. 412, GTO, Testarossa)
 Cone/Cup 368A-362A[2]
 1991-1990 GTO, Testarossa
 Cone/Cup (LH) 368A-362A
 Cone/Cup (RH) 28580-28521

Pinion

1991-1990 328 Ser.
 Cone/Cup (Outer) 28158-28300
 1991-1990 Testarossa
 Cone/Cup (Outer) 28158-28300

REAR AXLE (cont.)

Pinion (cont.)

1991-1990 412
 Cone/Cup (Outer) 27880-27820
 1991-1990
 Cone/Cup (Inner) M802048-M802011 ¹⁴

FORD - FRONT DRIVE - Contour

FRONT WHEEL

FWD

2000-1995
 Ball Bearing 510029[2]

REAR WHEEL

FWD

2000-1995
 Hub Unit Bearing 512024[2]

¹⁴Special Deviation Code On Some Models.

Mfg./Year	Model & Location	Part No.	Mfg./Year	Model & Location	Part No.
-----------	------------------	----------	-----------	------------------	----------

FORD - FRONT DRIVE - Contour (cont.)**CLUTCH****Release Bearing**

2000-1995
Bearing Assy 614155

4-SPEED AUTOMATIC TRANSAXLE**Differential**

2000-1995 (4HAT G)
Set SET17[2]
2000-1995 (AX4, AXOD)
Ball Bearing 208[2]
1997-1995 (4EAT G)
Bearing Assy 32008XM[2]

Torque Converter / Frt Pump

2000-1995 (CD4E)
Seal 4635V

Output Shaft

2000-1995 (4EAT G, 4HAT G)
Seal (LH) 223543
Repair Sleeve (LH) KWK99139
Seal (RH) 2007N
Repair Sleeve (RH) KWK99139
2000-1995 (AX4, AXOD)
Seal 3622S[2]
Repair Sleeve KWK99169[2]

5-SPEED MANUAL TRANSAXLE**Differential**

2000-1995 (MTX75)
Set SET17[2]

Input Shaft

2000-1995 (MTX75)
Seal 222430
Repair Sleeve KWK99098

Countershaft

2000-1995 (MTX75)
Bearing Assy (Frt) 32205[2]

Output Shaft

2000-1995 (MTX75)
Seal (LH) 223543
Repair Sleeve (LH) KWK99139
Seal (RH) 2007N
Repair Sleeve (RH) KWK99139

Selector Shaft Seal/Man. Shaft

2000-1995 (MTX75)
Seal 221620

CAMSHAFT SEAL**4 Cylinder**

2000-1995 121/2.0/L
Seal 3774S
Repair Sleeve KWK99169

6 Cylinder

2000-1995 155/2.5L
Seal 471651
Repair Sleeve KWK99106

CRANKSHAFT FRONT SEAL**4 Cylinder**

2000-1995 121/2.0/L
Seal 3771
Repair Sleeve KWK99139

6 Cylinder

2000-1995 2540cc/2.5L (DOHC)
Seal 482041N
Repair Sleeve KWK99187
Harmnc Balancer Slvs 88187

CRANKSHAFT REAR SEAL**4 Cylinder**

2000-1995 121/2.0/L
Seal 3772
Seal PTFE H/D (Opt) 5287

6 Cylinder

2000-1995 2540cc/2.5L (DOHC)
Seal Viton 3909
Seal PTFE H/D 5277
Repair Sleeve KWK99363

FORD - FRONT DRIVE - Escort

FRONT WHEEL

FWD

2003-1991	
Seal	1932S[2]
Ball Bearing	510013[2]
1990 (From 2/1/83)	
Set	SET39[2]
Hub Unit Bearing	518503[2] ⁶⁵

REAR WHEEL

FWD

2003-1994 (ABS)	
Hub Unit Bearing	512161[2]
2003-1990 (Non-ABS)(Drum)	
Hub Unit Bearing	513030[2]
1990	
Seal (Inner)	473677[2]
Set (Inner)	SET8[2]
Set (Outer)	SET12[2]

CLUTCH

Pilot Bearing

2003-1991 1.9L, 2.0L Pony, LX Model	
Ndle Bearing	FC65354
1996-1990 1.8 (DOHC) Mazda GT Model	
Ball Bearing	202SS

Release Bearing

2003-1997 2.0 (DOHC)(Mazda)	
Bearing Assy	614155
1997-1991 1.8 (DOHC) Mazda	
Bearing Assy	614079
1996-1991 116/1.9L	
Bearing Assy	614128
1990	
Bearing Assy	614060
Bearing Assy	614118

3-SPEED AUTOMATIC TRANSAXLE

Output Shaft

1993-1990	
Seal	3622S[2]
Repair Sleeve	KWK99169[2]

Manual Shaft

1990	
Seal	342517
Repair Sleeve	KWK99101

4-SPEED AUTOMATIC TRANSAXLE

Differential

2003-1991 (4EAT-F, F4E-II)	
Set	SET17[2]
1997-1990 (4EAT-F, ATX)	
Bearing Assy	32008XM[2]

4-SPEED AUTOMATIC TRANSAXLE

Torque Converter / Frt Pump

2002-1990 (4EAT-F, F4E-II)	
Seal	710446

Output Shaft

2002-1990 (4EAT-F, F4E-II)	
Seal (LH)	223543
Repair Sleeve	KWK99139
Seal (RH)	2007N
Repair Sleeve	KWK99139

4-SPEED MANUAL TRANSAXLE

Input Shaft

1990 (MTX II)(2nd Design)	
Seal	3638
Cone/Cup	LM67049A-LM67010[2]
Repair Sleeve	KWK99112[2]

Output Shaft

1990 (MTX)	
Seal	3622S[2]
Set	SET30[2] ^z
Repair Sleeve	KWK99169[2]

Selector Shaft Seal/Man. Shaft

1990 (MTX)	
Seal Viton	710274

5-SPEED MANUAL TRANSAXLE

Differential

2003-1997 (G5M)	
Bearing Assy	32008XM[2]
1996-1991 (G5M)	
Set	SET17[2]
1994-1990 (MTX)	
Set	SET45[2]

Input Shaft

2002-1991 (G5M)	
Seal	222430
Repair Sleeve	KWK99098
1995-1990 (MTX)	
Seal	3638
Cone/Cup	LM67049A-LM67010[2]
Repair Sleeve	KWK99112[2]

Countershaft

2002-1991 (G5M, MTX)	
Bearing Assy (Frt)	32205[2]
1995-1990 (G5M, MTX)	
Set	SET16[2]

^zNon-Cancellable/Non-Returnable

⁶⁵Kit = Nut, Studded Spindle, Bearing, Snap Ring

Mfg./Year Model & Location Part No. Mfg./Year Model & Location Part No.

FORD - FRONT DRIVE - Escort (cont.)

5-SPEED MANUAL TRANSAXLE

Output Shaft

2002-1991 (G5M, MTX)	
Seal (LH)	223543
Repair Sleeve (LH)	KWK99139
Seal (RH)	2007N
Repair Sleeve (RH)	KWK99139
1994-1990 (G5M, MTX)	
Seal	3622S[2]
Set	SET30[2] ^z
Repair Sleeve	KWK99169[2]

Selector Shaft Seal/Man. Shaft

2003-1991 (G5M)	
Seal	221620
1994-1990 (MTX III)	
Seal Viton	710274

DRIVESHAFT SUPPORT

1992-1990	
Ball Bearing	206F

CAMSHAFT SEAL

4 Cylinder

2003-1997 2.0L (SOHC)(DOHC)	
Seal	3774S
Repair Sleeve	KWK99169
1996-1991 113/1.8L (DOHC)	
Seal	223420
1996-1990 (1.6L, 1.9L)	
Seal	3774S
Repair Sleeve	KWK99169

CRANKSHAFT FRONT SEAL

4 Cylinder

2003-1997 (2.0L SOHC, 2.0L DOHC)	
Seal	3771
Repair Sleeve	KWK99139
1996-1991 113/1.8L (DOHC)	
Seal	710355
Repair Sleeve	KWK99145

CRANKSHAFT FRONT SEAL (cont.)

4 Cylinder (cont.)

1996-1990 (1.6L, 1.9L)	
Seal	3771
Repair Sleeve	KWK99139

CRANKSHAFT REAR SEAL

4 Cylinder

2003-1997 (2.0L SOHC, 2.0L DOHC)	
Seal	3772
Seal PTFE H/D	5287
1996-1991 113/1.8L (DOHC)	
Seal	228250
Repair Sleeve	KWK99328
1996-1990 (1.6L, 1.9L)	
Seal	3772
Seal PTFE H/D	5287

FORD - FRONT DRIVE - Freestyle

FRONT WHEEL

FWD

2007-2005	
Hub Unit Bearing	HA590028[2] ²⁵

REAR WHEEL

FWD

2007-2005	
Hub Unit Bearing	512299[2] ²⁵

CRANKSHAFT FRONT SEAL

6 Cylinder

2007-2005 3.0L	
Seal	482041N
Repair Sleeve	KWK99187

CRANKSHAFT REAR SEAL

6 Cylinder

2007-2005 3.0L	
Seal Viton	3909
Seal PTFE H/D (Opt)	5277
Repair Sleeve	KWK99362

^zNon-Cancellable/Non-Returnable

²⁵New Item, Check For Availability

Mfg./Year Model & Location Part No. Mfg./Year Model & Location Part No.

FORD - FRONT DRIVE - Focus

FRONT WHEEL

FWD

2009-2008
 Ball BearingWB000029[2]²⁵
 2007-2000
 Hub Unit BearingHA590263K[2]⁶⁹
 Ball Bearing (Opt) 510056[2]⁸⁰

REAR WHEEL

FWD

2009
 Taprd Bearing AssyWB000030[2]²⁵
 Seal SL260005[2]
 2008-2000
 Ball Bearing 516007[2]
 Seal 100944[2]²⁵

5-SPEED MANUAL TRANSAXLE

Differential

2004 (IB5)
 Seal 224020[2]
 Repair SleeveKWK99157
 2003-2000 (IB5)
 Cone/CupLM29749-LM29710[2]

CAMSHAFT SEAL

4 Cylinder

2004-2000 2.0L (SOHC)
 Seal3774S

CRANKSHAFT FRONT SEAL

4 Cylinder

2004-2000 2.0L (SOHC)(DOHC)
 Seal3771
 Repair SleeveKWK99139

CRANKSHAFT REAR SEAL

4 Cylinder

2004-2000 2.0L (SOHC)(DOHC)
 Seal3772

FORD - FRONT DRIVE - Fusion

FRONT WHEEL

FWD

2009-2006
 Ball Bearing510010[2]

4WD

2009-2006
 Ball Bearing510010[2]

REAR WHEEL

FWD

2009-2006 (Non-ABS)
 Hub Unit BearingHA590095[2]²⁵

4WD

2009-2007
 Ball Bearing510010[2]

5-SPEED AUTOMATIC TRANSAXLE

Output Shaft

2008-2006
 Seal2007N[2]
 Repair SleeveKWK99139

CRANKSHAFT FRONT SEAL

6 Cylinder

2009-2006 3.0L (DOHC)
 Seal482041N
 Repair SleeveKWK99187

CRANKSHAFT REAR SEAL

6 Cylinder

2009-2006 3.0L
 Seal Viton 3909
 Seal PTFE H/D (Opt) 5277
 Repair SleeveKWK99362

²⁵New Item, Check For Availability

⁶⁹Kit = Flg, Brg, Nut, & Snap Ring. Black Side Toward Sensor

⁸⁰Black Side Toward Sensor.

Mfg./Year	Model & Location	Part No.	Mfg./Year	Model & Location	Part No.
-----------	------------------	----------	-----------	------------------	----------

FORD - FRONT DRIVE - Probe**FRONT WHEEL****FWD**

1997-1993	
Seal	1932S[2]
Ball Bearing	510010[2]
1992-1990	
Seal	1932S[2]
Bearing Assy	513057[2]

REAR WHEEL**FWD**

1997-1993 (ABS)	
Hub Unit Bearing	512118[2]
1997-1993 (Non-ABS)	
Hub Unit Bearing	512119[2]
1992-1990	
Seal	224235[2]
Bearing Assy	513055[2]

CLUTCH**Pilot Bearing**

1993-1990	
Ball Bearing	202SS

Release Bearing

1997-1993 6 Cyl. 2.5 V6	
Bearing Assy	614060
Bearing Assy	614118
1997-1990 (2.0L DOHC, 2.2L Turbo, 3.0L)	
Bearing Assy	614079
1992-1990 4 Cyl. 2.2	
Bearing Assy	614067

4-SPEED AUTOMATIC TRANSAXLE**Differential**

1997-1990 (4EAT-G, 4EAT-GF, CD4E)	
Ball Bearing	208[2]

Torque Converter / Frt Pump

1997-1990 (4EAT-G, 4EAT-GF, CD4E)	
Seal	4189H

Output Shaft

1997-1990 (4EAT-G, 4EAT-GF)	
Seal (LH)	223543
Seal (RH)	2007N

5-SPEED MANUAL TRANSAXLE**Differential**

1997-1990 (MTX)	
Bearing Assy	32008XM[2]

5-SPEED MANUAL TRANSAXLE**Input Shaft**

1997-1990 (MTX)	
Seal (Outer)	1990
Set (Outer)	SET32[2]
Repair Sleeve	KWK99106

Output Shaft

1997-1990 (MTX)	
Seal (LH)	223543
Repair Sleeve (LH)	KWK99139
Seal (RH)	2007N
Repair Sleeve (RH)	KWK99139

Selector Shaft Seal/Man. Shaft

1997-1990 (MTX)	
Seal	221620

DRIVESHAFT SUPPORT

1992-1990	
Ball Bearing	206F

CAMSHAFT SEAL**4 Cylinder**

1997-1990 2.0L, 2.2L	
Seal	223420[2]

6 Cylinder

1997-1993 2497cc/2.5L	
Seal	223012[4]
Repair Sleeve	KWK99114[4]

CRANKSHAFT FRONT SEAL**4 Cylinder**

1997-1993 1991cc/2.0L	
Seal Viton	2012V
Repair Sleeve	KWK99134
1992-1990 133/2.2L (Gas)	
Seal	223420
Repair Sleeve	KWK99134

6 Cylinder

1997-1993 2497cc/2.5L	
Seal Viton	2012V
Repair Sleeve	KWK99166
1992-1990 183/3.0L	
Seal (Frt Entry)	2692
Seal (Rr Entry)	2942
Repair Sleeve	KWK99187
Harmnc Balancer Slvs	88187

CRANKSHAFT REAR SEAL**4 Cylinder**

1997-1993 1991cc/2.0L	
Seal	229004
Repair Sleeve	KWK99347
1992-1990 133/2.2L (Gas)	
Seal	229010
Repair Sleeve	KWK99354

Mfg./Year Model & Location Part No. Mfg./Year Model & Location Part No.

FORD - FRONT DRIVE - Probe (cont.)

CRANKSHAFT REAR SEAL

6 Cylinder

1997-1993 2497cc/2.5L	
Seal	1019S
Repair Sleeve	KWK99298
1992-1990 183/3.0L	
Seal	3772
Seal PTFE H/D (Opt)	5287

FORD - FRONT DRIVE - Taurus

FRONT WHEEL

FWD

2009-2008	
Hub Unit Bearing	HA590028[2] ²⁵
2007-1996	
Hub Unit Bearing	513100[2]
1995-1991 (From 2/1/91)	
Set	SET49[2]
Hub Unit Bearing	520100[2] ⁶⁵
1991-1990 (Thru 1/31/91)	
Set	SET49[2]
Hub Unit Bearing	520000[2] ⁶⁷

REAR WHEEL

FWD

2009-2008	
Hub Unit Bearing	512299[2] ²⁵
2007-2005 (ABS)(Disc)	
Hub Unit Bearing	HA590038[2] ²⁵
2007-2001 (ABS)(Drum)	
Hub Unit Bearing	512163[2]
2007-2001 (Non-ABS)(Drum)	
Hub Unit Bearing	512164[2]
2004-1993 (Disc)	
Hub Unit Bearing	512107[2]
2000 (ABS)(Drum)	
Hub Unit Bearing	512162[2]
2000-1990 (Non-ABS)(Drum)	
Hub Unit Bearing	512106[2]
1992-1990 (Disc)	
Hub Unit Bearing	512105[2] ¹⁶

CLUTCH

Pilot Bearing

1992-1990	
Ball Bearing	202SS

Release Bearing

1997-1996 3.4 8 Cyl. (SHO)	
Bearing Assy	614118
1996-1993 3.0 6 Cyl.	
Bearing Assy	614060
Bearing Assy	614118
1995-1990 3.0 DOHC 6 Cyl. (SHO)	
Bearing Assy	614060
Bearing Assy	614118

CLUTCH (cont.)

Release Bearing (cont.)

1992-1990 2.5 4 Cyl.	
Bearing Assy	614060
Bearing Assy	614118
1992-1990 3.0 6 Cyl.	
Bearing Assy	614079

3-SPEED AUTOMATIC TRANSAXLE

Differential

1994-1990 (ATX)	
Ball Bearing	208[2]

Torque Converter

1994-1990 (ATX)	
Seal	4539H
Repair Sleeve	KWK99235

Output Shaft

1994-1990 (ATX)	
Seal	3622S[2]
Repair Sleeve	KWK99169[2]

Manual Shaft

1994-1990 (ATX)	
Seal	342517
Repair Sleeve	KWK99101

4-SPEED AUTOMATIC TRANSAXLE

Differential

2002-1990 (AX4, AXOD)	
Ball Bearing	208[2]

Torque Converter / Frt Pump

2005-1990 (AX4, AXOD)	
Seal	4189H

Output Shaft

2007-1990	
Seal	3622S[2]
Repair Sleeve	KWK99169[2]

¹⁶Obsolete ²⁵New Item, Check For Availability

⁶⁵Kit = Nut, Studded Spindle, Bearing, Snap Ring

⁶⁷Kit = Flg, Brg, Nut, & Snap Ring

Mfg./Year	Model & Location	Part No.	Mfg./Year	Model & Location	Part No.
-----------	------------------	----------	-----------	------------------	----------

FORD - FRONT DRIVE - Taurus (cont.)**4-SPEED MANUAL TRANSAXLE****Input Shaft**

1990 (MTX II)	
Seal	3638
Cone/Cup	LM67049A-LM67010[2]
Repair Sleeve	KWK99112[2]

Output Shaft

1990 (MTX II)	
Seal	3622S[2]
Repair Sleeve	KWK99169[2]

Selector Shaft Seal/Man. Shaft

1990 (MTX II)	
Seal Viton	710274

5-SPEED MANUAL TRANSAXLE**Differential**

1995-1991 (Mazda F52)	
Set	SET17[2]
1995-1990 (MTX III)	
Set	SET45[2]

Input Shaft

1995-1991 (Mazda F52)	
Seal	222430
Repair Sleeve	KWK99098
1995-1990 (MTX III)	
Seal	3638
Cone/Cup	LM67049A-LM67010[2]
Repair Sleeve	KWK99112

Countershaft

1995-1991 (Mazda F52)	
Bearing Assy (Frt)	32205[2]
1995-1990 (MTX III)	
Set	SET16[2]

Output Shaft

1995-1991 (Mazda F52)	
Seal (LH)	223543
Repair Sleeve (LH)	KWK99139
Seal (RH)	2007N
Repair Sleeve (RH)	KWK99139
1995-1990 (MTX III)	
Seal	3622S[2]
Set	SET30[2] ^z
Repair Sleeve	KWK99169[2]

Selector Shaft Seal/Man. Shaft

1995-1990 (MTX III)	
Seal Viton	710274

DRIVESHAFT SUPPORT

1992-1990	
Ball Bearing	206F

CAMSHAFT SEAL**6 Cylinder**

2002-1990 182/3.0L (DOHC)	
Seal	1213N[4]
Repair Sleeve	KWK99157[4]
1995-1993 195/3.2L (DOHC)	
Repair Sleeve	KWK99157[4]
Seal	1213N[4]

8 Cylinder

2000-1996 206/3.4L (DOHC)	
Seal	710444[2]
Repair Sleeve	KWK99157[2]

CRANKSHAFT FRONT SEAL**4 Cylinder**

1991-1990 153/2.5L	
Seal	714075
Repair Sleeve	KWK99177

6 Cylinder

2009-2008 3498cc/3.5L (DOHC)	
Seal	482041N
Repair Sleeve	KWK99187
2007-1990 182/3.0L (OHV)	
Seal (Frt Entry)	2692
Seal (Rr Entry)	2942
Repair Sleeve	KWK99187
2005-1996 182/3.0L (DOHC), 206/3.4L (DOHC)	
Seal	482041N
Repair Sleeve	KWK99187
Harmnc Balancer Slvs	88187
1995-1993 195/3.2L (DOHC)	
Seal	710220
1995-1990 182/3.0L (DOHC)	
Seal	710220
1995-1990 232/3.8L	
Seal	2692

8 Cylinder

1999-1996 206/3.4L (DOHC)	
Seal	482041N
Repair Sleeve	KWK99187
Harmnc Balancer Slvs	88187

CRANKSHAFT REAR SEAL**4 Cylinder**

1991-1990 153/2.5L	
Seal	3772
Seal PTFE H/D (Opt)	5287

6 Cylinder

2007-1990 182/3.0L (OHV)	
Seal	3772
Seal PTFE H/D (Opt)	5287
2005-1996 182/3.0L (DOHC)	
Seal Viton	3909
Seal PTFE H/D (Opt)	5277
Repair Sleeve	KWK99362

^zNon-Cancellable/Non-Returnable

Mfg./Year Model & Location Part No. Mfg./Year Model & Location Part No.

FORD - FRONT DRIVE - Taurus (cont.)

CRANKSHAFT REAR SEAL (cont.)

6 Cylinder (cont.)

1995-1993 195/3.2L (DOHC)
 Seal 710219
 Repair Sleeve KWK99351
 1995-1990 182/3.0L (DOHC)
 Seal 710219
 Repair Sleeve KWK99351
 1995-1990 232/3.8L
 Seal Viton 3909
 Seal PTFE H/D (Opt) 5277
 Repair Sleeve KWK99363

CRANKSHAFT REAR SEAL

8 Cylinder

2000-1996 206/3.4L (DOHC)
 Seal 710219
 Repair Sleeve KWK99351

FORD - FRONT DRIVE - Tempo

FRONT WHEEL

FWD

1994-1990 (From 2/1/83)
 Set SET39[2]
 Hub Unit Bearing 518503[2]⁶⁵

REAR WHEEL

FWD

1994-1990
 Seal (Inner) 473677[2]
 Set (Inner) SET8[2]
 Set (Outer) SET12F[2]⁵⁹

DRIVESHAFT SUPPORT

1992-1990
 Ball Bearing 206F

FORD - AWD - Five Hundred

FRONT WHEEL

FWD

2007-2005
 Hub Unit Bearing HA590028[2]²⁵

AWD

2007-2005
 Hub Unit Bearing HA590028[2]²⁵

REAR WHEEL

FWD

2007-2005
 Hub Unit Bearing 512299[2]²⁵

AWD

2007-2005
 Hub Unit Bearing HA590029[2]²⁵

CRANKSHAFT FRONT SEAL

6 Cylinder

2007-2005 3.0L (DOHC)
 Seal 482041N

CRANKSHAFT REAR SEAL

6 Cylinder

2007-2005 183/3.0L
 Seal Viton 3909
 Repair Sleeve KWK99363

²⁵New Item, Check For Availability
 Snap Ring

⁵⁹O.E. Polymer Cage

⁶⁵Kit = Nut, Studded Spindle, Bearing,

Mfg./Year	Model & Location	Part No.	Mfg./Year	Model & Location	Part No.
-----------	------------------	----------	-----------	------------------	----------

FORD - AWD - Freestyle**FRONT WHEEL****AWD**

2007-2005

Hub Unit Bearing HA590028[2]²⁵**REAR WHEEL****AWD**

2007-2005

Hub Unit Bearing HA590029[2]²⁵**CRANKSHAFT FRONT SEAL****6 Cylinder**

2007-2005 3.0L

Seal 482041N

Repair Sleeve KWK99187

CRANKSHAFT REAR SEAL**6 Cylinder**

2007-2005 3.0L

Seal Viton 3909

Seal PTFE H/D (Opt) 5277

Repair Sleeve KWK99362

FORD - AWD - Taurus**FRONT WHEEL****AWD**

2009-2008

Hub Unit Bearing HA590028[2]²⁵**REAR WHEEL****AWD**

2009-2008

Hub Unit Bearing HA590029[2]²⁵**CRANKSHAFT FRONT SEAL****6 Cylinder**

2009-2008 3498cc/3.5L (DOHC)

Seal 482041N

Repair Sleeve KWK99187

FORD - AWD - Tempo**FRONT WHEEL****AWD**

1994-1990 (From 2/1/83)

Set SET39[2]

Hub Unit Bearing 518503[2]⁶⁵**REAR WHEEL****AWD**

1991-1990

Bearing Assy 513001[2]^Z**REAR AXLE****Axle Shaft**

1991-1990

Seal 3543[2]

Repair Sleeve KWK99139[2]

REAR AXLE**Pinion**

1991-1990 (4.75" R.G.)

Seal 472258

Repair Sleeve KWK99139

TRANSFER CASE**Input Shaft**

1991-1990 (I/S)

Set SET2

Ball Bearing (Pilot) 206WB

Front Output Shaft

1991-1990 (Frt. O/S)

Cone/Cup M86647-M86610[2]

Rear Output Shaft

1991-1990 (Rr. O/S)

Cone/Cup M86649-M86610

Ndle Bearing (Pilot) SCH78

^ZNon-Cancellable/Non-Returnable Spindle, Bearing, Snap Ring²⁵New Item, Check For Availability⁶⁵Kit = Nut, Studded

Mfg./Year Model & Location Part No. Mfg./Year Model & Location Part No.

FORD - AWD - Tempo (cont.)

CLUTCH

Release Bearing

1994-1992 3.0 V6 Mazda
 Bearing Assy 614079
 1990
 Bearing Assy 614060
 Bearing Assy 614118

5-SPEED MANUAL TRANSMISSION

Countershaft

1994-1990 (MTX III)
 Set SET16[2]

3-SPEED AUTOMATIC TRANSAXLE

Differential

1994-1990 (ATX)
 Ball Bearing 208[2]

Torque Converter

1994-1990 (ATX)
 Seal 4539H
 Repair Sleeve KWK99235

Output Shaft

1994-1990 (ATX)
 Seal 3622S[2]
 Repair Sleeve KWK99169[2]

Manual Shaft

1994-1990 (ATX)
 Seal 342517
 Repair Sleeve KWK99101

4-SPEED AUTOMATIC TRANSAXLE

Torque Converter / Frt Pump

1994-1990 (4EAT G, 4HAT G)
 Seal 710446
 1994-1990 (AX4, AXOD)
 Seal 4189H

Output Shaft

1994-1990 (4EAT G, 4HAT G)
 Seal (LH) 223543
 Repair Sleeve (LH) KWK99139
 Seal (RH) 2007N
 Repair Sleeve (RH) KWK99139
 1994-1990 (AX4, AXOD)
 Seal 3622S[2]
 Repair Sleeve KWK99169

4-SPEED MANUAL TRANSAXLE

Differential

1990 (MTX II)(2 pinion)
 Set SET45[2]
 1990 (MTX II)(4 pinion)
 Set SET37[2]

4-SPEED MANUAL TRANSAXLE

Input Shaft

1990 (MTX II)(2nd Design)
 Seal 3638
 Cone/Cup LM67049A-LM67010[2]
 Repair Sleeve KWK99112

Output Shaft

1990 (MTX)
 Seal (LH) 3622S[2]
 Set (LH) SET30[2]^z
 Repair Sleeve KWK99169[2]

Selector Shaft Seal/Man. Shaft

1990 (MTX)
 Seal Viton 710274

5-SPEED MANUAL TRANSAXLE

Differential

1994-1990 (MTX III)(RWB)(2 pinion)
 Set SET45[2]
 1994-1990 (MTX III)(RWB)(4 pinion)
 Set SET37[2]

Input Shaft

1994-1990 (MTX III)
 Seal 3638
 Cone/Cup LM67049A-LM67010[2]
 Repair Sleeve KWK99112

Output Shaft

1994-1990 (MTX III)
 Seal 3622S[2]
 Set SET30[2]^z
 Repair Sleeve KWK99169[2]

Selector Shaft Seal/Man. Shaft

1994-1990 (MTX III)
 Seal Viton 710274

CRANKSHAFT FRONT SEAL

4 Cylinder

1994-1990 140/2.3L
 Seal 714075
 Repair Sleeve KWK99177

6 Cylinder

1994-1992 183/3.0L
 Seal (Frt Entry) 2692
 Seal (Rr Entry) 2942
 Repair Sleeve KWK99187

CRANKSHAFT REAR SEAL

4 Cylinder

1994-1990 140/2.3L
 Seal 3772
 Seal PTFE H/D (Opt) 5287

^zNon-Cancellable/Non-Returnable

Mfg./Year	Model & Location	Part No.	Mfg./Year	Model & Location	Part No.
-----------	------------------	----------	-----------	------------------	----------

FORD - AWD - Tempo (cont.)**CRANKSHAFT REAR SEAL****6 Cylinder**

1994-1992	183/3.0L	
Seal		3772
Seal PTFE H/D (Opt)		5287

FORD - REAR DRIVE - Country Squire, Crown Victoria, LTD**FRONT WHEEL****RWD**

2009-2005	(From 2/23/05)	
Hub Unit Bearing		513230[2] ²⁵
2005-2003	(Thru 2/22/05)	
Hub Unit Bearing		513196[2]
2002-1997	(From 4/1/97)	
Hub Unit Bearing		513202[2]
1997-1992	(Thru 3/31/97)	
Hub Unit Bearing		513104[2]
1991-1990		
Seal (Inner)		6815[2]
Set (Inner)		SET11[2]
Set (Outer)		SET12[2]

REAR WHEEL**RWD**

2009-1990		
Seal		8660S[2]
Cylindrical Bearing		5707[2]
Bearing & Seal Kit		TRP1563TAV[2] ¹⁹

REAR AXLE**Differential Rebuild Kit**

2007-1990	(8.5", 8.8" R.G.)	
Kit		DRK311

Differential

2007-1990	(8.5", 8.8" R.G.)	
Set		SET36[2]

Pinion

2008-1990	(7.5", 8.5", 8.8" R.G.)	
Seal Viton		3604
Cone/Cup (Inner)		M802048-M802011
Cone/Cup (Outer)		M88048-M88010

4-SPEED AUTOMATIC TRANSMISSION**Torque Converter**

2005-1992	(AODE, AODEW, 4R70W)	
Seal		710447
Repair Sleeve		KWK99199
1993-1990	(AOT, AOD)	
Seal		331107N
Repair Sleeve		KWK99199

4-SPEED AUTOMATIC TRANSMISSION**Rear Seal/Ext. Housing**

2002-1995	(AODE)	
Seal		4764
1994-1990	(AOT, AOD, AODE)	
Seal		7692S
Seal Kit		5202 ⁶⁴

Selector Shaft Seal/Man. Shaft

2007-1994	(AODE, AODEW, 4R70W)	
Seal		7929S
2005-1990		
Seal		240816
Repair Sleeve		KWK99138

A/C COMPRESSOR

2002-1991	(Nippondenso FX 15)(Axial)	
Ball Bearing		5106WCC[2]
1996-1990	(Nippondenso 6E171)(Axial)	
Ball Bearing		5000KFF[2]
1990	(Ford FS6)(Axial)	
Ball Bearing		5000KFF[2]
1990	(Frigidaire A6)(Axial)	
Ball Bearing		907257[2]

ALTERNATOR

1991-1990	(Motorcraft)	
Ball Bearing (Rear End)		MNJ471S
1991-1990	(Motorcraft)	
Ball Bearing (Drive End)		203FF

POWER STEERING**Input Shaft**

1994-1990		
Seal		471645
Ndle Bearing		FC65753[2]

Pump Shaft

2001-1990		
Seal		8773S

Worm Shaft

2001-1990		
Ball Bearing		201CC[2]

¹⁹Opt. Axle Rpr Brg. Replaces O.E. Brg & Seal Bushing Kit²⁵New Item, Check For Availability⁶⁴Seal &

Mfg./Year Model & Location Part No. Mfg./Year Model & Location Part No.

FORD - REAR DRIVE - Country Squire, Crown Victoria, LTD (cont.)

CRANKSHAFT FRONT SEAL

8 Cylinder

2008-1992	281/4.6L	
Seal	482041N
Repair Sleeve	KWK99187
Harmnc Balancer Slvs	88187
1991-1990	(w/o 281/4.6, 292/4.8)	
Seal (Frt Entry)	2692
Seal (Rr Entry)	2942
Repair Sleeve	KWK99187
Harmnc Balancer Slvs	88187

CRANKSHAFT REAR SEAL

8 Cylinder

2008-1990	281/4.6L, 302/5.0L	
Seal Viton	3909
Seal PTFE H/D	5277
Repair Sleeve	KWK99362

CRANKSHAFT REAR SEAL (cont.)

8 Cylinder (cont.)

1991-1990	351/5.8L (W)	
Seal Viton	2377
Seal PTFE H/D	5278
Repair Sleeve	KWK99372

FORD - REAR DRIVE - Mustang; incl. Boss, Cobra, GT, Mach I, McLaren, Saleen, Shelby, SVO, SVT, Shelby GT500

FRONT WHEEL

RWD

2009-2005	(ABS)	
Hub Unit Bearing	HA590017[2] ²⁵
2009-2005	(Non-ABS)	
Hub Unit Bearing	HA590026[2] ²⁵
2004-1994	(ABS, Non-ABS)	
Hub Unit Bearing	513115[2]
1993-1990	(5.0L)	
Seal (Inner)	9150S[2]
Set (Inner)	SET5[2]
Set (Outer)	SET12F[2] ⁵⁹
1993-1990	(2.3L, 3.8L)(Exc. Turbo)	
Seal (Inner)	6815[2]
Set (Inner)	SET17[2]
Set (Outer)	SET12[2]

REAR WHEEL

RWD

2009-2005		
Seal	8835S[2]
Cylindrical Bearing	6408[2]
Bearing & Seal Kit	TRP1559TV[2] ¹⁹
2004-1999	(Indep. Rr. Susp.)	
Set	SET49[2]
2004-1990	(Exc. Indep. Rr. Susp.)	
Seal	8660S[2]
Cylindrical Bearing	5707[2]
Bearing & Seal Kit	TRP1563TAV[2] ¹⁹

CLUTCH RELEASE

Diaphragm Clutches

2002-1990	(8 Cyl.)	
Bearing Assy	614014
1996-1990	(6 Cyl.)	
Bearing Assy	614014

CLUTCH RELEASE (cont.)

Diaphragm Clutches (cont.)

1992-1990	4 Cyl. (5 Spd.)	
Bearing Assy	614014

REAR AXLE

Axle Shaft

2008-2001	(7.5" R.G.)	
Seal Viton	714569[2]
Repair Sleeve	KWK99157[2]
2008-1999	(8.8" R.G.)(Indep. Rr. Susp.)	
Ndle Bearing	FC66998[2]
Seal	100537[2]

Differential Rebuild Kit

2007-1990	(7.5" R.G.)	
Kit	DRK315
2006-1990	(8.8" R.G.)	
Kit	DRK311

Differential

2006-1990	(8.8" R.G.)	
Set	SET36[2]
2006-1990	(7.5" R.G.)(6.75" R.G.)	
Cone/Cup	LM501349-LM501314[2]

Pinion

2009-2007	Shelby GT500	
Seal Viton	3604
Cone/Cup (Inner)	NP159221-NP254157
Cone/Cup (Outer)	M88048-M88010

¹⁹Opt. Axle Rpr Brg. Replaces O.E. Brg & Seal Polymer Cage

²⁵New Item, Check For Availability

⁵⁹O.E.

FORD - REAR DRIVE - Mustang; incl. Boss, Cobra, GT, Mach I, McLaren, Saleen, Shelby, SVO, SVT, Shelby GT500 (cont.)**REAR AXLE (cont.)****Pinion (cont.)**

2008-1990 (7.5" R.G.)	
Seal Viton	3604
Cone/Cup (Inner)	M802048-M802011
Cone/Cup (Outer)	M88048-M88010
2008-1990 (8.8" R.G.)	
Seal Viton	3604
Cone/Cup (Inner)	M802048-M802011
Cone/Cup (Outer)	M88048-M88010

4-SPEED AUTOMATIC TRANSMISSION**Torque Converter**

2004-1994 (AODEW, 4R70W, 4R75W)	
Seal	710447
Repair Sleeve	KWK99199
2002-1992 (AODE)	
Seal	3404
1997-1990 (A4LD, C3)	
Seal	4143
1993-1990 (AOT, AOD)	
Seal	331107N[2]
Repair Sleeve	KWK99199

Rear Seal/Ext. Housing

2003-1995 (AODE W)	
Seal	4764[2]
2003-1992 (AOD Booted)(AODE)	
Seal	7692S[2]
Seal Kit	5202 ⁶⁴
1997-1990 (A4LD, C3)	
Seal	2655
Repair Sleeve	KWK99138
1991-1990 (AOT, AOD)(long boot)	
Seal	7692S[2]
Seal Kit	5202 ⁶⁴

Selector Shaft Seal/Man. Shaft

2008-1990	
Seal	7929S[2]

CLUTCH**Pilot Bearing**

2002-1996 8 Cyl. 281 (4.6)(SOHC and DOHC)	
Ndle Bearing	FC68329
1995-1990 8 Cyl. 302 (5.0 L)(Prod. from 5/1974 on)	
Ndle Bearing	FC65174
1995-1990 8 Cyl. 351	
Ndle Bearing	FC65662
1993-1990 4 Cyl. 140 (2.3 L)(normally aspirated and Turbo)	
Ndle Bearing	FC65354

CLUTCH**Release Bearing**

2004-1998	
Bearing Assy	614014

5-SPEED MANUAL TRANSMISSION**Front Input Shaft**

2002-1996 (Warner T45)	
Seal	7412S
Cone/Cup	M88048-M88010[2]
Repair Sleeve	KWK99125
2002-1994 (Warner T5 World Class)	
Seal	7412S
Set	SET5[2]
Repair Sleeve	KWK99125
Ndle Bearing	FA55505[2]
1996-1990 (Tremec 3550)	
Seal	3638
Cone/Cup	355-354A[2]
Repair Sleeve	KWK99112
1993-1990 (Warner T5 World Class)(L4)	
Seal	7412S
Cone/Cup	M88048-M88010[2]
Repair Sleeve	KWK99125
Ndle Bearing	FA55505[2]
1993-1990 (Warner T5 World Class)(V6) (V8)	
Seal	7412S
Set	SET5[2]
Repair Sleeve	KWK99125
Ndle Bearing	FA55505[2]

Countershaft

2004-1990 (Warner T5 World Class)	
Cone/Cup (Frnt)	LM67048-LM67010BCE[2]
Set (Rr)	SET6[2]
Ndle Bearing Thrust	NTA1423[2]
2002-1996 (Warner T45)	
Set (Frnt)	SET6[2]
Set (Rr)	SET6[2]
1996-1990 (Tremec 3550)	
Cone/Cup (Frnt)	1380-1328[2]
Cone/Cup (Rr)	1380-1328[2]

Mainshaft Pilot

2002-1996 (Warner T45)	
Set	SET1[2]
2002-1996 (Warner T5 World Class)	
Ndle Bearing	QBR23549[15]
1996-1990 (Tremec 3550)	
Ndle Bearing	QBR23549[17]
1995-1993 (Warner T5 World Class)(Cobra)	
Set	SET1[2]
1995-1993 (Warner T5 World Class)(Exc. Cobra)	
Ndle Bearing	QBR23549[15]
1992-1990 (Warner T5 World Class)	
Ndle Bearing	QBR23549[15]

⁶⁴Seal & Bushing Kit

Mfg./Year	Model & Location	Part No.	Mfg./Year	Model & Location	Part No.
FORD - REAR DRIVE - Mustang; incl. Boss, Cobra, GT, Mach I, McLaren, Saleen, Shelby, SVO, SVT, Shelby GT500 (cont.)					

5-SPEED MANUAL TRANSMISSION

Mainshaft 1st Speed Gear

2002-1990 (Warner T5 World Class)
Ndle BearingF218255[2]

Mainshaft 2nd Speed Gear

2002-1990 (Warner T5 World Class)
Ndle BearingF93934[2]

Reverse Idler

2002-1996 (Warner T45)
Ball Bearing 207[2]
1996-1990 (Tremec 3550)
Ndle BearingC407Q[44]

Rear Output Shaft

2002-1996 (Warner T45)
Seal 710426
Cone/Cup 25572-25520[2]
1996-1990 (Tremec 3550)
Seal 7692S
Seal Kit 5202⁶⁴
Ndle Bearing Thrust FA35688[2]

CAMSHAFT SEAL

4 Cylinder

1993-1990
Seal2955

CRANKSHAFT FRONT SEAL

4 Cylinder

1993-1990
Seal2955

6 Cylinder

2004 238/3.9L
Seal 712692
Harmnc Balancer Slvs 88187
2004-1990 232/3.8L
Seal (Frt) 2692
Seal (Rr) 2942
Repair SleeveKWK99187
Harmnc Balancer Slvs 88187

8 Cylinder

2008-1996 281/4.6L (SOHC)(DOHC),
330/5.4L (DOHC)
Seal482041N
Repair SleeveKWK99187
Harmnc Balancer Slvs 88187
1995-1990 255/4.2L, 302/5.0L, 351/5.8L
(W)
Seal (Frt Entry)2692
Seal (Rr Entry)2942
Repair SleeveKWK99187
Harmnc Balancer Slvs 88187

CRANKSHAFT REAR SEAL

4 Cylinder

1993-1990
Seal Viton 3909
Seal PTFE H/D (Opt) 5277
Repair SleeveKWK99363

6 Cylinder

2008-2005 245/4.0L
Seal Viton 3393
Repair SleeveKWK99238
2004-1990 232/3.8L from 12/31/82
Seal Viton 3909
Seal PTFE H/D (Opt) 5277
Repair SleeveKWK99363

8 Cylinder

2008-1990 281/4.6L, 302/5.0L,330/5.4L
Seal Viton 3909
Seal PTFE H/D 5277
Repair SleeveKWK99363
1996-1995 351/5.8L (W)
Seal Viton 2377
Seal PTFE H/D 5278
Repair SleeveKWK99372

⁶⁴Seal & Bushing Kit

Mfg./Year Model & Location Part No. Mfg./Year Model & Location Part No.

FORD - REAR DRIVE - Thunderbird**FRONT WHEEL****RWD**

2005-2002	
Hub Unit Bearing	HA590213[2]
1997-1991	
Hub Unit Bearing	513092[2]
1990 (ABS)	
Hub Unit Bearing	513076[2]
1990 (Non-ABS)	
Hub Unit Bearing	513077[2]

REAR WHEEL**RWD**

2005-2002	
Ball Bearing	511032[2]
1997-1990	
Set	SET49[2]

REAR AXLE**Axle Shaft**

2005-1990 (7.5", 8.8" R.G.)	
Seal Viton	714569[2]
Ndle Bearing	FC66998[2]
Repair Sleeve	KWK99157[2]

Differential Rebuild Kit

1997-1990 (8.8" R.G.)	
Kit	DRK311
1997-1990 (7.5" R.G.)	
Kit	DRK315

Differential

2005-2002 (8" R.G.)	
Set	SET36[2]
1997-1990 (8.8" R.G.)	
Set	SET36[2]
1997-1990 (7.5" R.G.)	
Cone/Cup	LM501349-LM501314[2]

Pinion

2005-2002 (8" R.G.)	
Seal Viton	3604
Cone/Cup (Inner)	NP559445-NP945727
Cone/Cup (Outer)	M88048-M88010
1997-1990 (7.5" R.G.)	
Seal Viton	3604
Cone/Cup (Inner)	M802048-M802011
Cone/Cup (Outer)	M88048-M88010
1997-1990 (8.8" R.G.)	
Seal Viton	3604
Cone/Cup (Inner)	M802048-M802011
Cone/Cup (Outer)	M88048-M88010

4-SPEED AUTOMATIC TRANSMISSION**Torque Converter**

1997-1994 (AODE, AODEW)	
Seal	710447
Repair Sleeve	KWK99199

4-SPEED AUTOMATIC TRANSMISSION (cont.)**Torque Converter (cont.)**

1993-1990 (AOT, AOD)	
Seal	331107N[2]
Repair Sleeve	KWK99199

Rear Seal/Ext. Housing

1997-1994 (AODE)	
Seal	7692S[2]
Seal Kit	5202 ⁶⁴
1993-1990 (AOT, AOD)(long boot)	
Seal	7692S[2]
Seal Kit	5202 ⁶⁴

Selector Shaft Seal/Man. Shaft

1997-1990	
Seal	7929S

5-SPEED AUTOMATIC TRANSMISSION**Selector Shaft Seal/Man. Shaft**

2005-2002	
Seal	7929S

CLUTCH**Pilot Bearing**

1995-1990 3.8 6 Cyl.	
Ndle Bearing	FC65174

5-SPEED MANUAL TRANSMISSION**Front Input Shaft**

1997-1990 Mazda	
Seal	223012
Repair Sleeve	KWK99114

Countershaft

1997-1990 (Mazda M5R2)	
Cylindrical Bearing (Center)	MR1207EL[2]
Ball Bearing (Rr)	304WB[2]

Extension Housing

1995-1990 (Mazda M5R2)	
Seal	710415

A/C COMPRESSOR

1997-1990 (Nippondenso FX 15)(Axial)	
Ball Bearing	5106WCC[2]
1990 (Ford FS6)(Axial)	
Ball Bearing	5000KFF[2]
1990 (Nippondenso 6P148)(Axial)	
Ball Bearing	5001KFF[2]
1990 (Frigidaire A6)(Axial)	
Ball Bearing	907257[2]

⁶⁴Seal & Bushing Kit

Mfg./Year Model & Location Part No. Mfg./Year Model & Location Part No.

FORD - REAR DRIVE - Thunderbird (cont.)

ALTERNATOR

- 1995-1994 Mitsubishi 110 Amp.
Ball Bearing (Drive End)303CC
- 1993-1990 (Motorcraft)
Ball Bearing (Drive End)203FF
- 1993-1990 (Motorcraft)
Ball Bearing (Rear End) MNJ471S

POWER STEERING

Input Shaft

- 1993-1990
Seal471645
Ndle Bearing FC65753[2]

Pump Shaft

- 1997-1990
Seal8773S

Worm Shaft

- 1997-1990
Ball Bearing 201CC[2]

CRANKSHAFT FRONT SEAL

6 Cylinder

- 1997-1990 232/3.8L
Seal (Frt)2692
Seal (Rr)2942
Repair Sleeve KWK99187
Harmnc Balancer Slvs 88187

8 Cylinder

- 1997-1994
Seal482041N
Repair SleeveKWK99187
Harmnc Balancer Slvs 88187
- 1993-1990
Seal (Frt Entry)2692
Seal (Rr Entry)2942
Repair SleeveKWK99187
Harmnc Balancer Slvs 88187

CRANKSHAFT REAR SEAL

6 Cylinder

- 1997-1990 232/3.8L from 12/31/82
Seal Viton 3909
Seal PTFE H/D 5277
Repair SleeveKWK99363

8 Cylinder

- 1997-1990 281/4.6L, 302/5.0L
Seal Viton 3909
Seal PTFE H/D 5277
Repair SleeveKWK99363

FORD - Import - Aspire

FRONT WHEEL

FWD

- 1997-1994
Seal (Inner)4990[2]
Set (Inner) SET11[2]
Seal (Outer) 710323[2]
Set (Outer) SET11[2]

REAR WHEEL

FWD

- 1997-1994
Seal (Inner) 1126S[2]
Set (Inner) SET4[2]
Set (Outer) SET1[2]

CLUTCH

Pilot Bearing

- 1997-1994
Ball Bearing 202SS

Release Bearing

- 1997-1994
Bearing Assy614127

3-SPEED AUTOMATIC TRANSAXLE

Differential

- 1997-1994 (ATX)
Bearing Assy32008XM[2]

Mfg./Year	Model & Location	Part No.	Mfg./Year	Model & Location	Part No.
-----------	------------------	----------	-----------	------------------	----------

FORD - Import - Aspire (cont.)**3-SPEED AUTOMATIC TRANSAXLE****Torque Converter**

1997-1994 (ATX)
 Seal 1012N
 Repair Sleeve KWK99177

Output Shaft

1997-1994 (ATX)
 Seal 2007N[2]
 Repair Sleeve KWK99139[2]

5-SPEED MANUAL TRANSAXLE**Differential**

1997-1994 (MTX)
 Set SET13[2]

Input Shaft

1997-1994 (MTX)
 Seal (Frt) 222238
 Repair Sleeve KWK99085
 Ball Bearing (Rr) 304DD[2]

Output Shaft

1997-1994 (MTX)
 Seal (LH) 223543
 Set (LH) SET3[2]
 Repair Sleeve KWK99139
 Seal (RH) 2007N
 Bearing Assy (RH) 32204[2]
 Repair Sleeve KWK99139

Selector Shaft Seal/Man. Shaft

1997-1994 (MTX)
 Seal 221620

CAMSHAFT SEAL**4 Cylinder**

1997-1994 1324cc/1.3L
 Seal 223012
 Repair Sleeve KWK99114

CRANKSHAFT FRONT SEAL**4 Cylinder**

1997-1994 1324cc/1.3L
 Seal 710355
 Repair Sleeve KWK99145

CRANKSHAFT REAR SEAL**4 Cylinder**

1997-1994 1324cc/1.3L
 Seal 228250
 Repair Sleeve KWK99328

FORD - Import - Festiva**FRONT WHEEL****FWD**

1993-1990
 Seal (Inner) 4990[2]
 Set (Inner) SET11[2]
 Seal (Outer) 710323[2]
 Set (Outer) SET11[2]

REAR WHEEL**FWD**

1993-1990
 Seal (Inner) 1126S[2]
 Set (Inner) SET4[2]
 Set (Outer) SET1[2]

CLUTCH**Pilot Bearing**

1993-1990
 Ball Bearing 202SS

Mfg./Year Model & Location Part No. Mfg./Year Model & Location Part No.

FORD - Import - Festiva (cont.)

CLUTCH

Release Bearing

1993-1990
Bearing Assy614127

3-SPEED AUTOMATIC TRANSAXLE

Differential

1993-1990 (ATX)
Bearing Assy32008XM[2]

Torque Converter

1993-1990 (ATX)
Seal 1012N
Repair SleeveKWK99177

Output Shaft

1993-1990 (ATX)
Seal2007N[2]
Repair SleeveKWK99139[2]

5-SPEED MANUAL TRANSAXLE

Differential

1993-1990 (MTX)
Set SET13[2]

Input Shaft

1993-1990 (MTX)
Seal (Frt) 222238
Repair SleeveKWK99085
Ball Bearing (Rr) 304DD[2]

Output Shaft

1993-1990 (MTX)
Seal (LH) 223543
Set (LH) SET3[2]
Repair SleeveKWK99139
Seal (RH) 2007N
Bearing Assy (RH)32204[2]
Repair SleeveKWK99139

Selector Shaft Seal/Man. Shaft

1993-1990 (MTX)
Seal221620

CAMSHAFT SEAL

4 Cylinder

1993-1990 1324cc/1.3L
Seal 223012
Repair SleeveKWK99114

CRANKSHAFT FRONT SEAL

4 Cylinder

1993-1990 1324cc/1.3L
Seal 223012
Repair SleeveKWK99114

CRANKSHAFT REAR SEAL

4 Cylinder

1993-1990 1324cc/1.3L
Seal 228250
Repair SleeveKWK99328

FORD TRUCK - Lt Truck, SUV - Aerostar, Bronco II, Explorer, Explorer Sport Trac, Ranger**FRONT WHEEL****RWD**

2009-2007	Explorer Sport Trac	
	Hub Unit Bearing	HA590156[2] ²⁵
2009-2006	Explorer	
	Hub Unit Bearing	HA590156[2] ²⁵
2009-1995	Ranger	
	Seal (Inner)	9150S[2]
	Set (Inner)	SET5[2]
	Set (Outer)	SET2[2]
2005-2002	Explorer	
	Hub Unit Bearing (ABS Cable Included)	SP470200[2]
	Hub Unit Bearing	SP470201[2] ⁰²
2005-2001	Explorer Sport Trac	
	Seal (Inner)	9150S[2]
	Set (Inner)	SET5[2]
	Set (Outer)	SET2[2]
2001-1995	Explorer	
	Seal (Inner)	9150S[2]
	Set (Inner)	SET5[2]
	Set (Outer)	SET2[2]
1997-1990	Aerostar	
	Seal (Inner)	6815[2]
	Set (Inner)	SET6[2]
	Set (Outer)	SET2[2]
1994-1991	Explorer	
	Seal (Inner)	6815[2]
	Set (Inner)	SET6[2]
	Set (Outer)	SET2[2]
1994-1990	Ranger	
	Seal (Inner)	6815[2]
	Set (Inner)	SET6[2]
	Set (Outer)	SET2[2]

4WD

2009-2007	Explorer Sport Trac	
	Hub Unit Bearing	HA590156[2] ²⁵
2009-2006	Explorer	
	Hub Unit Bearing	HA590156[2] ²⁵
2009-2003	Ranger (4 Whl. ABS)	
	Hub Unit Bearing	SP450202[2]
2005-2003	Explorer Sport Trac	
	Hub Unit Bearing	SP450202[2]
2005-2002	Explorer (4 Whl. ABS)	
	Hub Unit Bearing (ABS Cable Included)	SP470200[2]
	Hub Unit Bearing	SP470201[2] ⁰²
2002-2001	Explorer Sport Trac	
	Hub Unit Bearing	SP450200[2] ⁴⁰
2002-2000	Ranger (ABS)(From 6/22/2000)	
	Hub Unit Bearing	SP450201[2] ⁴⁰
2001-1995	Explorer	
	Hub Unit Bearing	SP450200[2] ⁴⁰
2000	Ranger (2 Whl. ABS)(From 6/22/2000)	
	Hub Unit Bearing	515014[2]
2000-1998	Ranger (2 Whl. ABS)(To 6/21/2000)	
	Hub Unit Bearing	515026[2]

FRONT WHEEL (cont.)**4WD (cont.)**

2000-1998	Ranger (4 Whl. ABS)(To 6/21/2000)	
	Hub Unit Bearing	515027[2]
1997-1990	Aerostar	
	Hub Unit Bearing	515000[2]
1997-1990	Bronco II, Ranger (Dana/Spicer 28 Axle)	
	Seal (Inner)	8312S[2]
	Set (Inner)	SET45[2]
	Set (Outer)	SET45[2]
1997-1990	Bronco II, Ranger (Dana/Spicer 35 Axle)	
	Seal (Inner)	4250[2]
	Set (Inner)	SET37[2]
	Set (Outer)	SET37[2]
1994-1991	Explorer	
	Seal (Inner)	4250[2]
	Set (Inner)	SET37[2]
	Set (Outer)	SET37[2]

REAR WHEEL**RWD**

2009-2007	Explorer Sport Trac	
	Hub Unit Bearing	HA590259K[2] ⁶⁸
	Bearing Assy	516008[2] ²⁵
2009-2002	Explorer (Indep. Rr. Susp.)	
	Hub Unit Bearing	HA590259K[2] ⁶⁸
	Bearing Assy (Opt)	516008[2] ²⁵
2009-1990	Ranger (7.5" R.G.)	
	Seal	8660S[2]
	Cylindrical Bearing	5707[2]
	Bearing & Seal Kit	TRP1563TAV[2] ¹⁹
2005-2001	Explorer, Explorer Sport Trac (Exc. Indep. Rr. Susp.)	
	Seal	8835S[2]
	Cylindrical Bearing	6408[2]
	Bearing & Seal Kit	TRP1559TV[2] ¹⁹
2005-1990	Ranger (8.8" R.G.)	
	Seal	8835S[2]
	Cylindrical Bearing	6408[2]
	Bearing & Seal Kit	TRP1559TV[2] ¹⁹
2002-1998	Ranger (Elec.)	
	Set	SET49[2]
2001-1991	Explorer (Exc. Indep. Rr. Susp.)	
	Seal	8835S[2]
	Cylindrical Bearing	6408[2]
	Bearing & Seal Kit	TRP1559TV[2] ¹⁹
1997-1990	Aerostar (8.8" R.G.)	
	Seal	8835S[2]
	Cylindrical Bearing	6408[2]
	Bearing & Seal Kit	TRP1559TV[2] ¹⁹
1997-1990	Aerostar (7.5" R.G.)	
	Seal	8660S[2]
	Cylindrical Bearing	5707[2]
	Bearing & Seal Kit	TRP1563TAV[2] ¹⁹
1990	Aerostar (Dana/Spicer 30 Axle)	
	Seal	2146[2]
	Set	SET9[2]

⁰²Does Not Come w/ Sensor Cable.
Check For Availability ⁴⁰5 Stud.

¹⁹Opt. Axle Rpr Brg. Replaces O.E. Brg & Seal
⁶⁸Kit = Flg, Brg, & Snap Ring

²⁵New Item,

Mfg./Year Model & Location Part No. Mfg./Year Model & Location Part No.
FORD TRUCK - Lt Truck, SUV - Aerostar, Bronco II, Explorer, Explorer Sport Trac, Ranger (cont.)

REAR WHEEL (cont.)

RWD (cont.)

1990	Bronco II	
Seal	8660S[2]
Cylindrical Bearing	5707[2]
Bearing & Seal Kit	TRP1563TAV[2] ¹⁹

4WD

2009-2007	Explorer Sport Trac	
Hub Unit Bearing	HA590259K[2] ⁶⁸
Bearing Assy	516008[2] ²⁵
2009-2002	Explorer (Indep. Rr. Susp.)	
Hub Unit Bearing	HA590259K[2] ⁶⁸
Bearing Assy (Opt)	516008[2] ²⁵
2009-1990	Ranger (7.5" R.G.)	
Seal	8660S[2]
Cylindrical Bearing	5707[2]
Bearing & Seal Kit	TRP1563TAV[2] ¹⁹
2005-2001	Explorer, Explorer Sport Trac (Exc. Indep. Rr. Susp.)	
Seal	8835S[2]
Cylindrical Bearing	6408[2]
Bearing & Seal Kit	TRP1559TV[2] ¹⁹
2005-1990	Ranger (8.8" R.G.)	
Seal	8835S[2]
Cylindrical Bearing	6408[2]
Bearing & Seal Kit	TRP1559TV[2] ¹⁹
2002-1998	Ranger (Elec.)	
Set	SET49[2]
2001-1991	Explorer (Exc. Indep. Rr. Susp.)	
Seal	8835S[2]
Cylindrical Bearing	6408[2]
Bearing & Seal Kit	TRP1559TV[2] ¹⁹
1997-1990	Aerostar (8.8" R.G.)	
Seal	8835S[2]
Cylindrical Bearing	6408[2]
Bearing & Seal Kit	TRP1559TV[2] ¹⁹
1990	Aerostar (Dana/Spicer 30 Axle)	
Seal	2146[2]
Set	SET9[2]
1990	Bronco II	
Seal	8660S[2]
Cylindrical Bearing	5707[2]
Bearing & Seal Kit	TRP1563TAV[2] ¹⁹

4WD FRONT AXLE

Axle Shaft

2008-2002	(8.8" R.G.)(Indep. Frt. Susp.)	
Ndle Bearing (Inner)	HK4012[2]
Ndle Bearing (Outer)	FC66998[2]
2001-1995	(Dana/Spicer 35 Axle)	
Seal Viton (LH)	710429
Seal Viton (RH)	710428
1997-1990	(Dana/Spicer 35IFS Axle)	
Seal (LH)	710043
Seal (RH)	470672
Cylindrical Bearing (RH)	5707[2]
1997-1990	(Dana/Spicer 28IFS Axle)	
Seal (LH)	3543
Seal (RH)	710065

Differential Rebuild Kit

2007-1990	(Dana/Spicer 35 Axle)	
Kit	DRK335
2003-2001	Explorer (Dana/Spicer Super 30 axle)	
Kit	DRK334B
1999-1990	(Dana/Spicer 28 Axle)	
Kit	DRK333

Differential

2007-1990	(Dana/Spicer 35 Axle)	
Cone/Cup	LM501349-LM501314[2]
2003-2001	Explorer (Dana/Spicer Super 30 axle)	
Cone/Cup	LM501349-LM501314[2]
1999-1990	(Dana/Spicer 28 Axle)	
Cone/Cup	LM29749-LM29710[2]

Pinion

2008-2001	Explorer (Dana/Spicer Super 30 axle)	
Seal Viton	714675
Cone/Cup (Inner)	HM88649-HM88610
Cone/Cup (Outer)	M86649-M86610
2008-2001	Ranger	
Seal Viton (Outer)	714675
Cone/Cup (Inner)	HM88648-HM88610
Cone/Cup (Outer)	M86649-M86610
1999-1990		
Seal (Dana/Spicer 28 Axle)	4244
Cone/Cup (Inner) (Dana/Spicer 28 Axle)	M88048-M88010
Seal Viton (Dana/Spice 35 Axle)	714675
Cone/Cup (Inner) (Dana/Spicer 35 Axle)	HM88648-HM88610
Cone/Cup (Outer) (All)	M86649-M86610

Spindle Kit

1997-1990	(Dana/Spicer 35IFS Axle)	
Bearing & Seal Kit	SBK4[2] ³⁶
1997-1990	(Dana/Spicer 28IFS Axle)	
Bearing & Seal Kit	SBK2[2] ³⁴

Spindle

1997-1993	(Dana/Spicer 28IFS, 35IFS axle)	
Seal (Inner)	710453[2]
Ndle Bearing (Inner)	B2110[2]
Seal (Outer)	722108[2]
Ndle Bearing Thrust	NTA1625[2]
1997-1990	(Dana/Spicer 35IFS Axle)	
Seal (Inner)	722109[2]
Ndle Bearing	B2110[2]
Seal (Outer)	722108
1992-1990	(Dana/Spicer 28IFS Axle)	
Seal (Inner)	340835[2]
Ndle Bearing (Inner)	SCE188[2]
Seal (Outer)	8314S[2]
Ndle Bearing Thrust (Outer)	NTA1625[2]

¹⁹Opt. Axle Rpr Brg. Replaces O.E. Brg & Seal

²⁵New Item, Check For Availability

³⁴Opt. Kit =

Brg SCE148, Seal 8314S ³⁶Opt. Kit = Brg B2110, Seals 722108 & 722109, & Ring

⁶⁸Kit = Flg,

Brg, & Snap Ring

Mfg./Year	Model & Location	Part No.	Mfg./Year	Model & Location	Part No.
-----------	------------------	----------	-----------	------------------	----------

FORD TRUCK - Lt Truck, SUV - Aerostar, Bronco II, Explorer, Explorer Sport Trac, Ranger (cont.)

REAR AXLE

Axle Shaft

2008-2002 (8.8" R.G.)(Indep. Rr. Susp.)	
Ndle Bearing	FC66998[2]
Seal	100537[2]

Differential Rebuild Kit

2008-2002 (8.8" R.G.)(Indep. Rr. Susp.)	
Kit	DRK311A ²⁵
2008-1990 (Dana/Spicer 35 Axle)	
Kit	DRK335
2008-1990 (7.5" R.G.)	
Kit	DRK315
2003-1990 (Dana/Spicer 28 Axle)	
Kit	DRK333
2001-1990 (8.8" R.G.)	
Kit	DRK311

Differential

2008-2002 (8.8" R.G.)(Indep. Rr. Susp.)	
Cone/Cup	LM603049-LM603019[2]
2008-1990 (7.5 R.G.)(Dana/Spicer 30 Axle)	
Cone/Cup	LM501349-LM501314[2]
2008-1990 (8.8" R.G.)	
Set	SET36[2]

Pinion

2008-1990 (7.5", 8.8", 8.8" IRS R.G.)	
Seal Viton	3604
Cone/Cup (Inner)	M802048-M802011
Cone/Cup (Outer)	M88048-M88010
Repair Sleeve	KWK99181

TRANSFER CASE REBUILD KIT

2003-2001	
Kit (Borg Warner 1354)	TCRK1354
2000-1998	
Kit (Borg Warner 4404)	TCRK4404
Kit (Borg Warner 4405)	TCRK4405
Kit (Borg Warner 1354)	TCRK1354
1997-1996	
Kit (Borg Warner 4405)	TCRK4405
Kit (Borg Warner 4404)	TCRK4404
Kit (Dana/Spicer 28)	TCRK28
1995-1991	
Kit (Dana/Spicer 28)	TCRK28
Kit (Borg Warner 1354)	TCRK1354
Kit (Borg Warner 4404)	TCRK4404
Kit (Borg Warner 4405)	TCRK4405

TRANSFER CASE REBUILD KIT (cont.)

1990	
Kit (Borg Warner 1359)	TCRK1359
Kit (Borg Warner 1354)	TCRK1354
Kit (Dana/Spicer 28)	TCRK28

TRANSFER CASE

Input Shaft

2008-1993	
Ball Bearing (Warner 4405)	209LO
Seal (Warner 1354, 4405)	710403
Ball Bearing (Warner 1354)	109L
Repair Sleeve (Warner 1354, 4405)	KWK99166
Ndle Bearing (Pilot (Warner 1354, 4405)	M18161
2008-1990 (Warner 1354)	
Seal (Pilot)	4143
Ndle Bearing (Pilot)	M18161
Seal	710403
Ball Bearing	109L
2001-1996 (Warner 4403, 4404)(w/o Boot)	
Seal	3946
Repair Sleeve	KWK99187
1998-1996 (Warner 4404)(booted)	
Seal	4333N
1997-1990 (Spicer TC28)	
Seal	710389
Ball Bearing	209D
Repair Sleeve	KWK99174
Ndle Bearing (Pilot)	B2110
1990 (Warner 1350, 1359)	
Seal	710062
Ball Bearing	109FFL
Repair Sleeve	KWK99175
Ndle Bearing (Pilot)	M18161

Front Output Shaft

2008-1996 (Warner 4405, 4411, 4412)	
Ball Bearing (Inner)	306H
Seal (Outer)	710403
Ball Bearing (Outer)	206WB
Seal	KWK99166
2008-1990 (Warner 1354, 4410)	
Seal	710403
Ball Bearing	206WB
Repair Sleeve	KWK99166
2001-1996 (Warner 4403, 4404)	
Ball Bearing (Inner)	206WB
Seal (Outer)	710403
Ball Bearing (Outer)	207
Repair Sleeve	KWK99166

²⁵New Item, Check For Availability

Mfg./Year	Model & Location	Part No.	Mfg./Year	Model & Location	Part No.
FORD TRUCK - Lt Truck, SUV - Aerostar, Bronco II, Explorer, Explorer Sport Trac, Ranger (cont.)					

TRANSFER CASE (cont.)

Front Output Shaft (cont.)

2001-1996 (Warner 4405)	
Ball Bearing (Inner)	306H
Seal (Outer)	710403
Ball Bearing (Outer)	206WB
Repair Sleeve	KWK99166
Ndle Bearing (Pilot)	FC67945 ¹⁶
1997-1990 (Spicer TC28)	
Seal	710388
Ball Bearing	209BB
Repair Sleeve	KWK99187
Ndle Bearing (Pilot)	B2110
1992-1990 (Warner 1354)	
Seal	4143
Ball Bearing	206WB

Rear Output Shaft

2008-2002 (Warner 4410)	
Seal	710403
Ball Bearing	208SL
Repair Sleeve	KWK99166
2008-1996 (Warner 4405, 4411, 4412)	
Seal	710403
Ball Bearing	306H
Repair Sleeve	KWK99166
2008-1993 (Warner 1354)	
Seal	710403
Ball Bearing	206WB
Repair Sleeve	KWK99166
2001-1999 (Warner 4403)	
Seal	710403
Ball Bearing	208
Repair Sleeve	KWK99166
2001-1996 (Warner 4405)	
Seal	710403
Ball Bearing	306H
Repair Sleeve	KWK99166
1998-1996 (Warner 4404)	
Ball Bearing (Inner)	N1061
Seal (Outer)	710403
Ball Bearing (Outer)	208SL
Repair Sleeve	KWK99166
1997-1990 (Spicer TC28)	
Seal	710441
Ball Bearing	209BB
Ndle Bearing (Pilot)	B2110
1992-1990 (Warner 1350, 1354)	
Seal	4143
Ball Bearing	206WB
Ndle Bearing (Pilot)	JH1612
1990 (Warner 1359)	
Seal	4143
Ball Bearing	206WB
Repair Sleeve	KWK99175

Selector Shaft Seal/Man. Shaft

2008-1990	
Seal	330385

4-SPEED AUTOMATIC TRANSMISSION

Torque Converter

2001-1996 (4R70W)	
Seal	3404
1996-1990 (A4LD, 4R44E, 4R55E)	
Seal	2658

Rear Seal/Ext. Housing

2002-1990 (A4LD, 4R44E, 4R55E)	
Seal	2655
2001-1996 (4R70W)	
Seal	4765

Selector Shaft Seal/Man. Shaft

2008-1990	
Seal	7929S

5-SPEED AUTOMATIC TRANSMISSION

Rear Seal/Ext. Housing

2008-2002 (5R55W)(Non-Booted)	
Seal	4764
2008-1997 (5R44E, 5R55E)	
Seal	2655
2008-1996 (5R55S, 5R55W)(Booted)	
Seal	4765

Selector Shaft Seal/Man. Shaft

2008-1997 (5R44E, 5R55E, 5R55S, 5R55W)	
Seal	7929S

6- SPEED AUTOMATIC TRANSMISSION

Torque Converter

2008-2006 (6R60)	
Seal	710484

Rear Seal/Ext. Housing

2008-2006 (6R60)(2WD)	
Seal	710487
2008-2006 (6R60)(4WD)	
Seal	710486

CLUTCH

Pilot Bearing

2002-1990 4 Cyl. (w/o Diesel)	
Ndle Bearing	FC65354
2001-1990 6 Cyl. 3.0	
Ndle Bearing	FC65354
1998-1992 6 Cyl. 2.9	
Ndle Bearing	F33126
1998-1992 6 Cyl. 4.0	
Ndle Bearing	F33126
1991-1990 6 Cyl. 4.0	
Ndle Bearing	F33126
1991-1990 6 Cyl. 2.8, 2.9 (Mazda trans)	
Ndle Bearing	F33126

¹⁶Obsolete

Mfg./Year	Model & Location	Part No.	Mfg./Year	Model & Location	Part No.
FORD TRUCK - Lt Truck, SUV - Aerostar, Bronco II, Explorer, Explorer Sport Trac, Ranger (cont.)					

CLUTCH (cont.)**Pilot Bearing (cont.)**

1991-1990	6 Cyl. 2.8, 2.9 (Mitsubishi trans)	
	BushingPB52

Release Bearing

2001-1993	(Hyd.piston type)	
	Bearing Assy614169
1992-1990	(Hyd.piston type)	
	Bearing Assy614061

5-SPEED MANUAL TRANSMISSION**Transmission Rebuild Kit**

2002-1990	(FM 146)	
	KitTRK50
2002-1990	(M5R1)	
	KitTRK247
2002-1990	(FM 145)	
	KitTRK50

Front Input Shaft

2002-1990	(Mazda M5R1)	
	Seal1990
	Repair SleeveKWK99106
1991-1990	Mitsubishi	
	Seal223014
	Repair SleeveKWK99114

Countershaft

2004-1991	Mazda	
	Ball Bearing (Rr)304WB[2]
1991-1990	Mitsubishi	
	Cone/Cup (Rr)XAA30205-YAA30205[2]
	Cone/Cup (Center)XAA30205-YAA30205[2]

Rear Output Shaft

2002-1990	(Mazda M5R1)(2WD)	
	Seal7692S
2002-1990	(Mazda M5R1)(4WD)	
	Seal1981
1991-1990	Mitsubishi	
	Seal223608
	Ball Bearing206L[2]

DRIVESHAFT SUPPORT

1997-1990	Ranger (Spicer 1280)(1.1811" 30mm Brg. I.D.)	
	Hanger Bearing AssyHBD206FF[2]

AUXILIARY SHAFT**4 Cylinder**

2001-1990	122/2.0, 140/2.3, 150/2.5	
	Seal2955

CAMSHAFT SEAL**4 Cylinder**

2000-1990	122/2.0, 140/2.3, 150/2.5	
	Seal2955

CRANKSHAFT FRONT SEAL**4 Cylinder**

2003-2001	140/2.3L (DOHC)	
	Seal3771
	Repair SleeveKWK99139
2001-1990	122/2.0L, 140/2.3L, 150/2.5L	
	Seal2955

6 Cylinder

2008-1990	183/3.0L	
	Seal (Frt Entry)2692
	Repair SleeveKWK99187
	Harmnc Balancer Slvs88187
2004-1990	171/2.8L, 177/2.9, 244/4.0L	
	Seal Viton2012V
	Repair SleeveKWK99166

8 Cylinder

2008-2002	281/4.6L	
	Seal482041N
	Repair SleeveKWK99187
	Harmnc Balancer Slvs88187
2001-1996	302/5.0L	
	Seal (Frt)2692
	Seal (Rr Entry)2942
	Repair SleeveKWK99187
	Harmnc Balancer Slvs88187

CRANKSHAFT REAR SEAL**4 Cylinder**

2003-1990	122/2.0L, 140/2.3L, 150/2.5L	
	Seal Viton3909
	Seal PTFE H/D5277
	Repair SleeveKWK99363

6 Cylinder

2008-1990	182/3.0L (OHV)	
	Seal3772
	Seal PTFE H/D (Opt)5287
2008-1990	171/2.8L, 177/2.9, 245/4.0L	
	Seal Viton3393
	Seal PTFE H/D (Opt)5288
	Repair SleeveKWK99238
2002-1995	181/3.0L (DOHC)	
	Seal Viton3909
	Seal PTFE H/D (Opt)5277
	Repair SleeveKWK99363

Mfg./Year Model & Location Part No. Mfg./Year Model & Location Part No.

FORD TRUCK - Lt Truck, SUV - Aerostar, Bronco II, Explorer, Explorer Sport Trac, Ranger (cont.)

CRANKSHAFT REAR SEAL

8 Cylinder

2008-2002	281/4.6L	
Seal Viton		3909
Seal PTFE H/D		5277
Repair Sleeve		KWK99362
2001-1996	302/5.0L	
Seal Viton		3909
Seal PTFE H/D		5277
Repair Sleeve		KWK99363

FORD TRUCK - Lt Truck, SUV - Edge

FRONT WHEEL

FWD

2009-2007		
Ball Bearing		510063[2]

AWD

2009-2007		
Ball Bearing		510063[2]

REAR WHEEL

FWD

2009		
Hub Unit Bearing		HA590335[2]
2008-2007		
Hub Unit Bearing		HA590180[2] ²⁵

AWD

2009-2007		
Hub Unit Bearing		HA590183[2] ²⁵

CRANKSHAFT FRONT SEAL

6 Cylinder

2008-2007	3496cc/3.5L	
Seal		482041N
Repair Sleeve		KWK99187

FORD TRUCK - Lt Truck, SUV - Escape, Escape Hybrid

FRONT WHEEL

FWD

2009-2001	Escape, Escape Hybrid	
Hub Unit Bearing		HA590286K[2] ⁶⁷
Ball Bearing		510072[2] ²⁵

4WD

2009-2001	Escape, Escape Hybrid	
Hub Unit Bearing		HA590286K[2] ⁶⁷
Ball Bearing		510072[2] ²⁵

REAR WHEEL

FWD

2009-2001	Escape, Escape Hybrid	
Ball Bearing		510029[2]

REAR WHEEL

4WD

2009-2001	Escape, Escape Hybrid	
Ball Bearing		510029[2]

4WD FRONT AXLE

Axle Shaft

2005-2001		
Seal		3622S[2]

REAR AXLE

Axle Shaft

2008-2001		
Seal Viton		710429[2]

²⁵New Item, Check For Availability

⁶⁷Kit = Flg, Brg, Nut, & Snap Ring

Mfg./Year Model & Location Part No. Mfg./Year Model & Location Part No.

FORD TRUCK - Lt Truck, SUV - Escape, Escape Hybrid (cont.)

REAR AXLE

Differential

2008-2001
Cone/CupLM29749-LM29710[2]

Pinion

2008-2001 (Spicer 28)(6.85" R.G.)
Seal 100552
Cone/Cup (Inner) M86649-M86610
Cone/Cup (Outer) M88048-M88010

TRANSFER CASE

Rear Output Shaft

2008-2001
Seal Viton 710429

CLUTCH - 4 CYLINDER

Pilot Bearing

2004-2001 2.0L
Ndle Bearing FC65354

CLUTCH

Release Bearing

2006-2001
Bearing Assy614079

4-SPEED AUTOMATIC TRANSAXLE

Manual Shaft

2004-2001 2.0L
Seal 342517
Repair SleeveKWK99101

5-SPEED MANUAL TRANSAXLE

Differential

2004-2001
Seal2007N[2]
Repair SleeveKWK99139
Bearing Assy32008XM[2]

Output Shaft

2004-2001
Bearing Assy (Rr)513185[2]

CRANKSHAFT FRONT SEAL

4 Cylinder

2004-2001 121/2.0L (DOHC)
Seal3771
Repair SleeveKWK99139

6 Cylinder

2008-2001 181/3.0L
Seal482041N
Repair SleeveKWK99187

CRANKSHAFT REAR SEAL

4 Cylinder

2004-2001 121/2.0L (DOHC)
Seal3772
Seal PTFE H/D (Opt) 5287

6 Cylinder

2008-2001 182/3.0L
Seal Viton 3909
Seal PTFE H/D 5277
Repair SleeveKWK99362

FORD TRUCK - Lt Truck, SUV - Flex

FRONT WHEEL

FWD

2009
Hub Unit BearingHA590261[2]²⁵

FRONT WHEEL

AWD

2009
Hub Unit BearingHA590261[2]²⁵

²⁵New Item, Check For Availability

Mfg./Year Model & Location Part No. Mfg./Year Model & Location Part No.

FORD TRUCK - Lt Truck, SUV - Flex (cont.)

REAR WHEEL

FWD

2009
Hub Unit Bearing HA590261[2]²⁵

AWD

2009
Hub Unit Bearing HA590261[2]²⁵

FORD - Minivan - Freestar, Windstar

FRONT WHEEL

FWD

2007-2004 (ABS)
Hub Unit Bearing (LH) HA590024[2]²⁵
2007-2004 (ABS)
Hub Unit Bearing (RH) HA590025[2]²⁵
2003-1999
Hub Unit Bearing 513156[2]
1998-1995
Set SET49[2]

REAR WHEEL

FWD

2007-2004 (ABS)
Hub Unit Bearing (LH) HA590021⁹⁴
Hub Unit Bearing (RH) HA590022⁸³
Hub Unit Bearing (RH) HA590021[2]⁹⁴
2003-1997 (From 8/4/97)
Hub Unit Bearing 512149[2]
1997-1995
Seal (Inner) 6815[2]
Set (Inner) SET6[2]
Set (Outer) SET12F[2]⁵⁹

4-SPEED AUTOMATIC TRANSAXLE

Differential

2001-1995
Ball Bearing 208[2]

Torque Converter / Frt Pump

2004-2001 (AF50N/AX4N)
Seal 4189H
2000-1995 (AXODE, AX4S)
Seal 4189H

Output Shaft

2007-2001 (AF50N/AX4N)
Seal 3622S[2]
Repair Sleeve KWK99169[2]
2000-1995 (AXODE, AX4S)
Seal 3622S[2]
Repair Sleeve KWK99169[2]

CRANKSHAFT FRONT SEAL

6 Cylinder

2007-2004 238/3.9L, 256/4.2L
Seal (Frt) 2692
Repair Sleeve KWK99187
2003-1995 232/3.8L
Seal (Frt) 2692
Seal (Rr) 2942
Repair Sleeve KWK99187
Harmnc Balancer Slvs 88187
2000-1995 183/3.0L
Seal (Frt) 2692
Seal (Rr) 2942
Repair Sleeve KWK99187
Harmnc Balancer Slvs 88187

CRANKSHAFT REAR SEAL

6 Cylinder

2006-2004 239/3.9L, 256/4.2L
Seal Viton 3909
Repair Sleeve KWK99362
2003-1995 232/3.8L
Seal Viton 3909
Seal PTFE H/D (Opt) 5277
Repair Sleeve KWK99363
2000-1995 182/3.0L
Seal 3772
Seal PTFE H/D (Opt) 5287

²⁵New Item, Check For Availability
⁹⁴HA590021 Will Service Both Sides.

⁵⁹O.E. Polymer Cage

⁸³Deplete Inventory

Mfg./Year	Model & Location	Part No.	Mfg./Year	Model & Location	Part No.
FORD TRUCK - Full Size SUV - Bronco - Full-Size					

FRONT WHEEL**4WD**

1996-1995	
Seal (Inner)	4250[2]
Set (Inner)	SET37[2]
Set (Outer)	SET45[2]
1994-1990 (Auto Locking Hub)	
Seal (Inner)	4250[2]
Set (Inner)	SET37[2]
Set (Outer)	SET45[2]
1994-1990 (Man. Locking Hub)	
Seal (Inner)	710091[2]
Set (Inner)	SET38[2]
Set (Outer)	SET45[2]

REAR WHEEL**4WD**

1996-1990 (8.8" R.G.)(Sterling Axle)	
Seal	8835S[2]
Cylindrical Bearing	6408[2]
Bearing & Seal Kit	TRP1559TV[2] ¹⁹

4WD FRONT AXLE**Differential Rebuild Kit**

1996-1990	
Kit	DRK339B

Differential

1996-1990	
Seal (Dana/Spicer 44 Axle)	2300[2]
Cone/Cup	25590-25523[2]

Pinion

1996-1990	
Seal	5778
Cone/Cup (Inner)	31594-31520
Cone/Cup (Outer)	02872-02820

Spindle Kit

1996-1990	
Bearing & Seal Kit	SBK4[2] ³⁶

Spindle

1996-1993 (Dana/Spicer 28IFS, 35IFS axle)	
Seal (Inner)	710453[2]
Ndle Bearing (Inner)	B2110[2]
Seal (Outer)	722108[2]
Ndle Bearing Thrust	NTA1625[2]
1992-1990	
Seal (Inner)	722108[2]
Ndle Bearing (Inner)	B2110[2]
Seal (Outer)	722109[2]

REAR AXLE**Differential Rebuild Kit**

1997-1990 (8.8" R.G.)	
Kit	DRK311

Differential

1996-1990 (8.8" R.G.)	
Set	SET36[2]

Pinion

1996-1990	
Seal Viton (8.8" R.G.)	3604
Seal (9" R.G.)	7044NA
Cone/Cup (Inner) (8.8" R.G.)	M802048-M802011
Cone/Cup (Inner) (9" R.G.)	M88048-M88010
Cone/Cup (Outer) (8.8" R.G.)	M88048-M88010
Cone/Cup (Outer) (9" R.G.)	M88048-M88010

TRANSFER CASE REBUILD KIT

1996-1990 (Warner 1356)	
Kit	TCRK1356
1991-1990 (Warner 1345)	
Kit	TCRK1345

TRANSFER CASE**Input Shaft**

1996 (Warner 4406)(Booted)	
Seal	4333N
Ball Bearing	211TB
Ndle Bearing (Pilot)	BK3026
1996 (Warner 4406)(w/o Boot)	
Seal	3946
Ball Bearing	211TB
Seal	KWK99187
1996-1990 (Warner 1356)	
Seal	714503
Ball Bearing	110CB
Ndle Bearing (Pilot)	BK3026
1990 (Warner 1345)	
Seal	710062
Repair Sleeve	KWK99175

Front Output Shaft

1996 (Warner 4406)	
Seal	4333N
Ball Bearing	208
1996-1990 (Warner 1356)	
Seal	714503
Ball Bearing	110CB
Ndle Bearing (Pilot)	BK3026
1990 (Warner 1345)	
Seal	710062
Ball Bearing	207
Repair Sleeve	KWK99187

Rear Output Shaft

1996 (Warner 4406, 4416)	
Seal	4503N
Ball Bearing	207
1996-1990 (Warner 1356)(slip yoke)	
Seal	4503N
Ball Bearing	207

¹⁹Opt. Axle Rpr Brg. Replaces O.E. Brg & Seal Ring³⁶Opt. Kit = Brg B2110, Seals 722108 & 722109, &

Mfg./Year	Model & Location	Part No.	Mfg./Year	Model & Location	Part No.
FORD TRUCK - Full Size SUV - Bronco - Full-Size (cont.)					

TRANSFER CASE (cont.)

Rear Output Shaft (cont.)

1996-1990 (Warner)(fixed yoke)	
Seal	4333N
Ball Bearing	207
1990 (Warner 1345)	
Seal	3946
Ball Bearing	207
Repair Sleeve	KWK99187
Ndle Bearing (Pilot)	B2812

Selector Shaft Seal/Man. Shaft

1996-1990 (Warner 1356)	
Seal	330385

3-SPEED AUTOMATIC TRANSMISSION

Torque Converter

1990 (C4, C5, C6)	
Seal	331107N
Repair Sleeve	KWK99199

Rear Seal/Ext. Housing

1990 (C6)(3.066" O.D.)	
Seal	410308

Selector Shaft Seal/Man. Shaft

1990 (C6)	
Seal	7929S

4-SPEED AUTOMATIC TRANSMISSION

Torque Converter

1996-1990 (AODE, E4OD)	
Seal	3404
1993-1990 (AOT, AOD)	
Seal	331107N
Repair Sleeve	KWK99199

Rear Seal/Ext. Housing

1996-1994 (AODE)	
Seal	4765
1996-1990 (E4OD)	
Seal	7300S
Seal Kit	5203 ⁶⁴
1993-1990 (AOT, AOD)(long boot)	
Seal	7692S
Seal Kit	5202 ⁶⁴

Selector Shaft Seal/Man. Shaft

1996-1990	
Seal	7929S

CLUTCH

Pilot Bearing

1996-1990	
Ndle Bearing	FC65662

CLUTCH

Release Bearing

1996-1993 (5 Spd.)(Hyd. piston type)	
Bearing Assy	614169
1992-1990 (5 Spd.)(Hyd. piston type)	
Bearing Assy	614061
1992-1990 (4 Spd.)	
Bearing Assy	614014[2]

4-SPEED MANUAL TRANSMISSION

Input Shaft

1993-1990 (Warner T18)	
Seal	7412S
Ball Bearing	308LTB[2]
Repair Sleeve	KWK99125

Rear Output Shaft

1993-1990 (Warner T18)(28 spline)	
Seal	7692S
Ball Bearing	308LI[2]
Seal Kit	5202 ⁶⁴

Selector Shaft Seal/Man. Shaft

1990	
Seal	313156

5-SPEED MANUAL TRANSMISSION

Transmission Rebuild Kit

1996-1990 (Mazda M5R2)	
Kit	TRK248

Front Input Shaft

1996-1992 (ZF S5 42)	
Seal Viton	713771
Cone/Cup	28580-28521[2]
Repair Sleeve	KWK99139
1996-1990 Mazda	
Seal	223012
Repair Sleeve	KWK99114

Front Input Shaft Pocket

1996-1992 (ZF S5 42)	
Cone	JH13349[2]

Countershaft

1996-1992 (ZF S5 42)	
Cone/Cup	2580-2520[2]

Rear Output Shaft

1996-1992 (ZF S5 42 application)(4WD)	
Seal	225010
Cone/Cup	J28573-28521[2]
1996-1992 (ZF S5 42)(4WD)	
Seal	1217
Cone/Cup	J28573-28521[2]
1996-1992 Mazda	
Seal	710415

⁶⁴Seal & Bushing Kit

Mfg./Year Model & Location Part No. Mfg./Year Model & Location Part No.

FORD TRUCK - Full Size SUV - Bronco - Full-Size (cont.)

DRIVESHAFT SUPPORT

1996-1990 (Spicer 1280 1310)(1.3780"
Brg. I.D.)(slip yoke style)
Ball Bearing 88107[2]
Hanger Bearing Assy HB88107A[2]

CRANKSHAFT FRONT SEAL

6 Cylinder

1992-1990 300/4.9L
Seal (Frt) 2692
Seal (Rr) 2942
Repair Sleeve KWK99187
Harmnc Balancer Slvs 88187

8 Cylinder

1996-1990 351/5.8L
Seal (Frt Entry) 2692
Seal (Rr Entry) 2942
Repair Sleeve KWK99187
Harmnc Balancer Slvs 88187
1996-1990 302/5.0L
Seal (Frt Entry) 2692
Seal (Rr Entry) 2942
Repair Sleeve KWK99187
Harmnc Balancer Slvs 88187

CRANKSHAFT REAR SEAL

6 Cylinder

1992-1990 300/4.9L
Seal Viton 2377
Seal PTFE H/D 5278
Repair Sleeve KWK99372

CRANKSHAFT REAR SEAL

8 Cylinder

1996-1990 302/5.0L From 1/1/83
Seal Viton 3909
Seal PTFE H/D 5277
Repair Sleeve KWK99363
1996-1990 351/5.8L (W) From 7/10/83
Seal Viton 2377
Seal PTFE H/D 5278
Repair Sleeve KWK99372

FORD TRUCK - Full Size SUV - Excursion

FRONT WHEEL

RWD

2005-2000
Seal (Inner) 4160[2]
Set (Inner) SET47[2]
Cone/Cup (Outer) 15101-15245[2]

4WD

2005-2000 (Coarse Thread Wheel Studs)
Hub Unit Bearing 515020[2]
2005-2000 (Fine Thread Wheel Studs)
Hub Unit Bearing SP580205[2]²⁵

REAR WHEEL

RWD

2005-2000
Seal (Inner) 370247A[2]⁸⁶
Cone/Cup (Inner) NP114036-NP064306[2]
Set (Outer) SET38[2]

FRONT AXLE

Steering Knuckle

2004-2000
Seal 710493[2]²⁵

4WD FRONT AXLE

Axle Shaft

2004-2000
Seal (Outer) 710413[2]
Ndl Bearing B2110[2]
2004-2000
Seal (Inner) 710492[2]²⁵

Differential Rebuild Kit

2005-2000 (Dana/Spicer 50)
Kit DRK336A

²⁵New Item, Check For Availability

⁸⁶Use RD247 to install seal number 370247A

Mfg./Year	Model & Location	Part No.	Mfg./Year	Model & Location	Part No.
FORD TRUCK - Full Size SUV - Excursion (cont.)					

4WD FRONT AXLE

Differential

2005-2000 (Dana/Spicer 50)
Cone/Cup JLM104948-LM104911A[2]

Pinion

2005-2000 (Dana/Spicer 50)
Seal 5778
Cone/Cup (Inner) HM88649-HM88610
Cone/Cup (Outer) 02872-02820
Repair Sleeve KWK99155

REAR AXLE

Differential Rebuild Kit

2005-2000 (10.5" R.G.)
Kit DRK317

Differential

2005-2000 (10.5" R.G.)
Cone/Cup 469-453X[2]

Pinion

2005-2000 (10.5" R.G.)
Seal Viton 4278
Cone/Cup (Inner) NP504493-NP949481
Cone/Cup (Outer) HM89443-HM89411
Repair Sleeve KWK99181

TRANSFER CASE REBUILD KIT

2003-2000 (New Process 273)
Kit TCRK271

TRANSFER CASE

Input Shaft

2003-2000 (New Process 273)
Ball Bearing 211TB[2]

Front Output Shaft

2003-2000 (New Process 273)
Ball Bearing 111TB[2]

4-SPEED AUTOMATIC TRANSMISSION

Torque Converter

2003-2000 (4R100)
Seal 3404

Rear Seal/Ext. Housing

2003-2000 (4R100)
Seal 100086

Selector Shaft Seal/Man. Shaft

2005-2000
Seal 7929S

CRANKSHAFT FRONT SEAL

8 Cylinder

2005-2000 330/5.4L
Seal 482041N
Repair Sleeve KWK99187
Harmnc Balancer Slvs 88187
2003-2000 446/7.3 (Diesel)
Seal 5066²⁶

10 Cylinder

2005-2000 415/6.8L
Seal 482041N
Repair Sleeve KWK99187
Harmnc Balancer Slvs 88187

CRANKSHAFT REAR SEAL

8 Cylinder

2005-2000 330/5.4L (SOHC)
Seal Viton 3909
Seal PTFE H/D 5277
Repair Sleeve KWK99363
2003-2000 446/7.3 (Diesel)
Seal 5723

10 Cylinder

2005-2000 415/6.8L
Seal Viton 3909
Seal PTFE H/D 5277
Repair Sleeve KWK99363

²⁶Opt. Kit = 3894V Seal & Sleeve

FORD TRUCK - Full Size SUV - Expedition**FRONT WHEEL****RWD**

2008-2007	
Hub Unit Bearing	SP550211[2] ²⁵
2006-2003 (ABS)	
Hub Unit Bearing	SP550206[2] ²⁵
2002-1997	
Seal (Inner)	4148[2]
Cone/Cup (Inner)	JL69349P-JL69310P[2]
Set (Outer)	SET12FP[2] ⁶⁰

4WD

2008-2007	
Hub Unit Bearing	SP550210[2] ²⁵
2006-2003	
Hub Unit Bearing	SP550202[2]
2002-2000 (ABS)(M14 Bolts)	
Hub Unit Bearing	515031[2]
2000-1997 (ABS)(M12 Bolts)	
Hub Unit Bearing	SP550201[2] ⁴⁰

REAR WHEEL**RWD**

2008-2007	
Hub Unit Bearing	SP550209[2] ²⁵
2006-2003	
Hub Unit Bearing	SP550203[2]
2002-1997	
Seal Viton	100357[2]
Cylindrical Bearing	R1561TV[2]
Bearing & Seal Kit	TF01561R[2] ¹⁹

4WD FRONT AXLE**Axle Shaft**

2008-1997 (8.8" R.G.)(Indep. Frt. Susp.)	
Ndle Bearing (Inner)	HK4012[2]
Ndle Bearing (Outer)	FC66998[2]

Differential Rebuild Kit

2006-1997 (8.8" R.G.)	
Kit	DRK311F

Differential

2006-2004	
Cone/Cup	LM603049-LM603019[2]
2003-1997	
Set	SET36[2]

Pinion

2006-1997	
Seal Viton	3604
Cone/Cup (Inner)	M802048-M802011
Cone/Cup (Outer)	M88048-M88010

REAR AXLE**Axle Shaft**

2008-2002 (8.8" R.G.)(Indep. Rr. Susp.)	
Ndle Bearing	FC66998[2]
Seal	100537[2]

Differential Rebuild Kit

2008-2003 (8.8" R.G.)(Indep. Rr. Susp.)	
Kit	DRK311A ²⁵
2008-2000 (9.75" R.G.)	
Kit	DRK316A
2000-1997 (8.8" R.G.)	
Kit	DRK311
1999-1997 (9.75" R.G.)	
Kit	DRK316

Differential

2008-2003 (8.8" R.G.)(Indep. Rr. Susp.)	
Cone/Cup	LM603049-LM603019[2]
2008-1997 (9.75" R.G.)	
Cone/Cup	NP343847-NP372019[2]
2002-1997 (8.8" R.G.)	
Set	SET36[2]

Pinion

2008-2000 (9.75" R.G.)	
Seal Viton	4278
Cone/Cup (Inner)	NP576375-NP434567
Cone/Cup (Outer)	HM89443-HM89411
2008-1997 (8.8" R.G.)	
Seal Viton	3604
Cone/Cup (Inner)	M802048-M802011
Cone/Cup (Outer)	M88048-M88010
Repair Sleeve	KWK99181
1999-1997 (9.75" R.G.)	
Seal Viton	3604
Cone/Cup (Inner)	NP576375-NP434567
Cone/Cup (Outer)	M88048-M88010

TRANSFER CASE REBUILD KIT

2002-1997 (Warner 4406)	
Kit	TCRK4406

TRANSFER CASE**Input Shaft**

2008-2003 (Warner 4416)	
Seal	3946
Repair Sleeve	KWK99187
2002-1997 (Warner 4406)	
Ball Bearing	211TB
Ndle Bearing (Pilot)	BK3026
Seal (Non-Booted)	3946
Seal (Booted)	4333N
Repair Sleeve	KWK99187

¹⁹Opt. Axle Rpr Brg. Replaces O.E. Brg & Seal²⁵New Item, Check For Availability⁴⁰5 Stud.⁶⁰O.E. Polymer Cage, Performance

Mfg./Year	Model & Location	Part No.	Mfg./Year	Model & Location	Part No.
-----------	------------------	----------	-----------	------------------	----------

FORD TRUCK - Full Size SUV - Expedition (cont.)

TRANSFER CASE

Front Output Shaft

2008-1997	(Warner)	
Seal	4333N
Ball Bearing	208[2]

Rear Output Shaft

2002-1997	(Warner 4406, 4416)	
Seal	4503N
Ball Bearing	207[2]

Selector Shaft Seal/Man. Shaft

2002-1997	(Warner)	
Seal	330385

4-SPEED AUTOMATIC TRANSMISSION

Torque Converter

2003-1997	(E4OD, 4R100)	
Seal	3404

Rear Seal/Ext. Housing

2007-1999	(4R100, E4OD)(1.88)	
Seal	100086
2007-1997	(4R100, E4OD)(1.68)	
Seal	7300S

Selector Shaft Seal/Man. Shaft

2006-1997		
Seal	7929S

CRANKSHAFT FRONT SEAL

8 Cylinder

2008-1997	281/4.6L, 330/5.4L	
Seal	482041N
Repair Sleeve	KWK99187
Harmnc Balancer Slvs	88187

CRANKSHAFT REAR SEAL

8 Cylinder

2008-1997	330/5.4L	
Seal Viton	3909
Seal PTFE H/D	5277
Repair Sleeve	KWK99362
2004-1997	281/4.6L	
Seal Viton	3909
Seal PTFE H/D	5277
Repair Sleeve	KWK99363

FORD TRUCK - 1/2 TON - Econoline, E150, F100, F150

FRONT WHEEL

RWD

2009	F150 (Base Pkg)(6 Stud)(From 7/23/08)	
Hub Unit Bearing	SP550216[2] ²⁵
2009	F150 (HD)(7 Stud)(From 7/23/08)	
Hub Unit Bearing	SP550215[2] ²⁵
2009-1990	E150	
Seal (Inner)	4148[2]
Set (Inner)	SET13[2]
Set (Outer)	SET12F[2] ⁵⁹
2008-2004	F150	
Set	SET930[2] ²⁵
2004-1997	F150	
Seal (Inner)	4148[2]
Set (Outer)	SET12FP[2] ⁶⁰
Set (Inner)	SET11[2]

FRONT WHEEL (cont.)

RWD (cont.)

1996-1990	F150	
Seal (Inner)	4148[2]
Set (Inner)	SET13[2]
Set (Outer)	SET12F[2] ⁵⁹

4WD

2009	F150 (Base)(6 Stud)(From 7/23/08)	
Hub Unit Bearing	SP550214[2] ²⁵
2009	F150 (HD)(7 Stud)(From 7/23/08)	
Hub Unit Bearing	SP550215[2] ²⁵
2008-2006	F150 (Base)(6 Stud)(From 12/5/05 to 7/23/08)	
Hub Unit Bearing	SP550207[2] ⁷⁸

²⁵New Item, Check For Availability

⁵⁹O.E. Polymer Cage

⁶⁰O.E. Polymer Cage, Performance

⁷⁸6 Stud, New Item.

Mfg./Year	Model & Location	Part No.	Mfg./Year	Model & Location	Part No.
FORD TRUCK - 1/2 TON - Econoline, E150, F100, F150 (cont.)					

FRONT WHEEL (cont.)**4WD (cont.)**

2008-2005	F150 (HD)(7 Stud)(From 2/28/05 to 7/23/08)	
	Hub Unit Bearing	SP550208[2] ⁸²
2005-2004	F150 (Base)(6 Stud)(From 6/2/03 to 11/29/04)	
	Hub Unit Bearing	SP550212[2] ²⁵
2005-2004	F150 (HD)(7 Stud)(From 6/2/03 to 11/29/04)	
	Hub Unit Bearing	SP550213[2] ²⁵
2004-2001	F150 (4 Whl. ABS)(5 Stud)	
	Hub Unit Bearing	515029[2]
2004-2001	F150 (Rr. Whl. ABS)(5 Stud)	
	Hub Unit Bearing	515028[2]
2004-2000	F150 (4 Whl. ABS)(7 Stud)	
	Hub Unit Bearing	515030[2]
2004-2000	F150 (Rr. Whl. ABS)(7 Stud)	
	Hub Unit Bearing	515022[2]
2000	F150 (4 Whl. ABS)(5 Stud)(M14 Stud)	
	Hub Unit Bearing	515029[2]
2000	F150 (Rr. Whl. ABS)(5 Stud)(M14 Stud)	
	Hub Unit Bearing	515028[2]
2000-1997	F150 (4 Whl. ABS)(5 Stud)(M12 Stud)	
	Hub Unit Bearing	SP550200[2] ⁴⁰
2000-1997	F150 (Rr. Whl. ABS)(5 Stud)(M12 Stud)	
	Hub Unit Bearing	515017[2]
1996-1995		
	Seal (Inner)	710430[2]
	Set (Inner)	SET37[2]
	Set (Outer)	SET45[2]
1994-1990	(From 6/1/88)	
	Seal (Inner)	4250[2]
	Set (Inner)	SET37[2]
	Set (Outer)	SET45[2]

REAR WHEEL**RWD**

2008-2004	F150	
	Seal Viton	100357[2]
	Cylindrical Bearing	R1561TV[2]
	Bearing & Seal Kit	TF01561R[2] ¹⁹
2008-1990	E100, E150	
	Seal	8835S[2]
	Cylindrical Bearing	6408[2]
	Bearing & Seal Kit	TRP1559TV[2] ¹⁹
2004	F150 Heritage (9.75", 10.25" R.G.)	
	Seal Viton	100357[2]
	Cylindrical Bearing	R1561TV[2]
	Bearing & Seal Kit	TF01561R[2] ¹⁹
2004	F150 Heritage, SVT Lightning (8.8" R.G.)	
	Seal	8835S[2]
	Seal Viton	100357[2]
	Cylindrical Bearing	6408[2]
	Bearing & Seal Kit	TRP1559TV[2] ¹⁹

REAR WHEEL (cont.)**RWD (cont.)**

2004-1990	F100, F150 (8.8" R.G.)(Sterling Axle)	
	Seal	8835S[2]
	Bearing & Seal Kit	TRP1559TV[2] ¹⁹
	Cylindrical Bearing	6408[2]
2003-1998	F150 (8.8" R.G.)	
	Seal	8835S[2]
	Cylindrical Bearing	6408[2]
	Bearing & Seal Kit	TRP1559TV[2] ¹⁹
2003-1998	F150 (9.75" R.G.)	
	Seal Viton	100357[2]
	Cylindrical Bearing	R1561TV[2]
	Bearing & Seal Kit	TF01561R[2] ¹⁹

4WD FRONT AXLE**Axle Shaft**

2008-1997	(8.8" R.G.)(Indep. Frt. Susp.)	
	Ndle Bearing (Inner)	HK4012[2]
	Ndle Bearing (Outer)	FC66998[2]
1996-1990	(Dana/Spicer 44 IFS axle)	
	Seal (LH)	710043
	Seal (RH)	470672
	Cylindrical Bearing (RH)	5707[2]

Differential Rebuild Kit

2006-1997	(8.8" R.G.)	
	Kit	DRK311F
1997-1990	(Dana/Spicer 44 Axle)	
	Kit	DRK339B

Differential

2006-2003	(8.8" R.G.)	
	Cone/Cup	LM603049-LM603019[2]
2003-1997	(8.8" R.G.)	
	Set	SET36[2]
1997-1990	(Dana/Spicer 44 Axle)	
	Cone/Cup	25590-25523[2]

Pinion

2008-1997	(8.8" R.G.)	
	Seal Viton	3604
	Cone/Cup (Inner)	M802048-M802011
	Cone/Cup (Outer)	M88048-M88010
	Repair Sleeve	KWK99181
1997-1990	(Dana/Spicer 44 Axle)	
	Seal	5778
	Cone/Cup (Inner)	HM88649-HM88610
	Cone/Cup (Outer)	02872-02820

Spindle Kit

1997-1990		
	Bearing & Seal Kit	SBK4[2] ³⁶

Spindle

2002-1997	(8.8" R.G.)	
	Ndle Bearing	HK1816[2]

¹⁹Opt. Axle Rpr Brg. Replaces O.E. Brg & Seal Brg B2110, Seals 722108 & 722109, & Ring

²⁵New Item, Check For Availability
⁴⁰5 Stud. ⁸²7 Stud, New Item.

³⁶Opt. Kit =

Mfg./Year	Model & Location	Part No.	Mfg./Year	Model & Location	Part No.
FORD TRUCK - 1/2 TON - Econoline, E150, F100, F150 (cont.)					

4WD FRONT AXLE (cont.)

Spindle (cont.)

1996-1993 (Dana/Spicer 28IFS, 35IFS axle)	
Seal (Inner)	710453[2]
Ndle Bearing (Inner)	B2110
Seal (Outer)	722108[2]
Ndle Bearing Thrust (Outer)	NTA1625[2]
1992-1990	
Seal (Inner)	722108[2]
Ndle Bearing (Inner)	B2110[2]
Seal (Outer)	722109[2]

REAR AXLE

Axle Shaft

2002 (8.8" R.G.)	
Ndle Bearing	FC66998[2]

Differential Rebuild Kit

2007-1990 (8.8" R.G.)	
Kit	DRK311
2006-2000 (9.75" R.G.)	
Kit	DRK316A
1999-1997 (9.75" R.G.)	
Kit	DRK316

Differential

2008-2004 (10.25" R.G.)	
Cone/Cup	469-453X[2]
2008-1997 (9.75" R.G.)	
Cone/Cup	NP343847-NP372019[2]
2008-1990 (8.8" R.G.)	
Set	SET36[2]

Pinion

2008-2000 (9.75" R.G.)	
Seal Viton	4278
Cone/Cup (Inner)	NP576375-NP434567
Cone/Cup (Outer)	HM89443-HM89411
2008-1997 (8.8" R.G.)	
Seal Viton	3604
Cone/Cup (Inner)	M802048-M802011
Cone/Cup (Outer)	M88048-M88010
2006-2004 (10.25" R.G.)	
Seal Viton	4278
Cone/Cup (Inner)	NP504493-NP949481
Cone/Cup (Outer)	HM89443-HM89411
2004 (8.8" R.G.)(Non-Locking)	
Seal Viton	3604
Cone/Cup (Inner)	NP576375-NP434567
Cone/Cup (Outer)	M88048-M88010
1999-1997 (9.75" R.G.)	
Seal Viton	3604
Cone/Cup (Inner)	NP576375-NP434567
Cone/Cup (Outer)	M88048-M88010
1999-1990 (8.8" R.G.)	
Seal Viton	3604
Cone/Cup (Inner)	M802048-M802011
Cone/Cup (Outer)	M88048-M88010

TRANSFER CASE REBUILD KIT

2002-1996 (Warner 4406)	
Kit	TCRK4406
1997-1990 (Warner 1356)	
Kit	TCRK1356
1991-1990 (Warner 1345)	
Kit	TCRK1345

TRANSFER CASE

Input Shaft

2008-2003 (Warner 4416)	
Seal	3946
Ball Bearing	211TB
Repair Sleeve	KWK99187
2007-1996 (Warner 4406)(Booted)	
Seal	4333N
Ball Bearing	211TB
Ndle Bearing (Pilot)	BK3026
2007-1996 (Warner 4406)(w/o Boot)	
Ball Bearing	211TB
Ndle Bearing (Pilot)	BK3026
Seal	3946
1995-1990 (Warner 1356)	
Seal	714503
Ball Bearing	110CB
Ndle Bearing (Pilot)	BK3026
1990 (Warner 1345)	
Seal	710062
Repair Sleeve	KWK99175

Front Output Shaft

2008-2003 (Warner 4416)	
Seal	4503N
Ball Bearing (Inner)	107WB
Seal (Outer)	4333N
Ball Bearing (Outer)	208
2007-1996 (Warner 4406)	
Seal	4333N
Ball Bearing	208
1996-1990 (Warner 1356)	
Seal	714503
Ball Bearing	110CB
Ndle Bearing (Pilot)	BK3026
1990 (Warner 1345)	
Seal	710062
Ball Bearing	207
Repair Sleeve	KWK99187
Ndle Bearing (Pilot)	B2012

Rear Output Shaft

2008-2003 (Warner 4416)	
Seal	4503N
Ball Bearing (Inner)	307TB
Ball Bearing (Outer)	111TB
2007-1996 (Warner 4406)	
Seal	4503N
Ball Bearing	207
Ndle Bearing Thrust	NTA2233
1996-1990 (Warner 1356)(fixed yoke)	
Seal	4333N
Ball Bearing	207

Mfg./Year	Model & Location	Part No.	Mfg./Year	Model & Location	Part No.
FORD TRUCK - 1/2 TON - Econoline, E150, F100, F150 (cont.)					

TRANSFER CASE (cont.)**Rear Output Shaft (cont.)**

1996-1990 (Warner 1356)(slip yoke)	
Seal	4503N
Ball Bearing	207
1990 (Warner 1345)	
Seal	3946
Ball Bearing	207
Repair Sleeve	KWK99187
Ndle Bearing (Pilot)	B2812

Selector Shaft Seal/Man. Shaft

2008-1990 (Warner)	
Seal	330385

3-SPEED AUTOMATIC TRANSMISSION**Torque Converter**

1990 (C4, C5, C6)	
Seal	331107N
Repair Sleeve	KWK99199

Rear Seal/Ext. Housing

1990 (C6)	
Seal	410308

Selector Shaft Seal/Man. Shaft

1990 (C6)	
Seal	7929S

4-SPEED AUTOMATIC TRANSMISSION**Torque Converter**

2002-1990 (AODE E, E4OD, 4R70W, AODEW)	
Seal	3404
1993-1990 (AOT, AOD)	
Seal	331107N
Repair Sleeve	KWK99199

Rear Seal/Ext. Housing

2007-1999 (4R100, E4OD)(1.88)	
Seal	100086
2002-1994 (4R70W, AODEE, AODEW)	
Seal (Booted)	4765
Seal (Non-Booted)	4764
1999-1990 (E4OD)	
Seal	7300S
Seal Kit	5203 ⁶⁴
1993-1990 (AOT, AOD)(long boot)	
Seal	7692S
Seal Kit	5202 ⁶⁴

Selector Shaft Seal/Man. Shaft

2008-1990	
Seal	7929S

5-SPEED AUTOMATIC TRANSMISSION**Selector Shaft Seal/Man. Shaft**

2008-2004	
Seal	7929S

CLUTCH - 6 CYLINDER**Pilot Bearing**

2002-1990 170/2.8L, 240/3.9L, 232/3.8L, 265/4.2L, 300/4.9L	
Ndle Bearing	FC65662

CLUTCH - 8 CYLINDER**Pilot Bearing**

2002-1990 281/4.6L, 302/5.0L, 351/5.8L (M)(W)	
Ndle Bearing	FC65662

CLUTCH**Release Bearing**

1999-1993 (5 Spd.)(Hyd. piston type)	
Bearing Assy	614169
1992-1990 (5 Spd.)(Hyd. piston type)	
Bearing Assy	614061
1992-1990 (4 Spd.)(cable mechanism)	
Bearing Assy	614014

4-SPEED MANUAL TRANSMISSION**Input Shaft**

1993-1990 (Warner T18)	
Seal	7412S
Ball Bearing	308LTB[2]
Repair Sleeve	KWK99125
1990 (Tremec)	
Seal	3638
Ball Bearing	308LTB[2]
Repair Sleeve	KWK99112

Rear Output Shaft

1993-1990 (Warner T18)(28 spline)	
Seal	7692S
Ball Bearing	308LI[2]
Seal Kit	5202 ⁶⁴
1990 (Tremec)(2nd Design)	
Seal	7692S
Ball Bearing	308L[2]
Seal Kit	5202 ⁶⁴

Selector Shaft Seal/Man. Shaft

1990 (Tremec)	
Seal	313156

5-SPEED MANUAL TRANSMISSION**Transmission Rebuild Kit**

2001-1990 (Mazda M5R2)	
Kit	TRK248

⁶⁴Seal & Bushing Kit

Mfg./Year Model & Location Part No. Mfg./Year Model & Location Part No.

FORD TRUCK - 1/2 TON - Econoline, E150, F100, F150 (cont.)

5-SPEED MANUAL TRANSMISSION

Front Input Shaft

- 2004-1990 (Mazda M5R2)
 - Seal 223012
 - Repair Sleeve KWK99114
- 2004-1990 (ZF S5 42)
 - Seal Viton 713771
 - Cone/Cup 28580-28521[2]
 - Repair Sleeve KWK99139

Front Input Shaft Pocket

- 2000-1990 (ZF S5 42)
 - Cone JH13349[2]

Countershaft

- 2004-1996 Mazda
 - Cylindrical Bearing (Center) MR1207EL[2]
 - Ball Bearing (Rr) 304WB[2]
- 2000-1990 (ZF S5 42)
 - Cone/Cup 2580-2520[2]

Rear Output Shaft

- 2001-1990 Mazda
 - Seal 710415
- 2000-1990 (ZF S5 42)(2WD)
 - Seal 225010
 - Cone/Cup J28573-28521[2]
- 2000-1990 (ZF S5 42)(4WD)
 - Seal 1217
 - Cone/Cup J28573-28521[2]

A/C COMPRESSOR

- 2002-1990 (Nippondenso FX 15)(Tecumseh, York)(Axial)
 - Ball Bearing 5106WCC[2]

DRIVESHAFT SUPPORT

- 1996-1993 F150
 - Ball Bearing 88107[2]
 - Hanger Bearing Assy HB88107A[2]
- 1992-1990 (Spicer 1280, 1310)(1.3780" Brg. I.D.)
 - Ball Bearing 88107[2]
 - Hanger Bearing Assy HB88107A[2]

POWER STEERING

Pump Shaft

- 1998-1990 (Ford pump)
 - Seal 8773S
- 1997-1990 (Saginaw pump)
 - Seal 7013S

MANUAL STEERING

Worm Shaft

- 1998-1990
 - Seal 221922

CRANKSHAFT FRONT SEAL

6 Cylinder

- 2008-1990 232/3.8L, 256/4.2L, 300/4.9L
 - Seal (Frt Entry) 2692
 - Seal (Rr Entry) 2942
 - Repair Sleeve KWK99187
 - Harmnc Balancer Slvs 88187

8 Cylinder

- 2008-1997 281/4.6L, 330/5.4L
 - Seal 482041N
 - Repair Sleeve KWK99187
 - Harmnc Balancer Slvs 88187
- 1996-1990 255/4.2L, 302/5.0L, 332/5.4L, 351/5.8L, 352/5.8L, 360/5.9L, 390/6.4L, 400/6.6L, 460/7.5L
 - Seal (Frt Entry) 2692
 - Seal (Rr Entry) 2942
 - Repair Sleeve KWK99187
 - Harmnc Balancer Slvs 88187

CRANKSHAFT REAR SEAL

6 Cylinder

- 2008-1997 256/4.2L
 - Seal Viton 3909
 - Seal PTFE H/D 5277
 - Repair Sleeve KWK99362
- 1996-1990 240/3.9, 300/4.9L
 - Seal Viton 2377
 - Seal PTFE H/D 5278
 - Repair Sleeve KWK99372

8 Cylinder

- 2008-1990 281/4.6L, 302/5.0L, 330/5.4L
 - Seal Viton 3909
 - Seal PTFE H/D 5277
 - Repair Sleeve KWK99362
- 2001-1990 302/5.0L From 12/82
 - Seal Viton 3909
 - Seal PTFE H/D 5277
 - Repair Sleeve KWK99363
- 1996-1990 351/5.8L (W) From 7/10/83
 - Seal Viton 2377
 - Seal PTFE H/D 5278
 - Repair Sleeve KWK99372

Mfg./Year	Model & Location	Part No.	Mfg./Year	Model & Location	Part No.
FORD TRUCK - 3/4 TON - Econoline, E250, F250					

FRONT WHEEL**RWD**

2009-2005	(Mono Beam Axle)	
Hub Unit Bearing	SP940203[2] ²⁵
2009-1999	(Twin I-Beam Axle)	
Seal (Inner)	4160[2]
Set (Inner)	SET47[2]
Cone/Cup (Outer)	15101-15245[2]
2009-1990	(Econoline)(From 11/4/80)	
Seal (Inner)	4160[2]
Set (Inner)	SET47[2]
Cone/Cup (Outer)	15101-15245[2]
2004-1999	(Mono Beam Axle)	
Hub Unit Bearing	HA590233[2] ²⁵
1999-1990	(L/D)(GVW Under 8,500 lb.)	
Seal (Inner)	4148[2]
Cone/Cup (Inner)	JL69349P-JL69310P[2]
Set (Outer)	SET12FP[2] ⁶⁰
Cone/Cup (Outer)	LM12749FP-LM12710P[2]
1998-1990	(H/D)(GVW Over 8,500 lb.)	
Seal (Inner)	4160[2]
Set (Inner)	SET47[2]
Cone/Cup (Outer)	15101-15245[2]

4WD

2009-2005	(SRW)(ABS)	
Hub Unit Bearing	SP940200[2] ²⁵
2004-1999	(SRW)(4 Whl. ABS)(Coarse Thread Studs)(From 3/22/99)	
Hub Unit Bearing	515020[2]
2004-1999	(SRW)(4 Whl. ABS)(Fine Thread Studs)(From 3/22/99)	
Hub Unit Bearing	SP580205[2] ²⁵
2004-1999	(SRW)(Rr. Whl. ABS)(From 3/22/99)	
Hub Unit Bearing	515021[2]
1999	(DRW)(4 Whl. ABS)(Coarse Thread Studs)(Thru 3/21/99)	
Hub Unit Bearing	HA590425[2]
1999	(SRW)(4 Whl. ABS)(Coarse Thread Studs)(Thru 3/21/99)	
Hub Unit Bearing	SP580204[2] ²⁵
1999	(SRW)(Rr. Whl. ABS)(Coarse Thread Studs)(Thru 3/21/99)	
Hub Unit Bearing	HA590132[2] ²⁵
1999-1997	(L/D)(4 Whl. ABS)(Thru 3/21/99)	
Hub Unit Bearing	515030[2]
1999-1997	(L/D)(Rr. Whl. ABS)(Thru 3/21/99)	
Hub Unit Bearing	515022[2]
1998-1995	(GVW Over 8,500 lb.)(Dana/Spicer 44 IFS H/D)	
Seal (Inner)	710430[2]
Cone/Cup (Inner)	LM104949-JLM104910[2]
Set (Outer)	SET45[2]
1998-1990	(Dana/Spicer 50, 60 Ser. Axle)	
Seal (Inner)	415960[2]
Cone/Cup (Inner)	387A-382A[2]
Set (Outer)	SET38[2]

FRONT WHEEL (cont.)**4WD (cont.)**

1994-1990	(Dana/Spicer 44 Axle)	
Seal (Inner)	4250[2]
Cone/Cup (Inner)	LM104949-JLM104910[2]
Set (Outer)	SET45[2]

REAR WHEEL**RWD**

2008-1999	(10.25" R.G.)	
Seal (Inner)	370247A[2] ⁸⁶
Cone/Cup (Inner)	NP114036-NPO64306[2]
Set (Outer)	SET38[2]
2008-1990	(Spicer 60, 70 Axle)(Full Floating Axle)	
Seal (Inner) (Thru 12/2004)	9864S[2]
Cone/Cup (Inner)	387AS-382A[2]
Set (Outer)	SET38[2]
2008-1990	(Econoline)(Semi Floating Axle)(10.25" R.G.)	
Seal	710067[2]
Cylindrical Bearing	R1561TV[2]
Bearing & Seal Kit	TF01561R[2] ¹⁹
1998	(Full Float Axle)(10.25" R.G.)(From 1/1/98)	
Seal (Inner)	370047A[2] ⁵⁷
Cone/Cup (Inner)	3992-3920[2]
Set (Outer)	SET38[2]
1998-1990	(Full Float Axle)(10.25" R.G.)	
Seal (Inner)	370047A[2] ⁵⁷
Cone/Cup (Inner)	3994-3920[2]
Set (Outer)	SET38[2]
1998-1990	(Spicer 60, 70 Axle)(Full Floating Axle)	
Seal (Inner)	9864S[2]
Cone/Cup (Inner)	387AS-382A[2]
Set (Outer)	SET38[2]
1998-1990	(Semi Floating Axle)(10.25" R.G.)	
Seal	710067[2]
Cylindrical Bearing	R1561TV[2]
Bearing & Seal Kit	TF01561R[2] ¹⁹
1997-1994	(Full Floating Axle)(10.25" R.G.)(From 4/1/94)	
Seal (Inner)	370047A[2] ⁵⁷
Cone/Cup (Inner)	3992-3920[2]
Set (Outer)	SET38[2]
1994-1990	(Full Floating Axle)(10.25" R.G.)(Thru 3/31/94)	
Seal (Inner)	370047A[2] ⁵⁷
Cone/Cup (Inner)	3994-3920[2]
Set (Outer)	SET38[2]

FRONT AXLE**Spindle Kit**

1998-1990	(Spicer 44 IFS)(2nd Design)	
Bearing & Seal Kit	SBK4[2] ³⁶
1995-1993	(Spicer 50.5)	
Bearing & Seal Kit	SBK5[2] ³⁷
1992-1990	(Spicer 50.5)	
Bearing & Seal Kit	SBK3[2] ³⁵

¹⁹Opt. Axle Rpr Brg. Replaces O.E. Brg & Seal ²⁵New Item, Check For Availability ³⁵Opt. Kit = Brg B2414, Seals 710044 & 710045 ³⁶Opt. Kit = Brg B2110, Seals 722108 & 722109, & Ring
³⁷Opt. Kit = Brg B2414, Seals 710414 & 710413 ⁵⁷Oil Bath Seal ⁶⁰O.E. Polymer Cage, Performance ⁸⁶Use RD247 to install seal number 370247A

Mfg./Year	Model & Location	Part No.	Mfg./Year	Model & Location	Part No.
-----------	------------------	----------	-----------	------------------	----------

FORD TRUCK - 3/4 TON - Econoline, E250, F250 (cont.)

FRONT AXLE

Spindle

2004-1999	
Seal (Inner)	710413[2]
Ndle Bearing (Inner)	B2110[2]
1998-1993 (Spicer 50.5)	
Seal (Inner)	710413
Ndle Bearing (Inner)	B2414[2]
Seal (Outer)	710414
1992-1990 (Spicer 50.5)	
Seal (Inner)	710044
Ndle Bearing (Inner)	B2414[2]
Seal (Outer)	710045

4WD FRONT AXLE

Axle Shaft

2008-1999	
Seal (Inner)	710492[2] ²⁵
2004-1999	
Seal (Outer)	710413[2]
Ndle Bearing	B2110[2]
1997-1990 (Dana/Spicer 44 Ser., 50 Ser. axle)	
Seal (LH)	710043[2]
Seal (RH)	470672[2]
Cylindrical Bearing (RH)	5707[2]

Differential Rebuild Kit

2006-2002 (Dana/Spicer 60 Ser. Axle)	
Kit	DRK331A
2004-1998 (Dana/Spicer 50 Ser. Axle)	
Kit	DRK336A
1997-1990 (Dana/Spicer 50 Ser. Axle)	
Kit	DRK336
1997-1990 (Dana/Spicer 44 Axle)	
Kit	DRK339B

Differential

2006-2002 (Dana/Spicer 60 Axle)	
Cone/Cup	387A-382S[2]
2005-1996 (Dana/Spicer 50 Ser. Axle)	
Cone/Cup	JLM104948-LM104911A[2]
1998-1990 (Dana/Spicer 44 Axle)	
Cone/Cup	25590-25523[2]
1995-1990 (Dana/Spicer 50 Ser. Axle)	
Cone/Cup	JLM104948-LM104911A[2]

Pinion

2007-2002 (Dana/Spicer 60 Axle)	
Seal	100712V
Cone/Cup (Inner)	HM803146-HM803110
Cone/Cup (Outer)	HM88542-HM88510
2004-1999 (Dana/Spicer 50 Ser. Axle)	
Seal	2506
Cone/Cup (Inner)	HM88649-HM88610
Cone/Cup (Outer)	02872-02820

4WD FRONT AXLE (cont.)

Pinion (cont.)

1998-1990	
Seal (All)	5778
Cone/Cup (Inner)	
(Dana/Spicer 44 Axle)	31594-31520
Cone/Cup (Inner)	
(Dana/Spicer 50)	HM88649-HM88610
Cone/Cup (Outer) (All)	02872-02820

Spindle Kit

1998-1990 (Dana/Spicer 44 Axle)	
Bearing & Seal Kit	SBK4[2] ³⁶
1998-1990 (Dana/Spicer 50 Ser. Axle)	
Bearing & Seal Kit	SBK3[2] ³⁵

Spindle

1998-1990 (Dana/Spicer 50 Ser. Axle)	
Seal (Inner)	710044[2]
Ndle Bearing (Inner)	B2414[2]
Seal (Outer)	710045[2]
1998-1990 (Dana/Spicer 44 Ser. axle from Ch. #B50000)	
Seal (Inner)	722108[2]
Ndle Bearing (Inner)	B2110[2]
Seal (Outer)	722109[2]

Steering Knuckle

2004-1999	
Seal	710493[2] ²⁵
1997-1990 (Dana/Spicer 50 Ser. Axle)	
Seal	710304[2]
Cone/Cup	23100-23256[2]

REAR AXLE

Differential Rebuild Kit

2007-1998 (Spicer 60-1 9.75 RG)	
Kit	DRK331B
2006-1999 (10.5" R.G.)	
Kit	DRK317
1998-1990 (10.25" R.G.)	
Kit	DRK314
1998-1990 (Dana/Spicer 60, 61 Ser. Axles)	
Kit	DRK331

Differential

2006-1990 (10.25", 10,5" R.G.)	
Cone/Cup	469-453X[2]
2005-2004 (Spicer 60 Axle)	
Cone/Cup	NP197868-NP802507[2]
1999 (Dana/Spicer 60-1U Axle)	
Cone/Cup	NP197868-NP802507[2]
1998-1990 (Dana/Spicer 60, 61, 70 Ser. Axles)	
Cone/Cup	387A-382S[2]

²⁵New Item, Check For Availability

³⁵Opt. Kit = Brg B2414, Seals 710044 & 710045

³⁶Opt.

Kit = Brg B2110, Seals 722108 & 722109, & Ring

FORD TRUCK - 3/4 TON - Econoline, E250, F250 (cont.)**REAR AXLE****Pinion**

2008-2007	(10.5" R.G.)	
Seal Viton	4278
Cone/Cup (Inner) NP761271-NP998236	
Cone/Cup (Outer) HM89443-HM89411	
2008-1990	(Dana/Spicer 60-1U Axle)	
Seal Viton	719316
Cone/Cup (Inner) HM803146-HM803110	
Cone/Cup (Outer) HM88542-HM88510	
2006-1999	(10.5" R.G.)	
Seal Viton	4278
Cone/Cup (Inner) NP504493-NP949481	
Cone/Cup (Outer) HM89443-HM89411	
Repair Sleeve	KWK99181
2005-2004	(Visteon 9.75" R.G.)	
Seal Viton	4278
Cone/Cup (Outer) HM89443-HM89411	
1998	(10.5" R.G.)(Prod. From 1/98 On)	
Seal Viton	4278
Cone/Cup (Inner) HM807044-HM807010	
Cone/Cup (Outer) HM89443-HM89411	

TRANSFER CASE REBUILD KIT

1998-1990	(Warner 1356)	
Kit	TCRK1356
1991-1990	(Warner 1345)	
Kit	TCRK1345

TRANSFER CASE**Input Shaft**

2002-1999	(New Process)	
Ball Bearing	211TB[2]
1999-1996	(Warner 4406, 4407)	
Seal	4333N
Ball Bearing	211TB
Ndle Bearing (Pilot)	BK3026
1998-1996	(Warner 4406)(w/o Boot)	
Seal	3946
Ball Bearing	211TB
Repair Sleeve	KWK99187
1998-1990	(Warner 1356)	
Seal	714503
Ball Bearing	110CB
Ndle Bearing (Pilot)	BK3026
1990	(Warner 1345)	
Seal	710062
Repair Sleeve	KWK99175

Front Output Shaft

2008-1999	(New Process 271, 273)	
Ball Bearing	111TB
Ndle Bearing (Pilot)	J2416
1999-1996	(Warner 4407)	
Ball Bearing (Inner)	207
Seal (Outer)	4333N
Ball Bearing (Outer)	208
Ndle Bearing (Pilot)	B2012
1998-1996	(Warner 4406)	
Seal	4333N
Ball Bearing	208

TRANSFER CASE (cont.)**Front Output Shaft (cont.)**

1998-1990	(Warner 1356)	
Seal	714503
Ball Bearing	207
Ndle Bearing (Pilot)	B2012
1990	(Warner 1345)	
Seal	3946
Ball Bearing	207
Repair Sleeve	KWK99187
Ndle Bearing (Pilot)	B2012

Rear Output Shaft

1999-1996	(Warner 4407)	
Seal	4503N
Ball Bearing	308WB
Ndle Bearing Thrust	NTA2233
1998-1996	(Warner 4406)	
Seal	4503N
Ball Bearing	207
Ndle Bearing Thrust	NTA2233
1998-1990	(Warner 1356)(fixed yoke)	
Seal	4333N
Ball Bearing	207
1998-1990	(Warner 1356)(slip yoke)	
Seal	4503N
Ball Bearing	207
Ndle Bearing Thrust	NTA2233
1990	(Warner 1345)	
Seal	3946
Ball Bearing	207
Repair Sleeve	KWK99187
Ndle Bearing (Pilot)	B2812

Intermediate Shaft

1999-1996	(Warner 4407)	
Ball Bearing	210S[2]

Oil Pump Housing

2008-1999	(New Process 271, 273)	
Seal	341022
Repair Sleeve	KWK99225

Selector Shaft Seal/Man. Shaft

1999-1990	(Warner)	
Seal	330385
Repair Sleeve	KWK99225

3-SPEED AUTOMATIC TRANSMISSION**Torque Converter**

1990	(C4, C5, C6)	
Seal	331107N
Repair Sleeve	KWK99199

Mfg./Year	Model & Location	Part No.	Mfg./Year	Model & Location	Part No.
FORD TRUCK - 3/4 TON - Econoline, E250, F250 (cont.)					

3-SPEED AUTOMATIC TRANSMISSION

Rear Seal/Ext. Housing

1990 (C6)	
Seal	410308

Selector Shaft Seal/Man. Shaft

1990 (C6)	
Seal	7929S

4-SPEED AUTOMATIC TRANSMISSION

Torque Converter

2002-1990 (4R70W, AODEW, E4OD)	
Seal	3404
1993-1990 (AOT, AOD)	
Seal	331107N
Repair Sleeve	KWK99199

Rear Seal/Ext. Housing

2002-1994 (4R70W, AODE)	
Seal	4765
2000-1990 (E4OD)	
Seal	7300S
Seal Kit	5203 ⁶⁴
1993-1990 (AOT, AOD)(long boot)	
Seal	7692S
Seal Kit	5202 ⁶⁴

Selector Shaft Seal/Man. Shaft

2008-1990	
Seal	7929S

5-SPEED AUTOMATIC TRANSMISSION

Torque Converter

2008-2005 (5R110W) Torqshift	
Seal	710485

Selector Shaft Seal/Man. Shaft

2008-2005	
Seal	7929S

CLUTCH - 6 CYLINDER

Pilot Bearing

1996-1990 6 Cyl. 300 (4.9)	
Ndle Bearing	FC65662

CLUTCH

Pilot Bearing

2002-1990 8 Cyl. 444 (7.3)(Diesel)	
Ndle Bearing	FC65662
1997-1990 8 Cyl. 460 (7.5)	
Ndle Bearing	FC66067
1997-1990 8 Cyl. 302 (5.0)	
Ndle Bearing	FC65662
1997-1990 8 Cyl. 351 (5.8)	
Ndle Bearing	FC65662

CLUTCH

Release Bearing

1998-1993 8 Cyl. 302 (5.0)(5 Spd.)(Hyd. Mechanism)	
Bearing Assy	614169
1998-1993 8 Cyl. 351 (5.8)(5 Spd.)(Hyd. Mechanism)	
Bearing Assy	614169
1997-1990 8 Cyl. 444 (7.3)(Diesel)	
Bearing Assy	614062
1997-1990 8 Cyl. 420 (6.9)(Diesel)(5 Spd.)	
Bearing Assy	614062
1997-1990 8 Cyl. 460 (7.5)(5 Spd.)	
Bearing Assy	614062
1993-1990 6 Cyl. 300 (4.9)(4 Spd.)(mechanical mechanism)	
Bearing Assy	614014
1993-1990 8 Cyl. 302 (5.0)(4 Spd.)(mechanical mechanism)	
Bearing Assy	614014
1993-1990 8 Cyl. 351 (5.8)(4 Spd.)(mechanical mechanism)	
Bearing Assy	614014
1993-1990 8 Cyl. 460 (7.5)(4 Spd.)	
Bearing Assy	614014
1992-1990 8 Cyl. 302 (5.0)(5 Spd.)(Hyd. Mechanism)	
Bearing Assy	614061
1992-1990 8 Cyl. 351 (5.8)(5 Spd.)(Hyd. Mechanism)	
Bearing Assy	614061
1991-1990 6 Cyl. 300 (4.9)(5 Spd.)(Hyd. mechanism)	
Bearing Assy	614061
Bearing Assy	614169

4-SPEED MANUAL TRANSMISSION

Input Shaft

1993-1990 (Warner T18)	
Seal	7412S
Ball Bearing	308LTB[2]
Repair Sleeve	KWK99125
1990 (Tremec)	
Seal	3638
Ball Bearing	308LTB[2]
Repair Sleeve	KWK99112

Rear Output Shaft

1993-1990 (Warner T18)(28 spline)	
Seal	7692S
Ball Bearing	308LI[2]
Seal Kit	5202 ⁶⁴
1990 (Tremec)(2nd Design)	
Seal	7692S
Ball Bearing	308L[2]
Seal Kit	5202 ⁶⁴

⁶⁴Seal & Bushing Kit

Mfg./Year Model & Location Part No. Mfg./Year Model & Location Part No.

FORD TRUCK - 3/4 TON - Econoline, E250, F250 (cont.)**4-SPEED MANUAL TRANSMISSION****Selector Shaft Seal/Man. Shaft**

1990 (Tremec)
Seal 313156

5-SPEED MANUAL TRANSMISSION**Transmission Rebuild Kit**

2004-1996 (ZF S5 47)
Kit TRK300ZF
1995-1990 (ZF S5 42)
Kit TRK300ZF

Front Input Shaft

2005-1990 (ZF S5 47)
Seal Viton 713771
Cone/Cup 28580-28521[2]
Repair Sleeve KWK99139
2002-1990 (ZF S5 42)
Seal Viton 713771
Cone/Cup 28580-28521[2]
Repair Sleeve KWK99139
1999-1990 (Mazda M5R2)
Seal 223012
Repair Sleeve KWK99114

Front Input Shaft Pocket

2004-1990 (ZF S5 47)
Cone JH13349[2]
2002-1990 (ZF S5 42)
Cone JH13349[2]

Countershaft

2005-1990 (ZF S5 47)
Cone/Cup 2580-2520[2]
2002-1990 (ZF S5 42)
Cone/Cup 2580-2520[2]

Rear Output Shaft

2004-1990 (ZF S5 47)(2WD)
Seal 225010
Cone/Cup J28573-28521[2]
2004-1990 (ZF S5 47)(4WD)
Seal 1217
Cone/Cup J28573-28521[2]
Repair Sleeve KWK99157
2002-1990 (ZF S5 42)(2WD)
Seal 225010
Cone/Cup J28573-28521[2]
2002-1990 (ZF S5 42)(4WD)
Seal 1217
Cone/Cup J28573-28521[2]
2001-1990 Mazda
Seal 710415

6-SPEED MANUAL TRANSMISSION**Transmission Rebuild Kit**

2004-1999 (ZF S6 650)
Kit TRKS6650ZF

Front Input Shaft

2004-1999 (ZF S6 650)
Cone/Cup NP007430-NP423135[2]

Front Input Shaft Pocket

2004-1999 (ZF S6 650)
Cone JH13349[2]

Main Shaft

2004-1999 (ZF S6 650)
Cone/Cup NP957859-NP771105[2]

Center Counter Shaft

2004-1999 (ZF S6 650)
Cone/Cup NP043905-NP547779[2]

Rear Output Shaft

2004-1999 (ZF S6 650)(2WD)
Seal 225010
Cone/Cup J28573-28521[2]
2004-1999 (ZF S6 650)(4WD)
Seal 1217
Cone/Cup J28573-28521[2]

A/C COMPRESSOR

2002-1990 (Nippondenso FX 15)(Axial)
Ball Bearing 5106WCC[2]
1996-1990 (Sanden SD 709)(Axial)
Ball Bearing 5001KFF[2]
1993-1990 (Ford FS6)(Axial)
Ball Bearing 5000KFF[2]

DRIVESHAFT SUPPORT

2007-1999 Spicer 1410 Series I.D.
1.5748" (40mm)
Hanger Bearing Assy HB88508A
2004-1999 Spicer 1310, 1330 Series (Slip
Yoke)
Hanger Bearing Assy HB88107A
Ball Bearing 88107
1997-1990 (Spicer 1410)(1.5748" 40mm
Brg. I.D. 2.25" height)
Hanger Bearing Assy HB88508A[2]
Ball Bearing 88508
1996-1993 (Spicer 1480)(1.5748" 40mm
Brg. I.D.)
Hanger Bearing Assy HB88508AA[2]
1992-1990 (Spicer 1260, 1280, 1310,
1410, 1480)(1.3780 Brg. I.D.)
Ball Bearing 88107[2]
Hanger Bearing Assy HB88107A[2]

Mfg./Year Model & Location Part No. Mfg./Year Model & Location Part No.

FORD TRUCK - 3/4 TON - Econoline, E250, F250 (cont.)

POWER STEERING

Pump Shaft

1997-1990 (Saginaw pump)	
Seal	7013S
1997-1990 (Ford pump)	
Seal	8773S

MANUAL STEERING

Worm Shaft

1998-1990	
Seal	221922

CRANKSHAFT FRONT SEAL

6 Cylinder

2003-1990 256/4.2L, 300/4.9L	
Seal (Frt Entry)	2692
Seal (Rr Entry)	2942
Repair Sleeve	KWK99187

8 Cylinder

2008-1997 281/4.6L, 330/5.4L	
Seal	482041N
Repair Sleeve	KWK99187
2003-1990 420/6.9L, 444/7.3L (Diesel)	
Seal Viton	3894V
Seal	5066 ²⁶
1997-1990 302/5.0L, 332/5.4L, 351/5.8L, 352/5.8L, 360/5.9L, 390/6.4L, 400/6.6L, 460/7.5L	
Seal (Frt Entry)	2692
Seal (Rr Entry)	2942
Repair Sleeve	KWK99187
Harmnc Balancer Slvs	88187

10 Cylinder

2008-1997 415/6.8L	
Seal	482041N
Repair Sleeve	KWK99187
Harmnc Balancer Slvs	88187

CRANKSHAFT REAR SEAL

6 Cylinder

2003-1997 256/4.2L	
Seal	39302
Seal PTFE H/D (Opt)	5277
Repair Sleeve	KWK99363
1998-1990 240/3.9, 300/4.9L	
Seal Viton	2377
Seal PTFE H/D (Opt)	5278
Repair Sleeve	KWK99372

CRANKSHAFT REAR SEAL

8 Cylinder

2008-1990 281/4.6L, 302/5.0L, 330/5.4L	
Seal Viton	3909
Seal PTFE H/D	5277
Repair Sleeve	KWK99362
2003-1994 444/7.3L (Diesel)	
Seal	5723
1998-1990 351/5.8L	
Seal Viton	2377
Seal PTFE H/D	5278
Repair Sleeve	KWK99372
1998-1990 460/7.5L	
Seal Rope	5095
Seal Split	5118
1994-1990 420/6.9L, 444/7.3L (Diesel)	
Seal Viton	3893V
Repair Sleeve	KWK99372

10 Cylinder

2008-1997 415/6.8L	
Seal Viton	3909
Seal PTFE H/D	5277
Repair Sleeve	KWK99362

²⁶Opt. Kit = 3894V Seal & Sleeve

Mfg./Year	Model & Location	Part No.	Mfg./Year	Model & Location	Part No.
FORD TRUCK - 1 TON - Econoline, E350, F350					

FRONT WHEEL**RWD**

2009-2005 (Mono Beam Axle)	
Hub Unit Bearing	SP940203[2] ²⁵
2009-1990 (Twin I-Beam Axle)	
Seal (Inner)	4160[2]
Set (Inner)	SET47[2]
Cone/Cup (Outer)	15101-15245[2]
2007-2004 (Stripped Chassis)	
Cone/Cup (Inner)	45284-45220
Cone/Cup (Outer)	25880-25820
2004-1999 (Mono Beam Axle)	
Hub Unit Bearing	HA590233[2] ²⁵

4WD

2009-2008 (DRW)(Fat Boy)	
Hub Unit Bearing	SP940204[2] ²⁵
2009-2005 (DRW)(ABS)	
Hub Unit Bearing	SP940201[2] ²⁵
2009-2005 (SRW)(ABS)	
Hub Unit Bearing	SP940200[2] ²⁵
2004-2000 (DRW)(4 Whl. ABS)	
Hub Unit Bearing	515025[2]
2004-2000 (SRW)(4 Whl. ABS)(Coarse Thread Studs)	
Hub Unit Bearing	515020[2]
2004-2000 (SRW)(4 Whl. ABS)(Fine Thread Studs)	
Hub Unit Bearing	SP580205[2] ²⁵
2004-2000 (SRW)(Rr. Whl. ABS)	
Hub Unit Bearing	515021[2]
1999 (DRW)(4 Whl. ABS)(Coarse Thread Studs)(Thru 3/21/99)	
Hub Unit Bearing	HA590425[2]
1999 (DRW)(4 Whl. ABS)(From 3/22/99)	
Hub Unit Bearing	515025[2]
1999 (SRW)(4 Whl. ABS)(Coarse Thread Studs)(From 3/22/99)	
Hub Unit Bearing	515020[2]
1999 (SRW)(4 Whl. ABS)(Coarse Thread Studs)(Thru 3/21/99)	
Hub Unit Bearing	SP580204[2] ²⁵
1999 (SRW)(4 Whl. ABS)(Fine Thread Studs)(From 3/22/99)	
Hub Unit Bearing	SP580205[2] ²⁵
1999 (SRW)(Rr. Whl. ABS)(Coarse Thread Studs)(Thru 3/21/99)	
Hub Unit Bearing	HA590132[2] ²⁵
1999 (SRW)(Rr. Whl. ABS)(From 3/22/99)	
Hub Unit Bearing	515021[2]
1997-1990	
Seal (Inner)	415960[2]
Cone/Cup (Inner)	387A-382A[2]
Set (Outer)	SET38[2]

REAR WHEEL**RWD**

2008-1999 (10.5" R.G.)	
Seal (Inner)	370247A[2] ⁸⁶
Cone/Cup (Inner)	NP114036-NP064306[2]
Set (Outer)	SET38[2]
2008-1999 (DRW)(Dana 80 Axle)(11.25 R.G)	
Seal (Inner)	710454[2]
Cone/Cup (Inner)	33281-33462[2]
Cone/Cup (Outer)	39250-39412[2]
2008-1990 (Econoline)	
Seal (Inner)	9864S[2]
Cone/Cup (Inner)	387AS-382A[2]
Set (Outer)	SET38[2]
1997-1994 (10.25", 10,5" R.G.)(From 4/1/94)	
Seal (Inner)	370047A[2] ⁵⁷
Cone/Cup (Inner)	3992-3920[2]
Set (Outer)	SET38[2]
1994-1990 (10.25" R.G.)(Thru 3/31/94)	
Seal (Inner)	370047A[2] ⁵⁷
Cone/Cup (Inner)	3994-3920[2]
Set (Outer)	SET38[2]
1993-1992 (Spicer 80 Ser. Axle)	
Seal (Inner)	370018A[2] ⁵⁷
Cone/Cup (Inner)	39585-39520[2]
Cone/Cup (Outer)	JLM506849-JLM506810[2]
1993-1990 (Spicer 60, 70 Axle)	
Seal (Inner)	9864S[2]
Cone/Cup (Inner)	387AS-382A[2]
Set (Outer)	SET38[2]

4WD

2008-1999 (10.5" R.G.)	
Seal (Inner)	370247A[2] ⁸⁶
Cone/Cup (Inner)	NP114036-NP064306[2]
Set (Outer)	SET38[2]
2008-1999 (DRW)(Dana 80 Axle)(11.25 R.G)	
Seal (Inner)	710454[2]
Cone/Cup (Inner)	33281-33462[2]
Cone/Cup (Outer)	39250-39412[2]
2008-1990 (Econoline)	
Seal (Inner)	9864S[2]
Cone/Cup (Inner)	387AS-382A[2]
Set (Outer)	SET38[2]
1997-1994 (10.25", 10,5" R.G.)(From 4/1/94)	
Seal (Inner)	370047A[2] ⁵⁷
Cone/Cup (Inner)	3992-3920[2]
Set (Outer)	SET38[2]
1994-1990 (10.25" R.G.)(Thru 3/31/94)	
Seal (Inner)	370047A[2] ⁵⁷
Cone/Cup (Inner)	3994-3920[2]
Set (Outer)	SET38[2]
1993-1992 (Spicer 80 Ser. Axle)	
Seal (Inner)	370018A[2] ⁵⁷
Cone/Cup (Inner)	39585-39520[2]
Cone/Cup (Outer)	JLM506849-JLM506810[2]

²⁵New Item, Check For Availability⁵⁷Oil Bath Seal⁸⁶Use RD247 to install seal number 370247A

FORD TRUCK - 1 TON - Econoline, E350, F350 (cont.)

REAR WHEEL (cont.)

4WD (cont.)

- 1993-1990 (Spicer 60, 70 Axle)
- Seal (Inner) 9864S[2]
- Cone/Cup (Inner) 387AS-382A[2]
- Set (Outer) SET38[2]

4WD FRONT AXLE

Axle Shaft

- 2008-1999
- Seal (Inner) 710492[2]²⁵
- 2004-1999
- Seal (Outer) 710413[2]
- Ndle Bearing B2110[2]
- 1997-1990 (Spicer 60 Axle)
- Seal 470682[2]
- 1997-1990 (w/o Spicer 60)
- Seal (Inner) 710414[2]
- Seal (Outer) 710413[2]

Differential Rebuild Kit

- 2006-2000 (Dana/Spicer 60 Ser. Axle)
- Kit DRK331A
- 2004-1999 (Dana/Spicer 50 Ser. Axle)
- Kit DRK336A
- 1999-1990 (Dana/Spicer 60 Ser. Axle)
- Kit DRK331
- 1997-1990 (Dana/Spicer 50 Ser. Axle)
- Kit DRK336

Differential

- 2006-1990 (Dana/Spicer 60 Ser. Monobeam Axle)
- Cone/Cup 387A-382S[2]
- 2004-1990
- Cone (Non-Independant Axle) JLM104946[2]
- Cone (Independant Axle) JLM104948[2]
- Cup (All) LM104911A[2]

Pinion

- 2007-2002 (Dana/Spicer 60 Ser. Monobeam Axle)
- Seal 100712V
- Cone/Cup (Inner) HM803146-HM803110
- Cone/Cup (Outer) HM88542-HM88510
- 2004-1999 (Dana/Spicer 50 Ser. Axle)
- Seal 2506
- Cone/Cup (Inner) HM88649-HM88610
- Cone/Cup (Outer) 02872-02820
- Repair Sleeve KWK99155
- 1997-1990 (Dana/Spicer 60 Ser. Axle)
- Seal Viton 719316
- Cone/Cup (Inner) HM803146-HM803110
- Cone/Cup (Outer) HM88542-HM88510
- Repair Sleeve KWK99187

4WD FRONT AXLE (cont.)

Pinion (cont.)

- 1997-1990 (Dana/Spicer 50 Ser. Indep. Axle)
- Seal 5778
- Cone/Cup (Inner) HM88649-HM88610
- Cone/Cup (Outer) 02872-02820

Spindle Kit

- 1997-1992
- Bearing & Seal Kit SBK5[2]³⁷
- 1991-1990 (Dana/Spicer 50, 60 Ser. Axle)
- Bearing & Seal Kit SBK3[2]³⁵

Spindle

- 2004-1999
- Seal 710413[2]
- Ndle Bearing B2110[2]
- 1997-1992
- Seal (Inner) 710414[2]
- Ndle Bearing (Inner) B2414[2]
- Seal (Outer) 710413[2]
- 1991-1990 (Dana/Spicer 50, 60 Ser. Axle)
- Seal (Inner) 710044[2]
- Ndle Bearing (Inner) B2414[2]
- Seal (Outer) 710045[2]

Steering Knuckle

- 2004-1999
- Seal 710493[2]²⁵
- 1998-1990 (Dana/Spicer 60-7 Axle)
- Seal 710304[2]
- Cone/Cup 23100-23256[2]

REAR AXLE

Differential Rebuild Kit

- 2007-2004 (Spicer 60-1 9.75 RG)
- Kit DRK331B
- 2006-1999 (10.5" R.G.)
- Kit DRK317
- 2004-1998 (Dana/Spicer 80 Axle)
- Kit DRK337A
- 1998-1990 (Dana/Spicer 70 H/D Axle)
- Kit DRK332HD
- 1998-1990 (Dana/Spicer 70-2U, 70-U Axles)
- Kit DRK332U
- 1998-1990 (Dana/Spicer 60 Ser. Axle)
- Kit DRK331
- 1997-1990 (Dana/Spicer 80 Axle)
- Kit DRK337
- 1997-1990 (10.25" R.G.)
- Kit DRK314

Differential

- 2006-1999 (10.5" R.G.)
- Cone/Cup 469-453X[2]

²⁵New Item, Check For Availability

³⁵Opt. Kit = Brg B2414, Seals 710044 & 710045

³⁷Opt.

Kit = Brg B2414, Seals 710414 & 710413

Mfg./Year	Model & Location	Part No.	Mfg./Year	Model & Location	Part No.
FORD TRUCK - 1 TON - Econoline, E350, F350 (cont.)					

REAR AXLE (cont.)**Differential (cont.)**

2005-1990	(Dana/Spicer 80 Axle F Super Duty Ch.)(10.25", "10.5" R.G.)	
Cone/Cup	469-453X[2]
2002-1999	(Dana/Spicer 60, 61, 70 Ser. Axles)	
Cone/Cup	NP197868-NP802507[2]
1998-1990	(Dana/Spicer 70-D, 70-B, 70-U, 70-2U Axles)(Dana/Spicer 60,60-U, 60-1U, 61-1, 61 Axle)	
Cone/Cup	387A-382S[2]
1995-1990	(Dana/Spicer 70 H/D, 70-1H/D, 70-2U, 80 Ser. Axles)(10.25" R.G.)	
Cone/Cup	469-453X[2]

Pinion

2008-2007	(10.5" R.G.)	
Seal Viton	4278
Cone/Cup (Inner)	NP761271-NP998236
Cone/Cup (Outer)	HM89443-HM89411
2008-1999	(Dana/Spicer 80 Axle)	
Seal	100727
Cone/Cup (Inner)	NP516549-NP673386
Cone/Cup (Outer)	M802048-M802011
2008-1990	(Dana/Spicer 60-1U Axle)	
Seal Viton	719316
Cone/Cup (Inner)	HM803146-HM803110
Cone/Cup (Outer)	HM88542-HM88510
2007-1990	(Dana/Spicer 70-2U Axle)	
Seal Viton	719316
Cone/Cup (Inner)	HM803149-HM803110
Cone/Cup (Outer)	HM88542-HM88510
Repair Sleeve	KWK99187
2006-1999	(10.5" R.G.)	
Seal Viton	4278
Cone/Cup (Inner)	NP504493-NP949481
Cone/Cup (Outer)	HM89443-HM89411
2006-1999	(11.25" R.G.)	
Seal Viton	4525V
Cone/Cup (Inner)	NP516549-NP673386
Cone/Cup (Outer)	M802048-M802011
1998-1990	(11.25" R.G.)	
Seal Viton	4525V
Cone/Cup (Inner)	HM807046-HM807010
Cone/Cup (Outer)	M802048-M802011
1998-1990	(Dana/Spicer 80 Axle)	
Seal Viton	4525V
Cone/Cup (Inner)	HM807046-HM807010
Cone/Cup (Outer)	M802048-M802011
1998-1990	(10.25", 10,5" R.G.)	
Seal Viton	4278
Cone/Cup (Inner)	HM807044-HM807010
Cone/Cup (Outer)	HM89443-HM89411
1997-1990	(Dana/Spicer 70-1H/D, 70 H/D Axle)	
Seal Viton	719316
Cone/Cup (Inner)	HM807040-HM807010
Cone/Cup (Outer)	HM88542-HM88510

TRANSFER CASE REBUILD KIT

1997-1990	(Warner 1356)(slip yoke)	
Kit	TCRK1356
1990	(Warner 1345)	
Kit	TCRK1345

TRANSFER CASE**Input Shaft**

2008-1999	(New Process 271, 273)	
Ball Bearing	211TB[2]
1997-1996	(Warner 4407)	
Seal	4333N
Ball Bearing	211TB
Ndle Bearing (Pilot)	BK3026
1997-1990	(Warner 1356)	
Seal	714503
Ball Bearing	110CB
Ndle Bearing (Pilot)	BK3026
1990	(Warner 1345)	
Seal	710062
Repair Sleeve	KWK99175

Front Output Shaft

2008-1999	(New Process 271, 273)	
Ball Bearing	111TB
Ndle Bearing (Pilot)	J2416
1997-1996	(Warner 4407)	
Ball Bearing (Inner)	207
Seal (Outer)	4333N
Ball Bearing (Outer)	208
Ndle Bearing (Pilot)	B2012
1997-1990	(Warner 1356)	
Seal	714503
Ball Bearing	207
Ndle Bearing (Pilot)	B2012
1990	(Warner 1345)	
Seal	3946
Ball Bearing	207
Repair Sleeve	KWK99187
Ndle Bearing (Pilot)	B2012

Rear Output Shaft

1997-1996	(Warner 4407)	
Seal	4503N
Ball Bearing	308WB
Ndle Bearing Thrust	NTA2233[2]
1997-1990	(Warner 1356)(fixed yoke)	
Seal	4333N
Ball Bearing	207
1997-1990	(Warner 1356)(slip yoke)	
Seal	4503N
Ball Bearing	207
1990	(Warner 1345)(w/o boot)	
Seal	3946
Ball Bearing	207
Repair Sleeve	KWK99187
Ndle Bearing (Pilot)	B2812

Mfg./Year Model & Location Part No. Mfg./Year Model & Location Part No.

FORD TRUCK - 1 TON - Econoline, E350, F350 (cont.)

TRANSFER CASE

Intermediate Shaft

1997-1996 (Warner 4407)
Ball Bearing 210S[2]

Oil Pump Housing

2008-1999 (New Process 271, 273)
Seal 341022
Repair Sleeve KWK99225

Selector Shaft Seal/Man. Shaft

1997-1990 (Warner 1356, 4407)
Seal 330385

3-SPEED AUTOMATIC TRANSMISSION

Torque Converter

1997-1990 (C4, C5, C6)
Seal 331107N
Repair Sleeve KWK99199

Rear Seal/Ext. Housing

1997-1990 (C6)
Seal 410308

Selector Shaft Seal/Man. Shaft

1997-1990 (C6)
Seal 7929S

4-SPEED AUTOMATIC TRANSMISSION

Torque Converter

2000-1990 (AODE, E4OD)
Seal 3404
1993-1990 (AOT, AOD)
Seal 331107N
Repair Sleeve KWK99199

Rear Seal/Ext. Housing

2000-1994 (AODE)
Seal 4765
2000-1990 (E4OD)
Seal 7300S
Seal Kit 5203⁶⁴
1993-1990 (AOT, AOD)(long boot)
Seal 7692S
Seal Kit 5202⁶⁴

Selector Shaft Seal/Man. Shaft

2005-1990
Seal 7929S

5-SPEED AUTOMATIC TRANSMISSION

Selector Shaft Seal/Man. Shaft

2008-2006
Seal 7929S

CLUTCH

Pilot Bearing

2002-1999 330/5.4L (SOHC)
Ndle Bearing FC68329
2002-1990 8 Cyl. 444 (7.3)(Diesel)
Ndle Bearing FC65662
1998-1997 330/5.4L
Ndle Bearing FC65662
1997-1990 8 Cyl. 460 (7.5)
Ndle Bearing FC66067
1997-1990 8 Cyl. 302 (5.0)
Ndle Bearing FC65662
1997-1990 8 Cyl. 351 (5.8)
Ndle Bearing FC65662
1997-1990 6 Cyl. 300 (4.9)
Ndle Bearing FC65662

Release Bearing

2002-1999 330/5.4L, 445/7.3L
Bearing Assy 614175
1998-1997 330/5.4L (SOHC)
Bearing Assy 614169
1998-1993 6 Cyl. 300 (4.9)(5 Spd.)(Hyd.
piston type)
Bearing Assy 614169
1998-1993 8 Cyl. 351 (5.8)(5 Spd.)(Hyd.
piston type)
Bearing Assy 614169
1998-1990 8 Cyl. 444 (7.3)(Diesel)
Bearing Assy 614062
1998-1990 8 Cyl. 420 (6.9)(Diesel)(5 Spd.)
Bearing Assy 614062
1998-1990 8 Cyl. 460 (7.5)(5 Spd.)
Bearing Assy 614062
1993-1990 8 Cyl. 351 (5.8)(4
Spd.)(mechanical mechanism)
Bearing Assy 614014
1993-1990 6 Cyl. 300 (4.9)(4
Spd.)(mechanical mechanism)
Bearing Assy 614014
1993-1990 8 Cyl. 460 (7.5)(4 Spd.)
Bearing Assy 614014
1992-1990 6 Cyl. 300 (4.9)(5 Spd.)(Hyd.
piston type)
Bearing Assy 614061
1992-1990 8 Cyl. 351 (5.8)(5 Spd.)(Hyd.
piston type)
Bearing Assy 614061

4-SPEED MANUAL TRANSMISSION

Input Shaft

1993-1990 (Warner T18)
Seal 7412S
Ball Bearing 308LTB[2]
Repair Sleeve KWK99125
1990 (Tremec)
Seal 3638
Ball Bearing 308LTB[2]
Repair Sleeve KWK99112

⁶⁴Seal & Bushing Kit

Mfg./Year	Model & Location	Part No.	Mfg./Year	Model & Location	Part No.
FORD TRUCK - 1 TON - Econoline, E350, F350 (cont.)					

4-SPEED MANUAL TRANSMISSION**Rear Output Shaft**

1993-1990	(Warner T18)(28 spline)	
Seal	7692S
Ball Bearing	308LI[2]
Seal Kit	5202 ⁶⁴
1990	(Tremec)(2nd Design)	
Seal	7692S
Ball Bearing	308LI[2]
Seal Kit	5202 ⁶⁴

Selector Shaft Seal/Man. Shaft

1990	(Tremec)	
Seal	313156

5-SPEED MANUAL TRANSMISSION**Transmission Rebuild Kit**

2004-1999	(ZF S5 47)	
Kit	TRK300ZF
1995-1990	(ZF S5 42)	
Kit	TRK300ZF

Front Input Shaft

2004-1999	(ZF S5 47)	
Seal Viton	713771
Cone/Cup	28580-28521[2]
Repair Sleeve	KWK99139
1998-1990	(ZF S5 42, S5 47)	
Seal Viton	713771
Cone/Cup	28580-28521[2]
Repair Sleeve	KWK99139
1990	Mazda	
Seal	223012
Repair Sleeve	KWK99114

Front Input Shaft Pocket

2004-1990	(ZF S5 47)	
Cone	JH13349[2]
2002-1990	(ZF S5 42)	
Cone	JH13349[2]

Countershaft

2005-1990	(ZF S5 47)	
Cone/Cup	2580-2520[2]
2002-1990	(ZF S5 42)	
Cone/Cup	2580-2520[2]

Rear Output Shaft

2004-1990	(ZF S5 47)(2WD)	
Seal	225010
Cone/Cup	J28573-28521[2]
2004-1990	(ZF S5 47)(4WD)	
Seal	1217
Cone/Cup	J28573-28521[2]
2002-1990	(ZF S5 42)(2WD)	
Seal	225010
Cone/Cup	J28573-28521[2]
2002-1990	(ZF S5 42)(4WD)	
Seal	1217
Cone/Cup	J28573-28521[2]

5-SPEED MANUAL TRANSMISSION (cont.)**Rear Output Shaft (cont.)**

1990	Mazda	
Seal	710415

6-SPEED MANUAL TRANSMISSION**Transmission Rebuild Kit**

2004-1999	(ZF S6 650)	
Kit	TRKS6650ZF

Front Input Shaft

2004-1999	(ZF S6 650)	
Cone/Cup	NP007430-NP423135[2]

Front Input Shaft Pocket

2004-1999	(ZF S6 650)	
Cone	JH13349[2]

Main Shaft

2004-1999	(ZF S6 650)	
Cone/Cup (Center)	NP957859-NP771105[2]

Center Counter Shaft

2004-1999	(ZF S6 650)	
Cone/Cup	NP043905-NP547779[2]

Rear Output Shaft

2004-1999	(ZF S6 650)(2WD)	
Seal	225010
Cone/Cup	J28573-28521[2]
2004-1999	(ZF S6 650)(4WD)	
Seal	1217
Cone/Cup	J28573-28521[2]

DRIVESHAFT SUPPORT

2007-1993	(Spicer 1480)(1.5748" 40mm Brg. I.D.)	
Hanger Bearing Assy	HB88508AA[2]
Ball Bearing	88508
2004-1999	Spicer 1310, 1330 Series (Slip Yoke)	
Hanger Bearing Assy	HB88107A
Ball Bearing	88107
2000-1997	E350	
Hanger Bearing Assy	HB88508G[2]
1995-1990	(Spicer 1260, 1280, 1310, 1410, 1480)(1.3780" Brg. I.D.)	
Ball Bearing	88107[2]
Hanger Bearing Assy	HB88107A[2]

POWER STEERING**Pump Shaft**

1997-1992	(Ford pump)	
Seal	8773S
1997-1990	E350 (Saginaw pump)	
Seal	7013S
1991-1990	F Ser.	
Seal	8773S

⁶⁴Seal & Bushing Kit

Mfg./Year Model & Location Part No. Mfg./Year Model & Location Part No.

FORD TRUCK - 1 TON - Econoline, E350, F350 (cont.)

MANUAL STEERING

Worm Shaft

1998-1990 E350
Seal 221922

CRANKSHAFT FRONT SEAL

6 Cylinder

1998-1990 240/3.9, 300/4.9L
Seal (Frt Entry) 2692
Seal (Rr Entry) 2942
Repair Sleeve KWK99187
Harmnc Balancer Slvs 88187

8 Cylinder

2008-1997 330/5.4L
Seal 482041N
Repair Sleeve KWK99187
2003-1990 420/6.9L, 444/7.3L (Diesel)
Seal Viton 3894V
Seal 5066²⁶
1997-1990 302/5.0L, 332/5.4L, 351/5.8L,
352/5.8L, 360/5.9L, 390/6.4L,
400/6.6L, 460/7.5L
Seal (Frt Entry) 2692
Seal (Rr Entry) 2942
Repair Sleeve KWK99187
Harmnc Balancer Slvs 88187

10 Cylinder

2008-1997 415/6.8L
Seal 482041N
Repair Sleeve KWK99187
Harmnc Balancer Slvs 88187

CRANKSHAFT REAR SEAL

6 Cylinder

1996-1990 240/3.9L, 300/4.9L
Seal Viton 2377
Seal PTFE H/D 5278
Repair Sleeve KWK99372

CRANKSHAFT REAR SEAL

8 Cylinder

2008-1997 330/5.4L
Seal Viton 3909
Seal PTFE H/D 5277
Repair Sleeve KWK99362
2003-1994 444/7.3L (Diesel)
Seal 5723
1998-1990 351/5.8L
Seal Viton 2377
Seal PTFE H/D 5278
Repair Sleeve KWK99372
1998-1990 460/7.5L
Seal Rope 5095
Seal Split 5118
1994-1990 420/6.9L, 444/7.3L (Diesel)
Seal Viton 3893V
Repair Sleeve KWK99372

10 Cylinder

2008-1997 415/6.8L
Seal Viton 3909
Seal PTFE H/D 5277
Repair Sleeve KWK99362

FORD TRUCK - 1-1/2, 2, 2-1/2 TON - Motor Home Chassis, 400, 450, F53, F59, 500, 550, 600, 700 Series

FRONT WHEEL

RWD

2009-2005 Super Duty (Mono Beam Axle)
Hub Unit Bearing SP940203[2]²⁵
2007-1999 Super Duty (Twin I-Beam Axle)
Seal (Inner) 4160[2]
Set (Inner) SET47[2]
Cone/Cup (Outer) 15101-15245[2]
2004-1999 Super Duty (Mono Beam Axle)
Hub Unit Bearing HA590233[2]²⁵

FRONT WHEEL (cont.)

RWD (cont.)

2003-2000 F650, F750 (9000 lb. Axle)(ABS)
Seal (Inner) 370132A[2]⁵⁷
Cone/Cup (Inner) 39581-39520[2]
Cone/Cup (Outer) 3585-3525[2]
2003-2000 F750 (12000 lb. Axle)(ABS)
Seal (Inner) 370001A[2]
Cone/Cup (Inner) HM212049-HM212011[2]
Cone/Cup (Outer) 3782-3720[2]

²⁵New Item, Check For Availability

²⁶Opt. Kit = 3894V Seal & Sleeve

⁵⁷Oil Bath Seal

FORD TRUCK - 1-1/2, 2, 2-1/2 TON - Motor Home Chassis, 400, 450, F53, F59, 500, 550, 600, 700 Series (cont.)**FRONT WHEEL (cont.)****RWD (cont.)**

1999-1990	600, 700 Ser. (6000, 7000 lb. Axle)(Disc)	
	Seal (Inner)	2674[2]
	Cone/Cup (Inner)	45284-45220[2]
	Cone/Cup (Outer)	25880-25820[2]
1998-1990	F450 Super Duty, F53, F550 Super Duty	
	Seal (Inner)	4160[2]
	Set (Inner)	SET47[2]
	Cone/Cup (Outer)	15101-15245[2]
1997-1992	(10,000, 12,000 & 14,600 lb. Axles), (ABS)	
	Seal (Inner)	370001A[2]
	Set (Inner)	SET413[2]
	Set (Outer)	SET406[2]
1994-1990	600, 700 Ser. (7500, 9000, 12000 lb. Axle)	
	Seal (Inner)	370132A[2] ⁵⁷
	Cone/Cup (Inner)	39581-39520[2]
	Cone/Cup (Outer)	3585-3525[2]

4WD

2009-2005	F450, F550 Super Duty (DRW)	
	Hub Unit Bearing	SP940202[2] ²⁵
2004-2000	F450, F550 Super Duty (DRW)(4 Whl. ABS)	
	Seal	710413[2]
	Hub Unit Bearing	515025[2]
2004-2000	F450, F550 Super Duty (SRW)(4 Whl. ABS)(Coarse Thread Studs)	
	Seal	710413[2]
	Hub Unit Bearing	515020[2]
2004-2000	F450, F550 Super Duty (SRW)(4 Whl. ABS)(Fine Thread Studs)	
	Seal	710413[2]
	Hub Unit Bearing	SP580205[2] ²⁵
2004-2000	F450, F550 Super Duty (SRW)(Rr. Whl. ABS)	
	Seal	710413[2]
	Hub Unit Bearing	515021[2]
1999	F450, F550 Super Duty (DRW)(4 Whl. ABS)(Coarse Thread Studs)(Thru 3/21/99)	
	Seal	710413[2]
	Hub Unit Bearing	HA590425[2]
1999	F450, F550 Super Duty (DRW)(4 Whl. ABS)(From 3/22/99)	
	Hub Unit Bearing	515025[2]
1999	F450, F550 Super Duty (SRW)(4 Whl. ABS)(Coarse Thread Studs)(From 3/22/99)	
	Hub Unit Bearing	515020[2]
1999	F450, F550 Super Duty (SRW)(4 Whl. ABS)(Coarse Thread Studs)(Thru 3/21/99)	
	Hub Unit Bearing	SP580204[2] ²⁵

FRONT WHEEL (cont.)**4WD (cont.)**

1999	F450, F550 Super Duty (SRW)(4 Whl. ABS)(Fine Thread Studs)(From 3/22/99)	
	Hub Unit Bearing	SP580205[2] ²⁵
1999	F450, F550 Super Duty (SRW)(Rr. Whl. ABS)(Coarse Thread Studs)(Thru 3/21/99)	
	Hub Unit Bearing	HA590132[2] ²⁵
1999	F450, F550 Super Duty (SRW)(Rr. Whl. ABS)(From 3/22/99)	
	Hub Unit Bearing	515021[2]
1997-1990		
	Seal (Inner)	415960[2]
	Cone/Cup (Inner)	387A-382A[2]
	Set (Outer)	SET38[2]

REAR WHEEL**RWD**

2007-1999	F450, F550 Super Duty	
	Seal (Inner)	710454[2]
	Cone/Cup (Inner)	33281-33462[2]
	Cone/Cup (Outer)	39250-39412[2]
2005-1999	E450, E550	
	Seal (Inner)	9864S[2]
	Cone/Cup (Inner)	387AS-382A[2]
	Set (Outer)	SET38[2]
2004-2000	F650, F750 (17,000 lb. Axle)(Dayton Whl.)	
	Seal (Inner)	370024A[2] ⁵⁷
	Set (Inner)	SET411[2]
	Set (Outer)	SET408[2]
1999-1990	(15,000 lb. Axle)(15" x 5" Drum)(Dayton Whl.)	
	Seal (Inner)	370047A[2] ⁵⁷
	Seal (Inner)	455858[2]
	Cone/Cup (Inner)	33287-33462[2]
	Seal (Outer)	5487[2]
	Cone/Cup (Outer)	3982-3920[2]
1999-1990	(15,000 lb. Axle)(15" x 6" Drum)(Dayton Whl.)	
	Seal (Inner)	370047A[2] ⁵⁷
	Seal (Inner)	455858[2]
	Cone/Cup (Inner)	33287-33462[2]
	Seal (Outer)	5487[2]
	Cone/Cup (Outer)	3982-3920[2]
1998-1992	F450, F53, F59	
	Seal (Inner)	370018A[2] ⁵⁷
	Cone/Cup (Inner)	39590-39520[2]
	Cone/Cup (Outer)	JLM506849-JLM506810[2]
1992-1990	(17,500, 18,000 & 19,000 lb. Axles)(w/15"x7" & 16"x7" Brks.)	
	Seal (Inner)	370024A[2] ⁵⁷
	Set (Inner)	SET411[2]
	Set (Outer)	SET408[2]

²⁵New Item, Check For Availability⁵⁷Oil Bath Seal

Mfg./Year Model & Location Part No. Mfg./Year Model & Location Part No.

FORD TRUCK - 1-1/2, 2, 2-1/2 TON - Motor Home Chassis, 400, 450, F53, F59, 500, 550, 600, 700 Series (cont.)

REAR WHEEL (cont.)

RWD (cont.)

1992-1990	(15,000 lb. Axle)(From Ch. # C42001)	
Seal (Inner)	370047A[2] ⁵⁷
Seal (Inner)	455858[2]
Seal (Outer)	5487[2]
Cone/Cup (Inner)	33287-33462[2]
Cone/Cup (Outer)	3982-3920[2]
1991-1990	(Dana/Spicer 80 Axle)	
Seal (Inner)	370018A[2] ⁵⁷
Cone/Cup (Inner)	39585-39520[2]
Cone/Cup (Outer)	368A-362A[2]
1991-1990	CF600 Ser. (20,000 lb., 23,000 lb. Axle)	
Seal (Inner)	370003A[2] ⁵⁷
Cone/Cup (Inner)	594A-592A[2]
Cone/Cup (Outer)	580-572[2]
1990	(13,000 lb. Axle)(13" x 5" Drum)(Budd Whl.)	
Seal (Inner)	370047A[2] ⁵⁷
Cone/Cup (Inner)	3984-3920[2]
Seal (Inner)	455858[2]
Cone/Cup (Outer)	462-453X[2]

FRONT AXLE

Differential

2004-2001	(DRW)	
Cone/Cup	387A-382S[2]
2004-1999	(SRW)	
Cone/Cup	JLM104948-LM104911A[2]

Pinion

2004-2001	(DRW)	
Cone/Cup (Inner)	HM88542-HM88510
Cone/Cup (Outer)	HM803146-HM803110
2004-1999	(SRW)	
Cone/Cup (Inner)	02872-02820
Cone/Cup (Outer)	HM88649-HM88610
1997-1995	F450 Super Duty	
Seal Viton	719316
Repair Sleeve	KWK99187

Steering Knuckle

2004-1999		
Seal	710493[2] ²⁵

4WD FRONT AXLE

Axle Shaft

2008-1999		
Seal (Inner)	710492[2] ²⁵
2004-1999		
Seal (Outer)	710413[2]
Ndle Bearing	B2110[2]

REAR AXLE

Differential Rebuild Kit

2007-2003	(Spicer 60 1 Axle)	
Kit	DRK331B
2006-1999	(10.5" R.G.)	
Kit	DRK317
2004-1998	(Dana/Spicer 80 Axle)	
Kit	DRK337A
1998-1990	(Dana/Spicer 80 Axle)	
Kit	DRK337
1994-1990	(Rockwell 13120, 15120 Axles)	
Kit	DRK218
1994-1990	(Rockwell 19220 Axle)	
Kit	DRK216
1992-1990	(Rockwell 17140 Axle)	
Kit	DRK215
1992-1990	(Rockwell 17220 Axle)	
Kit	DRK216

Differential

2006-1999	(10.5"R.G.)(11.25"R.G.)	
Cone/Cup	469-453X[2]
2004-1999	(14.24"R.G)	
Cone/Cup	3984-3920[2]
1994-1993	(Rockwell 19220 Axle)	
Cone/Cup	42381-42584[2]
1994-1992	(Rockwell 19145 Axle)	
Cone/Cup	JM716649-JM716610[2]
1994-1990	(Rockwell 13120, 15120 Axles)	
Cone/Cup (LH)	3994-JM511910
Cone/Cup (RH)	34306-34478
1994-1990	(Rockwell 15210 Axle)	
Cone/Cup (LH)	JP10049-JP10010
Cone/Cup (RH)	JLM714149-JLM714110
1994-1990	(Rockwell 17140, 21145 Axles)(3200-L-1676 Carrier)	
Cone/Cup	JM716649-JM716610[2]
1994-1990	(Rockwell 17140, 21145 Axles)(3200-M-1547 Carrier)	
Cone/Cup (LH)	JM716649-JM716610
Cone/Cup (RH)	JP10049-JP10010
1994-1990	(Rockwell 21145 Axle)(3200-R-1500 Carrier)	
Bearing Assy	32020X[2]
1994-1990	(Rockwell 21230 Axle)	
Cone/Cup (LH)	52400-52618
Cone/Cup (RH)	JM716649-JM716610
1994-1990	(Rockwell 23160 Axle)	
Bearing Assy	32021X[2]
1994-1990	(Rockwell 23240 Axle)	
Cone/Cup (LH)	JP12049-JP12010
Cone/Cup (RH)	JM716649-JM716610
1993-1990	(Rockwell 23180 Axle)	
Cone/Cup (LH)	JHM720249-JHM720210
Cone/Cup (RH)	64450-64700
1992-1990	(Rockwell 17220, 19220 Axles)	
Cone/Cup (LH)	42381-42584
Cone/Cup (RH)	JLM714149-JLM714110

²⁵New Item, Check For Availability

⁵⁷Oil Bath Seal

Mfg./Year Model & Location Part No. Mfg./Year Model & Location Part No.

FORD TRUCK - 1-1/2, 2, 2-1/2 TON - Motor Home Chassis, 400, 450, F53, F59, 500, 550, 600, 700 Series (cont.)**REAR AXLE****Pinion**

2008-2007	(10.5" R.G.)	
Seal Viton	4278
Cone/Cup (Inner) NP761271-NP998236	
Cone/Cup (Outer) HM89443-HM89411	
2006-1999	(10.5" R.G.)	
Seal Viton	4278
Cone/Cup (Inner) NP504493-NP949481	
Cone/Cup (Outer) HM89443-HM89411	
2004-1999	(14.24" R.G.)	
Cone/Cup (Rr)	72225C-72487[2]
2004-1999	(Spicer 80 Ser. Axle)	
Seal Viton	4525V
Cone/Cup (Inner)	55200C-55437
Cone/Cup (Outer)	M802048-M802011
1994-1993	(Rockwell 19220 Axle)	
Seal	415082N
Cone/Cup (Inner)	55200C-55437
Cone/Cup (Outer)	M804049-M804010
Cylindrical Bearing	RU1570UM[2]
1994-1990	(Rockwell 15210 Axle)(Prod. From 12/1987 On)	
Seal	415082N
Cone/Cup (Inner)	55200C-55437
Cone/Cup (Outer)	M804049-M804010
Cylindrical Bearing	RU1570UM[2]
1994-1990	(Rockwell 13120, 15120 Axles)	
Seal	415082N
Cone/Cup (Inner)	55200C-55437
Cone/Cup (Outer)	HM804846-HM804810
Cylindrical Bearing	MUB1305UDM[2]
1994-1990	(Rockwell 19145, 21145 Axles)	
Seal	3905
Cone/Cup (Inner)	72212C-72487
Cone/Cup (Outer)	55206C-55437
Cylindrical Bearing	RU1570UM[2]
1994-1990	(Rockwell 21230 Axle)	
Seal	415082N
Cone/Cup (Inner)	55200C-55437
Cone/Cup (Outer)	HM804846-HM804810
1994-1990	(Rockwell 23160 Axle)	
Seal	417987N
Cone/Cup (Inner)	9278-9220
Cone/Cup (Outer)	HM813843-HM813810
1994-1990	(Rockwell 23240 Axle)	
Seal	3905
Cone/Cup (Inner)	78225C-78551
Cone/Cup (Outer)	55206C-55437
1993-1990	(Rockwell 23180 Axle)	
Seal	417987N
Cone/Cup (Inner)	9278-9220
Cone/Cup (Outer)	H715334-H715311
Cylindrical Bearing	MUB7309UM[2]
1992-1990	(Rockwell 17140 Axle)(3200-L-1676 Carrier)	
Seal	415082N
Cone/Cup (Inner)	55200C-55437
Cone/Cup (Outer)	M804049-M804010
Cylindrical Bearing	RU1570UM[2]

REAR AXLE (cont.)**Pinion (cont.)**

1992-1990	(Rockwell 17220, 19220 Axles)	
Seal	415082N
Cone/Cup (Inner)	55200C-55437
Cone/Cup (Outer)	M804049-M804010
Cylindrical Bearing	RU1570UM[2]

TRANSFER CASE**Input Shaft**

2004-1999	F450, F550 Super Duty	
Ball Bearing	211TB

Front Output Shaft

2004-1999	F450, F550 Super Duty	
Ball Bearing	111TB

4-SPEED AUTOMATIC TRANSMISSION**Rear Seal/Ext. Housing**

2004-1999	F450, F550 Super Duty	
Seal	7300S
Repair Sleeve	KWK99168

Selector Shaft Seal/Man. Shaft

2004-1990		
Seal	7929S

5-SPEED AUTOMATIC TRANSMISSION**Torque Converter**

2008-2005	(5R110W) Torqshift	
Seal	710485

Selector Shaft Seal/Man. Shaft

2008-2005		
Seal	7929S

CLUTCH**Pilot Bearing**

2001-1999	F550 Super Duty	
Ndle Bearing	FC65174
1992-1990	600 Ser. (Clark 5 Spd.)	
Ball Bearing	206FF
1992-1990	700 Ser. (Clark 5 Spd.)	
Ball Bearing	206FF
1992-1990	600 Ser. (Diesel)(Exc. 1986, 1992 Clark 5 Spd.)	
Ball Bearing	205SS
1992-1990	600 Ser. (Gas)(single plate Cl.)(Exc. 1979, 1988, P600 Ser.)	
Ball Bearing	202SS
1992-1990	600 Ser. 359, 361, 389, 391, 429	
Ball Bearing	205SS

Mfg./Year	Model & Location	Part No.	Mfg./Year	Model & Location	Part No.
FORD TRUCK - 1-1/2, 2, 2-1/2 TON - Motor Home Chassis, 400, 450, F53, F59, 500, 550, 600, 700 Series (cont.)					

CLUTCH (cont.)

Pilot Bearing (cont.)

1992-1990	700 Ser. (Diesel)(Exc.1986, 1992 Clark 5 Spd.)	
	Ball Bearing	205SS
1992-1990	700 Ser. (Gas)(single plate Cl.)	
	Ball Bearing	202SS
1992-1990	700 Ser. 359, 361, 389, 391, 429	
	Ball Bearing	205SS

Release Bearing

2001-1999	F550 Super Duty	
	Bearing Assy	614175
1994-1993	(Dbl. plate Cl.)	
	Bearing Assy	614087
1994-1993	(single plate Cl.)	
	Bearing Assy	614058
1992-1990	700 Ser. (3208 Cat Diesel)(13" & 14" Dbl. plate Cl.)	
	Bearing Only	FA02256C
1992-1990	600, 700 Ser. (Diesel)(Dbl. plate Cl.)	
	Bearing Only	FB02256C
1992-1990	600, 700 Ser. (Diesel)(single plate Cl.)	
	Bearing Only	FA02256C
1992-1990	600, 700 Ser. (Gas)(Dbl. plate Cl.)	
	Bearing Only	FD02256C
1992-1990	600, 700 Ser. (Gas)(single plate Cl.)	
	Bearing Only	F01757C

DRIVESHAFT SUPPORT

2007-1999	(Spicer 1410)(1.5748" 40mm Brg. I.D. 2.25" height)	
	Hanger Bearing Assy	HB88508A
	Ball Bearing	88508
1996-1993	(Spicer 1480)(1.5748" 40mm Brg. I.D.)	
	Hanger Bearing Assy	HB88508AA
1993-1990	(Spicer 1410)(1.5748" 40mm Brg. I.D. 2.25" height)	
	Hanger Bearing Assy	HB88508A
1992-1990	(Spicer 1260, 1280, 1310, 1380, 1410, 1480)(1.3780" Brg. I.D.)	
	Ball Bearing	88107[2]
	Hanger Bearing Assy	HB88107A[2]

CRANKSHAFT FRONT SEAL

8 Cylinder

2005-2000	330/5.4L	
	Seal	482041N
2003-1990	7.3L (Diesel)	
	Seal Viton	3894V
	Seal	5066 ²⁶
1997-1990	460/7.5L	
	Seal	2692

10 Cylinder

2007-1999	415/6.8L	
	Seal	482041N

CRANKSHAFT REAR SEAL

8 Cylinder

2005-2000	330/5.4L	
	Seal Viton	3909
	Repair Sleeve	KWK99362
2003-1994	444/7.3L (Diesel)	
	Seal	5723
1997-1990	460/7.5L	
	Seal Rope	5095
	Seal Split	5118
1993-1990	420/6.9L, 444/7.3L (Diesel)	
	Seal Viton	3893V
	Repair Sleeve	KWK99372

10 Cylinder

2007-1997	6.8L	
	Seal Viton	3909
	Repair Sleeve	KWK99362

²⁶Opt. Kit = 3894V Seal & Sleeve

GEO - (See also Chevrolet Imports from 1998) - Metro, Prizm, Storm**FRONT WHEEL****FWD**

1997-1995 Metro	
Seal (Inner)	710394[2]
Seal (Outer)	710175[2]
Ball Bearing (Inner)	510001[2]
1997-1993 Prizm	
Seal Kit	5696[2] ¹²
Ball Bearing	510007[2]
Hub Unit Bearing (Non-ABS)	518507[2] ⁰⁶
Seal (Inner)	1993[2]
Seal (Outer)	4898[2]
1994-1992 Metro LSI	
Seal (Inner)	710394[2]
Seal (Outer)	710175[2]
Ball Bearing (Inner)	510001[2]
1994-1992 Metro exc. LSI	
Seal (Inner)	4904[2]
Ball Bearing (Inner)	107DD[2]
Ball Bearing (Outer)	107DD[2]
1993-1990 Storm	
Seal	1953S[2]
Ball Bearing	510033[2]
1993-1990 Storm GSi	
Seal (Inner)	710194[2]
Bearing Assy (Inner)	517005WB[2]
Seal (Outer)	710192[2]
1992-1990 Prizm	
Seal (Inner)	1993[2]
Ball Bearing (Inner)	510007[2]
Seal (Outer)	4898[2]
1991-1990 Metro	
Seal (Inner)	4904[2]
Ball Bearing	107DD[2]

REAR WHEEL**FWD**

1997-1996 Prizm (ABS)	
Hub Unit Bearing	512184[2]
1997-1995 Metro (ABS)	
Hub Unit Bearing	512204[2]
1997-1993 Prizm (Non-ABS)	
Hub Unit Bearing	512018[2]
1997-1990 Metro (Non-ABS)	
Ball Bearing (Inner)	205F[2]
Ball Bearing (Outer)	204F[2]
1995-1993 Prizm (ABS)	
Hub Unit Bearing	512019[2]
1993-1990 Storm	
Hub Unit Bearing	512171[2]
1992-1990 Prizm	
Seal	1180S[2]
Ball Bearing	513031[2]

CLUTCH**Pilot Bearing**

1996-1990 3 Cyl. 1.0, (Turbo)	
Ball Bearing	200CC
1996-1990 4 Cyl. 1.3	
Ball Bearing	200CC

CLUTCH (cont.)**Pilot Bearing (cont.)**

1996-1990 4 Cyl. 1.6 (DOHC)	
Ball Bearing	200CC

Release Bearing

1996-1995 Metro 1.3	
Bearing Assy	614082
1996-1993 Prizm 1.8 (DOHC)	
Bearing Assy	614152
1996-1992 Prizm 1.6 (DOHC)	
Bearing Assy	614152
1996-1990 Metro 1.0	
Bearing Assy	614082
1993-1990 Storm	
Bearing Assy	614108
1991-1990 Prizm 1.6 (DOHC)	
Bearing Assy	614043

5-SPEED MANUAL TRANSMISSION**Selector Shaft Seal/Man. Shaft**

1997-1990 (Aisin C51, C52)	
Seal	1015N
1993-1990 (Isuzu MFD 5M)	
Seal	3667

3-SPEED AUTOMATIC TRANSAXLE**Differential**

1997-1992 (Aisin A210)	
Ball Bearing	207[2]
1997-1990 (Aisin A131)	
Seal	710416[2]
1992-1990 (Jatco F3A)	
Cone/Cup	XAA32008X-Y32008X[2]
1991-1990 (Aisin A210)(w/o Turbo)	
Ball Bearing	207S[2]

Torque Converter

1997-1990 Metro	
Seal	223830
Repair Sleeve	KWK99147
1997-1990 Prizm	
Seal	223830
Repair Sleeve	KWK99147
1993-1990 Storm	
Seal Viton	710078
Repair Sleeve	KWK99177

Output Shaft

1997-1990 Metro	
Seal	223540[2]
Repair Sleeve	KWK99139[2]
1997-1990 Prizm	
Seal	710110[2]
1993-1990 Spectrum, Storm	
Seal	223542[2]
Repair Sleeve	KWK99139[2]

⁰⁶Kit = 2 Seals, Studed Spindle, Bearing, Plate¹²Opt = Seal & O-Ring. Incl w/ Hub Unit.

Mfg./Year Model & Location Part No. Mfg./Year Model & Location Part No.

GEO - (See also Chevrolet Imports from 1998) - Metro, Prizm, Storm (cont.)

3-SPEED AUTOMATIC TRANSAXLE

Manual Shaft

1997-1990	Metro	
Seal	710116
1997-1990	Prizm	
Seal	221207
Repair Sleeve	KWK99049

4-SPEED AUTOMATIC TRANSAXLE

Differential

1997-1993	(Aisin A245)	
Seal	710416[2]
1993-1990	(Jatco JF403)	
Seal (LH)	710109
Bearing Assy (LH)	30208M
Seal (RH)	710110
Bearing Assy (RH)	30208M

Torque Converter / Frt Pump

1997-1990	Prizm	
Seal	223830
Repair Sleeve	KWK99147
1993	Storm	
Seal	710114

Output Shaft

1997-1990	Prizm	
Seal (LH)	710109
Seal (RH)	710110
1993-1990	Storm	
Seal (LH)	710109
Seal (RH)	710110

Manual Shaft

1997-1990	Prizm	
Seal	221207
Repair Sleeve	KWK99049

ALTERNATOR

1997-1990	Metro	
Ball Bearing (Drive End)	302CC

OIL PUMP

4 Cylinder

1997-1990	1474cc/1.5L, 1600cc/1.6L(DOHC)	
Seal	223235
Repair Sleeve	KWK99128

CAMSHAFT SEAL

3 Cylinder

1997-1990	Metro 1.0	
Seal	710310
Repair Sleeve	KWK99128

CAMSHAFT SEAL

4 Cylinder

1997-1995	Metro 1.3	
Seal	710310
Repair Sleeve	KWK99128
1997-1990	Prizm	
Seal	1987S
Repair Sleeve	KWK99139
1993-1990	Storm	
Seal	1217

CRANKSHAFT FRONT SEAL

4 Cylinder

1997-1995	Metro	
Seal	710310
Repair Sleeve	KWK99128
1997-1990	Prizm	
Seal	223235
Repair Sleeve	KWK99128
1993-1990	Storm	
Seal	223220
Repair Sleeve	KWK99128

3 Cylinder

1997-1990	1.0L	
Seal	710310

CRANKSHAFT REAR SEAL

3 Cylinder

1997-1990	Metro 1.0	
Seal	710334

GEO - Import SUV - Tracker**FRONT WHEEL****RWD**

1997-1990

Seal (Inner)	710240[2]
Bearing Assy (Inner)	517009[2]
Seal (Outer)	710239[2]

4WD

1997-1990

Seal (Inner)	710240[2]
Bearing Assy (Inner)	517009[2]
Seal (Outer)	710239[2]

REAR WHEEL**RWD**

1997-1990

Ball Bearing	511004[2] ¹⁵
--------------------	-------------------------

FRONT AXLE**Steering Knuckle**

1997-1990

Seal (Inner)	710255
Seal (Outer)	710256

4WD FRONT AXLE**Axle Shaft**

1997-1990

Seal Viton	710331[2]
Ball Bearing	206FF[2]

Differential

1997-1990

Cone/Cup	17887-17831[2]
----------------	----------------

Pinion

1997-1990

Bearing Assy (Inner)	30307M
Seal (Outer)	710523
Bearing Assy (Outer)	30306M

REAR AXLE**Differential**

1997-1990

Bearing Assy	KC11445Y[2]
--------------------	-------------

Pinion

1997-1990

Seal (Outer)	710523
Bearing Assy (Outer)	30306M
Bearing Assy (Inner)	30307M

TRANSFER CASE**Input Shaft**

1997-1990

Seal	223540
Repair Sleeve	KWK99139

Front Output Shaft

1997-1990

Seal	1213N
Repair Sleeve	KWK99157

3-SPEED AUTOMATIC TRANSMISSION**Selector Shaft Seal/Man. Shaft**

1995-1990

Seal	8792S
------------	-------

4-SPEED AUTOMATIC TRANSMISSION**Selector Shaft Seal/Man. Shaft**

1997-1995

Seal	8792S
------------	-------

CAMSHAFT SEAL**4 Cylinder**

1997-1990

Seal	710310
------------	--------

CRANKSHAFT FRONT SEAL**4 Cylinder**

1997-1990 1.6L

Seal	710310
------------	--------

CRANKSHAFT REAR SEAL**4 Cylinder**

1993-1990 1.6 L

Seal	710334
------------	--------

¹⁵New Bearing Design, Replaces Collar

Mfg./Year	Model & Location	Part No.	Mfg./Year	Model & Location	Part No.
GMC TRUCK - 1-1/2, 2, 2-1/2 TON - 4500 (Class 4), 5000, 5500 (Class 5), 6000, 6500 (Class 6), 7000, 7500 (Class 7)					

FRONT WHEEL

FWD

1999-1997	(12,000 lb. Axle W7R042HD)
Seal Viton (Inner)	370212A[2] ⁵⁷
Cone/Cup (Inner)	JF7049A-JF7010[2]
Bearing Assy (Outer)	33208[2]
1998-1997	(W6R042)
Seal Viton (Inner)	370199A[2] ⁵⁷
Cone (Inner)	JM205149[2]
Bearing Assy (Outer)	32207M[2]
1998-1997	(W7R042M)
Seal (Inner)	370211A[2] ⁵⁷
Bearing Assy (Inner)	32208M[2]
1998-1990	(16,000 lb. Axle C6H042, C7H042, C7H064)
Seal (Inner)	370182A[2] ⁵⁷
Cone/Cup (Inner)	6461A-6420[2]
Cone/Cup (Outer)	557S-552A[2]
1997-1993	(9,000 lb. Axle B6P042, C6D042)
Seal (Inner)	370211A[2] ⁵⁷
Bearing Assy (Inner)	33208[2]
1997-1990	(11,000 lb. Axle C6H042, C7H042, C7H064, W7R042HD)
Seal (Inner)	370211A[2] ⁵⁷
Bearing Assy (Outer)	33208[2]
1997-1990	(14,500 lb. Axle C6H042, C7H042, C7H064)
Seal Viton (Inner)	370212A[2] ⁵⁷
Cone/Cup (Inner)	JF7049A-JF7010[2]
Cone/Cup (Outer)	JM205149-JM205110[2]
1997-1990	W5S042
Seal (Inner)	710087[2]
Bearing Assy (Inner)	513046[2]
Bearing Assy (Outer)	513045[2] ^Z
1996-1991	(12,000 lb. Axle Late C6H042, C7H042, C7H064)
Seal (Inner)	370211A[2] ⁵⁷
Cone/Cup (Inner)	JF7049A-JF7010[2]
Bearing Assy (Outer)	33208[2]
1996-1990	(8,000 lb. Axle B7T042, C5H042, C6H042, C7H042, C7H064, P6S042)
Seal Viton (Inner)	370199A[2] ⁵⁷
Cone/Cup (Inner)	JM205149A-JM205110[2]
Bearing Assy (Outer)	32207M[2]
1996-1990	(W7R042M Hyd.Brks. Z06 Axle)
Seal (Inner)	710084[2]
Cone/Cup (Inner)	H414245X-H414210[2]
Bearing Assy (Outer)	513047[2] ^Z
1996-1990	(W7R042)(HD Axle)
Seal (Inner)	710084[2]
Cone/Cup (Inner)	H414245X-H414210[2]
Bearing Assy (Outer)	513047[2] ^Z
1996-1990	(W7R042M Hyd.Brks. Z05 Axle)
Seal (Inner)	710088[2]
Cone/Cup (Inner)	HM212047-HM212011[2]
Cone/Cup (Outer)	4388-4335[2]

FRONT WHEEL (cont.)

FWD (cont.)

1994-1990	(W7R042T)
Seal (Inner)	710088[2]
Cone/Cup (Inner)	H414245X-H414210[2]
Bearing Assy (Outer)	513047[2] ^Z
1991	(12,000 lb. Axle Early C6H042, C7H042, C7H064)
Seal Viton (Inner)	370212A[2] ⁵⁷
Cone/Cup (Inner)	JF7049A-JF7010[2]
Bearing Assy (Outer)	33208[2]
1991-1990	(9,000 lb. Axle C7D064)
Seal (Inner)	370018A[2] ⁵⁷
Cone/Cup (Inner)	39581-39520[2]
Cone/Cup (Outer)	26878-26820[2]
1991-1990	(7,000 lb. Axle F070, B6P042, C5D042, C6D042, C7D042, C7D064, P4T042, P6T042)
Seal (Inner)	8976S[2]
Cone/Cup (Inner)	45284-45220[2]
Cone/Cup (Outer)	2796-2720[2]
1990	(14,000 lb. Axle C6H042, C7H042, C7H064)
Seal Viton (Inner)	370212A[2] ⁵⁷
Cone/Cup (Inner)	JF7049A-JF7010[2]
Cone/Cup (Outer)	JM205149-JM205110[2]
1990	(12,000 lb. Axle B6P042, C6D042, P6T042, S7T042)
Seal (Inner)	45282A[2]
Cone/Cup (Inner)	HM212047-HM212011[2]
Cone/Cup (Outer)	45282-45220[2]
1990	(5,000 lb. Axle F050, C5D042, C6D042, C7D042, P4T042)
Seal (Inner)	8975S[2]
Cone/Cup (Inner)	3578A-3525[2]
Cone/Cup (Outer)	15103S-15243[2]
1990	(5,500 lb. Axle F055, C5D042, C6D042, C7D042, P4T042)
Seal (Inner)	8975S[2]
Cone/Cup (Inner)	3578A-3525[2]
Cone/Cup (Outer)	15103S-15243[2]

REAR WHEEL

RWD

1998-1997	(Dana/Spicer S150S)(W6R042)
Seal (Inner)	370008A[2] ⁵⁷
Cone/Cup (Inner)	33287-33462[2]
Cone/Cup (Outer)	3982-3920[2]
1997-1990	(Eaton 21065 Axle)(B7T042, C6H042, C7H042)
Seal (Inner)	370003A[2] ⁵⁷
Cone/Cup (Inner)	594A-592A[2]
Cone/Cup (Outer)	580-572[2]
1997-1990	(Eaton 22065 Axle)(B7T042, C6H042, C7H042)
Seal (Inner)	370003A[2] ⁵⁷
Cone/Cup (Inner)	594A-592A[2]
Cone/Cup (Outer)	580-572[2]

^ZNon-Cancellable/Non-Returnable

⁵⁷Oil Bath Seal

Mfg./Year	Model & Location	Part No.	Mfg./Year	Model & Location	Part No.
GMC TRUCK - 1-1/2, 2, 2-1/2 TON - 4500 (Class 4), 5000, 5500 (Class 5), 6000, 6500 (Class 6), 7000, 7500 (Class 7) (cont.)					

REAR WHEEL (cont.)**RWD (cont.)**

1997-1990	(Eaton 23070 Axle)(B7T042, C6H042, C7H042)	
Seal (Inner)	370003A[2] ⁵⁷
Cone/Cup (Inner)	594A-592A[2]
Cone/Cup (Outer)	580-572[2]
1997-1990	(Eaton 23085 Axle)(B7T042, C6H042, C7H042)	
Seal (Inner)	370003A[2] ⁵⁷
Cone/Cup (Inner)	594A-592A[2]
Cone/Cup (Outer)	580-572[2]
1997-1990	(Eaton 23105 Axle)(B7T042, C6H042, C7H042)	
Seal (Inner)	370023A[2] ⁵⁷
Cone/Cup (Inner)	594A-592A[2]
Cone/Cup (Outer)	47686-47620[2]
1997-1990	(Eaton 26085 Axle)(B7T042, C6H042, C7H042)	
Seal (Inner)	370003A[2] ⁵⁷
Cone/Cup (Inner)	594A-592A[2]
Cone/Cup (Outer)	580-572[2]
1997-1990	(Eaton 15040 Axle)	
Seal (Inner)	370008A[2] ⁵⁷
Cone/Cup (Inner)	33287-33462[2]
Cone/Cup (Outer)	3982-3920[2]
1996-1991	(Eaton 19050 Axle)(B7T042, P6S042)	
Seal (Inner)	370024A[2] ⁵⁷
Cone/Cup (Inner)	47686-47620[2]
Cone/Cup (Outer)	39590-39520[2]
1996-1990	(Eaton 19050 Axle)(C6H042, C7H042)	
Seal (Inner)	370023A[2] ⁵⁷
Cone/Cup (Inner)	47686-47620[2]
Cone/Cup (Outer)	39590-39520[2]
1996-1990	(Eaton 19055 Axle)(C6H042, C7H042)	
Seal (Inner)	370023A[2] ⁵⁷
Cone/Cup (Inner)	47686-47620[2]
Cone/Cup (Outer)	39590-39520[2]
1996-1990	(Eaton DS341, DT341, DS402 Axle)	
Seal (Inner)	370023A[2] ⁵⁷
Cone/Cup (Inner)	594A-592A[2]
Cone/Cup (Outer)	47686-47620[2]
1996-1990	(Rockwell 23160 Axle)	
Seal (Inner)	370003A[2] ⁵⁷
Cone/Cup (Inner)	594A-592A[2]
Cone/Cup (Outer)	580-572[2]
1996-1990	(Rockwell SL100P, SQ100P Axle)	
Seal (Inner)	370023A[2] ⁵⁷
Cone/Cup (Inner)	594-592A[2]
Cone/Cup (Outer)	47686-47620[2]
1996-1990	(W6R042)	
Seal (Inner)	710085[2]
Bearing Assy (Inner)	32215[2]
Seal (Outer)	710086[2]
Bearing Assy (Outer)	32213M[2]

REAR WHEEL (cont.)**RWD (cont.)**

1994-1990	W5S042	
Seal (Inner)	710085[2]
Bearing Assy (Inner)	32215[2]
Seal (Outer)	710086[2]
Bearing Assy (Outer)	32213M[2]
1994-1990	(W7R042M)	
Bearing Assy (Inner)	32216[2]
Bearing Assy (Outer)	32215[2]
1994-1990	(W7R042T)	
Seal (Inner)	710089[2]
Bearing Assy (Inner)	32219M[2]
Seal (Outer)	710090[2]
Bearing Assy (Outer)	32218M[2]
1994-1990	(W7R042T)	
Seal (Inner)	710089[2]
Bearing Assy (Inner)	32219M[2]
Seal (Outer)	710090[2]
Bearing Assy (Outer)	32218M[2]
1993-1990	(13,500 lb. H135 Axle)	
Seal (Inner)	370046A[2] ⁵⁷
Cone/Cup (Inner)	3984-3920[2]
Cone/Cup (Outer)	28682-28622A[2]
1993-1990	(15,000 lb. H150, T150 Axle)	
Seal (Inner)	370009A[2] ⁵⁷
Cone/Cup (Inner)	33287-33472[2]
Cone/Cup (Outer)	3982-3925[2]
1992-1990	(17,500 lb. H175, T175 Axle)	
Seal (Inner)	370009A[2] ⁵⁷
Cone/Cup (Inner)	495AX-493[2]
Cone/Cup (Outer)	39590-39520[2]
1992-1990	(19,000 lb. Eaton 17121, 17221 Axle)	
Seal (Inner)	370023A[2] ⁵⁷
Cone/Cup (Inner)	47686-47620[2]
Cone/Cup (Outer)	39590-39520[2]
1990	(Eaton 19050 Axle)	
Seal (Inner)	370023A[2] ⁵⁷
Cone/Cup (Inner)	47686-47620[2]
Cone/Cup (Outer)	39590-39520[2]

SINGLE REAR AXLE**Differential Rebuild Kit**

1997-1990	(Eaton 26085P, 26085T Axles)	
Kit	DRK72A
1997-1990	(Eaton 19050T, 19055D, 19055S, 19055T axle)	
Kit	DRK23D
1997-1990	(Eaton 15040T Axle)	
Kit	DRK24
1997-1990	(Eaton 15101 Axle)	
Kit	DRK24
1997-1990	(Eaton 23221 Axle)	
Kit	DRK72A
1994-1990	(Dana/Spicer M185T, M190T, M220T Axles)	
Kit	DRK214
1991-1990	(Eaton 17401 Axle)	
Kit	DRK23B
1991-1990	(Eaton 16121 Axle)	
Kit	DRK23B

⁵⁷Oil Bath Seal

Mfg./Year	Model & Location	Part No.	Mfg./Year	Model & Location	Part No.
GMC TRUCK - 1-1/2, 2, 2-1/2 TON - 4500 (Class 4), 5000, 5500 (Class 5), 6000, 6500 (Class 6), 7000, 7500 (Class 7) (cont.)					

SINGLE REAR AXLE

Differential

1998-1990	(Rockwell 23160 Axle)	
	Bearing Assy	32021X[2]
1997-1990	(Eaton 15040T Axle)	
	Cone/Cup (LH)	498-493
	Cone/Cup (RH)	33275-33472
1997-1990	(Eaton 26085P, 26085T axle)(130537 case)	
	Cone/Cup (LH)	68462-68712
	Cone/Cup (RH)	42346-42584
1997-1990	(Eaton 26085P, 26085T axle)(27950 case)	
	Cone/Cup (LH)	68450-68712
	Cone/Cup (RH)	42346-42584
1997-1990	(Eaton 15040S Axle)	
	Cone/Cup (LH)	3994-3920
	Cone/Cup (RH)	497-493
1997-1990	(Eaton 19050S Axle)	
	Cone/Cup (LH)	3994-3920
	Cone/Cup (RH)	497-493
1997-1990	(Eaton 19050T, 19055D, 19055S, 19055T axle)	
	Cone/Cup (LH)	42381-42584
	Cone/Cup (RH)	495A-493
1997-1990	(Eaton 21065S, 23070S, 23105S Axles)	
	Cone/Cup (LH)	598-592A
	Cone/Cup (RH)	497-493
1997-1990	(Eaton 21065T Axle)	
	Cone/Cup (LH)	56425-56650
	Cone/Cup (RH)	497-493
1997-1990	(Eaton 23070P, 23070T Axles)	
	Cone/Cup (LH)	56425-56650
	Cone/Cup (RH)	497-493
1997-1990	(Eaton 17200, 17220, 17221, 17800, 17801, 18221, 7800 Axles)	
	Cone/Cup (LH)	56425-56650
	Cone/Cup (RH)	497-493
1996-1990	(Isuzu R077 Axle)	
	Bearing Assy	30214[2]
1995-1990	(Isuzu R065 Axle)	
	Cone/Cup	3984-3920[2]
1994-1990	(Isuzu R094 Axle)	
	Bearing Assy	32216[2]
1994-1990	(Dana/Spicer M185T, M190S, M190T, M220T Axles)	
	Cone/Cup (LH)	JM822049-JM822010
	Cone/Cup (RH)	JM716649-JM716610
1992-1990	(H110 Axle)	
	Cone/Cup	395-394A[2]
1991-1990	(Eaton 17401 Axle)	
	Cone/Cup (LH)	567-563
	Cone/Cup (RH)	3994-3920
1991-1990	(Eaton 16121 Axle)	
	Cone/Cup (LH)	567-563
	Cone/Cup (RH)	3994-3920

SINGLE REAR AXLE

Pinion

1998-1990	(Eaton 21065S Axle)	
	Cone/Cup (Inner)	78215C-78551
	Seal (Outer)	9773R[2]
	Cone/Cup (Outer)	55200C-55437
	Cylindrical Bearing	MUS1308UM[2]
1998-1990	(Rockwell 23160 Axle)	
	Cone/Cup (Inner)	9278-9220
	Seal (Outer)	417987N
	Cone/Cup (Outer)	HM813843-HM813810
1998-1990	(Eaton 19050T, 19055D, 19055S, 19055T Axle)(2.375" Pinion Shaft)	
	Cone/Cup (Inner)	55175C-55437
	Seal (Outer)	475095N
	Cone/Cup (Outer)	55175C-55437
	Cylindrical Bearing	MUS1307UM[2]
1998-1990	(Eaton 19050T, 19055D, 19055S, 19055T)(2.625" pinion shaft)	
	Cone/Cup (Inner)	55175C-55437
	Seal (Outer)	475095N
	Cone/Cup (Outer)	55175C-55437
	Cylindrical Bearing	MUS1307UM[2]
1998-1990	(Eaton 23070P, 23070T Axles)	
	Cone/Cup (Inner)	78215C-78551
	Seal (Outer)	712937
	Cone/Cup (Outer)	72212C-72487
	Cylindrical Bearing	MUB5207UM[2]
1998-1990	(Eaton 23070S Axle)	
	Cone/Cup (Inner)	H913842-H913810
	Seal (Outer)	712937
	Cone/Cup (Outer)	72212C-72487
	Cylindrical Bearing	MUS1308UM[2]
1998-1990	(Eaton 23105S axle)	
	Cone/Cup (Inner)	H913842-H913810
	Seal (Outer)	712937
	Cone/Cup (Outer)	72212C-72487
	Cylindrical Bearing	MUS1308UM[2]
1998-1990	(Eaton 21065T Axle)	
	Cone/Cup (Inner)	72200C-72487
	Seal (Outer)	9773R[2]
	Cone/Cup (Outer)	55200C-55437
	Cylindrical Bearing	MUS1307UM[2]
1998-1990	(Eaton 23221, 23421, 26085P, 26085T axle)	
	Cone/Cup (Inner)	78215C-78551
	Seal (Outer)	712937
	Cone/Cup (Outer)	72212C-72487
	Cylindrical Bearing	MUS1308UM[2]
1997-1990	(Eaton 15040T Axle)	
	Cone/Cup (Inner)	HM903249-HM903210
	Seal Kit (Outer)	722250S ²⁰
	Cone/Cup (Outer)	HM903249-HM903210
	Cylindrical Bearing	MU1305TDM[2]
1997-1990	(Eaton 15040S Axle)	
	Cone/Cup (Inner)	55175C-55437
	Seal (Outer)	9773R
	Cone/Cup (Outer)	HM903249-HM903210
	Cylindrical Bearing	MUB1305UDM[2]

²⁰Seal Kit

Mfg./Year	Model & Location	Part No.	Mfg./Year	Model & Location	Part No.
GMC TRUCK - 1-1/2, 2, 2-1/2 TON - 4500 (Class 4), 5000, 5500 (Class 5), 6000, 6500 (Class 6), 7000, 7500 (Class 7) (cont.)					

SINGLE REAR AXLE (cont.)**Pinion (cont.)**

1996-1990 (Eaton 19050S Axle)	
Cone/Cup (Inner)	72200C-72487
Seal (Outer)	9773R
Cone/Cup (Outer)	HM903249-HM903210
Cylindrical Bearing	RUB1570UM[2]
1995-1990 (Isuzu R065 Axle)	
Bearing Assy (Inner)	30310
Seal (Outer)	710276
Bearing Assy (Outer)	30309M
1995-1990 (Isuzu R077 Axle)	
Bearing Assy (Inner)	30310
Seal (Outer)	710276
Bearing Assy (Outer)	30309M
1994-1990 (Dana/Spicer M220T axle)	
Cone/Cup (Inner)	72225C-72487
Seal (Outer)	477163N
Cone/Cup (Outer)	55200C-55437
Cylindrical Bearing	MUS1308UM[2]
1994-1990 (Isuzu R094 Axle)	
Bearing Assy (Inner)	30310
Seal (Outer)	710275
Bearing Assy (Outer)	30311
1994-1990 (Isuzu R105 Axle)	
Bearing Assy (Inner)	30312
Seal (Outer)	710275
Cone/Cup (Outer)	580-572
1991-1990 (Eaton 17401 axle)(2.625" pinion shaft)	
Cone/Cup (Inner)	HM903249-HM903210
Seal (Outer)	712625
Cone/Cup (Outer)	HM903249-HM903210
Cylindrical Bearing	MUS1307UM[2]
1991-1990 (Eaton 16121, 16221, 16802)(2.375" pinion shaft)	
Cone/Cup (Inner)	HM903249-HM903210
Seal (Outer)	712375
Cone/Cup (Outer)	HM903249-HM903210
Cylindrical Bearing	MUS1307UM[2]
1991-1990 (Eaton 16121, 16221, 16802)(2.625" pinion shaft)	
Cone/Cup (Inner)	HM903249-HM903210
Seal (Outer)	712625
Cone/Cup (Outer)	HM903249-HM903210
Cylindrical Bearing	MUS1307UM[2]
1991-1990 (Eaton 17401 axle)(2.375" pinion shaft)	
Cone/Cup (Inner)	HM903249-HM903210
Seal (Outer)	712375
Cone/Cup (Outer)	HM903249-HM903210
Cylindrical Bearing	MUS1307UM[2]

TANDEM REAR AXLE - FRONTMOST AXLE**Differential Rebuild Kit**

1997-1990 (Eaton DS341 Axle)	
Kit	DRK196
1997-1990 (Eaton DT341, DS402, DT402 Axles)	
Kit	DRK207

Differential

1998-1990 (Eaton DS341 Axle)	
Cone/Cup (LH)	497-493
Cone/Cup (RH)	567-563
1998-1990 (Eaton DT341, DS402, DT402 Axles)	
Cone/Cup (LH)	497-493
Cone/Cup (RH)	56425-56650
1998-1990 (Rockwell SL100P, SQ100P Axles)	
Cone/Cup (LH)	JM716649-JM716610
Cone/Cup (RH)	JM716649-JM716610

Pinion

1998-1990 (Rockwell SL100P, SQ100P Axles)	
Cone/Cup (Inner)	72212C-72487
Cone/Cup (Outer)	72212C-72487
Cylindrical Bearing	RU1570UM[2]
1997-1990 (Eaton DS341 Axle)	
Cone/Cup (Inner)	55200C-55437
Seal (Outer)	9773R
Cone/Cup (Outer)	55200C-55437
Cylindrical Bearing	MUS1307UM[2]
1997-1990 (Eaton DT341, DS402, DT402 Axles)	
Cone/Cup (Inner)	72218C-72487
Cone/Cup (Outer)	HM807049-HM807010
Cylindrical Bearing	MUS1307UM[2]

TANDEM REAR AXLE - REARMOST AXLE**Differential Rebuild Kit**

1998-1990 (Eaton DT341, DS402, DT402 Axles)	
Kit	DRK207
1996-1990 (Eaton DS341 Axle)	
Kit	DRK196

Differential

1998-1990 (Eaton DS341 Axle)	
Cone/Cup (LH)	497-493
Cone/Cup (RH)	567-563
1998-1990 (Eaton DT341, DS402, DT402 Axles)	
Cone/Cup (LH)	497-493
Cone/Cup (RH)	56425-56650
1998-1990 (Rockwell SL100P, SL100Q Axles)	
Cone/Cup (LH)	JM716649-JM716610
Cone/Cup (RH)	JM716649-JM716610

Mfg./Year	Model & Location	Part No.	Mfg./Year	Model & Location	Part No.
GMC TRUCK - 1-1/2, 2, 2-1/2 TON - 4500 (Class 4), 5000, 5500 (Class 5), 6000, 6500 (Class 6), 7000, 7500 (Class 7) (cont.)					

TANDEM REAR AXLE - REARMOST AXLE

Pinion

1998-1990	(Eaton DS341 Axle)
Cone/Cup (Inner)	55200C-55437
Seal (Outer)	9773R
Cone/Cup (Outer)	55200C-55437
Cylindrical Bearing	MUS1307UM[2]
1998-1990	(Eaton DT341, DS402, DT402 Axles)
Cone/Cup (Inner)	72218C-72487
Cone/Cup (Outer)	HM807049-HM807010
Cylindrical Bearing	MUS1307UM[2]
1998-1990	(Rockwell SL100P, SL100Q Axles)
Cone/Cup (Inner)	72212C-72487
Seal (Outer)	3905
Cone/Cup (Outer)	72212C-72487
Cylindrical Bearing	RU1570UM[2]

CLUTCH

Pilot Bearing

1997-1990	350, 366, 427, 4 53
Ball Bearing	205FF
1992-1990	(3208 Caterpillar Diesel)
Ball Bearing	305DD
1992-1990	8.2 L (Detroit Diesel)(2.44")
Ball Bearing	305DD
1992-1990	8.2 L (Detroit Diesel)(2.047")
Ball Bearing	205FF

Release Bearing

1997-1990	366 (Spicer 13" Cl.)
Bearing Assy	614057
1997-1990	427 (Spicer 13" Cl.)
Bearing Assy	614057
1994-1990	6 Cyl. 6.5 L (Turbo Diesel)
Bearing Only	613009
1992-1990	8.2 L (Detroit Diesel)(Lipe flywheel)
Bearing Only	GE2505C
1992-1990	8.2 L (Detroit Diesel)(flat flywheel)
Bearing Assy	614065
1992-1990	(w/o 292, 350, 8.2 L)
Bearing Assy	614024
1992-1990	292, 350 (12" Cl.)
Bearing Assy	614018 ⁴²
1990	427 (12" dual Disc Cl.)(Fuller Trans.)
Bearing Only	613007
1990	427 (12" dual Disc Cl.)(Spicer Trans.)
Bearing Assy	614019
1990	350 (12" Cl.)
Bearing Assy	614018 ⁴²

CRANKSHAFT FRONT SEAL

6 Cylinder

1996-1990	403/6.6L (Turbo Diesel)
Seal	3945
Repair Sleeve	KWK99233
1995-1990	5785cc/5.8L (Turbo Diesel)
6494cc/6.5L (Diesel)	
6494cc/6.5L (Turbo Diesel)	
Seal Viton	710350
Repair Sleeve	KWK99235

8 Cylinder

1996-1990	366/6.0L, 427/7.0L
Seal	3945
Repair Sleeve	KWK99233
1991-1990	500/8.2L (Diesel) 500/8.2L (Turbo Diesel)
Seal	473476
Repair Sleeve	KWK99250
1990	636/10.4L (Diesel) 636/10.4L (Turbo Diesel)
Seal	39802
Repair Sleeve	KWK99287
1990	636/10.4L Diesel (2.375" shaft)
Seal	480988H
Repair Sleeve	KWK99237

CRANKSHAFT REAR SEAL

6 Cylinder

1996-1990	403/6.6L (Turbo Diesel)
Seal Viton	2261
Repair Sleeve	KWK99435
1995-1990	5785cc/5.8L (Turbo Diesel)
6494cc/6.5L (Diesel)	
6494cc/6.5L (Turbo Diesel)	
Seal Viton	710349
Repair Sleeve	KWK99413

8 Cylinder

1996-1990	366/6.0L, 427/7.0L
Seal Viton	2261
Repair Sleeve	KWK99435
1991-1990	500/8.2L (Diesel) 500/8.2L (Turbo Diesel)
Seal	455956H
1990	636/10.4L (Diesel) 636/10.4L (Turbo Diesel)
Seal	39801
Repair Sleeve	KWK99499

⁴²Self-Aligning Brg

Mfg./Year Model & Location Part No. Mfg./Year Model & Location Part No.

GRUMMAN - REAR DRIVE - Postal Vehicle**FRONT WHEEL****RWD**

1995-1990

Seal (Inner) 4739[2]
 Set (Inner) SET6[2]
 Set (Outer) SET34[2]

REAR WHEEL**RWD**

1994-1990

Cylindrical Bearing 513023[2]
 Bearing & Seal Kit TRP57509[2]¹⁹

REAR AXLE**Differential Rebuild Kit**

1995-1990

Kit DRK320

HONDA - Accord**FRONT WHEEL****FWD**

2008

Ball Bearing WB000019[2]²⁵

2007-2003

Ball Bearing 510073[2]

2002-1998

Ball Bearing 510050[2]

1997-1995 (6 Cyl.)

Bearing Module 510038[2]

1997-1990 (4 Cyl.)

Bearing Module 513098[2]

1990 EX

Hub Unit Bearing HA594460K[2]

REAR WHEEL**FWD**

2008

Hub Unit Bearing HA590202[2]

2007-2003

Hub Unit Bearing 512188[2]

2002-1998 (4 Cyl.)(Disc)

Hub Unit Bearing 512178[2]

2002-1998 (4 Cyl.)(Drum)

Hub Unit Bearing 512176[2]

2002-1998 (6 Cyl.)(Rear Disc)

Hub Unit Bearing 512179[2]

1997-1995 (4 Cyl.)(Disc)

Hub Unit Bearing 512020[2]

1997-1995 (4 Cyl.)(Drum)

Hub Unit Bearing 513080[2]

1997-1995 (6 Cyl.)(Rear Disc)

Hub Unit Bearing 512172[2]

1997-1991 (Wagon)(Drum)

Hub Unit Bearing 512122[2]

1994 (Coupe)(Sedan)(ABS)(Disc)

Hub Unit Bearing 512020[2]

1994 (Wagon)(Disc)

Hub Unit Bearing 512172[2]

1994-1990 (Coupe)(Sedan)(Drum)

Hub Unit Bearing 513080[2]

1993-1992 (Coupe)(Sedan)(Disc)

Hub Unit Bearing 513081[2]

REAR WHEEL (cont.)**FWD (cont.)**

1993-1991 (Wagon)(Disc)

Hub Unit Bearing 512032[2]

1991-1990 (ABS)(Disc)

Hub Unit Bearing 513081[2]

1991-1990 (Non-ABS)(Disc)

Hub Unit Bearing 513080[2]

CLUTCH**Release Bearing**

2002-1990

Bearing Assy 614072

4-SPEED AUTOMATIC TRANSAXLE**Differential**

2000-1990

Ball Bearing 208[2]

Torque Converter / Frt Pump

2002-1990

Seal 350609

Input Shaft

2002-1998

Seal 220918

Output Shaft

2002-1998 (4 Cyl.)

Seal Viton (LH) 224026

Repair Sleeve (LH) KWK99157

Seal (RH) 224066

Repair Sleeve (RH) KWK99157

2002-1998 (6 Cyl.)

Seal (LH) 710199

Repair Sleeve (LH) KWK99076

Seal Viton (RH) 224026

Repair Sleeve (RH) KWK99157

¹⁹Opt. Axle Rpr Brg. Replaces O.E. Brg & Seal²⁵New Item, Check For Availability

Mfg./Year	Model & Location	Part No.	Mfg./Year	Model & Location	Part No.
-----------	------------------	----------	-----------	------------------	----------

HONDA - Accord (cont.)

4-SPEED AUTOMATIC TRANSAXLE (cont.)

Output Shaft (cont.)

1997-1995 (6 Cyl.)	
Seal (LH)	712551
Repair Sleeve (LH)	KWK99157
Seal (RH)	224066
Repair Sleeve (RH)	KWK99157
1997-1990 (4 Cyl.)	
Seal Viton (LH)	224026[2]
Seal (RH)	224066
Repair Sleeve	KWK99157[2]
1993-1992 (4 Cyl.)(MPWA)	
Seal (RH)	224025
Seal (LH)	710173
Repair Sleeve	KWK99196

Manual Shaft

2005-1990	
Seal	221207
Repair Sleeve	KWK99049

5-SPEED AUTOMATIC TRANSAXLE

Output Shaft

2007-2003	
Seal (RH)	710300
Seal (LH)	710217
Repair Sleeve	KWK99157

5-SPEED MANUAL TRANSAXLE

Differential

2005-2004 (4 Cyl.)	
Ball Bearing	208S[2]

Input Shaft

2002-1994	
Seal	222830
Repair Sleeve	KWK99106
1993-1990	
Seal Viton	222742
Repair Sleeve	KWK99106

Output Shaft

2002-1994	
Seal (LH)	710315
Repair Sleeve (LH)	KWK99139
Seal (RH)	3459S
Repair Sleeve (RH)	KWK99157
1993-1990	
Seal (LH)	2007N
Repair Sleeve (LH)	KWK99139
Seal (RH)	3459S
Repair Sleeve (RH)	KWK99157

5-SPEED MANUAL TRANSAXLE

Selector Shaft Seal/Man. Shaft

2002-1990	
Seal	221607

ALTERNATOR

2000-1990 (Nippondenso)	
Ball Bearing (Drive End)	203FF
Ball Bearing (Rear End)	201CC
1998-1990 Mitsubishi	
Ball Bearing (Drive End)	303CC
Ball Bearing (Rear End)	201CC

OIL PUMP

4 Cylinder

2002-1990	
Seal Viton	712009
Repair Sleeve	KWK99106

6 Cylinder

2008-1995	
Seal	711181

CAMSHAFT SEAL

4 Cylinder

2005-1990	
Seal	712008
Repair Sleeve	KWK99111

6 Cylinder

2002-1998 3.0L	
Seal	710451[2]
Repair Sleeve	KWK99147[2]
1997-1995 2.7L	
Seal Viton	713771[2]
Repair Sleeve	KWK99139[2]

CRANKSHAFT FRONT SEAL

4 Cylinder

2002-1990 2156cc/2.2L, 2254cc/2.3L	
Seal	224015
Repair Sleeve	KWK99157

6 Cylinder

2002-1995	
Seal	1181
Repair Sleeve	KWK99162

CRANKSHAFT REAR SEAL

4 Cylinder

2008-2003 2354cc/2.4L	
Seal Viton	228008
2002-1999	
Seal	228015
Repair Sleeve	KWK99315
1998-1990	
Seal	228015
Repair Sleeve	KWK99315

Mfg./Year	Model & Location	Part No.	Mfg./Year	Model & Location	Part No.
-----------	------------------	----------	-----------	------------------	----------

HONDA - Accord (cont.)**CRANKSHAFT REAR SEAL****6 Cylinder**

2008-1995 2.7L, 3.0L, 3.5L

Seal Viton 228008

Repair Sleeve KWK99315

HONDA - Accord Hybrid**FRONT WHEEL****FWD**

2007-2005

Ball Bearing 510073[2]

REAR WHEEL**FWD**

2007-2005

Hub Unit Bearing HA590019[2]²⁵**HONDA - Civic, Civic Hybrid****FRONT WHEEL****FWD**

2009-2006 Hybrid

Bearing Assy 510089[2]²⁵

2008-2006 1.8L, Japan Built

Ball Bearing 510073[2]

2008-2006 1.8L, USA Built

Bearing Assy 510089[2]²⁵

2008-2006 2.0L

Ball Bearing 510073[2]

2005-2004 SI

Ball Bearing 510050[2]

2005-2003 Hybrid

Ball Bearing 510030[2]

2005-2001 DX, EX, HX, LX, SI

Ball Bearing 510030[2]

2000-1992 DX, HX

Ball Bearing 510015[2]

2000-1992 EX, SI

Ball Bearing 510030[2]

1991-1990

Ball Bearing 513024[2]

4WD

1991-1990

Ball Bearing 513024[2]

REAR WHEEL**FWD**

2009-2006 Hybrid

Hub Unit Bearing 512322[2]²⁵

2008-2006 Coupe, Sedan, (w/o GX)

Hub Unit Bearing HA590152[2]²⁵

2008-2006 Sedan (w/ GX)

Hub Unit Bearing 512322[2]²⁵**REAR WHEEL (cont.)****FWD (cont.)**

2007-2006 (Disc)

Hub Unit Bearing HA590164[2]²⁵

2005-2004 SI (ABS)

Hub Unit Bearing HA590005[2]

2005-2003 Hybrid

Hub Unit Bearing 512175[2]

2005-2001 DX, HX, LX (Non-ABS)

Hub Unit Bearing 512174[2]

2005-2001 EX

Hub Unit Bearing 512175[2]

2003-2002 SI (ABS)

Hub Unit Bearing HA590009[2]²⁵

2000-1995 (Disc)

Hub Unit Bearing 513105[2]

2000-1995 (Drum)(14" Wheel)

Hub Unit Bearing 513105[2]

2000-1992 (Non-ABS)(Drum)

Hub Unit Bearing 513035[2]

Seal 473367[2]

1991-1990 (Wagon)

Hub Unit Bearing 513033[2]

1991-1990

Hub Unit Bearing 513035[2]

Seal 473367[2]

4WD

1991-1990 (Wagon)(4WD)

Set SET35[2]

²⁵New Item, Check For Availability

Mfg./Year Model & Location Part No. Mfg./Year Model & Location Part No.

HONDA - Civic, Civic Hybrid (cont.)

REAR AXLE

Differential

1991-1990 (Wagon)(4WD)
 Seal 710110[2]
 Ball Bearing 208[2]

Pinion

1991-1990 (Wagon)(4WD)
 Seal 223843
 Bearing Assy (Inner) 32008XM
 Bearing Assy (Outer) 32306
 Repair Sleeve KWK99147

CLUTCH

Pilot Bearing

2005-1990
 Ball Bearing 102CC

Release Bearing

2005-2000
 Bearing Assy 614176
 2003 Civic Hybrid
 Bearing Assy 614122
 2000-1992
 Bearing Assy 614122
 1991-1990 1.6, (2WD)
 Bearing Assy 614146
 1991-1990 1.6L, (4WD)
 Bearing Assy 614031
 1991-1990 1.5L
 Bearing Assy 614146

4-SPEED AUTOMATIC TRANSAXLE

Differential

2002-2001 (MLYA)
 Ball Bearing 208S[2]
 2000-1990
 Ball Bearing 208[2]

Torque Converter / Frt Pump

2005-1990
 Seal 350609

Input Shaft

2002-2001 (MLYA)
 Ball Bearing 305AG[2]

Output Shaft

2005-1996
 Seal (LH) 710314
 Seal (LH) (S4RA) 710315
 Seal (RH) 1147
 Repair Sleeve KWK99139
 1995-1994
 Seal Viton (LH) (MPOA) 224026
 Seal (RH) (MPOA) 224066
 Repair Sleeve (MPOA) KWK99157

4-SPEED AUTOMATIC TRANSAXLE (cont.)

Output Shaft (cont.)

1995-1990
 Seal (LH) (S24A) 710314
 Seal (LH) (A24A)(L4) 223543
 Seal (RH) 1147
 Repair Sleeve KWK99139

Manual Shaft

2008-1990
 Seal 221207
 Repair Sleeve KWK99049

5-SPEED MANUAL TRANSAXLE

Transaxle Rebuild Kit

2000-1992 Civic
 Kit TRKH150

Differential

2005-1997
 Ball Bearing 208S[2]
 1996-1990
 Ball Bearing 207[2]

Input Shaft

2002-1990
 Seal Viton 222742
 Repair Sleeve KWK99106

Output Shaft

2002-1990
 Seal (LH) 710315
 Repair Sleeve (LH) KWK99139
 Seal (RH) 4901
 Repair Sleeve (RH) KWK99139

Selector Shaft Seal/Man. Shaft

2002-1990
 Seal 221607

ALTERNATOR

1993-1990 Mitsubishi
 Ball Bearing (Drive End) 303CC
 Ball Bearing (Rear End) 201CC

CV JOINT HALF SHAFT

2000-1992
 Seal 710300
 1991-1990 (Wagon)(4WD)
 Seal (Inner) 710161
 Ball Bearing (Inner) 108FFN
 Seal (Outer) 710147

Mfg./Year	Model & Location	Part No.	Mfg./Year	Model & Location	Part No.
-----------	------------------	----------	-----------	------------------	----------

HONDA - Civic, Civic Hybrid (cont.)**CAMSHAFT SEAL****4 Cylinder**

2005-2001	1.7L	
Seal		320595
2002-1990	1.6L	
Seal		320595

CRANKSHAFT FRONT SEAL**4 Cylinder**

2005-2003	1.3L	
Seal		473677
2005-2001	1.7L	
Seal		320595
2000-1990	1493cc/1.5L, 1594cc/1.6L	
Seal		710332
Seal Viton		1121
Repair Sleeve		KWK99125

CRANKSHAFT REAR SEAL**4 Cylinder**

2008-2002	1.3L, 2.0L	
Seal Viton		228008
Repair Sleeve		KWK99315
2005-2001	1.7L	
Seal		228009
2000-1990	1.3L, 1.5L, 1.6L	
Seal		228015
Repair Sleeve		KWK99315

HONDA - CRX**REAR WHEEL****FWD**

1991-1990		
Seal		473677[2]
Hub Unit Bearing		513035[2]

CLUTCH**Pilot Bearing**

1991-1990		
Ball Bearing		102CC

Release Bearing

1991-1990		
Bearing Assy		614077

4-SPEED AUTOMATIC TRANSAXLE**Differential**

1991-1990		
Ball Bearing		208[2]

Torque Converter / Frt Pump

1991-1990		
Seal		350609

Output Shaft

1991-1990		
Seal (LH)		4901
Repair Sleeve (LH)		KWK99139
Seal (RH)		1147
Repair Sleeve (RH)		KWK99139

4-SPEED AUTOMATIC TRANSAXLE**Manual Shaft**

1991-1990		
Seal		221207
Repair Sleeve		KWK99049

5-SPEED MANUAL TRANSAXLE**Differential**

1991-1990		
Ball Bearing (LH)		207
Ball Bearing (RH)		208

Input Shaft

1991-1990		
Seal Viton		222742
Repair Sleeve		KWK99106

Output Shaft

1991-1990	1.6L	
Seal (LH)		224025
Repair Sleeve (LH)		KWK99157
Seal (RH)		4901
Repair Sleeve (RH)		KWK99139
1991-1990	1.5L	
Seal (LH)		2007N
Seal (RH)		4901
Repair Sleeve (RH) (All)		KWK99139

Selector Shaft Seal/Man. Shaft

1991-1990		
Seal		710243
Repair Sleeve		KWK99058

Mfg./Year	Model & Location	Part No.	Mfg./Year	Model & Location	Part No.
-----------	------------------	----------	-----------	------------------	----------

HONDA - CRX (cont.)

ALTERNATOR

1991-1990	Mitsubishi	
	Ball Bearing (Drive End)	303CC
	Ball Bearing (Rear End)	201CC

CAMSHAFT SEAL

4 Cylinder

1991-1990	1.6L	
	Seal	320595
	Repair Sleeve	KWK99112
1991-1990	1.5L	
	Seal	320595
	Repair Sleeve	KWK99112

CRANKSHAFT FRONT SEAL

4 Cylinder

1991-1990	1.6L	
	Seal	710332
	Seal Viton	1121
	Repair Sleeve	KWK99125
1991-1990	1.5L	
	Seal	710332
	Seal Viton	1121
	Repair Sleeve	KWK99125

CRANKSHAFT REAR SEAL

4 Cylinder

1991-1990	1.6L	
	Seal	228015
1991-1990	1.5L	
	Seal	228015

HONDA - Del Sol

FRONT WHEEL

FWD

1997-1994	(ABS)	
	Ball Bearing	510030[2]
1997-1993	(Non-ABS)	
	Ball Bearing	510015[2]

REAR WHEEL

FWD

1997-1995	(ABS)(Disc)	
	Hub Unit Bearing	513105[2]
1997-1995	(Non-ABS)(Disc)	
	Hub Unit Bearing	513105[2]
1997-1993	(Drum)	
	Hub Unit Bearing	513035[2]
	Seal	473677[2]
1994-1993	(Disc)	
	Hub Unit Bearing	513105[2]

CLUTCH

Pilot Bearing

1997-1993		
	Ball Bearing	102CC

Release Bearing

1997-1993		
	Bearing Assy	614122

4-SPEED AUTOMATIC TRANSAXLE

Differential

1997-1993		
	Ball Bearing	208[2]

Torque Converter / Frt Pump

1997-1993		
	Seal	350609

Output Shaft

1997-1993		
	Seal (LH)	223543
	Repair Sleeve (LH)	KWK99139
	Seal (RH)	1147
	Repair Sleeve (RH)	KWK99139

Manual Shaft

1997-1993		
	Seal	221207
	Repair Sleeve	KWK99049

5-SPEED MANUAL TRANSAXLE

Differential

1997-1993		
	Ball Bearing	207[2]

Mfg./Year	Model & Location	Part No.	Mfg./Year	Model & Location	Part No.
-----------	------------------	----------	-----------	------------------	----------

HONDA - Del Sol (cont.)**5-SPEED MANUAL TRANSAXLE****Input Shaft**

1997-1993
 Seal Viton 222742
 Repair Sleeve KWK99106

Output Shaft

1997-1993 S, SI
 Seal (LH) 2007N
 Repair Sleeve (LH) KWK99139
 Seal (RH) 4901
 Repair Sleeve (RH) KWK99139

Selector Shaft Seal/Man. Shaft

1997-1993
 Seal 221607

ALTERNATOR

1997-1993 Mitsubishi
 Ball Bearing (Drive End) 303CC

CAMSHAFT SEAL**4 Cylinder**

1997-1993
 Seal 320595

CRANKSHAFT FRONT SEAL**4 Cylinder**

1997-1993
 Seal 710332
 Seal Viton 1121
 Repair Sleeve KWK99123

CRANKSHAFT REAR SEAL**4 Cylinder**

1997-1993
 Seal 228015

HONDA - Fit**FRONT WHEEL****FWD**

2008-2007
 Bearing Assy 510091[2]²⁵

REAR WHEEL**FWD**

2008-2007
 Hub Unit Bearing 512323[2]²⁵

CRANKSHAFT REAR SEAL**4 Cylinder**

2008-2007 1.5L
 Seal Viton 228008
 Repair Sleeve KWK99315

HONDA - Insight**FRONT WHEEL****FWD**

2006-2000
 Bearing Module BM513161[2]²⁵

REAR WHEEL**FWD**

2006-2000
 Hub Unit Bearing HA590008[2]²⁵

CLUTCH**Release Bearing**

2003-2000
 Bearing Assy 614122

5-SPEED MANUAL TRANSAXLE**Differential**

2004-2000
 Ball Bearing 207S[2]

²⁵New Item, Check For Availability

Mfg./Year Model & Location Part No. Mfg./Year Model & Location Part No.

HONDA - Insight (cont.)

5-SPEED MANUAL TRANSAXLE

Selector Shaft Seal/Man. Shaft

2004-2000
 Seal 221820
 Repair Sleeve KWK99082

OIL PUMP

3 Cylinder

2006-2000 1.0L
 Seal 473677
 Repair Sleeve KWK99157

CRANKSHAFT FRONT SEAL

3 Cylinder

2005-2000
 Seal 473677

HONDA - Prelude

FRONT WHEEL

FWD

2001-1997
 Ball Bearing 510039[2]
 1996-1992
 Ball Bearing 513052[2]
 1991-1990
 Ball Bearing 513241[2]

REAR WHEEL

FWD

2001-1997
 Hub Unit Bearing 512144[2]
 1996-1992 (ABS)
 Hub Unit Bearing 512022[2]
 1996-1992 (Non-ABS)
 Hub Unit Bearing 512242[2]
 1991-1990
 Ball Bearing 513182[2]

CLUTCH

Release Bearing

2001-1990
 Bearing Assy 614072

4-SPEED AUTOMATIC TRANSAXLE

Differential

2001-1997
 Bearing Assy (LH) 30208M
 Cone/Cup (RH) 11157X-11300
 1996-1992
 Bearing Assy (LH) 33108
 Bearing Assy (RH) 32008XM
 1991-1990
 Bearing Assy (LH) 30208M
 Bearing Assy (RH) 32010X

Torque Converter / Frt Pump

2001-1990
 Seal 350609

Output Shaft

2001-1992
 Seal (LH) 224025
 Repair Sleeve KWK99157
 Seal (RH) 224066
 Repair Sleeve KWK99157
 1991-1990
 Seal (LH) 2007N
 Seal (RH) 224066
 Repair Sleeve KWK99139

Manual Shaft

2001-1990
 Seal 221207
 Repair Sleeve KWK99049

5-SPEED MANUAL TRANSAXLE

Input Shaft

2001-1997 (SH)
 Seal 224460
 Repair Sleeve KWK99170
 2001-1997 Base
 Seal 2007N
 Repair Sleeve KWK99139
 1996-1990
 Seal 222830

Mfg./Year Model & Location Part No. Mfg./Year Model & Location Part No.

HONDA - Prelude (cont.)**5-SPEED MANUAL TRANSAXLE****Output Shaft**

2001-1997 (SH)	
Seal (LH)	224460
Repair Sleeve (LH)	KWK99139
Seal (RH)	3459S
Repair Sleeve (RH)	KWK99157
2001-1997 Base	
Seal (LH)	2007N
Repair Sleeve (LH)	KWK99139
Seal (RH)	3459S
Repair Sleeve (RH)	KWK99157
1996-1990	
Seal (LH)	2007N
Repair Sleeve (LH)	KWK99139
Seal (RH)	3459S
Repair Sleeve (RH)	KWK99157

Selector Shaft Seal/Man. Shaft

2001-1990	
Seal	221607

OIL PUMP**4 Cylinder**

2001-1992 2.2L (SOHC)(DOHC)(VTEC), 2.3L (DOHC)	
Seal Viton	712009
Repair Sleeve	KWK99106

CAMSHAFT SEAL**4 Cylinder**

2001-1993 2.2L VTEC	
Seal	1989
1996-1992 2.2L (SOHC)	
Seal	712008
Repair Sleeve	KWK99111
1996-1992 2.3L (DOHC)	
Seal	712008
Repair Sleeve	KWK99111

CRANKSHAFT FRONT SEAL**4 Cylinder**

2001-1992 2.2L, 2.3L	
Seal	224015
Repair Sleeve	KWK99157

CRANKSHAFT FRONT SEAL (cont.)**4 Cylinder (cont.)**

1991-1990 2.1L	
Seal Viton	1120S
Repair Sleeve	KWK99147
1991-1990 2.0L (SOHC)(DOHC)	
Seal Viton	1120S
Repair Sleeve	KWK99147

CRANKSHAFT REAR SEAL**4 Cylinder**

2001-1993 2.2L VTEC	
Seal	228015
Repair Sleeve	KWK99315
1996-1992 2.2L (SOHC)	
Seal	228015
Repair Sleeve	KWK99315
1996-1992 2.3L (DOHC)	
Seal	228015
Repair Sleeve	KWK99315
1991-1990 2.1L (DOHC)	
Seal	228015
Repair Sleeve	KWK99315
1991-1990 2.0L (SOHC)(DOHC)	
Seal	228015
Repair Sleeve	KWK99315

HONDA - S2000**FRONT WHEEL****RWD**

2009-2000	
Ball Bearing	510050[2]

REAR WHEEL**RWD**

2009-2000	
Ball Bearing	510050[2]

Mfg./Year Model & Location Part No. Mfg./Year Model & Location Part No.

HONDA - S2000 (cont.)

6-SPEED MANUAL TRANSMISSION

Front Input Shaft

2002-2000 (SCYM)
Seal 710157

Selector Shaft Seal/Man. Shaft

2002-2000 (SCYM)
Seal 710243

CRANKSHAFT FRONT SEAL

4 Cylinder

2003-2000 2.0L, 2.2L
Seal 710159

CRANKSHAFT REAR SEAL

4 Cylinder

2005-2000 2.0L, 2.2L
Seal Viton 228008

HONDA - Minivan, SUV, Truck - CR-V

FRONT WHEEL

FWD

2009-2007 Japan Built
Ball Bearing WB000011[2]²⁵
2009-2007 U.S Built
Bearing Assy WB000012[2]²⁵
2006
Ball Bearing 510074[2]
2005-2002
Ball Bearing 510039[2]
2001-1997
Ball Bearing 510039[2]

4WD

2009-2007 Japan Built
Ball Bearing WB000011[2]²⁵
2009-2007 U.S Built
Bearing Assy WB000012[2]²⁵
2006
Ball Bearing 510074[2]
2005-2002
Ball Bearing 510074[2]
2001-1997
Ball Bearing 510039[2]

REAR WHEEL

FWD

2009-2007
Hub Unit Bearing HA590190[2]²⁵
2005-2002
Ball Bearing (Non-ABS) 510015[2]
Ball Bearing (ABS) 511029[2]
2001-1998
Bearing Module (RH) HA592210
Bearing Module (LH) 512166²⁵

4WD

2009-2007
Hub Unit Bearing HA590204[2]²⁵
2006-2002
Ball Bearing (ABS) 511029[2]
2001-1997
Bearing Module (RH) HA592210
Bearing Module (LH) 512166²⁵

TRANSFER CASE

Input Shaft

2002-1994 (MUATC)
Seal 710247
Ball Bearing 207
Repair Sleeve KWK99149

Rear Output Shaft

2002-1994 (MUATC)
Ball Bearing 307TB

5-SPEED AUTOMATIC TRANSMISSION

Selector Shaft Seal/Man. Shaft

2007-2005
Seal 221207
Repair Sleeve KWK99049

CLUTCH - 4 CYLINDER

Pilot Bearing

2001-1997
Ball Bearing 102CC

²⁵New Item, Check For Availability

Mfg./Year Model & Location Part No. Mfg./Year Model & Location Part No.

HONDA - Minivan, SUV, Truck - CR-V (cont.)**CLUTCH - 4 CYLINDER****Release Bearing**

2001-1997
Bearing Assy 614072

4-SPEED AUTOMATIC TRANSAXLE**Differential**

2001-1998 (FWD)
Ball Bearing 208[2]
2001-1997 (4WD)
Ball Bearing 208[2]

Torque Converter / Frt Pump

2008-1997
Seal 350609

Output Shaft

2004-2002
Seal (LH) 710217
2001-1997
Seal (LH) 2007N
Repair Sleeve (LH) KWK99139
Seal (RH) 1036
Repair Sleeve (RH) KWK99157

Manual Shaft

2004-1997
Seal 221207
Repair Sleeve KWK99049

5-SPEED AUTOMATIC TRANSAXLE**Output Shaft**

2007-2005
Seal (RH) 710217
Repair Sleeve KWK99139

5-SPEED MANUAL TRANSAXLE**Transaxle Rebuild Kit**

2002-1997 (SBXM)
Kit TRKFH340

Differential

2005-2002
Ball Bearing 208S[2]
2001-1999
Bearing Assy (RH) 32008XM
1998
Bearing Assy (RH) 32008XM

Input Shaft

2005-2002
Seal 710157
Repair Sleeve KWK99111
2001-1998
Seal 222830
Repair Sleeve KWK99111

5-SPEED MANUAL TRANSAXLE**Output Shaft**

2001-1998
Seal (LH) 2007N
Repair Sleeve (LH) KWK99139
Seal (RH) 3459S
Repair Sleeve (RH) KWK99157

CAMSHAFT SEAL**4 Cylinder**

2001-1997
Seal 222743[2]

CRANKSHAFT FRONT SEAL**4 Cylinder**

2001-1997 1972cc/2.0L
Seal 223802

CRANKSHAFT REAR SEAL**4 Cylinder**

2008-2002 2400cc/2.4L
Seal Viton 228008
2001-1997 1972cc/2.0L
Seal 228015

HONDA - Minivan, SUV, Truck - Element

FRONT WHEEL

FWD

2008-2007 (SC)	
Bearing Assy	WB000013[2] ²⁵
2008-2003 (ABS)	
Ball Bearing	510074[2]
2005-2003 (Non-ABS)	
Ball Bearing	510050[2]

4WD

2008-2007	
Bearing Assy	WB000013[2] ²⁵
2008-2003 (ABS)	
Ball Bearing	510074[2]
2005-2003 (Non-ABS)	
Ball Bearing	510050[2]

REAR WHEEL

FWD

2008-2006	
Bearing Module (RH)	BM500003 ²⁵
Bearing Module (LH)	BM500014 ²⁵
2005-2004 DX, LX	
Bearing Module	BM500000[2] ²⁵
2005-2003 EX	
Bearing Module	BM500003[2] ²⁵
2003 DX	
Bearing Module	BM500002[2] ²⁵

4WD

2008-2006	
Bearing Module (RH)	BM500003 ²⁵
Bearing Module (LH)	BM500014 ²⁵
2005-2004 DX, LX	
Bearing Module	BM500000[2] ²⁵
2005-2003 EX	
Bearing Module	BM500003[2] ²⁵
2003 DX	
Bearing Module	BM500002[2] ²⁵

4WD FRONT AXLE

Pinion

2004-2002	
Seal (Outer)	450803
Set (Outer)	SET4

4-SPEED AUTOMATIC TRANSAXLE

Output Shaft

2007-2003	
Seal (LH)	710300
Repair Sleeve (LH)	KWK99157

4-SPEED AUTOMATIC TRANSAXLE

Manual Shaft

2007-2003	
Seal	221207
Repair Sleeve	KWK99049

5-SPEED AUTOMATIC TRANSAXLE

Output Shaft

2008	
Seal (LH)	710300
Repair Sleeve (LH)	KWK99157

Manual Shaft

2008	
Seal	221207
Repair Sleeve	KWK99049

5-SPEED MANUAL TRANSAXLE

Differential

2005-2003	
Ball Bearing	208S[2]

Input Shaft

2005-2003	
Seal	710157
Repair Sleeve	KWK99111

CRANKSHAFT REAR SEAL

4 Cylinder

2008-2003 2400cc/2.4L	
Seal Viton	228008

²⁵New Item, Check For Availability

HONDA - Minivan, SUV, Truck - Odyssey**FRONT WHEEL****FWD**

2009-2005	
Ball Bearing	WB000020[2] ²⁵
2004-1999	
Ball Bearing	510059[2]
1998-1995	
Bearing Module	510038[2]

REAR WHEEL**FWD**

2009-2005	
Hub Unit Bearing	HA590151[2] ²⁵
2004-1999	
Hub Unit Bearing	512180[2]
1998	
Hub Unit Bearing	512123[2]
1997-1995	
Hub Unit Bearing	512124[2]

4-SPEED AUTOMATIC TRANSAXLE**Differential**

2001-1999	
Seal (LH)	710199
Repair Sleeve (LH)	KWK99139
Seal Viton (RH)	224026
Repair Sleeve (RH)	KWK99157
1998	
Seal (LH)	710315
Repair Sleeve (LH)	KWK99139
Seal (RH)	224066
Repair Sleeve (RH)	KWK99157
1997-1995	
Bearing Assy (LH)	30208M
Cone/Cup (RH)	11157X-11300

Torque Converter / Frt Pump

2002-1995	
Seal	350609

Output Shaft

2004-2002	
Seal (LH)	710199
Seal (RH)	710300
Repair Sleeve (LH)	KWK99157
Repair Sleeve (RH)	KWK99139
2001-1999	
Seal (LH)	710199
Seal Viton (RH)	224026
1998	
Seal (LH)	710315
Repair Sleeve (LH)	KWK99139
Seal (RH)	224066
Repair Sleeve (RH)	KWK99157
1997-1995	
Seal (LH)	2007N
Seal (RH)	224066
Repair Sleeve (LH)	KWK99139
Repair Sleeve (RH)	KWK99157

4-SPEED AUTOMATIC TRANSAXLE**Manual Shaft**

2004-1995	
Seal	221207
Repair Sleeve	KWK99049

5-SPEED AUTOMATIC TRANSAXLE**Output Shaft**

2008-2005	
Seal (LH)	710199
Seal (RH)	710217
Repair Sleeve	KWK99139

Manual Shaft

2008-2005	
Seal	221207
Repair Sleeve	KWK99049

OIL PUMP**4 Cylinder**

1998-1995	2.2L, 2.3L	
Seal Viton		712009
Repair Sleeve		KWK99106

6 Cylinder

2008-1999	3.5L	
Seal		711181

CAMSHAFT SEAL**4 Cylinder**

1998	2.3 (SOHC)	
Seal		712008
1997-1995	2.2L (SOHC)	
Seal		712008

6 Cylinder

2004-1999	3.5L	
Seal		710451[2]

CRANKSHAFT FRONT SEAL**4 Cylinder**

1998	2.3 (SOHC)	
Seal		224015
Repair Sleeve		KWK99157
1997-1995	2.2L	
Seal		224015
Repair Sleeve		KWK99157

6 Cylinder

2001-1999	3.5L	
Seal		1181
Repair Sleeve		KWK99162

²⁵New Item, Check For Availability

Mfg./Year Model & Location Part No. Mfg./Year Model & Location Part No.

HONDA - Minivan, SUV, Truck - Odyssey (cont.)

CRANKSHAFT REAR SEAL

4 Cylinder

1998 2.3 (SOHC)
 Seal 228015
 Repair Sleeve KWK99315
 1997-1995 2.2L (SOHC)
 Seal 228015

6 Cylinder

2008-1999 3.5L
 Seal Viton 228008
 Repair Sleeve KWK99315

HONDA - Minivan, SUV, Truck - Passport

FRONT WHEEL

4WD

2001-1994
 Seal (Inner) 710168[2]
 Cone/Cup (Inner) NP697136-NP592766[2]
 Cone/Cup (Outer) NP654538-NP177400[2]

REAR WHEEL

RWD

2002-1998
 Seal 9912S[2]
 Cylindrical Bearing RW131R[2]
 1997-1994
 Seal 710166[2]
 Cylindrical Bearing 5707[2]

4WD

2002-1998
 Seal 9912S[2]
 Cylindrical Bearing RW131R[2]
 1997-1994
 Seal 9912S[2]
 Set SET10[2]

FRONT AXLE

Differential

2002-1994
 Set SET45[2]

Pinion

2002-1999
 Seal 710513
 Bearing Assy (Inner) 32307
 Bearing Assy (Outer) 30306M
 1998-1994
 Seal 474133
 Bearing Assy (Inner) 32307
 Bearing Assy (Outer) 30306M
 Repair Sleeve KWK99157

FRONT AXLE

Steering Knuckle

1995-1994 (Except DX)
 Seal 710527

REAR AXLE

Differential Rebuild Kit

2002-1999 (8.625" R.G.)
 Kit DRK321C
 1998-1994 (7.625" R.G.)
 Kit DRK320

Differential

2002-1994 (7.5" R.G., 7.625" R.G.)
 Seal LM501349-LM501314[2]
 1999-1994 (Spicer 44 3 axle)
 Seal 25590-25523[2]

Pinion

2002-1999 (GM Axle)
 Seal 710452
 Cone/Cup (Inner) M802048-M802011
 Cone/Cup (Outer) M88048-M88010
 1999-1998 (Dana/Spicer 44-3 Axle)
 Seal 710452
 Cone/Cup (Inner) HM88649-HM88610
 Cone/Cup (Outer) 02872-02820
 1997-1994 (7.625" R.G.)
 Cone/Cup (Inner) HM89249-HM89210
 Repair Sleeve KWK99147
 1997-1994 (Dana/Spicer 44-3 Axle)
 Seal 5778
 Cone/Cup (Inner) HM88649-HM88610
 Cone/Cup (Outer) 02872-02820
 Repair Sleeve KWK99155

TRANSFER CASE

Input Shaft

2002-1994 (MUATC)
 Seal 710247
 Ball Bearing 207
 Repair Sleeve KWK99149

Mfg./Year	Model & Location	Part No.	Mfg./Year	Model & Location	Part No.
HONDA - Minivan, SUV, Truck - Passport (cont.)					

TRANSFER CASE**Rear Output Shaft**

2002-1994 (MUATC)	
Ball Bearing	307TB

4-SPEED AUTOMATIC TRANSMISSION**Selector Shaft Seal/Man. Shaft**

2002-1994	
Seal	8792S

CLUTCH**Pilot Bearing**

2002-1994 3.2L	
Ball Bearing	203FFW
1997-1994 2.6L	
Ball Bearing	203FF

Release Bearing

2002-1994 3.2L	
Bearing Assy	614154
1996-1994 DX	
Bearing Assy	614163

5-SPEED MANUAL TRANSMISSION**Transmission Rebuild Kit**

2002-1994 (RWD)	
Kit	TRKFI200
2002-1993 (4WD)	
Kit	TRKFI160
1996-1994 (Warner T5 World Class)	
Kit	TRK5W

Front Input Shaft

1997-1994 (4WD)	
Seal	710157
Repair Sleeve	KWK99103
1996-1994 DX	
Seal	7412S

Rear Output Shaft

1997-1994 (4WD)	
Seal	3459S
1996-1994 DX	
Seal	710441

DRIVESHAFT SUPPORT

1997 (2WD)	
Hanger Bearing Assy	HB32
1997 (4WD)	
Hanger Bearing Assy	HB33

CAMSHAFT SEAL**4 Cylinder**

1996-1994 2.6L	
Seal	1981[2]
Repair Sleeve	KWK99114[2]

CAMSHAFT SEAL**6 Cylinder**

2002-1994 3.2L	
Seal	1981[2]
Repair Sleeve	KWK99114[2]

CRANKSHAFT FRONT SEAL**4 Cylinder**

1996-1994 2.6L	
Seal	224025
Repair Sleeve	KWK99157

6 Cylinder

2002-1994 3.2L	
Seal	224025
Repair Sleeve	KWK99157

CRANKSHAFT REAR SEAL**4 Cylinder**

1996-1994 2.6L	
Seal	710060
Repair Sleeve	KWK99364

6 Cylinder

2002-1994 3.2L	
Seal	710060
Repair Sleeve	KWK99364

Mfg./Year Model & Location Part No. Mfg./Year Model & Location Part No.

HONDA - Minivan, SUV, Truck - Pilot

FRONT WHEEL

FWD

2008-2006
Ball Bearing 510085[2]

4WD

2008-2005
Ball Bearing 510085[2]
2004-2003
Ball Bearing 510011[2]

REAR WHEEL

FWD

2008-2003
Ball Bearing 510039[2]

4WD

2008-2003
Ball Bearing 510039[2]

5-SPEED AUTOMATIC TRANSAXLE

Output Shaft

2008-2003
Seal (LH) 710300
Seal (RH) 710217
Repair Sleeve (LH) KWK99157
Repair Sleeve (RH) KWK99139

Manual Shaft

2005-2003
Seal 221207
Repair Sleeve KWK99049

OIL PUMP

6 Cylinder

2008-2003 3.5L
Seal 711181

CAMSHAFT SEAL

6 Cylinder

2004-2003 3.5L
Seal 710451[2]

CRANKSHAFT FRONT SEAL

6 Cylinder

2004-2003 3.5L
Seal Viton 2012V

CRANKSHAFT REAR SEAL

6 Cylinder

2008-2003 3.5L
Seal Viton 228008
Repair Sleeve KWK99315

HONDA - Minivan, SUV, Truck - Ridgeline

FRONT WHEEL

AWD

2009-2006
Bearing Assy WB000008[2]²⁵

REAR WHEEL

AWD

2009-2006
Bearing Assy WB000009[2]²⁵

OIL PUMP

6 Cylinder

2008-2006 3.5L
Seal 711181

CRANKSHAFT REAR SEAL

6 Cylinder

2008-2006 3.5L
Seal Viton 228008
Repair Sleeve KWK99315

²⁵New Item, Check For Availability

HUMMER - H1, H2**FRONT WHEEL****4WD**

2009-2008	H2	
Hub Unit Bearing	SP580312[2] ²⁵
2007-2003	H2	
Hub Unit Bearing	SP580304[2] ⁸³
Hub Unit Bearing	SP580310[2] ⁸⁴
2006-2002	H1	
Cone/Cup (Inner)	3490-3420[2]
Cone/Cup (Outer)	3780-3720[2]
2001-1990		
Cone/Cup (Inner)	3490-3420[2]
Cone/Cup (Outer)	3780-3720[2]

AWD

2003	H2	
Hub Unit Bearing	SP580304[2] ⁸³
Hub Unit Bearing	SP580310[2] ⁸⁴

REAR WHEEL**4WD**

2009-2003	H2	
Seal	710105[2]
Cylindrical Bearing	R1561TV[2]
Bearing & Seal Kit	TGM1561R[2] ¹⁹
2004-2002	H1	
Cone/Cup (Inner)	3490-3420[2]
Cone/Cup (Outer)	3780-3720[2]
2001-1992		
Cone/Cup (Inner)	3490-3420[2]
Cone/Cup (Outer)	3780-3720[2]

AWD

2003	H2	
Seal	710105[2]
Cylindrical Bearing	R1561TV[2]
Bearing & Seal Kit	TGM1561R[2] ¹⁹

4WD FRONT AXLE**Differential Rebuild Kit**

2005-2003	H2	
Kit	DRK324A
2001-1993	(AMC 20 Axle)	
Kit	DRK311J

Differential

2005-2003	H2	
Seal	450094[2]
Set	SET42[2]
Repair Sleeve	KWK99193[2]
2005-1993	(AMC 20 Axle)	
Set	SET36[2]

4WD FRONT AXLE**Pinion**

2005-2003	H2	
Seal	710281
Cone/Cup (Inner)	HM804846-HM804810
Cone/Cup (Outer)	HM88649-HM88610
2001-1993	(AMC 20 Axle)	
Seal	470331N
Cone/Cup (Inner)	M802048-M802011
Cone/Cup (Outer)	M88048-M88010

REAR AXLE**Differential Rebuild Kit**

2007-2006	H3	
Kit	DRK321C
2007-2003	H2	
Kit	DRK324B
2006-1993	(AMC 20 Axle)	
Kit	DRK311J

Differential

2005-2003	H2	
Set	SET42[2]
2001-1993	(AMC 20 Axle)	
Set	SET36[2]

Pinion

2005-2003	H2	
Seal	710507
Cone/Cup (Inner)	HM804846-HM804810
Cone/Cup (Outer)	HM88649-HM88610
2001-1993	(AMC 20 Axle)	
Seal	470331N
Cone/Cup (Inner)	M802048-M802011
Cone/Cup (Outer)	M88048-M88010

TRANSFER CASE REBUILD KIT

2001-1993	(New Venture 242)	
Kit	TCRK242A ¹⁶

TRANSFER CASE**Input Shaft**

2001-1993	(New Process 242)	
Seal (O.E.)	3173
Seal (Opt)	710928
Repair Sleeve	KWK99193
Ball Bearing (2nd Design)	110L
Ball Bearing (1st Design)(Thru 94)	N5210KLB
Ndle Bearing	FC66561

Front Output Shaft

2006-1993	(New Process 242)	
Seal	3946
Ball Bearing	207
Repair Sleeve	KWK99187
Ndle Bearing (Pilot)	J2416

¹⁶Obsolete ¹⁹Opt. Axle Rpr Brg. Replaces O.E. Brg & Seal
⁸³Deplete Inventory ⁸⁴Reorder

²⁵New Item, Check For Availability

Mfg./Year Model & Location Part No. Mfg./Year Model & Location Part No.

HUMMER - H1, H2 (cont.)

TRANSFER CASE

Rear Output Shaft

2001-1993 (New Process 242)
 Ball Bearing 206WB
 Ndle Bearing (Pilot) J2416

Oil Pump Housing

2001-1993 (New Process 242)
 Seal 341022
 Repair Sleeve KWK99225

3-SPEED AUTOMATIC TRANSMISSION

Torque Converter

1993 (3L80HD)
 Seal 6712NA
 Repair Sleeve KWK99187

Rear Seal/Ext. Housing

1993 (3L80HD)
 Seal 9449
 Seal Kit 5208⁶⁴

Selector Shaft Seal/Man. Shaft

1994-1993 (3L80HD)
 Seal 8792S

4-SPEED AUTOMATIC TRANSMISSION

Torque Converter

2001-1993 (4L80E)
 Seal 4598
 Repair Sleeve KWK99199

Rear Seal/Ext. Housing

2001-1993 (4L80E)
 Seal 9449
 Seal Kit 5208⁶⁴

Selector Shaft Seal/Man. Shaft

2008-1993 (4L65E, 4L80E)
 Seal 8792S

6- SPEED AUTOMATIC TRANSMISSION

Rear Seal/Ext. Housing

2008 (6L80)
 Seal 710533

A/C COMPRESSOR

2001-1993 (Frigidaire R4)
 Ball Bearing 907257[2]
 Ball Bearing (Frt Head) S128

ALTERNATOR

2001-1993 (Delco 124 Amp.)
 Ball Bearing (Rear End) 100CCAB

CRANKSHAFT FRONT SEAL

8 Cylinder

2008 378/6.2L (Gas)
 Seal Viton 100470
 Repair Sleeve KWK99210
 2007-2003 364/6.0L
 Seal Viton 100470
 Repair Sleeve KWK99210
 2004-1992 6.2L (Diesel), 6.5L (Diesel),
 Turbo Diesel)
 Seal 3945
 Repair Sleeve KWK99233
 1996-1995 350/5.7L
 Seal 9845
 Repair Sleeve KWK99176

CRANKSHAFT REAR SEAL

8 Cylinder

2007-2003 364/6.0L
 Seal Viton 100470
 2006-1992 379/6.2L (Diesel) 395/6.5L
 (Diesel) 395/6.5L (Turbo Diesel)
 6.6L (Diesel)
 Seal Viton 710258
 Repair Sleeve KWK99452
 1996-1995 350/5.7L
 Seal Viton 4359V
 Seal PTFE H/D 5274
 Repair Sleeve KWK99364

⁶⁴Seal & Bushing Kit

Mfg./Year Model & Location Part No. Mfg./Year Model & Location Part No.

HUMMER - H3

FRONT WHEEL

4WD

2009-2006

Hub Unit BearingSP550311[2]²⁵

REAR WHEEL

4WD

2009-2006

Cylindrical Bearing 513067[2]

Seal4762N[2]

4WD FRONT AXLE

Differential

2006

Set SET36[2]

Pinion

2006

Cone/Cup (Inner) HM89249-HM89210

Cone/Cup (Outer) M86649-M86610

REAR AXLE

Differential

2006

Set SET36[2]

REAR AXLE

Pinion

2006

Seal 710506

Cone/Cup (Inner) HM89249-HM89210

Cone/Cup (Outer) M86649-M86610

CRANKSHAFT FRONT SEAL

8 Cylinder

2008 325/ 5.3L

Seal Viton 100470

Repair Sleeve KWK99210

CRANKSHAFT REAR SEAL

8 Cylinder

2008 5.3L

Seal 100085

HYUNDAI - FRONT DRIVE - Accent, Azera, Elantra, Excel, Scoupe, Sonata, Tiburon, XG300, XG350

FRONT WHEEL

FWD

2009-2006 Azera

Ball Bearing 510084[2]

2009-2006 Tiburon (4 Cyl.)

Ball Bearing 510078[2]

2009-2006 Tiburon (6 Cyl.)

Ball Bearing 510076[2]

2009-2002 Sonata (From 1/3/02)

Ball Bearing 510034[2]

2009-2000 Accent

Ball Bearing 510055[2]

2008-2007 Elantra

Bearing Assy WB000014[2]²⁵

2006-2001 Elantra

Ball Bearing 510078[2]

2005-2003 Tiburon (4 Cyl.)

Ball Bearing 510078[2]

2005-2003 Tiburon (6 Cyl.)

Ball Bearing 510076[2]

2005-2003 XG300, XG350 (From 1/3/02)

Ball Bearing 510034[2]

2002-2001 XG300, XG350 (Thru 1/2/02)

Ball Bearing 510076[2]

2002-1999 Sonata (Thru 1/2/02)

Ball Bearing 510076[2]

2001-1997 Tiburon

Ball Bearing 510055[2]

FRONT WHEEL (cont.)

FWD (cont.)

2000-1996 Elantra

Ball Bearing 510055[2]

1999-1995 Accent

Seal (Inner) 229522[2]

Set (Inner) SET41[2]

Seal (Outer) 229522[2]

Set (Outer) SET41[2]

1998-1995 Sonata

Ball Bearing 510075[2]

1995-1992 Elantra

Seal (Inner) 229522[2]

Set (Inner) SET41[2]

Seal (Outer) 229522[2]

Set (Outer) SET41[2]

1995-1991 SCoupe

Seal 229522[2]

Set SET41[2]

1994-1990 Sonata

Seal (Inner) 225082[2]

Ball Bearing (Inner) 513036[2]

Seal (Outer) 225230[2]

1994-1990 Excel

Seal 229522[2]

Set SET41[2]

²⁵New Item, Check For Availability

Mfg./Year	Model & Location	Part No.	Mfg./Year	Model & Location	Part No.
HYUNDAI - FRONT DRIVE - Accent, Azera, Elantra, Excel, Scoupe, Sonata, Tiburon, XG300, XG350 (cont.)					

REAR WHEEL

FWD

2009	Sonata	
	Hub Unit Bearing	HA590325[2] ²⁵
2009-2008	Accent	
	Hub Unit Bearing	
	(Non-ABS)	HA590184[2] ²⁵
	Hub Unit Bearing	
	(ABS)	512324[2] ²⁵
2009-2007	Tiburon (ABS)	
	Hub Unit Bearing	HA590200[2] ²⁵
2009-2006	Azera	
	Hub Unit Bearing	HA590179[2] ²⁵
2008-2007	Elantra	
	Hub Unit Bearing	512340[2] ²⁵
2008-2006	Sonata (Electronic Stability)	
	Hub Unit Bearing	512265[2] ²⁵
2007-2006	Accent	
	Hub Unit Bearing	HA590184[2] ²⁵
2006-2003	Tiburon (ABS)	
	Hub Unit Bearing	512198[2]
2006-2001	Elantra (ABS)	
	Hub Unit Bearing	512195[2]
2006-2001	Elantra (Non-ABS)	
	Hub Unit Bearing	512194[2]
2005-2003	Tiburon (Non-ABS)	
	Hub Unit Bearing	512199[2]
2005-2001	XG300, XG350	
	Hub Unit Bearing	512189[2]
2005-2000	Accent (ABS)	
	Hub Unit Bearing	512192[2]
2005-2000	Accent (Non-ABS)	
	Hub Unit Bearing	512193[2]
2005-1999	Sonata (ABS)	
	Hub Unit Bearing	512190[2]
2005-1999	Sonata (Non-ABS)	
	Hub Unit Bearing	512191[2]
2001-1997	Tiburon	
	Hub Unit Bearing	512160[2]
2000-1996	Elantra	
	Hub Unit Bearing	512160[2]
1999-1997	Accent	
	Hub Unit Bearing	512165[2]
1998-1992	Sonata	
	Hub Unit Bearing	512026[2]
1996-1995	Accent	
	Hub Unit Bearing	512027[2]
1995-1992	Elantra	
	Seal (Inner)	1196[2]
	Bearing Assy (Inner)	516000[2]
	Bearing Assy (Outer)	516000[2]
1995-1991	SCoupe	
	Seal (Inner)	710404[2]
	Bearing Assy (Inner)	516000[2]
	Bearing Assy (Outer)	516000[2]
1994-1990	Excel	
	Seal (Inner)	710404[2]
	Bearing Assy (Inner)	516000[2]
	Bearing Assy (Outer)	516000[2]
1991-1990	Sonata	
	Seal (Inner)	494122[2]
	Set (Inner)	SET6[2]
	Set (Outer)	SET2[2]

CLUTCH - 4 CYLINDER

Release Bearing

2001-1990	(Exc. Tiburon)	
	Bearing Assy	614126

3-SPEED AUTOMATIC TRANSAXLE

Output Shaft

1994-1990	(KM170 1, KM171 1, KM171 5)	
	Seal	223543[2]
	Repair Sleeve	KWK99139[2]

4-SPEED AUTOMATIC TRANSAXLE

Differential

1999-1991	Accent, Excel	
	Ball Bearing	207[2]
1993-1990	(F4A23 2)	
	Ball Bearing	206WB[2]
1990	(F4A21 2, F4A22 2, F4A33 1)	
	Ball Bearing	207[2]

Torque Converter / Frt Pump

2001-1997	Tiburon	
	Seal	320583
	Repair Sleeve	KWK99182

Idler Shaft

1994-1991	(F4A21 2)	
	Bearing Assy	30206M[2]

Transfer Shaft

1995-1991	(F4A21 2)	
	Bearing Assy	30207M[2]

Output Shaft

2007-1997	Tiburon	
	Seal Viton	710259[2]
2007-1995	Accent	
	Seal Viton	710259[2]
2005-2002	Sonata	
	Seal Viton	710259[2]
	Repair Sleeve	KWK99139[2]
2000-1996	Elantra	
	Seal Viton	710259[2]
1998-1990	Sonata	
	Seal Viton (F4A33-1)	710259[2]
	Repair Sleeve	KWK99139[2]
	Seal (F4A22-2)	223543[2]
1995-1993	SCoupe	
	Seal Viton	710259[2]
1995-1992	Elantra	
	Seal	223543[2]
	Repair Sleeve	KWK99139[2]
1992-1991	SCoupe	
	Seal	223543[2]
	Repair Sleeve	KWK99139[2]

²⁵New Item, Check For Availability

Mfg./Year	Model & Location	Part No.	Mfg./Year	Model & Location	Part No.
-----------	------------------	----------	-----------	------------------	----------

HYUNDAI - FRONT DRIVE - Accent, Azera, Elantra, Excel, Scoupe, Sonata, Tiburon, XG300, XG350 (cont.)

4-SPEED MANUAL TRANSAXLE

Differential

1991-1990 (F4M21 1)
Ball Bearing 207[2]

Input Shaft

1991-1990 (F4M21 1, KM200 0)
Seal Viton 712007
Repair Sleeve KWK99098

Output Shaft

1991-1990 (F4M21 1, KM200 0)
Seal 223543[2]
Bearing Assy 30206M[2]
Repair Sleeve KWK99139[2]

Selector Shaft Seal/Man. Shaft

1991-1990
Seal 710222

5-SPEED MANUAL TRANSAXLE

Differential

2001-1997 Tiburon
Bearing Assy 32207M[2]
1999-1995 Accent
Ball Bearing 207[2]
1997-1995 Sonata
Bearing Assy 32207M[2]
1995-1992 Elantra
Bearing Assy 30207M[2]
1994-1991 Excel
Ball Bearing 207[2]
1992-1991 (F5M21 1, KM210 0)
Ball Bearing 207[2]
1990 (F5M21 1, KM201 0, KM210 0)
Ball Bearing 207[2]

Input Shaft

1998-1990 (F5M21 1, F5M22 2)
Seal Viton 712007
Repair Sleeve KWK99098
1992-1990 (KM210 0)
Seal Viton (Frt) 712007
Repair Sleeve KWK99098
Ball Bearing (Center) 304WB[2]
Ball Bearing (Rr) 306F[2]

Output Shaft

2004-1995 Accent
Seal 2007N[2]
2001-1997 Tiburon
Seal 2007N[2]
1998-1990 (F5M21 1, F5M22 2, KM201 0, KM210 0)
Seal 223543[2]
Bearing Assy 30206M[2]
Repair Sleeve KWK99139[2]

5-SPEED MANUAL TRANSAXLE (cont.)

Output Shaft (cont.)

1993-1990 (F5M22 2)
Seal 223543[2]
Repair Sleeve KWK99139[2]

Selector Shaft Seal/Man. Shaft

2007-1990
Seal 710222

ALTERNATOR

1996-1995 Mitsubishi 110 Amp.
Ball Bearing 303CC[2]

OIL PUMP

4 Cylinder

2005-1990 1795cc/1.8L(DOHC),
1796cc/1.8L(DOHC),
1997cc/2.0L(DOHC),
2351cc/2.4L,
2351cc/2.4L(DOHC)
Seal 222025
Repair Sleeve KWK99078

BALANCE SHAFT

4 Cylinder

1998-1992 1997cc/2.0L (DOHC)
Seal Viton 712007
Repair Sleeve KWK99098

CAMSHAFT SEAL

4 Cylinder

2005-1992 1595cc/1.6L, 1795cc/1.8L,
1975cc/2.0L, 1997cc/2.0L,
2351cc/2.4L (DOHC)
Seal 3771[2]
Repair Sleeve KWK99139[2]
2002-1990 1468cc/1.5L, 1495cc/1.5L,
2351cc/2.4L (SOHC)
Seal 3771
Repair Sleeve KWK99139

6 Cylinder

2005-2002 3500cc/3.5L
Seal (Rr) 710302
2001-2000 2493cc/2.5L
Seal (Rr) 710302
1998-1990 2972cc/3.0L
Seal 3771[2]
Repair Sleeve KWK99139[2]

CRANKSHAFT FRONT SEAL

4 Cylinder

2008-2000 1.6L (DOHC)
Seal 227235

Mfg./Year Model & Location Part No. Mfg./Year Model & Location Part No.

HYUNDAI - FRONT DRIVE - Accent, Azera, Elantra, Excel, Scoupe, Sonata, Tiburon, XG300, XG350 (cont.)

CRANKSHAFT FRONT SEAL (cont.)

4 Cylinder (cont.)

2008-1994	1796cc/1.8L, 1975cc/2.0L, 1997cc/2.0L, 2351cc/2.4L	
Seal		224460
2004-2002	2.4L	
Seal Viton		712007
1999-1993	1468cc/1.5L, 1495cc/1.5L	
Seal		223018
Repair Sleeve		KWK99114
1998-1996	1.8L (DOHC)	
Seal		710531[2]
1996-1990	1595cc/1.6L, 1997cc/2.0L, 2351cc/2.4L	
Seal		224460
1995-1993	1.8L (DOHC)	
Seal		224460
1992-1990	1468cc/1.5L	
Seal		223018
Repair Sleeve		KWK99114

6 Cylinder

2008-2000	2.5L, 2.7L	
Seal		223750
2005-2001	3.0L, 3.5L	
Seal		223750
1998-1990	2972cc/3.0L	
Seal		223750
Repair Sleeve		KWK99145

CRANKSHAFT REAR SEAL

4 Cylinder

2008-2006	2656cc/2.7L	
Seal Viton		229005
2008-1997	1796cc/1.8L, 1975cc/2.0L, 1997cc/2.0L, 2351cc/2.4L	
Seal Viton		228005
Repair Sleeve		KWK99315
2008-1993	1468cc/1.5L, 1495cc/1.5L, 1600cc/1.6L	
Seal		227235

CRANKSHAFT REAR SEAL (cont.)

4 Cylinder (cont.)

1996-1990	1595cc/1.6L, 1997cc/2.0L, 2351cc/2.4L	
Seal Viton		228005
Repair Sleeve		KWK99315
1992-1990	1468cc/1.5L	
Seal		227235

6 Cylinder

2005-1999	2493cc/2.5L, 2656cc/2.7L, 3500cc/3.5L	
Seal Viton		710056
Seal PTFE H/D		5279
2001-1990	2972cc/3.0L	
Seal Viton		710056
Seal PTFE H/D		5279

HYUNDAI - FRONT DRIVE - Genesis

FRONT WHEEL

FWD

2009		
Hub Unit Bearing		HA590324[2] ²⁵

REAR WHEEL

FWD

2009		
Hub Unit Bearing		HA590326[2] ²⁵

²⁵New Item, Check For Availability

Mfg./Year Model & Location Part No. Mfg./Year Model & Location Part No.

HYUNDAI TRUCK - Minivan, SUV, Truck - Entourage**FRONT WHEEL****FWD**

2009-2007

Hub Unit Bearing HA590206[2]²⁵**REAR WHEEL****FWD**

2009-2007

Hub Unit Bearing HA590016[2]²⁵**HYUNDAI TRUCK - Minivan, SUV, Truck - Sante Fe****FRONT WHEEL****FWD**

2009-2007

Hub Unit Bearing 513256[2]²⁵

2006-2001

Ball Bearing 510034[2]

4WD

2006-2001

Ball Bearing 510034[2]

AWD

2009-2007

Hub Unit Bearing 513256[2]²⁵**REAR WHEEL****FWD**

2009-2007

Hub Unit Bearing 512326[2]²⁵

2006-2001 (ABS)

Hub Unit Bearing 512196[2]

2006-2001 (Non-ABS)

Hub Unit Bearing 512197[2]

4WD

2006-2001

Set SET49[2]

AWD

2009-2008

Hub Unit Bearing 513256[2]²⁵

2007

Hub Unit Bearing 513256[2]²⁵**5-SPEED MANUAL TRANSMISSION****Selector Shaft Seal/Man. Shaft**

2001

Seal 710222

OIL PUMP**4 Cylinder**

2004-2001 2351cc/ 2.4L (DOCH)

Seal 222025

Repair Sleeve KWK99078

CAMSHAFT SEAL**4 Cylinder**

2005 1975cc/2.0L

Seal 3771[2]

2005-2003 3500cc/3.5L

Seal (Rr) 710302

2004-2001 2351cc/ 2.4L

Seal 3771[2]

Repair Sleeve KWK99139[2]

CRANKSHAFT FRONT SEAL**4 Cylinder**

2004-2001 2.4L

Seal 224460

6 Cylinder

2008-2001 2.7L, 3.5L

Seal 223750

CRANKSHAFT REAR SEAL**4 Cylinder**

2004-2001 2351cc/ 2.4L

Seal Viton 710235

6 Cylinder

2008-2001 2656cc/2.7L, 3500cc/3.5L

Seal Viton 710056

Seal PTFE H/D 5279

²⁵New Item, Check For Availability

Mfg./Year Model & Location Part No. Mfg./Year Model & Location Part No.

HYUNDAI TRUCK - Minivan, SUV, Truck - Tucson

FRONT WHEEL

FWD

2008-2005
Ball Bearing 510034[2]

4WD

2008-2005
Ball Bearing 510034[2]

REAR WHEEL

FWD

2008-2005
Hub Unit Bearing 512267[2]²⁵

4WD

2008-2005
Bearing Assy 513058[2]

CRANKSHAFT FRONT SEAL

4 Cylinder

2008-2005 1975cc/2.0L
Seal 710531

6 Cylinder

2008-2005 2656cc/2.7L
Seal 223750

CRANKSHAFT REAR SEAL

4 Cylinder

2008-2005 1975cc/2.0L
Seal Viton 710235

6 Cylinder

2008-2005 2656cc/2.7L
Seal Viton 710056
Seal PTFE H/D 5279

HYUNDAI TRUCK - Minivan, SUV, Truck - Veracruz

FRONT WHEEL

FWD

2009-2007
Hub Unit Bearing 513266[2]²⁵

AWD

2009-2007
Hub Unit Bearing 513266[2]²⁵

REAR WHEEL

FWD

2009-2007
Hub Unit Bearing 512326[2]²⁵

REAR WHEEL

AWD

2009-2007
Hub Unit Bearing 513256[2]²⁵

INFINITI - FRONT DRIVE - G20, I30, I35

FRONT WHEEL

FWD

2004-2000 I30, I35
Hub Unit Bearing HA590600K[2]⁶⁷₂₅
Ball Bearing (Opt) 510060[2]²⁵

FRONT WHEEL (cont.)

FWD (cont.)

2002-1991 G20
Seal (Inner) 710108[2]
Ball Bearing (Inner) 510009[2]
Seal (Outer) 710108[2]

²⁵New Item, Check For Availability

⁶⁷Kit = Flg, Brg, Nut, & Snap Ring

Mfg./Year	Model & Location	Part No.	Mfg./Year	Model & Location	Part No.
INFINITI - FRONT DRIVE - G20, I30, I35 (cont.)					

FRONT WHEEL (cont.)**FWD (cont.)**

1999-1996	I30	
Seal (Inner)		710108[2]
Ball Bearing (Inner)		510009[2]
Seal (Outer)		710108[2]

REAR WHEEL**FWD**

2004-2000	I30, I35	
Hub Unit Bearing		512203[2]
2002-1999	G20	
Hub Unit Bearing		HA590123[2] ²⁵

CLUTCH - 4 CYLINDER**Pilot Bearing**

2002-1991	1998cc/2.0L (DOHC)	
Bushing		PB22

CLUTCH - 6 CYLINDER**Pilot Bearing**

1999-1996	2988cc/3.0L (DOHC)	
Bushing		PB22

CLUTCH - 4 CYLINDER**Release Bearing**

2002-1991	1998cc/2.0L (DOHC)	
Bearing Assy		614047

CLUTCH - 6 CYLINDER**Release Bearing**

2001-1996	2988cc/3.0L (DOHC)	
Bearing Assy		614049

4-SPEED AUTOMATIC TRANSAXLE**Differential**

2002-1991	(RL4F03A)	
Ball Bearing		208[2]
2002-1991	(RL4F03V)	
Bearing Assy (LH)		32008XM
2000-1996	(RE4F04A)	
Bearing Assy		32009XM[2]
2000-1996	(RE4F04V)	
Bearing Assy (LH)		32009XM
Bearing Assy (RH)		32013X

Torque Converter / Frt Pump

2002-1991	(RL4F03A, RL4F03V)	
Seal		710442
2000-1996	(RE4F04A, RE4F04V)	
Seal		224663
Repair Sleeve		KWK99181

4-SPEED AUTOMATIC TRANSAXLE**Output Shaft**

2004-1996	(RE4F04A)	
Seal (LH)		710118
Seal (RH)		710124
2002-1991	(RL4F03A)	
Seal Viton		224026[2]
2002-1991	(RL4F03V)	
Seal (LH)		710132
Seal (RH)		710133
2001-1996	(RE4F04V)	
Seal (LH)		710397
Seal (RH)		710124

Oil Pump

2000-1996	(RE4F04A, RE4F04V)	
Seal		224450
1995-1991	(RE4F02V)	
Seal		224450

Manual Shaft

2002-1991	(RL4F03A, RL4F03V, RE4F04A, RE4F04V)	
Seal		221207

5-SPEED MANUAL TRANSAXLE**Differential**

2002-1991	(RS5F32A)	
Bearing Assy		32010X[2]
2002-1991	(RS5F32V)	
Bearing Assy (LH)		32010X
2000-1996	(RS5F50A)	
Bearing Assy		32009XM[2]
2000-1996	(RS5F50V)	
Bearing Assy (LH)		32009XM
Bearing Assy (RH)		32013X

Input Shaft

2002-1991	(RS5F32A)(RS5F32V)	
Seal		710316
Ball Bearing		305AG[2]
Repair Sleeve		KWK99098
2000-1996	(RS5F50A)(RS5F50V)	
Seal		710119
Ball Bearing		108A[2]
Repair Sleeve		KWK99111

Output Shaft

2000-1996	(RS5F50A)	
Seal (LH)		710118
Bearing Assy (LH)		32206M[2]
Seal (RH)		710124
Bearing Assy (RH)		30306M[2]
2000-1996	(RS5F50V)	
Seal (LH)		710397
Seal (RH)		710124
2000-1991	(RS5F32A)	
Seal (LH)		710132
2000-1991	(RS5F32V)	
Seal (LH)		710132
Seal (RH)		710133

²⁵New Item, Check For Availability

Mfg./Year	Model & Location	Part No.	Mfg./Year	Model & Location	Part No.
-----------	------------------	----------	-----------	------------------	----------

INFINITI - FRONT DRIVE - G20, I30, I35 (cont.)

ALTERNATOR

1997-1991 Hitachi 90 Amp.
Ball Bearing (Drive End)303CC

CAMSHAFT SEAL

4 Cylinder

2002-1991 1998cc/2.0L (DOHC)
Seal 223420[2]
Repair SleeveKWK99131

CRANKSHAFT FRONT SEAL

4 Cylinder

2002-1991 1998cc/2.0L (DOHC)
Seal 224650
Repair SleeveKWK99181

6 Cylinder

2004-2002 3498cc/3.5L
Seal 710356
Repair SleeveKWK99189
2001-1996 2988cc/3.0L (DOHC)
Seal 710356
Repair SleeveKWK99189

CRANKSHAFT REAR SEAL

4 Cylinder

2002-1995 2.0L (DOHC)
Seal PTFE H/D 228411 ²⁵
1994-1991 1998cc/2.0L (DOHC)
Seal Viton 228410

6 Cylinder

2004-2002 3498cc/3.5L (DOHC)
Seal Viton 710363
2001-1996 2988cc/3.0L (DOHC)
Seal Viton 710363

INFINITI - REAR DRIVE - G35, G37, J30, M30, M35, M45, Q45

FRONT WHEEL

RWD

2009-2006 M35, M45
Hub Unit Bearing HA590176[2] ²⁵
2008 G35, G37
Hub Unit Bearing HA590176[2] ²⁵
2007 G35 Coupe
Hub Unit Bearing HA590027[2] ²⁵
2007 G35 Sedan
Hub Unit Bearing HA590176 ²⁵
2006-2003 G35
Hub Unit Bearing HA590027[2] ²⁵
2006-2002 Q45
Hub Unit Bearing HA590126[2] ²⁵
2004-2003 M45
Bearing Assy JRM3449-90UA1[2]
2003 G35 (Exc. Stability Control)
Hub Unit Bearing HA590127[2] ²⁵
2001-1997 Q45
Seal 710292[2]
Bearing Assy JRM3449-90UA1[2]
2001-1997 Q45
Seal 710292[2]
Bearing Assy JRM3449-90UA1[2]
1997-1993 J30
Seal 710292[2]
Bearing Assy JRM3449-90UA1[2]
1996-1990 Q45
Seal 710108[2]
Taprd Bearing Assy JRM3848-90UA1[2]
1992-1990 M30 (ABS)
Set (Inner) SET6[2]
Set (Outer) SET2[2]

FRONT WHEEL (cont.)

RWD (cont.)

1992-1990 M30 (Non-ABS)
Seal (Inner) 710126[2]
Set (Inner) SET6[2]
Set (Outer) SET2[2]

AWD

2009-2006 M35, M45
Hub Unit Bearing HA590226[2]
2008-2007 G35 Sedan
Hub Unit Bearing HA590226[2]
2006-2004 G35 Sedan
Bearing Module BM500013[2] ²⁵

REAR WHEEL

RWD

2009-2008 M35, M45
Hub Unit Bearing HA590255[2] ²⁵
2008 G35, G37
Hub Unit Bearing HA590255[2] ²⁵
2007 G35 Coupe
Bearing Module BM500006[2] ²⁵
2007 G35 Sedan
Hub Unit Bearing HA590255[2] ²⁵
2007 M45
Hub Unit Bearing HA590255[2] ²⁵
2007-2006 M35
Hub Unit Bearing HA590175[2] ²⁵
2006 M45
Hub Unit Bearing HA590171[2] ²⁵

²⁵New Item, Check For Availability

Mfg./Year	Model & Location	Part No.	Mfg./Year	Model & Location	Part No.
INFINITI - REAR DRIVE - G35, G37, J30, M30, M35, M45, Q45 (cont.)					

REAR WHEEL (cont.)**RWD (cont.)**

2006-2003	G35	
Bearing Module	BM500006[2] ²⁵
2006-2002	Q45	
Bearing Module	BM500004[2] ²⁵
2004-2003	M45	
Bearing Assy	WB000002[2] ²⁵
2001-1997	Q45	
Seal	710439[2]
Bearing Assy	516004[2]
1997-1993	J30	
Seal	710439[2]
Bearing Assy	516004[2]
1996-1990	Q45	
Seal	710130[2]
Bearing Module	511011[2]
1992-1990	M30	
Seal (Inner)	710131[2]
Ball Bearing (Inner)	RW101[2]
Ball Bearing (Outer)	RW132[2]

AWD

2009-2008	M35, M45	
Hub Unit Bearing	HA590255[2] ²⁵
2008	G35, G37	
Hub Unit Bearing	HA590255[2] ²⁵
2007	G35 Coupe	
Bearing Module	BM500006[2] ²⁵
2007	G35 Sedan	
Hub Unit Bearing	HA590255[2] ²⁵
2006-2004	G35	
Bearing Module	BM500006[2] ²⁵

REAR AXLE**Differential**

2002-1990		
Seal	223542[2]
Bearing Assy	30209C[2]
Repair Sleeve	KWK99139[2]

Pinion

2007-2003	(R230 Axle)	
Seal	710117
Repair Sleeve	KWK99196
2002-1990	(R200V)	
Seal	712020
Set (Inner)	SET43
Bearing Assy (Outer)	32306C
Repair Sleeve	KWK99157
1992-1990	(R200KV)	
Seal	712020
Set (Inner)	SET45
Bearing Assy (Outer)	32306C
Repair Sleeve	KWK99157

4-SPEED AUTOMATIC TRANSMISSION**Torque Converter**

2000-1990	(RE4R01A, RE4R03A)	
Seal	224663
Repair Sleeve	KWK99181

Rear Seal/Ext. Housing

2000-1990	(RE4R01A, RE4R03A)	
Seal	223801

Selector Shaft Seal/Man. Shaft

2000-1990	(RE4R01A, RE4R03A)	
Seal	2027

ALTERNATOR

1997-1990	Hitachi 90 Amp.	
Ball Bearing (Drive End)	303CC
1997-1990	Hitachi 90 Amp.	
Ball Bearing (Rear End)	201CC

DRIVESHAFT SUPPORT

1997-1990	J30, M30	
Hanger Bearing Assy	HB6[2]

CAMSHAFT SEAL**6 Cylinder**

1997-1990	2960cc/3.0L (DOHC)	
Seal	224052[4]
Repair Sleeve	KWK99157[4]

CRANKSHAFT FRONT SEAL**6 Cylinder**

2008-2003	3498cc/3.5L	
Seal	710356
Repair Sleeve	KWK99189
1997-1990	2960cc/3.0L (DOHC)	
Seal	223340

8 Cylinder

2007-1990	4130cc/4.1L (DOHC), 4494cc/4.5L (DOHC)	
Seal	710354
Repair Sleeve	KWK99196
2006-2002	4494cc/4.5L	
Seal	710354

CRANKSHAFT REAR SEAL**6 Cylinder**

2009-2003	3498cc/3.5L (DOHC)	
Seal Viton	710363
1997-1995	2960cc/3.0L (DOHC)	
Seal PTFE H/D	228411 ²⁵
1994-1990	2960cc/3.0L (DOHC)	
Seal Viton	228410

²⁵New Item, Check For Availability

Mfg./Year Model & Location Part No. Mfg./Year Model & Location Part No.

INFINITI - REAR DRIVE - G35, G37, J30, M30, M35, M45, Q45 (cont.)

CRANKSHAFT REAR SEAL

8 Cylinder

2009-1995 4130cc/4.1L (DOHC),
4494cc/4.5L (DOHC)
Seal PTFE H/D 228411 ²⁵
1994-1990 4494cc/4.5L
Seal Viton 228410

INFINITI - SUV - EX35

FRONT WHEEL

RWD

2009-2008
Hub Unit Bearing HA590176[2] ²⁵

4WD

2009-2008
Hub Unit Bearing HA590226[2]

REAR WHEEL

RWD

2009-2008
Hub Unit Bearing HA590255[2] ²⁵

4WD

2009-2008
Hub Unit Bearing HA590255[2] ²⁵

CRANKSHAFT FRONT SEAL

6 Cylinder

2009-2008 3498cc/3.5L (DOHC)
Seal 710356
Repair Sleeve KWK99189

CRANKSHAFT REAR SEAL

6 Cylinder

2009-2008 3498cc/3.5L (DOHC)
Seal Viton 710363

INFINITI - SUV - FX35, FX45

FRONT WHEEL

RWD

2008-2003
Hub Unit Bearing HA590124[2] ²⁵

AWD

2008-2003
Hub Unit Bearing HA590125[2] ²⁵

REAR WHEEL

RWD

2008-2003
Bearing Module BM500005[2] ²⁵

REAR WHEEL

AWD

2008-2003
Bearing Module BM500005[2] ²⁵

REAR AXLE

Pinion

2007-2004 (R230 Axle)
Seal 710117
Repair Sleeve KWK99196

CRANKSHAFT FRONT SEAL

6 Cylinder

2007-2003 3498cc/3.5L
Seal 710356

²⁵New Item, Check For Availability

Mfg./Year Model & Location Part No. Mfg./Year Model & Location Part No.

INFINITI - SUV - FX35, FX45 (cont.)

CRANKSHAFT FRONT SEAL
8 Cylinder
 2007-2003
 Seal 224650

CRANKSHAFT REAR SEAL
6 Cylinder
 2009-2003 3498cc/3.5L (DOHC)
 Seal Viton 710363

CRANKSHAFT REAR SEAL
8 Cylinder
 2008-2003 4494cc/4.5L
 Seal PTFE H/D 228411 ²⁵

INFINITI - SUV - QX4

FRONT WHEEL
RWD
 2003-1997
 Seal (Inner) 710072[2]
 Set (Inner) SET37[2]
 Cone/Cup (Outer) LM300849-LM300811[2]

4WD
 2003-1997
 Seal (Inner) 710072[2]
 Set (Inner) SET37[2]
 Cone/Cup (Outer) LM300849-LM300811[2]

REAR WHEEL
RWD
 2003-1997
 Seal (Outer) 710176[2]
 Bearing Assy (Inner) 516005[2]

4WD
 2003-1997
 Seal 710176[2]
 Bearing Assy 516005[2]

4WD FRONT AXLE
Axle Shaft
 2002-1997 (R200A Axle)
 Seal (Inner) 1181
 Seal (Outer) 710398
 Ball Bearing (Outer) RW114R[2]

Differential
 2002-1997 (R200A Axle)
 Seal 223542[2]
 Bearing Assy 30209C[2]
 Repair Sleeve KWK99139[2]

4WD FRONT AXLE
Pinion
 2002-1997 (R200A Axle)
 Seal 712020
 Bearing Assy (Inner) 32307
 Bearing Assy (Outer) 32306C
 Repair Sleeve KWK99157

REAR AXLE
Differential
 2002-1997 (H233BS Axle)
 Cone/Cup 17887-17831[2]

Pinion
 2003-1997 (H233BS Axle)
 Seal 710245
 Bearing Assy (Inner) 32308
 Bearing Assy (Outer) 32306C
 Repair Sleeve KWK99166

TRANSFER CASE REBUILD KIT
 2003-1997
 Kit TRKFN510

TRANSFER CASE
Input Shaft
 2003-1997 (TX10A)(M/T)
 Seal 225030
 Ball Bearing 306TB[2]
 Repair Sleeve KWK99196
 2000-1997 (TX10A)(A/T)
 Seal 225035
 Ball Bearing 306TB[2]
 Repair Sleeve KWK99196

Front Output Shaft
 2003-1997 (TX10A)
 Seal 710113
 Ball Bearing 212L[2]

²⁵New Item, Check For Availability

Mfg./Year Model & Location Part No. Mfg./Year Model & Location Part No.

INFINITI - SUV - QX4 (cont.)

TRANSFER CASE

Rear Output Shaft

2003-1997 (TX10A)
 Seal 224266
 Ball Bearing 213SL[2]
 Repair Sleeve KWK99166

Drive Sprocket

2003-1997 (TX10A)
 Ball Bearing 208[2]

Selector Shaft Seal/Man. Shaft

2003-1997 (TX10A)
 Seal 221710
 Repair Sleeve KWK99068

4-SPEED AUTOMATIC TRANSMISSION

Torque Converter

2000-1997 (RE4R01A)
 Seal 224663
 Repair Sleeve KWK99181

Rear Seal/Ext. Housing

2000-1997 (RE4R01A)
 Seal 223801

Selector Shaft Seal/Man. Shaft

2000-1997 (RE4R01A)
 Seal 2027

CAMSHAFT SEAL

6 Cylinder

2000-1997 3274cc/3.3L
 Seal 223420[2]
 Repair Sleeve KWK99134[2]

CRANKSHAFT FRONT SEAL

6 Cylinder

2003-2001 3498cc/3.5L
 Seal 710356

CRANKSHAFT FRONT SEAL (cont.)

6 Cylinder (cont.)

2000-1997 3274cc/3.3L
 Seal 224052
 Repair Sleeve KWK99157

CRANKSHAFT REAR SEAL

6 Cylinder

2003-2001 3498cc/3.5L (DOHC)
 Seal Viton 710363
 2000-1997 3274cc/3.3L
 Seal PTFE H/D 228411 ²⁵

INFINITI - SUV - QX56

FRONT WHEEL

RWD

2009-2008
 Hub Unit Bearing SP500703[2] ²⁵
 2007-2004
 Hub Unit Bearing SP500701[2] ⁷⁸

4WD

2009-2008
 Hub Unit Bearing SP500703[2] ²⁵
 2007-2004
 Hub Unit Bearing SP500701[2] ⁷⁸

REAR WHEEL

RWD

2009-2004
 Hub Unit Bearing SP500702[2] ⁷⁸

4WD

2009-2004
 Hub Unit Bearing SP500702[2] ⁷⁸

²⁵New Item, Check For Availability

⁷⁸6 Stud, New Item.

Mfg./Year	Model & Location	Part No.	Mfg./Year	Model & Location	Part No.
-----------	------------------	----------	-----------	------------------	----------

INFINITI - SUV - QX56 (cont.)**FRONT AXLE****Pinion**

2007-2004
 Seal 710117
 Repair Sleeve KWK99196

TRANSFER CASE**Front Output Shaft**

2006-2004
 Seal 710113

CRANKSHAFT REAR SEAL**8 Cylinder**

2009-2004
 Seal PTFE H/D 228411²⁵

INTERNATIONAL TRUCK - 1/2, 3/4, 1, 1-1/2, 2 TON - All Models - by axle designation**REAR AXLE****Differential**

1991-1990 (14038 Axle)
 Bearing Assy 32218M[2]

Pinion

1991-1990 (14021, 14022 Axles)
 Bearing Assy (Inner) 30311
 Bearing Assy (Outer) 30309M
 1991-1990 (14038 Axle)
 Bearing Assy (Inner) 30311

ISOTTA FRASCHINI - ALL**FRONT WHEEL****RWD**

1999-1996 T8 spider
 Ball Bearing 510019[2]

REAR WHEEL**RWD**

1999-1996 T8 spider
 Ball Bearing 510019[2]

ISUZU - FRONT DRIVE - Impulse, Stylus**FRONT WHEEL****FWD**

1993-1991 Stylus (Exc. Turbo)
 Seal (Inner) 710194[2]
 Ball Bearing (Inner) 510033[2]
 Seal (Outer) 1953S[2]
 1993-1991 Stylus (Turbo)
 Seal (Inner) 710194[2]
 Bearing Assy (Inner) 517005WB[2]
 Seal (Outer) 710192[2]

FRONT WHEEL (cont.)**FWD (cont.)**

1992-1990 Impulse (Exc. Turbo)
 Ball Bearing 510033[2]
 Seal 1953S[2]
 1992-1990 Impulse (Turbo)
 Seal (Inner) 710194[2]
 Bearing Assy (Inner) 517005WB[2]
 Seal (Outer) 710192[2]

²⁵New Item, Check For Availability

Mfg./Year Model & Location Part No. Mfg./Year Model & Location Part No.

ISUZU - FRONT DRIVE - Impulse, Stylus (cont.)

FRONT WHEEL

AWD

1992-1991 Impulse (Turbo)
 Seal (Inner) 710194[2]
 Bearing Assy (Inner) 517005WB[2]
 Seal (Outer) 710192[2]

REAR WHEEL

FWD

1993-1991 Stylus
 Hub Unit Bearing 512171[2]
 1992-1990 Impulse
 Hub Unit Bearing 512171[2]

AWD

1992-1991 Impulse
 Hub Unit Bearing 512171[2]

REAR AXLE

Differential

1992-1991 Impulse (AWD)
 Cone/Cup LM501349-LM501314[2]

Pinion

1992-1991 Impulse (AWD)
 Cone/Cup (Inner) 02475-02420
 Seal (Outer) 473258
 Bearing Assy (Outer) 30305M
 Repair Sleeve KWK99139

CLUTCH

Pilot Bearing

1997-1996 4 Cyl. 2.2
 Bushing H/D PB652HD
 1996-1992 6 Cyl. 3.2 (SOHC)(DOHC)
 Ball Bearing 203FFW
 1995-1990 (4 Cyl.)
 Ball Bearing 203FF
 1994-1990 6 Cyl. 2.8
 Bushing H/D PB652HD
 1994-1990 6 Cyl. 3.1
 Bushing H/D PB652HD

Release Bearing

1999-1998 4 Cyl. 2.2 (260mm Cl.)
 Bearing Assy 614154
 1998-1996 4 Cyl. 2.2 (Hyd.piston type)
 Bearing Assy 614174
 1998-1991 6 Cyl. 3.1 (260mm Cl.)
 Bearing Assy 614154
 1998-1991 6 Cyl. 3.2 (260mm Cl.)
 Bearing Assy 614154
 1998-1991 6 Cyl. 3.2 (DOHC)(260mm Cl.)
 Bearing Assy 614154
 1998-1991 6 Cyl. 3.5 (260mm Cl.)
 Bearing Assy 614154
 1997-1993 4 Cyl. 2.6 (260mm Cl.)(MUA
 Trans.)
 Bearing Assy 614154

CLUTCH (cont.)

Release Bearing (cont.)

1997-1993 4 Cyl. 2.6 (260mm Cl.)(Warner
 Trans.)
 Bearing Assy 614163
 1997-1993 6 Cyl. 3.2 (240mm Cl.)
 Bearing Assy 614163
 1995-1990 4 Cyl. 2.6 (246mm Cl.)
 Bearing Only 613012
 1995-1990 4 Cyl. 2.3 (215mm Cl.)
 Bearing Only 01496
 1994-1991 6 Cyl. 3.1 (246mm Cl.)
 Bearing Only 613012
 1993-1990 4 Cyl. 1.5 (Turbo)(215mm Cl.)
 Bearing Assy 614108
 1993-1990 4 Cyl. 1.6 (215mm Cl.)
 Bearing Assy 614108
 1993-1990 4 Cyl. 1.6 (DOHC)(215mm Cl.)
 Bearing Assy 614108
 1993-1990 4 Cyl. 1.6
 (DOHC)(Turbo)(215mm Cl.)
 Bearing Assy 614108
 1993-1990 4 Cyl. 1.8 (DOHC)(215mm Cl.)
 Bearing Assy 614108
 1992-1991 6 Cyl. 3.1 (240mm Cl.)(MUA
 Trans.)
 Bearing Only 613012
 1992-1991 6 Cyl. 3.1 (240mm Cl.)(Warner
 Trans.)
 Bearing Assy 614083
 1991-1990 6 Cyl. 2.8 (235mm Cl.)
 Bearing Only 613012

3-SPEED AUTOMATIC TRANSAXLE

Differential

1993-1990 (F3A)
 Bearing Assy 32008XM[2]

Torque Converter

1993-1990 (F3A)
 Seal Viton 710078
 Repair Sleeve KWK99177

Output Shaft

1993-1990 Stylus, lmark (F3A)
 Seal 223542[2]
 Repair Sleeve KWK99139[2]

4-SPEED AUTOMATIC TRANSAXLE

Differential

1992-1990 Impulse (JF403)
 Bearing Assy 30208M[2]

Torque Converter / Frt Pump

1992-1990 Impulse (JF403)
 Seal 710114

Mfg./Year	Model & Location	Part No.	Mfg./Year	Model & Location	Part No.
-----------	------------------	----------	-----------	------------------	----------

ISUZU - FRONT DRIVE - Impulse, Stylus (cont.)**5-SPEED MANUAL TRANSAXLE****Transaxle Rebuild Kit**

1993-1990 (MSG5G)
Kit TRKFI120

Differential

1993-1990 (MFD5M)
Bearing Assy 32008XM[2]
1992-1990 (MFD5T)
Bearing Assy (LH) 32008XM

Input Shaft

1993-1990 (MFD5M, MFD5T)
Seal 222835
Repair Sleeve KWK99111
Bearing Assy (Frt) 32206M[2]
Bearing Assy (Rr) 30306M[2]

Output Shaft

1993-1990 (MFD5M)
Set (LH) SET5[2]
Seal (RH) 223542
Bearing Assy (RH) 32206M[2]
Repair Sleeve KWK99139
1992-1990 (MFD5T)
Seal (LH) 3543
Repair Sleeve (LH) KWK99139
Seal Viton (RH) 710428
Repair Sleeve (RH) KWK99210

Selector Shaft Seal/Man. Shaft

1993-1990 (MFD5M, MFD5T)
Seal 3667

ALTERNATOR

1995-1990 Hitachi 60 Amp.
Ball Bearing (Drive End) 303CC
Ball Bearing (Rear End) 201CC

CAMSHAFT SEAL**4 Cylinder**

1993-1990 1588cc/1.6L (DOHC)
Seal 710308[2]
Repair Sleeve KWK99157[2]

CRANKSHAFT FRONT SEAL**4 Cylinder**

1993-1990 1471cc/1.5L, 1471cc/1.5L
(Turbo), 1588cc/1.6L,
1588cc/1.6L (DOHC), 1808CC/
1.8L (DOHC)
Seal 223220
Repair Sleeve KWK99128

CRANKSHAFT REAR SEAL**4 Cylinder**

1993-1990 1471cc/1.5L, 1471cc/1.5L
(Turbo), 1588cc/1.6L,
1588cc/1.6L (DOHC), 1808CC/
1.8L (DOHC)
Seal 228700

ISUZU TRUCK - Minivan, SUV, Truck - Amigo, Ascender, Axiom, Hombre, Oasis, Pickup, Rodeo, Rodeo Sport, Trooper, VehiCROSS**FRONT WHEEL****FWD**

1999-1996 Oasis
Bearing Module 510038[2]

FRONT WHEEL**RWD**

2008-2006 (Z85 Pkg.)
Hub Unit Bearing (LH) HA590058⁰²
Hub Unit Bearing (RH) HA590062⁰²
2008-2006 (ZQ8 Pkg.)
Hub Unit Bearing (LH) HA590054⁰²
Hub Unit Bearing (RH) HA590059⁰²

⁰²Does Not Come w/ Sensor Cable.

Mfg./Year	Model & Location	Part No.	Mfg./Year	Model & Location	Part No.
ISUZU TRUCK - Minivan, SUV, Truck - Amigo, Ascender, Axiom, Hombre, Oasis, Pickup, Rodeo, Rodeo Sport, Trooper, VehiCROSS (cont.)					

FRONT WHEEL (cont.)

RWD (cont.)

2008-2003	Ascender	
	Hub Unit Bearing	513188[2]
2004-2002	Axiom (From 11/1/01)	
	Hub Unit Bearing	HA590653[2]
2004-2002	Rodeo, Rodeo Sport	
	Hub Unit Bearing	HA590653[2]
2002	Axiom (Thru 10/31/01)	
	Seal (Inner)	710168[2]
	Cone/Cup (Inner)	NP697136-NP592766[2]
	Cone/Cup (Outer)	NP654538-NP177400[2]
2001-1995	Rodeo, Rodeo Sport	
	Seal (Inner)	710168[2]
	Cone/Cup (Inner)	NP697136-NP592766[2]
	Cone/Cup (Outer)	NP654538-NP177400[2]
2000-1998	Amigo	
	Seal (Inner)	710168[2]
	Cone/Cup (Inner)	NP697136-NP592766[2]
	Cone/Cup (Outer)	NP654538-NP177400[2]
2000-1996	Hombre	
	Seal (Inner)	4739[2]
	Set (Inner)	SET6[2]
	Set (Outer)	SET34[2]
1996-1995	Trooper	
	Seal (Inner)	710168[2]
	Cone/Cup (Inner)	NP697136-NP592766[2]
	Cone/Cup (Outer)	NP654538-NP177400[2]
1994-1991	Rodeo	
	Seal (Inner)	710168[2]
	Cone/Cup (Inner)	XAA32009X-Y32009X[2]
	Bearing Assy (Outer)	32008XM[2]
1994-1990	Amigo	
	Seal (Inner)	710168[2]
	Bearing Assy (Inner)	32009XM[2]
	Bearing Assy (Outer)	32008XM[2]
1994-1990	Pup, Pickup	
	Seal (Inner)	1974[2]
	Set (Inner)	SET5[2]
	Set (Outer)	SET3[2]
1994-1990	Trooper	
	Seal (Inner)	1974[2]
	Set (Inner)	SET5[2]
	Set (Outer)	SET3[2]

4WD

2008-2006	Pickup	
	Hub Unit Bearing (LH)	HA590060 ⁰²
	Hub Unit Bearing (RH)	HA590023 ⁰²
2008-2003	Ascender	
	Hub Unit Bearing	513188[2]
2002	Axiom (Thru 10/31/01)	
	Seal (Inner)	710168[2]
	Cone/Cup (Inner)	NP697136-NP592766[2]
	Cone/Cup (Outer)	NP654538-NP177400[2]
2002-1990	Trooper	
	Seal (Inner)	710168[2]
	Cone/Cup (Inner)	NP697136-NP592766[2]
	Cone/Cup (Outer)	NP654538-NP177400[2]

FRONT WHEEL (cont.)

4WD (cont.)

2001-1999	VehiCROSS	
	Seal (Inner)	710168[2]
	Cone/Cup (Inner)	NP697136-NP592766[2]
	Cone/Cup (Outer)	NP654538-NP177400[2]
2001-1995	Rodeo, Rodeo Sport	
	Seal (Inner)	710168[2]
	Cone/Cup (Inner)	NP697136-NP592766[2]
	Cone/Cup (Outer)	NP654538-NP177400[2]
2000-1998	Amigo	
	Seal (Inner)	710168[2]
	Cone/Cup (Inner)	NP697136-NP592766[2]
	Cone/Cup (Outer)	NP654538-NP177400[2]
2000-1998	Hombre	
	Hub Unit Bearing	513124[2]
1994-1991	Rodeo	
	Seal (Inner)	710168[2]
	Bearing Assy (Inner)	32009XM[2]
	Cone (Outer)	A140[2]
1994-1990	Amigo	
	Seal (Inner)	710168[2]
	Bearing Assy (Inner)	32009XM[2]
	Cone (Outer)	A140[2]
1994-1990	Pickup	
	Seal (Inner)	710168[2]
	Bearing Assy (Inner)	32009XM[2]
	Cone (Outer)	A140[2]

REAR WHEEL

FWD

1999-1996	Oasis	
	Hub Unit Bearing	512124[2]

RWD

2008-2006	Pickup	
	Seal	4762N[2]
	Cylindrical Bearing	513067[2]
2008-2003	Ascender	
	Seal	4762N[2]
	Cylindrical Bearing	513067[2]
	Bearing & Seal Kit	TRP59047[2] ¹⁹
2004-1998	Amigo, Axiom, Rodeo, Rodeo Sport	
	Seal	9912S[2]
	Cylindrical Bearing	RW131R[2]
2002-1990	Trooper, Trooper II (From 7/1/87)	
	Seal (Inner)	225230[2]
	Ball Bearing (Inner)	511016[2]
	Seal (Outer)	473179[2]
2001-1999	VehiCROSS	
	Seal (Inner)	225230[2]
	Ball Bearing (Inner)	511016[2]
	Seal (Outer)	473179[2]
2000-1996	Hombre (8.5 R.G.)	
	Seal	8835S[2]
	Cylindrical Bearing	6408[2]

⁰²Does Not Come w/ Sensor Cable.

¹⁹Opt. Axle Rpr Brg. Replaces O.E. Brg & Seal

Mfg./Year	Model & Location	Part No.	Mfg./Year	Model & Location	Part No.
ISUZU TRUCK - Minivan, SUV, Truck - Amigo, Ascender, Axiom, Hombre, Oasis, Pickup, Rodeo, Rodeo Sport, Trooper, VehiCROSS (cont.)					

REAR WHEEL (cont.)**RWD (cont.)**

2000-1996	Hombre (GM Axle)(7.625" R.G.)	
	Cylindrical Bearing	5707[2]
	Seal (Axle Code C)(Mf	
	In U.S.A.)	710166[2]
	Seal (Axle Code K)(Mf	
	In Canada)	8660S[2]
1997-1991	Rodeo (GM Axle)(7.625" R.G.)	
	Seal	710166[2]
	Cylindrical Bearing	5707[2]
	Bearing & Seal Kit	TRP1563TAV[2] ¹⁹
1995-1994	Rodeo (6 Cyl.)	
	Seal	9912S[2]
	Set	SET10[2]
1995-1990	Pickup (2.3L)	
	Seal (Inner)	473812[2]
	Bearing Assy (Inner)	30208M[2]
	Seal (Outer)	473179[2]
1995-1990	Pickup (2.6L)	
	Seal (Inner)	225230[2]
	Ball Bearing (Inner)	511016[2]
	Seal (Outer)	473179[2]
1994-1990	Amigo (2.6L)	
	Seal (Inner)	225230[2]
	Ball Bearing (Inner)	511016[2]
	Seal (Outer)	473179[2]
1993-1990	Amigo (2.3L)	
	Seal (Inner)	473812[2]
	Bearing Assy (Inner)	30208M[2]
	Seal (Outer)	473179[2]

4WD FRONT AXLE**Axle Shaft**

2008-2003	(I-280, i-290, i-350, i-370, Ascender)	
	Cylindrical Bearing	513067[2]
	Seal	710491[2]
2004-1996	(7.25" R.G.)	
	Seal	710516[2]
2000-1998		
	Seal	710491[2]
1995-1990	Amigo, Pickup, Rodeo, Trooper, Trooper II	
	Seal (Inner)	710169
	Ball Bearing (Inner)	106FL[2]
	Seal (Outer)	710170

Differential

2007-2006	Pickup	
	Cone/Cup	LM501349-LM501314[2]
2006-2003	Ascender	
	Set	SET11[2]
2004-1990	(10 Bolt Hsg. Cover)	
	Set	SET45[2]
2000-1998	Hombre (7.25" R.G.)	
	Set	SET11[2]
1999-1996	Oasis	
	Bearing Assy (LH)	30208M

4WD FRONT AXLE**Pinion**

2007-2003	Ascender	
	Seal	710474 ²⁵
	Cone/Cup (Inner)	M88048-M88010
	Cone/Cup (Outer)	M86649-M86610
2004-1999	(10 Bolt Hsg. Cover)	
	Seal	710513
	Bearing Assy (Inner)	32307
	Bearing Assy (Outer)	30306M
2000-1998	Hombre (7.25" R.G.)	
	Seal	8611N
	Cone/Cup (Inner)	M88047-M88010
	Cone/Cup (Outer)	M86649-M86610
1998-1990	(10 Bolt Hsg. Cover)	
	Seal	474133
	Bearing Assy (Inner)	32307
	Bearing Assy (Outer)	30306M

Steering Knuckle

1995-1990		
	Seal	710527[2]

REAR AXLE**Differential Rebuild Kit**

2007-2006	(8" RG)	
	Kit	DRK320D
2007-1999	(8.625" R.G.)	
	Kit	DRK321C
2001	(7.625" R.G.)(1st Design)(1.5" Seal I.D.)	
	Kit	DRK320
2001	(7.625" R.G.)(2nd Design)(1.687" Seal I.D.)	
	Kit	DRK320B
2000-1999	Hombre (GM Axle)(7.625" R.G.)	
	Kit	DRK320C
2000-1991	(7.5" R.G., 7.625" R.G.)	
	Kit	DRK320
1997	(8.5" R.G.)(1st Design)	
	Kit	DRK321

Differential

2007-2006	Pickup	
	Set	SET36[2]
2006-2003	Ascender	
	Set	SET36[2]
2004-1996	(7.625", 8.50" R.G.)	
	Cone/Cup	LM501349-LM501314[2]
2004-1993	(Dana/Spicer 44-3 Axle)	
	Cone/Cup	25590-25523[2]
1999-1990	(KS22, NPR, R040, Axles)	
	Cone/Cup	29590-29522[2]
1995-1990	(10 Bolt Hsg. Cover)(2.6L Engine)	
	Bearing Assy	30210M[2]
1994-1990	(10 Bolt Hsg. Cover)(2.3L Engine)	
	Set	SET45[2]

¹⁹Opt. Axle Rpr Brg. Replaces O.E. Brg & Seal²⁵New Item, Check For Availability

Mfg./Year	Model & Location	Part No.	Mfg./Year	Model & Location	Part No.
ISUZU TRUCK - Minivan, SUV, Truck - Amigo, Ascender, Axiom, Hombre, Oasis, Pickup, Rodeo, Rodeo Sport, Trooper, VehiCROSS (cont.)					

REAR AXLE

Pinion

2007-2003	Ascender	
	Cone/Cup (Inner) (All)	M802048-M802011
	Cone/Cup (Outer) (5 Passenger)	M86649-M86610
	Cone/Cup (Outer) (7 Passenger)	M88048-M88010
	Seal (All)	710506
2007-1998	(GM Axle)(8.50" R.G.)	
	Cone/Cup (Inner)	M802048-M802011
	Cone/Cup (Outer)	M88048-M88010
	Seal	710506
2001	(7.625" R.G.)(1st Design)(1.5" Seal I.D.)	
	Seal (Inner)	HM89249-HM89210
	Seal (Outer)	M86648A-M86610
	Seal (Outer)	8610
2001	(7.625" R.G.)(2nd Design)(1.687" Seal I.D.)	
	Seal (Inner)	HM89249-HM89210
	Seal (Outer)	M86649-M86610
	Seal (Outer)	710474 ²⁵
2000-1990	Pickup (GM Axle)(7.625" R.G.)	
	Cone/Cup (Inner)	HM89249-HM89210
	Cone/Cup (Outer)	M86649-M86610
	Seal	8610
1996-1990	Rodeo (GM Axle)(7.625" R.G.)	
	Cone/Cup (Inner)	HM89249-HM89210
	Cone/Cup (Outer)	M86649-M86610
	Seal	8610
1995-1990	(10 Bolt Hsg. Cover)	
	Bearing Assy (Inner)	32307
	Bearing Assy (Outer)	30306M
	Seal	474133

TRANSFER CASE REBUILD KIT

2001-1998	Kit	TRKFI190
------------------	-----	----------

TRANSFER CASE

Input Shaft

2007-2003	(New Process 226C)	
	Ball Bearing	N5210KLB
2004-1998	(Borg Warner 4422)	
	Seal	224250
	Ball Bearing	209L[2]
2004-1990	(MUATC)	
	Seal	710247
	Ball Bearing	207[2]
	Repair Sleeve	KWK99149
2001-1998	(New Process 233)	
	Seal	3173[2]
	Ball Bearing	110L[2]
	Seal (Opt)	710928
	Repair Sleeve	KWK99193
	Ndle Bearing (Pilot)	FC66561[2]

TRANSFER CASE

Front Output Shaft

2007-2003	(New Process 226C)	
	Ball Bearing	107WB
2004-1998	(Borg Warner 4422)	
	Ball Bearing	306TB
2001-1998	(New Process 233)	
	Seal Viton	4813V
	Ball Bearing	206WB
	Ndle Bearing (Pilot)	J2416

Rear Output Shaft

2004-1998	(Borg Warner 4422)	
	Ball Bearing	306TB
2004-1990	(MUATC)	
	Ball Bearing	307TB
2001-1998	(New Process 233)	
	Seal Kit	5200 ⁶⁴
	Seal	9613S
	Ball Bearing	206WB
	Ndle Bearing (Pilot)	B5020

Oil Pump Housing

2001-1998	(New Process 233)	
	Seal	341022
	Repair Sleeve	KWK99225

4-SPEED AUTOMATIC TRANSMISSION

Torque Converter

2002	Axiom	
	Seal	3459S
	Repair Sleeve	KWK99157
2002-1991	(4L30E)(THM700R4)	
	Seal	3227
	Repair Sleeve	KWK99174
2000-1996	(4L60, 4L60E, 4L65E)	
	Seal	4950
	Repair Sleeve	KWK99174
2000-1993	(4L80E)	
	Seal	4598
	Repair Sleeve	KWK99199
1994-1990	(Aisin 03 75, 03 80)	
	Seal	223830
	Repair Sleeve	KWK99147

Rear Seal/Ext. Housing

2007-2003	(4L60E)(Booted)	
	Seal	4934
2007-2003	(4L60E)(Exc. Booted)	
	Seal	4583
2002-1991	(4L30E)(4L60E)(THM700R4)	
	Seal	9613S
	Seal Kit	5200 ⁶⁴
2001-1999	VehiCROSS	
	Seal	3459S
	Repair Sleeve	KWK99157
2001-1998	(4L60E)(Booted)	
	Seal	4934
2001-1996	(4L60E)(Exc. Booted)	
	Seal	4583

²⁵New Item, Check For Availability

⁶⁴Seal & Bushing Kit

Mfg./Year	Model & Location	Part No.	Mfg./Year	Model & Location	Part No.
ISUZU TRUCK - Minivan, SUV, Truck - Amigo, Ascender, Axiom, Hombre, Oasis, Pickup, Rodeo, Rodeo Sport, Trooper, VehiCROSS (cont.)					

4-SPEED AUTOMATIC TRANSMISSION (cont.)

Rear Seal/Ext. Housing (cont.)

2000-1993	(4L80E)	
Seal	9449
Seal Kit	5208 ⁶⁴
1998-1991	Trooper	
Seal	3459S
Repair Sleeve	KWK99157
1997-1996	(4L60E)(Booted)	
Seal	9613S
1994-1990	(Aisin 03 75, 03 80)	
Seal	710319

Selector Shaft Seal/Man. Shaft

2008-1991	(4L30E)(4L60E)(4L80E)(THM70 OR4)	
Seal	8792S

CLUTCH

Pilot Bearing

2006	(2.8L DOHC)	
Ball Bearing	302CC
2006	(5 cyl.)	
Ball Bearing	302CC
2003-1990	(4 Cyl.)	
Ball Bearing	203FF
2001-1996	4 Cyl. 2.2	
Bushing H/D	PB652HD
2000-1999	4.3 V6	
Ball Bearing	302CC
1998-1997	4.3 V6	
Ball Bearing	57080
1998-1992	6 Cyl. 3.2 (SOHC)(DOHC)	
Ball Bearing	203FFW
1994-1990	(6 Cyl.)	
Bushing H/D	PB652HD

Release Bearing

2006	5 Cyl.	
Bearing Assy	614174
2003-2000	2.2L (DOHC)	
Bearing Assy	614163
2003-1996	4 Cyl. 2.2 (Hyd.piston type)	
Bearing Assy	614174
2003-1991	6 Cyl. 3.2 (DOHC)(260mm Cl.)	
Bearing Only	613012
2001-1997	6 Cyl. 4.3 (Hyd. Cl.)	
Bearing Assy	614174
1999-1998	2.2 (240MM Clutch)	
Bearing Assy	614163
1999-1993	6 Cyl. 3.2 (240mm Cl.)	
Bearing Assy	614163
1998-1991	6 Cyl. 3.1 (260mm Cl.)	
Bearing Assy	614154
1998-1991	6 Cyl. 3.2 (260mm Cl.)	
Bearing Assy	614154
1998-1991	6 Cyl. 3.5 (260mm Cl.)	
Bearing Assy	614154

CLUTCH (cont.)

Release Bearing (cont.)

1997-1993	4 Cyl. 2.6 (260mm Cl.)(MUA Trans.)	
Bearing Assy	614154
1997-1993	4 Cyl. 2.6 (260mm Cl.)(Warner Trans.)	
Bearing Assy	614163
1995-1990	4 Cyl. 2.6 (246mm Cl.)	
Bearing Only	613012
1995-1990	4 Cyl. 2.3 (225mm Cl.)	
Bearing Assy	614078
1995-1990	4 Cyl. 2.3 (215mm Cl.)	
Bearing Only	01496
1994-1991	6 Cyl. 3.1 (246mm Cl.)	
Bearing Only	613012
1993-1990	4 Cyl. 1.5 (Turbo)(215mm Cl.)	
Bearing Assy	614108
1993-1990	4 Cyl. 1.6 (215mm Cl.)	
Bearing Assy	614108
1993-1990	4 Cyl. 1.6 (DOHC)(215mm Cl.)	
Bearing Assy	614108
1993-1990	4 Cyl. 1.6 (DOHC)(Turbo)(215mm Cl.)	
Bearing Assy	614108
1993-1990	4 Cyl. 1.8 (DOHC)(215mm Cl.)	
Bearing Assy	614108
1992-1991	6 Cyl. 3.1 (240mm Cl.)(MUA Trans.)	
Bearing Only	613012
1992-1991	6 Cyl. 3.1 (240mm Cl.)(Warner Trans.)	
Bearing Assy	614083
1991-1990	6 Cyl. 2.8 (235mm Cl.)	
Bearing Only	613012

5-SPEED MANUAL TRANSMISSION

Transmission Rebuild Kit

2002-1991	(MSG5F)	
Kit	TRKFI160
2002-1991	(MSG5G)	
Kit	TRKFI200
2002-1991	(Warner T5 World Class)	
Kit	TRK5W
2000-1996	(New Venture 1500)	
Kit	TRK1500GM
1991-1990	(MSG5F)	
Kit	TRKFI130

Front Input Shaft

2004-1998	(AR-5)	
Seal	223253
2004-1992	(MUA5C, MUA5CT)	
Ball Bearing	308L
Seal	710511
2001-1997	(New Process 3500)	
Seal	4529N
Ball Bearing	307FFLS[2]
Repair Sleeve	KWK99138

⁶⁴Seal & Bushing Kit

Mfg./Year	Model & Location	Part No.	Mfg./Year	Model & Location	Part No.
ISUZU TRUCK - Minivan, SUV, Truck - Amigo, Ascender, Axiom, Hombre, Oasis, Pickup, Rodeo, Rodeo Sport, Trooper, VehiCROSS (cont.)					

5-SPEED MANUAL TRANSMISSION (cont.)

Front Input Shaft (cont.)

2001-1996 (New Process 1500)	
Seal	223020
Ball Bearing	306VVL[2]
1999-1998 (Warner T5)	
Seal	7412S
Set	SET5[2]
Repair Sleeve	KWK99125
Ndle Bearing	FA55505[2]
1994-1991 (Warner T5)	
Seal	7412S
Set	SET5[2]
Repair Sleeve	KWK99125
Ndle Bearing	FA55505[2]
1994-1990 (MSG5A, MAG5C, MSG5T)	
Seal	1990
Ball Bearing	208LO[2]
Repair Sleeve	KWK99106
1993-1990 (MSA5D, MSG5D, MSG5R)	
Seal	1990
Repair Sleeve	KWK99106
1991-1990 (MUA5, MUA5T)	
Seal	710157
Repair Sleeve	KWK99103

Countershaft

2004-1998 (AR-5)	
Cylindrical Bearing (Frt)	MSN5305GTBV ²⁵
2000-1997 (New Process 3500)	
Ndle Bearing	FC68336[2]
2000-1996 (New Process 1500)	
Ndle Bearing (Frt)	FC68336[2]
Ball Bearing (Rr)	206FF[2]
1999-1998 (Warner T5)	
Cone/Cup (Frt)	LM67048-LM67010BCE[2]
Set (Rr)	SET6[2]
Ndle Bearing Thrust	NTA1423[2]
1994-1991 (Warner T5)	
Cone/Cup (Frt)	LM67048-LM67010BCE[2]
Set (Rr)	SET6[2]
Ndle Bearing Thrust	NTA1423[2]

Mainshaft Pilot

1999-1991 (Warner T5)	
Ndle Bearing	QBR23549[15]

Mainshaft 1st Speed Gear

1999-1991 (Warner T5)	
Ndle Bearing	F218255[2]

Mainshaft 2nd Speed Gear

1999-1991 (Warner T5)	
Ndle Bearing	F93934[2]

5-SPEED MANUAL TRANSMISSION

Rear Output Shaft

2004-1998 (AR-5)(4WD)	
Seal	1209N
2004-1998 (AR-5)(RWD)	
Seal	710319
2004-1990 (MUA5, MSG5C, MUA5C, MSG5F)	
Seal	710247
2002-1990 (MUA5T, MUA5CT)	
Seal	224250
2001-1997 (New Process 3500)	
Seal	416288
Ball Bearing	307FFT[2]
2001-1996 (New Process 1500)	
Seal	416288
Ball Bearing	306L[2]
1999-1991 (Warner T5)	
Seal	710441
Cone/Cup	25877-25821[2]
1993-1990 (MSA5D)	
Ball Bearing	308FFL[2]

4-SPEED AUTOMATIC TRANSAXLE

Differential

1997-1996 (MPJA)	
Bearing Assy (LH)	30208M

Torque Converter / Frt Pump

1999-1996 (MDWA, MPJA)	
Seal	350609

Input Shaft

1999-1996 (MDWA, MPJA)	
Seal	220918

Output Shaft

1999-1998 (MDWA)	
Seal (LH)	710315
Repair Sleeve (LH)	KWK99139
Seal (RH)	224066
Repair Sleeve (RH)	KWK99157
1997-1996 (MPJA)	
Seal (LH)	2007N
Repair Sleeve (LH)	KWK99139
Seal (RH)	224066
Repair Sleeve (RH)	KWK99157

Pinion

1997-1996 (MPJA)	
Seal	222830
Repair Sleeve	KWK99111

²⁵New Item, Check For Availability

Mfg./Year	Model & Location	Part No.	Mfg./Year	Model & Location	Part No.
ISUZU TRUCK - Minivan, SUV, Truck - Amigo, Ascender, Axiom, Hombre, Oasis, Pickup, Rodeo, Rodeo Sport, Trooper, VehiCROSS (cont.)					

4-SPEED AUTOMATIC TRANSAXLE**Manual Shaft**

1997-1996 (MPJA)	
Seal	221207
Repair Sleeve	KWK99049

ALTERNATOR

1997-1990 Hitachi 60 Amp.	
Ball Bearing (Drive End)	303CC
Ball Bearing (Rear End)	201CC

DRIVESHAFT SUPPORT

2001-1996 (Spicer 1280 1410)(1.3780" Brg. I.D.)	
Ball Bearing	88107[2]
Hanger Bearing Assy	HB88107A[2]
Hanger Bearing Assy	
Opt. w/ Slinger	HB88107E[2]
1997-1991 Rodeo (2WD)	
Hanger Bearing Assy	HB32[2]
1997-1991 Rodeo (4WD)	
Hanger Bearing Assy	HB33[2]

CV JOINT HALF SHAFT

1999-1996 Oasis	
Seal	710300

OIL PUMP**4 Cylinder**

1999-1996 2156cc/2.2L, 2253cc/2.3L(SOHC)	
Seal Viton	712009
Repair Sleeve	KWK99106

CAMSHAFT SEAL**4 Cylinder**

2003-2000 2180cc/2.2L (DOHC)	
Seal	710515
2000 2180cc/2.2L (OHV)	
Seal	712008
1997-1990 2254cc/2.3L, 2559cc/2.6L	
Seal	223014
Repair Sleeve	KWK99114

6 Cylinder

2004-1992 3165cc/3.2L, 3494cc/3.5L	
Seal	223014[2]
Repair Sleeve	KWK99114[2]
2000 4294cc/4.3L	
Seal	712008

CRANKSHAFT FRONT SEAL**8 Cylinder**

2006-2003 325/ 5.3L	
Seal Viton	100470

CRANKSHAFT FRONT SEAL**4 Cylinder**

2000-1996 134/2.2L	
Seal	9845
Repair Sleeve	KWK99176
1999-1998 2254cc/2.3L	
Seal	224015
Repair Sleeve	KWK99157
1997-1996 2156cc/2.2L	
Seal	224015
Repair Sleeve	KWK99157
1997-1990 2254cc/2.3L, 2559cc/2.6L	
Seal	224025
Repair Sleeve	KWK99157

6 Cylinder

2004-2000 3.2L, 3.5L	
Seal	224020
2000 4294cc/4.3L	
Seal	9845
1999-1992 3.2L, 3.5L	
Seal	224025
Repair Sleeve	KWK99157
1994-1990 173/2.8L, 189/3.1L	
Seal	9845
Repair Sleeve	KWK99176

CRANKSHAFT REAR SEAL**4 Cylinder**

2003-1998 2180cc/2.2L (DOHC)	
Seal Viton	710237
2000-1996 2180cc/2.2L (OHV)	
Seal	4307V
Seal PTFE H/D (Opt)	5273
1999-1996 2156cc/2.2L, 2254cc/2.3L	
Seal	228015
Repair Sleeve	KWK99315
1997-1990 2254cc/2.3L, 2559cc/2.6L	
Seal	710060
Repair Sleeve	KWK99364

6 Cylinder

2004-2003 3491cc/3.5L	
Seal	710060
Repair Sleeve	KWK99369
2004-1992 3165cc/3.2L	
Seal	710060
Repair Sleeve	KWK99369
2002-1998 3475cc/3.5L	
Seal	710060
Repair Sleeve	KWK99369
2000-1997 262/4.3L	
Seal Viton	4359V
Seal PTFE H/D	5274
1994-1990 173/2.8L, 189/3.1L	
Seal	4307V
Seal PTFE H/D	5273
Repair Sleeve	KWK99298

Mfg./Year	Model & Location	Part No.	Mfg./Year	Model & Location	Part No.
ISUZU TRUCK - Minivan, SUV, Truck - Amigo, Ascender, Axiom, Hombre, Oasis, Pickup, Rodeo, Rodeo Sport, Trooper, VehiCROSS (cont.)					

CRANKSHAFT REAR SEAL

8 Cylinder

2006-2003	325/ 5.3L	
Seal	100085

JAGUAR - ALL

FRONT WHEEL

RWD

2009-2007	XK	
Ball Bearing	510010[2]
2009-1999	XK8, XKR	
Ball Bearing	510010[2]
2009-1996	Vanden Plas	
Ball Bearing	510010[2]
2008-2004	XJ8, XJR	
Hub Unit Bearing	HA590224
2006-2000	S Type	
Hub Unit Bearing	HA590224[2]
2003-1999	XJ8, XJR	
Ball Bearing	510010[2]
1998-1997	XK8	
Set	SET49[2]
1997-1990	XJ6	
Set (Inner)	SET17[2]
Set (Outer)	SET8[2]
1996-1993	XJS	
Set (Inner)	SET17[2]
Set (Outer)	SET8[2]
1992-1990	XJS	
Seal (Inner)	473454[2]
Set (Inner)	SET13[2]
Set (Outer)	SET12[2]

AWD

2007-2002	X Type	
Ball Bearing (Replaces		
HA590225)	WB000003[2] ²⁵

REAR WHEEL

RWD

2008-2000	S Type, Super V8	
Ball Bearing	511032[2]
2008-1993	XJ6, XJ12, XJR, XJS, XJ8,	
	XK8, Vanden Plas	
Set (Inner)	SET45[2]
Cone/Cup (Outer)	LM503349A-LM503310[2]
1992-1990	XJ12, XJS	
Cone/Cup (Inner)	18590-18520[2]
Cone/Cup (Outer)	18690-18620[2]
1992-1990	XJ6, Sovereign, Vanden Plas	
Set (Inner)	SET45[2]
Cone/Cup (Outer)	LM503349A-LM503310[2]

REAR WHEEL

AWD

2007-2002	X Type	
Hub Unit Bearing	HA590174[2] ²⁵

REAR AXLE

Axle Shaft

2008-2000		
Seal Viton	714569[2]
Repair Sleeve	KWK99157[2]
1999-1990	(Salisbury axle)	
Set	SET17[2]

Differential

2005-1992		
Cone/Cup	25577C-25523[2]
1991-1990	4HU	
Cone/Cup	25577-25523[2]
1990	XJS Ser.	
Taprd Bearing Assy	JRM3535-90U01[2]

4-SPEED AUTOMATIC TRANSMISSION

Torque Converter

1995-1994	(4L80E)	
Seal	4598
Repair Sleeve	KWK99199
1995-1990	(ZF 4HP 22, ZF 4HP 24)	
Seal	224052

Rear Seal/Ext. Housing

1995-1994	(4L80E)	
Seal	9449
Seal Kit	5208 ⁶⁴
1995-1990	(ZF 4HP 22, ZF 4HP 24)	
Seal	224045

Selector Shaft Seal/Man. Shaft

1996-1994	(4L80E)	
Seal	8792S

5-SPEED AUTOMATIC TRANSMISSION

Torque Converter

2002-1997	(ZF 5HP 24)	
Seal	224015
Repair Sleeve	KWK99157

²⁵New Item, Check For Availability

⁶⁴Seal & Bushing Kit

Mfg./Year	Model & Location	Part No.	Mfg./Year	Model & Location	Part No.
-----------	------------------	----------	-----------	------------------	----------

JAGUAR - ALL (cont.)**5-SPEED AUTOMATIC TRANSMISSION****Rear Seal/Ext. Housing**

2002-1997 (ZF 5HP 24)
Seal 224045

Selector Shaft Seal/Man. Shaft

2003-2000 (5R55N)
Seal 7929S

CRANKSHAFT FRONT SEAL**6 Cylinder**

2008-2000 152/2.5L, 182/3.0L
Seal 482041N
Harmnc Balancer Slvs 88187
Repair Sleeve KWK99187

12 Cylinder

1996-1990 5343cc/5.3L, 5994cc/6.0L
Seal 450867
Repair Sleeve KWK99212

CRANKSHAFT REAR SEAL**6 Cylinder**

2008-2000 2497cc/2.5L, 2967cc/3.0L
Seal Viton 3909
Seal PTFE H/D 5277
Repair Sleeve KWK99363

JEEP - Liberty**FRONT WHEEL****RWD**

2008-2002 (ABS)
Hub Unit Bearing (LH) HA599455L
Hub Unit Bearing (RH) HA599455R
2005-2002 (Non-ABS)
Hub Unit Bearing HA599467[2]

4WD

2007-2002 (ABS)
Hub Unit Bearing (LH) HA599455L[2]
Hub Unit Bearing (RH) HA599455R[2]
2005-2002 (Non-ABS)
Hub Unit Bearing HA599467[2]

REAR WHEEL**RWD**

2009-2008
Seal SL260004[2]²⁵
Cylindrical Bearing 6410[2]
2007-2002 (Chrysler Axle)(8.25" R.G.)
Seal SL260010[2]
Cylindrical Bearing 6408[2]
Bearing & Seal Kit TRP1559TV[2]¹⁹
2002 (Dana/Spicer 35 Axle)
Seal 2146[2]
Bearing Assy NP182140-904A1[2]⁰⁸

4WD FRONT AXLE**Differential**

2005-2002
Cone/Cup LM501349-LM501314[2]

4WD FRONT AXLE**Pinion**

2008-2002
Cone/Cup (Inner) M802048-M802011
Cone/Cup (Outer) HM88649-HM88610
Seal 450303

REAR AXLE**Differential Rebuild Kit**

2007-2002 (8.25" R.G.)
Kit DRK303B²⁵
2004-2002 (Dana/Spicer 35 Axle)
Kit DRK335

Differential

2005-2002 (8.25" R.G.)
Set SET36[2]
2002 (Dana/Spicer 35 Axle)
Cone/Cup LM501349-LM501314[2]

Pinion

2008-2002 (8.25" R.G.)
Seal 710480
Cone/Cup (Inner) M802048-M802011
Cone/Cup (Outer) M86649-M86610
2002 (Dana/Spicer 35 Axle)
Seal Viton 714675
Cone/Cup (Inner) HM88648-HM88610
Cone/Cup (Outer) M86649-M86610

⁰⁸Locking Collar Not Included.
Check For Availability

¹⁹Opt. Axle Rpr Brg. Replaces O.E. Brg & Seal

²⁵New Item,

Mfg./Year Model & Location Part No. Mfg./Year Model & Location Part No.

JEEP - Liberty (cont.)

TRANSFER CASE

Input Shaft

2008-2002 (New Process 231, 242)
 Seal3173
 Seal (Opt)710928
 Repair SleeveKWK99193
 Ball Bearing110L
 Ndle Bearing (Pilot)FC66561

Front Output Shaft

2009-2002 (New Process 231)
 Seal Viton710056
 Repair SleeveKWK99155
 Ball Bearing206WB
 Ndle Bearing (Pilot)J2416
 2009-2002 (New Process 242)
 Seal3946
 Repair SleeveKWK99187
 Ball Bearing207XLO
 Ndle Bearing (Pilot)J2416

Rear Output Shaft

2005-2002 (New Process 231)
 Seal4370N
 Repair SleeveKWK99149
 Ball Bearing206WB
 Ndle Bearing (Pilot)B5020
 2005-2002 (New Process 242)
 Ball Bearing206WB
 Ndle Bearing (Pilot)C672Q¹⁶

Oil Pump Housing

2005-2002
 Seal341022
 Repair SleeveKWK99225

CAMSHAFT SEAL

4 Cylinder

2004-2002 2.4L
 Seal Viton320249

CRANKSHAFT FRONT SEAL

4 Cylinder

2005-2002 148/2.4L
 Seal Viton320348

6 Cylinder

2008-2002 226/3.7L
 Seal710472

CRANKSHAFT REAR SEAL

4 Cylinder

2005-2002 148/2.4L
 Seal Viton710056
 Repair SleeveKWK99360

6 Cylinder

2009-2002 226/3.7L
 Seal231004

JEEP - CUV - CROSSOVER / SPORT UTILITY - Compass, Patriot

FRONT WHEEL

FWD

2008-2007 Compass, Patriot
 Bearing Assy510090[2]²⁵

REAR WHEEL

RWD

2008-2007 Compass, Patriot
 Hub Unit BearingHA590216[2]²⁵

REAR WHEEL

4WD

2008-2007 Compass, Patriot
 Hub Unit BearingHA590230[2]²⁵

¹⁶Obsolete ²⁵New Item, Check For Availability

Mfg./Year	Model & Location	Part No.	Mfg./Year	Model & Location	Part No.
JEEP - SUV - SPORT UTILITY VEHICLES - Cherokee, Commander, Grand Cherokee					

FRONT WHEEL**RWD**

2008-2005	Commander, Grand Cherokee	
	Hub Unit Bearing	HA590036[2] ²⁵
2004-1999	Grand Cherokee	
	Hub Unit Bearing	HA598679[2]
2001-2000	Cherokee (Cast Rotor)	
	Hub Unit Bearing	HA597449[2]
1999	Cherokee (Cast Rotor)	
	Hub Unit Bearing	HA597449[2]
1999-1990	Cherokee (Composite Rotor)	
	Hub Unit Bearing	513084[2]
1998-1993	Grand Cherokee	
	Hub Unit Bearing	513084[2]

4WD

2008-2005	Commander, Grand Cherokee	
	Hub Unit Bearing	HA590036[2] ²⁵
2004-1999	Grand Cherokee	
	Hub Unit Bearing	HA598679[2]
2001-2000	Cherokee (Cast Rotor)	
	Hub Unit Bearing	HA597449[2]
1999	Cherokee (Cast Rotor)	
	Hub Unit Bearing	HA597449[2]
1999	Cherokee (Composite Rotor)	
	Hub Unit Bearing	513084[2]
1998-1990	Cherokee, Grand Cherokee	
	Hub Unit Bearing	513084[2]

REAR WHEEL**RWD**

2008-2005	Commander, Grand Cherokee	
	Hub Unit Bearing	HA590141[2] ²⁵
2004-1998	WJ Grand Cherokee (Dana/Spicer 35,44 Axle)	
	Seal	2146[2]
	Bearing Assy	NP182140-904A1[2] ⁰⁸
2001	KJ Cherokee (Dana/Spicer 35,44 Axle)	
	Seal	2146[2]
	Bearing Assy	NP182140-904A1[2] ⁰⁸
2001-1998	XJ Cherokee (Dana/Spicer 35 Axle)	
	Seal	8660S[2]
	Cylindrical Bearing	5707[2]
2001-1991	Cherokee, Cherokee Sport (Chrysler Axle)(8.25" R.G.)	
	Seal	8835S[2]
	Cylindrical Bearing	6408[2]
	Bearing & Seal Kit	TRP1559TV[2] ¹⁹
1997-1994	Grand Cherokee (Dana/Spicer 44)(Flg. Axle Shaft)	
	Seal (Inner)	8660S[2]
	Set (Inner)	SET10[2]
	Seal (Outer)	4857[2]
1997-1990	Cherokee, Grand Cherokee (Dana/Spicer 35 Axle)	
	Seal	8660S[2]
	Cylindrical Bearing	5707[2]

4WD FRONT AXLE**Axle Shaft**

2008-2005	(7.875" R.G.)	
	Seal	710489 ²⁵

Differential Rebuild Kit

2008-1999	(Dana/Spicer 30 Axle)	
	Kit	DRK334C
1998-1997	(Dana/Spicer 30 Axle)	
	Kit	DRK334TJ
1996-1990	(Dana/Spicer 30 Axle)	
	Kit	DRK334
1993-1990	(Dana/Spicer 44 Axle)	
	Kit	DRK339B

Differential

2004-1990	(Dana/Spicer 30, 35 Axles)	
	Cone/Cup	LM501349-LM501314[2]
1993-1990	(Dana/Spicer 44 Axle)	
	Cone/Cup	25590-25523[2]

Pinion

2008-2005	(7.875" R.G.)	
	Cone/Cup (Inner)	HM803146-HM803110
	Seal (Outer)	710461
	Cone/Cup (Outer)	M88043-M88010
2004-2002	(Dana/Spicer 35 Axle)	
	Seal Viton	714675
	Cone/Cup (Inner)	HM88648-HM88610
	Cone/Cup (Outer)	M86649-M86610
2001-1999	(Dana/Spicer 30 Axle)	
	Seal	5778
	Cone/Cup (Inner)	HM88649-HM88610
	Cone/Cup (Outer)	M86649-M86610
1998-1997	(Dana/Spicer 30 Axle)	
	Seal	5778
	Cone/Cup (Inner)	HM88649-HM88610
	Cone/Cup (Outer)	M86649-M86610
1996-1994	(Dana/Spicer 30 Axle)	
	Seal	5778
	Cone/Cup (Inner)	HM88649-HM88610
	Cone/Cup (Outer)	02872-02820
1993-1990		
	Seal (All)	5778
	Cone/Cup (Inner) (Dana/Spicer 44 Axle)	31594-31520
	Cone/Cup (Inner) (Dana/Spicer 30 Axle)	HM88649-HM88610
	Cone/Cup (Outer) (All)	02872-02820

Spindle Kit

1998-1990		
	Bearing & Seal Kit	SBK1[2] ³³

Spindle

1998-1990		
	Seal (Inner)	722108[2]
	Ndle Bearing (Inner)	B2110[2]
	Seal (Outer)	722109[2]

⁰⁸Locking Collar Not Included.
Check For Availability

¹⁹Opt. Axle Rpr Brg. Replaces O.E. Brg & Seal
³³Opt. Kit = Brg B2110, Seals 722108 & 722109.

²⁵New Item,

Mfg./Year	Model & Location	Part No.	Mfg./Year	Model & Location	Part No.
JEEP - SUV - SPORT UTILITY VEHICLES - Cherokee, Commander, Grand Cherokee (cont.)					

4WD FRONT AXLE

Intermediate Shaft

1993-1990 (Spicer 30 F)(Disconnect)
Ndle Bearing SCE108

REAR AXLE

Differential Rebuild Kit

2008-2005 (Chrysler Axle)(8.25" R.G.)
Kit DRK303B²⁵
2004-1999 (Dana/Spicer 44 Axle)
Kit DRK339B
2004-1992 (Dana/Spicer 35C Axle)
Kit DRK335C
2001-1997 (8.25" R.G.)
Kit DRK303A
1998-1990 (Dana/Spicer 44 Axle)
Kit DRK339B
1991-1990 (Dana/Spicer 35C Axle)
Kit DRK335F

Differential

2008-2005 (Chrysler C213R, C213RE)
Set SET36[2]
2008-1999 (Dana/Spicer 44-4 Axle)
Set SET36[2]
2004-1990 (Dana/Spicer 35C Axle)
Cone/Cup LM501349-LM501314[2]
1998-1991 (Chrysler Axle)(8.25" R.G.)
Set SET36[2]
1998-1990 (Dana/Spicer 44 Axle)
Cone/Cup 25590-25523[2]

Pinion

2008-2000 (Chrysler Axle)(8.25" R.G.)
Seal 710480
Cone/Cup (Inner) M802048-M802011
Cone/Cup (Outer) M86649-M86610
2008-1992 (Dana/Spicer 35C Axle)
Seal Viton 714675
Cone/Cup (Inner) HM88648-HM88610
Cone/Cup (Outer) (All) M86649-M86610
2004-1999 (Dana/Spicer 44-4 Axle)
Seal Viton (Outer) 719316
Cone/Cup (Inner) M802048-M802011
Cone/Cup (Outer) M88048-M88010
1999-1991 (Chrysler Axle)(8.25" R.G.)
Seal 8516N
Cone/Cup (Inner) M802048-M802011
Cone/Cup (Outer) M86649-M86610
1998-1990 (Dana/Spicer 44 Axle)
Seal 5778
Cone/Cup (Inner) 31594-31520
Cone/Cup (Outer) 02872-02820
1991-1990 (Dana/Spicer 35C Axle)
Seal 470331N
Cone/Cup (Inner) HM88648-HM88610
Cone/Cup (Outer) M86649-M86610

TRANSFER CASE REBUILD KIT

2002-1994 (New Process 231)
Kit TCRK231A¹⁶
1994-1990 (New Process 231)
Kit TCRK231⁵¹
1994-1990 (New Process 242)(Exc. cases
52098383/4/5)
Kit TCRK242
1991-1990 (New Process 228, 229)
Kit TCRK229

TRANSFER CASE

Input Shaft

2005-1997
Seal (N.P.
231,249)(O.E.) 3173
Seal (N.P. 231,
249)(Opt.) 710928
Repair Sleeve (N.P.
231, 242, 247, 249) KWK99193
Ball Bearing (N.P. 231,
242, 247, 249) 110L
Ndle Bearing (Pilot
(N.P. 231, 242, 247,
249) FC66561
1996-1990
Seal (N.P. 231, 242,
247, 249) 3173
Ball Bearing (N.P. 231,
242, 247, 249)(1st
Design) N5210KLB
Ball Bearing (N.P. 231,
242, 247, 249)(2nd
Design) 110L
Seal (Opt) 710928
Repair Sleeve (N.P.
231, 242, 247, 249) KWK99193
Ndle Bearing (Pilot
(N.P. 242, 247, 249) FC66561
Ndle Bearing (Pilot
(N.P. 231) SCH1810
1991-1990
Ndle Bearing (N.P.
207) B3210
Ndle Bearing (N.P.
208, 219, 228, 229) B5020
Seal (N.P. 207, 208,
219, 228, 229) 3173
Seal (Opt) 710928
Repair Sleeve (N.P.
207, 208, 219, 228,
229) KWK99193
Ndle Bearing (Pilot
(N.P. 208, 219, 228,
229) B2012
Ndle Bearing Thrust
(N.P. 228, 229) NTA3244
Ndle Bearing Thrust
(N.P. 208, 219) AXK5070

¹⁶Obsolete

²⁵New Item, Check For Availability

⁵¹BD50-8 I/S Brg.

Mfg./Year	Model & Location	Part No.	Mfg./Year	Model & Location	Part No.
-----------	------------------	----------	-----------	------------------	----------

JEEP - SUV - SPORT UTILITY VEHICLES - Cherokee, Commander, Grand Cherokee (cont.)

TRANSFER CASE

Front Output Shaft

2008-1993 (New Process 242,243,247,249)	
Seal	3946
Ball Bearing	207XLO
Repair Sleeve	KWK99187
Ndle Bearing (Pilot)	J2416
2005-1990 (New Process 231)	
Seal	710046
Ball Bearing	206WB
Repair Sleeve	KWK99155
Ndle Bearing (Pilot)	J2416
1996-1990 (New Process 242)	
Seal	3946
Ball Bearing	207
Repair Sleeve	KWK99187
Ndle Bearing (Pilot)	J2416
1991-1990 (New Process 208, 219, 228, 229)	
Seal	3946
Ndle Bearing	B2816
Repair Sleeve	KWK99187
Ndle Bearing (Pilot)	J2416
Ndle Bearing Thrust	NTA2840

Rear Output Shaft

2005-1999 (New Process 242)	
Ball Bearing	206WB
Ndle Bearing (Pilot)	C672Q ¹⁶
2005-1997 (New Process 231)	
Seal	4370N
Ball Bearing	206WB
Repair Sleeve	KWK99149
Ndle Bearing (Pilot)	B5020
1998-1993 (New Process 242, 249)	
Seal	4370N
Ball Bearing	206L
Repair Sleeve	KWK99149
Ndle Bearing (Pilot)	C672Q ¹⁶
1996-1990 (New Process 231)	
Seal	2506
Ball Bearing	206WB
Repair Sleeve	KWK99149
Ndle Bearing (Pilot)	B5020
1991-1990 (New Process 228, 229)	
Seal	3946
Ball Bearing	207
Repair Sleeve	KWK99187
Ndle Bearing (Pilot)	B3612
Ndle Bearing Thrust	TC2435

3-SPEED AUTOMATIC TRANSMISSION

Torque Converter

1996-1994 (A904, A999, 30RH, 31RH, 32RH)	
Seal	331228H[2]
Repair Sleeve	KWK99149
1991-1990 (A727)	
Seal	331227H[2]
Repair Sleeve	KWK99187

Rear Seal/Ext. Housing

1996-1994 (30RH)	
Seal	710058[2]
Ball Bearing	206LOE[2] ³⁸
1991-1990 (A727)	
Seal	7300S[2]
Ball Bearing	207XLO[2]
Seal Kit	5206 ⁶⁴

Selector Shaft Seal/Man. Shaft

2000-1990 (A904, A999, 30RH, 31RH, 32RH)	
Seal	8609

4-SPEED AUTOMATIC TRANSMISSION

Torque Converter

2004-1993 (42RE, 44RE, A500SE)	
Seal	331228H[2]
Repair Sleeve	KWK99149
2000-1990 (Aisin 03 40)	
Seal	223830[2]
Repair Sleeve	KWK99147
1995-1993 (A518, 46RH)	
Seal	331227H[2]
Repair Sleeve	KWK99187

Rear Seal/Ext. Housing

2004-1993 (42RE, 44RE)(4WD)(1.687" shaft)	
Seal	7300S[2]
Ball Bearing	207XLO[2]
Seal Kit	5206 ⁶⁴
2000-1993 (42RE, 44RE)(4WD)(1.937" shaft)	
Seal	710058[2]
Ball Bearing	207XLO[2]
2000-1990 (Aisin 30-40FL)	
Seal	225005[2]
2000-1990 (Aisin 30-40LE)	
Seal	710319[2]
1995-1993 (46RH)	
Seal	710058[2]
Ball Bearing	207XLO[2]
1993 (A518, A500SE)(1.687" shaft)	
Seal	7300S[2]
Ball Bearing	207XLO[2]
1993 (A518, A500SE)(1.937" shaft)	
Seal	710058[2]
Ball Bearing	207XLO[2]

Selector Shaft Seal/Man. Shaft

2004-1993 (A518, 42RE, 44RE, 46RH, A500SE)	
Seal	8609[2]
2001-1990 (Aisin 03 40)	
Seal	221207[2]
Repair Sleeve	KWK99049

¹⁶Obsolete³⁸Reuse Snap Ring.⁶⁴Seal & Bushing Kit

Mfg./Year Model & Location Part No. Mfg./Year Model & Location Part No.

JEEP - SUV - SPORT UTILITY VEHICLES - Cherokee, Commander, Grand Cherokee (cont.)

CLUTCH

Pilot Bearing

2002-1992	6 Cyl. 242 (4.0)	
	Ndle Bearing	SCE1295
2000-1990	(4 Cyl.)	
	Ndle Bearing	FC65446
1991-1990	6 Cyl. 242 (4.0)	
	Ndle Bearing	FC66426

Release Bearing

2002-1994	6 Cyl. 242 (4.0)	
	Bearing Assy	614093
2000-1994	4 Cyl. 150 (2.5)	
	Bearing Assy	614093
1993	4 Cyl. 150 (2.5)(Hyd. piston type)	
	Hyd. Bearing Assy	619004
1993	6 Cyl. 242 (4.0)(Hyd. piston type)	
	Hyd. Bearing Assy	619004
1992-1991	4 Cyl. 150 (2.5)(Hyd. piston type)	
	Hyd. Bearing Assy	619001
1992-1991	6 Cyl. 242 (4.0)(Hyd. piston type)	
	Hyd. Bearing Assy	619003
1990	6 Cyl. 242 (4.0)(Hyd. piston type)	
	Hyd. Bearing Assy	619008
1990	4 Cyl. 150 (2.5)(Hyd. piston type)	
	Hyd. Bearing Assy	619007

4-SPEED MANUAL TRANSMISSION

Input Shaft

1993-1990	(Aisin AX4)	
	Seal	1981[2]
	Repair Sleeve	KWK99114

Rear Output Shaft

1993-1991	(Aisin AX4)(4WD)	
	Seal	710319[2]
	Ball Bearing	205BB[2]
1993-1990	(Aisin AX4)(4WD)	
	Seal	1209N[2]
	Ball Bearing	205BB[2]

5-SPEED MANUAL TRANSMISSION

Transmission Rebuild Kit

2001-1990	(Aisin AX5)	
	Kit	TRKFT160
2001-1990	(Aisin AX15)	
	Kit	TRKFT300

5-SPEED MANUAL TRANSMISSION

Front Input Shaft

2000-1990	(Aisin AX15)	
	Seal	223253[2]
	Repair Sleeve	KWK99128
2000-1990	(Aisin AX5)	
	Seal	1981[2]
	Repair Sleeve	KWK99114
1990	(Peugeot BA10/5)	
	Seal Viton	710164[2]
	Repair Sleeve	KWK99128

Rear Countershaft

2000-1990	(Aisin AX15)	
	Cylindrical Bearing (Frt)	MSN5305GTBV[2] ²⁵
2000-1990	(Aisin AX5)	
	Ball Bearing (Rr)	204[2]

Rear Output Shaft

2001-1990	(Aisin AX15)	
	Seal (2WD)	223840
	Seal (4WD)	1209N
2001-1990	(Aisin AX5)	
	Seal (2WD)	223840
	Seal (4WD)	1209N
	Ball Bearing	205BB

ALTERNATOR

1993-1991	78 Amp.	
	Ball Bearing (Rear End)	203FF
1993-1990	(Delco Remy 42, 56, 63, 66, 78 Amp.)(Type II)	
	Ball Bearing (Drive End)	203S
1990	(Delco Remy 42, 56, 63, 66, 78 Amp.)(Type II)	
	Ball Bearing (Drive End)	203F
1990	(Delco Remy 37, 42, 55, 63, 78 Amp.)	
	Ball Bearing (Rear End)	MNJ471S

CRANKSHAFT FRONT SEAL

4 Cylinder

2000-1990	150/2.5L	
	Seal	321460
	Repair Sleeve	KWK99179

6 Cylinder

2008-2005	226/3.7L	
	Seal	710472
2004-1990	258/4.2L, 242/4.0L	
	Seal	321460
	Repair Sleeve	KWK99179

8 Cylinder

2001-1999	287/4.7L	
	Seal	3103
1998-1993	318/5.2L, 360/5.9L	
	Seal Viton	713103
	Repair Sleeve	KWK99218

²⁵New Item, Check For Availability

Mfg./Year Model & Location Part No. Mfg./Year Model & Location Part No.

JEEP - SUV - SPORT UTILITY VEHICLES - Cherokee, Commander, Grand Cherokee (cont.)

CRANKSHAFT REAR SEAL

4 Cylinder

2000-1990 150/2.5L
Seal3698
Repair SleeveKWK99294

6 Cylinder

2009-2005 226/3.7L
Seal231004
2004-1990 258/4.2L, 242/4.0L
Seal5111S

8 Cylinder

2006-2002 285/4.7L
Seal231004
2001-1999 287/4.7L
Seal231004
1998 360/5.9L
Seal Split5106
1998-1993 318/5.2L
Seal5414

CRANKSHAFT REAR SEAL (cont.)

8 Cylinder (cont.)

1991-1990 304/5.0L, 360/5.9L, 401/6.6L
Seal472341
Repair SleeveKWK99200

JEEP - LIGHT TRUCK - Sahara, TJ, Wrangler

FRONT WHEEL

RWD

2008-2007 Wrangler, Sahara
Hub Unit BearingHA590242[2]²⁵

4WD

2008-2007 Wrangler, Sahara
Hub Unit BearingHA590242[2]²⁵
2006-2000 Wrangler, Sahara, TJ
Hub Unit BearingHA597449[2]
1999-1990 Wrangler, TJ
Hub Unit Bearing513084[2]
Seal710068[2]

REAR WHEEL

RWD

2008-1994 (Dana/Spicer 44)(Flg. Axle Shaft)
Seal (Inner)9912S[2]
Set (Inner)SET10[2]
2006-1990 (Dana/Spicer 35 Axle)
Seal8660S[2]
Cylindrical Bearing5707[2]

4WD

2008-1994 (Dana/Spicer 44)(Flg. Axle Shaft)
Seal (Inner)9912S[2]
Set (Inner)SET10[2]
2006-1990 (Dana/Spicer 35 Axle)
Seal8660S[2]
Cylindrical Bearing5707[2]

4WD FRONT AXLE

Axle Shaft

2002-1994 (Spicer 30 F)
Seal710068[2]
1993-1990 (Spicer 30 F)(Disconnect)
Seal (LH)710068
Ndle Bearing (LH)BH208[2]
Seal (RH)710202
1993-1990 (Spicer 30 F)(w/o Disconnect)
Seal710068[2]

Differential Rebuild Kit

2007-1997 (Dana/Spicer 30 Axle)
KitDRK334TJ
1995-1990 (Dana/Spicer 30 Axle)
KitDRK334

Differential

2005-2003 (Exc. Trulock Diff.)
Cone/CupLM501349-LM501314[2]
2005-2003 (Trulock Diff.)
Cone/Cup25590-25523[2]
2002-1990 (Dana/Spicer 30 Axle)
Cone/CupLM501349-LM501314[2]

²⁵New Item, Check For Availability

JEEP - LIGHT TRUCK - Sahara, TJ, Wrangler (cont.)

4WD FRONT AXLE

Pinion

2005-2003 (Exc. Trulock Diff.)	
Seal Viton	5778V
Cone/Cup (Inner)	HM88649-HM88610
Cone/Cup (Outer)	M86649-M86610
Repair Sleeve	KWK99155
2005-2003 (Trulock Diff.)	
Cone/Cup (Outer)	02872-02820
2002-1997 (Dana/Spicer 30 Axle)	
Seal Viton	5778V
Cone/Cup (Inner)	HM88649-HM88610
Cone/Cup (Outer)	M86649-M86610
Repair Sleeve	KWK99155
1996-1990 (Dana/Spicer 30 Axle)	
Seal	5778
Seal Viton (Opt)	5778V
Cone/Cup (Inner)	HM88649-HM88610
Cone/Cup (Outer)	02872-02820
Repair Sleeve	KWK99155

Spindle Kit

2002-1990 (Spicer 30 F)	
Bearing & Seal Kit	SBK1[2] ³³

Spindle

2002-1990 (Dana/Spicer 30 Axle)	
Seal (Inner)	722108[2]
Ndle Bearing (Inner)	B2110[2]
Seal (Outer)	722109[2]

Intermediate Shaft

1993-1990 (Spicer 30 F)(Disconnect)	
Ndle Bearing	SCE108

REAR AXLE

Differential Rebuild Kit

2004-1992 (Dana/Spicer 35 Axle)	
Kit	DRK335C
2004-1990 (Dana/Spicer 44-1HD Axle,44M)	
Kit	DRK339B
1991-1990 (Dana/Spicer 35 Axle)	
Kit	DRK335J ¹⁶

Differential

2005-1990 (Dana/Spicer 35C Axle)	
Cone/Cup	LM501349-LM501314[2]
2005-1990 (Dana/Spicer 44-1HD Axle,44M)	
Cone/Cup	25590-25523[2]

REAR AXLE

Pinion

2008-1992 (Dana/Spicer 35C Axle)	
Seal Viton	714675
Cone/Cup (Inner)	HM88648-HM88610
Cone/Cup (Outer)	M86649-M86610
2004-2003 (Dana/Spicer 44-1HD Axle)	
Seal Viton	5778V
Cone/Cup (Inner)	31593-31520
Cone/Cup (Outer)	02872-02820
Repair Sleeve	KWK99155
2002-1990 (Dana/Spicer 44-1HD Axle)	
Seal Viton	5778V
Cone/Cup (Inner)	31594-31520
Cone/Cup (Outer)	02872-02820
Repair Sleeve	KWK99155
1991-1990 (Dana/Spicer 35C Axle)	
Seal	470331N
Cone/Cup (Inner)	HM88648-HM88610
Cone/Cup (Outer)	M86649-M86610

TRANSFER CASE REBUILD KIT

1995-1990 (New Process 231)	
Kit	TCRK231 ⁵¹

TRANSFER CASE

Input Shaft

2008-1997 (New Process 231, 241)	
Seal (O.E.)	3173
Seal (Opt)	710928
Repair Sleeve	KWK99193
Ball Bearing	110L
Ndle Bearing (Pilot)	FC66561[2]
1995-1990 (New Process 231)	
Seal	3173
Seal (Opt)	710928
Repair Sleeve	KWK99193
Ball Bearing	N5210KLB
Ndle Bearing (Pilot)	SCH1810

Front Output Shaft

2009-1990 (New Process 231)	
Seal	710046
Ball Bearing	206WB
Repair Sleeve	KWK99155
Ndle Bearing (Pilot)	J2416

Rear Output Shaft

2005-1997 (New Process 231)	
Seal	4370N
Ball Bearing	206WB
Repair Sleeve	KWK99149
Ndle Bearing (Pilot)	B5020

Oil Pump Housing

2005-1990 (New Process 207, 229, 231)	
Seal	341022
Repair Sleeve	KWK99225

¹⁶Obsolete

³³Opt. Kit = Brg B2110, Seals 722108 & 722109.

⁵¹BD50-8 I/S Brg.

JEEP - LIGHT TRUCK - Sahara, TJ, Wrangler (cont.)**3-SPEED AUTOMATIC TRANSMISSION****Torque Converter**

2002-1990	(A904, A999, 30RH, 31RH, 32RH)	
Seal	331228H[2]
Repair Sleeve	KWK99149

Rear Seal/Ext. Housing

2001-1994	(31RH, 32RH)	
Seal	710058[2]
Ball Bearing	206LOE[2] ³⁸
1993-1990	(A904, A999, 30RH)	
Seal	2506[2]
Ball Bearing	206LOE[2] ³⁸

Selector Shaft Seal/Man. Shaft

2002-1990	(A904, A999, 30RH, 31RH, 32RH)	
Seal	8609[2]

CLUTCH - 4 CYLINDER**Pilot Bearing**

2002-1990	150/2.5L	
Ndle Bearing	FC65446

CLUTCH - 6 CYLINDER**Pilot Bearing**

2004-2003		
Ndle Bearing	FC69907
2002-1992	242/4.0L	
Ndle Bearing	SCE1295
Ndle Bearing	FC69907
1991-1990	242/4.0L, 258/4.2L	
Ndle Bearing	FC66426

CLUTCH - 4 CYLINDER**Release Bearing**

2005-2003	148/2.4L (DOHC)	
Bearing Assy	614093
2002-1997	150/2.5L	
Bearing Assy	614093
1995-1994	150/2.5L	
Bearing Assy	614093
1993	150/2.5L	
Hyd. Bearing Assy	619004
1992-1991	150/2.5L	
Hyd. Bearing Assy	619001
1990	150/2.5L	
Hyd. Bearing Assy	619007

CLUTCH - 6 CYLINDER**Release Bearing**

2002-1997	242/4.0L	
Bearing Assy	614093
1995-1994	242/4.0L	
Bearing Assy	614093
1993	242/4.0L	
Hyd. Bearing Assy	619004

CLUTCH - 6 CYLINDER (cont.)**Release Bearing (cont.)**

1992-1991	242/4.0L	
Hyd. Bearing Assy	619003
1990	242/4.0L, 258/4.2L	
Hyd. Bearing Assy	619008

5-SPEED MANUAL TRANSMISSION**Transmission Rebuild Kit**

2002-1990	(Aisin AX5)	
Kit	TRKFT160

Front Input Shaft

2002-1990	(Aisin AX5)	
Seal	1981[2]
Repair Sleeve	KWK99114
1997-1990	(Aisin AX15)	
Seal	223253[2]
Repair Sleeve	KWK99128
1990	(Peugeot BA10/5)	
Seal Viton	710164[2]
Repair Sleeve	KWK99128

Rear Countershaft

2002-1990	(Aisin AX5)	
Ball Bearing (Rr)	204[2]
2001-1990	(Aisin AX15)	
Cylindrical Bearing (Frt)	MSN5305GTBV[2] ²⁵

Rear Output Shaft

2002-1990	(Aisin AX5)	
Seal (2WD)	223840
Seal (4WD)	1209N
Ball Bearing	205BB
2001-1990	(Aisin AX15)	
Seal (2WD)	223840
Seal (4WD)	1209N

ALTERNATOR

1990	(Leece Neville 35, 40, 55 Amp.)	
Ball Bearing (Rear End)	MNJ471S
1990	(Delco Remy 42, 56, 63, 66, 78 Amp.)(Type II)	
Ball Bearing (Drive End)	203F

CRANKSHAFT FRONT SEAL**4 Cylinder**

2006-2003	148/2.4L	
Seal Viton	320348
2002-1990	150/2.5L	
Seal	321460
Repair Sleeve	KWK99179

6 Cylinder

2008-2007	231/3.8L	
Seal	3638
Repair Sleeve	KWK99112
2006-1991	242/4.0L	
Seal	321460
Repair Sleeve	KWK99179

²⁵New Item, Check For Availability³⁸Reuse Snap Ring.

Mfg./Year Model & Location Part No. Mfg./Year Model & Location Part No.

JEEP - LIGHT TRUCK - Sahara, TJ, Wrangler (cont.)

CRANKSHAFT FRONT SEAL (cont.)

6 Cylinder (cont.)

1990 258/4.2L
 Seal 321460
 Repair Sleeve KWK99179

CRANKSHAFT REAR SEAL

4 Cylinder

2006-2003 148/2.4L
 Seal Viton 710056
 2002-1997 150/2.5L
 Seal 3698
 Repair Sleeve KWK99294
 1995-1990 150/2.5L
 Seal 3698
 Repair Sleeve KWK99294

6 Cylinder

2009-2007 3.8L
 Seal Viton 710056
 2006-1991 242/4.0L
 Seal 5111S

CRANKSHAFT REAR SEAL (cont.)

6 Cylinder (cont.)

1995-1990 258/4.2L
 Seal 5111S

JEEP - FULL-SIZE WAGONEER, Grand Wagoneer, Wagoneer, Wagoneer Limited

FRONT WHEEL

4WD

1991-1990
 Seal (Inner) 471271[2]
 Cone/Cup (Inner) LM104949-JLM104910[2]
 Set (Outer) SET45[2]

REAR WHEEL

RWD

1993-1990 (Dana/Spicer 35 Axle)
 Seal 8660S[2]
 Cylindrical Bearing 5707[2]
 1993-1990 (Dana/Spicer 44 Axle)
 Seal (Inner) 481837[2]
 Set (Inner) SET10[2]
 Seal (Outer) 9912S[2]

4WD

1993-1990 (Dana/Spicer 35 Axle)
 Seal 8660S[2]
 Cylindrical Bearing 5707[2]
 1993-1990 (Dana/Spicer 44 Axle)
 Seal (Inner) 481837[2]
 Set (Inner) SET10[2]
 Seal (Outer) 9912S[2]

4WD FRONT AXLE

Differential Rebuild Kit

1991-1990 (Dana/Spicer 30 Axle)
 Kit DRK334
 1991-1990 (Dana/Spicer 44 Axle)
 Kit DRK339B

Differential

1991-1990 (Dana/Spicer 30 Axle)
 Cone/Cup LM501349-LM501314[2]
 1991-1990 (Dana/Spicer 44 Axle)
 Cone/Cup 25590-25523[2]

Pinion

1991-1990 (Dana/Spicer 30 Axle)
 Seal 5778
 Cone/Cup (Inner) HM88649-HM88610
 Cone/Cup (Outer) 02872-02820
 1991-1990 (Dana/Spicer 44 Axle)
 Seal 5778
 Cone/Cup (Inner) 31594-31520
 Cone/Cup (Outer) 02872-02820

Spindle Kit

1991-1990
 Bearing & Seal Kit SBK1[2]³³

Spindle

1991-1990
 Seal (Inner) 722108[2]
 Ndle Bearing (Inner) B2110[2]
 Seal (Outer) 722109[2]

REAR AXLE

Differential

1991-1990 (Dana/Spicer 44 Axle)
 Cone/Cup 25590-25523[2]

³³Opt. Kit = Brg B2110, Seals 722108 & 722109.

Mfg./Year Model & Location Part No. Mfg./Year Model & Location Part No.

**JEEP - FULL-SIZE WAGONEER, Grand Wagoneer, Wagoneer, Wagoneer Limited
(cont.)****REAR AXLE****Pinion**

1991-1990 (Dana/Spicer 44 Axle)	
Cone/Cup (Inner)	31594-31520
Cone/Cup (Outer)	02872-02820

TRANSFER CASE**Input Shaft**

1994-1990	
Seal	3173
Seal (Opt)	710928
Repair Sleeve	KWK99193
Ball Bearing (N.P. 231, 242, 249)(1st Design)	N5210KLB
Ndle Bearing (N.P. 208, 219, 228, 229)	B5020
Ndle Bearing (N.P. 207)	B3210
Ndle Bearing (Pilot (N.P. 208, 219, 228, 229)	B2012
Ndle Bearing (Pilot (N.P. 231)	SCH1810
Ndle Bearing Thrust (N.P. 228, 229)	NTA3244
Ndle Bearing Thrust (N.P. 208, 219)	AXK5070

Front Output Shaft

1991-1990 (New Process 242)	
Seal	3946
Ball Bearing	207
Repair Sleeve	KWK99187
Ndle Bearing (Pilot)	J2416
1991-1990 (New Process 208, 219, 228, 229)	
Seal	3946
Ndle Bearing	B2816
Repair Sleeve	KWK99187
Ndle Bearing (Pilot)	J2416
Ndle Bearing Thrust	NTA2840

Rear Output Shaft

1991-1990 (New Process 231)	
Seal	2506
Ball Bearing	206WB
Repair Sleeve	KWK99149
Ndle Bearing (Pilot)	B5020
1991-1990 (New Process 228, 229)	
Seal	3946
Ball Bearing	207
Repair Sleeve	KWK99187
Ndle Bearing (Pilot)	B3612
Ndle Bearing Thrust	TC2435

3-SPEED AUTOMATIC TRANSMISSION**Torque Converter**

1991-1990 (A727)	
Seal	331227H[2]
Repair Sleeve	KWK99187

Rear Seal/Ext. Housing

1991-1990 (A727)	
Seal	7300S[2]
Ball Bearing	207XLO[2]
Seal Kit	5206 ⁶⁴

Selector Shaft Seal/Man. Shaft

1991-1990 (A904, A999, 30RH, 31RH, 32RH)	
Seal	8609[2]

4-SPEED AUTOMATIC TRANSMISSION**Torque Converter**

1993 (A518, 46RH)	
Seal	331227H[2]
Repair Sleeve	KWK99187
1991-1990 (Aisin 03 40)	
Seal	223830[2]
Repair Sleeve	KWK99147

Rear Seal/Ext. Housing

1991-1990 (Aisin 30-40FL)	
Seal	225005[2]
1991-1990 (Aisin 30-40LE)	
Seal	710319[2]

Selector Shaft Seal/Man. Shaft

1991-1990 (Aisin 03 40)	
Seal	221207[2]
Repair Sleeve	KWK99049

CLUTCH**Release Bearing**

1990 (8 Cyl.)	
Bearing Assy	614115

4-SPEED MANUAL TRANSMISSION**Input Shaft**

1991-1990 (Aisin AX4)	
Seal	1981[2]
Repair Sleeve	KWK99114

Rear Output Shaft

1991 (Aisin AX4)(4WD)	
Seal	710319[2]
Ball Bearing	205BB[2]
1991-1990 (Aisin AX4)(4WD)	
Seal	1209N[2]
Ball Bearing	205BB[2]

⁶⁴Seal & Bushing Kit

Mfg./Year Model & Location Part No. Mfg./Year Model & Location Part No.

JEEP - FULL-SIZE WAGONEER, Grand Wagoneer, Wagoneer, Wagoneer Limited (cont.)

5-SPEED MANUAL TRANSMISSION

Front Input Shaft

- 1991-1990 (Aisin AX15)
Seal 223253[2]
Repair Sleeve KWK99128
- 1991-1990 (Aisin AX5)
Seal 1981[2]
Repair Sleeve KWK99114
- 1990 (Peugeot BA10/5)
Seal Viton 710164[2]
Repair Sleeve KWK99128

Rear Countershaft

- 1991-1990 (Aisin AX15)
Cylindrical Bearing (Frt) MSN5305GTBV[2]²⁵
- 1991-1990 (Aisin AX5)
Ball Bearing (Rr) 204[2]

Rear Output Shaft

- 1991-1990 (Aisin AX15)
Seal (2WD) 223840
Seal (4WD) 1209N
- 1991-1990 (Aisin AX5)
Seal (2WD) 223840
Seal (4WD) 1209N
Ball Bearing 205BB

ALTERNATOR

- 1993-1991 78 Amp.
Ball Bearing (Rear End) 203FF
- 1991-1990 (Delco Remy 37, 42, 55, 63, 78 Amp.)(Type I)
Ball Bearing (Drive End) 203S
- 1990 (Delco Remy 42, 56, 63, 66, 78 Amp.)(Type II)
Ball Bearing (Drive End) 203F
- 1990 (Delco Remy 37, 42, 55, 63, 78 Amp.)
Ball Bearing (Rear End) MNJ471S

CRANKSHAFT FRONT SEAL

4 Cylinder

- 1991-1990 150/2.5L
Seal 321460
Repair Sleeve KWK99179
Harmnc Balancer Slvs 88179

6 Cylinder

- 1991-1990 232/3.8L, 242/4.0L, 258/4.2L
Seal 321460
Repair Sleeve KWK99179

8 Cylinder

- 1991-1990 304/5.0L, 360/5.9L, 401/6.6L
Seal 472341
Repair Sleeve KWK99200

CRANKSHAFT REAR SEAL

4 Cylinder

- 1991-1990 150/2.5L
Seal 3698
Repair Sleeve KWK99294

6 Cylinder

- 1991-1990 232/3.8L, 242/4.0L, 258/4.2L
Seal 5115

8 Cylinder

- 1991-1990 304/5.0L, 360/5.9L, 401/6.6L
Seal 5112S⁰³

⁰³Optional ²⁵New Item, Check For Availability

Mfg./Year Model & Location Part No. Mfg./Year Model & Location Part No.

JEEP - TRUCK - Comanche**FRONT WHEEL****RWD**

1992-1990 Comanche
Hub Unit Bearing 513084[2]

4WD

1992-1990 Comanche, Pickup (Dana/Spicer
30 Axle)
Hub Unit Bearing 513084[2]
1992-1990 (Dana/Spicer 44-1F Axle)
Seal (Inner) 471271[2]
Cone/Cup (Inner) LM104949-JLM104910[2]
Set (Outer) SET45[2]

REAR WHEEL**RWD**

1992-1990 Comanche (Dana/Spicer 35
Axle)
Seal 46485[2]
Cylindrical Bearing 5707[2]
1992-1990 (Dana/Spicer 60 Axle)(Tapered
Axle Shaft)
Seal (Inner) 455860[2]
Cone/Cup (Inner) 28678-28622[2]
Cone/Cup (Outer) 18690-18620[2]
1992-1990 (Dana/Spicer 44)(Flg. Axle
Shaft)
Seal 2689S[2]
Set SET10[2]

4WD FRONT AXLE**Axle Shaft**

1992-1990 (Spicer 30 F)(Disconnect)
Seal (LH) 710068
Ndl Bearing (LH) BH208[2]
Seal (RH) 710204
1992-1990 (Spicer 30 F)(w/o Disconnect)
Seal 710068[2]
1992-1990 (Spicer 44 1F)(2.250" O.D.)
Seal 5131[2]

Differential Rebuild Kit

1992-1990 (Dana/Spicer 30 Axle)
Kit DRK334
1992-1990 (Dana/Spicer 44 Axle)
Kit DRK339B

Differential

1992-1990 (Dana/Spicer 30 Axle)
Cone/Cup LM501349-LM501314[2]
1992-1990 (Dana/Spicer 44 Axle)
Cone/Cup 25590-25523[2]

4WD FRONT AXLE**Pinion**

1992-1990 (Dana/Spicer 27, 30 Axles)
Seal 5778
Cone/Cup (Inner) HM88649-HM88610
Cone/Cup (Outer) 02872-02820
1992-1990 (Dana/Spicer 44 Axle)
Seal 5778
Cone/Cup (Inner) 31594-31520
Cone/Cup (Outer) 02872-02820

Spindle Kit

1992-1990
Bearing & Seal Kit SBK1[2]³³

Spindle

1992-1990
Seal (Inner) 722108[2]
Ndl Bearing (Inner) B2110[2]
Seal (Outer) 722109[2]

Intermediate Shaft

1992-1990 (Spicer 30 F)(Disconnect)
Ndl Bearing SCE108

REAR AXLE**Differential Rebuild Kit**

1992-1991 (Chrysler Axle)(8.25" R.G.)
Kit DRK303
1992-1990 (Dana/Spicer 44 Axle)
Kit DRK339B
1991-1990 (Dana/Spicer 35 Axle)
Kit DRK335J¹⁶

Differential

1992-1991 (Chrysler Axle)(8.25" R.G.)
Set SET36[2]
1992-1990 (Dana/Spicer 35 Axle)
Cone/Cup LM501349-LM501314[2]
1992-1990 (Dana/Spicer 44 Axle)
Cone/Cup 25590-25523[2]

Pinion

1992 (Dana/Spicer 35 Axle)
Seal Viton 714675
Cone/Cup (Inner) HM88648-HM88610
Cone/Cup (Outer) M86649-M86610
1992-1991 (Chrysler Axle)(8.25" R.G.)
Seal 8516N
Cone/Cup (Inner) M802048-M802011
Cone/Cup (Outer) M86649-M86610
1992-1990 (Dana/Spicer 44 Axle)
Seal 5778
Cone/Cup (Inner) 31594-31520
Cone/Cup (Outer) 02872-02820
1991-1990 (Dana/Spicer 35 Axle)
Seal 470331N
Cone/Cup (Inner) HM88648-HM88610
Cone/Cup (Outer) M86649-M86610

¹⁶Obsolete³³Opt. Kit = Brg B2110, Seals 722108 & 722109.

JEEP - TRUCK - Comanche (cont.)

TRANSFER CASE REBUILD KIT

1992-1990	(New Process 231)	
Kit	TCRK231 ⁵¹	
1992-1990	(New Process 242)(Exc. cases 52098383/4/5)	
Kit	TCRK242	
1991-1990	(New Process 228, 229)	
Kit	TCRK229	

TRANSFER CASE

Input Shaft

1992-1990		
Seal (N.P. 231, 242, 249)	3173	
Ball Bearing (N.P. 231, 242, 249)	N5210KLB	
Seal (Opt)	710928	
Repair Sleeve (N.P. 231, 242, 249)	KWK99193	
Ndle Bearing (Pilot) (N.P. 231)	SCH1810	
Ndle Bearing (Pilot) (N.P. 242, 249)	FC66561	
1991-1990		
Seal (N.P. 208, 219, 228, 229)	3173	
Ndle Bearing (N.P. 208, 219, 228, 229)	B5020	
Seal (Opt)	710928	
Repair Sleeve (N.P. 208, 219, 228, 229)	KWK99193	
Ndle Bearing (Pilot) (N.P. 208, 219, 228, 229)	B2012	
Ndle Bearing Thrust (N.P. 228, 229)	NTA3244	
Ndle Bearing Thrust (N.P. 208, 219)	AXK5070	

Front Output Shaft

1992-1990	(New Process 231)	
Seal	710046	
Ball Bearing	206WB	
Repair Sleeve	KWK99155	
Ndle Bearing (Pilot)	J2416	
1992-1990	(New Process 242)	
Seal	3946	
Ball Bearing	207	
Repair Sleeve	KWK99187	
Ndle Bearing (Pilot)	J2416	
1991-1990	(New Process 208, 219, 228, 229)	
Seal	3946	
Ndle Bearing	B2816	
Repair Sleeve	KWK99187	
Ndle Bearing (Pilot)	J2416	
Ndle Bearing Thrust	NTA2840	

TRANSFER CASE

Rear Output Shaft

1992-1990	(New Process 231)	
Seal	2506	
Ball Bearing	206WB	
Repair Sleeve	KWK99149	
Ndle Bearing (Pilot)	B5020	
1991-1990	(New Process 228, 229)	
Seal	3946	
Ball Bearing	207	
Repair Sleeve	KWK99187	
Ndle Bearing (Pilot)	B3612	
Ndle Bearing Thrust	TC2435	

3-SPEED AUTOMATIC TRANSMISSION

Torque Converter

1992-1990	(A727)	
Seal	331227H[2]	
Repair Sleeve	KWK99187	

Rear Seal/Ext. Housing

1992-1990	(A727)	
Seal	7300S[2]	
Ball Bearing	207XLO[2]	
Seal Kit	5206 ⁶⁴	

Selector Shaft Seal/Man. Shaft

1992-1990	(A904, A999, 30RH, 31RH, 32RH)	
Seal	8609[2]	

4-SPEED AUTOMATIC TRANSMISSION

Torque Converter

1992-1990	(Aisin 03 40)	
Seal	223830[2]	
Repair Sleeve	KWK99147	

Rear Seal/Ext. Housing

1992-1990	(Aisin 30-40FL)	
Seal	225005[2]	
1992-1990	(Aisin 30-40LE)	
Seal	710319[2]	

Selector Shaft Seal/Man. Shaft

1992-1990	(Aisin 03 40)	
Seal	221207[2]	
Repair Sleeve	KWK99049	

CLUTCH

Pilot Bearing

1992-1990	4 Cyl. 150 (2.5)(AMC)	
Ndle Bearing	FC65446	
1991-1990	6 Cyl. 242 (4.0)	
Ndle Bearing	FC66426	
1991-1990	6 Cyl. 258 (4.2)	
Ndle Bearing	FC66426	

⁵¹BD50-8 I/S Brg.

⁶⁴Seal & Bushing Kit

Mfg./Year	Model & Location	Part No.	Mfg./Year	Model & Location	Part No.
-----------	------------------	----------	-----------	------------------	----------

JEEP - TRUCK - Comanche (cont.)**CLUTCH****Release Bearing**

1992-1991	4 Cyl. 150 (2.5)(Hyd. piston type)	
	Hyd. Bearing Assy	619001
1992-1991	6 Cyl. 242 (4.0)(Hyd. piston type)	
	Hyd. Bearing Assy	619003
1990	6 Cyl. 242 (4.0)(Hyd. piston type)	
	Hyd. Bearing Assy	619008
1990	4 Cyl. 150 (2.5)(Hyd. piston type)	
	Hyd. Bearing Assy	619007

4-SPEED MANUAL TRANSMISSION**Input Shaft**

1992-1990	(Aisin AX4)	
	Seal	1981[2]
	Repair Sleeve	KWK99114

Rear Output Shaft

1992-1991	(Aisin AX4)(4WD)	
	Seal	710319[2]
	Ball Bearing	205BB[2]
1992-1990	(Aisin AX4)(4WD)	
	Seal	1209N[2]
	Ball Bearing	205BB[2]

5-SPEED MANUAL TRANSMISSION**Front Input Shaft**

1992-1990	(Aisin AX15)	
	Seal	223253[2]
	Repair Sleeve	KWK99128
1992-1990	(Aisin AX5)	
	Seal	1981[2]
	Repair Sleeve	KWK99114
1990	(Peugeot BA10/5)	
	Seal Viton	710164[2]
	Repair Sleeve	KWK99128

Rear Countershaft

1992-1990	(Aisin AX15)	
	Cylindrical Bearing (Frt)	MSN5305GTBV[2] ²⁵
1992-1990	(Aisin AX5)	
	Ball Bearing (Rr)	204[2]

Rear Output Shaft

1992-1990	(Aisin AX15)	
	Seal (2WD)	223840
	Seal (4WD)	1209N
1992-1990	(Aisin AX5)	
	Seal (2WD)	223840
	Seal (4WD)	1209N
	Ball Bearing	205BB

CRANKSHAFT FRONT SEAL**4 Cylinder**

1992-1990	150/2.5L	
	Seal	321460
	Repair Sleeve	KWK99179

6 Cylinder

1992-1990	258/4.2L, 242/4.0L	
	Seal	321460
	Repair Sleeve	KWK99179

8 Cylinder

1992-1990	304/5.0L, 360/5.9L, 401/6.6L	
	Seal	472341
	Repair Sleeve	KWK99200

CRANKSHAFT REAR SEAL**4 Cylinder**

1992-1990	150/2.5L	
	Seal	3698
	Repair Sleeve	KWK99294

6 Cylinder

1992-1990	232/3.8L, 242/4.0L, 258/4.2L	
	Seal	5115

8 Cylinder

1992-1990	304/5.0L, 360/5.9L, 401/6.6L	
	Seal	5112S ⁰³

⁰³Optional²⁵New Item, Check For Availability

Mfg./Year Model & Location Part No. Mfg./Year Model & Location Part No.

KIA - Amanti, Magentis, Optima, Rio, Rondo, Sedona, Sephia, Spectra

FRONT WHEEL

FWD

2009-2007 Rondo	
Bearing Assy	WB000015[2] ²⁵
2009-2006 Rio	
Ball Bearing	510055[2]
2009-2006 Sedona	
Hub Unit Bearing	HA590206[2] ²⁵
2009-2004 Amanti	
Ball Bearing	510084[2]
2008-2004 Spectra New Style	
Ball Bearing	510078[2]
2008-2003 Optima (From 1/3/02)	
Ball Bearing	510034[2]
2005-2002 Sedona	
Set	SET49[2]
2005-2001 Rio	
Seal (Inner)	4990[2]
Set (Inner)	SET11[2]
Seal (Outer)	710323[2]
Set (Outer)	SET11[2]
2004-2001 Spectra (Hatchback)	
Ball Bearing	510003[2]
2004-2001 Spectra (Sedan)	
Ball Bearing	510010[2]
2002-2001 Optima (To 1/2/02)	
Ball Bearing	510076[2]
2001-1994 Sephia	
Seal	1932S[2]
Ball Bearing	510003[2]
2000 Spectra	
Ball Bearing	510010[2]

REAR WHEEL

FWD

2009-2008 Rondo	
Hub Unit Bearing	HA590052[2]
2009-2007 Amanti	
Hub Unit Bearing	HA590179[2] ²⁵
2009-2006 Rio	
Hub Unit Bearing	HA590184[2] ²⁵
2009-2006 Sedona	
Hub Unit Bearing	HA590016[2] ²⁵
2008-2006 Optima New Style	
Hub Unit Bearing	
(ABS)	512265[2] ²⁵
Hub Unit Bearing	
(Non-ABS)	512266[2] ²⁵
2008-2004 Spectra New Style	
Hub Unit Bearing	
(ABS)	HA590194[2] ²⁵
Hub Unit Bearing	
(Non-ABS)	HA590188[2] ²⁵
2007 Rondo	
Hub Unit Bearing	HA590179[2] ²⁵
2006-2004 Amanti	
Hub Unit Bearing	HA590010[2] ²⁵
2006-2001 Optima Old Style	
Hub Unit Bearing	
(ABS)	512190[2]
Hub Unit Bearing	
(Non-ABS)	512191[2]

REAR WHEEL (cont.)

FWD (cont.)

2005-2003 Sedona (ABS)(From 12/2/03)	
Hub Unit Bearing	HA590013[2] ²⁵
Cone/Cup (Outer)	
Optional	14585-14525[2]
Cone/Cup (Inner)	
Optional	15578-15520[2]
2005-2002 Sedona (Non-ABS)	
Hub Unit Bearing	HA590011[2] ²⁵
Cone/Cup (Outer)	
Optional	14585-14525[2]
Cone/Cup (Inner)	
Optional	15578-15520[2]
2005-2001 Rio	
Seal (Inner)	1126S
Set (Inner)	SET2[2]
Set (Outer)	SET4[2]
2004-2000 Spectra (Drum)	
Hub Unit Bearing	512200[2]
2003-2002 Sedona (ABS)(Thru 12/1/03)	
Hub Unit Bearing	HA590012[2] ²⁵
Cone/Cup (Outer)	
Optional	14585-14525[2]
Cone/Cup (Inner)	
Optional	15578-15520[2]
2001-2000 Sephia (Disc)	
Hub Unit Bearing	512251[2] ²⁵
2001-1994 Sephia (Drum)	
Hub Unit Bearing	512200[2]

4WD FRONT AXLE

Differential

2002-1995 Sportage	
Cone/Cup	XAA32008X-Y32008X[2]

Pinion

2007-2003 Sorento	
Bearing Assy (Inner)	32207M
Bearing Assy (Outer)	30307M
2002-1995 Sportage	
Bearing Assy (Inner)	32207M
Bearing Assy (Outer)	32206M

REAR AXLE

Differential

2007-2003 Sorento	
Bearing Assy	32210M[2]
2002-1995 Sportage	
Cone/Cup	XAA32008X-Y32008X[2]

Pinion

2007-2003 Sorento	
Bearing Assy (Inner)	32307
Bearing Assy (Outer)	30307M
2002-1995 Sportage	
Seal	1216N
Bearing Assy (Inner)	32207M
Bearing Assy (Outer)	32206M

²⁵New Item, Check For Availability

Mfg./Year Model & Location Part No. Mfg./Year Model & Location Part No.

KIA - Amanti, Magentis, Optima, Rio, Rondo, Sedona, Sephia, Spectra (cont.)**TRANSFER CASE REBUILD KIT**

2002-1995 Sportage
Kit TRKFK100

4-SPEED AUTOMATIC TRANSMISSION**Torque Converter**

2002-1995 (Aisin O3 72)
Seal 223830
Repair Sleeve KWK99147

Rear Seal/Ext. Housing

2004-2003 (Aisin O3 40)
Seal 3459S
2002-1995 (Aisin O3 72)
Seal 710319

5-SPEED AUTOMATIC TRANSMISSION**Torque Converter**

2006-2004 (F5A51)
Seal 320583
Repair Sleeve KWK99157
2005-2002 Sedona
Bearing Assy 32009XM[2]

CLUTCH**Pilot Bearing**

2002-1994
Ball Bearing 202SS

Release Bearing

2002-1995 Sportage
Bearing Assy 614067
1999-1994 Sephia
Bearing Assy 614128

5-SPEED MANUAL TRANSMISSION**Transmission Rebuild Kit**

2002-1995 Sportage (4WD)
Kit TRKFK110

Front Input Shaft

2002-1995 (Getrag R15MXD)
Seal 1970
Repair Sleeve KWK99147

Rear Output Shaft

2002-1995 (Getrag R15MXD)
Seal 710435

Selector Shaft Seal/Man. Shaft

2006-2004 (M5BF2)
Seal 710222
1997-1995 (Mazda G25R-M)
Seal 221620

4-SPEED AUTOMATIC TRANSAXLE**Differential**

2005-2004 Spectra
Bearing Assy 30207M[2]
2005-2001 Rio
Set SET17[2]
2004-2001 Optima
Set SET45[2]
2003-2000 Spectra
Set SET17[2]
2002-1994 (Jatco F4A EL)
Set SET17[2]
2001-1994 Sephia
Set SET17[2]

Torque Converter / Frt Pump

2007-2004 Amanti, Spectra
Seal 320583
Repair Sleeve KWK99182
2007-2001 Optima
Seal 320583
Repair Sleeve KWK99182
2005-1994 (Jatco F4A EL)
Seal 710446
2001-1994 Sephia
Seal 710446
Repair Sleeve KWK99266

Output Shaft

2008-2006 (A4AF3)
Seal Viton 710259[2]
2007-2001 (F4A42 1)
Bearing Assy (Frt) 32009XM
Bearing Assy (Rr) 32006
2005-1994 (Jatco F4A EL)
Seal (LH) 223543
Repair Sleeve (LH) KWK99139
Seal (RH) 2007N
Repair Sleeve (RH) KWK99139

5-SPEED MANUAL TRANSAXLE**Transaxle Rebuild Kit**

2001-1995 1.8L
Kit TRKFMZ150
1997-1994 1.6 L
Kit TRKFMZ130

Differential

2007-2006 (M5GF2)
Bearing Assy 32009XM[2]
2007-2001 Optima
Set SET45[2]
2006-2004 (M5BF2)
Bearing Assy 30207M[2]
2003-2000 Spectra
Bearing Assy 32008XM[2]
1997-1995 (Mazda G5M)
Cone/Cup XAA32008X-Y32008X[2]
1997-1994 (Mazda F52)
Set SET17[2]

Mfg./Year Model & Location Part No. Mfg./Year Model & Location Part No.

KIA - Amanti, Magentis, Optima, Rio, Rondo, Sedona, Sephia, Spectra (cont.)

5-SPEED MANUAL TRANSAXLE

Input Shaft

2007-2006 (Hyundai M5CF1)	
Seal Viton	712007
Repair Sleeve	KWK99098
2007-2001 (Mazda M5BF2, M5GF1)	
Seal Viton	712007
Repair Sleeve	KWK99098
2004-1998 (Mazda G15M-R)	
Seal	1990
Set	SET32
Repair Sleeve	KWK99106
1997-1995 (Mazda G5M)	
Bearing Assy (Inner)	513185[2]
Seal (Outer)	1990
Set (Outer)	SET32[2]
Repair Sleeve	KWK99106
1997-1994 (Mazda F52)	
Seal	1990
Repair Sleeve	KWK99106

Output Shaft

2006-2004 (M5BF2)	
Seal	223543
Seal	KWK99139
1997-1995 (Mazda G5M)	
Seal (LH)	223543
Repair Sleeve (LH)	KWK99139
Seal (RH)	2007N
Repair Sleeve (RH)	KWK99139
1997-1994 (Mazda F52)	
Seal (LH)	223543
Bearing Assy (LH)	32205[2]
Repair Sleeve (LH)	KWK99139
Seal (RH)	2007N
Repair Sleeve (RH)	KWK99139

Extension Housing

1997-1995 (Mazda G5M)	
Seal	221620

OIL PUMP

4 Cylinder

2008-2001 2400cc/2.4L	
Seal	222025
Repair Sleeve	KWK99078

CAMSHAFT SEAL

4 Cylinder

2007-2001 2351cc/ 2.4L	
Seal	3771
Repair Sleeve	KWK99139
2004-2000 1793cc/1.8L	
Seal	710355
2002-1996 1998cc/2.0L (DOHC)	
Seal	223420[2]
1997-1995 1597cc/1.6L (DOHC), 1839cc/1.8L (DOHC)	
Seal	223420[2]
1995 1998cc/2.0L	
Seal	223420

CAMSHAFT SEAL (cont.)

4 Cylinder (cont.)

1995-1993 1597cc/1.6L	
Seal	223012
Repair Sleeve	KWK99114

6 Cylinder

2007-2002 2656cc/2.7L, 3500cc/3.5L	
Seal (Frt)	223010[4]
Repair Sleeve	KWK99114
Seal (Rr)	710302[4]
Repair Sleeve	KWK99114

CRANKSHAFT FRONT SEAL

6 Cylinder

2008-2002 2.7L	
Seal	710355
2006-2002 3.5L (DOHC)	
Seal	710355

4 Cylinder

2008-2001 1493cc/1.5L, 1594cc/1.6L	
Seal	710355
2008-2001 2.4L	
Seal	224460
2007-2004 2.0L (DOHC)	
Seal	710531
2004-2000 1793cc/1.8L	
Seal	710355
2002-1995 1998/2.0L	
Seal	223420
1997-1994 1597cc/1.6L, 1597cc/1.6L (DOHC), 1839cc/1.8L (DOHC)	
Seal	710355
Repair Sleeve	KWK99145

CRANKSHAFT REAR SEAL

4 Cylinder

2008-2001 1493cc/1.5L (DOHC), 1594cc/1.6L (DOHC)	
Seal	228250
Repair Sleeve	KWK99328
2008-2001 2.4L	
Seal Viton	229005
2007-1994 1597cc/1.6L, 1597cc/1.6L (DOHC), 1839cc/1.8L (DOHC)	
Seal	228250
Repair Sleeve	KWK99328
2002-1995 1998/2.0L, 1998cc/2.0L (DOHC)	
Seal	229010
Repair Sleeve	KWK99354

6 Cylinder

2008-2001 2.5L, 2.7L, 3.5L	
Seal Viton	229005

Mfg./Year	Model & Location	Part No.	Mfg./Year	Model & Location	Part No.
-----------	------------------	----------	-----------	------------------	----------

KIA - SUV - Borrego**FRONT WHEEL****RWD**

2009

Hub Unit Bearing HA590329[2]²⁵**4WD**

2009

Hub Unit Bearing HA590327[2]²⁵**REAR WHEEL****RWD**

2009

Ball Bearing HA590328[2]²⁵**REAR WHEEL****4WD**

2009

Hub Unit Bearing HA590327[2]²⁵**KIA - SUV - Sorento****FRONT WHEEL****FWD**

2008-2003 Sorento

Bearing Assy WB000016[2]²⁵**4WD**

2008-2003 Sorento

Bearing Assy WB000016[2]²⁵**REAR WHEEL****FWD**

2008-2003 Sorento

Ball Bearing 516009[2]²⁵

Seal 223840[2]

4WD

2008-2003 Sorento

Ball Bearing 516009[2]²⁵

Seal 223840[2]

4WD FRONT AXLE**Axle Shaft**

2008-2003

Ball Bearing RW101[2]

4-SPEED AUTOMATIC TRANSMISSION**Selector Shaft Seal/Man. Shaft**

2004-2003

Seal 221207

Repair Sleeve KWK99049

CRANKSHAFT FRONT SEAL**6 Cylinder**

2006-2003 3498cc/3.5L (DOHC)

Seal 223750

CRANKSHAFT REAR SEAL**6 Cylinder**

2006-2003 3498cc/3.5L (DOHC)

Seal Viton 229005

Repair Sleeve KWK99354

²⁵New Item, Check For Availability

Mfg./Year Model & Location Part No. Mfg./Year Model & Location Part No.

KIA - SUV - Sportage

FRONT WHEEL

FWD

2009-2005 Sportage
Ball Bearing 510034[2]

RWD

2002-1995 Sportage
Seal (Inner) 710094[2]
Set (Inner) SET47[2]
Seal (Outer) 710093[2]
Set (Outer) SET11[2]

4WD

2009-2005 Sportage
Ball Bearing 510034[2]

REAR WHEEL

FWD

2009-2005 Sportage
Hub Unit Bearing 512267[2] ²⁵

RWD

2002-1998 Sportage
Seal (Inner) 473823[2]
Set (Inner) SET2[2]
Set (Outer) SET9[2]
1997-1995 Sportage
Seal (Inner) 223240[2]
Seal (Outer) 710387[2]

4WD

2009-2005 Sportage
Set SET49[2]

4-SPEED AUTOMATIC TRANSMISSION

Selector Shaft Seal/Man. Shaft

2002-1995
Seal 221122

CRANKSHAFT FRONT SEAL

4 Cylinder

2008-2005 2.0L (DOHC)
Seal 710531
2002-1995 2.0L (SOHC)(DOHC)
Seal 223420

6 Cylinder

2008-2005 2.7L
Seal 223750

CRANKSHAFT REAR SEAL

4 Cylinder

2008-2005 1975cc/2.0L
Seal Viton 710235

6 Cylinder

2008-2005 2656cc/2.7L
Seal Viton 229005
Repair Sleeve KWK99354

LAFORZA - Other Applications

FRONT WHEEL

RWD

1992-1990
Seal (Inner) 4250[2]
Set (Inner) SET37[2]
Set (Outer) SET45[2]

REAR WHEEL

RWD

1992-1990
Seal 8835S[2]
Cylindrical Bearing 6408[2]
Bearing & Seal Kit TRP1559TV[2] ¹⁹

¹⁹Opt. Axle Rpr Brg. Replaces O.E. Brg & Seal

²⁵New Item, Check For Availability

Mfg./Year	Model & Location	Part No.	Mfg./Year	Model & Location	Part No.
-----------	------------------	----------	-----------	------------------	----------

LAMBORGHINI - ALL**REAR AXLE****Differential**

1993-1990 Countach
Cone/Cup JM207049-JM207010[2]

Pinion

1993-1990 Countach
Cone/Cup (Inner) M802048-M802011
Cone/Cup (Outer) HM88649-HM88610

LEXUS - FRONT DRIVE - ES250, ES300, ES330, ES350**FRONT WHEEL****FWD**

2009-2007 ES350
Ball Bearing 510063[2]
2006-2004 ES330
Ball Bearing 510063[2]
2003-1992
Ball Bearing 510006[2]
1991-1990
Seal (Inner) 4899[2]
Ball Bearing (Inner) 514002B[2]
Seal (Outer) 225220[2]
Seal 5700[2]

REAR WHEEL**FWD**

2009-2007 ES350
Hub Unit Bearing (LH) HA592460
Hub Unit Bearing (RH) HA592450
2006-2004 ES330
Hub Unit Bearing (LH) HA592460
Hub Unit Bearing (RH) HA592450
2003-2002 ES300
Hub Unit Bearing (LH) HA592460
Hub Unit Bearing (RH) HA592450
2001-1992
Bearing Module 512009[2]
1991-1990
Seal 224210
Ball Bearing 513022[2]

CLUTCH - 6 CYLINDER**Release Bearing**

1993-1990 2507cc./2.5L (DOHC),
2958cc./3.0L (DOHC)(236mm
Cl.)
Bearing Assy 614084

4-SPEED AUTOMATIC TRANSAXLE**Torque Converter / Frt Pump**

2001-1990 (A540E, A541E)
Seal 223830
Repair Sleeve KWK99147

4-SPEED AUTOMATIC TRANSAXLE**Output Shaft**

2001-1990 (A540E, A541E)
Seal (LH) 712551
Seal (RH) 710112

Manual Shaft

2001-1990 (U140E, A540E, A541E)
Seal 221207
Repair Sleeve KWK99049

5-SPEED AUTOMATIC TRANSAXLE**Torque Converter**

2003-2002 (U150E, U151E)
Seal 224020

Manual Shaft

2006-2002 (U150E, U151E)
Seal 221207
Repair Sleeve KWK99049

5-SPEED MANUAL TRANSAXLE**Differential**

1993-1992 (E53)
Bearing Assy (RH) 30210M
1991-1990 (E52)
Bearing Assy (RH) 30210M

Input Shaft

1993-1992 (E53)
Seal 223010
Repair Sleeve KWK99114
1991-1990 (E52)
Seal 223010
Repair Sleeve KWK99114

Mfg./Year Model & Location Part No. Mfg./Year Model & Location Part No.

LEXUS - FRONT DRIVE - ES250, ES300, ES330, ES350 (cont.)

5-SPEED MANUAL TRANSAXLE

Output Shaft

1993-1992 (E53)	
Seal (LH)	223540
Repair Sleeve (LH)	KWK99139
Seal Viton (RH)	224026
Repair Sleeve (RH)	KWK99157
1991-1990 (E52)	
Seal	710112[2]
Repair Sleeve	KWK99196[2]

Selector Shaft Seal/Man. Shaft

1993-1990	
Seal	1015N

OIL PUMP

6 Cylinder

2006-2004 3300cc/3.3L	
Seal	224020
Repair Sleeve	KWK99157
2003-1994 2955cc/3.0L (DOHC)	
Seal	224020
Repair Sleeve	KWK99157

CAMSHAFT SEAL

6 Cylinder

2006-2004 3300cc/3.3L	
Seal	224020
2003-1994 2995cc/3.0L (DOHC)	
Seal	223801[2]
Repair Sleeve	KWK99147[2]
1993-1992 2958cc/3.0L (DOHC)	
Seal	223801[4]
Repair Sleeve	KWK99147[4]
1991-1990 2507cc/2.5L (DOHC)	
Seal	223801[2]
Repair Sleeve	KWK99147[2]

CRANKSHAFT FRONT SEAL

6 Cylinder

2006-2004 3300cc/3.3L	
Seal	224020
2003-1992 2959cc/3.0L	
Seal	224020
1991-1990 2507cc/2.5L	
Seal	224020
Repair Sleeve	KWK99157

CRANKSHAFT REAR SEAL

6 Cylinder

2006-2004 3300cc/3.3L	
Seal Viton	229210
2003-1990 2507cc/2.5L, 2958cc/3.0L, 2995/3.0L (DOHC)	
Seal Viton	229210

LEXUS - REAR DRIVE - GS300, GS350, GS400, GS430, GS450H, GS460, IS250, IS300, IS350, IS F, LS400, LS430, LS460, LS600H, SC300, SC400, SC430

FRONT WHEEL

RWD

2009-2006 GS300, GS350, GS430, GS450H, GS460	
Hub Unit Bearing (RH)	HA590137 ²⁵
Hub Unit Bearing (LH)	HA590138 ²⁵
2009-2006 SC430	
Seal	1941
Ball Bearing	510017[2]
2008-2007 LS460	
Hub Unit Bearing (RH)	HA590265 ²⁵
Hub Unit Bearing (LH)	HA590270 ²⁵
2008-2006 IS250, IS350, IS F	
Hub Unit Bearing (RH)	HA590137 ²⁵
Hub Unit Bearing (LH)	HA590138 ²⁵
2006-2001 LS430	
Hub Unit Bearing	HA593550[2]

FRONT WHEEL (cont.)

RWD (cont.)

2005-2001 IS300	
Ball Bearing	513150[2]
2005-1998 GS300, GS400, GS430, SC300, SC400, SC430	
Seal	1941[2]
Ball Bearing	510017[2]
2000-1998 LS400	
Ball Bearing	510071[2]
1997-1990	
Seal	1941[2]
Ball Bearing	510017[2]

²⁵New Item, Check For Availability

Mfg./Year	Model & Location	Part No.	Mfg./Year	Model & Location	Part No.
LEXUS - REAR DRIVE - GS300, GS350, GS400, GS430, GS450H, GS460, IS250, IS300, IS350, IS F, LS400, LS430, LS460, LS600H, SC300, SC400, SC430 (cont.)					

FRONT WHEEL**AWD**

2009-2008	LS600H	
	Hub Unit Bearing	HA590267[2] ²⁵
2008-2007	GS350	
	Hub Unit Bearing (LH)	HA590140 ²⁵
	Hub Unit Bearing (RH)	HA590139 ²⁵
2008-2006	IS250	
	Hub Unit Bearing (LH)	HA590140 ²⁵
	Hub Unit Bearing (RH)	HA590139 ²⁵
2006	GS300	
	Hub Unit Bearing (LH)	HA590140 ²⁵
	Hub Unit Bearing (RH)	HA590139 ²⁵

REAR WHEEL**RWD**

2009-2008	LS600H	
	Hub Unit Bearing	HA590268[2] ²⁵
2009-2006	GS300, GS350, GS430, GS450H, GS460	
	Hub Unit Bearing	HA590136[2] ²⁵
2009-2006	SC430	
	Ball Bearing	511028[2]
2008-2007	LS460	
	Hub Unit Bearing	HA590269[2] ²⁵
2008-2006	IS250, IS350, IS F	
	Hub Unit Bearing	HA590136[2] ²⁵
2006-2001	LS430	
	Hub Unit Bearing	HA591050[2]
2005-2001	IS300	
	Ball Bearing	511028[2]
2005-1998	GS300, GS400, GS430, SC430	
	Ball Bearing	511028[2]
2000-1998	LS400, SC300, SC400	
	Seal (Inner)	1928[2]
	Ball Bearing (Inner)	511007[2]
	Seal (Outer)	1935[2]
1997-1990		
	Seal (Inner)	1928[2]
	Ball Bearing (Inner)	511007[2]
	Seal (Outer)	1935[2]

AWD

2009-2008	LS600H	
	Hub Unit Bearing	HA590268[2] ²⁵
2009-2006	GS300, GS350, GS430, GS450H, GS460	
	Hub Unit Bearing	HA590136[2] ²⁵
2009-2006	SC430	
	Ball Bearing	511028[2]
2008-2007	LS460	
	Hub Unit Bearing	HA590269[2] ²⁵
2008-2006	IS250, IS350, IS F	
	Hub Unit Bearing	HA590136[2] ²⁵
2006-2001	LS430	
	Hub Unit Bearing	HA591050[2]
2005-2001	IS300	
	Ball Bearing	511028[2]
2005-1998	GS300, GS400, GS430, SC430	
	Ball Bearing	511028[2]

REAR WHEEL (cont.)**AWD (cont.)**

2000-1998	LS400, SC300, SC400	
	Seal (Inner)	1928[2]
	Ball Bearing (Inner)	511007[2]
	Seal (Outer)	1935[2]
1997-1990		
	Seal (Inner)	1928[2]
	Ball Bearing (Inner)	511007[2]
	Seal (Outer)	1935[2]

4-SPEED AUTOMATIC TRANSMISSION**Torque Converter**

2000-1990	(A340E)	
	Seal	223830
	Repair Sleeve	KWK99147

Rear Seal/Ext. Housing

2000-1990	(A340E)	
	Seal	3459S

Selector Shaft Seal/Man. Shaft

2000-1990	(A340E)	
	Seal	221207
	Repair Sleeve	KWK99049

5-SPEED AUTOMATIC TRANSMISSION**Torque Converter**

2002-1996	(A650E)	
	Seal	223830
	Repair Sleeve	KWK99147

Rear Seal/Ext. Housing

2002-1996	(A650E)	
	Seal	710142

Selector Shaft Seal/Man. Shaft

2006-1998	(A650E)	
	Seal	221207
	Repair Sleeve	KWK99049

CLUTCH**Pilot Bearing**

1996-1992	2997cc/3.0L (DOHC)	
	Ball Bearing	201CC

Release Bearing

1996-1992	(6 Cyl.)	
	Bearing Assy	614088

5-SPEED MANUAL TRANSMISSION**Front Input Shaft**

2004-1992	(W55, W58)	
	Seal	1981
	Repair Sleeve	KWK99114

²⁵New Item, Check For Availability

Mfg./Year	Model & Location	Part No.	Mfg./Year	Model & Location	Part No.
LEXUS - REAR DRIVE - GS300, GS350, GS400, GS430, GS450H, GS460, IS250, IS300, IS350, IS F, LS400, LS430, LS460, LS600H, SC300, SC400, SC430 (cont.)					

5-SPEED MANUAL TRANSMISSION

Rear Output Shaft

2004-1992	(W55, W58)	
Seal		223840

OIL PUMP

6 Cylinder

2006	2994cc/3.0L	
Seal		224020
Repair Sleeve		KWK99157

8 Cylinder

2000-1990	3969cc/4.0L (DOHC)	
Seal		473677
Repair Sleeve		KWK99157

CAMSHAFT SEAL

6 Cylinder

2005-1992	2997cc/3.0L (DOHC)	
Seal		710436[2]

8 Cylinder

2000-1990	3969cc/4.0L (DOHC)	
Seal		223802
Repair Sleeve		KWK99147[2]

CRANKSHAFT FRONT SEAL

6 Cylinder

2005-1992	2997cc/3.0L	
Seal		224663
Repair Sleeve		KWK99181

8 Cylinder

2006-2001	4294cc/4.3L	
Seal		224020

CRANKSHAFT REAR SEAL

6 Cylinder

2006	2994cc/3.0L	
Seal Viton		229210
2006	3456cc/3.5L	
Seal Viton		229210
2005-1992	2997cc/3.0L (DOHC)	
Seal Viton		229005
Repair Sleeve		KWK99354

8 Cylinder

2009-1990	3969cc/4.0L (DOHC), 4293cc/4.3L (DOHC)	
Seal Viton		710352
Repair Sleeve		KWK99364

LEXUS - SUV - GX470, LX450, LX470, LX570, RX300, RX330, RX350

FRONT WHEEL

FWD

2009-2004	RX330, RX350	
Ball Bearing		510063[2]
2003-1999	RX300	
Ball Bearing		510006[2]

4WD

2009-2003	GX470	
Bearing Module		BM500007[2] ²⁵
2008	LX570	
Bearing Module		BM500018[2]
2007-1998	LX470	
Seal (Inner)		710456[2]
Set (Outer)		SET47[2]
Cone/Cup (Inner)		JLM506849A-JLM506810[2]

FRONT WHEEL (cont.)

4WD (cont.)

1997-1996	LX450	
Seal (Inner)		226285[2]
Cone/Cup (Inner)		JLM104948-JLM104910[2]
Set (Outer)		SET47[2]

REAR WHEEL

FWD

2009-2004	RX330, RX350	
Hub Unit Bearing (RH)		HA592451 ²⁵
Hub Unit Bearing (LH)		HA592461 ²⁵
2003-1999	RX300	
Bearing Module		512009[2]

²⁵New Item, Check For Availability

Mfg./Year	Model & Location	Part No.	Mfg./Year	Model & Location	Part No.
LEXUS - SUV - GX470, LX450, LX470, LX570, RX300, RX330, RX350 (cont.)					

REAR WHEEL**4WD**

2009-2004	RX330, RX350	
	Hub Unit Bearing	HA590338[2] ²⁵
2009-2003	GX470	
	Bearing Module (LH)	HA594246
	Bearing Module (RH)	HA590050
2007-1998	LX470	
	Ball Bearing	510011[2]
2003-1999	RX300	
	Ball Bearing (Inner)	514002B[2]
	Seal (Outer)	225275
1997-1996	LX450	
	Seal (Inner)	226285[2]
	Cone/Cup (Inner)	JLM104948-JLM104910[2]
	Set (Outer)	SET47[2]

4WD FRONT AXLE**Differential**

2002-1996	(8.875" R.G.)	
	Bearing Assy	32010X[2]

Pinion

2007-2003	(8" R.G.)	
	Seal	710525
	Cone/Cup (Inner)	HM88649-HM88610
2002-1996	(8.875" R.G.)	
	Seal (Outer)	1177
	Bearing Assy (Inner)	35028
	Bearing Assy (Outer)	30306M

REAR AXLE**Differential**

2002-1999	(6.7" R.G.)	
	Seal	710419[2]
	Set	SET45[2]
	Repair Sleeve	KWK99139[2]
2002-1996	(8.875" R.G.)	
	Bearing Assy	32010X[2]

Pinion

2007-2003	(8" R.G.)	
	Seal	710525
	Cone/Cup (Inner)	HM88649-HM88610
2006-1999	(6.7" R.G.)	
	Seal (Outer)	1176S
	Cone/Cup (Inner)	HM88649-HM88610
	Cone/Cup (Outer)	M86649-M86610
	Repair Sleeve	KWK99147
2002-1996	(8.875" R.G.)	
	Seal (Outer)	1177
	Bearing Assy (Inner)	35028
	Bearing Assy (Outer)	30306M

TRANSFER CASE**Input Shaft**

1997-1996	(HF2AV)	
	Seal	224810
	Repair Sleeve	KWK99189

Front Output Shaft

1997-1996	(HF2AV)	
	Seal	224815
	Ball Bearing	208S[2]
	Repair Sleeve	KWK99189

Rear Output Shaft

1997-1996	(HF2AV)	
	Seal	710173
	Ball Bearing	110CB[2]

4-SPEED AUTOMATIC TRANSMISSION**Torque Converter**

2003-1998	(A343F)	
	Seal	223830
	Repair Sleeve	KWK99147
1997-1996	(A442F)	
	Seal Viton	2025
	Repair Sleeve	KWK99169

Rear Seal/Ext. Housing

2003-1998	(A343F)	
	Seal	3459S
1997-1996	(A442F)	
	Seal	224820

Selector Shaft Seal/Man. Shaft

2003-1999	(A140E, A140F)	
	Seal	223540
	Repair Sleeve	KWK99139
2003-1996	(A343F, A442F)	
	Seal	221207
	Repair Sleeve	KWK99049

4-SPEED AUTOMATIC TRANSAXLE**Differential**

2003-1999	(U140E, U140F)	
	Seal	710416[2]

Torque Converter / Frt Pump

2003-1999	(U140E, U140F)	
	Seal	223830
	Repair Sleeve	KWK99147

Output Shaft

2003-1999	(U150E, U151E)	
	Seal	223540[2]
	Repair Sleeve	KWK99139

Manual Shaft

2003-1999	(U140E, U140F)	
	Seal	221207
	Repair Sleeve	KWK99049
2002-1996	(A343F)	
	Seal	221207

²⁵New Item, Check For Availability

Mfg./Year	Model & Location	Part No.	Mfg./Year	Model & Location	Part No.
LEXUS - SUV - GX470, LX450, LX470, LX570, RX300, RX330, RX350 (cont.)					

5-SPEED AUTOMATIC TRANSAXLE
Manual Shaft

2008-2004 (U151E, U151F)
Seal 221207

ALTERNATOR

1997-1996 (Nippondenso 90)(Amp.)
Ball Bearing (Drive End) 302CC

POWER STEERING

Pump Shaft

2002-1998 LX470
Seal 710412

OIL PUMP

6 Cylinder

2006-2004 3300cc/3.3L
Seal 224020
Repair Sleeve KWK99157
2003-1999 2995cc/3.0L (DOHC)
Seal 224020
Repair Sleeve KWK99157

8 Cylinder

2009-1998 4664cc/4.7L
Seal 473677
Repair Sleeve KWK99157

CAMSHAFT SEAL

6 Cylinder

2003-1999 2995cc/3.0L (DOHC)
Seal 223801[2]
Repair Sleeve KWK99147[2]

8 Cylinder

2006-1998 4664cc/4.7L
Seal 223802[2]
Repair Sleeve KWK99147[2]

CRANKSHAFT FRONT SEAL

6 Cylinder

2006-2004 3300cc/3.3L
Seal 224020
2003-1999
Seal 224020
1997-1996 4476cc/4.5L
Seal 710187

8 Cylinder

2005-1998 4664cc/4.7L
Seal 224020

CRANKSHAFT REAR SEAL

6 Cylinder

2006-2004 3300cc/3.3L
Seal Viton 229210
2003-1999 2997cc/3.0L
Seal Viton 229210
1997-1996 4476cc/4.5L
Seal 710526

8 Cylinder

2009-1998 4664cc/4.7L
Seal Viton 710352
Repair Sleeve KWK99364

Mfg./Year	Model & Location	Part No.	Mfg./Year	Model & Location	Part No.
-----------	------------------	----------	-----------	------------------	----------

LEXUS - SUV - RX400H**FRONT WHEEL****FWD**

2009-2006

Ball Bearing 510063[2]

REAR WHEEL**FWD**

2009-2006

Hub Unit Bearing (RH) HA592451 ²⁵Hub Unit Bearing (LH) HA592461 ²⁵**4WD**

2009-2006

Hub Unit Bearing HA590338[2] ²⁵**OIL PUMP****6 Cylinder**

2008-2007

Seal 224020

Repair Sleeve KWK99157

CAMSHAFT SEAL**6 Cylinder**

2008-2007

Seal 223801

Repair Sleeve KWK99147

CRANKSHAFT REAR SEAL**6 Cylinder**

2008-2007

Seal Viton 229210

LINCOLN - FRONT DRIVE - Continental**FRONT WHEEL****FWD**

2002-1995

Hub Unit Bearing 513100[2]

1994-1991 (From 2/1/91)

Set SET49[2]

Hub Unit Bearing 520100[2] ⁶⁵

1991-1990 (Thru 1/31/91)

Set SET49[2]

Hub Unit Bearing 520000[2] ⁶⁷**REAR WHEEL****FWD**

2002-1993

Hub Unit Bearing 512107[2]

1992-1990

Hub Unit Bearing 512105[2] ¹⁶**4-SPEED AUTOMATIC TRANSAXLE****Differential**

2002-1990

Ball Bearing 208[2]

Torque Converter / Frt Pump

2002-1990

Seal 4189H

4-SPEED AUTOMATIC TRANSAXLE**Output Shaft**

2002-1990

Seal 3622S[2]

Repair Sleeve KWK99169[2]

ALTERNATOR

1990 (Motorcraft)

Ball Bearing (Drive End) 203FF

1990 (Motorcraft)

Ball Bearing (Rear End) MNJ471S

POWER STEERING**Input Shaft**

1995-1990

Seal 471645

Ndle Bearing FC65753[2]

Pitman Shaft

1992-1990

Seal 710504

Pump Shaft

2002-1990

Seal 8773S

Worm Shaft

1995-1990

Ball Bearing 201CC[2]

¹⁶Obsolete²⁵New Item, Check For Availability⁶⁵Kit = Nut, Studded Spindle, Bearing, Snap Ring⁶⁷Kit = Flg, Brg, Nut, & Snap Ring

Mfg./Year Model & Location Part No. Mfg./Year Model & Location Part No.

LINCOLN - FRONT DRIVE - Continental (cont.)

CRANKSHAFT FRONT SEAL

6 Cylinder

1994-1990 232/3.8L
 Seal (Frt Entry)2692
 Seal (Rr Entry)2942
 Repair SleeveKWK99187
 Harmnc Balancer Slvs 88187

8 Cylinder

2002-1995 281/4.6L
 Seal482041N
 Repair SleeveKWK99187
 Harmnc Balancer Slvs 88187

CRANKSHAFT REAR SEAL

6 Cylinder

1994-1990 232/3.8L
 Seal Viton 3909
 Seal PTFE H/D 5277
 Repair SleeveKWK99363

CRANKSHAFT REAR SEAL

8 Cylinder

2002-1995 281/4.6L
 Seal Viton 3909
 Seal PTFE H/D 5277
 Repair SleeveKWK99362

LINCOLN - FRONT DRIVE - MKS

FRONT WHEEL

FWD

2009
 Hub Unit BearingHA590261[2]²⁵

AWD

2009
 Hub Unit BearingHA590261[2]²⁵

REAR WHEEL

FWD

2009
 Hub Unit BearingHA590261[2]²⁵

REAR WHEEL

AWD

2009
 Hub Unit BearingHA590261[2]²⁵

LINCOLN - FRONT DRIVE - Zephyr, MKZ

FRONT WHEEL

FWD

2009-2006
 Ball Bearing510010[2]

AWD

2009-2006
 Ball Bearing510010[2]

REAR WHEEL

FWD

2009-2006 (Non-ABS)
 Hub Unit BearingHA590095[2]²⁵
 2006 (ABS)
 Hub Unit BearingHA590100[2]²⁵

AWD

2009-2007
 Ball Bearing510010[2]

CRANKSHAFT FRONT SEAL

6 Cylinder

2008-2006 3.0L, 3.5L (DOHC)
 Seal482041N
 Repair SleeveKWK99187

²⁵New Item, Check For Availability

Mfg./Year	Model & Location	Part No.	Mfg./Year	Model & Location	Part No.
LINCOLN - FRONT DRIVE - Zephyr, MKZ (cont.)					

CRANKSHAFT REAR SEAL**6 Cylinder**

2006	3.0L (DOHC)	
Seal Viton	3909
Seal PTFE H/D	5277
Repair Sleeve	KWK99363

LINCOLN - REAR DRIVE - Continental, LS, Mark Series, Town Car**FRONT WHEEL****RWD**

2009-2006	Town Car	
Hub Unit Bearing	513230[2] ²⁵
2006-2000	LS	
Hub Unit Bearing	HA590213[2]
2005-2003	Town Car	
Hub Unit Bearing	513196[2]
2002-1997	Town Car (From 4/1/97)	
Hub Unit Bearing	513202[2]
1998-1993	Mark VIII	
Hub Unit Bearing	513092[2]
1997-1992	Town Car (Thru 3/31/97)	
Hub Unit Bearing	513104[2]
1993-1990	(Exc. Town Car)	
Seal (Inner)	9150S[2]
Set (Inner)	SET5[2]
Set (Outer)	SET12[2]
1991-1990	Town Car	
Seal (Inner)	6815[2]
Set (Inner)	SET11[2]
Set (Outer)	SET12[2]

REAR WHEEL**RWD**

2009-1993	Continental, Town Car	
Seal	8660S[2]
Cylindrical Bearing	5707[2]
Bearing & Seal Kit	TRP1563TAV[2] ¹⁹
2009-1990	Town Car (Limo. Ch.)	
Seal	8835S[2]
Cylindrical Bearing	6408[2]
Bearing & Seal Kit	TRP1559TV[2] ¹⁹
2006-2000	LS	
Ball Bearing	511032[2]
1998-1993	Mark VIII	
Set	SET49[2]
1992-1990	(Exc. Limo. Ch.)	
Seal	8660S[2]
Cylindrical Bearing	5707[2]
Bearing & Seal Kit	TRP1563TAV[2] ¹⁹

REAR AXLE**Axle Shaft**

2006-2000	(8.8" R.G.)(Indep. Rr. Susp.)	
Seal Viton (Inner)	714569[2]
Ndle Bearing (Inner)	FC66998[2]
Repair Sleeve	KWK99157[2]

REAR AXLE (cont.)**Axle Shaft (cont.)**

1998-1990	(IRS 7.5" R.G., IRS 8.8" R.G.)	
Seal Viton	714569[2]
Ndle Bearing	FC66998[2]
Repair Sleeve	KWK99157[2]

Differential Rebuild Kit

2008-1990	(8.5", 8.8" R.G.)	
Kit	DRK311

Differential

2008-1990	Town Car	
Set	SET36[2]
2006-2000	LS	
Set	SET36[2]
1998-1993	Mark Ser.	
Cone/Cup	LM501349-LM501314[2]

Pinion

2008-2000	(8" R.G.)	
Seal Viton	3604
Cone/Cup (Inner)	NP559445-NP945727
Cone/Cup (Outer)	M88048-M88010
2008-1999	(8.8" R.G.)	
Seal Viton	3604
Cone/Cup (Inner)	M802048-M802011
Cone/Cup (Outer)	M88048-M88010
1998-1990		
Seal Viton	3604
Cone/Cup (Inner)	M802048-M802011
Cone/Cup (Outer)	M88048-M88010
Cylindrical Bearing	R1535TAV

4-SPEED AUTOMATIC TRANSMISSION**Torque Converter**

2006-1992	(AODE)	
Seal	472341
Repair Sleeve	KWK99199
1991-1990	(AOT, AOD)	
Seal	331107N
Repair Sleeve	KWK99199

¹⁹Opt. Axle Rpr Brg. Replaces O.E. Brg & Seal²⁵New Item, Check For Availability

Mfg./Year	Model & Location	Part No.	Mfg./Year	Model & Location	Part No.
-----------	------------------	----------	-----------	------------------	----------

LINCOLN - REAR DRIVE - Continental, LS, Mark Series, Town Car (cont.)

4-SPEED AUTOMATIC TRANSMISSION

Rear Seal/Ext. Housing

2003-1995 (AODE)	
Seal	4764
1994-1990 (AODE)	
Seal	7692S
Seal Kit	5202 ⁶⁴
1991-1990 (AOT, AOD)(long boot)	
Seal	7692S
Seal Kit	5202 ⁶⁴

Selector Shaft Seal/Man. Shaft

2006-1990	
Seal	7929S
Repair Sleeve	KWK99076

5-SPEED AUTOMATIC TRANSMISSION

Selector Shaft Seal/Man. Shaft

2006-2000	
Seal	7929S

ALTERNATOR

1990 (Motorcraft)(w/o 95 Amp.)	
Ball Bearing (Drive End)	203FF
1990 (Motorcraft)(w/o 95 Amp.)	
Ball Bearing (Rear End)	MNJ471S

CRANKSHAFT FRONT SEAL

6 Cylinder

2005-2000 182/3.0L (DOHC)	
Seal	482041N
Repair Sleeve	KWK99187
Harmnc Balancer Slvs	88187
1994-1990 232/3.8L	
Seal (Frt Entry)	2692
Seal (Rr Entry)	2942
Repair Sleeve	KWK99187
Harmnc Balancer Slvs	88187

8 Cylinder

2008-1991 281/4.6L	
Seal	482041N
Repair Sleeve	KWK99187
Harmnc Balancer Slvs	88187

CRANKSHAFT FRONT SEAL (cont.)

8 Cylinder (cont.)

1992-1990 302/5.0L, 351/5.8L, 400/6.6L, 460/7.5L	
Seal (Frt Entry)	2692
Seal (Rr Entry)	2942
Repair Sleeve	KWK99187
Harmnc Balancer Slvs	88187

CRANKSHAFT REAR SEAL

6 Cylinder

2005-2000 182/3.0L	
Seal Viton	3909
Seal PTFE H/D	5277
Repair Sleeve	KWK99363

8 Cylinder

2008-1990 281/4.6L, 302/5.0L	
Seal Viton	3909
Seal PTFE H/D	5277
Repair Sleeve	KWK99362

LINCOLN - SUV, Truck - Aviator, Blackwood, Mark LT, Navigator

FRONT WHEEL

RWD

2009-2007 Navigator	
Hub Unit Bearing	SP550211[2] ²⁵
2008-2006 Mark LT	
Set	SET930[2] ²⁵
2006-2003 Navigator	
Hub Unit Bearing	SP550206[2] ²⁵
2005-2003 Aviator	
Hub Unit Bearing	HA590259K[2] ⁶⁸

FRONT WHEEL (cont.)

RWD (cont.)

2002 Blackwood	
Seal (Inner)	4148[2]
Cone/Cup (Inner)	JL69349P-JL69310P[2]
Set (Outer)	SET12FP[2] ⁶⁰
2002-1998 Navigator	
Seal (Inner)	4148[2]
Cone/Cup (Inner)	JL69349P-JL69310P[2]
Set (Outer)	SET12FP[2] ⁶⁰

²⁵New Item, Check For Availability

⁶⁰O.E. Polymer Cage, Performance

⁶⁴Seal & Bushing Kit

⁶⁸Kit = Flg, Brg, & Snap Ring

LINCOLN - SUV, Truck - Aviator, Blackwood, Mark LT, Navigator (cont.)**FRONT WHEEL****4WD**

2009-2007 Navigator	
Hub Unit Bearing	SP550210[2] ²⁵
2008-2006 Mark LT	
Hub Unit Bearing	SP550207[2] ⁷⁸
Hub Unit Bearing	SP550208[2] ⁸²
2006-2003 Navigator	
Hub Unit Bearing	SP550202[2]
2002-2000 (ABS)(M14 Bolts)	
Hub Unit Bearing	515031[2]
2000-1998 (ABS)(M12 Bolts)	
Hub Unit Bearing	SP550201[2] ⁴⁰

AWD

2005-2003 Aviator	
Hub Unit Bearing (ABS Cable Included)	SP470200[2]
Hub Unit Bearing	SP470201[2] ⁰²

REAR WHEEL**RWD**

2009-2007 Navigator	
Hub Unit Bearing	SP550209[2] ²⁵
2008-2006 Mark LT	
Seal Viton	100357[2]
Cylindrical Bearing	R1561TV[2]
2006-2003 Navigator	
Hub Unit Bearing	SP550203[2]
2005-2003 Navigator (Indep. Rr. Susp.)	
Ndle Bearing	FC66998[2]
2002 Blackwood	
Seal Viton	100357[2]
Cylindrical Bearing	R1561TV[2]
Bearing & Seal Kit	TF01561R[2] ¹⁹
2002-1998 Navigator (Exc. Indep. Rr. Susp.)	
Seal Viton	100357[2]
Cylindrical Bearing	R1561TV[2]
Bearing & Seal Kit	TF01561R[2] ¹⁹

4WD

2009-2007 Navigator	
Hub Unit Bearing	SP550209[2] ²⁵
2008-2006 Mark LT	
Seal Viton	100357[2]
Cylindrical Bearing	R1561TV[2]
2006-2003 Navigator	
Hub Unit Bearing	SP550203[2]
2005-2003 Navigator (Indep. Rr. Susp.)	
Ndle Bearing	FC66998[2]
2002 Blackwood	
Seal Viton	100357[2]
Cylindrical Bearing	R1561TV[2]
Bearing & Seal Kit	TF01561R[2] ¹⁹
2002-1998 Navigator (Exc. Indep. Rr. Susp.)	
Seal Viton	100357[2]
Cylindrical Bearing	R1561TV[2]
Bearing & Seal Kit	TF01561R[2] ¹⁹

REAR WHEEL**AWD**

2005-2003 Aviator	
Hub Unit Bearing	HA590259K[2] ⁶⁸

4WD FRONT AXLE**Axle Shaft**

2008-1998 (8.8" R.G.)(Indep. Frt. Susp.)	
Ndle Bearing (Inner)	HK4012[2]
Ndle Bearing (Outer)	FC66998[2]

Differential Rebuild Kit

2007-1998 (8.8" R.G.)	
Kit	DRK311F

Differential

2007-2003 (8.8" R.G.)	
Cone/Cup	LM603049-LM603019[2]
2005-2003 Aviator	
Cone/Cup	LM501349-LM501314[2]
2002-1998 (8.8" R.G.)	
Set	SET36[2]

Pinion

2007-1998 (8.8" R.G.)	
Seal Viton	3604
Cone/Cup (Inner)	M802048-M802011
Cone/Cup (Outer)	M88048-M88010

REAR AXLE**Axle Shaft**

2008-2002 (8.8" R.G.)(Indep. Rr. Susp.)	
Ndle Bearing	FC66998[2]
Seal	100537[2]

Differential Rebuild Kit

2008-2002 (8.8" R.G.)(Indep. Rr. Susp.)	
Kit	DRK311A ²⁵
2007-2006 (9.75" R.G.)	
Kit	DRK316A
2001-1998 (8.8" R.G.)	
Kit	DRK311

Differential

2008-2006 (10.25" R.G.)	
Seal	469-453X[2]
2008-2002 (8.8" R.G.)(Indep. Rr. Susp.)	
Cone/Cup	LM603049-LM603019[2]
2008-1998 (9.75" R.G.)	
Cone/Cup	NP343847-NP372019[2]
2001-1998 (8.8" R.G.)	
Set	SET36[2]

⁰²Does Not Come w/ Sensor Cable.
Check For Availability ⁴⁰5 Stud.
⁸²7 Stud, New Item.

¹⁹Opt. Axle Rpr Brg. Replaces O.E. Brg & Seal ²⁵New Item,
⁶⁸Kit = Flg, Brg, & Snap Ring ⁷⁸6 Stud, New Item.

Mfg./Year	Model & Location	Part No.	Mfg./Year	Model & Location	Part No.
LINCOLN - SUV, Truck - Aviator, Blackwood, Mark LT, Navigator (cont.)					

REAR AXLE

Pinion

2008-2006 (10.25" R.G.)	
Seal Viton	4278
Cone/Cup (Inner)	NP504493-NP949481
Cone/Cup (Outer)	HM89443-HM89411
2008-2003 (9.75" R.G.)	
Seal Viton	4278
Cone/Cup (Inner)	NP576375-NP434567
Cone/Cup (Outer)	HM89443-HM89411
2008-1998 (8.8" R.G.)	
Seal Viton	3604
Cone/Cup (Inner)	M802048-M802011
Cone/Cup (Outer)	M88048-M88010
2002-1998 (9.75" R.G.)	
Seal Viton	3604
Cone/Cup (Inner)	NP576375-NP434567
Cone/Cup (Outer)	M88048-M88010

TRANSFER CASE REBUILD KIT

2002-1998 (Warner 4406)	
Kit	TCRK4406

TRANSFER CASE

Input Shaft

2008-2006 (Warner 4406)(Booted)	
Seal	4333N
Ball Bearing	211TB
Ndle Bearing (Pilot)	BK3026
2008-2003 (Warner 4416)	
Seal	3946
Ball Bearing	211TB
Repair Sleeve	KWK99187
2007-2006 (Warner 4406)(w/o Boot)	
Seal	3946
Ball Bearing	211TB
Repair Sleeve	KWK99187
2005-2003 (Warner 4410)	
Seal	710403
Ball Bearing	209LO
Repair Sleeve	KWK99166
2002-1998 (Warner 4406)(Booted)	
Seal	4333N
Ball Bearing	211TB
Ndle Bearing (Pilot)	BK3026
2002-1998 (Warner 4406)(w/o Boot)	
Seal	3946
Ball Bearing	211TB
Ndle Bearing (Pilot)	BK3026
Repair Sleeve	KWK99187

Front Output Shaft

2008-2006 (Warner 4406)	
Seal	4333N
Ball Bearing	208
2008-2003 (Warner 4416)	
Ball Bearing (Inner)	107WB
Seal (Outer)	4333N
Ball Bearing (Outer)	208
Seal	4333N

TRANSFER CASE (cont.)

Front Output Shaft (cont.)

2005-2003 (Warner 4410)	
Seal	710403
Ball Bearing	206WB
Repair Sleeve	KWK99166
2005-2003 (Warner 4410, 4411E)	
Seal	710403
Repair Sleeve	KWK99166
2002-1998 (Warner 4406, 4416)	
Seal	4333N
Ball Bearing	208[2]

Rear Output Shaft

2008-2002 (Warner 4416)	
Seal	4503N
Ball Bearing (Inner)	307TB
Ball Bearing (Outer)	111TB
2007-2006 (Warner 4406)	
Seal	4503N
Ball Bearing	207
Ndle Bearing Thrust	NTA2233
2005-2003 (Warner 4410)	
Seal	710403
Ball Bearing	208SL
Repair Sleeve	KWK99166
2002-1998 (Warner 4406)	
Seal	4503N
Ball Bearing	207[2]
Ndle Bearing Thrust	NTA2233

Selector Shaft Seal/Man. Shaft

2008-1998 (Warner 4406, 4416)	
Seal	330385

4-SPEED AUTOMATIC TRANSMISSION

Torque Converter

2002-1998 (AODE)	
Seal	3404

Rear Seal/Ext. Housing

2004-1998 (AODE)	
Seal	7300S
Repair Sleeve	KWK99168

Selector Shaft Seal/Man. Shaft

2006-1998	
Seal	7929S

5-SPEED AUTOMATIC TRANSMISSION

Torque Converter

2008-2007 (5R110W) Torqshift	
Seal	710485

Mfg./Year Model & Location Part No. Mfg./Year Model & Location Part No.

LINCOLN - SUV, Truck - Aviator, Blackwood, Mark LT, Navigator (cont.)

5-SPEED AUTOMATIC TRANSMISSION

Selector Shaft Seal/Man. Shaft

2008-2003
Seal 7929S

POWER STEERING

Pump Shaft

2001-1998
Seal 8773S

CRANKSHAFT FRONT SEAL

8 Cylinder

2008-1998 330/5.4L (SOHC)
Seal 482041N
Repair Sleeve KWK99187
Harmnc Balancer Slvs 88187
2005-2003 281/4.6L
Seal 482041N
2005-1998 330/5.4L (DOHC)
Seal 482041N
Repair Sleeve KWK99187
Harmnc Balancer Slvs 88187

CRANKSHAFT REAR SEAL

8 Cylinder

2008-1998 330/5.4L
Seal Viton 3909
Seal PTFE H/D 5277
Repair Sleeve KWK99362
2005-2003 281/4.6L
Seal Viton 3909
Seal PTFE H/D 5277
Repair Sleeve KWK99363

LINCOLN - SUV, Truck - MKX

FRONT WHEEL

FWD

2009-2007
Ball Bearing 510063[2]

AWD

2009-2007
Ball Bearing 510063[2]

REAR WHEEL

FWD

2009
Hub Unit Bearing HA590335[2]
2008-2007
Hub Unit Bearing HA590180[2]²⁵

AWD

2009-2007
Hub Unit Bearing HA590183[2]²⁵

CRANKSHAFT FRONT SEAL

6 Cylinder

2008-2007 3498cc/3.5L (DOHC)
Seal 482041N
Repair Sleeve KWK99187

MASERATI - ALL

FRONT WHEEL

RWD

1992-1990 228
Set (Inner) SET6[2]
Set (Outer) SET2[2]

FRONT WHEEL (cont.)

RWD (cont.)

1992-1990 430
Set (Inner) SET6[2]
Set (Outer) SET2[2]

²⁵New Item, Check For Availability

Mfg./Year Model & Location Part No. Mfg./Year Model & Location Part No.

MASERATI - ALL (cont.)

FRONT WHEEL (cont.)

RWD (cont.)

1991-1990 Spyder
 Set (Inner) SET6[2]
 Set (Outer) SET2[2]

REAR WHEEL

RWD

1993-1990 228
 Cone/Cup (Inner) LM78349-LM78310A[2]
 Cone/Cup (Outer) LM300849-LM300811[2]
 1993-1990 430
 Cone/Cup (Inner) LM78349-LM78310A[2]
 Cone/Cup (Outer) LM300849-LM300811[2]
 1992-1990 Spyder
 Cone/Cup (Inner) LM78349-LM78310A[2]
 Cone/Cup (Outer) LM300849-LM300811[2]

REAR AXLE

Differential

1993-1990 228, 430
 Cone/Cup LM501349-LM501311[2]

MAZDA - FRONT DRIVE - Mazda3, Mazda5, Mazda6, Millenia, MX-3, MX-6, Protege, 323, 626

FRONT WHEEL

FWD

2009 Mazda 6 (2.5L)
 Ball Bearing WB000026[2]²⁵
 2009 Mazda 6 (3.7L)
 Ball Bearing WB000025[2]²⁵
 2009-2006 Mazda5
 Ball Bearing 510010[2]
 2008-2006 Mazda Speed6
 Ball Bearing 510063[2]
 2008-2005 Mazda 3 (ABS)(From 1/05)
 Ball Bearing WB000033[2]²⁵
 2008-2005 Mazda 3 (Non- ABS)(From 1/05)
 Ball Bearing WB000032[2]²⁵
 2008-2003 Mazda6
 Ball Bearing 510053[2]
 2005-2004 Mazda3 (ABS)
 Hub Unit Bearing HA590097[2]²⁵
 2005-2004 Mazda3 (Non-ABS)
 Hub Unit Bearing HA590072[2]²⁵
 2003-1990 Protege
 Seal 1932S[2]
 Ball Bearing 510003[2]
 2002-2001 Millenia (2.3L)
 Seal 710392[2]
 Ball Bearing 511019[2]
 2002-2001 Millenia (2.5L)
 Seal 1932S[2]
 Ball Bearing 510010[2]
 2002-1998 626
 Seal 1932S[2]
 Ball Bearing 510010[2]

FRONT WHEEL (cont.)

FWD (cont.)

2000-1997 Millenia
 Seal 1932S[2]
 Ball Bearing 510010[2]
 1997-1993 626
 Seal 1932S[2]
 Ball Bearing 510010[2]
 1997-1993 MX-6
 Seal 1932S[2]
 Ball Bearing 510010[2]
 1996-1995 Millenia (2.3L)
 Ball Bearing 510010[2]
 1996-1995 Millenia (2.5L)
 Seal 1932S[2]
 Ball Bearing 510010[2]
 1996-1992 MX-3
 Seal 1932S[2]
 Ball Bearing 510003[2]
 1995-1990 323
 Seal 1932S[2]
 Ball Bearing 510003[2]
 1992-1990 MX-6
 Seal 1932S[2]
 Bearing Assy 513057[2]
 1992-1990 626
 Seal 1932S[2]
 Bearing Assy 513057[2]

²⁵New Item, Check For Availability

Mfg./Year	Model & Location	Part No.	Mfg./Year	Model & Location	Part No.
-----------	------------------	----------	-----------	------------------	----------

MAZDA - FRONT DRIVE - Mazda3, Mazda5, Mazda6, Millenia, MX-3, MX-6, Protege, 323, 626 (cont.)

FRONT WHEEL**AWD**

2007-2006	Mazda6	
	Ball Bearing	510053[2]
1991-1990	Protege	
	Seal	1932S[2]
	Ball Bearing	510003[2]

REAR WHEEL**FWD**

2009	Mazda6	
	Hub Unit Bearing	HA590336[2] ²⁵
2009-2006	Mazda5	
	Hub Unit Bearing	HA590099[2] ²⁵
2008-2004	Mazda3 (ABS)	
	Hub Unit Bearing	HA590099[2] ²⁵
2008-2003	Mazda6 (ABS)	
	Hub Unit Bearing	HA590100[2] ²⁵
2008-2003	Mazda6 (Non-ABS)	
	Hub Unit Bearing	HA590095[2] ²⁵
2006-2004	Mazda3 (Non-ABS)	
	Hub Unit Bearing	HA590098[2] ²⁵
2003-1990	Protege (Drum)	
	Hub Unit Bearing	513030[2]
2002-2001	Millenia (ABS)(Disc)	
	Hub Unit Bearing	513131[2]
2002-2001	Protege (ABS)(Disc)	
	Hub Unit Bearing	513131[2]
2002-1998	626 (ABS)	
	Hub Unit Bearing	512186[2]
2002-1993	626 (Non-ABS)	
	Hub Unit Bearing	512119[2]
2000-1995	Millenia	
	Hub Unit Bearing	512118[2]
2000-1995	Protege (Disc)	
	Hub Unit Bearing	512161[2]
1997-1993	626 (ABS)	
	Hub Unit Bearing	512118[2]
1997-1993	MX-6 (ABS)	
	Hub Unit Bearing	512118[2]
1997-1993	MX-6 (Non-ABS)	
	Hub Unit Bearing	512119[2]
1995-1990	323	
	Hub Unit Bearing	513030[2]
1994-1992	MX-3 (Disc)	
	Hub Unit Bearing	512161[2]
1994-1992	MX-3 (Non-ABS)	
	Hub Unit Bearing	513030[2]
1992-1990	626 (4 Whl. Steering)	
	Seal	710191[2]
	Bearing Assy	513245[2] ^z
1992-1990	626 (Exc. 4 Whl. Steering)	
	Seal	224235[2]
	Bearing Assy	513055[2]
1992-1990	MX-6 (4 Whl. Steering)	
	Seal	710191[2]
	Bearing Assy	513245[2] ^z
1992-1990	MX-6 (Exc. 4 Whl. Steering)	
	Seal	224235[2]
	Bearing Assy	513055[2]

REAR WHEEL**AWD**

2008-2003	Mazda6	
	Ball Bearing	510010[2]
1991-1990	Protege	
	Seal	1932S[2]
	Ball Bearing	510003[2]

REAR AXLE**Pinion**

1991-1990	Protege (AWD), 323 (AWD)	
	Bearing Assy (Inner)	32206M
	Seal (Outer)	710217
	Bearing Assy (Outer)	32205
	Repair Sleeve	KWK99139

CLUTCH**Pilot Bearing**

1996-1990		
	Ball Bearing	202SS

Release Bearing

2002-2001	626, 2.0L	
	Bearing Assy	614067
2002-2001	Protege, 1.66L	
	Bearing Assy	614128
2002-2001	Protege, 2.0L	
	Bearing Assy	614067
1997-1993	626 4 Cyl.	
	Bearing Assy	614079
1997-1993	MX 6 4 Cyl.	
	Bearing Assy	614079
1996-1993	626 6 Cyl.	
	Bearing Assy	614079
1996-1993	MX 6 6 Cyl.	
	Bearing Assy	614079
1996-1990	Proteg (FWD)(SOHC)	
	Bearing Assy	614128
1995-1993	RX 7 (Twin Turbo)	
	Bearing Assy	614164
1995-1992	MX-3	
	Bearing Assy	614128
1993-1990	323 (SOHC)	
	Bearing Assy	614128
1993-1990	MX 6 (w/o Turbo)	
	Bearing Assy	614067
1992-1990	Proteg, (DOHC)	
	Bearing Assy	614067
1992-1990	MX 6 (Turbo)	
	Bearing Assy	614079
1992-1990	929	
	Bearing Assy	614079
1992-1990	626 (Turbo)	
	Bearing Assy	614079
1992-1990	626 (w/o Turbo)	
	Bearing Assy	614067
1992-1990	RX 7 (Turbo)	
	Bearing Assy	614079
1991-1990	Proteg, (4WD)	
	Bearing Assy	614079

^zNon-Cancellable/Non-Returnable²⁵New Item, Check For Availability

Mfg./Year Model & Location Part No. Mfg./Year Model & Location Part No.

MAZDA - FRONT DRIVE - Mazda3, Mazda5, Mazda6, Millenia, MX-3, MX-6, Protege, 323, 626 (cont.)

3-SPEED AUTOMATIC TRANSAXLE

Differential

1991-1990 (F3A)
Bearing Assy32008XM[2]

Torque Converter

1991-1990 (F3A)
Seal1012N
Repair SleeveKWK99177

Output Shaft

1991-1990 (F3A)
Seal223543[2]
Repair SleeveKWK99139[2]

4-SPEED AUTOMATIC TRANSAXLE

Differential

2002-1990 (F4A EL)
SetSET17[2]
2000-1995 (JF403)
Bearing Assy30208M[2]
1997-1990 (G4A EL)
Bearing Assy32008XM[2]

Torque Converter / Frt Pump

2002-1990 (F4A EL, G4A EL, G4A HL)
Seal710446
2000-1995 (JF403)
Seal710114

Output Shaft

2007-2006 (FS5A-EL)
Seal2007N[2]
Repair SleeveKWK99139
2002-1990 (F4A EL, G4A EL, G4A HL)
Seal (LH)223543
Seal (RH)2007N
Repair SleeveKWK99139

5-SPEED AUTOMATIC TRANSAXLE

Output Shaft

2002-1996
Seal3622S[2]
Repair SleeveKWK99169[2]

4-SPEED MANUAL TRANSAXLE

Differential

1991-1990 (F4A)
SetSET17[2]

Input Shaft

1991-1990 (F4A)
Seal222430
Repair SleeveKWK99098

4-SPEED MANUAL TRANSAXLE

Output Shaft

1991-1990 (F4A)
Seal (LH)223543
Repair Sleeve (LH)KWK99139
Seal (RH)2007N
Repair Sleeve (RH)KWK99139

5-SPEED MANUAL TRANSAXLE

Input Shaft

2002-1990 (F5A, F52, F501)
Seal222430
Repair SleeveKWK99098
2002-1990 (F5F, G5A, G5M, G5Y, H5Y, G501)
Seal (Outer)1990
Set (Outer)SET32[2]
Repair SleeveKWK99106

Countershaft

2002-1990 (F5A, F52, F501)
Bearing Assy (Frt)32205[2]

Output Shaft

2002-1990 (F5A, F5F, F52, G5A, G5M, G5Y, H5Y, F501, G501)
Seal (LH)223543
Repair Sleeve (LH)KWK99139
Seal (RH)2007N
Repair Sleeve (RH)KWK99139

Selector Shaft Seal/Man. Shaft

2003-1990 (G5M, G5Y, H5Y)
Seal221620

CV JOINT HALF SHAFT

1995-1992 MX 3 (1.6)
Seal (Inner)710224
Seal (Outer)710223
1992-1990 626
Seal710253
Seal (Inner)710224
Seal (Outer)710223
1992-1990 MX-6
Seal710253
Seal (Inner)710224
Seal (Outer)710223

OIL PUMP

6 Cylinder

1995-1990 2954/3.0L
Seal710264

Mfg./Year	Model & Location	Part No.	Mfg./Year	Model & Location	Part No.
-----------	------------------	----------	-----------	------------------	----------

MAZDA - FRONT DRIVE - Mazda3, Mazda5, Mazda6, Millenia, MX-3, MX-6, Protege, 323, 626 (cont.)

CAMSHAFT SEAL

4 Cylinder

2003-1990	1489cc/1.5L, 1597cc/1.6L, 1839cc/1.8L, 1991cc/2.0L	
Seal		223420[2]
1995-1990	1597cc/1.6L, 1839cc/1.8L	
Seal		223012
1992-1990	1998cc/2.0L, 2184cc/2.2L	
Seal		223420

6 Cylinder

2002-1992	1844cc/1.8L, 2254cc/2.3L, 2497cc/2.5L	
Seal		223012[4]
Repair Sleeve		KWK99114[4]

CRANKSHAFT FRONT SEAL

4 Cylinder

2003-1994	2.0L (SOHC)(DOHC)	
Seal		223420
2001-1992	1489cc/1.5L, 1597cc/1.6L, 1839cc/1.8L	
Seal		710355
Repair Sleeve		KWK99145
1993	1991cc/2.0L From 3/13/93	
Seal		223420
1993	1991cc/2.0L, (Thru 3/12/93)	
Seal Viton		2012V
Repair Sleeve		KWK99166
1992-1990	1998cc/2.0L, 2184cc/2.2L	
Seal		223420
1991	1597cc/1.6L From 12/2/90	
Seal		710355
Repair Sleeve		KWK99145
1991	1597cc/1.6L To 12/1/90	
Seal		223012
Repair Sleeve		KWK99114
1991	1839cc/1.8L From 2/2/91	
Seal		710355
Repair Sleeve		KWK99145
1991	1839cc/1.8L To 2/1/91	
Seal		223012
Repair Sleeve		KWK99114
1990	1597cc/1.6L, 1839cc/1.8L	
Seal		223012
Repair Sleeve		KWK99114

6 Cylinder

2008-2003	2967cc/3.0L	
Seal		482041N
Repair Sleeve		KWK99187

CRANKSHAFT FRONT SEAL (cont.)

6 Cylinder (cont.)

2002-1992	1844cc/1.8L, 2254cc/2.3L, 2497cc/2.5L	
Seal Viton		2012V
Repair Sleeve		KWK99166

CRANKSHAFT REAR SEAL

4 Cylinder

2005-1990	1489cc/1.5L, 1589cc/1.6L, 1839cc/1.8L	
Seal		228250
Repair Sleeve		KWK99328
2003-1993	2.0L (DOHC)	
Seal		229004
Repair Sleeve		KWK99347
1992-1990	1998cc/2.0L, 2184cc/2.2L	
Seal		229010
Repair Sleeve		KWK99354

6 Cylinder

2008-2003	2967cc/3.0L	
Seal Viton		3909
Repair Sleeve		KWK99362
2002-1992	1844cc/1.8L, 2254cc/2.3L, 2497cc/2.5L	
Seal		1019S
Repair Sleeve		KWK99298

Mfg./Year	Model & Location	Part No.	Mfg./Year	Model & Location	Part No.
MAZDA - REAR DRIVE - MX-5 Miata, RX-7, RX-8, 626, 929					

FRONT WHEEL

FWD

1995-1992	929	
Hub Unit Bearing	513131[2]
1991-1990	929	
Seal	1207N[2]
Ball Bearing	510035[2]

RWD

2009-2006	MX-5 Miata (ABS)	
Hub Unit Bearing	HA590205[2] ²⁵
2009-2006	MX-5 Miata (Non-ABS)	
Hub Unit Bearing	HA590199[2] ²⁵
2008-2004	RX-8	
Hub Unit Bearing	HA590096[2] ²⁵
2005-1991	MX-5 Miata (ABS)	
Hub Unit Bearing	513155[2]
2005-1990	MX-5 Miata (Non-ABS)	
Hub Unit Bearing	513152[2]
1995-1993	RX-7 (ABS)	
Hub Unit Bearing	512118[2]
1991-1990	RX-7	
Seal (Inner)	1975S[2]
Bearing Assy (Inner)	32204[2]
Set (Outer)	SET11[2]

REAR WHEEL

FWD

1995-1992	929	
Ball Bearing	511019[2]
1991-1990	929	
Bearing Assy	513057[2]

RWD

2009-2006	MX-5 Miata	
Ball Bearing	510010[2]
2008-2004	RX-8	
Bearing Assy	WB000007[2] ²⁵
2005-1990	MX-5 Miata	
Seal	1932S[2]
Ball Bearing	510003[2]
1995-1993	RX-7	
Ball Bearing	511019[2]
1992-1990	RX-7	
Seal	225872[2]
Ball Bearing	510010[2]

REAR AXLE

Differential

2005-1990	MX-5 Miata	
Seal Viton	710218[2]
Cone/Cup	XAA32008X-Y32008X[2]
Repair Sleeve	KWK99139[2]
1995-1990	929	
Seal	223840[2]
Repair Sleeve	KWK99147[2]
1992-1990	RX 7 (Exc. Locking Diff.)	
Seal	2007N[2]
Cone/Cup	XAA32008X-Y32008X[2]
Repair Sleeve	KWK99139[2]

REAR AXLE (cont.)

Differential (cont.)

1992-1990	RX 7 (Locking Diff.)	
Seal Viton	710218[2]
Repair Sleeve	KWK99139[2]

Pinion

2005-1990	MX-5 Miata	
Seal	2008S
Bearing Assy (Inner)	32307
Bearing Assy (Outer)	32206M
Repair Sleeve	KWK99128
1995-1993	RX-7	
Bearing Assy (Inner)	32308
Bearing Assy (Outer)	30306M
1995-1990	929	
Bearing Assy (Inner)	32307
Bearing Assy (Outer)	30306M
1992-1990	RX 7 (Exc. Locking Diff.)	
Seal	712010
Bearing Assy (Inner)	32207M
Bearing Assy (Outer)	32206M
Repair Sleeve	KWK99189
1992-1990	RX 7 (Locking Diff.)	
Bearing Assy (Inner)	32207M
Bearing Assy (Outer)	30306M
Ball Bearing	108TB

4-SPEED AUTOMATIC TRANSMISSION

Torque Converter

1997-1990	(L4N71B)	
Seal Viton	2025
Repair Sleeve	KWK99166
1995-1992	(R4AEL)	
Seal	224663
Repair Sleeve	KWK99181
1991		
Seal	1953S
Repair Sleeve	KWK99169

Rear Seal/Ext. Housing

1997-1990	(L4N71B)	
Seal	223801
1995-1993	(R4AEL)	
Seal	710517

CLUTCH

Pilot Bearing

1996-1990	Rotary	
Ball Bearing	152016
1996-1990	(w/o rotary)	
Ball Bearing	202SS

CLUTCH - ROTARY

Release Bearing

1995-1993	1308cc./130L (Turbo)(240mm Cl.)	
Bearing Assy	614164

²⁵New Item, Check For Availability

Mfg./Year Model & Location Part No. Mfg./Year Model & Location Part No.

MAZDA - REAR DRIVE - MX-5 Miata, RX-7, RX-8, 626, 929 (cont.)**CLUTCH - ROTARY (cont.)****Release Bearing (cont.)**

1992-1990	1308cc./130L, 1308cc./130L (Turbo)(230mm Cl.)	
Bearing Assy		614079

CLUTCH - 4 CYLINDER**Release Bearing**

2003-1994	1839cc./1.8L (DOCH)(225mm Cl.)	
Bearing Assy		614120
1993-1990	1597cc./1.6L (200mm Cl.)	
Bearing Assy		614120

5-SPEED MANUAL TRANSMISSION**Front Input Shaft**

1992-1990	(5D)	
Seal		1990
Ball Bearing		306L[2]
Repair Sleeve		KWK99106
1991-1990	(5HC)	
Seal		1990
Ball Bearing		108A[2]
Repair Sleeve		KWK99106

Countershaft

1992-1990	(5E)	
Ball Bearing (Frt)		5205KLE
Ball Bearing (Rr)		304WB
1991-1990	(5HC)	
Ball Bearing (Frt)		5205KLE

Intermediate Shaft

1992-1990	(w/o 5HC)	
Ball Bearing		306L[2]

Rear Output Shaft

1992-1990	(5D)	
Ball Bearing		305AG[2]

5-SPEED AUTOMATIC TRANSAXLE**Output Shaft**

2003-1999		
Seal		3622S[2]
Repair Sleeve		KWK99169[2]

ALTERNATOR

1999-1990	65 Amp.	
Ball Bearing (Drive End)		303CC
Ball Bearing (Rear End)		201CC
1993-1990	Exc. Navajo	
Ball Bearing (Drive End)		303CC

CAMSHAFT SEAL**4 Cylinder**

2005-1990	1597cc/1.6L, 1839cc/1.8L	
Seal (RH)		223420[2]

6 Cylinder

2002-2000	2497cc/2.5L	
Seal		223012
1995-1990	2954/3.0L (DOHC)	
Seal (LH)		226510[2]
Seal (RH)		710338[2]
1991-1990	2954/3.0L (SOHC)	
Seal		1940[2]

CRANKSHAFT FRONT SEAL**Rotary**

1995-1990	1146cc./1.1L, 1308cc./1.3L (225mm Cl.)	
Seal Viton		2025
Repair Sleeve		KWK99169

4 Cylinder

2005-1991	1597cc/1.6L (From 2/2/91), 1839cc/1.8L	
Seal		710355
Repair Sleeve		KWK99145
2002-2000	1991cc/2.0L	
Seal Viton		2012V
1991-1990	1597cc/1.6L (To 2/1/91)	
Seal		223012
Repair Sleeve		KWK99114

6 Cylinder

2002-2000	2497cc/2.5L	
Seal Viton		2012V
1995-1990	2954cc/3.0L	
Seal		224660
Repair Sleeve		KWK99181

CRANKSHAFT REAR SEAL**Rotary**

1995-1990	1146cc./1.1L, 1308cc./1.3L (225mm Cl.)	
Seal Viton		226840

4 Cylinder

2002-1990	1489cc/1.5L, 1597cc/1.6L, 1839cc/1.8L	
Seal		228250
Repair Sleeve		KWK99328

6 Cylinder

1995-1990	2954cc/3.0L	
Seal		1019S
Repair Sleeve		KWK99298

Mfg./Year	Model & Location	Part No.	Mfg./Year	Model & Location	Part No.
MAZDA - SUV, Truck - B2200, B2300, B2500, B2600, B3000, B4000, CX-7, CX-9, MPV, Navajo, Tribute					

FRONT WHEEL

FWD

2009-2008	Tribute, Tribute (Hybrid)	
	Ball Bearing	510072[2]
2009-2007	CX-7	
	Ball Bearing	510063[2]
2009-2007	CX-9	
	Ball Bearing	510063[2]
2006-2001	Tribute	
	Hub Unit Bearing	HA590286K[2] ⁶⁷
	Ball Bearing	510072[2] ²⁵
2006-2000	MPV	
	Seal	1932S[2]
	Ball Bearing	510010[2]
1998-1990	MPV	
	Hub Unit Bearing	513131[2]

RWD

2009-1995	B2300, B2500, B3000, B4000	
	Seal (Inner)	9150S[2]
	Set (Inner)	SET5[2]
	Set (Outer)	SET2[2]
2006-2000	MPV	
	Seal	1932S[2]
	Ball Bearing	510010[2]
1998-1990	MPV	
	Hub Unit Bearing	513131[2]
1994-1992	B2300, B3000, B4000	
	Seal (Inner)	6815[2]
	Set (Inner)	SET6[2]
	Set (Outer)	SET2[2]
1994-1991	Navajo	
	Seal (Inner)	6815[2]
	Set (Inner)	SET6[2]
	Set (Outer)	SET2[2]
1993-1992	B2200, B2600	
	Seal (Inner)	225225[2]
	Set (Inner)	SET5[2]
	Bearing Assy (Outer)	30205M[2]
1991-1990	B2000, B2200, B2600	
	Seal (Inner)	225225[2]
	Set (Inner)	SET5[2]
	Bearing Assy (Outer)	30205M[2]

4WD

2009-2008	Tribute, Tribute (Hybrid)	
	Ball Bearing	510072[2]
2009-2003	B3000, B4000 (4 Whl. ABS)	
	Hub Unit Bearing	SP450202[2]
2009-2001	B3000, B4000 (2 Whl. ABS)(From 6/22/00)	
	Hub Unit Bearing	515014[2]
2004-2001	Tribute	
	Hub Unit Bearing	HA590286K[2] ⁶⁷
	Ball Bearing	510072[2] ²⁵
2002-2000	B3000, B4000 (4 Whl. ABS)(From 6/22/00)	
	Hub Unit Bearing	SP450201[2] ⁴⁰
	Sensor Kit	SK450201[2] ¹⁶
2000	B2000, B3000, B4000 (4 Whl. ABS)	
	Hub Unit Bearing (Thru	

6/21/00)		515027[2]
2000	B3000, B4000 (2 Whl. ABS)	
	Hub Unit Bearing (From 6/22/00)	515014[2]
	Hub Unit Bearing (Thru 6/21/00)	515026[2]
2000-1998	B2500	
	Hub Unit Bearing	515026[2]
1999-1998	B2000, B3000, B4000 (4 Whl. ABS)(Thru 6/21/00)	
	Hub Unit Bearing	515027[2]
1999-1998	B3000, B4000 (2 Whl. ABS)(Thru 6/21/00)	
	Hub Unit Bearing	515026[2]
1998-1997	MPV	
	Ball Bearing	510053[2]
1998-1997	MPV	
	Ball Bearing	510053[2]
1997-1994	B4000	
	Seal (Inner)	4250[2]
	Set (Inner)	SET37[2]
	Set (Outer)	SET37[2]
1996-1994	B2300, B3000	
	Seal (Inner)	8312S[2]
	Set (Inner)	SET45[2]
	Set (Outer)	SET45[2]
1996-1990	MPV	
	Seal (Inner)	1932S[2]
	Ball Bearing (Inner)	510010[2]
	Seal (Outer)	710225[2]
1995-1990	MPV	
	Seal (Inner)	1932S[2]
	Ball Bearing (Inner)	510010[2]
	Seal (Outer)	710225[2]
1994-1991	Navajo	
	Seal (Inner)	4250[2]
	Set (Inner)	SET37[2]
	Set (Outer)	SET37[2]
1993-1990	B2600	
	Seal (Inner)	710094[2]
	Set (Inner)	SET47[2]
	Seal (Outer)	710093[2]
	Set (Outer)	SET11[2]

AWD

2009-2007	CX-7	
	Ball Bearing	510063[2]
2009-2007	CX-9	
	Ball Bearing	510063[2]
2006-2005	Tribute	
	Hub Unit Bearing	HA590286K[2] ⁶⁷
	Ball Bearing	510072[2] ²⁵

REAR WHEEL

FWD

2009-2008	Tribute, Tribute (Hybrid)	
	Ball Bearing	510029[2]
2009-2007	CX-7	
	Hub Unit Bearing	HA590195[2] ²⁵
2009-2007	CX-9	
	Hub Unit Bearing	HA590041[2] ²⁵

¹⁶Obsolete Snap Ring

²⁵New Item, Check For Availability

⁴⁰5 Stud.

⁶⁷Kit = Flg, Brg, Nut, &

Mfg./Year	Model & Location	Part No.	Mfg./Year	Model & Location	Part No.
-----------	------------------	----------	-----------	------------------	----------

MAZDA - SUV, Truck - B2200, B2300, B2500, B2600, B3000, B4000, CX-7, CX-9, MPV, Navajo, Tribute (cont.)

REAR WHEEL (cont.)

FWD (cont.)

2006-2001	Tribute	
	Ball Bearing	510029[2]
2006-2000	MPV (ABS)	
	Hub Unit Bearing	513131[2]
2006-2000	MPV (Non-ABS)	
	Hub Unit Bearing	512270[2] ²⁵
1998-1996	MPV	
	Seal	710320[2]
	Ball Bearing	511027[2]

RWD

2009-1994	B2300	
	Seal	8660S[2]
	Cylindrical Bearing	5707[2]
	Bearing & Seal Kit	TRP1563TAV[2] ¹⁹
2009-1994	B3000	
	Seal	8660S[2]
	Cylindrical Bearing	5707[2]
	Bearing & Seal Kit	TRP1563TAV[2] ¹⁹
2009-1994	B4000	
	Seal	8835S[2]
	Cylindrical Bearing	6408[2]
	Bearing & Seal Kit	TRP1563TAV[2] ¹⁹
2006-2004	MPV (Disc)	
	Hub Unit Bearing	513131[2]
2006-2000	MPV (Drum)	
	Hub Unit Bearing	
	(Non-ABS)	512270[2] ²⁵
	Hub Unit Bearing	
	(ABS)	513131[2]
2001-1998	B2500	
	Seal	8660S[2]
	Cylindrical Bearing	5707[2]
	Bearing & Seal Kit	TRP1563TAV[2] ¹⁹
1998-1996	MPV	
	Ball Bearing	511027[2]
	Seal	710320[2]
1998-1990	MPV (Drum)	
	Seal (Inner)	224820[2]
	Ball Bearing (Inner)	307FF[2]
	Seal (Outer)	710150[2]
1994-1991	Navajo	
	Seal	8835S[2]
	Cylindrical Bearing	6408[2]
	Bearing & Seal Kit	TRP1559TV[2] ¹⁹
1993-1990	B2200	
	Seal (Inner)	223550[2]
	Bearing Assy (Inner)	30208M[2]
	Seal (Outer)	1994[2]
1993-1990	B2600	
	Seal (Inner)	223550[2]
	Bearing Assy (Inner)	30208M[2]
	Seal (Outer)	1994[2]

4WD

2009-2008	Tribute, Tribute (Hybrid)	
	Ball Bearing	510029[2]

REAR WHEEL (cont.)

4WD (cont.)

2009-1994	B2300	
	Seal	8660S[2]
	Cylindrical Bearing	5707[2]
	Bearing & Seal Kit	TRP1563TAV[2] ¹⁹
2009-1994	B3000	
	Seal	8660S[2]
	Cylindrical Bearing	5707[2]
	Bearing & Seal Kit	TRP1563TAV[2] ¹⁹
2009-1994	B4000	
	Seal	8835S[2]
	Cylindrical Bearing	6408[2]
	Bearing & Seal Kit	TRP1559TV[2] ¹⁹
2004-2001	Tribute	
	Ball Bearing	510029[2]
2001-1998	B2500	
	Seal	8660S[2]
	Cylindrical Bearing	5707[2]
	Bearing & Seal Kit	TRP1563TAV[2] ¹⁹
1998-1996	MPV	
	Seal	710320[2]
	Ball Bearing	511027[2]
1995-1990	MPV	
	Seal (Inner)	224820[2]
	Seal (Outer)	710150[2]
1993-1990	B2200	
	Seal (Inner)	223550[2]
	Bearing Assy (Inner)	30208M[2]
	Seal (Outer)	1994[2]
1993-1990	B2600	
	Seal (Inner)	223550[2]
	Bearing Assy (Inner)	30208M[2]
	Seal (Outer)	1994[2]

AWD

2009-2007	CX-7	
	Hub Unit Bearing	HA590193[2] ²⁵
2009-2007	CX-9	
	Hub Unit Bearing	HA590056[2] ²⁵
2006-2005	Tribute	
	Ball Bearing	510029[2]

4WD FRONT AXLE

Axle Shaft

2006-2001	Tribute	
	Seal Viton	710429[2]

Differential Rebuild Kit

2007-1998	(Dana/Spicer 35IFS Axle)	
	Kit	DRK335
1997-1991	(Dana/Spicer 28IFS Axle)	
	Kit	DRK333

¹⁹Opt. Axle Rpr Brg. Replaces O.E. Brg & Seal

²⁵New Item, Check For Availability

Mfg./Year	Model & Location	Part No.	Mfg./Year	Model & Location	Part No.
MAZDA - SUV, Truck - B2200, B2300, B2500, B2600, B3000, B4000, CX-7, CX-9, MPV, Navajo, Tribute (cont.)					

4WD FRONT AXLE

Differential

2007-1998 (Dana/Spicer 35IFS Axle)	
Cone/Cup	LM501349-LM501314[2]
1997-1991 (Dana/Spicer 28IFS Axle)	
Cone/Cup	LM29749-LM29710[2]

Pinion

2007-1991	
Seal Viton (Dana/Spice 35 Axle)	714675
Seal (Dana/Spicer 28 Axle)	4244
Cone/Cup (Inner) (Dana/Spicer 35 Axle)	HM88648-HM88610
Cone/Cup (Inner) (Dana/Spicer 28 Axle)	M88048-M88010
Cone/Cup (Outer) (All)	M86649-M86610
1998-1995 MPV	
Seal	712011
Bearing Assy (Inner)	32207M
Bearing Assy (Outer)	32206M

Spindle Kit

1998-1991 (Dana/Spicer 35IFS Axle)	
Bearing & Seal Kit	SBK4[2] ³⁶
1997-1994 (Dana/Spicer 28IFS Axle)	
Bearing & Seal Kit	SBK2[2] ³⁴

Spindle

1997-1993 (Dana/Spicer 28IFS, 35IFS axle)	
Seal (Inner)	710453[2]
Ndle Bearing (Inner)	B2110[2]
Seal (Outer)	722108[2]
Ndle Bearing Thrust (Outer)	NTA1625[2]
1996-1994 (Dana/Spicer 28IFS Axle)	
Seal (Inner)	8314S[2]
Ndle Bearing (Inner)	SCE188[2]
Seal (Outer)	340836[2]

REAR AXLE

Axle Shaft

2008-2001	
Seal Viton	710429[2]

Differential Rebuild Kit

2007-1994 Ford (7.5" R.G.)	
Kit	DRK315
2007-1991 Ford (8.8" R.G.)	
Kit	DRK311

Differential

2008-2001 Tribute	
Cone/Cup	LM29749-LM29710[2]
2007-2003 Ford (7.5" R.G.)	
Cone/Cup	LM29749-LM29710[2]
2007-1991 Ford (8.8" R.G.)	
Set	SET36[2]

REAR AXLE (cont.)

Differential (cont.)

2002-1994 Ford (7.5" R.G.)	
Cone/Cup	LM501349-LM501314[2]
1993-1990 (Exc. Ford Axle)	
Bearing Assy	32008XM[2]

Pinion

2008-2001 Tribute	
Cone/Cup (Inner)	M86649-M86610
Cone/Cup (Outer)	M88048-M88010
Seal	100552
2007-1991 (Ford 7.5", 8.8" R.G. Axles)	
Seal Viton	3604
Cone/Cup (Inner)	M802048-M802011
Cone/Cup (Outer)	M88048-M88010
1998-1990 B2600, MPV	
Seal	712011
Bearing Assy (Inner)	30307M
Bearing Assy (Outer)	30306M
Repair Sleeve	KWK99157
1993-1990 B2000, B2200	
Seal	1216N
Bearing Assy (Inner)	32307
Bearing Assy (Outer)	32206M
Repair Sleeve	KWK99157

TRANSFER CASE REBUILD KIT

2003-1991 (MPV)	
Kit	TRKFMZ230
1996-1990 Pickup	
Kit	TRKFMZ220

TRANSFER CASE

Input Shaft

2008-1993 (Warner 1354)	
Seal	710403
Ball Bearing	109L
Ndle Bearing (Pilot)	M18161
Repair Sleeve	KWK99166
1998-1990 (R5MX)	
Seal	710284
Repair Sleeve	KWK99157
1993-1990 (R5MXD)	
Ball Bearing	209BB
1992-1991 (Warner 1354)	
Seal	4143
Ball Bearing	109L
Ndle Bearing (Pilot)	M18161

Front Output Shaft

2008-1993 (Warner 1354)	
Seal	710403
Ball Bearing	206WB[2]
Repair Sleeve	KWK99166
1998-1990 (R5MX)	
Seal	710283
1993-1990 (R5MXD)	
Ball Bearing	309

³⁴Opt. Kit = Brg SCE148, Seal 8314S

³⁶Opt. Kit = Brg B2110, Seals 722108 & 722109, & Ring

Mfg./Year	Model & Location	Part No.	Mfg./Year	Model & Location	Part No.
-----------	------------------	----------	-----------	------------------	----------

MAZDA - SUV, Truck - B2200, B2300, B2500, B2600, B3000, B4000, CX-7, CX-9, MPV, Navajo, Tribute (cont.)

TRANSFER CASE (cont.)

Front Output Shaft (cont.)

1992-1991 (Warner 1354)	
Seal	4143
Ball Bearing	206WB[2]

Rear Output Shaft

2007-1993 (Warner 1354)	
Seal	710403
Ball Bearing	206WB
Repair Sleeve	KWK99166
Ndle Bearing (Pilot)	JH1612
1993-1990 (R5MXD)	
Ball Bearing	106WB
1992-1991 (Warner 1354)	
Seal	4143
Ball Bearing	206WB
Ndle Bearing (Pilot)	JH1612

Selector Shaft Seal/Man. Shaft

2007-1991 (Warner 1354)	
Seal	330385

4-SPEED AUTOMATIC TRANSMISSION

Torque Converter

1999-1990 (Jatco R4AEL)	
Seal	224663
Repair Sleeve	KWK99181
1997-1991 (A4LD)	
Seal	2658
1995-1990 (Jatco N4A, L4N71B)	
Seal Viton	2025
Repair Sleeve	KWK99166

Rear Seal/Ext. Housing

2002-1991 (4R44E, A4LD)	
Seal	2655

Selector Shaft Seal/Man. Shaft

2002-1991 (4R44E, A4LD)	
Seal	7929S

5-SPEED AUTOMATIC TRANSMISSION

Rear Seal/Ext. Housing

2002-1997 (Ford 5R55E)	
Seal	2655

Selector Shaft Seal/Man. Shaft

2008-1997 (Ford 5R55E)	
Seal	7929S

CLUTCH

Pilot Bearing

2002-1994 4 Cyl. 2.0L, 2.3L, 2.5L	
Ndle Bearing	FC65354
2002-1994 6 Cyl. 3.0	
Ndle Bearing	FC65354
2002-1991 6 Cyl. 4.0	
Ndle Bearing	F33126
1991-1990 6 Cyl. 3.0	
Ball Bearing	202SS

Release Bearing

1998 B2500 truck (Hyd. Mechanism)	
Bearing Assy	614169
1998-1994 B3000 truck (Hyd. Mechanism)	
Bearing Assy	614169
1998-1993 B4000 truck (Hyd. Mechanism)	
Bearing Assy	614169
1995-1994 B2300 truck (Hyd. Mechanism)	
Bearing Assy	614169
1993-1990 B2600	
Bearing Assy	614079
1993-1990 B2200	
Bearing Assy	614079

5-SPEED MANUAL TRANSMISSION

Transmission Rebuild Kit

2003-1990 B5V	
Kit	TRKFMZ210
2002-1990 (M5R1)	
Kit	TRK247
1993-1990 B2600 pickup	
Kit	TRKFMZ210
1993-1990 B2200 (Dbl. Ball Frt. C/S Brg.)	
Kit	TRKFMZ200
1990 B2200 (Single Ball Frt. C/S Brg.)	
Kit	TRKFMZ120

Front Input Shaft

2002-1994 (M5R1)	
Seal	1990
Repair Sleeve	KWK99106
1993-1990 (5HC)	
Seal	1990
Ball Bearing	108A[2]
Repair Sleeve	KWK99106
1993-1990 (5E, 5TB)	
Seal	1990
Ball Bearing	306L[2]
Repair Sleeve	KWK99106

Countershaft

1993-1990 (5HC)	
Ball Bearing (Frt)	5205KLE[2]
1993-1990 (5E, 5TB)	
Ball Bearing (Frt)	5205KLE[2]
Ball Bearing (Rr)	304WB[2]

Mfg./Year Model & Location Part No. Mfg./Year Model & Location Part No.

MAZDA - SUV, Truck - B2200, B2300, B2500, B2600, B3000, B4000, CX-7, CX-9, MPV, Navajo, Tribute (cont.)

5-SPEED MANUAL TRANSMISSION

Intermediate Shaft

1993-1990 (5E, 5TB)
Ball Bearing306L[2]

Rear Output Shaft

2002-1994 (M5R1)(2WD)
Seal7692S
2002-1994 (M5R1)(4WD)
Seal1981
1993-1990 (5D)
Seal2443
Ball Bearing305AG[2]

4-SPEED AUTOMATIC TRANSAXLE

Output Shaft

2001-2000 (GF4A-EL)
Seal (LH)223543
Seal (RH)2007N
Repair SleeveKWK99139

5-SPEED AUTOMATIC TRANSAXLE

Output Shaft

2002-2001 (C4DE)
Seal (LH)3622S
Repair SleeveKWK99169

5-SPEED MANUAL TRANSAXLE

Input Shaft

2002-2001 (G5M)
Seal1990
SetSET32[2]
Repair SleeveKWK99106

Output Shaft

2002-2001 (G5M)
Seal2007N[2]
Repair SleeveKWK99139

ALTERNATOR

1993-1990 Exc. Navajo
Ball Bearing (Drive End)303CC

DRIVESHAFT SUPPORT

1995-1990 (.9843" Brg. I.D.)
Ball Bearing205F[2]
1994 B2300
Hanger Bearing AssyHBD206FF[2]
1994 B3000
Hanger Bearing AssyHBD206FF[2]
1994 B4000
Hanger Bearing AssyHBD206FF[2]
1992-1990 B2200
Hanger Bearing AssyHB29[2]

POWER STEERING

Input Shaft

2002-1995 B2300, B3000, B4000
Seal471645
Ndle BearingFC65753[2]

Pump Shaft

2002 B2300
Seal8773S
2002 B3000, B4000 (Ford Pump)
Seal8773S

MANUAL STEERING

Sector Shaft

1995-1994 B2300
Seal223010

Worm Shaft

1995-1994 B2300
Seal221922

OIL PUMP

6 Cylinder

1998-1990 2954/3.0L
Seal710264

CAMSHAFT SEAL

4 Cylinder

2001-2000 2492cc/2.5L
Seal2955

CRANKSHAFT FRONT SEAL

4 Cylinder

2004-2001 121/2.0L (DOHC), 140/2.3L (DOHC)
Seal3771
Repair SleeveKWK99139
2001-1994 140/2.3L, 150/2.5L
Seal2955
1995-1990 2606cc/2.6L
Seal224460
Repair SleeveKWK99181
1993-1990 1998cc/2.0L, 2184cc/2.2L
Seal223420

6 Cylinder

2007-2000 155/2.5L (DOHC), 181/3.0L (DOHC)
Seal482041N
Repair SleeveKWK99187
2007-1994 2954/3.0L
Seal (Frt Entry)2692
Seal (Rr Entry)2942
Repair SleeveKWK99187
2004-1991 244/4.0L
Seal473560N
Repair SleeveKWK99166

Mfg./Year Model & Location Part No. Mfg./Year Model & Location Part No.

MAZDA - SUV, Truck - B2200, B2300, B2500, B2600, B3000, B4000, CX-7, CX-9, MPV, Navajo, Tribute (cont.)

CRANKSHAFT FRONT SEAL (cont.)

6 Cylinder (cont.)

1993-1990 2954cc/3.0L
 Seal 224660
 Repair Sleeve KWK99181

CRANKSHAFT REAR SEAL

4 Cylinder

2005-1994 2.0L, 2.3L, 2.5L
 Seal Viton 3909
 Seal PTFE H/D 5277
 Repair Sleeve KWK99363
 1998-1990 2555cc/2.6L
 Seal Viton 228005
 Repair Sleeve KWK99315
 1995-1990 1998cc/2.0L, 2184cc/2.2L,
 2606cc/2.6L
 Seal 229010
 Repair Sleeve KWK99354

6 Cylinder

2008-1991 4016/4.0L
 Seal Viton 3393
 Seal PTFE H/D 5288
 Repair Sleeve KWK99237
 2007-1994 3.0 6 Cyl.
 Seal 3772

CRANKSHAFT REAR SEAL (cont.)

6 Cylinder (cont.)

2006-2000 2.5L, 3.0 L
 Seal Viton 3909
 Seal PTFE H/D 5277
 Repair Sleeve KWK99362
 1993-1990 2954cc/3.0L
 Seal 1019S
 Repair Sleeve KWK99298

MERCEDES BENZ - 100 SERIES

FRONT WHEEL

RWD

1993-1990 100 Ser. (Exc. 2.3L 16 Valve)
 Set (Inner) SET6[2]
 Set (Outer) SET1[2]

REAR WHEEL

RWD

1993-1990 100 Ser.
 Ball Bearing 513130[2]

DRIVESHAFT SUPPORT

1993-1990
 Ball Bearing 105CC

MERCEDES BENZ - 200 SERIES

FRONT WHEEL

RWD

2007-1994
 Seal (Inner) SL260011[2]
 Set (Inner) SET17[2]
 Set (Outer) SET12[2]

FRONT WHEEL

AWD

2009-2003
 Ball Bearing 513130[2]

Mfg./Year Model & Location Part No. Mfg./Year Model & Location Part No.

MERCEDES BENZ - 200 SERIES (cont.)

REAR WHEEL

RWD

2007-1994 C220, C230, C240, C240
4-MATIC, C280, C280
4-MATIC, SLK230, SLK280
Ball Bearing 513130[2]

DRIVESHAFT SUPPORT

1997-1994 (25mm bearing)
Ball Bearing 105CC
1997-1994 (30mm bearing)
Ball Bearing 106CC

MERCEDES BENZ - 300 SERIES

FRONT WHEEL

RWD

2007-2003 CLK320, CLK350, C32 AMG,
C320, C320 4-MATIC, C350,
C350 4MATIC, SLK32 AMG,
SLK320, SLK350
Seal (Inner) SL260011[2]
Set (Inner) SET17[2]
Set (Outer) SET12[2]
2007-2003 E320, E350
Cone/Cup (Inner) XAA32008X-Y32008X[2]
Set (Outer) SET12[2]
2002-1996 CLK320, C32 AMG, C320, C36
AMG, E320, SLK32 AMG,
SL320, SLK320
Seal (Inner) SL260011[2]
Set (Inner) SET17[2]
Set (Outer) SET12[2]
1999-1996 E300
Cone/Cup (Inner) XAA32008X-Y32008X[2]
Set (Outer) SET2[2]
1999-1992 S320, S350, 300SD, 300SE,
300SEL
Cone/Cup (Inner) XAA32008X-Y32008X[2]
Bearing Assy (Outer) 33205[2]
1995 E300
Set (Inner) SET17[2]
Set (Outer) SET2[2]
1995-1993 300D, E, TE, E320 Sedan,
300CE Sedan
Set (Inner) SET6[2]
Set (Outer) SET2[2]
1995-1993 E320, 300CE Convertible
Set (Inner) SET17[2]
Set (Outer) SET12[2]
1995-1990 C36, SL320, 300SL
Seal (Inner) SL260011[2]
Set (Inner) SET17[2]
Set (Outer) SET12[2]
1992-1990 300CE, D, E, TD, TE
Set (Inner) SET6[2]
Set (Outer) SET2[2]

FRONT WHEEL (cont.)

RWD (cont.)

1991-1990 300CDT, SD, SDL, SE, SEL,
350SD, SDL
Seal (Inner) 1960[2]
Set (Inner) SET5[2]
Set (Outer) SET3[2]

AWD

2009-2007 E Class
Ball Bearing 510083[2]
2009-2000 C Class
Ball Bearing 513130[2]

REAR WHEEL

RWD

2006 S350
Ball Bearing 510083[2]
2005-2003 CLK320, C32 AMG, C320,
SLK32 AMG, SLK320, SLK350
Ball Bearing 513150[2]
2002-1992 300 Ser. (Exc. Convertible)
Ball Bearing 513130[2]
1999-1998 E320 (Wagon)
Ball Bearing 510083[2]
1993-1990 300TE
Bearing Assy JXC25469C-92UA3[2]
1991-1990 300CE, 300D, 300E, 300SL,
300TD, 350SDL
Ball Bearing 513130[2]
1991-1990 300SDL, 300SE, 300SEL
Seal (Inner) 1174S[2]
Cone/Cup (Inner) LM300849-LM300811[2]
Cone/Cup (Outer) LM503349A-LM503310[2]

DRIVESHAFT SUPPORT

1997-1994
Ball Bearing 106CC
1993-1990
Ball Bearing 106CC

Mfg./Year Model & Location Part No. Mfg./Year Model & Location Part No.

MERCEDES BENZ - 400 SERIES**FRONT WHEEL****RWD**

2003-1998	CLK430, C43, E430	
	Seal (Inner)	SL260011[2]
	Set (Inner)	SET17[2]
	Set (Outer)	SET12[2]
1997-1992	S420, 400SE, 400SEL	
	Cone/Cup (Inner)	XAA32008X-Y32008X[2]
	Bearing Assy (Outer)	33205[2]
1995-1992	400E, E420	
	Set (Inner)	SET17[2]
	Set (Outer)	SET12[2]
1991-1990		
	Seal (Inner)	1960[2]
	Set (Inner)	SET5[2]
	Set (Outer)	SET3[2]

AWD

2006-2003	E Class	
	Ball Bearing	510083[2]
2002-2000	E Class	
	Ball Bearing	513130[2]

REAR WHEEL**RWD**

2003-1999	CLK430, C43	
	Ball Bearing	513130[2]
1997-1992		
	Ball Bearing	513130[2]

REAR WHEEL (cont.)**RWD (cont.)**

1991-1990		
	Seal (Inner)	1174S[2]
	Cone/Cup (Inner)	LM300849-LM300811[2]
	Cone/Cup (Outer)	LM503349A-LM503310[2]

DRIVESHAFT SUPPORT**1997-1990**

Ball Bearing	106CC
--------------------	-------

MERCEDES BENZ - 500 SERIES**FRONT WHEEL****RWD**

2005	SLK55 AMG	
	Set (Inner)	SET17[2]
	Set (Outer)	SET12[2]
2005-2004	E500, E55, SL500, SL55	
	Bearing Assy (Inner)	32008XM[2]
	Set (Outer)	SET12[2]
2005-2004	G500, G55	
	Bearing Assy (Inner)	32010X[2]
	Bearing Assy (Outer)	32011XM[2]
2002-2000	CL500, CLK500, CL55 AMG, CLK55 AMG, E500, 500E, SL500, 500SL, SLK55 AMG	
	Seal (Inner)	SL260011[2]
	Set (Inner)	SET17[2]
	Set (Outer)	SET12[2]
1999-1992	S500, 500SEC, 500SEL	
	Cone/Cup (Inner)	XAA32008X-Y32008X[2]
	Bearing Assy (Outer)	33205[2]
1997-1990	E500, SL500, 500E, 500SL	
	Seal (Inner)	SL260011[2]
	Set (Inner)	SET17[2]
	Set (Outer)	SET12[2]
1991-1990	500SEC, 500SEL, 560SEC, 560SEL	
	Set (Inner)	SET5[2]
	Set (Outer)	SET3[2]

AWD

2006-2003	E & S Class	
	Ball Bearing	510083[2]

REAR WHEEL**RWD**

2005-1992	CL500, CLK500, CL55 AMG, CLK55 AMG, E500, 500E, SL500, 500SL, SLK55 AMG	
	Ball Bearing	513130[2]
1991-1990	500SL	
	Ball Bearing	513130[2]
1991-1990	500SEC, 500SEL, 560SEC, 560SEL, 560SL	
	Seal (Inner)	1174S[2]
	Cone/Cup (Inner)	LM300849-LM300811[2]
	Cone/Cup (Outer)	LM503349A-LM503310[2]

DRIVESHAFT SUPPORT**1997-1990**

Ball Bearing	106CC
--------------------	-------

Mfg./Year	Model & Location	Part No.	Mfg./Year	Model & Location	Part No.
-----------	------------------	----------	-----------	------------------	----------

MERCEDES BENZ - 600 SERIES

FRONT WHEEL

RWD

2005-2004	SL600	
	Bearing Assy (Inner)	32008XM[2]
	Set (Outer)	SET12[2]
2002-1993	600SL, SL600	
	Seal (Inner)	SL260011[2]
	Set (Inner)	SET17[2]
	Set (Outer)	SET12[2]
1999-1992	600SEL, CL600, S600	
	Bearing Assy (Inner)	32008XM[2]
	Bearing Assy (Outer)	33205[2]

REAR WHEEL

RWD

2005-2001	CL600, CL65 AMG	
	Ball Bearing	513130[2]
1998-1993	600SL, SL600	
	Ball Bearing	513130[2]

DRIVESHAFT SUPPORT

1997-1992	
	Ball Bearing 106CC

MERCEDES BENZ - <ALL Non-Wheel End Systems>

REAR AXLE

Differential

1997-1994	500 Ser.	
	Cone/Cup	387AS-382A[2]
1997-1992	600 Ser.	
	Cone/Cup	387AS-382A[2]
1993-1992	400SEL, 400SE	
	Cone/Cup	387AS-382A[2]
1993-1990	400E, 420SEL	
	Cone/Cup	LM806649-LM806610[2]
1993-1990	500 Ser.	
	Cone/Cup	LM806649-LM806610[2]

Pinion

1997-1992	600 Ser.	
	Cone/Cup (Inner)	HM803149-HM803110
	Cone/Cup (Outer)	HM88649-HM88610
1997-1990	500 Ser.	
	Cone/Cup (Inner)	HM803149-HM803110
	Cone/Cup (Outer)	HM88649-HM88610
1993-1992	400SEL, 400SE	
	Cone/Cup (Inner)	HM803149-HM803110
	Cone/Cup (Outer)	HM88649-HM88610
1993-1990	400E, 420SEL	
	Cone/Cup (Inner)	M802048-M802011
	Cone/Cup (Outer)	M86649-M86610
1993-1990	190 Ser.	
	Cone/Cup (Inner)	HM88649-HM88610
	Cone/Cup (Outer)	M84548-M84510

CLUTCH

Release Bearing

1991-1990	260E	
	Bearing Assy	614125
1991-1990	190 Ser.	
	Bearing Assy	614125

CLUTCH (cont.)

Release Bearing (cont.)

1991-1990	300 Ser.	
	Bearing Assy	614125
1991-1990	280SE, (W126 Ch.)	
	Bearing Assy	614125
1990	240D, TD	
	Bearing Assy	614125

ALTERNATOR

1992-1990	(Bosch 90 Amp.)	
	Ball Bearing (Drive End)	303CC
1992-1990	(Bosch 55 Amp.)	
	Ball Bearing (Drive End)	303CC
	Ball Bearing (Rear End)	201S
1992-1990	(Bosch 65 Amp.)	
	Ball Bearing (Drive End)	303CC
	Ball Bearing (Rear End)	201CC
1992-1990	(Bosch 70 Amp.)	
	Ball Bearing (Drive End)	303CC
	Ball Bearing (Rear End)	201CC
1992-1990	(Motorola 55 Amp.)	
	Ball Bearing (Drive End)	203FF
1990	(Bosch 80 Amp.)	
	Ball Bearing (Drive End)	303CC

CRANKSHAFT FRONT SEAL

4 Cylinder

2004-2003	1796cc./1.8L	
	Seal	710289
	Repair Sleeve	KWK99177
2003-1994	2199cc/2.2L, 2295cc/2.3L	
	Seal	710289
	Repair Sleeve	KWK99177
1993-1991	2298cc/2.3L	
	Seal	710289
	Repair Sleeve	KWK99177

MERCEDES BENZ - <ALL Non-Wheel End Systems> (cont.)

CRANKSHAFT FRONT SEAL

6 Cylinder

1999-1994 2799cc/2.8L, 26966cc/3.0L (Dsl.), 3199cc/3.2L (DOHC)
 Seal 710289
 Repair Sleeve KWK99177
 1993-1990 2599cc/2.6L, 2797cc/2.8L, 2962cc/3.0L, 2997cc/3.0L, 3199cc/3.2L
 Seal 710289
 Repair Sleeve KWK99177

8 Cylinder

2001-1990 4196cc/4.2L(DOHC), 4973/5.0L(DOHC)
 Seal 710289
 Repair Sleeve KWK99177

12 Cylinder

1994-1992 5987cc/6.0L
 Seal 710289
 Repair Sleeve KWK99177

CRANKSHAFT REAR SEAL

4 Cylinder

2003-1994 1796cc/1.8L, 2197cc/2.2L, 2295cc/2.3L
 Seal 710288

6 Cylinder

1999-1990 2599cc/2.6L, 2797cc/2.8L, 2962cc/3.0L, 2997cc/3.0L, 3199cc/3.2L
 Seal 710288

CRANKSHAFT REAR SEAL

8 Cylinder

2008-1990 4966cc/5.0L, 4973cc/5.0L, 5547cc/5.6L
 Seal Viton 710290
 Repair Sleeve KWK99393
 1999-1995 4196cc/4.2L
 Seal Viton 710290
 Repair Sleeve KWK99393

12 Cylinder

1999-1992 5987cc/6.0L
 Seal 710288

MERCEDES BENZ - SUV - G500, ML320, ML350, ML500, ML55 AMG

FRONT WHEEL

4WD

2006-1998 ML Series
 Ball Bearing 510083[2]
 2005-2002 G500, G55
 Bearing Assy (Inner) 32010X[2]
 Bearing Assy (Outer) 32011XM[2]

REAR WHEEL

RWD

2008-1998 G500, G55
 Seal 710468[2]
 Bearing Assy 516010[2]²⁵
 2005-1998 ML Series
 Ball Bearing 510083[2]

²⁵New Item, Check For Availability

Mfg./Year	Model & Location	Part No.	Mfg./Year	Model & Location	Part No.
-----------	------------------	----------	-----------	------------------	----------

MERCURY - FRONT DRIVE - Capri

FRONT WHEEL

FWD

1994-1991	
Seal (Inner)	4990[2]
Seal (Outer)	710323[2]
Set	SET11[2]

REAR WHEEL

FWD

1994-1991	
Seal (Inner)	1213N[2]
Set (Inner)	SET8[2]
Set (Outer)	SET2[2]

CLUTCH

Pilot Bearing

1994-1991	
Ball Bearing	202SS

Release Bearing

1994-1991 (Exc. Turbo)	
Bearing Assy	614128
1994-1991 (Turbo)	
Bearing Assy	614079

4-SPEED AUTOMATIC TRANSAXLE

Differential

1992-1991 (4HAT G)	
Bearing Assy	32009XM[2]

Torque Converter / Frt Pump

1992-1991 (4HAT G)	
Seal	710446[2]

Input Shaft

1994-1991	
Seal	710446
Repair Sleeve	KWK99266

Output Shaft

1994-1991 (4HAT G)	
Seal (LH)	223543
Seal (RH)	2007N
Repair Sleeve	KWK99139[2]

5-SPEED MANUAL TRANSAXLE

Differential

1994-1991 (Exc. Turbo)	
Set	SET17[2]
1994-1991 (Turbo)	
Bearing Assy	32008XM[2]

5-SPEED MANUAL TRANSAXLE

Input Shaft

1994-1991 (Exc. Turbo)	
Seal	222430[2]
Repair Sleeve	KWK99098
1994-1991 (Turbo)	
Seal (Outer)	1990[2]
Set (Outer)	SET32[2]
Repair Sleeve	KWK99106

Output Shaft

1994-1991	
Seal (LH)	223543
Seal (RH)	2007N
Repair Sleeve	KWK99139[2]

ALTERNATOR

1994-1991 (Bosch 85 Amp.)	
Ball Bearing (Drive End)	303CC
1994-1991 (Bosch 85 Amp.)	
Ball Bearing (Rear End)	201S
1994-1991 (Mitsubishi 70 Amp.)	
Ball Bearing (Drive End)	303CC

CAMSHAFT SEAL

4 Cylinder

1994-1991 1597cc/1.6L	
Seal	223420[2]

CRANKSHAFT FRONT SEAL

4 Cylinder

1994-1991 1597cc/1.6L, (From 12/1/90)	
Seal	710355
1991 1597cc/1.6L, (Thru 12/1/90)	
Seal	223012
Repair Sleeve	KWK99114

CRANKSHAFT REAR SEAL

4 Cylinder

1994-1991 1597cc/1.6L, (From 12/1/90)	
Seal	228250
Repair Sleeve	KWK99328

Mfg./Year Model & Location Part No. Mfg./Year Model & Location Part No.

MERCURY - FRONT DRIVE - Cougar

FRONT WHEEL

FWD

2002-1999
Ball Bearing 510029[2]

REAR WHEEL

FWD

2002-1999
Hub Unit Bearing 512024[2]

5-SPEED AUTOMATIC TRANSAXLE

Output Shaft

2002-1999
Seal 3622S[2]
Repair Sleeve KWK99169[2]

CAMSHAFT SEAL

4 Cylinder

2002-1999 121/2.0L (DOHC)
Seal 3774S

6 Cylinder

2002-1999 2450cc/2.5L
Seal 471651
Repair Sleeve KWK99106

CRANKSHAFT FRONT SEAL

4 Cylinder

2002-1999 121/2.0/L (DOHC)
Seal Viton 713771
Repair Sleeve KWK99139

CRANKSHAFT FRONT SEAL

6 Cylinder

2002-1999 155/2.5L
Seal 482041N
Repair Sleeve KWK99187

CRANKSHAFT REAR SEAL

4 Cylinder

2002-1999 121/2.0L
Seal 3772
Seal PTFE H/D (Opt) 5287

6 Cylinder

2002-2000 2450cc/2.5L
Seal Viton 3909
Seal PTFE H/D (Opt) 5277
Repair Sleeve KWK99363

MERCURY - FRONT DRIVE - Mystique

FRONT WHEEL

FWD

2000-1995
Ball Bearing 510029[2]

REAR WHEEL

FWD

2000-1995
Hub Unit Bearing 512024[2]

CLUTCH

Release Bearing

2000-1995
Bearing Assy 614128

4-SPEED AUTOMATIC TRANSAXLE

Differential

2000-1995 (4EAT F)
Set SET17[2]

4-SPEED AUTOMATIC TRANSAXLE

(cont.)

Differential (cont.)

2000-1995 (AX4, AXOD)
Ball Bearing 208[2]
1997-1995 (4EAT G)
Bearing Assy 32008XM[2]

Torque Converter / Frt Pump

2000-1995 (4EAT G, 4HAT G)
Seal 710446
2000-1995 (AX4, AXOD)
Seal 4189H
2000-1995 (CD4E)
Seal 4635V

Mfg./Year Model & Location Part No. Mfg./Year Model & Location Part No.

MERCURY - FRONT DRIVE - Mystique (cont.)

4-SPEED AUTOMATIC TRANSAXLE

Output Shaft

- 2000-1995 (4EAT G, 4HAT G)
 - Seal (LH) 223543
 - Seal (RH) 2007N
 - Repair Sleeve KWK99139[2]
- 2000-1995 (AX4, AXOD)
 - Seal 3622S[2]
 - Repair Sleeve KWK99169[2]

5-SPEED MANUAL TRANSAXLE

Differential

- 2000-1995 (Mazda F52)
 - Set SET17[2]

Input Shaft

- 2000-1995 (Mazda F52)
 - Seal 222430
 - Repair Sleeve KWK99098

Output Shaft

- 2000-1995 (Mazda F52)
 - Seal (LH) 223543
 - Seal (RH) 2007N
 - Repair Sleeve KWK99139[2]

Selector Shaft Seal/Man. Shaft

- 2000-1995
 - Seal 221620

CAMSHAFT SEAL

4 Cylinder

- 2000-1995 121/2.0/L
 - Seal 3774S
 - Repair Sleeve KWK99169

6 Cylinder

- 2000-1995 2450cc/2.5L
 - Seal 471651
 - Repair Sleeve KWK99106

CRANKSHAFT FRONT SEAL

4 Cylinder

- 2000-1995 121/2.0/L
 - Seal Viton 713771
 - Repair Sleeve KWK99139

CRANKSHAFT FRONT SEAL

6 Cylinder

- 2000-1995 2540cc/2.5L (DOHC)
 - Seal 482041N
 - Repair Sleeve KWK99187
 - Harmnc Balancer Slvs 88187

CRANKSHAFT REAR SEAL

4 Cylinder

- 2000-1995 121/2.0/L
 - Seal 3772
 - Seal PTFE H/D (Opt) 5287

6 Cylinder

- 2000-1995 2540cc/2.5L
 - Seal Viton 3909
 - Repair Sleeve KWK99363
 - Seal PTFE H/D 5277

MERCURY - FRONT DRIVE - Sable

FRONT WHEEL

FWD

- 2009-2008
 - Hub Unit Bearing HA590028[2]²⁵
- 2005-1996
 - Hub Unit Bearing 513100[2]

FRONT WHEEL (cont.)

FWD (cont.)

- 1995-1991 (From 2/1/91)
 - Set SET49[2]
 - Hub Unit Bearing (Opt) 520100[2]⁶⁵

²⁵New Item, Check For Availability

⁶⁵Kit = Nut, Studded Spindle, Bearing, Snap Ring

MERCURY - FRONT DRIVE - Sable (cont.)**FRONT WHEEL (cont.)****FWD (cont.)**

1991-1990 (Thru 1/31/91)	
Set	SET49[2] ⁶⁷
Hub Unit Bearing	520000[2] ⁶⁷

AWD

2009-2008	
Hub Unit Bearing	HA590028[2] ²⁵

REAR WHEEL**FWD**

2009-2008	
Hub Unit Bearing	512299[2] ²⁵
2005 (ABS)(Disc)	
Hub Unit Bearing	HA590038[2] ²⁵
2005-2001 (ABS)(Drum)	
Hub Unit Bearing	512163[2]
2005-2001 (Non-ABS)(Drum)	
Hub Unit Bearing	512164[2]
2004-1993 (Disc)	
Hub Unit Bearing	512107[2]
2000 (ABS)(Drum)	
Hub Unit Bearing	512162[2]
2000-1990 (Non-ABS)(Drum)	
Hub Unit Bearing	512106[2]
1992-1990 (Disc)	
Hub Unit Bearing	512105[2] ¹⁶

AWD

2009-2008	
Hub Unit Bearing	HA590029[2] ²⁵

CLUTCH**Pilot Bearing**

1993-1990	
Ball Bearing	202SS

Release Bearing

1993-1990	
Bearing Assy	614060
Bearing Assy	614118

4-SPEED AUTOMATIC TRANSAXLE**Differential**

2002-1990 (AX4, AXOD)	
Ball Bearing	208[2]

Torque Converter / Frt Pump

2005-1990 (AX4, AXOD)	
Seal	4189H

4-SPEED AUTOMATIC TRANSAXLE**Input Shaft**

2004-1992 (AXOD, AXODE, AX4N, AX4S)	
Seal	4189H
1992-1991 (Exc. AXOD)	
Seal	4539H
Repair Sleeve	KWK99235

Output Shaft

2005-1990	
Seal	3622S[2]
Repair Sleeve	KWK99169[2]

Manual Shaft

1992-1991 (Exc. AXOD)	
Seal	342517
Repair Sleeve	KWK99101

ALTERNATOR

1991-1990 (Motorcraft)	
Ball Bearing (Drive End)	203FF
1991-1990 (Motorcraft)	
Ball Bearing (Rear End)	MNJ471S

CRANKSHAFT FRONT SEAL**6 Cylinder**

2008 213/3.5L	
Seal	482041N
Repair Sleeve	KWK99187
2005-1996 182/3.0L (DOHC)	
Seal	482041N
Repair Sleeve	KWK99187
2005-1990 182/3.0L (OHV)	
Seal (Frt Entry)	2692
Seal (Rr Entry)	2942
Repair Sleeve	KWK99187
Harmnc Balancer Slvs	88187
1995-1990 232/3.8L	
Seal (Frt Entry)	2692
Seal (Rr Entry)	2942
Repair Sleeve	KWK99187
Harmnc Balancer Slvs	88187

CRANKSHAFT REAR SEAL**6 Cylinder**

2005-1996 182/3.0L (DOHC)	
Seal Viton	3909
Seal PTFE H/D (Opt)	5277
Repair Sleeve	KWK99363
2005-1990 182/3.0L (OHV)	
Seal	3772
Seal PTFE H/D (Opt)	5287
1995-1990 232/3.8L	
Seal Viton	3909
Seal PTFE H/D (Opt)	5277
Repair Sleeve	KWK99363

¹⁶Obsolete²⁵New Item, Check For Availability⁶⁷Kit = Flg, Brg, Nut, & Snap Ring

Mfg./Year	Model & Location	Part No.	Mfg./Year	Model & Location	Part No.
-----------	------------------	----------	-----------	------------------	----------

MERCURY - FRONT DRIVE - Tracer

FRONT WHEEL

FWD

1999-1991	
Seal	1932S[2]
Ball Bearing	510013[2]

REAR WHEEL

FWD

1999-1994 (Disc)	
Hub Unit Bearing	512161[2]
1999-1994 (Drum)	
Hub Unit Bearing	
(Non-ABS)	513030[2]
Hub Unit Bearing	
(ABS)	512161[2]
1993-1991	
Hub Unit Bearing	513030[2]

CLUTCH - 4 CYLINDER

Pilot Bearing

1999-1997 1998cc/2.0L	
Ndle Bearing	FC65354
1996-1991 113/1.8L (DOHC)	
Ball Bearing	202SS
1996-1991 116/1.9L	
Ndle Bearing	FC65354

CLUTCH

Release Bearing

1999-1997 1998cc/2.0L	
Bearing Assy	614155
1996-1991 113/1.8L (DOHC)	
Bearing Assy	614079
1996-1991 116/1.9L	
Bearing Assy	614128

4-SPEED AUTOMATIC TRANSAXLE

Differential

1999-1991 (AX4, AXOD)	
Ball Bearing	208[2]

Torque Converter / Frt Pump

1999-1991 (AX4, AXOD)	
Seal	4189H

Output Shaft

1999-1991	
Seal (LH)	223543
Seal (RH)	2007N
Repair Sleeve	KWK99139[2]

5-SPEED MANUAL TRANSAXLE

Differential

1999-1991 (Mazda F52)	
Set	SET17[2]
1994-1990 (MTX III)	
Set	SET45[2]

Input Shaft

1999-1991 (Mazda F52)	
Seal	222430
1994-1990 (MTX III)	
Seal	3638
Cone/Cup	LM67049A-LM67010[2]
Repair Sleeve	KWK99112

Output Shaft

1999-1991 (Mazda F52)	
Seal (LH)	223543
Seal (RH)	2007N
Repair Sleeve	KWK99139[2]
1994-1990 (MTX III)	
Seal	3622S[2]
Set	SET30[2] ²
Repair Sleeve	KWK99169[2]

Selector Shaft Seal/Man. Shaft

1996-1991 (Mazda G5M)	
Seal	221620
1994-1990 (MTX III)	
Seal Viton	710274

ALTERNATOR

1991-1990 (Motorcraft)	
Ball Bearing (Drive End)	203FF
1991-1990 (Motorcraft)	
Ball Bearing (Rear End)	MNJ471S

CAMSHAFT SEAL

4 Cylinder

1999-1991 116/1.9L, 122/2.0L	
Seal	3774S
Repair Sleeve	KWK99169
1996-1991 1839cc/1.8L	
Seal	223420

CRANKSHAFT FRONT SEAL

4 Cylinder

1999-1997 122/2.0L	
Seal	3771
Repair Sleeve	KWK99139
1996-1991 116/1.9L	
Seal	3771
Repair Sleeve	KWK99139
1996-1991 1839cc/1.8L	
Seal	710355
Repair Sleeve	KWK99145

CRANKSHAFT REAR SEAL

4 Cylinder

1999-1991 116/1.9L, 122/2.0L	
Seal	3772
Seal PTFE H/D (Opt)	5287
1996-1991 1839cc/1.8L	
Seal	228250
Repair Sleeve	KWK99328

²Non-Cancellable/Non-Returnable

Mfg./Year Model & Location Part No. Mfg./Year Model & Location Part No.

MERCURY - AWD - Milan

FRONT WHEEL

FWD

2009-2006
Ball Bearing 510010[2]

AWD

2009-2006
Ball Bearing 510010[2]

REAR WHEEL

FWD

2009-2006 (ABS)
Hub Unit Bearing HA590100[2]²⁵
2009-2006 (Non-ABS)
Hub Unit Bearing HA590095[2]²⁵

AWD

2009-2007
Ball Bearing 510010[2]

5-SPEED AUTOMATIC TRANSAXLE

Output Shaft

2008-2006
Repair Sleeve KWK99139[2]
Seal 2007N[2]

CRANKSHAFT FRONT SEAL

6 Cylinder

2008-2006 182/3.0L (DOHC)
Seal 482041N
Repair Sleeve KWK99187

CRANKSHAFT REAR SEAL

6 Cylinder

2008-2006 182/3.0L
Seal Viton 3909
Seal PTFE H/D 5277
Repair Sleeve KWK99362

MERCURY - AWD - Montego

FRONT WHEEL

FWD

2007-2005
Hub Unit Bearing HA590028[2]²⁵

AWD

2007-2005
Hub Unit Bearing HA590028[2]²⁵

REAR WHEEL

FWD

2007-2005
Hub Unit Bearing 512299[2]²⁵

AWD

2007-2005
Hub Unit Bearing HA590029[2]²⁵

CRANKSHAFT FRONT SEAL

6 Cylinder

2007-2005 3.0L
Seal 482041N
Repair Sleeve KWK99187

CRANKSHAFT REAR SEAL

6 Cylinder

2007-2005 183/3.0L
Seal Viton 3909
Seal PTFE H/D 5277
Repair Sleeve KWK99362

²⁵New Item, Check For Availability

Mfg./Year Model & Location Part No. Mfg./Year Model & Location Part No.

MERCURY - AWD - Topaz

FRONT WHEEL

FWD

1994-1990
 Set SET39[2]
 Hub Unit Bearing 518503[2]⁶⁵

AWD

1994-1990
 Set SET39[2]
 Hub Unit Bearing 518503[2]⁶⁵

REAR WHEEL

FWD

1994-1990
 Seal (Inner) 473677[2]
 Set (Inner) SET8[2]
 Set (Outer) SET12[2]

AWD

1991-1990
 Bearing Assy 513001[2]^Z

REAR AXLE

Axle Shaft

1991-1990
 Seal 3543[2]
 Repair Sleeve KWK99139[2]

TRANSFER CASE

Input Shaft

1991-1990 (Spicer)
 Set SET2
 Ball Bearing (Pilot) 206WB

Front Output Shaft

1991-1990 (Spicer)
 Cone/Cup M86647-M86610[2]

Rear Output Shaft

1991-1990 (Spicer)
 Cone/Cup M86649-M86610
 Ndle Bearing (Pilot) SCH78

CLUTCH

Release Bearing

1994-1990
 Bearing Assy 614060
 Bearing Assy 614118

3-SPEED AUTOMATIC TRANSAXLE

Differential

1994-1990 (ATX)
 Ball Bearing 208[2]

3-SPEED AUTOMATIC TRANSAXLE

Torque Converter

1994-1990 (ATX)
 Seal 4539H[2]
 Repair Sleeve KWK99235

Input Shaft

1994-1991 (ATX)
 Seal 4539H
 Repair Sleeve KWK99235

Output Shaft

1994-1990 (ATX)
 Seal 3622S[2]
 Repair Sleeve KWK99169[2]

Manual Shaft

1994-1990 (ATX)
 Seal 342517
 Repair Sleeve KWK99101

4-SPEED AUTOMATIC TRANSAXLE

Output Shaft

1994-1992 (AXODE)
 Seal 3622S[2]
 Repair Sleeve KWK99169[2]

5-SPEED MANUAL TRANSAXLE

Differential

1994-1990 (MTX III)(2 pinion)
 Set SET45[2]
 1994-1990 (MTX III)(4 pinion)
 Set SET37[2]

Input Shaft

1994-1990 (MTX III)
 Seal 3638
 Cone/Cup LM67049A-LM67010[2]
 Repair Sleeve KWK99112

Countershaft

1994-1990 (MTX III)
 Set SET16[2]

Output Shaft

1994-1990 (MTX III)
 Seal 3622S[2]
 Set SET30[2]^Z
 Repair Sleeve KWK99169[2]

Selector Shaft Seal/Man. Shaft

1994-1990 (MTX III)
 Seal Viton 710274
 Repair Sleeve KWK99059

^ZNon-Cancellable/Non-Returnable

⁶⁵Kit = Nut, Studded Spindle, Bearing, Snap Ring

Mfg./Year	Model & Location	Part No.	Mfg./Year	Model & Location	Part No.
-----------	------------------	----------	-----------	------------------	----------

MERCURY - AWD - Topaz (cont.)**ALTERNATOR**

1991-1990	Mazda 65 Amp.	
	Ball Bearing (Drive End)	303CC
1991-1990	(Motorcraft)	
	Ball Bearing (Drive End)	203FF
1991-1990	(Motorcraft)	
	Ball Bearing (Rear End)	MNJ471S

CRANKSHAFT FRONT SEAL**4 Cylinder**

1994-1990	140/2.3L	
	Seal	714075
	Repair Sleeve	KWK99177

6 Cylinder

1994-1992	182/3.0L (OHV)	
	Seal (Frt Entry)	2692
	Seal (Rr Entry)	2942
	Repair Sleeve	KWK99187
	Harmnc Balancer Slvs	88187

CRANKSHAFT REAR SEAL**4 Cylinder**

1994-1990	140/2.3L	
	Seal	3772
	Seal PTFE H/D (Opt)	5287

6 Cylinder

1994-1992	183/3.0L	
	Seal	3772
	Seal PTFE H/D (Opt)	5287

MERCURY - REAR DRIVE - Grand Marquis, Marauder**FRONT WHEEL****RWD**

2009-2004	Grand Marquis, Marauder	
	Hub Unit Bearing	513230[2] ²⁵
2003	Grand Marquis, Marauder	
	Hub Unit Bearing	513196[2]
2002-1997	(From 4/1/97)	
	Hub Unit Bearing	513202[2]
1997-1992	(Thru 3/31/97)	
	Hub Unit Bearing	513104[2]
1991-1990		
	Seal (Inner)	6815[2]
	Set (Inner)	SET11[2]
	Set (Outer)	SET12[2]

REAR WHEEL**RWD**

2009-1990		
	Seal	8660S[2]
	Cylindrical Bearing	5707[2]
	Bearing & Seal Kit	TRP1563TAV[2] ¹⁹

REAR AXLE**Differential Rebuild Kit**

2008-1990	(8.5", 8.8" R.G.)	
	Kit	DRK311

REAR AXLE**Differential**

2008-1990	(8.5", 8.8" R.G.)	
	Set	SET36[2]

Pinion

2008-1999	(8.8" R.G.)	
	Seal Viton	3604
	Cone/Cup (Inner)	M802048-M802011
	Cone/Cup (Outer)	M88048-M88010
1998-1990	(7.5", 8.5", 8.8" R.G.)	
	Seal Viton	3604
	Cone/Cup (Inner)	M802048-M802011
	Cone/Cup (Outer)	M88048-M88010
	Repair Sleeve	KWK99181

4-SPEED AUTOMATIC TRANSMISSION**Torque Converter**

2005-1992	(AODE, 4R70W)	
	Seal	710447
	Repair Sleeve	KWK99199
1992-1990	(AOT, AOD)	
	Seal	331107N[2]
	Repair Sleeve	KWK99199

¹⁹Opt. Axle Rpr Brg. Replaces O.E. Brg & Seal²⁵New Item, Check For Availability

Mfg./Year Model & Location Part No. Mfg./Year Model & Location Part No.

MERCURY - REAR DRIVE - Grand Marquis, Marauder (cont.)

4-SPEED AUTOMATIC TRANSMISSION

Rear Seal/Ext. Housing

2002-1995 (AODE)	
Seal	4764[2]
1994-1992 (AODE)	
Seal	7692S[2]
Seal Kit	5202 ⁶⁴
1991-1990 (AOT, AOD)(long boot)	
Seal	7692S[2]
Seal Kit	5202 ⁶⁴
1991-1990 (AOT, AOD)(short boot)	
Seal	2194[2]

Selector Shaft Seal/Man. Shaft

2007-1990	
Seal	7929S
Repair Sleeve	KWK99076

4-SPEED MANUAL TRANSMISSION

Selector Shaft Seal/Man. Shaft

2004-2003 (AODE W)	
Seal	7929S

ALTERNATOR

1991-1990 (Motorcraft)	
Ball Bearing (Drive End)	203FF
1991-1990 (Motorcraft)	
Ball Bearing (Rear End)	MNJ471S

CRANKSHAFT FRONT SEAL

8 Cylinder

2008-1992 281/4.6L	
Seal	482041N
Repair Sleeve	KWK99187
Harmnc Balancer Slvs	88187
1991-1990 (w/o 281/4.6, 292/4.8)	
Seal (Frt Entry)	2692
Seal (Rr Entry)	2942
Repair Sleeve	KWK99187
Harmnc Balancer Slvs	88187

CRANKSHAFT REAR SEAL

8 Cylinder

2006-1990 281/4.6L, 302/5.0L	
Seal Viton	3909
Seal PTFE H/D	5277
Repair Sleeve	KWK99362
1991-1990 351/5.8L (W)	
Seal Viton	2377
Seal PTFE H/D	5278
Repair Sleeve	KWK99372

MERCURY - REAR DRIVE - Cougar

FRONT WHEEL

RWD

1997-1993	
Hub Unit Bearing	513092[2]
1992-1991 (ABS, Non-ABS)	
Hub Unit Bearing	513092[2]
1990 (ABS)	
Hub Unit Bearing	513076[2]
1990 (Non-ABS)	
Hub Unit Bearing	513077[2]

REAR WHEEL

RWD

1997-1990	
Set	SET49[2]

CLUTCH RELEASE

Diaphragm Spring Pressure Plates

1996-1993 6 Cyl. (including Supercharged)	
Bearing Assy	614061
1992-1991 (8 Cyl.)	
Bearing Assy	614038
1992-1990 6 Cyl. (including Supercharged)	
Bearing Assy	614061

⁶⁴Seal & Bushing Kit

Mfg./Year Model & Location Part No. Mfg./Year Model & Location Part No.

MERCURY - REAR DRIVE - Cougar (cont.)**REAR AXLE****Axle Shaft**

1997-1990 (IRS 7.5" R.G., IRS 8.8" R.G.)	
Seal Viton	714569[2]
Ndle Bearing	FC66998[2]
Repair Sleeve	KWK99157[2]

Differential Rebuild Kit

1997-1990 (8.8" R.G.)	
Kit	DRK311
1997-1990 (7.5" R.G.)	
Kit	DRK315

Differential

1997-1990 (7.5" R.G.)	
Cone/Cup	LM501349-LM501314[2]
1997-1990 (8.8" R.G.)	
Set	SET36[2]

Pinion

1997-1990 (7.5", 8.8" R.G.)	
Seal Viton	3604
Cone/Cup (Inner)	M802048-M802011
Cone/Cup (Outer)	M88048-M88010

4-SPEED AUTOMATIC TRANSMISSION**Torque Converter**

1997-1992 (AODE)	
Seal	3404
1993-1990 (AOT, AOD)	
Seal	331107N[2]
Repair Sleeve	KWK99199

Rear Seal/Ext. Housing

1997-1994 (AODE W)	
Seal	4764
1997-1994 (AODE)	
Seal	7692S[2]
Seal Kit	5202 ⁶⁴
1993-1990 (AOT, AOD)(long boot)	
Seal	7692S[2]
Seal Kit	5202 ⁶⁴
1993-1990 (AOT, AOD)(short boot)	
Seal	2194[2]

Selector Shaft Seal/Man. Shaft

1997-1990	
Seal	7929S
Repair Sleeve	KWK99076

CLUTCH**Pilot Bearing**

1992-1990 (w/o 4.6 V8)	
Ndle Bearing	FC65174

5-SPEED MANUAL TRANSMISSION**Front Input Shaft**

1997-1990 (Mazda M5R2)	
Seal	223012[2]
Repair Sleeve	KWK99114

Countershaft

1995-1990 (Mazda M5R2)	
Cylindrical Bearing	
(Center)	MR1207EL[2]
Ball Bearing (Rr)	304WB[2]

Rear Output Shaft

1995-1990 (Mazda M5R2)	
Seal	710414[2]

Extension Housing

1995-1990 (Mazda M5R2)	
Seal	710415

ALTERNATOR

1993-1990 (Motorcraft)	
Ball Bearing (Drive End)	203FF
1993-1990 (Motorcraft)	
Ball Bearing (Rear End)	MNJ471S

CRANKSHAFT FRONT SEAL**8 Cylinder**

1997-1994 281/4.6L	
Seal	482041N
Repair Sleeve	KWK99187
Harmnc Balancer Slvs	88187
1993-1990 (w/o 281/4.6)	
Seal (Fr Entry)	2692
Seal (Rr Entry)	2942
Repair Sleeve	KWK99187
Harmnc Balancer Slvs	88187

CRANKSHAFT REAR SEAL**6 Cylinder**

1999 2540cc/2.5L (DOHC)	
Seal Viton	3909
Seal PTFE H/D	5277
Repair Sleeve	KWK99363
1997-1990 232/3.8L From 1/1/83	
Seal Viton	3909
Seal PTFE H/D	5277
Repair Sleeve	KWK99363

8 Cylinder

1997-1990 281/4.6L, 302/5.0L	
Seal Viton	3909
Seal PTFE H/D	5277
Repair Sleeve	KWK99363

⁶⁴Seal & Bushing Kit

Mfg./Year Model & Location Part No. Mfg./Year Model & Location Part No.

MERCURY - SUV - Mariner, Mariner Hybrid

FRONT WHEEL

FWD

2009-2005
 Hub Unit Bearing HA590286K[2]⁶⁷
 Ball Bearing 510072[2]²⁵

4WD

2009-2005
 Hub Unit Bearing HA590286K[2]⁶⁷
 Ball Bearing 510072[2]²⁵

REAR WHEEL

FWD

2009-2005
 Ball Bearing 510029[2]

4WD

2009-2005
 Ball Bearing 510029[2]

REAR AXLE

Axle Shaft

2008-2005
 Seal Viton 710429[2]

Differential

2008-2005
 Cone/Cup LM29749-LM29710[2]

REAR AXLE

Pinion

2008-2005
 Cone/Cup (Inner) M86649-M86610
 Cone/Cup (Outer) M88048-M88010
 Seal 100552

CRANKSHAFT FRONT SEAL

6 Cylinder

2008-2005 3.0L
 Seal 482041N

CRANKSHAFT REAR SEAL

6 Cylinder

2008-2005 3.0L
 Seal Viton 3909
 Seal PTFE H/D 5277
 Repair Sleeve KWK99362

MERCURY - SUV - Mountaineer

FRONT WHEEL

RWD

2009-2006
 Hub Unit Bearing HA590156[2]²⁵
 2005-2002
 Hub Unit Bearing (ABS
 Cable Included) SP470200[2]
 Hub Unit Bearing SP470201[2]⁰²
 2001-1997
 Seal (Inner) 9150S[2]
 Set (Inner) SET5[2]
 Set (Outer) SET2[2]

4WD

2009-2006
 Hub Unit Bearing HA590156[2]²⁵
 2005-2002
 Hub Unit Bearing (ABS
 Cable Included) SP470200[2]
 Hub Unit Bearing SP470201[2]⁰²
 2001-1997
 Hub Unit Bearing SP450200[2]⁴⁰

FRONT WHEEL

AWD

2009-2006
 Hub Unit Bearing HA590156[2]²⁵
 2005-2002
 Hub Unit Bearing (ABS
 Cable Included) SP470200[2]
 Hub Unit Bearing SP470201[2]⁰²
 2001-1997
 Hub Unit Bearing SP450200[2]⁴⁰

REAR WHEEL

RWD

2009-2006
 Bearing Assy 516008[2]²⁵
 2005-2002
 Hub Unit Bearing HA590259K[2]⁶⁸
 2001-1997
 Seal 8835S[2]
 Cylindrical Bearing 6408[2]
 Bearing & Seal Kit TRP1559TV[2]¹⁹

⁰²Does Not Come w/ Sensor Cable.
 Check For Availability ⁴⁰5 Stud.
 Snap Ring

¹⁹Opt. Axle Rpr Brg. Replaces O.E. Brg & Seal
⁶⁷Kit = Flg, Brg, Nut, & Snap Ring

²⁵New Item,
⁶⁸Kit = Flg, Brg, &

MERCURY - SUV - Mountaineer (cont.)**REAR WHEEL****4WD**

2009-2006	
Bearing Assy	516008[2] ²⁵
2005-2002	
Hub Unit Bearing	HA590259K[2] ⁶⁸
2001-1997	
Seal	8835S[2]
Cylindrical Bearing	6408[2]
Bearing & Seal Kit	TRP1559TV[2] ¹⁹

AWD

2009-2006	
Bearing Assy	516008[2] ²⁵
2005-2002	
Hub Unit Bearing	HA590259K[2] ⁶⁸
2001-1997	
Seal	8835S[2]
Cylindrical Bearing	6408[2]
Bearing & Seal Kit	TRP1559TV[2] ¹⁹

4WD FRONT AXLE**Axle Shaft**

2008-2002 (8.8" R.G.)(Indep. Frt. Susp.)	
Ndle Bearing (Inner)	HK4012[2]
Ndle Bearing (Outer)	FC66998[2]
2001-1997 (Dana/Spicer 35 Axle)	
Seal Viton (LH)	710429
Ndle Bearing (LH)	S268[2]
Seal (RH)	710248
Cylindrical Bearing (RH)	5707[2]

Differential Rebuild Kit

2001-1997 (Dana/Spicer 35 Axle)	
Kit	DRK335

Differential

2007-2002	
Cone/Cup	LM501349-LM501314[2]
2001-1997 (Dana/Spicer 35 Axle)	
Cone/Cup	LM501349-LM501314[2]

Pinion

2007-2002	
Seal Viton	714675
Cone/Cup (Inner)	HM88649-HM88610
Cone/Cup (Outer)	M86649-M86610
2001-1997 (Dana/Spicer 35 Axle)	
Seal Viton	714675
Cone/Cup (Inner)	HM88648-HM88610
Cone/Cup (Outer)	M86649-M86610

Spindle Kit

2001-1997 (Dana/Spicer 35 Axle)	
Bearing & Seal Kit	SBK1[2] ³³

4WD FRONT AXLE**Spindle**

2001-1997 (Dana/Spicer 35 Axle)	
Seal (Inner)	722108[2]
Ndle Bearing (Inner)	B2110[2]
Seal (Outer)	722109[2]

REAR AXLE**Axle Shaft**

2008-2002 (8.8" R.G.)(Indep. Rr. Susp.)	
Ndle Bearing	FC66998[2]
Seal	100537[2]

Differential Rebuild Kit

2008-2002 (8.8" R.G.)(Indep. Rr. Susp.)	
Kit	DRK311A ²⁵
2001-1997 (8.8" R.G.)	
Kit	DRK311

Differential

2008-2002 (8.8" R.G.)(Indep. Rr. Susp.)	
Cone/Cup	LM603049-LM603019[2]
2001-1997 (8.8" R.G.)	
Set	SET36[2]

Pinion

2007-1997 (8.8" R.G.)	
Seal Viton	3604
Cone/Cup (Inner)	M802048-M802011
Cone/Cup (Outer)	M88048-M88010

TRANSFER CASE REBUILD KIT

2002-1998 4.0L.	
Kit	TCRK4405
2001-1997 5.0L	
Kit	TCRK4404

TRANSFER CASE**Input Shaft**

2008-2002 (Warner 4410)	
Seal	710403
Ball Bearing	209LO
Repair Sleeve	KWK99166
2008-1997 (Warner 4405, 4411, 4412)	
Seal	710403
Ball Bearing	209LO
Repair Sleeve	KWK99166
Ndle Bearing (Pilot)	M18161
2001-1999 (Warner 4403)	
Seal	3946
Ball Bearing	109TB
Repair Sleeve	KWK99187
1998 (Warner 4404)(booted)	
Seal	4333N
Ball Bearing	109TB
Ndle Bearing (Pilot)	SCH1310

¹⁹Opt. Axle Rpr Brg. Replaces O.E. Brg & Seal ²⁵New Item, Check For Availability
Brg B2110, Seals 722108 & 722109. ⁶⁸Kit = Flg, Brg, & Snap Ring

³³Opt. Kit =

MERCURY - SUV - Mountaineer (cont.)

TRANSFER CASE (cont.)

Input Shaft (cont.)

1998	(Warner 4404)(w/o boot)	
Seal		3946
Ball Bearing		109TB
Repair Sleeve		KWK99187
Ndle Bearing (Pilot)		SCH1310

Front Output Shaft

2008-2002	(Warner 4410)	
Seal		710403
Ball Bearing		206WB
Repair Sleeve		KWK99166
2008-1997	(Warner 4405, 4411, 4412)	
Ball Bearing (Inner)		306H[2]
Seal (Outer)		710403
Ball Bearing (Outer)		206WB[2]
Repair Sleeve		KWK99166
Ndle Bearing		FC67945[2] ¹⁶
2002-1998	(Warner 4403, 4404)	
Ball Bearing (Inner)		206WB[2]
Seal (Outer)		710403
Ball Bearing (Outer)		207[2]
Repair Sleeve		KWK99166

Rear Output Shaft

2008-2002	(Warner 4410)	
Seal		710403
Ball Bearing		208SL
Repair Sleeve		KWK99166
2008-1997	(Warner 4405, 4411, 4412)	
Seal		710403
Ball Bearing		306H[2]
Repair Sleeve		KWK99166
2002-1999	(Warner 4403)	
Seal		710403
Ball Bearing		208[2]
Repair Sleeve		KWK99166
1998	(Warner 4404)	
Ball Bearing (Inner)		N1061[2]
Seal (Outer)		710403
Ball Bearing (Outer)		208SL[2]
Repair Sleeve		KWK99166

Selector Shaft Seal/Man. Shaft

2008-1997	(Warner 4403, 4404, 4405)	
Seal		330385

4-SPEED AUTOMATIC TRANSMISSION

Torque Converter

2001-1997	(4R70W)	
Seal		3404

Rear Seal/Ext. Housing

2001-1997	(4R70W)	
Seal		4765

4-SPEED AUTOMATIC TRANSMISSION

Selector Shaft Seal/Man. Shaft

2001-1997	(4R70W)	
Seal		7929S

5-SPEED AUTOMATIC TRANSMISSION

Selector Shaft Seal/Man. Shaft

2008-2002	(5R55E)	
Seal		7929S

6- SPEED AUTOMATIC TRANSMISSION

Torque Converter

2008-2006	(6R60)	
Seal		710484

Rear Seal/Ext. Housing

2008-2006	(6R60)(2WD)	
Seal		710487
2008-2006	(6R60)(4WD)	
Seal		710486

ALTERNATOR

1998-1997	Mitsubishi 110 Amp.	
Ball Bearing (Drive End)		303CC

CRANKSHAFT FRONT SEAL

6 Cylinder

2008-2002	281/4.6L	
Seal		482041N
Repair Sleeve		KWK99187
2006-2004	244/4.0L	
Seal Viton		2012V
2003-1998	244/4.0L	
Seal		473560N
Repair Sleeve		KWK99166

8 Cylinder

2005-2002	281/4.6L	
Seal		482041N
Repair Sleeve		KWK99187
Harmnc Balancer Slvs		88187
2001-1997	302/5.0L	
Seal (Frt Entry)		2692
Seal (Rr Entry)		2942
Repair Sleeve		KWK99187
Harmnc Balancer Slvs		88187

CRANKSHAFT REAR SEAL

6 Cylinder

2008-1998	244/4.0L	
Seal Viton		3393
Seal PTFE H/D		5288
Repair Sleeve		KWK99238

¹⁶Obsolete

Mfg./Year	Model & Location	Part No.	Mfg./Year	Model & Location	Part No.
-----------	------------------	----------	-----------	------------------	----------

MERCURY - SUV - Mountaineer (cont.)**CRANKSHAFT REAR SEAL****8 Cylinder**

2008-1997	281/4.6L, 302/5.0L	
	Seal Viton	3909
	Seal PTFE H/D	5277
	Repair Sleeve	KWK99362

MERCURY - Minivan - Villager**FRONT WHEEL****FWD**

2002-1993		
	Ball Bearing	510028[2]

REAR WHEEL**FWD**

2002-1997		
	Hub Unit Bearing	HA590057[2]
1996-1993		
	Ball Bearing	511008[2]

4-SPEED AUTOMATIC TRANSAXLE**Differential**

2002-1993	(4F20E)	
	Bearing Assy	32009XM[2]

Torque Converter / Frt Pump

2002-1993	(4F20E)	
	Seal	224450

Output Shaft

2002-1993	(4F20E)	
	Seal (LH)	710118
	Seal (RH)	710124

Manual Shaft

2002-1993	(4F20E)	
	Seal	221207

A/C COMPRESSOR

1998-1993	(Cl. Pulley)(Nippondenso FX 15)	
	Ball Bearing	5106WCC[2]

ALTERNATOR

1998-1993	Mitsubishi 110 Amp.	
	Ball Bearing (Drive End)	303CC

CAMSHAFT SEAL**6 Cylinder**

2002-1999	3275/3.3L	
	Seal	224052[2]
	Repair Sleeve	KWK99157[2]
1998-1993	2960cc/3.0L	
	Seal	223420[2]
	Repair Sleeve	KWK99134[2]

CRANKSHAFT FRONT SEAL**6 Cylinder**

2002-1999	3275/3.3L	
	Seal	224052
	Repair Sleeve	KWK99157
1998-1993	2960cc/3.0L	
	Seal	224052
	Repair Sleeve	KWK99157

CRANKSHAFT REAR SEAL**6 Cylinder**

2002-1999	3275/3.3L	
	Seal PTFE H/D	228411 ²⁵
1998-1993	2960cc/3.0L	
	Seal Viton	228410

²⁵New Item, Check For Availability

Mfg./Year Model & Location Part No. Mfg./Year Model & Location Part No.

MERCURY - Minivan - Monterey

FRONT WHEEL

FWD

2007-2004 (L.H.)(ABS)
Hub Unit Bearing HA590024[2]²⁵
2007-2004 (R.H.)(ABS)
Hub Unit Bearing HA590025[2]²⁵

REAR WHEEL

FWD

2007-2004 (ABS)
Hub Unit Bearing (LH) HA590021⁹⁴
Hub Unit Bearing (RH) HA590022⁸³
Hub Unit Bearing (RH)
(Reorder) HA590021[2]⁹⁴

4-SPEED AUTOMATIC TRANSAXLE

Input Shaft

2007-2004 (AX4N)
Seal 4189H

Output Shaft

2007-2004 (AX4N)
Seal 3622S[2]
Repair Sleeve KWK99169

CRANKSHAFT FRONT SEAL

6 Cylinder

2007-2004 256/4.2L
Seal 712692
Repair Sleeve KWK99187

CRANKSHAFT REAR SEAL

6 Cylinder

2007-2004 256/4.2L
Seal Viton 3909
Seal PTFE H/D 5277
Repair Sleeve KWK99362

MERKUR - ALL

REAR WHEEL

RWD

1990
Seal 224252[2]
Set SET24[2]

CLUTCH

Pilot Bearing

1990 Scorpio
Ndle Bearing FC65354
1990 XR4Ti
Ndle Bearing FC65354

CLUTCH

Release Bearing

1990 Scorpio
Bearing Only F01267C
1990 XR4Ti
Bearing Assy 614014

MITSUBISHI - FRONT DRIVE - Diamante, Eclipse, Expo, Galant, Galant Sigma, Lancer, Mirage, Precis, 3000GT

FRONT WHEEL

FWD

2008 Lancer
Ball Bearing WB000021[2]²⁵
2008-2007 Eclipse
Hub Unit Bearing HA590177[2]²⁵
2008-2007 Galant 3.8L
Hub Unit Bearing HA590177[2]²⁵
2008-2004 Galant 2.4L
Hub Unit Bearing 513157

FRONT WHEEL (cont.)

FWD (cont.)

2007-2006 Lancer ES, SE, OZ Rally, Ralliart
Ball Bearing 510079[2]
2006 Eclipse
Hub Unit Bearing HA590108[2]²⁵
2006-2004 Galant 3.8L
Hub Unit Bearing HA590108[2]²⁵
2005-2002 Lancer ES
Ball Bearing 510021[2]

²⁵New Item, Check For Availability

⁸³Deplete Inventory

⁹⁴HA590021 Will Service Both Sides.

MITSUBISHI - FRONT DRIVE - Diamante, Eclipse, Expo, Galant, Galant Sigma, Lancer, Mirage, Precis, 3000GT (cont.)

FRONT WHEEL (cont.)

FWD (cont.)

2005-2002	Lancer LS, O-Z Rally, Ralliart	
	Ball Bearing	510079[2]
2005-1995	Eclipse	
	Hub Unit Bearing	513157[2]
2004-1992	Diamante	
	Seal (Inner)	710182[2]
	Ball Bearing (Inner)	510034[2]
	Seal (Outer)	710183[2]
2003-1996	Galant	
	Hub Unit Bearing (4 Stud)	HA590240[2]
	Hub Unit Bearing (5 Lug Whl.)	513157[2]
	Bearing Module (Opt)	513135[2]
2002-2000	Mirage	
	Ball Bearing	510021[2]
1999-1993	Mirage	
	Seal (Inner)	8430S[2]
	Ball Bearing	510016[2]
	Seal (Outer)	4898[2]
1999-1991	3000GT	
	Seal (Inner)	710182[2]
	Ball Bearing (Inner)	510034[2]
	Seal (Outer)	710183[2]
1995-1994	Galant	
	Hub Unit Bearing	HA590240[2]
1995-1992	Expo	
	Seal (Inner)	225450[2]
	Ball Bearing (Inner)	513036[2]
	Seal (Outer)	225230[2]
1994-1990	Eclipse	
	Seal (Inner)	225450[2]
	Ball Bearing (Inner)	513036[2]
	Seal (Outer)	225230[2]
1994-1990	Precis	
	Seal (Inner)	229522[2]
	Set (Inner)	SET41[2]
	Seal (Outer)	229522[2]
	Set (Outer)	SET41[2]
1993-1990	Galant, Galant Sigma	
	Seal (Inner)	225450[2]
	Ball Bearing (Inner)	513036[2]
	Seal (Outer)	225230[2]
1992-1990	Mirage	
	Seal (Inner)	229522[2]
	Set (Inner)	SET41[2]
	Seal (Outer)	229522[2]
	Set (Outer)	SET41[2]

AWD

2008	Lancer Evolution	
	Hub Unit Bearing	HA590271[2] ²⁵
2006-2003	Lancer Evolution	
	Hub Unit Bearing	513133[2]
1999-1995	Eclipse	
	Hub Unit Bearing	513157[2]
1999-1991	3000GT	
	Hub Unit Bearing	513133[2]

FRONT WHEEL (cont.)

AWD (cont.)

1995-1992	Expo	
	Seal (Inner)	225450[2]
	Ball Bearing (Inner)	513036[2]
	Seal (Outer)	225230[2]
1994-1990	Eclipse	
	Seal (Inner)	225450[2]
	Ball Bearing (Inner)	513036[2]
	Seal (Outer)	225230[2]
1992-1990	Galant	
	Seal (Inner)	225450[2]
	Ball Bearing (Inner)	513036[2]
	Seal (Outer)	225230[2]

REAR WHEEL

FWD

2008-2006	Eclipse (ABS)	
	Hub Unit Bearing	HA590128[2] ²⁵
2006-2004	Galant (ABS)	
	Hub Unit Bearing	HA590128[2] ²⁵
2006-2004	Galant (Non-ABS)	
	Hub Unit Bearing	HA590129[2] ²⁵
2006-2004	Lancer Sedan (2.4L)	
	Hub Unit Bearing	HA590103[2] ²⁵
2006-2002	Lancer ES	
	Hub Unit Bearing	HA590104[2] ²⁵
2006-2002	Lancer LS, O-Z Rally	
	Hub Unit Bearing	HA590101[2] ²⁵
2005-1995	Eclipse	
	Hub Unit Bearing	HA590306[2]
	Bearing Module	512136[2]
2004-1997	Diamante (ABS)	
	Hub Unit Bearing	HA590107[2] ²⁵
2003-1996	Galant (ABS)(From 3/96)	
	Hub Unit Bearing	HA590306[2]
2003-1996	Galant (Non-ABS)(From 3/96)	
	Bearing Module	512136[2]
2002-1997	Mirage (ABS)	
	Hub Unit Bearing	512185[2]
2002-1993	Mirage (Non-ABS)	
	Hub Unit Bearing	512148[2]
1999-1991	3000GT	
	Hub Unit Bearing	512039[2]
1996-1994	Galant (To 3/96)	
	Hub Unit Bearing	512235[2]
1996-1992	Diamante (ABS)	
	Hub Unit Bearing	512011[2] ⁸¹
1996-1992	Diamante (Non-ABS)	
	Hub Unit Bearing	512010[2]
1995-1992	Expo	
	Hub Unit Bearing	512040[2]
1994-1990	Eclipse (ABS)	
	Hub Unit Bearing	512011[2] ⁸¹
1994-1990	Eclipse (Non-ABS)	
	Hub Unit Bearing	512010[2]
1994-1990	Precis	
	Seal (Inner)	710404[2]
	Bearing Assy	516000[2]
1993-1990	Galant (Disc)	
	Hub Unit Bearing	512158[2]

²⁵New Item, Check For Availability⁸¹Holes Exists For Tone Ring, Reuse Tone Ring.

Mfg./Year	Model & Location	Part No.	Mfg./Year	Model & Location	Part No.
MITSUBISHI - FRONT DRIVE - Diamante, Eclipse, Expo, Galant, Galant Sigma, Lancer, Mirage, Precis, 3000GT (cont.)					

REAR WHEEL (cont.)

FWD (cont.)

1993-1990	Galant (Drum)	
	Seal (Inner)	1196[2]
	Set (Inner)	SET4[2]
	Set (Outer)	SET1[2]
1992-1990	Mirage (Drum)	
	Seal (Inner)	1205N[2]
	Bearing Assy	516001WB[2]
1990	Mirage (Disc)	
	Seal (Inner)	1205N[2]
	Bearing Assy	516000[2]
1990	Galant Sigma	
	Seal (Inner)	494122[2]
	Set (Inner)	SET6[2]
	Set (Outer)	SET2[2]

AWD

2008	Lancer Evolution	
	Hub Unit Bearing	HA590275[2]
2006-2003	Lancer Evolution	
	Bearing Module	512181[2]
1999-1995	Eclipse	
	Bearing Module	512181[2]
1999-1991	3000GT	
	Seal (Inner)	710152[2]
	Ball Bearing (Inner)	511014[2]
	Ball Bearing (Outer)	511015[2]
1995-1992	Expo	
	Ball Bearing	511013[2]
1994-1990	Eclipse	
	Seal (Inner)	710152[2]
	Ball Bearing (Inner)	511014[2]
	Ball Bearing (Outer)	511015[2]
1992-1990	Galant	
	Seal (Inner)	710152[2]
	Ball Bearing (Inner)	511014[2]
	Ball Bearing (Outer)	511015[2]

REAR AXLE

Differential

1997-1991	(4WD) 3000GT	
	Seal	710208[2]
1995-1990	(4WD) Eclipse, Expo, Galant	
	Seal	710396[2]
	Bearing Assy	30207M[2]

CLUTCH

Pilot Bearing

1996-1990	6 Cyl. 3.0	
	Ball Bearing	203FF
1996-1990	4 Cyl. 2.0, 2.4, 2.6	
	Ball Bearing	102CC

CLUTCH

Release Bearing

2003-2000	Eclipse 2.4 (SOHC)(w/o Turbo)	
	Bearing Assy	614126
1999-1996	Eclipse (AWD)(Turbo) 2.4L (SOHC)	
	Bearing Assy	614099
1999-1996	Eclipse 2.0L (DOHC)	
	Bearing Assy	614121
1996-1992	Expo	
	Bearing Assy	614126
1996-1991	3000GT (AWD)(Turbo)	
	Bearing Assy	614099
1996-1991	3000GT (w/o AWD Turbo)	
	Bearing Assy	614126
1996-1991	Diamante	
	Bearing Assy	614126
1996-1990	Galant Ser. (FWD)	
	Bearing Assy	614126
1995	Eclipse (AWD)(Turbo)	
	Bearing Assy	614099[2]
1995	Eclipse (w/o Turbo)(w/o AWD)	
	Bearing Assy	614121
1995-1990	Mirage (FWD)	
	Bearing Assy	614126
1994-1990	Eclipse (AWD)(Turbo)	
	Bearing Assy	614099
1994-1990	Eclipse 2.0 (DOHC)(w/o Turbo)	
	Bearing Assy	614126
1992-1990	Precis	
	Bearing Assy	614126
1991-1990	Sigma	
	Bearing Assy	614126

3-SPEED AUTOMATIC TRANSAXLE

Differential

1996-1990	(F3A21 2)	
	Ball Bearing	207[2]

Torque Converter

1997-1990		
	Seal	320583
	Repair Sleeve	KWK99157

Idler Shaft

1997-1990	(F3A21 2)	
	Bearing Assy	30206M[2]

Transfer Shaft

1997-1990	(F3A21 2)	
	Bearing Assy	30207M[2]
1994-1990	(KM171 1, KM171 2, KM172 0, KM171 5)	
	Bearing Assy (Inner)	30206M[2]
	Bearing Assy (Outer)	30304[2]

Mfg./Year Model & Location Part No. Mfg./Year Model & Location Part No.

MITSUBISHI - FRONT DRIVE - Diamante, Eclipse, Expo, Galant, Galant Sigma, Lancer, Mirage, Precis, 300GT (cont.)**3-SPEED AUTOMATIC TRANSAXLE****Output Shaft**

1999-1990	
Seal	223543[2]
Repair Sleeve	KWK99139[2]

4-SPEED AUTOMATIC TRANSAXLE**Differential**

2005-2002 (F4A42 1)	
Bearing Assy	30207M[2]
1999-1997 (F4A21 2, F4A33 1)	
Ball Bearing	207[2]
1999-1995 (F4AC1)	
Seal	3459S[2]
Set	SET11[2]
Repair Sleeve	KWK99157[2]
1996-1990 (F4A21 2, F4A22 2, F4A33 1, KM176 5, KM177 0)	
Ball Bearing	207[2]
1990 (KM177 8)	
Ball Bearing	206WB[2]

Torque Converter / Frt Pump

2005-2000 (F4A42 1, F4A51 2)	
Seal	320583
1999-1997 (F4A21 2, F4A33 1, W4A33 1)	
Seal	320583
Repair Sleeve	KWK99157
1999-1995 (F4AC1)	
Seal	331228H
Repair Sleeve	KWK99149
1996-1990 (F4A21 2, F4A22 2, F4A33 1, KM176 5, KM175 5, KM177 0, KM177 8, W4A32 1, W4A33 1)	
Seal	320583
Repair Sleeve	KWK99157

Input Shaft

1995-1990 (W4A32 1)	
Seal	223014
Repair Sleeve	KWK99114

Idler Shaft

1997-1991 (F4A21 2)	
Bearing Assy	30206M[2]

Transfer Shaft

1999-1995 (F4AC1)	
Set	SET16[2]
1997-1991 (F4A21 2)	
Bearing Assy	30207M[2]

4-SPEED AUTOMATIC TRANSAXLE**Output Shaft**

2007-2000 (F4A41 1, F4A42 2, F4A4B 4)	
Bearing Assy (Frt)	32009XM[2]
Bearing Assy (Rr)	32006[2]
2006-1999 (F4A51 2)	
Bearing Assy (Frt)	32010X[2]
Bearing Assy (Rr)	32006[2]
1999-1993 (F4A33 1)	
Seal Viton	710259[2]
1999-1990 (W4A32 1, W4A33 1)	
Seal (LH)	223543
Seal (RH)	710199
Repair Sleeve	KWK99139[2]
1997 (F4A21 2)	
Seal	223543[2]
Repair Sleeve	KWK99139
1996-1993 (F4A21 2, F4A22 2)	
Seal	223543[2]
Repair Sleeve	KWK99139
1992-1990 (F4A21 2, F4A22 2, F4A33 1, KM176 5, KM175 5, KM177 0, KM177 8)	
Seal	223543[2]
Repair Sleeve	KWK99139

Manual Shaft

1999-1995 (F4AC1)	
Seal	8609

5-SPEED MANUAL TRANSAXLE**Transaxle Rebuild Kit**

1994-1990	Precis	
Kit		TRKM100
1992-1990	Galant, Mirage	
Kit		TRKM100

Differential

2004-1999 (F5M42 1)	
Bearing Assy	30207M[2]
1997-1995 (A578)	
Set	SET11[2]

Input Shaft

2002-1999 (F5M42 1)	
Seal	222510
1999-1990 (F5M31 2, F5M33 1, W5M33 2)	
Seal Viton	712007

Output Shaft

1999-1990 (W5M33 2)	
Seal (LH)	223543
Seal (RH)	710199
Repair Sleeve	KWK99139[2]
1997-1995 (F5M31 2)	
Seal	2007N[2]
1997-1993 (F5M33 2)	
Seal	223543[2]
Repair Sleeve	KWK99139[2]

Mfg./Year	Model & Location	Part No.	Mfg./Year	Model & Location	Part No.
MITSUBISHI - FRONT DRIVE - Diamante, Eclipse, Expo, Galant, Galant Sigma, Lancer, Mirage, Precis, 3000GT (cont.)					

5-SPEED MANUAL TRANSAXLE

Selector Shaft Seal/Man. Shaft

1999-1995 (A578)	
Seal	3816
1997-1990 (F5M21 1, F5M21 2, F5M22 2, KM201 0, KM206 0)	
Seal	710222

Extension Housing

1994-1991 (W5MG1)	
Seal	224025
1993-1990 (W5M31 2)	
Seal	710310
Repair Sleeve	KWK99128

ALTERNATOR

1994-1991 110 Amp.	
Ball Bearing (Drive End)	303CC
1994-1990 65 Amp.	
Ball Bearing (Drive End)	302CC

OIL PUMP

4 Cylinder

2008-2005 2351cc/2.4L, 2378cc/2.4L	
Seal	222025
Repair Sleeve	KWK99078
2004-1990 1997cc/2.0L, 2351cc/2.4L	
Seal	222025
Repair Sleeve	KWK99078
1992-1990 1597cc/1.6L (DOHC)	
Seal	222025
Repair Sleeve	KWK99078

6 Cylinder

2003-2002 2972cc/3.0L	
Seal	222025
Repair Sleeve	KWK99078

CAMSHAFT SEAL

4 Cylinder

2002-1990 1500cc/1.5L, 1834cc/1.8L	
Seal	3771

6 Cylinder

2006-1997	
Seal	3771

CRANKSHAFT FRONT SEAL

4 Cylinder

2008-2001 2378cc/2.4L, 2350cc/2.4L	
Seal	224460
2007-2002 2.0L (SOHC)(DOHC)	
Seal	223750
2002-1992 1834cc/1.8L	
Seal	223750
2002-1990 1468cc/1.5L	
Seal	223018
Repair Sleeve	KWK99114

CRANKSHAFT FRONT SEAL (cont.)

4 Cylinder (cont.)

2000-1990 1595cc/1.6L, 1755cc/1.8L, 1795cc/1.8L, 1997cc/2.0L, 2351cc/2.4L	
Seal	224460

6 Cylinder

2008-1990 2972cc/3.0L, 3496cc/3.5L, 3828cc/3.8L	
Seal	223750

CRANKSHAFT REAR SEAL

4 Cylinder

2008-2003 2.0L(SOHC)(DOHC), 2.4L(SOHC)	
Seal Viton	710235
2002-1992 1834cc/1.8L, 2350cc/2.4L(SOHC)	
Seal Viton	710235
2002-1990 1468cc/1.5L, 1597cc/1.6L, 1755cc/1.8L	
Seal	227235
2000-1990 1595cc/1.6L, 1795cc/1.8L, 1997cc/2.0L, 2351cc/2.4L	
Seal Viton	228005
Repair Sleeve	KWK99315
1999-1995 122/2.0L (DOHC)	
Seal Viton	710056
Seal PTFE H/D	5279

6 Cylinder

2008-2004 3828/3.8L	
Seal Viton	710056
2005-1990 2497cc/2.5L, 2967cc/3.0L	
Seal Viton	710056
Seal PTFE H/D	5279
2004-1997 3496cc/3.5L	
Seal Viton	710056

Mfg./Year Model & Location Part No. Mfg./Year Model & Location Part No.

MITSUBISHI - Minivan, SUV, Truck - Endeavor, Mighty Max, Montero, Montero Sport, Outlander, Raider PU, Van**FRONT WHEEL****FWD**

2009-2007	Outlander	
	Ball Bearing	WB000021[2] ²⁵
2009-2006	Endeavor (From 11/05)	
	Hub Unit Bearing	HA590177[2] ²⁵
2006-2004	Endeavor (Thru 10/05)	
	Hub Unit Bearing	HA590108[2] ²⁵
2006-2003	Outlander	
	Ball Bearing	510079[2]

RWD

2008-2006	Raider PU (2W-ABS)	
	Hub Unit Bearing	HA590034[2] ²⁵
2008-2006	Raider PU (4W-ABS)	
	Hub Unit Bearing	HA590035[2]
2000-1997	Montero, Montero Sport	
	Seal (Inner)	225875[2]
	Set	SET47[2]
1996-1990		
	Seal (Inner)	225010[2]
	Set (Inner)	SET5[2]
	Set (Outer)	SET3[2]

4WD

2009-2007	Outlander	
	Ball Bearing	WB000021[2] ²⁵
2008-2006	Raider PU (2W-ABS)	
	Hub Unit Bearing	HA590034[2] ²⁵
2008-2006	Raider PU (4W-ABS)	
	Hub Unit Bearing	HA590035[2]
2006-2001	Montero	
	Hub Unit Bearing	HA590145[2] ²⁵
2004-2001	Montero Sport	
	Seal (Inner)	225875[2]
	Set (Inner)	SET47[2]
	Set (Outer)	SET47[2]
2000-1990		
	Seal (Inner)	225875[2]
	Set (Inner)	SET47[2]
	Set (Outer)	SET47[2]

AWD

2009-2007	Outlander	
	Ball Bearing	WB000021[2] ²⁵
2009-2006	Endeavor (From 11/05)	
	Hub Unit Bearing	HA590177[2] ²⁵
2006	Raider PU (2W-ABS)	
	Hub Unit Bearing	HA590034[2] ²⁵
2006	Raider PU (4W-ABS)	
	Hub Unit Bearing	HA590035[2]
2006-2004	Endeavor (Thru 10/05)	
	Hub Unit Bearing	HA590108[2] ²⁵
2006-2003	Outlander	
	Ball Bearing	510079[2]

REAR WHEEL**FWD**

2009-2008	Outlander (2.4L)	
	Hub Unit Bearing	HA590256[2] ²⁵
2009-2007	Outlander (3.0L)	
	Hub Unit Bearing	HA590247[2] ²⁵
2009-2004	Endeavor (ABS)	
	Hub Unit Bearing	HA590143[2] ²⁵
2006-2005	Outlander LS	
	Hub Unit Bearing	HA590103 ²⁵
2005-2004	Endeavor (Non-ABS)	
	Hub Unit Bearing	HA590144[2] ²⁵
2004-2003	Outlander	
	Hub Unit Bearing	HA590103[2] ²⁵

RWD

2007-2006	Raider PU	
	Seal	8835S[2]
	Cylindrical Bearing	6408[2]
2004-2001	Montero Sport (Exc. Locking Diff.)	
	Seal (Inner)	4989[2]
	Bearing Assy (Inner)	30208M[2]
	Seal (Outer)	225010[2]
2004-2001	Montero Sport (Locking Diff.)	
	Seal (Inner)	4989[2]
	Ball Bearing (Inner)	516006[2]
	Seal (Outer)	710437[2]
1996-1992	Mighty Max	
	Seal (Inner)	4989[2]
	Bearing Assy (Inner)	30208M[2]
	Seal (Outer)	225010[2]
1991-1990	Mighty Max	
	Seal (Inner)	4989[2]
	Bearing Assy (Inner)	30208M[2]
	Seal (Outer)	225010[2]
1990	Van Wagon	
	Seal (Inner)	223550[2]
	Cone/Cup (Inner)	LM29749-LM29710[2]
	Seal (Outer)	224510[2]

4WD

2006-2001	Montero	
	Hub Unit Bearing	HA590039[2] ²⁵
2004-2001	Montero Sport (Exc. Locking Diff.)	
	Seal (Inner)	4989[2]
	Bearing Assy (Inner)	30208M[2]
	Seal (Outer)	225010[2]
2004-2001	Montero Sport (Locking Diff.)	
	Seal (Inner)	4989[2]
	Ball Bearing (Inner)	516006[2]
	Seal (Outer)	710437[2]
2000-1992	Montero	
	Seal (Inner)	4989[2]
	Ball Bearing (Inner)	516006[2]
	Seal (Outer)	710437[2]
1994-1992	Mighty Max	
	Seal (Inner)	4989[2]
	Bearing Assy (Inner)	30208M[2]
	Seal (Outer)	225010[2]

²⁵New Item, Check For Availability

Mfg./Year	Model & Location	Part No.	Mfg./Year	Model & Location	Part No.
MITSUBISHI - Minivan, SUV, Truck - Endeavor, Mighty Max, Montero, Montero Sport, Outlander, Raider PU, Van (cont.)					

REAR WHEEL (cont.)

4WD (cont.)

1991-1990	Mighty Max, Montero
Seal (Inner)	4989[2]
Bearing Assy (Inner)	30208M[2]
Seal (Outer)	225010[2]

AWD

2009-2008	Outlander (2.4L)
Hub Unit Bearing	HA590258[2] ²⁵
2009-2007	Outlander (3.0L)
Hub Unit Bearing	HA590249[2] ²⁵
2009-2004	Endeavor
Hub Unit Bearing	HA590120[2] ²⁵
2007-2006	Raider PU
Seal	8835S[2]
Cylindrical Bearing	6408[2]
2004-2003	Outlander
Ball Bearing	511013[2]

FRONT AXLE

Differential

2008-2006	(C205F)
Cone/Cup	LM102949-LM102911[2]
2003-1994	
Seal	710151[2]
Cone/Cup	17887-17831[2]
1993-1990	(4 Cyl.)
Seal	710335[2]
Cone/Cup	17887-17831[2]
Repair Sleeve	KWK99139[2]
1993-1990	(6 Cyl.)
Seal	710151[2]
Cone/Cup	17887-17831[2]

Pinion

2008-2006	(C205F)
Seal	710476
Cone/Cup (Inner)	M88048-M88010
2003-1994	
Seal	224570
Cone/Cup (Inner)	HM89449-HM89410
Cone/Cup (Outer)	M88043-M88010
Repair Sleeve	KWK99169
1993-1991	(6 Cyl.)
Seal	224570
Cone/Cup (Inner)	HM89449-HM89410
Cone/Cup (Outer)	M88043-M88010
Repair Sleeve	KWK99169
1993-1990	(4 Cyl.)
Seal	224255
Cone/Cup (Inner)	HM89449-HM89410
Cone/Cup (Outer)	M86649-M86610
Repair Sleeve	KWK99169
1990	(6 Cyl.)
Seal	1943
Cone/Cup (Inner)	HM89449-HM89410
Cone/Cup (Outer)	M88043-M88010
Repair Sleeve	KWK99169

FRONT AXLE

Steering Knuckle

1993-1990	
Seal	710146[2]

4WD FRONT AXLE

Axle Shaft

2008-2006	Raider PU
Seal	710489[2] ²⁵

REAR AXLE

Differential Rebuild Kit

2007-2006	Raider PU
Kit	DRK304A ²⁵

Differential

2008-2006	(9.25" R.G.)
Cone/Cup	JLM704649-JLM704610[2]
2005-2003	Outlander
Seal	223543[2]
Bearing Assy	30207M[2]
2003-2001	Montero
Cone/Cup	17887-17831[2]
2000-1990	
Cone/Cup	17887-17831[2]

Pinion

2008-2006	(8.25" R.G.)
Seal	710480
Cone/Cup (Inner)	M802048-M802011
Cone/Cup (Outer)	M86649-M86610
2008-2006	(9.25" R.G.)
Seal	710481
Cone/Cup (Inner)	M804049-M804010
Cone/Cup (Outer)	M88048-M88010
2005-2003	Outlander
Seal	471847N
Bearing Assy (Inner)	32207M
Bearing Assy (Outer)	30305C
2004-2001	Montero
Seal	224570
Cone/Cup (Inner)	HM89249-HM89210
Cone/Cup (Outer)	M88043-M88010
Repair Sleeve	KWK99177
2000-1994	Mighty Max, Montero
Seal	224570
Cone/Cup (Inner)	HM89249-HM89210
Cone/Cup (Outer)	M88043-M88010
Repair Sleeve	KWK99177
1993-1990	Mighty Max, Montero (4 Cyl.)
Seal	224570
Cone/Cup (Inner)	HM89449-HM89410
Cone/Cup (Outer)	M88043-M88010
Repair Sleeve	KWK99177

²⁵New Item, Check For Availability

Mfg./Year	Model & Location	Part No.	Mfg./Year	Model & Location	Part No.
MITSUBISHI - Minivan, SUV, Truck - Endeavor, Mighty Max, Montero, Montero Sport, Outlander, Raider PU, Van (cont.)					

REAR AXLE (cont.)**Pinion (cont.)**

1993-1990	Mighty Max, Montero (6 Cyl.)
Seal (All)	224570
Cone/Cup (Inner)	HM89249-HM89210
Cone/Cup (Outer)	M88043-M88010
Repair Sleeve	KWK99177
1990	Van Wagon
Seal	224570
Cone/Cup (Inner)	HM89449-HM89410
Cone/Cup (Outer)	M88043-M88010
Repair Sleeve	KWK99177

TRANSFER CASE REBUILD KIT

2002-1991	(KM120)
Kit	TRKFM220
1996-1990	(KM100)
Kit	TRKFM230

TRANSFER CASE**Input Shaft**

2008-2006	(New Process 243)
Ndle Bearing (Pilot)	FC66561
2003-1990	(V4AC1, V4AW2, V5M21)
Seal	1992
Repair Sleeve	KWK99177
Ball Bearing	5209W
1997-1990	(V5MT1)
Seal	224560
Repair Sleeve	KWK99177
Ball Bearing	5209W

Front Output Shaft

2008-2006	(New Process 244HD)
Seal	3946
Repair Sleeve	KWK99187
2006-1990	
Seal	223608
Repair Sleeve	KWK99146
Ball Bearing	306TB

Rear Output Shaft

2003-1990	
Seal	224052
Repair Sleeve	KWK99157
Ball Bearing	211TB

Drive Sprocket

2003-1990	
Ball Bearing	307TB

4-SPEED AUTOMATIC TRANSMISSION**Torque Converter**

2002-1990	(Aisin)
Seal	223830
Repair Sleeve	KWK99147
1996-1990	(A500)
Seal	331228H
Repair Sleeve	KWK99149

Rear Seal/Ext. Housing

2002-1995	(Aisin 03 40)
Seal	225005
1996-1990	(A500)(4WD)
Seal	710058
Ball Bearing	207XLO[2]
1996-1990	(A500)(RWD)
Seal	7300S
Ball Bearing	207XLO[2]
Seal Kit	5206 ⁶⁴
1994-1990	(Aisin 03 72)
Seal	710319

Selector Shaft Seal/Man. Shaft

2003-1995	(Aisin 03 40)
Seal	221207
Repair Sleeve	KWK99049
1996-1990	(A500)
Seal	8609

CLUTCH**Pilot Bearing**

1996-1990	6 Cyl. 3.0
Ball Bearing	203FF
1996-1990	4 Cyl. 2.0, 2.4, 2.6
Ball Bearing	102CC

Release Bearing

1999-1990	2972cc/3.0L
Bearing Assy	614107
1999-1990	2350cc/2.4L
Bearing Assy	614016

5-SPEED MANUAL TRANSMISSION**Transmission Rebuild Kit**

2001-1990	(V5MT1 2)
Kit	TRKFM200
2000-1990	Montero (4WD)(V6)
Kit	TRKFM200
1999-1990	(R5M21)
Kit	TRKFM130

Front Input Shaft

1996-1990	
Seal	223014
Ball Bearing	307L[2]
Repair Sleeve	KWK99114

Countershaft

1996-1990	(KM132 1)
Bearing Assy	30205M[2]
1993-1990	(KM132 E, KM132 9, KM145 2, KM145 4, KM145 8)
Cone/Cup	XAA30205-YAA30205[2]

⁶⁴Seal & Bushing Kit

Mfg./Year	Model & Location	Part No.	Mfg./Year	Model & Location	Part No.
MITSUBISHI - Minivan, SUV, Truck - Endeavor, Mighty Max, Montero, Montero Sport, Outlander, Raider PU, Van (cont.)					

5-SPEED MANUAL TRANSMISSION

Rear Output Shaft

1996-1990 (KM132 1, KM145 8, KM145 9)	
Seal	223608
Ball Bearing	511014[2]

4-SPEED AUTOMATIC TRANSAXLE

Torque Converter / Frt Pump

2004-2003 (F4A42 2, W4A42 2)	
Seal	320583

ALTERNATOR

1994-1991 110 Amp.	
Ball Bearing (Drive End)	303CC
1994-1990 65 Amp.	
Ball Bearing (Drive End)	302CC

DRIVESHAFT SUPPORT

1994-1992 Mighty Max	
Hanger Bearing Assy	HB22
1991-1990 Mighty Max (2WD)	
Hanger Bearing Assy	HB14
1991-1990 Mighty Max (4WD)	
Hanger Bearing Assy	HB30[2]

OIL PUMP

4 Cylinder

2006-2003 2351cc/2.4L, 2378cc/2.4L	
Seal	222025
Repair Sleeve	KWK99078
1999-1990 2351cc/ 2.4L	
Seal	222025
Repair Sleeve	KWK99078

CAMSHAFT SEAL

4 Cylinder

2006-2003 2.4L	
Seal	3771
1999-1990 2000/2.0L, 2300/2.3L (Diesel), 2350/2.4L	
Seal	3771
Repair Sleeve	KWK99139

6 Cylinder

2006-2004 230/3.8L (SOHC)	
Seal	3771
2004-1997 215/3.5L (SOHC)	
Seal	3771
2003-1990 2972cc/3.0L	
Seal	3771[2]
Repair Sleeve	KWK99139[2]
2002-1994 3500/3.5L (DOHC)	
Seal (Frt)	223010[2]
Seal (Rr)	710302[2]
Repair Sleeve	KWK99114[4]

CRANKSHAFT FRONT SEAL

4 Cylinder

2006-2003 2.4L	
Seal	224460
1999-1990 2000/2.0L, 2300/2.3L (Diesel), 2350/2.4L	
Seal	224460

6 Cylinder

2008-2006 226/3.7L	
Seal	710472
2006-2003 3828/3.8L	
Seal	223750
2004-1994 3500/3.5L (DOHC)	
Seal	223750
2003-1990 2972cc/3.0L	
Seal	223750

CRANKSHAFT REAR SEAL

4 Cylinder

2006-2003 2.4L	
Seal Viton	710235
1999-1990 2000/2.0L, 2300/2.3L (Diesel), 2350/2.4L	
Seal Viton	228005
Repair Sleeve	KWK99315

6 Cylinder

2008-2006 226/3.7L	
Seal	710471
2006-1994 3500/3.5L, 3797 3.8L	
Seal Viton	710056
2003-1990 2972cc/3.0L	
Seal Viton	710056
Seal PTFE H/D	5279

Mfg./Year	Model & Location	Part No.	Mfg./Year	Model & Location	Part No.
-----------	------------------	----------	-----------	------------------	----------

NISSAN/DATSUN - FRONT WHEEL DRIVE - Altima, Axxess, Maxima, NX, Pulsar, Sentra, Stanza, Versa

FRONT WHEEL**FWD**

2009	Maxima	
	Hub Unit Bearing	HA590252[2] ²⁵
2009-2007	Altima (2.5L)(ABS), Hybrid	
	Hub Unit Bearing	HA590250[2] ²⁵
2009-2007	Altima (3.5L)(ABS)	
	Hub Unit Bearing	HA590252[2] ²⁵
2009-2007	Sentra (Non-ABS)	
	Hub Unit Bearing	HA590276[2] ²⁵
2009-2007	Sentra S, SL (ABS)	
	Hub Unit Bearing	HA590277[2] ²⁵
2009-2007	Versa	
	Hub Unit Bearing	HA590285[2] ²⁵
2008-2007	Sentra SE-R (ABS)	
	Hub Unit Bearing	HA590278[2] ²⁵
2008-2000	Maxima	
	Hub Unit Bearing	HA590600K[2] ⁶⁷
	Ball Bearing (Opt)	510060[2] ²⁵
2007	Altima (2.5L)(Non-ABS)	
	Hub Unit Bearing	HA590251[2] ²⁵
2006-2002	Altima (2.5L)	
	Ball Bearing	510060[2]
2006-2002	Altima (3.5L)	
	Hub Unit Bearing	HA590600K[2] ⁶⁷
	Ball Bearing (Opt)	510060[2] ²⁵
2006-2000	Sentra	
	Ball Bearing	510061[2]
2001-1998	Altima (Non-ABS)	
	Ball Bearing (Inner)	510068[2]
	Seal	710108[2]
2001-1993	Altima (ABS)	
	Ball Bearing (Inner)	510009[2]
	Seal	710108[2]
1999-1991	Sentra	
	Seal (Inner)	710127[2]
	Ball Bearing (Inner)	514002B[2]
	Seal (Outer)	710125[2]
1999-1990	Maxima	
	Ball Bearing	510009[2]
	Seal	710108[4]
1998-1995	200SX	
	Seal (Inner)	710127[2]
	Ball Bearing (Inner)	514002B[2]
	Seal (Outer)	710125[2]
1993-1991	NX	
	Seal (Inner)	710127[2]
	Ball Bearing (Inner)	514002B[2]
	Seal (Outer)	710125[2]
1992-1990	Axxess	
	Ball Bearing (Inner)	510009[2]
	Seal	710108[2]
1992-1990	Stanza	
	Ball Bearing	510009[2]
	Seal	710108[4]
1990	Micra, Multi Wagon, Multi Wagon	
	Ball Bearing	510054[2]
1990	Pulsar	
	Seal	710107[2]
	Ball Bearing	510008[2]

FRONT WHEEL (cont.)**FWD (cont.)**

1990	Sentra	
	Seal	710107[2]
	Ball Bearing	510008[2]

AWD

1990	Axxess	
	Ball Bearing	510009[2]
	Seal	710108[4]

REAR WHEEL**FWD**

2009	Maxima	
	Hub Unit Bearing	HA590253[2] ²⁵
2009-2007	Altima (ABS), Hybrid	
	Hub Unit Bearing	HA590253[2] ²⁵
2009-2007	Sentra (Non-ABS)	
	Hub Unit Bearing	HA590279[2] ²⁵
2009-2007	Sentra S, SL (ABS)	
	Hub Unit Bearing	HA590280[2]
2009-2007	Sentra SE-R (ABS)	
	Hub Unit Bearing	HA590281[2] ²⁵
2009-2007	Versa (ABS)	
	Hub Unit Bearing	HA590288[2] ²⁵
2009-2007	Versa (Non-ABS)	
	Hub Unit Bearing	HA590286[2] ²⁵
2008-2004	Maxima	
	Hub Unit Bearing	HA590111[2] ²⁵
2007	Altima (2.5L)(Non-ABS)	
	Hub Unit Bearing	HA590254[2] ²⁵
2006-2002	Altima (ABS)	
	Hub Unit Bearing	512201[2]
2006-2002	Altima (Non-ABS)	
	Hub Unit Bearing	512202[2]
2006-2000	Sentra (ABS)	
	Hub Unit Bearing	HA590110[2] ²⁵
2003-2000	Maxima	
	Hub Unit Bearing	512203[2]
2001-1998	Altima (ABS)(Disc)	
	Hub Unit Bearing	HA590047[2] ²⁵
2001-1998	Altima (ABS)(Drum)	
	Hub Unit Bearing	HA590043[2] ²⁵
2001-1998	Altima (Non-ABS)	
	Hub Unit Bearing	512016[2]
1999-1997	Maxima (ABS)	
	Hub Unit Bearing	HA590153[2] ²⁵
1999-1995	Maxima (Non-ABS)	
	Hub Unit Bearing	HA590154[2] ²⁵
1999-1991	Sentra (Non-ABS)	
	Hub Unit Bearing	512025[2]
1998-1995	200SX (Non-ABS)	
	Hub Unit Bearing	512025[2]
1997-1993	Altima	
	Hub Unit Bearing	(ABS, Non-ABS) 512016[2]
1995-1990	Axxess	
	Hub Unit Bearing	512016[2]
1992-1990	Stanza (Non-ABS)	
	Hub Unit Bearing	512016[2]

²⁵New Item, Check For Availability⁶⁷Kit = Flg, Brg, Nut, & Snap Ring

Mfg./Year Model & Location Part No. Mfg./Year Model & Location Part No.

NISSAN/DATSUN - FRONT WHEEL DRIVE - Altima, Axxess, Maxima, NX, Pulsar, Sentra, Stanza, Versa (cont.)

REAR WHEEL (cont.)

FWD (cont.)

1990	Pulsar	
Ball Bearing	513071[2]
1990	Sentra	
Ball Bearing	513071[2]

4WD

1995-1990	Axxess	
Ball Bearing (Inner)	510009[2]
Seal	710108[2]

AWD

1990	Axxess	
Ball Bearing (Inner)	510009[2]
Seal	710108[2]

TRANSFER CASE REBUILD KIT

1995-1990	(TY10B)	
Kit	TRKFN500 ²⁵

TRANSFER CASE

Input Shaft

1990	(TX10)	
Seal	225035

Front Output Shaft

1990		
Seal	226018
Repair Sleeve	KWK99235

Selector Shaft Seal/Man. Shaft

1992-1990	(TY10)	
Seal	710243
Repair Sleeve	KWK99098

CLUTCH - 4 CYLINDER

Pilot Bearing

2002-1990		
Bushing	PB22

CLUTCH - 6 CYLINDER

Pilot Bearing

2002-1990		
Bushing	PB22

CLUTCH - 4 CYLINDER

Release Bearing

2001-1991	1998cc./2.0L (DOHC)(215mm Cl.)	
Bearing Assy	614047
1999-1990	1597cc./1.6L (190mm Cl.)	
Bearing Assy	614047
1992-1990	2389cc./2.4L (225mm Cl.)	
Bearing Assy	614157

CLUTCH - 6 CYLINDER

Release Bearing

1992-1990	2960cc/3.0L, 2988cc/3.0 (DOHC)	
Bearing Assy	614049

3-SPEED AUTOMATIC TRANSAXLE

Differential

1992-1990	(RL3F01A, RN3F01A)	
Bearing Assy (LH)	32013X
Bearing Assy (RH)	30208M

Torque Converter

1992-1990	(RL3F01A, RN3F01A)	
Seal	224979

Output Shaft

1992-1990	(RL3F01A)	
Seal Viton	224026[2]
Repair Sleeve	KWK99157[2]
Bearing Assy (RH)	32006[2]
Bearing Assy (LH)	32007X[2]
1990	(RN3F01A)	
Seal	710122[2]
Bearing Assy (RH)	32006[2]
Bearing Assy (LH)	32007X[2]

4-SPEED AUTOMATIC TRANSAXLE

Differential

2005-1992	(RE4F04A)	
Bearing Assy	32009XM[2]
2002-1998	(RL4F03V)	
Bearing Assy (LH)	32008XM
2002-1991	(RL4F03A, RE4F03A)	
Ball Bearing	208[2]
2001-2000	(RE4F03B)	
Bearing Assy	32008XM[2]
2001-1992	(RE4F04V)	
Bearing Assy (LH)	32009XM
Bearing Assy (RH)	32013X
1994-1991	(RL4F03V)	
Bearing Assy (LH)	32008XM
1994-1990	(RE4F02A, RL4F02A)	
Bearing Assy (LH)	32013X
Bearing Assy (RH)	30208M
1992-1990	(RE4F02V)	
Bearing Assy (LH)	32010X
Bearing Assy (RH)	32013X

Torque Converter / Frt Pump

2002-1991	(RL4F03A, RE4F03A, RL4F03V)	
Seal	710442
2001-1990	(RE4F02A, RE4F02V, RL4F02A, RE4F04A, RE4F04V)	
Seal	224663
Repair Sleeve	KWK99181

²⁵New Item, Check For Availability

NISSAN/DATSUN - FRONT WHEEL DRIVE - Altima, Axxess, Maxima, NX, Pulsar, Sentra, Stanza, Versa (cont.)

4-SPEED AUTOMATIC TRANSAXLE

Output Shaft

2006-1992 (RE4F04A, RE4F04B)	
Seal (LH)	710118
Seal (RH)	710124
2001-1992 (RE4F04V)	
Seal (LH)	710397
Seal (RH)	710124
2001-1991 (RL4F03A, RE4F03A)	
Seal Viton	224026[2]
2001-1991 (RL4F03V)	
Seal (LH)	710132
Seal (RH)	710133
1994-1990 (RE4F02A, RE4F02V)	
Seal (LH)	710123
Seal (RH)	710124
1992-1990 (RL4F02A)(4WD)	
Seal	226018[2]

Manual Shaft

2006-1991	
Seal	221207

5-SPEED AUTOMATIC TRANSAXLE

Torque Converter

2007-2004 (RE5F22A)	
Seal	222830
Repair Sleeve	KWK99147

Output Shaft

2007-2004 (RE5F22A)	
Seal	4764[2]

Manual Shaft

2007-2004 (RE5F22A)	
Seal	221207
Repair Sleeve	KWK99049

4-SPEED MANUAL TRANSAXLE

Differential

1990 (RN4F31A)	
Bearing Assy	30208M[2]

Input Shaft

1990 (RN4F31A)	
Seal	710316
Ball Bearing	305AG[2]
Repair Sleeve	KWK99098

Output Shaft

1990 (RN4F31A)	
Seal Viton	224026[2]
Repair Sleeve	KWK99157[2]

5-SPEED MANUAL TRANSAXLE

Differential

2002-1991 (RS5F32V)	
Bearing Assy (LH)	32010X
2002-1990 (RS5F31A)(RS5F32A)	
Bearing Assy	32010X[2]
2001-1990 (RS5F50A)	
Bearing Assy	32009XM[2]
2001-1990 (RS5F50V)	
Bearing Assy (LH)	32009XM
Bearing Assy (RH)	32013X
1991-1990 (RS5F30A)	
Bearing Assy	30208M[2]

Input Shaft

2002-1991 (RS5F32A)(RS5F32V)	
Seal	710316
Ball Bearing	305AG[2]
Repair Sleeve	KWK99098
2001-1990 (RS5F50A)(RS5F50V)	
Seal	710119
Ball Bearing	108A[2]
Repair Sleeve	KWK99111
1999-1990 (RS5F30A)(RS5F31A)	
Seal	710316
Ball Bearing	305AG[2]
Repair Sleeve	KWK99098

Output Shaft

2002-1998 (RS5F32A)	
Seal	710132[2]
2002-1991 (RS5F32V)	
Seal (LH)	710132
Seal (RH)	710133
2001-1990 (RS5F50A)	
Seal (LH)	710118
Bearing Assy (LH)	32206M[2]
Seal (RH)	710124
Bearing Assy (RH)	30306M[2]
2001-1990 (RS5F50V)	
Seal (LH)	710397
Seal (RH)	710124
1999-1990 (RS5F31A)	
Seal (LH)	225210
Seal (RH)	710134
1991-1990 (RS5F30A)	
Seal Viton	224026[2]
Bearing Assy	30304[2]
Repair Sleeve	KWK99157[2]

ALTERNATOR

1994-1992 Mitsubishi 110 Amp.	
Ball Bearing (Drive End)	303CC
1994-1990 Hitachi 70, 80, 90 Amp.	
Ball Bearing (Drive End)	303CC

Mfg./Year Model & Location Part No. Mfg./Year Model & Location Part No.

NISSAN/DATSUN - FRONT WHEEL DRIVE - Altima, Axxess, Maxima, NX, Pulsar, Sentra, Stanza, Versa (cont.)

BALANCE SHAFT

4 Cylinder

1990 1597cc/1.6L
 Seal 710415
 Repair Sleeve KWK99128

CAMSHAFT SEAL

4 Cylinder

2001-1991 1597cc/1.6L (DOHC),
 1998cc/2.0 (DOHC)
 Seal 223420[2]
 Repair Sleeve KWK99134[2]
 1990 1487cc/1.5L, 1597cc/1.6L
 Seal 224020
 Repair Sleeve KWK99157

6 Cylinder

1994-1992 2960cc/3.0L (DOHC)
 Seal 224052[4]
 Repair Sleeve KWK99157[4]
 1994-1990 2960cc/3.0L
 Seal 224052[2]
 Repair Sleeve KWK99157[2]

CRANKSHAFT FRONT SEAL

4 Cylinder

2008-2002 2488cc/2.5L
 Seal 224650
 Repair Sleeve KWK99181
 2006-2000 1800/1.8L
 Seal 224052
 2001-1991 1998cc/2.0L
 Seal 224650
 Repair Sleeve KWK99181
 2001-1990 2389cc/2.4L
 Seal 224650
 1999-1991 1600/ 1.6L (DOHC)
 Seal 710308
 Repair Sleeve KWK99157
 1993-1990 1600/ 1.6L (SOHC)
 Seal 223602
 Repair Sleeve KWK99146

6 Cylinder

2008-2004 3498cc/3.5L (DOHC)
 Seal 710356
 2003-2002 3498cc/3.5L (DOHC)
 Seal 710356
 2001-1995 2988cc/3.0L
 Seal 710356
 Repair Sleeve KWK99189

CRANKSHAFT REAR SEAL

4 Cylinder

2008-1995 1597cc/1.6L(DOHC),
 1769cc/1.8L(DOHC),
 1998cc/2.0L(DOHC),
 2488cc/2.5L(DOHC)
 Seal PTFE H/D 228411 ²⁵
 2001-1991 2389cc/2.4L
 Seal 228009
 Repair Sleeve KWK99315
 1994-1990 1597cc/1.6L, 1598cc/1.6L,
 1680cc/1.7L, 1809cc/1.8L,
 1974cc/2.0L, 1998cc/2.0L
 Seal Viton 228410

6 Cylinder

2008-2002 3498cc/3.5L (DOHC)
 Seal Viton 710363
 2001-1995 2988cc/3.0L
 Seal Viton 710363
 1995-1990 2960cc/3.0L
 Seal Viton 228410

²⁵New Item, Check For Availability

NISSAN/DATSUN - REAR WHEEL DRIVE - Maxima, 240SX, 240Z, 300ZX, 350Z**FRONT WHEEL****RWD**

2009-2003	350Z	
Hub Unit Bearing	HA590027[2] ²⁵	
1998-1990	240SX	
Ball Bearing	510031[2]	
1996-1990	300ZX	
Seal	710108[2]	
Bearing Assy	513244[2]	

REAR WHEEL**RWD**

2009-2003	350Z	
Bearing Module	BM500006[2] ²⁵	
1998-1990	240SX	
Bearing Module	512014[2]	
1996-1991	300ZX (Exc. Turbo)	
Seal	710129[2]	
Bearing Module (1.675" Bore)	511011[2]	
1996-1990	300ZX (Turbo)	
Seal	710130[2]	
1993-1991	NX1600, NX2000	
Ball Bearing	513071[2]	
1990	300ZX (Exc. Turbo)(Thru 2/90)	
Seal	710129[2]	
Bearing Module	512014[2]	

REAR AXLE**Differential**

2002-1998	(C200B Axle)	
Bearing Assy	30209C[2]	
2002-1990	(H233, H233B, H233BS Axles)	
Cone/Cup	17887-17831[2]	
1998-1990	(R230 Axle)	
Seal	710135[2]	
Bearing Assy	32211M[2]	
1998-1990	(R200, R200A, R200KV, R200V Axles)	
Seal	223542[2]	
Bearing Assy	30209C[2]	
1995-1990	(H190, H190A, H190B Axles)	
Seal	1167S[2]	
Bearing Assy	30208M[2]	
1995-1990	(R180, R180A Axles)	
Seal	1167S[2]	
Bearing Assy	30208M[2]	
1993-1990	(C200, C200B Axles)	
Bearing Assy	30209C[2]	

Pinion

2002-1998	(C200B Axle)	
Seal	710245	
Bearing Assy (Outer)	32306C	
Repair Sleeve	KWK99166	
2002-1998	(H233BS Axle)	
Bearing Assy (Inner)	32308	
Seal (Outer)	710245	
Bearing Assy (Outer)	32306C	
Repair Sleeve	KWK99166	

4-SPEED AUTOMATIC TRANSMISSION**Torque Converter**

1996-1990	(RE4R01A, RE4R03A)	
Seal	224450	
Repair Sleeve	KWK99181	

Rear Seal/Ext. Housing

1996-1990	(E4N71B, RE4R01A, RE4R03A)	
Seal	223801	

Selector Shaft Seal/Man. Shaft

1996-1990	(RE4R01A, RE4R03A)	
Seal	2027	

CLUTCH**Pilot Bearing**

1996-1990	(6 Cyl.)	
Bushing	PB22	
1995-1990	4 Cyl. (1.6 and larger)	
Bushing	PB22	
1995-1990	4 Cyl. (under 1.6)	
Bushing	PB21	

Release Bearing

1998-1990	240SX	
Bearing Only	613015	
1997-1990	300ZX	
Bearing Only	613015	
1996-1995	200SX SE R	
Bearing Assy	614047	
1996-1994	200SX	
Bearing Assy	614047	
1993-1991	NX 1600, 2000	
Bearing Assy	614047	

5-SPEED MANUAL TRANSMISSION**Transmission Rebuild Kit**

1996-1990	(FS5R30A)	
Kit	TRKFN150	
1996-1990	(FS5W71H, FS5W71M, FS5W71N, FS5W71S)	
Kit	TRKFN110	

Front Input Shaft

1998-1995	(FS5W71C)	
Seal	1981	
Repair Sleeve	KWK99114	
1998-1990	(FS5R30A)	
Seal	1981	
Ball Bearing	1308L[2]	
Repair Sleeve	KWK99114	
1994-1990	(FS5W71A, FS5W71B, FS5W71C)	
Seal	1981	
Ball Bearing	306LO[2]	
Repair Sleeve	KWK99114	

²⁵New Item, Check For Availability

Mfg./Year Model & Location Part No. Mfg./Year Model & Location Part No.

NISSAN/DATSUN - REAR WHEEL DRIVE - Maxima, 240SX, 240Z, 300ZX, 350Z (cont.)

5-SPEED MANUAL TRANSMISSION

Countershaft

1998-1990 (FS5W71A, FS5W71B, FS5W71C)
 Ball Bearing (Center)305AG[2]
 Ball Bearing (Rr) 204[2]

Rear Output Shaft

1998-1990 (FS5R30A)
 Seal224215
 Ball Bearing307L[2]
 1998-1990 (FS5W71A, FS5W71B, FS5W71C)
 Seal 710324
 Ball Bearing 306TB[2]

Extension Housing

1998-1990 (FS5W71A, FS5W71B, FS5W71C)
 Ball Bearing 205BB[2]
 1994-1990 (FS5R30A)
 Ball Bearing307L[2]

ALTERNATOR

1994-1992 Mitsubishi 110 Amp.
 Ball Bearing (Drive End)303CC
 1994-1990 Hitachi 70 Amp.
 Ball Bearing (Drive End)303CC
 1994-1990 Hitachi 80 Amp.
 Ball Bearing (Drive End)303CC
 1994-1990 Hitachi 90 Amp.
 Ball Bearing (Drive End)303CC

DRIVESHAFT SUPPORT

1998-1990 240SX
 Hanger Bearing Assy HB6[2]
 Ball Bearing 206FF[2]

CAMSHAFT SEAL

6 Cylinder

1996-1990 2960cc/3.0L (DOHC)
 Seal224052[4]
 Repair SleeveKWK99157[4]

CRANKSHAFT FRONT SEAL

4 Cylinder

2002-1990 1998cc/2.0L, 2389cc/2.4L
 Seal 224650
 Repair SleeveKWK99181
 2001-1990 1597cc/1.6L
 Seal 710308
 Repair SleeveKWK99157

6 Cylinder

2008-2003 3498cc/3.5L
 Seal 710356

CRANKSHAFT FRONT SEAL (cont.)

6 Cylinder (cont.)

2002-1990 2960cc/3.0L, 3274cc/3.3L
 Seal 224052
 Repair SleeveKWK99157
 2001-1995 2988cc/3.0L (DOHC)
 Seal 710356
 Repair SleeveKWK99189
 1996-1990 2960cc/3.0L (VG30, VG30E, VG30T)
 Seal 223340

CRANKSHAFT REAR SEAL

4 Cylinder

2002-1990 2389cc/2.4L
 Seal 228009
 Repair SleeveKWK99315
 2001-1990 1597cc/1.6L, 1598cc/1.6L, 1680cc/1.7L, 1809cc/1.8L, 1974cc/2.0L, 1998cc/2.0L
 Seal Viton 228410

6 Cylinder

2008-2003 3498cc/3.5L (DOHC)
 Seal Viton 710363
 2002-1996 3274cc/3.3L
 Seal Viton 228410
 2001-1995 2988cc/3.0L
 Seal Viton 710363
 1996-1995 2960cc/3.0L
 Seal PTFE H/D 228411[2]²⁵
 1994-1990 2960cc/3.0L
 Seal Viton 228410

²⁵New Item, Check For Availability

Mfg./Year	Model & Location	Part No.	Mfg./Year	Model & Location	Part No.
NISSAN/DATSUN - AWD/FWD - CUV, Minivan, SUV - Murano, Rogue, Quest					

FRONT WHEEL**FWD**

2009	Murano	
	Hub Unit Bearing	HA590236[2] ²⁵
2009-2008	Rogue	
	Hub Unit Bearing	HA590239[2] ²⁵
2009-2004	Quest	
	Hub Unit Bearing	HA590046[2] ²⁵
2008-2003	Murano	
	Hub Unit Bearing	HA590046[2] ²⁵
2002-1993	Quest	
	Ball Bearing	510028[2]

AWD

2009	Murano	
	Hub Unit Bearing	HA590236[2] ²⁵
2009-2008	Rogue	
	Hub Unit Bearing	HA590239[2] ²⁵
2008-2003	Murano	
	Hub Unit Bearing	HA590046[2] ²⁵

REAR WHEEL**FWD**

2009	Murano	
	Hub Unit Bearing	HA590237[2] ²⁵
2009-2008	Rogue	
	Hub Unit Bearing	HA590241[2] ²⁵
2009-2004	Quest	
	Hub Unit Bearing	HA590109[2] ²⁵
2007-2003	Murano	
	Hub Unit Bearing	HA590045[2] ²⁵
2002-1999	Quest	
	Hub Unit Bearing	HA590057[2]
1998-1993		
	Ball Bearing	511008[2]

AWD

2009	Murano	
	Hub Unit Bearing	HA590238[2] ²⁵
2009-2008	Rogue	
	Hub Unit Bearing	HA590235[2] ²⁵
2007-2003	Murano	
	Hub Unit Bearing	HA590044[2] ²⁵

4-SPEED AUTOMATIC TRANSAXLE**Differential**

2002-1993	(RE4F04A)	
	Bearing Assy	32009XM[2]

Torque Converter / Frt Pump

2002-1993	(RE4F04A)	
	Seal	224663

4-SPEED AUTOMATIC TRANSAXLE**Output Shaft**

2006-1993	(RE4F04A, RE4F04B)	
	Seal (LH)	710118
	Seal (RH)	710124

Oil Pump

2002-1993	(RE4F04A)	
	Seal	224450

Manual Shaft

2002-1993	(RE4F04A)	
	Seal	221207

5-SPEED AUTOMATIC TRANSAXLE**Torque Converter**

2007-2004	(RE5F22A)	
	Seal	222830
	Repair Sleeve	KWK99147

Output Shaft

2007-2004	(RE5F22A)	
	Seal	4764

Manual Shaft

2007-2004	(RE5F22A)	
	Seal	221207
	Repair Sleeve	KWK99049

A/C COMPRESSOR

1998-1993	(Cl. Pulley)(Nippondenso FX 15)	
	Ball Bearing	5106WCC[2]

ALTERNATOR

1998-1993	Mitsubishi 110 Amp.	
	Ball Bearing (Drive End)	303CC

CAMSHAFT SEAL**6 Cylinder**

2002-1999	3275/3.3L	
	Seal	224052[2]
	Repair Sleeve	KWK99157[2]
1998-1993	2960cc/3.0L	
	Seal	223420[2]
	Repair Sleeve	KWK99134[2]

CRANKSHAFT FRONT SEAL**4 Cylinder**

2008	2488cc/2.5L	
	Seal	224650
	Repair Sleeve	KWK99181

²⁵New Item, Check For Availability

Mfg./Year	Model & Location	Part No.	Mfg./Year	Model & Location	Part No.
NISSAN/DATSUN - AWD/FWD - CUV, Minivan, SUV - Murano, Rogue, Quest (cont.)					

CRANKSHAFT FRONT SEAL

6 Cylinder

2007-2003	3498cc/3.5L	
Seal	710236
Repair Sleeve	KWK99189
2002-1999	3275/3.3L	
Seal	224052
Repair Sleeve	KWK99157
1998-1993	2960cc/3.0L	
Seal	224052
Repair Sleeve	KWK99157

CRANKSHAFT REAR SEAL

4 Cylinder

2008	2488cc/2.5L	
Seal PTFE H/D	228411 ²⁵

CRANKSHAFT REAR SEAL

6 Cylinder

2007	3498cc/3.5L	
Seal Viton	710363
2002-1999	3275/3.3L	
Seal PTFE H/D	228411 ²⁵
1998-1993	2960cc/3.0L	
Seal Viton	228410

NISSAN/DATSUN - 4WD/RWD - SUV, Truck - Armada, D21, Frontier, Pathfinder, Titan, Xterra, X-Trail

FRONT WHEEL

RWD

2009	Armada	
Hub Unit Bearing	HA590284[2] ²⁵
2009	Titan PU	
Hub Unit Bearing	HA590284[2] ²⁵
2009-2005	Frontier	
Hub Unit Bearing	SP450702[2] ⁷⁸
2009-2005	Pathfinder	
Hub Unit Bearing	SP450702[2] ⁷⁸
2009-2005	Xterra	
Hub Unit Bearing	SP450702[2] ⁷⁸
2008	Armada	
Hub Unit Bearing	SP500703[2] ²⁵
2008-2004	Titan PU	
Hub Unit Bearing	SP500701[2] ⁷⁸
2007-2004	Armada	
Hub Unit Bearing	SP500701[2] ⁷⁸
2004-2000	Frontier (6 Cyl.)	
Seal (Inner)	710072[2]
Set (Inner)	SET37[2]
Cone/Cup (Outer)	LM300849-LM300811[2]
2004-2000	Xterra	
Seal (Inner)	710072[2]
Set (Inner)	SET37[2]
Cone/Cup (Outer)	LM300848-LM300811[2]
2004-1998	Frontier (4 Cyl.)	
Set (Inner)	SET5[2]
Set (Outer)	SET3[2]
Seal	710478 ²⁵
2004-1990	Pathfinder	
Seal (Inner)	710072[2]
Set (Inner)	SET37[2]
Cone/Cup (Outer)	LM300849-LM300811[2]
1997-1990	D21 Hardbody	
Seal (Inner)	710073[2]
Set (Inner)	SET5[2]
Set (Outer)	SET3[2]

4WD

2009	Armada	
Hub Unit Bearing	HA590284[2] ²⁵
2009	Titan PU	
Hub Unit Bearing	HA590284[2] ²⁵
2009-2005	Frontier	
Hub Unit Bearing	SP450701[2] ⁷⁸
2009-2005	Pathfinder	
Hub Unit Bearing	SP450701[2] ⁷⁸
2009-2005	Xterra	
Hub Unit Bearing	SP450701[2] ⁷⁸
2008	Armada	
Hub Unit Bearing	SP500703[2] ²⁵
2008-2004	Titan PU	
Hub Unit Bearing	SP500701[2] ⁷⁸
2007-2004	Armada	
Hub Unit Bearing	SP500701[2] ⁷⁸
2004-2000	Frontier (4 Cyl.)	
Set (Inner)	SET5[2]
Set (Outer)	SET3[2]
2004-2000	Xterra, Frontier (6 Cyl)	
Seal (Inner)	710072[2]
Set (Inner)	SET37[2]
Cone/Cup (Outer)	LM300849-LM300811[2]
2004-1990	Pathfinder	
Set (Inner)	SET37[2]
Seal (Outer)	710072[2]
Cone/Cup (Outer)	LM300849-LM300811[2]
1999-1998	Frontier	
Seal (Inner)	710072[2]
Set (Inner)	SET37[2]
Cone/Cup (Outer)	LM300849-LM300811[2]
1997-1990	D21 Hardbody	
Seal (Inner)	710072[2]
Set (Inner)	SET37[2]
Cone/Cup (Outer)	LM300849-LM300811[2]

²⁵New Item, Check For Availability

⁷⁸6 Stud, New Item.

Mfg./Year	Model & Location	Part No.	Mfg./Year	Model & Location	Part No.
-----------	------------------	----------	-----------	------------------	----------

NISSAN/DATSUN - 4WD/RWD - SUV, Truck - Armada, D21, Frontier, Pathfinder, Titan, Xterra, X-Trail (cont.)

REAR WHEEL

RWD

2009	Titan PU	
	Set	SET80[2] ^Z
2009-2005	Pathfinder	
	Hub Unit Bearing	HA500701[2] ⁷⁸
2009-2005	Xterra	
	Bearing Module	BM500022[2] ²⁵
	Seal	710479[2]
2008-2006	Frontier (Stand Trans, Off Road)	
	Set	SET10[2]
2008-2005	Frontier (Auto Trans)	
	Bearing Module	BM500022[2] ²⁵
	Seal	710479[2]
2008-2004	Armada	
	Hub Unit Bearing	SP500702[2] ⁷⁸
2008-2004	Titan PU	
	Set	SET10[2]
2004-2000	Xterra (4 Cyl.)	
	Seal	710305[2]
	Bearing Assy	513246[2]
2004-2000	Xterra (6 Cyl.)	
	Seal	710176[2]
	Bearing Assy	516005[2]
2004-1999	Frontier (4 Cyl.)	
	Seal	710305[2]
	Bearing Assy	513246[2]
2004-1998	Frontier (6 Cyl.)	
	Seal	710176[2]
	Bearing Assy	516005[2]
2004-1996	Pathfinder	
	Seal	710176[2]
	Bearing Assy	516005[2]
1997-1990	D21 Hardbody Pickup (SRW)	
	Seal (Inner)	473823[2]
	Bearing Assy	30208M[2]
	Seal (Outer)	710305[2]
1995-1990	Pathfinder (Disc)	
	Seal	710176[2]
	Bearing Assy	513246[2]
1995-1990	Pathfinder (Drum)	
	Seal (Inner)	473823[2]
	Bearing Assy (Inner)	30208M[2]
	Seal (Outer)	710305[2]
1995-1990	D21 Hardbody Pickup (DRW.)	
	Seal (Inner)	226530[2]
	Seal (Outer)	223400[2]
	Bearing Assy	32010X[2]

FRONT AXLE

Differential

2004-1999	Xterra 2.4L	
	Bearing Assy	30209C[2]
2004-1999	Xterra 3.3L	
	Bearing Assy	30208M[2]
2002-1999	Frontier 3.3L	
	Bearing Assy	30208M[2]
2002-1998	Frontier 2.4L	
	Bearing Assy	30209C[2]

FRONT AXLE (cont.)

Differential (cont.)

2002-1990	(R200, R200A Axles)	
	Seal	223542[2]
	Bearing Assy	30209C[2]
	Repair Sleeve	KWK99139
2002-1990	(R180, R180A Axles)	
	Seal	1167S[2]
	Bearing Assy	30208M[2]
	Repair Sleeve	KWK99128

Pinion

2005-1990		
	Seal (R180 Axles)	2011S
	Bearing Assy (Inner)	
	(All)	32307
	Bearing Assy (Outer)	
	(R180 Axles)	32305
	Repair Sleeve (R180 Axles)	KWK99139
	Ball Bearing (Pilot)	
	(R180 Axles)	30565
	Seal (R200A Axle)	712020
	Repair Sleeve (R200A Axle)	KWK99157

REAR AXLE

Differential

2004-1990	(H233, H233B, H233BS Axles)	
	Cone/Cup	17887-17831[2]
2002-1998	(C200B Axle)	
	Bearing Assy	30209C[2]
2002-1990	(H190, H190A, H190B Axles)	
	Seal	1167S[2]
	Bearing Assy	30208M[2]
1998-1990	(R230 Axle)	
	Seal	710135[2]
	Bearing Assy	32211M[2]
1995-1990	(R180, R180A Axles)	
	Seal	1167S[2]
	Bearing Assy	30208M[2]
1993-1990	(C200, C200B Axles)	
	Bearing Assy	30209C[2]

Pinion

2004-1998	(H233BS Axle)	
	Seal	710245
	Bearing Assy (Inner)	32308
	Bearing Assy (Outer)	32306C
	Repair Sleeve	KWK99166
2004-1990	(C200B Axle)	
	Seal	710245
	Bearing Assy (Inner)	32307
	Bearing Assy (Outer)	32306C
	Repair Sleeve	KWK99166
2002-1990	(H190, H190A, H190B Axles)	
	Seal	1979
	Bearing Assy (Inner)	32307
	Bearing Assy (Outer)	30306M

^ZNon-Cancellable/Non-Returnable

²⁵New Item, Check For Availability

⁷⁸6 Stud, New Item.

Mfg./Year	Model & Location	Part No.	Mfg./Year	Model & Location	Part No.
NISSAN/DATSUN - 4WD/RWD - SUV, Truck - Armada, D21, Frontier, Pathfinder, Titan, Xterra, X-Trail (cont.)					

REAR AXLE (cont.)

Pinion (cont.)

1992-1990 (R180 Axle)	
Seal	1173
Bearing Assy (Inner)	32307
Bearing Assy (Outer)	32305
Repair Sleeve	KWK99139

TRANSFER CASE REBUILD KIT

2002-1990 (TX10)	
Kit	TRKFN240

TRANSFER CASE

Input Shaft

2004-1990 (TX10, TX10A)(A/T)	
Seal	225035
Ball Bearing	306TB[2]
Repair Sleeve	KWK99196
2004-1990 (TX10, TX10A)(M/T)	
Seal	225030
Ball Bearing	306TB[2]
Repair Sleeve	KWK99196
1992-1990 (TY10A)	
Seal	224150

Front Output Shaft

2008-2004 (Fuji TX14B)	
Seal	710113
2004-1990 (TX10, TX10A)	
Seal	710113
Ball Bearing	212L[2]
1992-1990 (TY10A)	
Seal	226018
Repair Sleeve	KWK99235

Rear Output Shaft

2004-1990 (TX10, TX10A)	
Seal	224266
Ball Bearing	213SL[2]
Repair Sleeve	KWK99166
1992-1990 (TY10A)	
Seal	710214

Drive Sprocket

2004-1990 (TX10, TX10A)	
Ball Bearing	208[2]

Selector Shaft Seal/Man. Shaft

2004-1990 (TX10, TX10A)	
Seal	221710
Repair Sleeve	KWK99068
1992-1990 (TY10, TY10A)	
Seal	710243
Repair Sleeve	KWK99098

4-SPEED AUTOMATIC TRANSMISSION

Torque Converter

2002-1990 (RE4R01A, RL4R01A)	
Seal	224663
Repair Sleeve	KWK99181

Rear Seal/Ext. Housing

2002-1990 (RL4R01A)	
Seal	224464
2002-1990 (E4N71B, RE4R01A)	
Seal	223801

Selector Shaft Seal/Man. Shaft

2002-1990 (RE4R01A, RL4R01A)	
Seal	2027

CLUTCH - 4 CYLINDER

Release Bearing

2004-1996 2.4L (DOHC)	
Bearing Only	613015
2004-1996 3.3 L	
Bearing Only	613015
2003-2001 3.5L	
Bearing Only	613015
1995-1990 3.0 6 Cyl.	
Bearing Assy	DNE01576C
Bearing Only	01576
1995-1990 2.4L	
Bearing Assy	DNE01576C
Bearing Only	01576

5-SPEED MANUAL TRANSMISSION

Transmission Rebuild Kit

2002-1990 (FS5R30A)	
Kit	TRKFN150
2002-1990 (FS5W71C)	
Kit	TRKFN110
1997-1990 (FS5W71G)	
Kit	TRKFN190
1997-1990 (FS5R30A, FS5R30B)	
Kit	TRKFN150
1997-1990 (FS5W71E)	
Kit	TRKFN110

Front Input Shaft

2002-1995 (FS5W71C)	
Seal	1981
Repair Sleeve	KWK99114
2002-1990 (FS5R30A)	
Seal	1981
Ball Bearing	1308L[2]
Repair Sleeve	KWK99114
1994-1990 (FS5W71A, FS5W71B, FS5W71C)	
Seal	1981
Ball Bearing	306LO[2]
Repair Sleeve	KWK99114

Mfg./Year	Model & Location	Part No.	Mfg./Year	Model & Location	Part No.
-----------	------------------	----------	-----------	------------------	----------

**NISSAN/DATSUN - 4WD/RWD - SUV, Truck - Armada, D21, Frontier,
Pathfinder, Titan, Xterra, X-Trail (cont.)**

5-SPEED MANUAL TRANSMISSION

Countershaft

2002-1990	(FS5W71A, FS5W71B, FS5W71C)	
Ball Bearing (Center)	305AG[2]
Ball Bearing (Rr)	204[2]

Rear Output Shaft

2002-1990	(FS5R30A)	
Seal	224215
Ball Bearing	1308L[2]
2002-1990	(FS5W71A, FS5W71B, FS5W71C)	
Seal	710324
Ball Bearing	306TB[2]

Extension Housing

2002-1990	(FS5R30A)	
Seal	224215
Ball Bearing	307L[2]
2002-1990	(FS5W71A, FS5W71B, FS5W71C)	
Seal	3771
Ball Bearing	205BB[2]

DRIVESHAFT SUPPORT

2004-1998	Frontier (RWD)	
Hanger Bearing Assy	HB6
1997-1990	Pathfinder, Pickup (RWD)	
Hanger Bearing Assy	HB6[2]
Ball Bearing	206FF[2]
1995-1990	Hardbody Pickup (4WD)(V6)	
Hanger Bearing Assy	HB13[2]
Ball Bearing	206FF[2]

CAMSHAFT SEAL

6 Cylinder

2004-1999	3275/3.3L	
Seal	223420
1998-1990	2960cc/3.0L	
Seal	223420[2]
Repair Sleeve	KWK99134[2]

CRANKSHAFT FRONT SEAL

4 Cylinder

2008-2005	2500cc/2.5L	
Seal	224650
Repair Sleeve	KWK99181
2004-1994	2389cc/2.4L	
Seal	224650
Repair Sleeve	KWK99181

6 Cylinder

2008-2005	3954cc/4.0L	
Seal	710356
2004-2001	3498cc/3.5L	
Seal	710356
Repair Sleeve	KWK99189

CRANKSHAFT FRONT SEAL (cont.)

6 Cylinder (cont.)

2004-1996	3275/3.3L	
Seal	224052
Repair Sleeve	KWK99157
1996-1990	2960cc/3.0L	
Seal	223340

CRANKSHAFT REAR SEAL

4 Cylinder

2008-2005	2500cc/2.5L	
Seal PTFE H/D	228411 ²⁵
2004-1990	2389cc/2.4L	
Seal	228009
Repair Sleeve	KWK99315

6 Cylinder

2008-2005	3954cc/4.0L	
Seal PTFE H/D	228411 ²⁵
2004-2001	3498cc/3.5L	
Seal Viton	710363
2004-1996	3275/3.3L	
Seal PTFE H/D	228411 ²⁵
1996-1990	2960cc/3.0L	
Seal Viton	228410

8 Cylinder

2008-2004	5552cc/5.6L	
Seal PTFE H/D	228411 ²⁵

²⁵New Item, Check For Availability

Mfg./Year	Model & Location	Part No.	Mfg./Year	Model & Location	Part No.
OLDSMOBILE - FRONT DRIVE - Achieva, Alero, Cutlass Calais, Cutlass Supreme					

FRONT WHEEL

FWD

2004-1999 Alero	
Hub Unit Bearing	513137[2]
1998-1992 Achieva	
Hub Unit Bearing	513017K[2] ⁶¹
1997 Cutlass Supreme	
Hub Unit Bearing	513044[2]
1996-1990 Cutlass Supreme	
Hub Unit Bearing	513044[2]
1991-1990 Cutlass Calais	
Hub Unit Bearing	513017K[2] ⁶¹

REAR WHEEL

FWD

2004-1999 Alero	
Hub Unit Bearing	512152[2]
1999-1998 Cutlass	
Hub Unit Bearing	512150[2] ⁸³
Hub Unit Bearing	512237[2] ⁸⁴
1998-1992 Achieva	
Hub Unit Bearing	512001[2]
1997 Cutlass, Cutlass Supreme	
Hub Unit Bearing	512151[2]
1996-1992 Cutlass Supreme (ABS)	
Hub Unit Bearing	512004[2]
1994-1990 Cutlass Supreme (Non-ABS)	
Hub Unit Bearing	513018[2]
1991 Calais (ABS)	
Hub Unit Bearing	512001[2]
1991 Calais (Non-ABS)	
Hub Unit Bearing	513012[2]
1991-1990 Cutlass Supreme (ABS)	
Hub Unit Bearing	513042[2]
1990 Calais (Exc. Stabilizer Bar)	
Hub Unit Bearing	513012[2]
1990 Calais (Stabilizer Bar)	
Hub Unit Bearing	512001[2]

CLUTCH

Release Bearing

2001-1995 (5 Spd.)(Isuzu Trans.)(Hyd. piston type)	
Hyd. Bearing Assy	619006
1994-1992 4 Cyl. 2.3 (DOHC)(T550 Trans.)(Hyd. piston type)(5 Spd.)	
Hyd. Bearing Assy	619005
1994-1992 4 Cyl. 2.3 (SOHC)(5 Spd.)(Isuzu Trans.)	
Bearing Assy	614108
1994-1992 Quad4 (5 Spd.)(Isuzu Trans.)	
Bearing Assy	614108
1992-1991 3.4 V6 (5 Spd.)(Isuzu Trans.)	
Bearing Assy	614108
1992-1990 Quad4 (5 Spd.)(Muncie Trans.)	
Bearing Assy	614069
1992-1990 4 Cyl. (w/o Quad4)(5 Spd.)	
Bearing Assy	614108
1990 6 Cyl. (5 Spd.)	
Bearing Assy	614069

3-SPEED AUTOMATIC TRANSAXLE

Torque Converter

1996-1990 (HM3T40)	
Seal	4072N[2]
1996-1990 (THM125)	
Seal	4072N[2]

Output Shaft

1996-1990 (THM125)(3T40)	
Seal	3543[2]
Repair Sleeve	KWK99139[2]

Manual Shaft

1996-1990	
Seal	8792S

4-SPEED AUTOMATIC TRANSAXLE

Torque Converter / Frt Pump

2004-1999 (4T40E, 4T45E, 4T60E)	
Seal	4072N
Repair Sleeve	KWK99172
2001-1990 (THM440 T4, 4T60, 4T60 E, 4T40)	
Seal	4072N[2]

Output Shaft

2004-1997 (4T40E)	
Seal	SL260001[2] ²⁵
1999-1997 (4T60E)	
Seal (LH)	710096
Repair Sleeve (RH)	KWK99139
Seal	3543
Repair Sleeve (RH)	KWK99139
1998-1990 (THM440 T4, 4T60, 4T60 E)	
Seal (LH)	710096[2]
Seal (RH)	3543[2]
Repair Sleeve	KWK99139[2]

Manual Shaft

2004-1990 (4T40E, 4T45E, 4T60E)	
Seal	8792S

5-SPEED MANUAL TRANSAXLE

Differential

1999-1991 (Getrag 284)	
Cone/Cup	LM503349P-LM503310P[2]
1998-1990 (Isuzu)	
Bearing Assy	32008XM[2]
1994-1992 (New Process)	
Set	SET11[2]
1990 (Getrag)	
Set	SET11[2]

²⁵New Item, Check For Availability

⁶¹Kit = Seal, Hub Nut, & Brg Unit

⁸³Deplete Inventory

⁸⁴Reorder

Mfg./Year Model & Location Part No. Mfg./Year Model & Location Part No.

OLDSMOBILE - FRONT DRIVE - Achieva, Alero, Cutlass Calais, Cutlass Supreme (cont.)**5-SPEED MANUAL TRANSAXLE****Input Shaft**

1998-1995 (Isuzu)	
Seal	222835
Bearing Assy	30306M
Repair Sleeve	KWK99111
1994-1990 (Isuzu)	
Seal	222835
Repair Sleeve	KWK99111
1991-1990 (Getrag)	
Ball Bearing	305DD[2]

Output Shaft

1999-1991 (Getrag 284)	
Seal	2003N[2]
Repair Sleeve	KWK99146[2]
Cone/Cup (RH)	LM503349P-LM503310P[2]
Set (LH)	SET5
1998-1990 (Isuzu)	
Seal	3543[2]
Repair Sleeve	KWK99139[2]
Bearing Assy (RH)	32206M[2]
Set (LH)	SET5[2]
1994-1993 (New Process T550)	
Seal	3543[2]
Repair Sleeve	KWK99139[2]
1991-1990 (Getrag)	
Seal	3543[2]
Repair Sleeve	KWK99139[2]

Selector Shaft Seal/Man. Shaft

1998-1990	
Seal	710243

POWER STEERING**Pump Shaft**

2001-1992	
Seal	7013S
1991-1990 (integral reservoir)	
Seal	221925
Ball Bearing	203FF[2]

Worm Shaft

1990	
Seal	222510

CRANKSHAFT FRONT SEAL**4 Cylinder**

2004-2002 2.2L (DOHC)	
Seal	9845
Repair Sleeve	KWK99176
2001-1990 2.3L (DOHC), 2.4L (DOHC)	
Seal Viton	320259
Repair Sleeve	KWK99199
1991-1990 112/1.8L, 121/2.0L, 134/2.2L, 151/2.5L	
Seal	9845
Repair Sleeve	KWK99176
Harmnc Balancer Slvs	88176

6 Cylinder

2004-1990 173/2.8L, 189/3.1L, 207/3.4L	
Seal	9845
Repair Sleeve	KWK99176
1993-1990 181/3.0L, 204/3.3L	
Seal Viton	710162
Repair Sleeve	KWK99193

CRANKSHAFT REAR SEAL**4 Cylinder**

2004-2002 2.2L (DOHC)	
Seal Viton	710237
2001-1990 138/2.3L, 146/2.4L	
Seal	40375
1999-1990 3.1L	
Seal	4307V
1996-1993 134/2.2L	
Seal	4307V
Repair Sleeve	KWK99298
Seal PTFE H/D	5273
1991-1990 151/2.5L	
Seal	3698

6 Cylinder

2004-1990 173/2.8L, 189/3.1L, 207/3.4L	
Seal	4307V
Seal PTFE H/D	5273
Repair Sleeve	KWK99298
1993-1990 204/3.3L, 231/3.8L	
Seal Viton	320691
Repair Sleeve	KWK99328
1993-1990 204/3.3L, 231/3.8L	
Seal Viton	320691
Repair Sleeve	KWK99328

Mfg./Year Model & Location Part No. Mfg./Year Model & Location Part No.

OLDSMOBILE - FRONT DRIVE - Aurora

FRONT WHEEL

FWD

2003-2001 (2nd Design)
 Hub Unit Bearing 513179[2]⁷³
 2001-1997 (1st Design)
 Hub Unit Bearing 513121[2]⁷²
 1996-1995
 Hub Unit Bearing 513087[2]⁴⁵

REAR WHEEL

FWD

2003-1995
 Hub Unit Bearing 512003[2]

4-SPEED AUTOMATIC TRANSAXLE

Torque Convertor / Frt Pump

2003-2001 (4T65 E)
 Seal 4072N
 Repair Sleeve KWK99172
 2001-1995 (4T80 E)
 Seal 224840
 Repair Sleeve KWK99189

Output Shaft

2003-2001 (4T65 E)
 Seal (LH) (Yellow) 100165
 Repair Sleeve (LH) KWK99139
 Seal (RH) (Green) 3543
 Repair Sleeve (RH) KWK99139
 2001-1995 (4T80 E)
 Seal (LH) 714679
 Seal (RH) 4674N

Manual Shaft

2003-1995 (4T65E, 4T80E)
 Seal 8792S
 Repair Sleeve KWK99050

POWER STEERING

Pump Shaft

2001-1995
 Ball Bearing 203FF[2]

CRANKSHAFT FRONT SEAL

6 Cylinder

2002-2001 212/3.5L
 Seal 470163

8 Cylinder

2002-1995 244/4.0L
 Seal Viton 710263

CRANKSHAFT REAR SEAL

6 Cylinder

2003-1995 3.5L (DOHC), 4.1L (DOHC)
 Seal Viton 710262

8 Cylinder

2003-1995 244/4.0L
 Seal Viton 710262

OLDSMOBILE - FRONT DRIVE - Cutlass Ciera, Cutlass Cruiser

FRONT WHEEL

FWD

1996-1994
 Hub Unit Bearing 513087[2]⁴⁵
 1993-1990
 Hub Unit Bearing 513016K[2]⁶¹

REAR WHEEL

FWD

1996-1994
 Hub Unit Bearing 512078[2]
 1993-1990
 Hub Unit Bearing 513018[2]

⁴⁵Brg Flg Mtg Holes Non-Threaded. ⁶¹Kit = Seal, Hub Nut, & Brg Unit ⁷²Steel Wire Clip. Brg Flg Mtg Holes Threaded. ⁷³Plastic Wire Clip.

Mfg./Year Model & Location Part No. Mfg./Year Model & Location Part No.

OLDSMOBILE - FRONT DRIVE - Cutlass Ciera, Cutlass Cruiser (cont.)**CLUTCH****Release Bearing**

1993-1992	Quad4 (5 Spd.)(Isuzu Trans.)	
	Bearing Assy	614108
1992-1990	Quad4 (5 Spd.)(Muncie Trans.)	
	Bearing Assy	614069
1992-1990	6 Cyl. (5 Spd.)	
	Bearing Assy	614069
1992-1990	4 Cyl. (w/o Quad4)(5 Spd.)	
	Bearing Assy	614108

3-SPEED AUTOMATIC TRANSAXLE**Torque Converter**

1996-1990		
	Seal	4072N

Output Shaft

1996-1990	(THM125)(3T40)	
	Seal	3543[2]
	Repair Sleeve	KWK99138[2]

Manual Shaft

1996-1990		
	Seal	8792S

4-SPEED AUTOMATIC TRANSAXLE**Torque Converter / Frt Pump**

1996-1994	(4T60E)	
	Seal	4072N
	Repair Sleeve	KWK99172

Output Shaft

1996-1990	(4T60E)	
	Seal (LH)	710096
	Seal (RH)	3543
	Repair Sleeve	KWK99139[2]

Manual Shaft

1996-1994	(4T60E)	
	Seal	8792S
	Repair Sleeve	KWK99049

POWER STEERING**Pump Shaft**

1996-1990		
	Seal	480821

CRANKSHAFT FRONT SEAL**4 Cylinder**

1996-1990	134/2.2L, 151/2.5L	
	Seal	9845
	Repair Sleeve	KWK99176

CRANKSHAFT FRONT SEAL**6 Cylinder**

1996-1990	173/2.8L, 189/3.1L	
	Seal	9845
	Repair Sleeve	KWK99176
1993-1990	204/3.3L, 231/3.8L	
	Seal Viton	710162
	Repair Sleeve	KWK99193

CRANKSHAFT REAR SEAL**4 Cylinder**

1996-1993	134/2.2L	
	Seal	4307V
	Seal PTFE H/D	5273
	Repair Sleeve	KWK99298
1992-1990	151/2.5L	
	Seal	3698

6 Cylinder

1996-1990	173/2.8L, 189/3.1L	
	Seal	4307V
	Seal PTFE H/D	5273
	Repair Sleeve	KWK99298
1993-1990	204/3.3L	
	Seal Viton	320691

Mfg./Year	Model & Location	Part No.	Mfg./Year	Model & Location	Part No.
OLDSMOBILE - FRONT DRIVE - Eighty-Eight, LSS, Ninety-Eight, Touring Sedan					

FRONT WHEEL

FWD

1999-1996		
Hub Unit Bearing	513121[2]	⁷²
1999-1992 (ABS)		
Hub Unit Bearing	513087[2]	⁴⁵
1993-1992 Eighty-Eight (Non-ABS)		
Hub Unit Bearing	513088[2]	
1991 Eighty-Eight, Ninety-Eight (ABS)		
Hub Unit Bearing	513016K[2]	⁶¹
1991-1990 Eighty-Eight, Ninty-Eight (Non-ABS)		
Hub Unit Bearing	513016K[2]	⁶¹
1990 Eighty-Eight, Ninety-Eight, Touring Sedan (ABS)		
Hub Unit Bearing	513016K[2]	⁶¹

REAR WHEEL

FWD

1999-1994		
Hub Unit Bearing	513062[2]	
1993-1992 Eighty-Eight (Non-ABS)		
Hub Unit Bearing	513018[2]	
1993-1991 Eighty-Eight, Ninety-Eight (ABS)		
Hub Unit Bearing	513062[2]	
1991-1990 Eighty-Eight, Ninty-Eight (Non-ABS)		
Hub Unit Bearing	513018[2]	
1990 Eighty-Eight, Ninety-Eight, Touring Sedan (ABS)		
Hub Unit Bearing	513041[2]	

4-SPEED AUTOMATIC TRANSAXLE

Torque Converter / Frt Pump

1999-1990 (4T60E, 4T65E)		
Seal	4072N[2]	

Output Shaft

1999-1994 (4T65 E)		
Seal (LH) (Yellow)	100165	
Repair Sleeve (LH)	KWK99139	
Seal (RH) (Green)	3543	
Repair Sleeve (RH)	KWK99139	
1997-1990 (4T60E)		
Seal (LH)	710096	
Repair Sleeve (LH)	KWK99139	
Seal (RH)	3543	
Repair Sleeve	KWK99139	

Manual Shaft

1999-1990 (4T60E, 4T65E)		
Seal	8792S	

POWER STEERING

Pump Shaft

1999-1990		
Seal	480821	

POWER STEERING

Worm Shaft

1999-1990		
Seal	222510	

CRANKSHAFT FRONT SEAL

6 Cylinder

1999-1990		
Seal Viton	710162	
Repair Sleeve	KWK99139	

CRANKSHAFT REAR SEAL

6 Cylinder

1999-1991		
Seal Viton	320691	
Repair Sleeve	KWK99328	
1990		
Seal	5591	
Seal PTFE H/D	5291	

⁴⁵Brg Flg Mtg Holes Non-Threaded. Flg Mtg Holes Threaded.

⁶¹Kit = Seal, Hub Nut, & Brg Unit

⁷²Steel Wire Clip. Brg

Mfg./Year Model & Location Part No. Mfg./Year Model & Location Part No.

OLDSMOBILE - FRONT DRIVE - Intrigue**FRONT WHEEL****FWD**

2002-2001 (2nd Design)	
Hub Unit Bearing	513179[2] ⁷³
2001-1998 (1st Design)	
Hub Unit Bearing	513121[2] ⁷²

REAR WHEEL**RWD**

2002-1998	
Hub Unit Bearing	512150[2] ⁸³
Hub Unit Bearing	512237[2] ⁸⁴

4-SPEED AUTOMATIC TRANSAXLE**Torque Converter / Frt Pump**

2002-1998 (4T65 E)	
Seal	4072N
Repair Sleeve	KWK99172

Output Shaft

2002-1998 (4T65 E)	
Seal (LH) (Yellow)	100165
Repair Sleeve (LH)	KWK99139
Seal (RH) (Green)	3543
Repair Sleeve (RH)	KWK99139

Manual Shaft

2002-1998 (4T65 E)	
Seal	8792S

POWER STEERING**Pump Shaft**

2002-1999 212/3.5L	
Seal	7013S
Ball Bearing	203FF[2]
1999-1998 231/3.8L	
Seal	7013S

CRANKSHAFT FRONT SEAL**6 Cylinder**

2002-1999 212/3.5L	
Seal Viton	710263
1999-1998 231/3.8L	
Seal Viton	710162
Repair Sleeve	KWK99193

CRANKSHAFT REAR SEAL**6 Cylinder**

2002-1999 212/3.5L	
Seal Viton	710262
1999-1998 231/3.8L	
Seal Viton	320691
Repair Sleeve	KWK99328

OLDSMOBILE - FRONT DRIVE - Toronado**FRONT WHEEL****FWD**

1992	
Hub Unit Bearing	513087[2] ⁴⁵
1991-1990	
Hub Unit Bearing	513059[2]

REAR WHEEL**FWD**

1992	
Hub Unit Bearing	512003[2]
1991	
Hub Unit Bearing	512003[2]
1990 (ABS)	
Hub Unit Bearing	513041[2]

REAR WHEEL (cont.)**FWD (cont.)**

1990 (Non-ABS)	
Hub Unit Bearing	513018[2]

3-SPEED AUTOMATIC TRANSAXLE**Torque Converter**

1992-1990	
Seal	4072N[2]

⁴⁵Brg Flg Mtg Holes Non-Threaded.
Wire Clip. ⁸³Deplete Inventory⁷²Steel Wire Clip. Brg Flg Mtg Holes Threaded. ⁸⁴Reorder⁷³Plastic

Mfg./Year Model & Location Part No. Mfg./Year Model & Location Part No.

OLDSMOBILE - FRONT DRIVE - Toronado (cont.)

3-SPEED AUTOMATIC TRANSAXLE

Output Shaft

1992-1990
 Seal (LH) 710096
 Repair Sleeve (LH) KWK99139
 Seal (RH) 3543
 Repair Sleeve (RH) KWK99138

Manual Shaft

1992-1990
 Seal 8792S

4-SPEED AUTOMATIC TRANSAXLE

Torque Converter / Frt Pump

1992-1990
 Seal 4072N

Output Shaft

1992-1990
 Seal (Pass Side) 3543
 Seal (Driver Side) 710096

Manual Shaft

1992-1990
 Seal 8792S

ALTERNATOR

1992-1990
 Ball Bearing (Drive End) 203FF
 Ball Bearing (Rear End) 100CCAB

POWER STEERING

Pump Shaft

1992
 Seal 7013S
 Ball Bearing 203FF[2]
 1991-1990
 Seal 22192S
 Ball Bearing 203FF[2]

CRANKSHAFT FRONT SEAL

6 Cylinder

1992-1990 231/3.8L
 Seal Viton 710162
 Repair Sleeve KWK99193

CRANKSHAFT REAR SEAL

6 Cylinder

1992-1991 231/3.8L
 Seal Viton 320691
 Repair Sleeve KWK99328
 1990
 Seal 5591
 Seal PTFE H/D 5291

OLDSMOBILE - REAR DRIVE - Cruiser Wagon, Custom Cruiser, Eighty-Eight, Ninety-Eight

FRONT WHEEL

RWD

1992-1991
 Seal (Inner) 4739[2]
 Set (Inner) SET6[2]
 Set (Outer) SET3[2]
 1990
 Seal (Inner) 8871[2]
 Set (Inner) SET6[2]
 Set (Outer) SET3[2]

REAR WHEEL

RWD

1992-1990 (Wagon or Pontiac Axle)
 Seal 8835S[2]
 Cylindrical Bearing 6408[2]
 Bearing & Seal Kit TRP1559TV[2]¹⁹

REAR AXLE

Differential Rebuild Kit

1996-1990 (8.5" R.G.)
 Kit DRK321
 1990 (7.5" R.G.)
 Kit DRK320

¹⁹Opt. Axle Rpr Brg. Replaces O.E. Brg & Seal

Mfg./Year Model & Location Part No. Mfg./Year Model & Location Part No.

OLDSMOBILE - REAR DRIVE - Cruiser Wagon, Custom Cruiser, Eighty-Eight, Ninety-Eight (cont.)**REAR AXLE****Differential**

1996-1990 (B, C, G, K, O Axles)
Cone/Cup LM501349-LM501314[2]

Pinion

1996-1990 (8.5" R.G.)
Seal 2043
Cone/Cup (Inner) M802048-M802011
Cone/Cup (Outer) M88048-M88010

4-SPEED AUTOMATIC TRANSMISSION**Torque Converter**

1992-1990
Seal 3227[2]
Repair Sleeve KWK99174

Rear Seal/Ext. Housing

1992-1990
Seal 9613S[2]
Repair Sleeve KWK99149
Seal Kit 5200⁶⁴

POWER STEERING**Pitman Shaft**

1992-1990
Seal Kit PSK1²⁴

Pump Shaft

1992-1990 (Saginaw)
Seal 7013S

CRANKSHAFT FRONT SEAL**8 Cylinder**

1992-1991
Seal 9845
Repair Sleeve KWK99176
Harmnc Balancer Slvs 88176
1990
Seal 472082
Repair Sleeve KWK99199
Harmnc Balancer Slvs 88199

CRANKSHAFT REAR SEAL**8 Cylinder**

1992 5.7L
Seal Viton 4359V
1992-1991 305/5.0L
Seal Viton 4359V
Seal PTFE H/D 5274
Repair Sleeve KWK99364
1990 307/5.0L
Seal 5419

OLDSMOBILE - Minivan, SUV - Bravada**FRONT WHEEL****4WD**

2004-2002
Hub Unit Bearing 513188[2]
2001-1997
Hub Unit Bearing 513124[2]
1996-1991
Hub Unit Bearing 513061[2]

REAR WHEEL**4WD**

2004-2002
Seal 4762N
Cylindrical Bearing 513067[2]
2001-1991
Seal 710166[2]
Cylindrical Bearing 5707[2]
Bearing & Seal Kit TRP1563TAV[2]¹⁹

¹⁹Opt. Axle Rpr Brg. Replaces O.E. Brg & Seal²⁴Opt. Kit = Seals 5683 & 5684. Not Sold Separately⁶⁴Seal & Bushing Kit

Mfg./Year Model & Location Part No. Mfg./Year Model & Location Part No.

OLDSMOBILE - Minivan, SUV - Bravada (cont.)

4WD FRONT AXLE

Axle Shaft

- 2004-1998**
- Seal 710491[2]
- Ndle Bearing HK4012[2]
- 1997**
- Seal 223255[2]
- Ndle Bearing B2010[2]
- Seal 710491[2]
- 1996**
- Ndle Bearing HK4012[2]
- Seal 710491[2]
- 1994-1991**
- Seal 223255[2]
- Ndle Bearing B2010[2]

Differential Rebuild Kit

- 2004-1991** (7.25" R.G.)
- Kit DRK320A

Differential

- 2004-1991** (7.25" R.G.)
- Set SET11[2]

Pinion

- 2004-1991**
- Seal 8611N
- Cone/Cup (Inner) (O.E.) M88048S-M88010
- Cone/Cup (Outer) M86649-M86610

REAR AXLE

Differential Rebuild Kit

- 2001-1999**
- Kit DRK320C
- 1998-1991**
- Kit DRK320

Differential

- 2004-2002** (8.5", 8.625" R.G.)
- Set SET36[2]
- 2004-1991** (7.5" R.G., 7.625" R.G.)
- Cone/Cup LM501349-LM501314[2]

Pinion

- 2004-2002** (8.5", 8.625" R.G.)(113" W/B)
- Seal 8610
- Cone/Cup (Inner) NP457992-NP926068
- Cone/Cup (Outer) M86649-M86610
- 2001-1999**
- Seal 8610
- Cone/Cup (Inner) HM89249-HM89210
- Cone/Cup (Outer) M86649-M86610
- 1998-1991**
- Seal 8610
- Cone/Cup (Inner) HM89249-HM89210
- Cone/Cup (Outer) M86649-M86610

TRANSFER CASE REBUILD KIT

- 1997-1996** (Warner 4472)
- Kit TCRK1372

TRANSFER CASE REBUILD KIT (cont.)

- 1994-1991** (Warner 4472)
- Kit TCRK1372

TRANSFER CASE

Input Shaft

- 2001-1998** (New Process 136C)
- Ndle Bearing (Pilot) FC66561
- Seal 472636
- Ball Bearing 110CB
- Ball Bearing (Frnt) 207
- 1997-1996** (Warner 4472)
- Seal (O.E.) 710062
- Ball Bearing 109TB
- Repair Sleeve KWK99175
- Ndle Bearing (Pilot) SCH1310
- 1994-1991** (Warner 4472)
- Seal (O.E.) 710062
- Ball Bearing 109TB
- Repair Sleeve KWK99175
- Ndle Bearing (Pilot) SCH1310

Front Output Shaft

- 2001-1998** (New Process 136C)
- Ball Bearing 110CB
- Ball Bearing (Frnt) 207
- 1997-1991** (Warner 4472)
- Seal (Frnt) 714503
- Ball Bearing (Frnt) 207
- Ndle Bearing (Pilot) JH1612

Rear Output Shaft

- 2001-1998** (New Process 136C)
- Seal 710496
- 1997-1996** (Warner 4472)(booted)
- Seal 4503N
- Ball Bearing 208SL[2]
- 1997-1996** (Warner 4472)(w/o boot)
- Seal 714503
- Ball Bearing 208SL[2]
- 1994-1991** (Warner 4472)(booted)
- Seal 4503N
- Ball Bearing 208SL[2]
- 1994-1991** (Warner 4472)(w/o boot)
- Seal 714503
- Ball Bearing 208SL[2]

4-SPEED AUTOMATIC TRANSMISSION

Torque Converter

- 2004-1993**
- Seal 3227
- Repair Sleeve KWK99174
- 1992-1991**
- Seal 3227
- Repair Sleeve KWK99174

Mfg./Year	Model & Location	Part No.	Mfg./Year	Model & Location	Part No.
OLDSMOBILE - Minivan, SUV - Bravada (cont.)					

4-SPEED AUTOMATIC TRANSMISSION**Rear Seal/Ext. Housing**

2004-1991	
Seal	9613S
Repair Sleeve	KWK99149
Seal Kit	5200 ⁶⁴

Selector Shaft Seal/Man. Shaft

2004-1991	
Seal	8792S
Repair Sleeve	KWK99050

DRIVESHAFT SUPPORT

2001-1991	
Hanger Bearing Assy	HB88107A
Ball Bearing	88107

CRANKSHAFT FRONT SEAL**6 Cylinder**

2001-1991	262/4.3L
Seal	9845
Repair Sleeve	KWK99176

CRANKSHAFT REAR SEAL**6 Cylinder**

2004-1991	262/4.3L
Seal Viton	4359V
Seal PTFE H/D	5274
Repair Sleeve	KWK99364

OLDSMOBILE - Minivan, SUV - Silhouette**FRONT WHEEL****FWD**

2004-2001	(2nd Design)
Hub Unit Bearing	513179[2] ⁷³
2001-1997	(1st Design)
Hub Unit Bearing	513121[2] ⁷²
1996-1992	
Hub Unit Bearing	513087[2] ⁴⁵
1991-1990	
Hub Unit Bearing	513016K[2] ⁶¹

AWD

2004-2002	(2nd Design)
Hub Unit Bearing	513179[2] ⁷³

REAR WHEEL**FWD**

2004-2002	
Hub Unit Bearing	512078[2]
2001-1992	
Hub Unit Bearing	512078[2]
1991-1990	
Hub Unit Bearing	513018[2]

AWD

2004-2002	
Hub Unit Bearing	513121[2] ⁷²

3-SPEED AUTOMATIC TRANSAXLE**Torque Converter**

1996-1990	(THM125C)
Seal	4072N

Output Shaft

1996-1990	(THM125C)
Seal	3543[2]
Repair Sleeve	KWK99138[2]

Manual Shaft

1996-1990	(THM125C)
Seal	8792S
Repair Sleeve	KWK99050

4-SPEED AUTOMATIC TRANSAXLE**Torque Converter / Frt Pump**

2004-1990	(4T60E, 4T65E)
Seal	4072N
Repair Sleeve	KWK99172

Output Shaft

2004-1999	(4T65 E)
Seal (LH) (Yellow)	100165
Repair Sleeve (LH)	KWK99139
Seal (RH) (Green)	3543
Repair Sleeve (RH)	KWK99139
1998-1992	(4T60E)
Seal (LH)	710096
Repair Sleeve	KWK99139
Seal (RH)	3543
Repair Sleeve	KWK99139

⁴⁵Brg Flg Mtg Holes Non-Threaded. ⁶¹Kit = Seal, Hub Nut, & Brg Unit⁷²Steel Wire Clip. Brg Flg Mtg Holes Threaded. ⁷³Plastic Wire Clip.⁶⁴Seal & Bushing Kit

Mfg./Year Model & Location Part No. Mfg./Year Model & Location Part No.

OLDSMOBILE - Minivan, SUV - Silhouette (cont.)

4-SPEED AUTOMATIC TRANSAXLE

Manual Shaft

2004-1992 (4T60E, 4T65E)
 Seal8792S
 Repair SleeveKWK99050

CRANKSHAFT FRONT SEAL

6 Cylinder

2004-1996 207/3.4L
 Seal9845
 Repair SleeveKWK99176
 1995-1992 231/3.8L
 Seal Viton710162
 Repair SleeveKWK99193
 1994-1990 189/3.1L
 Seal9845
 Repair SleeveKWK99176

CRANKSHAFT REAR SEAL

6 Cylinder

2004-1990 189/3.1L, 207/3.4L
 Seal4307V
 Seal PTFE H/D5273
 Repair SleeveKWK99298
 1995-1992 231/3.8L
 Seal Viton320691
 Repair SleeveKWK99328

PEUGEOT - ALL

FRONT WHEEL

FWD

1992-1990 405
 Ball Bearing513073[2]

RWD

1991-1990 505 (2.8L)
 Ball Bearing513051[2]
 1991-1990 505 (Exc. 2.8)
 Seal (Inner)224520[2]
 Set (Inner)SET33[2]^z
 Bearing Assy (Outer)32005X[2]

REAR WHEEL

FWD

1992-1990 405 (w/o ABS)
 Hub Unit Bearing512017[2]

RWD

1992-1990 505 Sedan
 Seal (Inner)225460[2]
 Ball Bearing (Inner)513151[2]
 Seal (Outer)557008XX[2]

REAR AXLE

Differential

1992-1990 504, 505, 604
 SetSET37[2]

REAR AXLE

Pinion

1991-1990 (404L, U6, U8, U10, 504,
 505,604)
 Seal1012N
 Cone/Cup (Inner)HM89449-HM89410
 Cone/Cup (Outer)M88048-M88010

CLUTCH

Pilot Bearing

1990 4 Cyl. 2.5 (Turbo Diesel)
 Ball Bearing103CC
 1990 4 Cyl. (Gas Turbo)
 Ball Bearing103CC
 1990 4 Cyl. (w/o Gas Turbo)
 BushingPB38¹⁶
 1990 4 Cyl. (w/o Turbo Diesel)
 BushingPB38¹⁶
 1990 4 Cyl. 2.2 (Turbo Diesel)
 BushingPB38¹⁶

ALTERNATOR

1991-1990 (Motorola 70 Amp.)
 Ball Bearing (Drive End)203FF
 Ball Bearing (Rear End)200CC

CRANKSHAFT FRONT SEAL

4 Cylinder

1991-1990 1905cc/1.9L (SOHC)(DOHC)
 Seal223605
 Repair SleeveKWK99146
 1991-1990 1971cc/2.0L, 2155cc/2.2L,
 2165cc/2.2L
 Seal Viton225020
 Repair SleeveKWK99196

^zNon-Cancellable/Non-Returnable

¹⁶Obsolete

Mfg./Year	Model & Location	Part No.	Mfg./Year	Model & Location	Part No.
-----------	------------------	----------	-----------	------------------	----------

PEUGEOT - ALL (cont.)**CRANKSHAFT FRONT SEAL****6 Cylinder**

1990	2849cc/2.8L	
Seal		224252
Repair Sleeve		KWK99169

CRANKSHAFT REAR SEAL**4 Cylinder**

1991-1990	1905cc/1.9, 1905cc/1.9 (DOHC), 1971cc/2.0, 2155cc/2.2 (Turbo), 2165cc/2.2	
Seal Viton		229005
Repair Sleeve		KWK99354

CRANKSHAFT REAR SEAL**6 Cylinder**

1990	2849cc/2.8L	
Seal		228010
Repair Sleeve		KWK99315

PLYMOUTH - FRONT DRIVE - Acclaim, Sundance**FRONT WHEEL****FWD**

1995-1991	Acclaim, Sundance	
Hub Unit Bearing		513075[2]
1990		
Seal		5604[2] ⁵⁶
Ball Bearing		513006[2]
Hub Unit Bearing (4 Stud)		518501[2] ⁶²
Hub Unit Bearing (5 Lug Whl.)		518502[2] ⁶³

REAR WHEEL**FWD**

1995-1990		
Seal (Inner)		4099[2]
Set (Inner)		SET46[2]
Set (Outer)		SET16[2]

CLUTCH**Release Bearing**

1995-1990	(4 Cyl.)	
Bearing Assy		614092
1994-1991	6 Cyl. 3.0, 3.2	
Bearing Assy		614092

3-SPEED AUTOMATIC TRANSAXLE**Differential**

1995-1990	(A404, A413, A470, A670, 31TH)	
Seal		3459S[2]
Set		SET11[2]
Repair Sleeve (Opt)		KWK99157[2]

3-SPEED AUTOMATIC TRANSAXLE**Torque Converter**

1995-1990		
Seal		331228H[2]
Repair Sleeve		KWK99149

Transfer Shaft

1995-1990	(A404, A413, A470, A670, 31TH)	
Set		SET11[2]

Output Shaft

1995-1990	(A404, A413, A470, A670)	
Seal		3459S[2]
Set		SET17[2]
Repair Sleeve		KWK99157[2]

Manual Shaft

1995-1990	(A404, A413, A470, A670, 31TH)	
Seal		8609

4-SPEED AUTOMATIC TRANSAXLE**Differential**

1995-1990	(A604, 41TE)	
Seal		3459S[2]
Set		SET11[2]
Repair Sleeve		KWK99157[2]

Torque Converter / Frt Pump

1995-1990	(A604, 41TE)	
Seal		331228H
Repair Sleeve		KWK99149

⁵⁶Opt. Kit = Seal 3948 & Sleeve ⁶²Kit = Plate, Gasket, 3 Bolts, Studded Spindle, Seal, & Bearing⁶³Kit = Plate, Gasket, 3 Bolts, Studded Spindle, Seal, & Bearing

Mfg./Year Model & Location Part No. Mfg./Year Model & Location Part No.

PLYMOUTH - FRONT DRIVE - Acclaim, Sundance (cont.)

4-SPEED AUTOMATIC TRANSAXLE

Transfer Shaft

1995-1992 (41TE)
 Set (RH) SET45[2]
 1991-1990 (A604 41TE)
 Set SET11[2]

Output Shaft

1995-1990 (A604 41TE)
 Seal 3459S[2]
 Set SET17[2]
 Repair Sleeve KWK99157[2]

Manual Shaft

1995-1990 (A604, 41TE)
 Seal 8609

5-SPEED MANUAL TRANSAXLE

Differential

1995-1990 (A465, A520, A523, A525,
 A543, A555, A568)
 Seal 3459S[2]
 Set SET11[2]
 Repair Sleeve KWK99157[2]

Input Shaft

1995-1990 (A465, A520, A523, A525,
 A543, A555, A568)
 Seal (Frt) 3732S
 Set (Frt) SET4[2]
 Repair Sleeve KWK99106
 Set (Rr) SET5[2]

Selector Shaft Seal/Man. Shaft

1995-1990 (A465, A520, A523, A525,
 A543, A555, A568)
 Seal 3816

CAMSHAFT SEAL

4 Cylinder

1995-1990 135/2.2L, 153/2.5L
 Seal 3655S
 Repair Sleeve KWK99139

6 Cylinder

1995-1990 181/3.0L
 Seal 3771[2]
 Repair Sleeve KWK99139[2]

INTERMEDIATE SHAFT

4 Cylinder

1995-1990 135/2.2L, 153/2.5L
 Seal 3655S

CRANKSHAFT FRONT SEAL

4 Cylinder

1995-1990 135/2.2L, 153/2.5L
 Seal 3638
 Repair Sleeve KWK99112
 1994-1990 135/2.2L
 Seal 3638
 Repair Sleeve KWK99112

6 Cylinder

1995-1990 181/3.0L
 Seal 223750

CRANKSHAFT REAR SEAL

4 Cylinder

1995-1990 135/2.2L, 153/2.5L
 Seal Viton 710056
 Seal PTFE H/D 5279

6 Cylinder

1995-1990 181/3.0L
 Seal Viton 710056
 Seal PTFE H/D 5279

Mfg./Year Model & Location Part No. Mfg./Year Model & Location Part No.

PLYMOUTH - FRONT DRIVE - Breeze**FRONT WHEEL****FWD**

2000-1996
Hub Unit Bearing 513138[2]

REAR WHEEL**FWD**

2000-1998 (ABS)
Hub Unit Bearing 512220[2]
2000-1996 (Non-ABS)
Hub Unit Bearing 512154[2]
1997-1996 (ABS)
Hub Unit Bearing 512133[2]

CLUTCH**Release Bearing**

2000-1996
Bearing Assy 614121

4-SPEED AUTOMATIC TRANSAXLE**Differential**

2000-1997 (A604 41TE)(Prod. from mid
1997 on)
Cone/Cup (LH) NP889967-NP714580
Cone/Cup (RH) NP952605-JL69310P
1997-1996 (A604 41TE)(Prod. thru mid
1997)
Cone/Cup (LH) NP889967-NP714580
Cone/Cup (RH) JL69348-JL69310

Torque Converter / Frt Pump

2000-1996
Seal 331228H
Repair Sleeve KWK99149

Transfer Shaft

2000-1996 (A604, 41TE)
Cone/Cup (Inner) NP853895-NP352518[2]
Set (Outer) SET45[2]

Output Shaft

2000-1997 (A604 41TE)(Prod. from mid
1997 on)
Seal (Outer) 3459S[2]
Cone/Cup (Outer) LM300848-LM300911[2]
Cone/Cup (Inner) NP952605-JL69310P[2]
1997-1996 (A604 41TE)(Prod. thru mid
1997)
Seal (Outer) 3459S[2]
Cone/Cup (Outer) LM300848-LM300811[2]
Cone/Cup (Inner) JL69348-JL69310[2]

Manual Shaft

2000-1996 (41TE)
Seal 8609

5-SPEED MANUAL TRANSAXLE**Differential**

2000-1996
Seal 3459S[2]
Set SET11[2]
Repair Sleeve KWK99157[2]

Input Shaft

2000-1996
Seal (Frt) 3732S
Set (Frt) SET4[2]
Repair Sleeve KWK99106
Set (Rr) SET5[2]

Selector Shaft Seal/Man. Shaft

2000-1996
Seal 3816

CAMSHAFT SEAL**4 Cylinder**

2000-1996 122/2.0L (SOHC), 148/2.4L
(DOHC)
Seal Viton 320249
Repair Sleeve KWK99139

CRANKSHAFT FRONT SEAL**4 Cylinder**

2000-1996 122/2.0L (SOHC), 148/2.4L
(DOHC)
Seal Viton 320348
Repair Sleeve KWK99128

CRANKSHAFT REAR SEAL**4 Cylinder**

2000-1996 122/2.0L
Seal Viton 710056
Seal PTFE H/D 5279
2000-1996 148/2.4L
Seal Viton 710056
Seal PTFE H/D 5279

Mfg./Year Model & Location Part No. Mfg./Year Model & Location Part No.

PLYMOUTH - FRONT DRIVE - Horizon

FRONT WHEEL

FWD

1990
 Seal5604[2]⁵⁶
 Ball Bearing B39[2]
 Hub Unit Bearing 518500[2]⁶²

REAR WHEEL

FWD

1990
 Seal (Inner)4099[2]
 Set (Inner) SET46[2]
 Set (Outer) SET16[2]

CLUTCH

Release Bearing

1991-1990 6 Cyl. 3.0, 3.2
 Bearing Assy614092
 1990 (4 Cyl.)
 Bearing Assy614092

3-SPEED AUTOMATIC TRANSAXLE

Differential

1990 (A404, A413, A470, A670,
 31TH)
 Seal3459S[2]
 Set SET11[2]
 Repair Sleeve (Opt)KWK99157[2]

Torque Converter

1990
 Seal331228H[2]
 Repair SleeveKWK99149

Transfer Shaft

1990 (A404, A413, A470, A670,
 31TH)
 Set SET11[2]

Output Shaft

1990 (A404, A413, A470, A670)
 Seal3459S[2]
 Set SET17[2]
 Repair SleeveKWK99157[2]

Manual Shaft

1990 (A404, A413, A470, A670,
 31TH)
 Seal8609

5-SPEED MANUAL TRANSAXLE

Differential

1990
 Seal3459S[2]
 Set SET11[2]
 Repair SleeveKWK99157[2]

Input Shaft

1990
 Seal (Frt)3732S
 Set (Frt) SET4[2]
 Repair SleeveKWK99106
 Set (Rr) SET5[2]

Selector Shaft Seal/Man. Shaft

1990
 Seal3816

CAMSHAFT SEAL

4 Cylinder

1990 135/2.2L
 Seal (Frt)3655S
 Repair SleeveKWK99139

CRANKSHAFT FRONT SEAL

4 Cylinder

1990 135/2.2L
 Seal3638
 Repair SleeveKWK99112

CRANKSHAFT REAR SEAL

4 Cylinder

1990 135/2.2L
 Seal Viton710056
 Seal PTFE H/D5279

⁵⁶Opt. Kit = Seal 3948 & Sleeve

⁶²Kit = Plate, Gasket, 3 Bolts, Studded Spindle, Seal, & Bearing

Mfg./Year Model & Location Part No. Mfg./Year Model & Location Part No.

PLYMOUTH - FRONT DRIVE - Neon**FRONT WHEEL****FWD**

2001-2000	
Ball Bearing	510057[2]
1999-1995	
Ball Bearing	510032[2]
Hub Unit Bearing (4 Stud)	HA590181K[2] ⁶⁸
Hub Unit Bearing (5 Lug Whl.)	HA590182K[2] ⁶⁸

REAR WHEEL**FWD**

2001-2000	
Hub Unit Bearing	512167[2]
1999-1998	
Hub Unit Bearing	512013[2]
1997-1996	
Hub Unit Bearing	512023[2]
1995	
Hub Unit Bearing (4 Stud)	512021[2]
Hub Unit Bearing (5 Lug Whl.)	512023[2]

CLUTCH**Release Bearing**

2002-1995	
Bearing Assy	614121

3-SPEED AUTOMATIC TRANSAXLE**Differential**

2001-1997 (A404 31TH)(Prod. from mid 1997 on)	
Seal (LH)	3459S
Cone/Cup (LH)	NP889967-NP714580
Seal (RH)	3459S
Cone/Cup (RH)	NP952605-JL69310P
1997-1996 (A404 31TH)(Prod. thru mid 1997)	
Seal (LH)	3459S
Cone/Cup (LH)	NP889967-NP714580
Seal (RH)	3459S
Cone/Cup (RH)	JL69348-JL69310
1995 (A404 31TH)	
Seal	3459S[2]
Cone/Cup	JL69349CP-JL69310[2]

Torque Converter

2001-1995 (A404, 31TH)	
Seal	331228H[2]
Repair Sleeve	KWK99149

3-SPEED AUTOMATIC TRANSAXLE**Transfer Shaft**

2001-1995 (A404 31TH)	
Cone/Cup (LH)	NP952605-JL69310P[2]
Cone/Cup (RH)	NP952605-JL69310P[2]

Output Shaft

2001-1995 (A404 31TH)	
Seal	3459S[2]
Cone/Cup	L68149P-L68111P[2]
Repair Sleeve	KWK99157[2]

Manual Shaft

2001-1995 (A404, 31TH)	
Seal	8609

5-SPEED MANUAL TRANSAXLE**Differential**

2001-1996 (A578)	
Seal	3459S[2]
Set	SET11[2]
Repair Sleeve	KWK99157[2]

Input Shaft

2001-1995 (A578)	
Seal (Frnt)	3732S
Set (Frnt)	SET4[2]
Repair Sleeve	KWK99106
Set (Rr)	SET5[2]

Selector Shaft Seal/Man. Shaft

2001-1995 (A578)	
Seal	3816

CAMSHAFT SEAL**4 Cylinder**

2001-1995 122/2.0L	
Seal Viton	320249
Repair Sleeve	KWK99139

CRANKSHAFT FRONT SEAL**4 Cylinder**

2001-1995 122/2.0L	
Seal Viton	320348
Repair Sleeve	KWK99128

CRANKSHAFT REAR SEAL**4 Cylinder**

2001-1995 122/2.0L	
Seal Viton	710056
Seal PTFE H/D	5279

⁶⁸Kit = Flg, Brg, & Snap Ring

Mfg./Year Model & Location Part No. Mfg./Year Model & Location Part No.

PLYMOUTH - REAR DRIVE - Prowler

FRONT WHEEL

RWD

2001-1997
Hub Unit Bearing 513123[2]

REAR WHEEL

RWD

2001-1997
Hub Unit Bearing 513089[2]

4-SPEED AUTOMATIC TRANSAXLE

Differential

2001-1997 (A606, 42LE)
Seal 3459S[2]
Set SET36[2]
Repair Sleeve KWK99157[2]

Torque Convertor / Frt Pump

2001-1997 (A606, 42LE)
Seal 331228H[2]
Repair Sleeve KWK99149

Transfer Shaft

2001-1997 (A606, 42LE)
Cone/Cup (Outer) 26131H-26334[2]
Cone/Cup (Inner) M802048CP-M802011AP[2]

Output Shaft

2001 (A606, 42LE)
Seal (LH) 4738N
Seal (RH) 4748N
Cone/Cup (Inner) NP117885-LM300811[2]
Cone/Cup (Outer) NP952605-JL69310P[2]
2000-1997 (A606 42LE)(Prod. from mid 1997 on)
Seal (LH) 4738N
Seal (RH) 4748N
Cone/Cup (Inner) LM300848-LM300811[2]
Cone/Cup (Outer) NP952605-JL69310P[2]
1997 (A606 42LE)(Prod. thru mid 1997)
Seal (LH) 4738N
Seal (RH) 4748N
Cone/Cup (Inner) LM300848-LM300811[2]
Cone/Cup (Outer) JL69348-JL69310P[2]

Manual Shaft

2001-1997 (A606, 42LE)
Seal 8609[2]

CAMSHAFT SEAL

6 Cylinder

2001-1997 215/3.5L
Seal 714655[2]
Repair Sleeve KWK99112[2]

CRANKSHAFT FRONT SEAL

6 Cylinder

2001-1997 215/3.5L
Repair Sleeve KWK99139

CRANKSHAFT REAR SEAL

6 Cylinder

2001-1997 215/3.5L
Seal Viton 710056
Seal PTFE H/D 5279

Mfg./Year	Model & Location	Part No.	Mfg./Year	Model & Location	Part No.
-----------	------------------	----------	-----------	------------------	----------

PLYMOUTH - Import - Colt, Laser**FRONT WHEEL****FWD**

1994-1993	Colt	
Seal (Inner)	8430S[2]
Ball Bearing (Inner)	510016[2]
Seal (Outer)	4898[2]
1994-1990	Laser	
Seal (Inner)	225450[2]
Ball Bearing (Inner)	513036[2]
Seal (Outer)	225230[2]
1992-1990	Colt	
Seal	229522[2]
Set	SET41[2]
1991-1990	Colt Vista	
Seal	229522[2]
Set	SET41[2]

4WD

1991-1990	Colt Vista	
Seal (Inner)	225082[2]
Ball Bearing (Inner)	513036[2]
Seal (Outer)	225230[2]

AWD

1994-1992	Colt	
Seal (Inner)	8430S[2]
Ball Bearing (Inner)	510016[2]
Seal (Outer)	4898[2]
1994-1992	Laser	
Seal (Inner)	225450[2]
Ball Bearing (Inner)	513036[2]
Seal (Outer)	225230[2]

REAR WHEEL**FWD**

1994-1993	Colt (ABS)	
Hub Unit Bearing	512033[2]
1994-1993	Colt (Non-ABS)	
Hub Unit Bearing	512148[2]
1994-1992	Colt Vista	
Hub Unit Bearing	512040[2]
1994-1990	Laser (ABS)	
Hub Unit Bearing	512011[2] ⁸¹
1994-1990	Laser (Non-ABS)	
Hub Unit Bearing	512010[2]
1992-1991	Colt (Drum)	
Seal (Inner)	1205N[2]
Bearing Assy	516001WB[2]
1991-1990	Colt Vista	
Seal (Inner)	1196[2]
Set (Inner)	SET4[2]
Set (Outer)	SET1[2]
1990	Colt (2Dr.)(Disc)	
Seal (Inner)	1205N[2]
Bearing Assy	516000[4]
1990	Colt (2Dr.)(Drum)	
Seal (Inner)	1205N[2]
Bearing Assy	516001WB[4]
1990	Colt (4Dr.)	
Seal (Inner)	1205N[2]
Bearing Assy	513029[4] ^Z

4WD

1991-1990	Colt Vista	
Seal (Inner)	710152[2]
Ball Bearing (Inner)	511014[2]
Ball Bearing (Outer)	511015[2]
1990	Colt Vista	
Seal (Inner)	1955[2]

AWD

1994-1992	Colt Vista	
Ball Bearing	511013[2]
1994-1992	Laser	
Seal (Inner)	710152[2]
Ball Bearing (Inner)	511014[2]
Ball Bearing (Outer)	511015[2]

REAR AXLE**Differential**

1994-1990	Colt Ser. (AWD)	
Seal	710396[2]
Bearing Assy	30207M[2]
Repair Sleeve	KWK99139[2]
1994-1990	Laser (AWD)	
Seal	710396[2]
Bearing Assy	30207M[2]
Repair Sleeve	KWK99139[2]

4-SPEED AUTOMATIC TRANSMISSION**Torque Converter**

1994-1990		
Seal	320583
Repair Sleeve	KWK99157

CLUTCH**Release Bearing**

1994-1990	Laser (AWD)(Turbo)	
Bearing Assy	614099
1994-1990	Laser (w/o AWD)(w/o Turbo)	
Bearing Assy	614126
1994-1990	Colt	
Bearing Assy	614126
1991-1990	Colt Vista	
Bearing Assy	614126

3-SPEED AUTOMATIC TRANSAXLE**Differential**

1996-1990	(w/o KM172 0, KM172 5)	
Ball Bearing	207[2]
1990	(KM172 0, KM172 5)	
Bearing Assy	30207M[2]

Torque Converter

1996-1990		
Seal	320583
Repair Sleeve	KWK99157

^ZNon-Cancellable/Non-Returnable⁸¹Holes Exists For Tone Ring, Reuse Tone Ring.

Mfg./Year Model & Location Part No. Mfg./Year Model & Location Part No.

PLYMOUTH - Import - Colt, Laser (cont.)

3-SPEED AUTOMATIC TRANSAXLE

Output Shaft

1996-1990
 Seal 223543[2]
 Repair Sleeve KWK99139[2]

4-SPEED AUTOMATIC TRANSAXLE

Differential

1996-1990 (F4A21 2, F4A22 2, F4A33 1, KM176 5)
 Ball Bearing 207[2]

Torque Convertor / Frt Pump

1996-1990
 Seal 320583
 Repair Sleeve KWK99157

Output Shaft

1996-1993 (F4A21 2, F4A22 2)
 Seal 223543[2]
 Repair Sleeve KWK99139[2]
 1996-1993 (F4A33 1)
 Seal Viton 710259[2]
 1996-1992 (W4A32 1)
 Seal (LH) 223543
 Seal (RH) 710199
 Repair Sleeve KWK99139[2]
 1992-1990 (F4A21 2, F4A22 2, F4A33 1, KM176 5)
 Seal 223543[2]
 Repair Sleeve KWK99139[2]

4-SPEED MANUAL TRANSAXLE

Differential

1992-1990 (F4M21 1)
 Ball Bearing 207[2]

Input Shaft

1992-1990 (F4M21 1, KM200 0)
 Seal Viton 712007
 Repair Sleeve KWK99098

Output Shaft

1992-1990 (F4M21 1, KM200 0)
 Seal 223543[2]
 Bearing Assy 30206M[2]
 Repair Sleeve KWK99139[2]

Selector Shaft Seal/Man. Shaft

1992-1990 (KM160 2)
 Seal 710222

5-SPEED MANUAL TRANSAXLE

Differential

1996-1990 (KM182 2, F5M22 2, KM182 0, KM206 0, KM221 1)
 Bearing Assy 30207M[2]
 1996-1990 (F5M21 1, F5M21 2, W5M31 2, W5M33 2, KM162 0, KM162 0, KM163 0, KM201 0)
 Ball Bearing 207[2]

Input Shaft

1996-1990 (F5M21 1, F5M21 2, F5M22 2, F5M33 2W5M31 2, W5M33 2)
 Seal Viton 712007
 Repair Sleeve KWK99098
 1994-1991 (Getrag)
 Seal Viton 712007
 Repair Sleeve KWK99098
 1991-1990 (KM182 2, KM182 0, KM221 1)
 Seal Viton 712007
 Ball Bearing (Center) 304WB[2]
 Bearing Assy (Rr) 30304[2]
 Repair Sleeve KWK99098

Countershaft

1991-1990 (KM182 0, KM182 2, KM221 1)
 Bearing Assy 30304[2]
 1990 (KM201 0, KM206 0)
 Ball Bearing (Frt) RW122[2]
 Ball Bearing (Rr) 108A[2]

Output Shaft

1996-1993 (F5M33 1)
 Seal Viton 710259[2]
 1996-1992 (W5M33 2)
 Seal (LH) 223543
 Seal (RH) 710199
 Repair Sleeve KWK99139[2]
 1996-1990 (F5M21 1, F5M21 2, F5M22 2, KM201 0, KM206 0)
 Seal 223543[2]
 Bearing Assy 30206M[2]
 Repair Sleeve KWK99139[2]
 1996-1990 (KM182 2, KM162 0, KM163 0, KM221 1, F5M31 2, F5M33 2)
 Seal 223543[2]
 Repair Sleeve KWK99139[2]
 1994-1993 (Getrag)
 Seal Viton 710259[2]
 1993-1992 (W5M31 2)
 Seal (LH) 223543
 Repair Sleeve (LH) KWK99139
 Seal (RH) 1981
 Repair Sleeve (RH) KWK99114
 1992-1991 (Getrag)
 Seal 223543[2]
 Repair Sleeve KWK99139[2]

Mfg./Year	Model & Location	Part No.	Mfg./Year	Model & Location	Part No.
-----------	------------------	----------	-----------	------------------	----------

PLYMOUTH - Import - Colt, Laser (cont.)**5-SPEED MANUAL TRANSAXLE****Pinion**

1996-1990 (W5M31 2, W5M33 2)
 Seal 223014
 Repair Sleeve KWK99114

Selector Shaft Seal/Man. Shaft

1996-1990 (KM162 0)
 Seal 710222

Extension Housing

1993-1992 (W5M31 2)
 Seal 710317
 1991-1990 (KM182 0, KM182 2, KM221
 1)
 Seal 223240
 Bearing Assy 30206M[2]
 Repair Sleeve KWK99128

DRIVESHAFT SUPPORT

1991-1990 Colt Vista (4WD)
 Hanger Bearing Assy HB25[2]

OIL PUMP**4 Cylinder**

1994-1992 2351cc/ 2.4L
 Seal 222025
 Repair Sleeve KWK99078
 1994-1990 1755cc/1.8L (SOHC)
 Seal 221710
 Repair Sleeve KWK99068
 1994-1990 1597cc/1.6L, 1997cc/2.0L,
 2351cc/2.4L
 Seal 222025
 Repair Sleeve KWK99078

CAMSHAFT SEAL**4 Cylinder**

1996-1990 1410cc/1.4L, 1468cc/1.5L,
 1597cc/1.6L, 1755cc/1.8L,
 1834cc/1.8L, 1997cc/2.0L,
 2351cc/2.4L
 Seal 3771
 Repair Sleeve KWK99139

CRANKSHAFT FRONT SEAL**4 Cylinder**

1996-1992 1834cc/1.8L
 Seal 223750
 Repair Sleeve KWK99145
 1996-1990 1468cc/1.5L
 Seal 223018
 Repair Sleeve KWK99114

CRANKSHAFT FRONT SEAL (cont.)**4 Cylinder (cont.)**

1996-1990 1595cc/1.6L (DOHC),
 1597cc/1.6L, 1755cc/1.8L,
 1997cc/2.0L, 2351cc/2.4L
 Seal 224460

CRANKSHAFT REAR SEAL**4 Cylinder**

1996-1990 1595cc/1.6L (DOHC),
 1834cc/1.8L, 1997cc/2.0L
 (DOHC), 2351cc/2.4L
 Seal Viton 228005
 Repair Sleeve KWK99315
 1996-1990 1410cc/1.4L, 1468cc/1.5L,
 1597cc/1.6L, 1755cc/1.8L0L
 Seal 227235
 1991-1990 1997cc/2.0L (SOHC), 156/2.6L
 Seal Viton 228005
 Repair Sleeve KWK99315

Mfg./Year Model & Location Part No. Mfg./Year Model & Location Part No.

PLYMOUTH - Minivan - (See also Chrysler) - Grand Voyager, Voyager

FRONT WHEEL

FWD

2000-1996 (14" Whl.)	
Hub Unit Bearing	513122[2]
2000-1996 (15", 16", 17" Whl.)	
Hub Unit Bearing	513123[2]
1995-1991 (14" Whl.)	
Hub Unit Bearing	513075[2]
1995-1990 (15" Whl.)	
Hub Unit Bearing	513074[2] ⁴⁴
1990 (14" Whl.)	
Seal	5604[2] ⁵⁶
Ball Bearing	513006[2]
Hub Unit Bearing (4 Stud)	518501[2] ⁶²
Hub Unit Bearing (5 Lug Whl.)	518502[2] ⁶³

AWD

1995-1991	
Hub Unit Bearing	513074[2] ⁴⁴

REAR WHEEL

FWD

2000-1996 (Drum)	
Hub Unit Bearing (14" Whl.)	512155[2]
Hub Unit Bearing (15", 16", & 17" Whl)	512156[2]
1995-1990	
Seal (Inner)	4249[2]
Set (Inner)	SET17[2]
Set (Outer)	SET16[2]

AWD

1995-1991	
Hub Unit Bearing	512125[2]

AWD REAR AXLE

Differential

2000-1994	
Cone/Cup	JL69349H-JL69310[2]

Pinion

2000-1994	
Set (Inner)	SET45
Set (Outer)	SET17

TRANSFER CASE

Input Shaft

2000-1991	
Seal	710501

TRANSFER CASE

Front Output Shaft

2000-1991	
Seal	3459S
Repair Sleeve	KWK99157
Ball Bearing	106WB

5-SPEED MANUAL TRANSMISSION

Selector Shaft Seal/Man. Shaft

1995-1990	
Seal	3816

3-SPEED AUTOMATIC TRANSAXLE

Differential

2000-1997 31TH	
Seal (LH)	3459S
Cone/Cup (LH)	NP889967-NP714580
Seal (RH)	3459S
Cone/Cup (RH)	NP952605-JL69310P
1996-1990 (A413, A670, 31TH)	
Seal	3459S[2]
Set	SET11[2]
Repair Sleeve (Opt)	KWK99157[2]
1995-1992 (A404 31TH)	
Seal	3459S[2]
Cone/Cup	JL69349CP-JL69310P[2]
1991-1990	
Seal	3459S[2]
Cone/Cup	JL69349H-JL69310[2]

Torque Converter

2000-1990 (A413, 31TH)	
Seal	331228H[2]
Repair Sleeve	KWK99149

Transfer Shaft

2000-1990 (A413, A670, 31TH)	
Set	SET11[2]

Output Shaft

2000-1992 31TH	
Seal	3459S[2]
Cone/Cup	L68149P-L68111P[2]
Repair Sleeve (RH)	KWK99157[2]
Seal (RH)	L68149P-L68111P
1991-1990 (A413, 31TH)	
Seal	3459S[2]
Set	SET17[2]
Repair Sleeve	KWK99157[2]

Manual Shaft

2000-1990 (A413, 31TH)	
Seal	8609[2]

⁴⁴Brg Flg Mtg Holes Threaded. Studded Spindle, Seal, & Bearing

⁵⁶Opt. Kit = Seal 3948 & Sleeve

⁶²Kit = Plate, Gasket, 3 Bolts,

⁶³Kit = Plate, Gasket, 3 Bolts, Studded Spindle, Seal, & Bearing

Mfg./Year Model & Location Part No. Mfg./Year Model & Location Part No.

PLYMOUTH - Minivan - (See also Chrysler) - Grand Voyager, Voyager (cont.)**4-SPEED AUTOMATIC TRANSAXLE****Differential**

2000-1997	(A604 41TE)(AWD)(Prod. from mid 1997 on)
Cone/Cup (LH)	NP889967-NP714580
Cone/Cup (RH)	NP952605-JL69310P
2000-1997	(A604 41TE)(Prod. from mid 1997 on)
Cone/Cup (LH)	NP889967-NP714580
Cone/Cup (RH)	NP952605-JL69310P
1997	(A604 41TE)(AWD)(Prod. thru mid 1997)
Cone/Cup (LH)	NP889967-NP714580
Cone/Cup (RH)	JL69348-JL69310
1997-1996	(A604 41TE)(Prod. thru mid 1997)
Cone/Cup (LH)	NP889967-NP714580
Cone/Cup (RH)	JL69348-JL69310
1995-1994	(A604 41TE)(AWD)
Cone/Cup (LH)	JL69348-JL69310
Cone/Cup (RH)	LM503349-LM503310
1995-1991	(A604 41TE)
Cone/Cup	JL69348-JL69310[2]
1993-1991	(A604 41TE)(AWD)
Cone/Cup (LH)	JL69348-JL69310
Cone (RH)	LM503349
1990	(A604, A670)
Set	SET11[2]

Torque Converter / Frt Pump

2000-1990	(A604, A604, A670, 41TE)(incl. AWD)
Seal	331228H[2]

Transfer Shaft

2000-1996	(A604, 41TE)
Cone/Cup (Inner)	NP853895-NP352518[2]
Set (Outer)	SET45[2]
1995-1991	(A604, 41TE)
Cone/Cup (Inner)	13687-13623X[2]
Set (Outer)	SET45[2]

Output Shaft

2000-1997	(A604 41TE)(AWD)(Prod. from mid 1997 on)
Cone/Cup (Outer)	LM300848-LM300911[2]
Cone/Cup (Inner)	NP952605-JL69310P[2]
Seal	3459S[2]
Repair Sleeve	KWK99157[2]
2000-1997	(A604 41TE)(Prod. from mid 1997 on)
Cone/Cup (Outer)	LM300848-LM300911[2]
Cone/Cup (Inner)	NP952605-JL69310P[2]
Seal	3459S[2]
Repair Sleeve	KWK99157[2]
1997-1991	(A604 41TE)(AWD)(Prod. thru mid 1997)
Cone/Cup (Outer)	LM300848-LM300811[2]
Cone/Cup (Inner)	JL69348-JL69310[2]
Seal	3459S[2]
Repair Sleeve	KWK99157[2]

4-SPEED AUTOMATIC TRANSAXLE**(cont.)****Output Shaft (cont.)**

1997-1991	(A604 41TE)(Prod. thru mid 1997)
Cone/Cup (Outer)	LM300848-LM300811[2]
Cone/Cup (Inner)	JL69348-JL69310[2]
Seal	3459S[2]
Repair Sleeve	KWK99157[2]
1990	(A604)
Seal	3459S[2]
Set	SET17[2]
Repair Sleeve	KWK99157[2]

Manual Shaft

2000-1990	(A604, 41TE)
Seal	8609[2]

CAMSHAFT SEAL**4 Cylinder**

2000-1996	148/2.4L
Seal Viton	320249[2]
Repair Sleeve	KWK99139[2]
1995-1990	153/2.5L
Seal	3655S
Repair Sleeve	KWK99139

6 Cylinder

2000-1990	2972cc/3.0L
Seal	3771[2]
Repair Sleeve	KWK99139[2]

INTERMEDIATE SHAFT**6 Cylinder**

2000-1990	201/3.3L, 230/3.8L
Seal	3655S

CRANKSHAFT FRONT SEAL**4 Cylinder**

2000-1996	148/2.4L
Seal Viton	320348
Repair Sleeve	KWK99128
1995-1990	153/2.5L
Seal	3638
Repair Sleeve	KWK99112

6 Cylinder

2000-1990	201/3.3L, 230/3.8L
Seal	3638
Repair Sleeve	KWK99112
2000-1990	2972cc/3.0L
Seal	223750

Mfg./Year	Model & Location	Part No.	Mfg./Year	Model & Location	Part No.
PLYMOUTH - Minivan - (See also Chrysler) - Grand Voyager, Voyager (cont.)					

CRANKSHAFT REAR SEAL

4 Cylinder

2000-1990	135/2.2L, 153/2.5L, 181/3.0L, 201/3.3L, 229/3.8L	
Seal Viton	710056
Seal PTFE H/D	5279

6 Cylinder

2000-1990	2972cc/3.0L, 201/3.3L, 231/3.8L	
Seal Viton	710056
Seal PTFE H/D	5279

PONTIAC - FRONT DRIVE - Bonneville

FRONT WHEEL

FWD

2005-2004	GXP	
Hub Unit Bearing	HA590093[2] ⁴⁰
2005-2001	SE, SLE, SSEi (2nd Design)	
Hub Unit Bearing	513179[2] ⁷³
2001-2000	(1st Design)	
Hub Unit Bearing	513121[2] ⁷²
1999-1992	(ABS)	
Hub Unit Bearing	513087[2] ⁴⁵
1992	(Non-ABS)	
Hub Unit Bearing	513088[2]
1991-1990		
Hub Unit Bearing	513016K[2] ⁶¹

REAR WHEEL

FWD

2005-2000		
Hub Unit Bearing	512003[2]
1999-1991	(ABS)	
Hub Unit Bearing	513062[2]
1992-1990	(Non-ABS)	
Hub Unit Bearing	513018[2]
1990	(ABS)	
Hub Unit Bearing	513041[2]

4-SPEED AUTOMATIC TRANSAXLE

Torque Convertor / Frt Pump

2005-2004	(4T80 E)	
Seal	224840
Repair Sleeve	KWK99189
2005-1990	(4T60E, 4T65E)	
Seal	4072N
Repair Sleeve	KWK99172

Output Shaft

2005-2004	(4T80 E)	
Seal (LH)	714679
Seal (RH)	4674N
2005-1998	(4T65 E)	
Seal (LH) (Yellow)	100165
Seal (RH) (Green)	3543
Repair Sleeve	KWK99139[2]

4-SPEED AUTOMATIC TRANSAXLE (cont.)

Output Shaft (cont.)

1997-1990		
Seal (LH)	710096
Seal (RH)	3543
Repair Sleeve	KWK99139[2]

Manual Shaft

2005-1992	(4T60E, 4T65E, 4T80E)	
Seal	8792S

ALTERNATOR

1997-1990	(Delco)	
Ball Bearing (Rear End)	100CCAB
Ball Bearing (Drive End)	203FF

POWER STEERING

Pump Shaft

2000-1992		
Seal	7013S

CRANKSHAFT FRONT SEAL

6 Cylinder

2005-1990	231/3.8L	
Seal Viton	710162
Repair Sleeve	KWK99193

CRANKSHAFT REAR SEAL

6 Cylinder

2005-1991	3.8L	
Seal Viton	320691
Seal PTFE H/D	5291
1990	231/3.8L	
Seal	5591

⁴⁰5 Stud. ⁴⁵Brg Flg Mtg Holes Non-Threaded.

⁷²Steel Wire Clip. Brg Flg Mtg Holes Threaded.

⁶¹Kit = Seal, Hub Nut, & Brg Unit

⁷³Plastic Wire Clip.

Mfg./Year Model & Location Part No. Mfg./Year Model & Location Part No.

PONTIAC - FRONT DRIVE - Bonneville (cont.)

CRANKSHAFT REAR SEAL

8 Cylinder

2005-2004 4.6L (DOHC)
Seal Viton 710262

PONTIAC - FRONT DRIVE - G5, Pursuit

FRONT WHEEL

FWD

2009-2007 (ABS)(15" Whl)
Hub Unit Bearing HA590068[2]
2009-2007 (ABS)(16" & 17" Whls)
Hub Unit Bearing HA590086[2]
2009-2007 (Non-ABS)
Hub Unit Bearing HA590069[2]

REAR WHEEL

FWD

2009-2007 (ABS)(Drum)
Hub Unit Bearing (4
Stud) HA590066[2]
Hub Unit Bearing (5
Lug Whl.) HA590088[2]
2009-2007 (Disc)
Hub Unit Bearing HA590088[2]
2009-2007 (Non-ABS)(Drum)
Hub Unit Bearing HA590067[2]

4-SPEED AUTOMATIC TRANSAXLE

Torque Converter / Frt Pump

2008-2007 (4T45E)
Seal 4072N

4-SPEED AUTOMATIC TRANSAXLE

Manual Shaft

2008-2007 (4T45E)
Seal 8792S

CRANKSHAFT REAR SEAL

4 Cylinder

2009-2005
Seal Viton 710237
Repair Sleeve KWK99354

PONTIAC - FRONT DRIVE - G6

FRONT WHEEL

FWD

2008-2006 (Non-ABS)
Hub Unit Bearing HA590071[2]
2008-2005 (ABS)
Hub Unit Bearing HA590070[2]

REAR WHEEL

FWD

2008-2005 (ABS)
Hub Unit Bearing HA590080[2]
2008-2005 (Non-ABS)
Hub Unit Bearing HA590081[2]

4-SPEED AUTOMATIC TRANSAXLE

Torque Converter / Frt Pump

2008-2006 (4T45E, 4T65E)
Seal 4072N
Repair Sleeve KWK99172

Output Shaft

2008-2005 (4T40E)
Seal SL260001[2]²⁵
Repair Sleeve KWK99139[2]
2006 (4T65 E)
Seal (LH) (Yellow) 100165
Repair Sleeve (LH) KWK99139
Seal (RH) (Green) 3543
Repair Sleeve (RH) KWK99139

²⁵New Item, Check For Availability

Mfg./Year Model & Location Part No. Mfg./Year Model & Location Part No.

PONTIAC - FRONT DRIVE - G6 (cont.)

4-SPEED AUTOMATIC TRANSAXLE

Manual Shaft

2008-2005 (4T45E, 4T65E)
Seal8792S

CRANKSHAFT FRONT SEAL

4 Cylinder

2009-2006 2.4L (DOHC)
Seal Viton710237

6 Cylinder

2008-2005 213/3.5L, 237/3.9L
Seal9845
Repair SleeveKWK99176
Harmnc Balancer Slvs 88176

CRANKSHAFT REAR SEAL

6 Cylinder

2009-2005 3.5L
Seal4307V
Seal PTFE H/D 5273
Repair SleeveKWK99298

CRANKSHAFT REAR SEAL (cont.)

6 Cylinder (cont.)

2006 3.9L
Seal4307V
Seal PTFE H/D 5273
Repair SleeveKWK99298

PONTIAC - FRONT DRIVE - Grand Am

FRONT WHEEL

FWD

2005-1999
Hub Unit Bearing 513137[2]
1998-1990
Hub Unit Bearing 513017K[2]⁶¹
Seal Kit5697[2]¹²

REAR WHEEL

FWD

2005-2001
Hub Unit Bearing 512152[2]
2000-1999 (Disc)
Hub Unit Bearing 512152[2]
2000-1999 (Drum)
Hub Unit Bearing 512003[2]
1998-1991
Hub Unit Bearing 512001[2]
1990
Hub Unit Bearing 513012[2]

CLUTCH

Pilot Bearing

1991-1990 (4 Cyl.)
BushingPB650

Release Bearing

2001-2000 146/2.4L
Hyd. Bearing Assy 619006

CLUTCH (cont.)

Release Bearing (cont.)

1999-1995 (5 Spd.)(Isuzu Trans.)(Hyd. piston type)
Hyd. Bearing Assy 619006
1994-1992 4 Cyl. 2.3 (DOHC)(T550 Trans.)(Hyd. piston type)
Hyd. Bearing Assy 619005
1994-1992 4 Cyl. 2.3 (SOHC)(5 Spd.)(Isuzu Trans.)
Bearing Assy614108
1994-1992 Quad4 (5 Spd.)(Isuzu Trans.)
Bearing Assy614108
1992-1990 Quad4 (5 Spd.)(Muncie Trans.)
Bearing Assy614069
1992-1990 6 Cyl. (5 Spd.)
Bearing Assy614069
1992-1990 4 Cyl. (w/o Quad4)(5 Spd.)
Bearing Assy614108

3-SPEED AUTOMATIC TRANSAXLE

Torque Converter

1995-1990 (THM125C)
Seal4072N

¹²Opt = Seal & O-Ring. Incl w/ Hub Unit.

⁶¹Kit = Seal, Hub Nut, & Brg Unit

Mfg./Year	Model & Location	Part No.	Mfg./Year	Model & Location	Part No.
PONTIAC - FRONT DRIVE - Grand Am (cont.)					

3-SPEED AUTOMATIC TRANSAXLE**Output Shaft**

1995-1990 (THM125C)	
Seal	3543[2]
Repair Sleeve	KWK99139[2]

Manual Shaft

1995-1990 (THM125C)	
Seal	8792S

4-SPEED AUTOMATIC TRANSAXLE**Torque Converter / Frt Pump**

2005-1990 (4T40E, 4T45E, 4T60E)	
Seal	4072N
Repair Sleeve	KWK99172

Output Shaft

2005-1996 (4T40E, 4T45E)	
Seal	SL260001[2] ²⁵
1998-1990 (4T60E)	
Seal (LH)	710096
Repair Sleeve (LH)	KWK99139
Seal (RH)	3543
Repair Sleeve (RH)	KWK99139

Manual Shaft

2005-1990 (4T40E, 4T45E, 4T60E)	
Seal	8792S

5-SPEED MANUAL TRANSAXLE**Input Shaft**

2004-1990	
Seal	222835
Ball Bearing	306VVL[2]
Repair Sleeve	KWK99111

Output Shaft

2004-1990	
Seal	3543[2]
Repair Sleeve	KWK99139[2]
Bearing Assy (RH)	32206M[2]
Set (LH)	SET5[2]

Selector Shaft Seal/Man. Shaft

2004-1990	
Seal	8792S

ALTERNATOR

1992-1990 (Delco)	
Ball Bearing (Drive End)	203FF
Ball Bearing (Rear End)	100CCAB

POWER STEERING**Pump Shaft**

2000-1992	
Seal	7013S

CAMSHAFT SEAL**4 Cylinder**

1995-1990 138/2.3L (DOHC)	
Seal Viton	713771
Repair Sleeve	KWK99139
1994-1992 138/2.3L (SOHC)	
Seal Viton	713771
Repair Sleeve	KWK99139

CRANKSHAFT FRONT SEAL**4 Cylinder**

2001-1996 2.4L (DOHC)	
Seal Viton	320259
1995-1990 138/2.3L (DOHC)	
Seal Viton	320259
1994-1992 138/2.3L (SOHC)	
Seal Viton	320259
1991-1990 151/2.5L	
Seal	9845
Repair Sleeve	KWK99176
Harmnc Balancer Slvs	88176

6 Cylinder

2005-1999 201/3.4L	
Seal	9845
Repair Sleeve	KWK99176
Harmnc Balancer Slvs	88176
1998-1994 189/3.1L	
Seal	9845
Repair Sleeve	KWK99176
Harmnc Balancer Slvs	88176
1993-1992 3300/3.3L	
Seal Viton	710162
Repair Sleeve	KWK99193

CRANKSHAFT REAR SEAL**4 Cylinder**

2005-2002 2.2L (DOHC)	
Seal Viton	710237
2001-1996 146/2.4L	
Seal	40375
1995-1990 138/2.3L (DOHC)	
Seal	40375
1994-1992 138/2.3L (SOHC)	
Seal	40375
1991-1990 151/2.5L	
Seal	3698

6 Cylinder

2005-1999 201/3.4L	
Seal	4307V
Seal PTFE H/D	5273
Repair Sleeve	KWK99298
1998-1994 189/3.1L	
Seal	4307V
Seal PTFE H/D	5273
Repair Sleeve	KWK99298
1993-1992 3300/3.3L	
Seal Viton	320691
Repair Sleeve	KWK99328

²⁵New Item, Check For Availability

Mfg./Year Model & Location Part No. Mfg./Year Model & Location Part No.

PONTIAC - FRONT DRIVE - Grand Prix

FRONT WHEEL

FWD

2008-2004 (ABS)	
Hub Unit Bearing	HA590093[2] ⁴⁰
2008-2004 (Non-ABS)	
Hub Unit Bearing	HA590085[2] ⁸⁴
2003-2001 (2nd Design)	
Hub Unit Bearing	
(ABS)	513179[2] ⁷³
Hub Unit Bearing	
(Non-ABS)	HA590085[2] ⁸⁴
2001-1997 (1st Design)	
Hub Unit Bearing	513121[2] ⁷²
1996-1990	
Hub Unit Bearing	513044[2]

REAR WHEEL

FWD

2008-2004 (ABS)	
Hub Unit Bearing	HA590092[2]
2008-2004 (Non-ABS)	
Hub Unit Bearing	HA590074[2]
2003 (ABS)	
Hub Unit Bearing	512237[2] ⁸⁴
2003 (Non-ABS)	
Hub Unit Bearing	512221[2]
2002-1997	
Hub Unit Bearing	512150[2] ⁸³
Hub Unit Bearing	512237[2] ⁸⁴
1996-1992 (ABS)	
Hub Unit Bearing	512004[2]
1996-1990 (Non-ABS)	
Hub Unit Bearing	513018[2]
1991-1990 (ABS)	
Hub Unit Bearing	513042[2]

CLUTCH

Release Bearing

1996-1995 (5 Spd.)(Isuzu Trans.)(Hyd. piston type)	
Hyd. Bearing Assy	619006
1994-1992 Quad4 (5 Spd.)(Isuzu Trans.)	
Bearing Assy	614108
1992-1991 3.4 V6 (5 Spd.)(pull type Cl.)	
Bearing Assy	614108
1992-1990 4 Cyl. (w/o Quad4 & Turbo)(5 Spd.)	
Bearing Assy	614108
1992-1990 6 Cyl. (5 Spd.)	
Bearing Assy	614069
1992-1990 Quad4 (5 Spd.)(Muncie Trans.)	
Bearing Assy	614069

3-SPEED AUTOMATIC TRANSAXLE

Torque Converter

1993-1990	
Seal	4072N

3-SPEED AUTOMATIC TRANSAXLE

Output Shaft

1993-1990	
Seal	3543[2]
Repair Sleeve	KWK99139[2]

Manual Shaft

1993-1990	
Seal	8792S

4-SPEED AUTOMATIC TRANSAXLE

Torque Converter / Frt Pump

2008-1990 (4T60E, 4T65E)	
Seal	4072N
Repair Sleeve	KWK99172

Output Shaft

2008-1997 (4T65 E)	
Seal (LH) (Yellow)	100165
Repair Sleeve (LH)	KWK99139
Seal (RH) (Green)	3543
Repair Sleeve (RH)	KWK99139
2000-1990 (THM440 T4, 4T60, 4T60 E)	
Seal (LH)	710096
Repair Sleeve (LH)	KWK99139
Seal (RH)	3543
Repair Sleeve (RH)	KWK99139

Manual Shaft

2008-1990	
Seal	8792S

5-SPEED MANUAL TRANSAXLE

Input Shaft

2000-1990	
Seal	222835
Ball Bearing	306VVL[2]
Repair Sleeve	KWK99111

Output Shaft

2000-1990	
Seal (LH)	3543[2]
Repair Sleeve	KWK99139[2]
Bearing Assy (RH)	32206M[2]
Set (LH)	SET5[2]

Selector Shaft Seal/Man. Shaft

2001-1990	
Seal	3667

ALTERNATOR

2002-1990 (Delco)	
Ball Bearing (Drive End)	203FF
Ball Bearing (Rear End)	100CCAB

⁴⁰5 Stud. Inventory

⁷²Steel Wire Clip. Brg Flg Mtg Holes Threaded.
⁸⁴Reorder

⁷³Plastic Wire Clip.

⁸³Deplete

Mfg./Year Model & Location Part No. Mfg./Year Model & Location Part No.

PONTIAC - FRONT DRIVE - Grand Prix (cont.)**CRANKSHAFT FRONT SEAL****4 Cylinder**

1991-1990 138/2.3L
Seal Viton 320259

6 Cylinder

2005-1997 231/3.8L
Seal Viton 710162
Repair Sleeve KWK99193
2003-1990 173/2.8L, 189/3.1L, 207/3.4L
Seal 9845
Repair Sleeve KWK99176

8 Cylinder

2007-2005 325/ 5.3L
Seal Viton 100470
Repair Sleeve KWK99210

CRANKSHAFT REAR SEAL**4 Cylinder**

1991-1990 138/2.3L
Seal 40375

6 Cylinder

2008-1997 3.8L
Seal Viton 320691
Repair Sleeve KWK99322

CRANKSHAFT REAR SEAL (cont.)**6 Cylinder (cont.)**

2003-1990 189/3.1L, 207/3.4L
Seal 4307V
Seal PTFE H/D 5273
Repair Sleeve KWK99298

8 Cylinder

2008-2005 5.3L
Seal 100085

PONTIAC - FRONT DRIVE - Sunbird**FRONT WHEEL****FWD**

1994-1990
Hub Unit Bearing 513017K[2]⁶¹

REAR WHEEL**FWD**

1994-1992
Hub Unit Bearing 512001[2]
1991-1990
Hub Unit Bearing 513012[2]

CLUTCH**Release Bearing**

1994-1991 6 Cyl. (5 Spd.)
Bearing Assy 614069
1994-1990 4 Cyl. 2.0 (Turbo)(5 Spd.)
Bearing Assy 614069
1993-1990 4 Cyl. (w/o Quad4 & Turbo)(5
Spd.)
Bearing Assy 614108
1991-1990 4 Cyl. 1.8 (Turbo)(5 Spd.)
Bearing Assy 614108

3-SPEED AUTOMATIC TRANSAXLE**Torque Converter**

1994-1990 (THM125C)
Seal 4072N

Output Shaft

1994-1990 (THM125C)
Seal 3543[2]
Repair Sleeve KWK99139[2]

Manual Shaft

1994-1990 (THM125C)
Seal 8792S

5-SPEED MANUAL TRANSAXLE**Input Shaft**

1994-1990
Seal 222835
Ball Bearing 306VVVL[2]
Repair Sleeve KWK99111

⁶¹Kit = Seal, Hub Nut, & Brg Unit

Mfg./Year Model & Location Part No. Mfg./Year Model & Location Part No.

PONTIAC - FRONT DRIVE - Sunbird (cont.)

5-SPEED MANUAL TRANSAXLE

Output Shaft

1994-1990
 Seal3543[2]
 Repair SleeveKWK99139[2]
 Bearing Assy (RH)32206M[2]
 Set (LH)SET5[2]

Selector Shaft Seal/Man. Shaft

1994-1990
 Seal3667

ALTERNATOR

1992-1990 (Delco)
 Ball Bearing (Rear End)100CCAB
 1992-1990 (Delco)
 Ball Bearing (Drive End)203FF

CRANKSHAFT FRONT SEAL

4 Cylinder

1994-1990 112/1.8L, 122/2.0L, 151/2.5L
 Seal9845
 Repair SleeveKWK99176

6 Cylinder

1994-1991 189/3.1L
 Seal9845
 Repair SleeveKWK99176

CRANKSHAFT REAR SEAL

4 Cylinder

1994-1990 122/2.0L
 Seal4307V
 Seal PTFE H/D5273
 Repair SleeveKWK99298

6 Cylinder

1994-1991 189/3.1L
 Seal4307V
 Seal PTFE H/D5273
 Repair SleeveKWK99298

PONTIAC - FRONT DRIVE - Sunfire

FRONT WHEEL

FWD

2005-1995
 Hub Unit Bearing513017K[2]⁶¹

REAR WHEEL

FWD

2005-2003 (Non-ABS)
 Hub Unit Bearing513012[2]
 2005-1995 (ABS)
 Hub Unit Bearing512001[2]

CLUTCH

Release Bearing

1999-1995
 Hyd. Bearing Assy619006

3-SPEED AUTOMATIC TRANSAXLE

Torque Converter

2000-1995 (THM125C)
 Seal4072N

3-SPEED AUTOMATIC TRANSAXLE

Output Shaft

2000-1995 (THM125C)
 Seal3543[2]
 Repair SleeveKWK99139[2]

Manual Shaft

2001-1995 (THM125C)
 Seal8792S

4-SPEED AUTOMATIC TRANSAXLE

Torque Converter / Frt Pump

2005-1995 (4T40E)
 Seal4072N
 Repair SleeveKWK99172

Output Shaft

2005-1995 (4T40E)
 SealSL260001[2]²⁵

²⁵New Item, Check For Availability

⁶¹Kit = Seal, Hub Nut, & Brg Unit

Mfg./Year Model & Location Part No. Mfg./Year Model & Location Part No.

PONTIAC - FRONT DRIVE - Sunfire (cont.)

4-SPEED AUTOMATIC TRANSAXLE

Manual Shaft

2005-1995 (4T40E)
Seal 8792S

5-SPEED MANUAL TRANSAXLE

Input Shaft

2005-1995
Seal 222835
Ball Bearing 306VVL[2]
Repair Sleeve KWK99111

Output Shaft

2005-1995
Seal 3543[2]
Repair Sleeve KWK99139[2]
Bearing Assy (RH) 32206M[2]
Set (LH) SET5[2]

Selector Shaft Seal/Man. Shaft

2005-1995
Seal 8792S

CAMSHAFT SEAL

4 Cylinder

1995 138/2.3L (DOHC)
Seal Viton 713771
Repair Sleeve KWK99139

CRANKSHAFT FRONT SEAL

4 Cylinder

2002-1996 2.4L (DOHC)
Seal Viton 320259
2002-1995 2.2L (OHV)
Seal 9845
Repair Sleeve KWK99176
Harmnc Balancer Slvs 88176

CRANKSHAFT FRONT SEAL (cont.)

4 Cylinder (cont.)

1995 2.3L (DOHC), 2.4L (DOHC)
Seal Viton 320259

CRANKSHAFT REAR SEAL

4 Cylinder

2005-2002 2.2L (DOHC)
Seal Viton 710237
2002-1995 138/2.3L, 146/2.4L
Seal 40375
2002-1995 2.2L (OHV)
Seal 4307V
Seal PTFE H/D 5273
Repair Sleeve KWK99298

PONTIAC - FRONT DRIVE, AWD - 6000

FRONT WHEEL

FWD

1991-1990
Hub Unit Bearing 513016K[2]⁶¹

AWD

1990
Hub Unit Bearing 513016K[2]⁶¹

REAR WHEEL

FWD

1991-1990 (Non-ABS)
Hub Unit Bearing 513018[2]
1990 (ABS)(JL9 Brks.)
Hub Unit Bearing 513039[2]

AWD

1990
Hub Unit Bearing 513016K[2]⁶¹
Seal Kit 5698[2]¹²

REAR AXLE

Axle Shaft

1990
Seal 3543[2]

Differential Rebuild Kit

1990
Kit DRK320A

¹²Opt = Seal & O-Ring. Incl w/ Hub Unit.

⁶¹Kit = Seal, Hub Nut, & Brg Unit

Mfg./Year Model & Location Part No. Mfg./Year Model & Location Part No.

PONTIAC - FRONT DRIVE, AWD - 6000 (cont.)

AWD REAR AXLE

Differential

1990 (AWD)
Set SET11[2]

Pinion

1990 (AWD)
Cone/Cup (Inner) M88048S-M88010
Cone/Cup (Outer) M86649-M86610
Seal 710532
Repair Sleeve KWK99152

TRANSFER CASE

Input Shaft

1990
Bearing Assy 32205B[2]

Front Output Shaft

1990
Cone/Cup M88048-M88010[2]

Rear Output Shaft

1990
Cone/Cup M86649-M86610[2]

CLUTCH

Release Bearing

1991-1990 6 Cyl. (5 Spd.)
Bearing Assy 614069
1991-1990 4 Cyl. (w/o Quad4 & Turbo)(5 Spd.)
Bearing Assy 614108

3-SPEED AUTOMATIC TRANSAXLE

Torque Converter

1991-1990 (THM125C)
Seal 4072N

Output Shaft

1991-1990
Seal 3543[2]
Repair Sleeve KWK99139[2]

Manual Shaft

1991-1990
Seal 8792S

4-SPEED AUTOMATIC TRANSAXLE

Torque Converter / Frt Pump

1991-1990 (THM440 T4)
Seal 4072N

4-SPEED AUTOMATIC TRANSAXLE

Output Shaft

1991-1990 (THM440 T4, 4T60, 4T60 E)
Seal (LH) 710096
Seal (RH) 3543
Repair Sleeve KWK99139[2]

Manual Shaft

1991-1990
Seal 8792S

5-SPEED MANUAL TRANSAXLE

Input Shaft

1991-1990
Seal 222835
Ball Bearing 306VVL[2]
Repair Sleeve KWK99111

Output Shaft

1991-1990
Seal 3543[2]
Set (LH) SET5[2]
Bearing Assy (RH) 32206M[2]
Repair Sleeve KWK99139[2]

Selector Shaft Seal/Man. Shaft

1991-1990
Seal 3667

ALTERNATOR

1991-1990 (Delco)
Ball Bearing (Drive End) 203FF
Ball Bearing (Rear End) 100CCAB

CRANKSHAFT FRONT SEAL

4 Cylinder

1991-1990 151/2.5L
Seal 9845
Repair Sleeve KWK99176
Harmnc Balancer Slvs 88176

6 Cylinder

1991-1990 173/2.8L, 189/3.1L
Seal 9845
Repair Sleeve KWK99176
Harmnc Balancer Slvs 88176

CRANKSHAFT REAR SEAL

4 Cylinder

1991-1990 151/2.5L
Seal 3698

Mfg./Year Model & Location Part No. Mfg./Year Model & Location Part No.

PONTIAC - FRONT DRIVE, AWD - 6000 (cont.)**CRANKSHAFT REAR SEAL****6 Cylinder**

1991-1990	173/2.8L, 189/3.1L	
Seal	4307V
Seal PTFE H/D	5273
Repair Sleeve	KWK99298

PONTIAC - FRONT DRIVE, AWD - Vibe**FRONT WHEEL****FWD**

2009	1.8L	
Ball Bearing	510070[2]
2009	2.4L	
Ball Bearing	510063[2]
2008-2003		
Ball Bearing	510070[2]

AWD

2009	2.4L	
Ball Bearing	510063[2]
2006-2003		
Ball Bearing	510070[2]

REAR WHEEL**FWD**

2009	(Non GT)(1.8L)	
Hub Unit Bearing 1.8L	HA590305[2] ²⁵
2009	(Non GT)(2.4)	
Hub Unit Bearing 2.4L	HA590311[2] ²⁵
2009	GT	
Hub Unit Bearing	HA590310[2] ²⁵
2008-2003	(ABS)	
Hub Unit Bearing	512215[2] ¹⁶
Hub Unit Bearing	512217[2] ⁸⁴
2008-2003	(Non-ABS)	
Hub Unit Bearing	512218[2] ⁸⁴

AWD

2009		
Hub Unit Bearing	HA590294[2] ²⁵
2006-2003	(ABS)	
Hub Unit Bearing	HA590002[2]

5-SPEED MANUAL TRANSMISSION**Selector Shaft Seal/Man. Shaft**

2008-2003		
Seal	1015N

4-SPEED AUTOMATIC TRANSAXLE**Output Shaft**

2008-2007	(Aisin U240E)	
Seal	223540[2]
Repair Sleeve	KWK99139[2]
2006-2003	(Aisin A246E)	
Seal (LH)	710109
Seal (RH)	710110

4-SPEED AUTOMATIC TRANSAXLE**(cont.)****Output Shaft (cont.)**

2006-2003	(Aisin U240E, U341F)	
Seal	223540[2]
Repair Sleeve	KWK99139[2]

Manual Shaft

2006-2003	(Aisin A246E)	
Seal	221207
Repair Sleeve	KWK99049

5-SPEED MANUAL TRANSAXLE**Input Shaft**

2006-2003		
Seal	320603

6-SPEED MANUAL TRANSAXLE**Input Shaft**

2006-2003		
Seal	320603

CRANKSHAFT FRONT SEAL**4 Cylinder**

2008-2003	1794cc/1.8L, 1796cc/1.8L	
Seal	223800
Repair Sleeve	KWK99147

CRANKSHAFT REAR SEAL**4 Cylinder**

2009-2003	1.8L (DOHC)(w/ H.O.)	
Seal	716102
2009-2003	1.8L (DOHC)(w/o H.O.)	
Seal	3698

¹⁶Obsolete²⁵New Item, Check For Availability⁸⁴Reorder

Mfg./Year Model & Location Part No. Mfg./Year Model & Location Part No.

PONTIAC - REAR DRIVE - G8

FRONT WHEEL

RWD

2009-2008
Hub Unit Bearing HA590299[2]²⁵

REAR WHEEL

RWD

2009-2008
Ball Bearing WB000027[2]²⁵

5-SPEED AUTOMATIC TRANSMISSION

Selector Shaft Seal/Man. Shaft

2008 (5L40E)
Seal 8792S

6- SPEED AUTOMATIC TRANSMISSION

Rear Seal/Ext. Housing

2008 (6L80)
Seal 710533

6-SPEED AUTOMATIC TRANSMISSION

Selector Shaft Seal/Man. Shaft

2008 (6L80)
Seal 8792S

CRANKSHAFT FRONT SEAL

8 Cylinder

2009-2008 364/6.0L
Seal Viton 100470
Repair Sleeve KWK99210

CRANKSHAFT REAR SEAL

8 Cylinder

2009-2008 6.0L
Seal 100085

PONTIAC - REAR DRIVE - Grand Am, Grand Prix, GTO

3-SPEED AUTOMATIC TRANSMISSION

Selector Shaft Seal/Man. Shaft

1993-1990
Seal 8792S

4-SPEED AUTOMATIC TRANSMISSION

Torque Converter

1993-1990
Seal 4072N

Selector Shaft Seal/Man. Shaft

2005-1990
Seal 8792S[2]

PONTIAC - REAR DRIVE - GTO (04 +)

FRONT WHEEL

RWD

2006-2004
Hub Unit Bearing (LH) HA590007²⁵
Hub Unit Bearing (RH) HA590006²⁵

REAR WHEEL

RWD

2006-2004
Bearing Only 511035[2]²⁵

²⁵New Item, Check For Availability

Mfg./Year	Model & Location	Part No.	Mfg./Year	Model & Location	Part No.
PONTIAC - REAR DRIVE - GTO (04+) (cont.)					

4-SPEED AUTOMATIC TRANSMISSION**Torque Converter**

2006-2004 (4L60, 4L60E, 4L65E)	
Seal	3227
Repair Sleeve	KWK99174

Rear Seal/Ext. Housing

2006-2004 (4L60, 4L60E, 4L65E)	
Seal	9613S
Seal Kit	5200 ⁶⁴
Repair Sleeve	KWK99149

Selector Shaft Seal/Man. Shaft

2006-2004 (4L60, 4L60E, 4L65E)	
Seal	8792S
Repair Sleeve	KWK99050

6-SPEED MANUAL TRANSMISSION**Front Input Shaft**

2006-2004 (Tremec T56)	
Seal	7412S

CRANKSHAFT FRONT SEAL**8 Cylinder**

2006-2005 6.0L	
Seal Viton	100470
Repair Sleeve	KWK99210
2004 5.7L	
Seal Viton	100470
Repair Sleeve	KWK99210

CRANKSHAFT REAR SEAL**8 Cylinder**

2006-2004 5.7L, 6.0L	
Seal	100085

PONTIAC - REAR DRIVE - Firebird**FRONT WHEEL****RWD**

2002-1993	
Hub Unit Bearing	513090[2]
1992-1990	
Seal (Inner)	8871[2]
Set (Inner)	SET6[2]
Set (Outer) (Exc. Performance Pkg, Trans Am, GTA)	SET34[2]
Set (Outer) (Performance Pkg, Trans Am, GTA)	SET3[2]

REAR WHEEL**RWD**

2002-1992	
Seal	8660S[2]
Cylindrical Bearing	5707[2]
Bearing & Seal Kit	TRP1563TAV[2] ⁹³ ₁₉
1991-1990 (7.75" R.G.)	
Set	SET9[2]
Seal (RH)	710179[2]
Seal (LH)	224255[2]

REAR WHEEL (cont.)**RWD (cont.)**

1991-1990 (Exc. 7.75" R.G.)	
Seal	8660S[2]
Cylindrical Bearing	5707[2]
Bearing & Seal Kit	TRP1563TAV[2] ⁹³ ₁₉

REAR AXLE**Differential Rebuild Kit**

2002-2001 (7.625" R.G.)(2nd Design)(1.687" Seal I.D.)	
Kit	DRK320C
2001-1999 (7.625" R.G.)(1st Design)(1.5" Seal I.D.)	
Kit	DRK320
1998-1990 (7.5" R.G.)	
Kit	DRK320

¹⁹Opt. Axle Rpr Brg. Replaces O.E. Brg & Seal⁶⁴Seal & Bushing Kit⁹³Non-Traction Control.

Mfg./Year Model & Location Part No. Mfg./Year Model & Location Part No.

PONTIAC - REAR DRIVE - Firebird (cont.)

REAR AXLE

Differential

2002-1990 (7.5", 7.625", 8.5" R.G.)(B, C, G, K, O Axle)
 Cone/Cup LM501349-LM501314[2]
 1991-1990 (7.75" R.G.)
 Set SET47[2]

Pinion

2002-1990 (7.5" R.G., 7.625" R.G.)
 Seal 8610
 Cone/Cup (Inner) HM89249-HM89210
 Cone/Cup (Outer) M86649-M86610
 1991-1990 (7.75" R.G.)
 Seal 7457N
 Cone/Cup (Inner) HM89446-HM89410
 Cone/Cup (Outer) M86649-M86610

4-SPEED AUTOMATIC TRANSMISSION

Torque Converter

2002-1994
 Seal 3227
 Repair Sleeve KWK99174
 1993-1990
 Seal 3227
 Repair Sleeve KWK99174

Rear Seal/Ext. Housing

2002-1990
 Seal 9613S
 Repair Sleeve KWK99149
 Seal Kit 5200⁶⁴

Selector Shaft Seal/Man. Shaft

2002-1990
 Seal 8792S

CLUTCH

Pilot Bearing

1999-1994 (8 Cyl.)
 Ball Bearing 57080
 1996-1990 (6 Cyl.)
 Bushing H/D PB652HD
 1993-1990 (8 Cyl.)
 Bushing H/D PB656HD

CLUTCH - 6 CYLINDER

Release Bearing

2002-1996 231/3.8L
 Bearing Assy 614174
 1995-1990 173/2.8L, 189/3.1L, 231/3.8L, 207/3.4L
 Bearing Assy 614083

CLUTCH - 8 CYLINDER

Release Bearing

2002-1998 346/5.7L (GEN II)
 Bearing Assy 614174

CLUTCH - 8 CYLINDER (cont.)

Release Bearing (cont.)

1997-1993 350/5.7L
 Bearing Assy 614116
 1992-1990 305/5.0L
 Bearing Assy 614083

5-SPEED MANUAL TRANSMISSION

Front Input Shaft

2001-1990
 Seal 7412S[2]
 Set SET5[2]
 Repair Sleeve KWK99125
 Ndle Bearing FA55505[2]

Countershaft

2000-1990
 Cone/Cup (Frt) LM67048-LM67010BCE[2]
 Set (Rr) SET6[2]
 Ndle Bearing Thrust NTA1423[2]

Rear Output Shaft

1996-1990
 Seal 9613S[2]
 Cone/Cup 25877-25821[2]
 Seal Kit 5200⁶⁴

6-SPEED MANUAL TRANSMISSION

Front Input Shaft

2001-1993
 Seal 7412S
 Repair Sleeve KWK99125

Rear Output Shaft

2001-1993
 Seal 9613S
 Seal Kit 5200⁶⁴

ALTERNATOR

2001-1992 (Delco 140 Amp.)
 Ball Bearing (Rear End) 100CCAB
 1990 (Delco)
 Ball Bearing (Drive End) 203FF

CRANKSHAFT FRONT SEAL

6 Cylinder

2002-1990 231/3.8L
 Seal Viton 710162
 Repair Sleeve KWK99193
 1995-1993 201/3.4L
 Seal 9845
 Repair Sleeve KWK99176
 1995-1990 173/2.8L, 189/3.1L, 207/3.4L
 Seal 9845
 Repair Sleeve KWK99176
 Harmnc Balancer Slvs 88176

⁶⁴Seal & Bushing Kit

Mfg./Year Model & Location Part No. Mfg./Year Model & Location Part No.

PONTIAC - REAR DRIVE - Firebird (cont.)

CRANKSHAFT FRONT SEAL

8 Cylinder

2002-1998 346/5.7L (GEN III)	
Seal Viton	100470
Repair Sleeve	KWK99210
1997-1990 305/5.0L, 350/5.7L	
Seal	9845
Repair Sleeve	KWK99176
Harmnc Balancer Slvs	88176

CRANKSHAFT REAR SEAL

6 Cylinder

2002-1995 3.8L	
Seal Viton	320691
Repair Sleeve	KWK99328
1995-1990 3.1L, 3.4L	
Seal	4307V
1995-1990 173/2.8L (2nd Design)	
Seal	4307V
Repair Sleeve	KWK99298
Seal PTFE H/D	5273

CRANKSHAFT REAR SEAL

8 Cylinder

2002-1998 346/5.7L (GEN III)	
Seal	100085
1997-1990 305/5.0L, 350/5.7L	
Seal Viton	4359V
Repair Sleeve	KWK99364
Seal PTFE H/D	5274

PONTIAC - REAR DRIVE - Solstice

FRONT WHEEL

RWD

2008-2007 (Non-ABS)	
Hub Unit Bearing	HA590185[2] ²⁵
2008-2006 (ABS)	
Hub Unit Bearing	HA590186[2] ²⁵

REAR WHEEL

RWD

2008-2007 (Non-ABS)	
Hub Unit Bearing	HA590185[2] ²⁵
2008-2006 (ABS)	
Hub Unit Bearing	HA590186[2] ²⁵

5-SPEED AUTOMATIC TRANSMISSION

Selector Shaft Seal/Man. Shaft

2008-2006 (5L40E)	
Seal	8792S

CRANKSHAFT REAR SEAL

4 Cylinder

2009-2006	
Seal Viton	710237

PONTIAC - Import- FRONT DRIVE - Firefly (Canada), Optima

FRONT WHEEL

FWD

1994-1990 Firefly	
Seal (Inner)	710394[2]
Ball Bearing (Inner)	510001[2]
Seal (Outer)	710175[2]

REAR WHEEL

FWD

1991-1990 Firefly	
Ball Bearing (Inner)	205F[2]
Ball Bearing (Outer)	204F[2]

²⁵New Item, Check For Availability

Mfg./Year	Model & Location	Part No.	Mfg./Year	Model & Location	Part No.
PONTIAC - Import- FRONT DRIVE - Firefly (Canada), Optima (cont.)					

CLUTCH

Release Bearing

1991-1990	Firefly (Canada)	
	Bearing Assy	614082
1991-1990	Optima (5 Spd.)	
	Bearing Assy	614171

ALTERNATOR

1997-1990	(Nippondenso)	
	Ball Bearing (Drive End)	302CC
	Ball Bearing (Rear End)	201CC
1991-1990	(Bosch)	
	Ball Bearing (Drive End)	203FF
	Ball Bearing (Rear End)	201CC

CAMSHAFT SEAL

3 Cylinder

2000-1990	993cc/1.0L	
	Seal	710310
	Repair Sleeve	KWK99128

4 Cylinder

2000-1992	1324cc/1.3L	
	Seal	710310
	Repair Sleeve	KWK99128
1991-1990	1598cc/1.6	
	Seal Viton	1108
	Repair Sleeve	KWK99139
1990	1998cc/2.0L	
	Seal Viton	1108
	Repair Sleeve	KWK99139

CRANKSHAFT FRONT SEAL

3 Cylinder

2000-1990	993cc/1.0L	
	Seal	710310

4 Cylinder

2000-1992	1324cc/1.3L	
	Seal	710310
	Repair Sleeve	KWK99128
1991-1990	1598cc/1.6	
	Seal	710399
	Repair Sleeve	KWK99166

CRANKSHAFT FRONT SEAL (cont.)

4 Cylinder (cont.)

1990	1998cc/2.0L	
	Seal Viton	710164
	Repair Sleeve	KWK99128

CRANKSHAFT REAR SEAL

3 Cylinder

2000-1990	993cc/1.0L	
	Seal	710334

4 Cylinder

2000-1992	1324cc/1.3L	
	Seal	710334
1991-1990	1598cc/1.6	
	Seal Viton	228008
	Repair Sleeve	KWK99315
1990	1998cc/2.0L	
	Seal Viton	710237
	Repair Sleeve	KWK99354

PONTIAC - Import- FRONT DRIVE - LeMans

FRONT WHEEL

FWD

1993-1991		
	Set	SET35[2]
1990	1.6 L	
	Ball Bearing	513113[2]
1990	2.0L	
	Set	SET35[2]

REAR WHEEL

FWD

1993-1990		
	Seal (Inner)	4175[2]
	Set (Inner)	SET8[2]
	Set (Outer)	SET1[2]

Mfg./Year Model & Location Part No. Mfg./Year Model & Location Part No.

PONTIAC - Import- FRONT DRIVE - LeMans (cont.)**CLUTCH****Release Bearing**

1993-1990 (4 Spd.)	
Bearing Assy	614172
1993-1990 (5 Spd.)	
Bearing Assy	614171

3-SPEED AUTOMATIC TRANSAXLE**Torque Converter**

1993-1990	
Seal	4072N

Output Shaft

1993-1990	
Seal	3543[2]
Repair Sleeve	KWK99139[2]

Manual Shaft

1993-1990	
Seal	8792S

4-SPEED MANUAL TRANSAXLE**Output Shaft**

1993-1990	
Seal	3543[2]
Repair Sleeve	KWK99139[2]

5-SPEED MANUAL TRANSAXLE**Output Shaft**

1993-1990	
Seal	3543[2]
Repair Sleeve	KWK99139[2]

ALTERNATOR

1997-1990 (Nippondenso)	
Ball Bearing (Drive End)	302CC
Ball Bearing (Rear End)	201CC
1991-1990 (Bosch)	
Ball Bearing (Drive End)	203FF
Ball Bearing (Rear End)	201CC

CAMSHAFT SEAL**4 Cylinder**

1993-1990	
Seal Viton	1108
Repair Sleeve	KWK99139

CRANKSHAFT FRONT SEAL**4 Cylinder**

1993-1990 1598cc/1.6	
Seal	710399
Repair Sleeve	KWK99166
1990 1998cc/2.0L	
Seal Viton	710164
Repair Sleeve	KWK99128

CRANKSHAFT REAR SEAL**4 Cylinder**

1993-1990 1598cc/1.6	
Seal Viton	228008
Repair Sleeve	KWK99315
1990 1998cc/2.0L	
Seal Viton	710237
Repair Sleeve	KWK99354

PONTIAC TRUCK - SUV - Aztek**FRONT WHEEL****FWD**

2005-2003 (Non-ABS)	
Hub Unit Bearing	HA590048[2] ⁸³
Hub Unit Bearing	HA590085[2] ⁸⁴
2005-2001 (ABS)	
Hub Unit Bearing	513187[2]

AWD

2005-2003 (Non-ABS)	
Hub Unit Bearing	HA590048[2] ⁸³
Hub Unit Bearing	HA590085[2] ⁸⁴
2005-2001 (ABS)	
Hub Unit Bearing	513187[2]

⁸³Deplete Inventory⁸⁴Reorder

Mfg./Year	Model & Location	Part No.	Mfg./Year	Model & Location	Part No.
-----------	------------------	----------	-----------	------------------	----------

PONTIAC TRUCK - SUV - Aztek (cont.)

**REAR WHEEL
FWD**

2005-2003 (Non-ABS)	
Hub Unit Bearing	512221[2]
2005-2001 (ABS)	
Hub Unit Bearing	512237[2] ⁸⁴

AWD

2005-2001	
Hub Unit Bearing	513121[2] ⁷²

**4-SPEED AUTOMATIC TRANSAXLE
Torque Convertor / Frt Pump**

2005-2001 (4T65 E)	
Seal	4072N
Repair Sleeve	KWK99172

Output Shaft

2005-2001 (4T65 E)	
Seal (LH) (Yellow)	100165
Repair Sleeve	KWK99139
Seal (RH) (Green)	3543
Repair Sleeve	KWK99139

Manual Shaft

2005-2001 (4T65 E)	
Seal	8792S

POWER STEERING

Pump Shaft

2003-2001	
Seal	7013S

**CRANKSHAFT FRONT SEAL
6 Cylinder**

2005-2001 207/3.4L	
Seal	9845
Repair Sleeve	KWK99176
Harmnc Balancer Slvs	88176

**CRANKSHAFT REAR SEAL
6 Cylinder**

2005-2001 207/3.4L	
Seal	4307V
Seal PTFE H/D	5273
Repair Sleeve	KWK99298

PONTIAC TRUCK - SUV - Torrent

**FRONT WHEEL
FWD**

2009-2007	
Hub Unit Bearing	HA590262[2] ²⁵
2006 (ABS)	
Hub Unit Bearing	513189[2]
2006 (Non-ABS)	
Hub Unit Bearing	513190[2]

AWD

2009-2007	
Hub Unit Bearing	HA590262[2] ²⁵
2006 (ABS)	
Hub Unit Bearing	513189[2]
2006 (Non-ABS)	
Hub Unit Bearing	513190[2]

**REAR WHEEL
FWD**

2007-2006 (ABS)	
Hub Unit Bearing	512229[2]
2007-2006 (Non-ABS)	
Hub Unit Bearing	512230[2]

AWD

2009-2007	
Hub Unit Bearing	HA590264[2] ²⁵
2006	
Hub Unit Bearing	512229[2]

**5-SPEED AUTOMATIC TRANSMISSION
Selector Shaft Seal/Man. Shaft**

2007-2006 (Aisin AF33-5)	
Seal	221207
Repair Sleeve	KWK99049

²⁵New Item, Check For Availability

⁷²Steel Wire Clip. Brg Flg Mtg Holes Threaded.

⁸⁴Reorder

Mfg./Year	Model & Location	Part No.	Mfg./Year	Model & Location	Part No.
PONTIAC TRUCK - SUV - Torrent (cont.)					

5-SPEED AUTOMATIC TRANSAXLE**Output Shaft**

2007-2006 (Aisin AF33-5)	
Seal	4764[2]

CRANKSHAFT FRONT SEAL**6 Cylinder**

2008-2006 207/3.4L	
Seal	9845
Repair Sleeve	KWK99176
Harmnc Balancer Slvs	88176

CRANKSHAFT REAR SEAL**6 Cylinder**

2009-2006 3.4L	
Seal	4307V
Seal PTFE H/D	5273
Repair Sleeve	KWK99298

PONTIAC - Minivan - Montana, Trans Sport**FRONT WHEEL****FWD**

2005-2003 (Non-ABS)	
Hub Unit Bearing	513160[2] ⁸³
Hub Unit Bearing	HA590085[2] ⁸⁴
2005-2001 (2nd Design)(ABS)	
Hub Unit Bearing	513179[2] ⁷³
2001-1997 (1st Design)(ABS)	
Hub Unit Bearing	513121[2] ⁷²
1996-1992	
Hub Unit Bearing	513087[2] ⁴⁵
1991-1990	
Hub Unit Bearing	513016K[2] ⁶¹
Seal Kit	5698[2] ¹²

AWD

2005-2002 (2nd Design)(ABS)	
Hub Unit Bearing	513179[2] ⁷³

REAR WHEEL**FWD**

2005 (Drum ~ Rear Wheel)	
Hub Unit Bearing	512150[2] ⁸³
Hub Unit Bearing	512237[2] ⁸⁴
2004-1997 (Drum ~ Rear Wheel)	
Hub Unit Bearing	512078[2]
2003-1997 (Disc ~ Rear Wheel)	
Hub Unit Bearing	512150[2] ⁸³
Hub Unit Bearing	512237[2] ⁸⁴
1996-1992 (Drum Brks.)(Auto Level)	
Hub Unit Bearing	512078[2]
1991-1990	
Hub Unit Bearing	513018[2]

REAR WHEEL**AWD**

2005-2002	
Hub Unit Bearing	513121[2] ⁷²

3-SPEED AUTOMATIC TRANSAXLE**Torque Converter**

1995-1990	
Seal	4072N

Output Shaft

1995-1990	
Seal	3543[2]
Repair Sleeve	KWK99139[2]

Manual Shaft

1995-1990	
Seal	8792S

4-SPEED AUTOMATIC TRANSAXLE**Torque Converter / Frt Pump**

2007-1992 (4T65 E)	
Seal	4072N
Repair Sleeve	KWK99172

Output Shaft

2005-1999 (4T65 E)	
Seal (LH) (Yellow)	100165
Repair Sleeve (LH)	KWK99139
Seal (RH) (Green)	3543
Repair Sleeve (RH)	KWK99139
1998-1992 (4T40E, 4T60E)	
Seal (LH)	710096
Seal (RH)	3543
Repair Sleeve	KWK99139[2]

¹²Opt = Seal & O-Ring. Incl w/ Hub Unit. ⁴⁵Brg Flg Mtg Holes Non-Threaded. ⁶¹Kit = Seal, Hub Nut, & Brg Unit
⁷²Steel Wire Clip. Brg Flg Mtg Holes Threaded. ⁷³Plastic Wire Clip.
⁸³Deplete Inventory ⁸⁴Reorder

Mfg./Year Model & Location Part No. Mfg./Year Model & Location Part No.

PONTIAC - Minivan - Montana, Trans Sport (cont.)

4-SPEED AUTOMATIC TRANSAXLE

Manual Shaft

2006-1992 (4T65 E)
Seal8792S

ALTERNATOR

1999-1992 (Delco)
Ball Bearing (Rear End) 100CCAB
1991-1990 (Delco)
Ball Bearing (Drive End) 203FF

CRANKSHAFT FRONT SEAL

6 Cylinder

2006-2005 213/3.5L (OHV), 237/3.9L
Seal9845
Repair SleeveKWK99176
Harmnc Balancer Slvs 88176
2005-1990 189/3.1L, 207/3.4L
Seal9845
Repair SleeveKWK99176
Harmnc Balancer Slvs 88176
1995-1992 231/3.8L
Seal Viton 710162
Repair SleeveKWK99193

CRANKSHAFT REAR SEAL

6 Cylinder

2005-1990 189/3.1L, 207/3.4L
Seal4307V
Seal PTFE H/D 5273
Repair SleeveKWK99298
1995-1992 231/3.8L
Seal Viton 320691
Repair SleeveKWK99328

PONTIAC - Minivan - Montana SV6

FRONT WHEEL

FWD

2006
Hub Unit BearingHA590157[2]²⁵
2005
Hub Unit BearingHA590093[2]⁴⁰

AWD

2006
Hub Unit BearingHA590157[2]²⁵
2005
Hub Unit BearingHA590093[2]⁴⁰

REAR WHEEL

FWD

2006-2005 (Exc. Indep. Rr. Susp.)(Rectangular Flange)
Hub Unit BearingHA590092[2]
2006-2005 (Indep. Rr. Susp.)(Triangular Flange)
Hub Unit BearingHA590091[2]

AWD

2006
Hub Unit BearingHA590157[2]²⁵
2005
Hub Unit BearingHA590093[2]⁴⁰

4-SPEED AUTOMATIC TRANSAXLE

Torque Converter / Frt Pump

2006-2005 (4T65 E)
Seal4072N

Output Shaft

2007-2005 (4T65 E)
Seal (LH) (Yellow)100165
Repair Sleeve (LH) KWK99139
Seal (RH) (Green) 3543
Repair Sleeve (RH)KWK99139

Manual Shaft

2006-2005 (4T65 E)
Seal8792S

CRANKSHAFT FRONT SEAL

6 Cylinder

2006 3.9L
Seal9845
Repair SleeveKWK99176
Harmnc Balancer Slvs 88176
2006-2005 3.5L
Seal9845
Repair SleeveKWK99176
Harmnc Balancer Slvs 88176

²⁵New Item, Check For Availability

⁴⁰5 Stud.

Mfg./Year	Model & Location	Part No.	Mfg./Year	Model & Location	Part No.
-----------	------------------	----------	-----------	------------------	----------

PONTIAC - Minivan - Montana SV6 (cont.)**CRANKSHAFT REAR SEAL****6 Cylinder**

2006-2005	3.5L	
Seal	4307V
Seal PTFE H/D	5273
Repair Sleeve	KWK99298
2006-2005	3.9L	
Seal	4307V
Seal PTFE H/D	5273
Repair Sleeve	KWK99298

PORSCHE - ALL**FRONT WHEEL****RWD**

2009-2002	911	
Ball Bearing	WB000017[2] ²⁵
2008-2006	Cayman	
Ball Bearing	WB000017[2] ²⁵
2008-2005	Boxster	
Ball Bearing	WB000017[2] ²⁵
2004-1997	Boxster	
Ball Bearing	513106[2]
1995-1992	968	
Seal (Inner)	1012N[2]
Set (Inner)	SET17[2]
Set (Outer)	SET3[2]
1995-1990	928 (From Ch. # 861000)	
Seal (Inner)	1012N[2]
Set (Inner)	SET17[2]
Set (Outer)	SET3[2]
1991-1990	944	
Seal (Inner)	1012N[2]
Set (Inner)	SET17[2]
Set (Outer)	SET3[2]

AWD

2009-2005	911	
Ball Bearing	WB000017[2] ²⁵
2005-1999	911	
Ball Bearing	513106[2]

REAR WHEEL**RWD**

2009-2005	911	
Ball Bearing	WB000018[2] ²⁵
2008-2006	Cayman	
Ball Bearing	WB000017[2] ²⁵
2008-2005	Boxster	
Ball Bearing	WB000017[2] ²⁵
2004-2001	Boxster S	
Ball Bearing	513180[2]
2004-1997	Boxster	
Ball Bearing	513106[2]
2004-1990	911	
Ball Bearing	513180[2]
1994-1991	968	
Ball Bearing	513180[2]
1991-1990	944 Ser.	
Ball Bearing	513180[2]

AWD

2009-2005	911	
Ball Bearing	WB000018[2] ²⁵
2004-1990	911	
Ball Bearing	513180[2]

FRONT AXLE**Differential**

2000-1990	911 Carrera 4	
Cone/Cup (LH)	XAC32010X-Y32010X
Bearing Assy (RH)	30210M

Pinion

2000-1990	911 Carrera 4	
Cone/Cup (Inner)	HM89449-HM89410
Cone/Cup (Outer)	M88048-M88010

REAR AXLE**Differential**

1993-1992	968 (A/T)	
Cone/Cup (LH)	LM806649-LM806610
Cone/Cup (RH)	LM300849-LM300811
1993-1992	968 (M/T)	
Cone/Cup (LH)	LM501344-LM501310
Cone/Cup (RH)	LM300849-LM300811
1993-1990	911 C2 Coupe, C4 Coupe	
Bearing Assy (LH)	30210M
1993-1990	911 Ser.	
Cone/Cup	XAA32010XM-Y32010XM[2]
1993-1990	928	
Cone/Cup	XAA32010XM-Y32010XM[2]
1991-1990	944	
Set (LH)	SET45
Cone/Cup (RH)	LM300849-LM300811
1990	924 (5 Spd. Man.)	
Set (LH)	SET45
Cone/Cup (RH)	LM300849-LM300811
1990	924 (A/T)	
Cone/Cup (LH)	LM300849-LM300811

CLUTCH**Release Bearing**

1994-1992	968	
Bearing Assy	614132 ³⁰

²⁵New Item, Check For Availability³⁰Ball Brg Replaces Carbon Brg.

Mfg./Year Model & Location Part No. Mfg./Year Model & Location Part No.

PORSCHE - ALL (cont.)

CLUTCH (cont.)

Release Bearing (cont.)

1994-1990	911 6 Cyl.	
Bearing Assy	614137 ³⁰
1991-1990	944	
Bearing Assy	614132 ³⁰

3-SPEED AUTOMATIC TRANSAXLE

Differential

1991-1990		
Cone/Cup	LM300849-LM300811[2]

Torque Converter

1991-1990		
Seal	3083
Repair Sleeve	KWK99169

Output Shaft

1991-1990		
Seal	224520[2]
Repair Sleeve	KWK99177

Pinion

1991-1990		
Seal (Frt)	222820
Cone/Cup (Frt)	M88048-M88010
Repair Sleeve (Frt)	KWK99111
Seal (Rr)	1012N
Cone/Cup (Rr)	M86649-M86610
Repair Sleeve (Rr)	KWK99177

5-SPEED AUTOMATIC TRANSAXLE

Output Shaft

2008-1996	(ZF5HP19HLA)	
Seal	223510[2]
Repair Sleeve	KWK99139[2]

5-SPEED MANUAL TRANSAXLE

Differential

1997-1990	(Getrag G28, G50, G64)	
Bearing Assy	32010X[2]

Input Shaft

1995-1990	(VW 016)	
Seal	222540
Repair Sleeve	KWK99098

Output Shaft

1997-1990	(Getrag G50, G64)	
Seal	224560[2]
Repair Sleeve	KWK99177
1995-1990	(VW 016)	
Seal	224520[2]
Repair Sleeve	KWK99177
1991-1990	(Getrag G28)	
Seal	224820[2]
Repair Sleeve	KWK99189

CAMSHAFT SEAL

4 Cylinder

1995-1990	2474cc/2.5L, 2980cc/3.0L	
Seal	223020
Repair Sleeve	KWK99114

8 Cylinder

1995-1990	4957cc/5.0L, 5397cc/5.4L	
Seal	223020
Repair Sleeve	KWK99114

CRANKSHAFT FRONT SEAL

6 Cylinder

2008-2000	2687cc/2.7L (DOHC), 3387cc/2.7L (DOHC)	
Seal Viton	710196
Repair Sleeve	KWK99157
1999-1997	2480cc/2.5L	
Seal Viton	710196
Repair Sleeve	KWK99157
1993-1990	3164cc/3.2L, 3299cc/3.3L	
Seal	226020
Repair Sleeve	KWK99235

8 Cylinder

1995-1990	4474cc/4.5L, 4670cc/4.7L, 4957cc/5.0L, 5397cc/5.4L	
Seal	60X85X8
Repair Sleeve	KWK99235

CRANKSHAFT REAR SEAL

4 Cylinder

1995-1990	2474cc/2.5L, 2980cc/3.0L	
Seal	229010
Repair Sleeve	KWK99354

6 Cylinder

2002-2001	3608cc/3.6L	
Seal	229010
Repair Sleeve	KWK99354
1999-1997	2480cc/2.5L	
Seal	716102
Repair Sleeve	KWK99333
1998-1990	2994cc/3.0L, 3164cc/3.2L, 3299cc/3.3L, 3608cc/3.6L	
Seal	229010
Repair Sleeve	KWK99354

8 Cylinder

1995-1990	4474cc/4.5L, 4670cc/4.7L, 4957cc/5.0L, 5397cc/5.4L	
Seal	229010
Repair Sleeve	KWK99354

³⁰Ball Brg Replaces Carbon Brg.

Mfg./Year	Model & Location	Part No.	Mfg./Year	Model & Location	Part No.
-----------	------------------	----------	-----------	------------------	----------

PORSCHE - SUV - Cayenne**FRONT WHEEL****AWD**

2009-2003

Ball Bearing 510082[2]²⁵**REAR WHEEL****AWD**

2009-2003

Ball Bearing 510082[2]²⁵**ROLLS ROYCE - ALL (includes BENTLEY chassis)****FRONT WHEEL****RWD**

1992-1990 Silver Spur

Cone/Cup (Inner) LM29749-LM29710[2]

Set (Outer) SET4[2]

1992-1990 Silver Spirit

Cone/Cup (Inner) LM29749-LM29710[2]

Set (Outer) SET4[2]

1992-1990 Corniche

Cone/Cup (Inner) LM29749-LM29710[2]

Set (Outer) SET4[2]

REAR WHEEL**RWD**

1992-1990 Corniche I, II, III

Cone/Cup (Inner) 18790-18720[2]

Cone/Cup (Outer) 18690-18620[2]

1990 Silver Spur I, II

Cone/Cup (Inner) 18790-18720[2]

Cone/Cup (Outer) 18690-18620[2]

1990 Silver Spirit I, II

Cone/Cup (Inner) 18790-18720[2]

Cone/Cup (Outer) 18690-18620[2]

REAR AXLE**Differential**

1992-1990

Cone/Cup (LH) 29590-29520

Cone/Cup (RH) 368A-362A

Pinion

1990 Corniche

Cone/Cup (Inner) 18790-18720

Cone/Cup (Outer) 18690-18620

1990 Silver Spur

Cone/Cup (Inner) 18790-18720

Cone/Cup (Outer) 18690-18620

1990 Silver Spirit

Cone/Cup (Inner) 18790-18720

Cone/Cup (Outer) 18690-18620

3-SPEED AUTOMATIC TRANSMISSION**Torque Converter**

1990 (THM400)

Seal 6712NA

Repair Sleeve KWK99187

Rear Seal/Ext. Housing

1990 (THM400)

Seal 9449

Seal Kit 5208⁶⁴**Selector Shaft Seal/Man. Shaft**

1990 (THM400)

Seal 8792S

4-SPEED AUTOMATIC TRANSMISSION**Torque Converter**

1992-1991 (4L80E)

Seal 4598

Repair Sleeve KWK99199

Rear Seal/Ext. Housing

1992-1991 (4L80E)

Seal 9449

Seal Kit 5208⁶⁴**Selector Shaft Seal/Man. Shaft**

1992-1991 (4L80E)

Seal 8792S

²⁵New Item, Check For Availability⁶⁴Seal & Bushing Kit

Mfg./Year Model & Location Part No. Mfg./Year Model & Location Part No.

ROVER - SUV - Defender 90, Defender 110, Discovery, LR2, LR3, Range Rover

FRONT WHEEL

4WD

2008-2006	Range Rover Sport	
	Hub Unit Bearing	HA500601[2]
2008-2005	LR3 (T5 Platform)	
	Hub Unit Bearing	HA500601[2]
2008-2003	Range Rover	
	Ball Bearing	510082[2] ²⁵
2002-1999	Range Rover	
	Cone	NP275832-9FUA1[2] ²⁵
1998-1994	Discovery	
	Set	SET37[4]
1998-1990	Range Rover	
	Set	SET37[2]
1997-1993	Defender 90, 110	
	Set	SET37[2]

AWD

2005-2002	Freelander	
	Ball Bearing	510087[2] ²⁵

REAR WHEEL

4WD

2008-2006	Range Rover Sport	
	Taprd Bearing Assy	WB000036[2]
2008-2005	LR3 (T5 Platform)	
	Taprd Bearing Assy	WB000036[2]
2008-2003	Range Rover	
	Ball Bearing	510082[2] ²⁵
2002-1999	Range Rover	
	Cone	NP275832-9FUA1[2] ²⁵
1998-1994	Discovery	
	Set	SET37[2]
1997-1993	Defender 90, 110	
	Set	SET37[2]
1994-1990	Range Rover	
	Set	SET37[2]

AWD

2008	LR2	
	Ball Bearing	510087[2] ²⁵
2005-2002	Freelander	
	Ball Bearing	510087[2] ²⁵

4WD FRONT AXLE

Differential

1997-1994		
	Set	SET47[2]
1993		
	Set (From Mid Year)	SET47[2]
	Set (To Mid Year)	SET45[2]
1992-1990		
	Set	SET45[2]

4WD FRONT AXLE

Pinion

2002-1990		
	Cone/Cup (Inner)	HM801346X-HM801310
	Cone/Cup (Outer)	M88046-M88010

Steering Knuckle

2002-1990		
	Cone/Cup	11590-11520[2]

REAR AXLE

Differential

1997-1994		
	Set	SET47[2]
1993		
	Set (From Mid Year)	SET47[2]
	Set (To Mid Year)	SET45[2]
1992-1990		
	Set	SET45[2]

Pinion

2002-1990		
	Cone/Cup (Inner)	HM801346X-HM801310
	Cone/Cup (Outer)	M88046-M88010

TRANSFER CASE REBUILD KIT

1996-1990	Range Rover	
	Kit	TCRK1361

4-SPEED AUTOMATIC TRANSMISSION

Torque Converter

2004-1990	(ZF 4HP 22, ZF 4HP 24)	
	Seal	224052
	Repair Sleeve	KWK99157

Rear Seal/Ext. Housing

2004-1990	(ZF 4HP 22, ZF 4HP 24)	
	Seal	710140

5-SPEED AUTOMATIC TRANSMISSION

Torque Converter

2005-2003	(5L40E)	
	Seal	710559

Selector Shaft Seal/Man. Shaft

2005-2003	(5L40E)	
	Seal	8792S

CRANKSHAFT FRONT SEAL

8 Cylinder

2005-2003	(4.4L)(DOHC)	
	Seal Viton	716484
	Repair Sleeve	KWK99189

²⁵New Item, Check For Availability

Mfg./Year Model & Location Part No. Mfg./Year Model & Location Part No.

ROVER - SUV - Defender 90, Defender 110, Discovery, LR2, LR3, Range Rover (cont.)

CRANKSHAFT REAR SEAL

6 Cylinder

2008-2005 (4.0L)
Seal Viton 3393

8 Cylinder

2005-2003 (4.4L)(DOHC)
Seal 231003[2]
Repair Sleeve KWK99393[2]

SAAB - 9-2X, 9-3, 9-5, 9-7X, 900, 9000

FRONT WHEEL

FWD

2008-2003 9-3
Hub Unit Bearing 513191[2]
2008-2002 9-5
Hub Unit Bearing 513192[2]
2003 9-3 (Convertible)
Ball Bearing 510052[2]
2003 9-3 (Sedan)
Hub Unit Bearing 513191[2]
2002 9-3
Ball Bearing 510052[2]
2001-1999 9-5
Ball Bearing 510052[2]
1998-1994 900
Ball Bearing 510052[2]
1998-1990 9000
Hub Unit Bearing 513126[2]
1993-1990 900
Ball Bearing 513106[2]

AWD

2009-2008 9-3
Hub Unit Bearing 513191[2]
2008-2005 9-7X
Hub Unit Bearing 513188[2]
2006-2005 9-2X
Bearing Assy 517008[2]

REAR WHEEL

FWD

2008-2003 9-3
Hub Unit Bearing HA590290[2]²⁵
2008-2000 9-5
Hub Unit Bearing 512232[2]
2002-1999 9-3
Hub Unit Bearing 512145[2]
1999 9-5
Hub Unit Bearing 512145[2]
1998-1994 900
Hub Unit Bearing 512145[2]
1998-1990 9000
Hub Unit Bearing 512146[2]¹⁶
1993-1990 900
Hub Unit Bearing 512146[2]¹⁶

AWD

2009-2008 9-3
Hub Unit Bearing HA590290[2]²⁵
2009-2005 9-7X
Seal 4762N[2]
Cylindrical Bearing 513067[2]
2006-2005 9-2X Aero
Bearing Assy 516003[2]
2006-2005 9-2X Linear
Bearing Assy 513248[2]

FRONT AXLE

Pinion

1993-1990
Seal Viton 483230V
Repair Sleeve KWK99162

4WD FRONT AXLE

Axle Shaft

2008-2005
Seal 710491[2]

REAR AXLE

Differential Rebuild Kit

2008-2005 (8" R.G.)
Kit DRK320D
2007-2005 (8.625" R.G.)
Kit DRK321C

Pinion

2008-2005
Seal (Rear Axle) 710506
2006-2005
Seal 1173
Repair Sleeve KWK99139

4-SPEED AUTOMATIC TRANSMISSION

Torque Converter

2008-2005 (4L60E, 4L70E)
Seal 4950
Repair Sleeve KWK99174

¹⁶Obsolete ²⁵New Item, Check For Availability

Mfg./Year Model & Location Part No. Mfg./Year Model & Location Part No.

SAAB - 9-2X, 9-3, 9-5, 9-7X, 900, 9000 (cont.)

4-SPEED AUTOMATIC TRANSMISSION

Selector Shaft Seal/Man. Shaft

2008-2005 (4L60E, 4L70E)
Seal8792S

CLUTCH

Pilot Bearing

2005 (4 Cyl.)
Ball Bearing201CC
1992-1990 900
Ball Bearing202FF

Release Bearing

2005 (4 Cyl.)
Bearing Assy614159
1990 900, 9000
Bearing Assy614080

4-SPEED AUTOMATIC TRANSAXLE

Differential

2005 (TZ1A2)
Bearing Assy30208M[2]
1997-1990 (ZF 4HP 14, 4HP 18Q)
Cone/Cup (LH)LM806649-LM806610
Cone/Cup (RH)LM300849-LM300811

Torque Converter / Frt Pump

2006-2005 (TZ1A2)
Seal225010
Repair SleeveKWK99196
2002-1994 (Aisin 50 40, 50 42)
Seal223830
Repair SleeveKWK99147
1994-1990 (ZF 4HP 14)
Seal225110
Repair SleeveKWK99187

Output Shaft

2006-2005 (TZ1A2)
Seal223050
Repair SleeveKWK99114
2003-1994 (Aisin 50 40, 50 42)
Seal4764[2]

Oil Pump

2006-2005 (TZ1A2)
Seal710265

Manual Shaft

2002-1994 (Aisin 50 40, 50 42)
Seal221207
Repair SleeveKWK99049

5-SPEED AUTOMATIC TRANSAXLE

Torque Converter

2008 9-3, 9-5
Seal222830
Repair SleeveKWK99147

Output Shaft

2008 9-3, 9-5
Seal4764[2]

Manual Shaft

2008 9-3, 9-5
Seal221207
Repair SleeveKWK99049

5-SPEED MANUAL TRANSAXLE

Differential

1993-1990 9000
Cone/Cup (LH)LM300849-LM300811
Set (RH)SET45
1992-1990 900
Seal223510[2]
SetSET45[2]
Repair SleeveKWK99139

Input Shaft

1993-1990 9000
Set (Frt)SET4[2]
Cone/Cup (Rr)15106-15245[2]
1992-1990 900
Cone/CupM84548-M84510[2]

Output Shaft

1993-1990 9000
Bearing Assy (LH)32008XM[2]
Cone/Cup (RH)15106-15245[2]

Pinion

1992-1990 900
Cone/Cup (Frt)HM88649-HM88610
Cone/Cup (Rr)M88048-M88010

OIL PUMP

4 Cylinder

2006-2005 1995cc/2.0L, 2458cc/2.5L
Seal710236

CAMSHAFT SEAL

6 Cylinder

2002-1994 2498cc/2.0L, 2962cc/3.0L
Seal714436
Repair SleeveKWK99139

Mfg./Year	Model & Location	Part No.	Mfg./Year	Model & Location	Part No.
SAAB - 9-2X, 9-3, 9-5, 9-7X, 900, 9000 (cont.)					

CRANKSHAFT FRONT SEAL**4 Cylinder**

2007-2003	1985cc/2.0L, 2290cc/2.3L
Seal	331227H
Harmnc Balancer Slvs	88187
Repair Sleeve	KWK99187
2002-1990	1985cc/2.0L, 2119cc/2.1L, 2290cc/2.3L
Seal	331227H
Repair Sleeve	KWK99187

8 Cylinder

2008-2005	325/5.3L, 364/6.0L
Seal Viton	100470
Repair Sleeve	KWK99210

CRANKSHAFT REAR SEAL**4 Cylinder**

2007-2004	1985cc/2.0L, 2290cc/2.3L
Seal Viton	710237
Repair Sleeve	KWK99354
2006-2005	1995cc/2.0L, 2458cc/2.5L
Seal Viton	710235
2003-1990	1985cc/2.0L, 2119cc/2.1L, 2290cc/2.3L
Seal	3772

CRANKSHAFT REAR SEAL**6 Cylinder**

2007-1994	2498cc/2.5L, 2792cc/2.8L, 2962cc/3.0L
Seal Viton	710237
Repair Sleeve	KWK99354

8 Cylinder

2008-2005	325/5.3L, 364/6.0L
Seal	100085

SATURN - Astra, Aura, Ion, L Series, S Series**FRONT WHEEL****FWD**

2009-2008	Astra
Hub Unit Bearing	HA590297[2] ²⁵
2009-2007	Aura
Hub Unit Bearing	HA590070[2]
2007-2004	Ion (Red Line)
Hub Unit Bearing	HA590086[2]
2007-2003	Ion (ABS)(Exc. Red Line)
Hub Unit Bearing	HA590068[2]
2007-2003	Ion (Exc. Red Line)(Non-ABS)
Hub Unit Bearing	HA590069[2]
2005-2000	L Ser.
Ball Bearing	510052[2]
2002-1994	S Ser.
Ball Bearing	510024[2]
Hub Unit Bearing	HA590156K[2] ⁶⁷
1993-1991	
Ball Bearing	510024[2]
Hub Unit Bearing	HA590155K[2]

REAR WHEEL**FWD**

2009-2008	Astra
Ball Bearing	510029[2]
2009-2007	Aura
Hub Unit Bearing	HA590081[2]
2007-2004	Ion (Red Line)(Disc)
Hub Unit Bearing	HA590088[2]

REAR WHEEL (cont.)**FWD (cont.)**

2007-2003	Ion (ABS)(Exc. Red Line)(Drum)
Hub Unit Bearing	HA590066[2]
2007-2003	Ion (Exc. Red Line)(Non-ABS)(Drum)
Hub Unit Bearing	HA590067[2]
2005-2000	L Ser. (ABS)
Hub Unit Bearing	512238[2]
2005-2000	L Ser. (Non-ABS)
Hub Unit Bearing	512239[2]
2002-1991	S Ser. (ABS)
Hub Unit Bearing	512002[2]
2002-1991	S Ser. (Non-ABS)
Hub Unit Bearing	512000[2]

CLUTCH**Release Bearing**

1997-1991	
Bearing Assy	614161

4-SPEED AUTOMATIC TRANSAXLE**Differential**

2002-1991	(TAAT)
Seal Viton	714616[2]
Ball Bearing	208[2]

²⁵New Item, Check For Availability⁶⁷Kit = Flg, Brg, Nut, & Snap Ring

Mfg./Year Model & Location Part No. Mfg./Year Model & Location Part No.

SATURN - Astra, Aura, Ion, L Series, S Series (cont.)

4-SPEED AUTOMATIC TRANSAXLE

Torque Converter / Frt Pump

2008-1991 (4T40E, 4T45E)
 Seal4072N
 Repair SleeveKWK99172

Input Shaft

2003-2002
 Ball BearingFC69598[2]

Output Shaft

2007-2000 (4T40E)
 Seal SL260001[2]²⁵
 2002-1991 (TAAT)
 Seal (LH)4613N
 Seal (RH) 4614N

Manual Shaft

2008-2001 (4T40E, 4T45E)
 Seal 8792S
 2002-1995 (TAAT)
 Seal4701N
 1994 (TAAT)(1st Design)
 Seal 718610
 1994 (TAAT)(2nd Design)
 Seal4701N
 1993-1991 (TAAT)
 Seal 718610

5-SPEED AUTOMATIC TRANSAXLE

Differential

1996-1991 (TAMT)
 Ball Bearing 208[2]

5-SPEED MANUAL TRANSAXLE

Transaxle Rebuild Kit

2002-1991 (S Ser.)
 Kit TRKFG120

Differential

2002-1991 (TAMT)
 Ball Bearing 208[2]

Output Shaft

2002-1991 (TAMT)
 Seal (LH)4613N
 Seal (RH) 4614N
 Ndle Bearing (RH)F213118¹⁶

POWER STEERING

Pump Shaft

1999-1991 (Saginaw pump)
 Seal 7013S

CAMSHAFT SEAL

6 Cylinder

2005-2000 2962cc/3.0L
 Seal 714436
 Repair SleeveKWK99139

CRANKSHAFT FRONT SEAL

4 Cylinder

2004 2198cc/2.2L ION
 Seal 9845
 2002-1991 116/1.9L
 Seal Viton 324204

6 Cylinder

2008-2007 213/3.5L
 Seal 9845
 Repair SleeveKWK99176
 2005-2000 2962cc/3.0L
 Seal 223750

CRANKSHAFT REAR SEAL

4 Cylinder

2009-2007 2.4L
 Seal Viton 710237
 2007-2004 2.0L, 2.2L
 Seal Viton 710237
 2006-2000 2.2L (DOHC)
 Seal Viton 710237
 2002-1991 116/1.9L
 Seal Viton 327995
 Seal PTFE H/D 5273
 Repair SleeveKWK99298

6 Cylinder

2008-2007 3.5L
 Seal4307V
 2005-2000 3.0L (DOHC)
 Seal Viton 710237

¹⁶Obsolete ²⁵New Item, Check For Availability

Mfg./Year	Model & Location	Part No.	Mfg./Year	Model & Location	Part No.
-----------	------------------	----------	-----------	------------------	----------

SATURN - Sky**FRONT WHEEL****RWD**

2009-2007

Hub Unit BearingHA590186[2]²⁵**REAR WHEEL****RWD**

2009-2007

Hub Unit BearingHA590186[2]²⁵**5-SPEED AUTOMATIC TRANSMISSION****Selector Shaft Seal/Man. Shaft**

2008-2007 (5L40E)

Seal8792S

CRANKSHAFT REAR SEAL**4 Cylinder**

2009-2007 2.0L

Seal Viton710237

2009-2007 2.4L

Seal Viton710237

SATURN TRUCK - Minivan, SUV - Outlook**FRONT WHEEL****FWD**

2009-2007

Hub Unit BearingHA590227[2]²⁵**AWD**

2009-2007

Hub Unit BearingHA590227[2]²⁵**REAR WHEEL****FWD**

2009-2007

Hub Unit BearingHA590227[2]²⁵**REAR WHEEL****AWD**

2009-2007

Hub Unit BearingHA590227[2]²⁵**SATURN TRUCK - Minivan, SUV - Relay****FRONT WHEEL****FWD**

2007-2006

Hub Unit BearingHA590157[2]²⁵

2005

Hub Unit BearingHA590093[2]⁴⁰**AWD**

2007-2006

Hub Unit BearingHA590157[2]²⁵

2005

Hub Unit BearingHA590093[2]⁴⁰**REAR WHEEL****FWD**

2007-2006

Hub Unit BearingHA590116[2]²⁵

2005

(Exc. Indep. Rr. Susp.)(Rectangular Flange)

Hub Unit BearingHA590092[2]

REAR WHEEL (cont.)**FWD (cont.)**

2005 (Indep. Rr. Susp.)(Triangular Flange)

Hub Unit BearingHA590091[2]

AWD

2006

Hub Unit BearingHA590157[2]²⁵

2005

Hub Unit BearingHA590093[2]⁴⁰**4-SPEED AUTOMATIC TRANSAXLE****Torque Converter / Frt Pump**

2007-2005 (4T65 E)

Seal4072N

Repair SleeveKWK99172

²⁵New Item, Check For Availability⁴⁰5 Stud.

Mfg./Year	Model & Location	Part No.	Mfg./Year	Model & Location	Part No.
-----------	------------------	----------	-----------	------------------	----------

SATURN TRUCK - Minivan, SUV - Relay (cont.)

4-SPEED AUTOMATIC TRANSAXLE

Output Shaft

2008-2005 (4T65 E)	
Seal (LH) (Yellow)	100165
Repair Sleeve (LH)	KWK99139
Seal (RH) (Green)	3543
Repair Sleeve (RH)	KWK99139

Manual Shaft

2006-2005 (4T65 E)	
Seal	8792S

CRANKSHAFT FRONT SEAL

6 Cylinder

2007-2006 3.9L	
Seal	9845
Repair Sleeve	KWK99176
Harmnc Balancer Slvs	88176
2006-2005 3.5L	
Seal	9845
Repair Sleeve	KWK99176
Harmnc Balancer Slvs	88176

CRANKSHAFT REAR SEAL

6 Cylinder

2009-2006 3.9L	
Seal	4307V
Seal PTFE H/D	5273
Repair Sleeve	KWK99298
2006-2005 3.5L	
Seal	4307V
Seal PTFE H/D	5273
Repair Sleeve	KWK99298

SATURN TRUCK - Minivan, SUV - VUE

FRONT WHEEL

FWD

2009-2008	
Hub Unit Bearing	HA590262[2] ²⁵
2007-2002 (ABS)	
Hub Unit Bearing	513189[2]
2007-2002 (Non-ABS)	
Hub Unit Bearing	513190[2]

AWD

2009-2008	
Hub Unit Bearing	HA590262[2] ²⁵
2007-2002 (ABS)	
Hub Unit Bearing	513189[2]
2007-2002 (Non-ABS)	
Hub Unit Bearing	513190[2]

REAR WHEEL

FWD

2009-2008	
Hub Unit Bearing	HA590264[2] ²⁵
2007-2002 (ABS)	
Hub Unit Bearing	512229[2]
2007-2002 (Non-ABS)	
Hub Unit Bearing	512230[2]

AWD

2009-2008	
Hub Unit Bearing	HA590264[2] ²⁵
2007-2002 (ABS)	
Hub Unit Bearing	512229[2]
2007-2002 (Non-ABS)	
Hub Unit Bearing	512230[2]

REAR AXLE

Pinion

2005-2002	
Cone/Cup (Inner)	M88048-M88010
Cone/Cup (Outer)	M86649-M86610

4-SPEED AUTOMATIC TRANSAXLE

Torque Converter / Frt Pump

2006-2002 (AF33)	
Seal	222830
Repair Sleeve	KWK99147

Output Shaft

2007-2002 (AF33)	
Seal	4764[2]

Manual Shaft

2008 (4T45E)	
Seal	8792S

5-SPEED AUTOMATIC TRANSAXLE

Manual Shaft

2007-2002 (AF33)	
Seal	221207

²⁵New Item, Check For Availability

Mfg./Year	Model & Location	Part No.	Mfg./Year	Model & Location	Part No.
-----------	------------------	----------	-----------	------------------	----------

SATURN TRUCK - Minivan, SUV - VUE (cont.)

OIL PUMP

6 Cylinder

2007-2004	3471cc/3.5L	
Seal		711181

CRANKSHAFT FRONT SEAL

6 Cylinder

2003-2002	2962cc/3.0L	
Seal		223750

CRANKSHAFT REAR SEAL

4 Cylinder

2009-2007	2.4L	
Seal Viton		710237
2007-2002	2.2L (DOHC)	
Seal Viton		710237

CRANKSHAFT REAR SEAL

6 Cylinder

2009-2004	3.5L	
Seal Viton		228008
2003-2002	3.0L (DOHC)	
Seal Viton		710237

SCION - xA, xB, tC

FRONT WHEEL

FWD

2009-2005	tC	
Ball Bearing		510070[2]
2009-2004	xA, xB	
Hub Unit Bearing		HA590165[2] ²⁵
Ball Bearing Optional		510062[2]

REAR WHEEL

FWD

2009-2005	tC	
Hub Unit Bearing		HA590040[2] ²⁵
2009-2004	xA, xB	
Hub Unit Bearing		HA594245[2]

5-SPEED MANUAL TRANSMISSION

Selector Shaft Seal/Man. Shaft

2006-2004		
Seal		1015N

4-SPEED AUTOMATIC TRANSAXLE

Output Shaft

2006-2004	(U241E, U340E)	
Seal		223540[2]
Repair Sleeve		KWK99139[2]

OIL PUMP

4 Cylinder

2009-2005	2362cc/2.4L(DOHC)	
Seal		221820
2006-2004	1496cc/1.5L(DOHC)	
Seal		710450
Repair Sleeve		KWK99078

CRANKSHAFT FRONT SEAL

4 Cylinder

2009-2005	2.4L	
Seal Viton		2025
Repair Sleeve		KWK99166
2006-2004	1.5L	
Repair Sleeve		KWK99139

CRANKSHAFT REAR SEAL

4 Cylinder

2009-2005	2.4L	
Seal Viton		710189
2006-2004	1.5L	
Seal		228015

²⁵New Item, Check For Availability

Mfg./Year Model & Location Part No. Mfg./Year Model & Location Part No.

STERLING - Honda automobiles - England

FRONT WHEEL

FWD

1991-1990 825, 827
Ball Bearing513052[2]

REAR WHEEL

FWD

1991-1990 825, 827
Ball Bearing513051[2]

CLUTCH

Release Bearing

1991-1990 827SLi
Bearing Assy614068

4-SPEED AUTOMATIC TRANSAXLE

Differential

1991-1990 (PL5X)
Bearing Assy30208M[2]

Torque Converter / Frt Pump

1991-1990 (G4)
Seal350609

Output Shaft

1991-1990 (G3T4, G4)
Seal Viton224026[2]
Repair SleeveKWK99157

Manual Shaft

1991-1990 (G3T4, G4)
Seal221207
Repair SleeveKWK99049

5-SPEED MANUAL TRANSAXLE

Differential

1991-1990 (G3T4, C3P4)
Cone/Cup (LH)XAA32008X-Y32008X
Bearing Assy (RH)32010X

Output Shaft

1991-1990 (G3T4, C3P4)
Seal Viton224026[2]
Repair SleeveKWK99157

A/C COMPRESSOR

1990 (Nippondenso 10P15)(Axial)
Ball Bearing5000KFF[2]
1990 (Nippondenso 10P17)(Axial)
Ball Bearing5000KFF[2]

ALTERNATOR

1990 (Nippondenso)
Ball Bearing (Drive End)203FF
Ball Bearing (Rear End)201CC

POWER STEERING

Pump Shaft

1991-1990 827 Ser.
Seal221620

OIL PUMP

6 Cylinder

1991-1990 2494cc/2.5L, 2675cc/2.7L
Seal711181

CAMSHAFT SEAL

6 Cylinder

1991-1990 2494cc/2.5L, 2675cc/2.7L
Seal Viton713771
Repair SleeveKWK99139

CRANKSHAFT FRONT SEAL

6 Cylinder

1991-1990 2494cc/2.5L, 2675cc/2.7L
Seal711181

CRANKSHAFT REAR SEAL

6 Cylinder

1991-1990 2494cc/2.5L, 2675cc/2.7L
Seal Viton228008
Repair SleeveKWK99315

SUBARU AWD - Impreza, Justy, Legacy, Loyale, Outback, SVX, XT**FRONT WHEEL****FWD**

2008-2005 Legacy, Outback	
Hub Unit Bearing	HA590118[2] ²⁵
2004-1990 Legacy	
Seal (Inner)	1993[2]
Seal (Outer)	225650[2]
Bearing Assy	517008[2]
1997-1993 Impreza	
Seal (Inner)	225673[2]
Seal (Outer)	710393[2]
Bearing Assy	517008[2]
1997-1992 SVX	
Seal (Inner)	710229[2]
Seal (Outer)	710231[2]
Bearing Assy	517007[2]
1994-1990 Loyale	
Seal (Inner)	710230[2]
Seal (Outer)	225230[2]
Ball Bearing	207[2]
1994-1990 Justy	
Seal (Inner)	1974[2]
Seal (Outer)	224462[2]
Ball Bearing	206WB[2]
1992-1990 XT6	
Seal (Inner)	710230[2]
Seal (Outer)	225230[2]
Bearing Assy	513015[2]
1991-1990 XT Ser. (Exc. XT6)	
Seal (Inner)	710230[2]
Seal (Outer)	225230[2]
Ball Bearing	207[2]

4WD

1993-1990 Loyale	
Seal (Inner)	710230[2]
Seal (Outer)	225230[2]
Ball Bearing	207[2]
1992-1990 XT6	
Seal (Inner)	710230[2]
Seal (Outer)	225230[2]
Bearing Assy	513015[2]
1991-1990 XT Ser. (Exc. XT6)	
Seal (Inner)	710230[2]
Seal (Outer)	225230[2]
Ball Bearing	207[2]

AWD

2009-2008 Impreza (Exc. WXR STI)	
Hub Unit Bearing	HA590315[2] ²⁵
2009-2008 Impreza (WXR STI)	
Hub Unit Bearing	HA590316[2] ²⁵
2008-2005 Legacy, Outback	
Hub Unit Bearing	HA590118[2] ²⁵
2006-1993 Impreza	
Seal (Inner)	1993[2]
Bearing Assy (Inner)	517008[2]
Seal (Outer)	225650[2]
2004-2000 Outback	
Seal (Inner)	1993[2]
Bearing Assy (Inner)	517008[2]
Seal (Outer)	225650[2]

FRONT WHEEL (cont.)**AWD (cont.)**

2004-1990 Legacy	
Seal (Inner)	1993[2]
Bearing Assy (Inner)	517008[2]
Seal (Outer)	225650[2]
1997-1992 SVX	
Seal (Inner)	710229[2]
Bearing Assy (Inner)	517007[2]
Seal (Outer)	710231[2]
1994 Loyale	
Ball Bearing	207[2]
Seal (Outer)	225230[2]
Seal (Inner)	710230[2]

REAR WHEEL**FWD**

1997-1993 Impreza (ABS)	
Hub Unit Bearing	512036[2]
1997-1991 Legacy (ABS)	
Hub Unit Bearing	512036[2]
1996-1993 Impreza (Non-ABS)	
Hub Unit Bearing	512036[2]
1996-1990 Legacy (Non-ABS)	
Hub Unit Bearing	512036[2]
1995-1990 Justy	
Seal (Inner)	223830[2]
Bearing Assy (Inner)	30205M[2]
Bearing Assy (Outer)	30204M[2]
1993-1990 Loyale	
Seal (Inner)	1984[2]
Bearing Assy (Inner)	30206M[2]
Bearing Assy (Outer)	30204M[2]

4WD

1995-1990 Justy	
Seal (Inner)	710228[2]
Ball Bearing (Inner)	305AG[2]
Seal (Outer)	710227[2]
Ball Bearing (Outer)	206WB[2]
1993-1990 Loyale	
Seal (Inner)	224015[2]
Bearing Assy (Inner)	513056[2]
Seal (Outer)	225005[2]
1991-1990 XT	
Seal (Inner)	224015[2]
Bearing Assy (Inner)	513056[2]
Seal (Outer)	225005[2]

AWD

2009-2008 Impreza (Exc. WXR STI)	
Hub Unit Bearing	HA590313[2] ²⁵
2009-2008 Impreza (WXR STI)	
Hub Unit Bearing	HA590314[2] ²⁵
2009-2005 Legacy, Outback	
Hub Unit Bearing	HA590119[2] ²⁵
2007-2004 Impreza (Exc. WXR STI)	
Bearing Assy	513248[2]
Ball Bearing (Opt)	511023[2]
Seal (Inner)	710226
Seal (Intermediate)	225005
Seal Viton (Outer)	710259

²⁵New Item, Check For Availability

Mfg./Year	Model & Location	Part No.	Mfg./Year	Model & Location	Part No.
<i>SUBARU AWD - Impreza, Justy, Legacy, Loyale, Outback, SVX, XT (cont.)</i>					

REAR WHEEL (cont.)

AWD (cont.)

2006-2004	Impreza (WXR STI)	
Bearing Assy	516003[2]
Seal (Inner)	710226
Seal (Intermediate)	225673
Seal (Outer)	710393
2004-2000	Legacy	
Bearing Module	512183[2]
2004-2000	Outback	
Bearing Module	512183[2]
2003-1993	Impreza	
Bearing Assy	513248[2]
Ball Bearing (Opt)	511023[2]
Seal (Inner)	710226
Seal (Intermediate)	225005
Seal Viton (Outer)	710259
1999-1990	Legacy	
Bearing Assy	513248[2]
Ball Bearing (Opt)	511023[2]
Seal (Inner)	710226
Seal (Intermediate)	225005
Seal (Outer)	710529
1997-1992	SVX	
Bearing Assy	516003[2]
1994	Loyale	
Seal (Inner)	224015[2]
Bearing Assy (Inner)	513056[2]
Seal (Outer)	225005[2]

REAR AXLE

Differential

1997-1990	Exc. Justy (4WD)	
Seal	223255[2]
Bearing Assy	30208M[2]
1994-1990	Justy (4WD)	
Seal	222745[2]
Bearing Assy	32007X[2]

Pinion

2008-1998	Impreza (4WD)	
Seal	1173
1997-1990	Exc. Justy (4WD)	
Seal	1173
Bearing Assy (Inner)	32306
Bearing Assy (Outer)	32305
1994-1990	Justy (4WD)	
Seal	710267
Bearing Assy (Inner)	30206M

CLUTCH

Pilot Bearing

2002-1990	(4WD)	
Ball Bearing	201CC

CLUTCH - 3 CYLINDER

Release Bearing

1994-1991	1189cc/1.2	
Bearing Assy	614160

CLUTCH - 4 CYLINDER

Release Bearing

2002-1990	1820cc/1.8, 2212cc/2.2, 2457cc/2.5	
Bearing Assy	614159
1992-1990	1781cc/1.8L, 1781cc/1.8L (Turbo)	
Bearing Assy	614059

CLUTCH - 6 CYLINDER

Release Bearing

1991-1990	2672CC/2.7L	
Bearing Assy	614059

3-SPEED AUTOMATIC TRANSAXLE

Torque Converter

1994-1990	(TA86, TX86, T71T, T81M, T81T, T81X)	
Seal Viton	2025
Repair Sleeve	KWK99169

Output Shaft

1994-1990	(TA86, TX86, T71T, T81M, T81T, T81X)	
Seal	222745[2]
Repair Sleeve	KWK99106

4-SPEED AUTOMATIC TRANSAXLE

Differential

2002-1990	(TZ1A2, TZ102)	
Bearing Assy	30208M[2]

Torque Converter / Frt Pump

2002-1990	(TZ1A2, TA102, TZ102)	
Seal	225010
Repair Sleeve	KWK99196

Output Shaft

2008-1990	(TZ1A2, TA102, TZ102)	
Seal	223050[2]
Repair Sleeve	KWK99114

Oil Pump

2002-1990	(TZ1A2, TA102, TZ102)	
Seal	710265

Extension Housing

1996-1995	(TA102)	
Seal	3771
Repair Sleeve	KWK99139
1994-1990	(TA102, TZ102)	
Seal	3771
Repair Sleeve	KWK99139

Mfg./Year Model & Location Part No. Mfg./Year Model & Location Part No.

SUBARU AWD - Impreza, Justy, Legacy, Loyale, Outback, SVX, XT (cont.)**5-SPEED MANUAL TRANSAXLE****Differential**

2002-1998	(TY752, TY754)	
Bearing Assy	30208M[2]
1994-1990	(TM64F, TW64F)	
Ball Bearing (LH)	207S[2]
Ball Bearing (RH)	207[2]

Input Shaft

2002-1999	(TY754)	
Seal	222558
Repair Sleeve	KWK99098
2002-1990	(TM702, TM752)	
Seal	222240
Repair Sleeve	KWK99085
1994-1990	(TM64F, TW64F)	
Seal	222030
Ball Bearing	205BB[2]
Repair Sleeve	KWK99078
1994-1990	(TW75F, TY75F)	
Seal	222558
Ball Bearing	305AG[2]
Repair Sleeve	KWK99098

Output Shaft

2002-1999	(TY754)	
Seal	223050[2]
Repair Sleeve	KWK99114
2002-1990	(TY752)	
Seal	223050[2]
Repair Sleeve	KWK99114
1996-1990	(TM50F, TM55F, TM60F, TM64F, TW64F, TM70F)	
Seal	222745[2]
Repair Sleeve	KWK99106
1996-1990	(TM702, T71G, T71W, T72G, TM75F, TW75F, TM752, T81G)	
Seal	222745[2]
Repair Sleeve	KWK99106

Extension Housing

1994-1990	(TM50F, TM60F, TM70F, T71G, T72G, TM75F, TW75F, T81G)	
Seal	221820
1994-1990	(TM55F, T71W, TY75F, TY752)	
Seal	3771
Repair Sleeve	KWK99139

ALTERNATOR

1992-1990	Hitachi 50, 55, 60, 65 Amp.	
Ball Bearing (Drive End)	303CC
Ball Bearing (Rear End)	201CC

OIL PUMP**4 Cylinder**

2008-2000	1995cc/2.0L, 2458cc/2.5L	
Seal	710236

OIL PUMP (cont.)**4 Cylinder (cont.)**

1999-1990	1820cc/1.8, 2212cc/2.2, 2457cc/2.5	
Seal	710238

6 Cylinder

2007-2001	2999cc/3.0L	
Seal	710236
1997-1992	3318cc/3.3L	
Seal	710236

CAMSHAFT SEAL**3 Cylinder**

1994-1990	1189cc/1.2	
Seal	223018
Repair Sleeve	KWK99114

4 Cylinder

2005-1996	2457cc/2.5L	
Seal	223230
Repair Sleeve	KWK99128
2001-1990	1820cc/1.8L, 2212cc/2.2L	
Seal	223230
Repair Sleeve	KWK99128
1994-1990	1781cc/1.8L, 1781cc/1.8L (Turbo)	
Seal	223830
Repair Sleeve	KWK99147

6 Cylinder

2002-2001	2999cc/3.0L	
Seal	223230
Repair Sleeve	KWK99128
1996-1992	3318cc/3.3L	
Seal	223230
Repair Sleeve	KWK99128
1991-1990	2672cc/2.7L	
Seal	223830
Repair Sleeve	KWK99147

CRANKSHAFT FRONT SEAL**3 Cylinder**

1994-1990	1189cc/1.2	
Seal	710233

4 Cylinder

2006-1998	2458cc/2.5L	
Seal	710236
2005-2002	1994cc/2.0L	
Seal	710236
2001-1995	1781cc/1.8L, 2212cc/2.2L	
Seal	710236
1994-1990	1781cc/1.8L	
Seal	1038
Repair Sleeve	KWK99147

Mfg./Year Model & Location Part No. Mfg./Year Model & Location Part No.
SUBARU AWD - Impreza, Justy, Legacy, Loyale, Outback, SVX, XT (cont.)

CRANKSHAFT FRONT SEAL

6 Cylinder

2006-2001	2999cc/3.0L	
Seal		710236
1991-1990	2672cc/2.7L	
Seal		223230
Repair Sleeve		KWK99147

CRANKSHAFT REAR SEAL

3 Cylinder

1994-1990	1189cc/1.2	
Seal		710234

4 Cylinder

2008-2004	1995cc/2.0L, 2458cc/2.5L	
Seal Viton		710235
2003-1990	1820cc/1.8, 2212cc/2.2, 2457cc/2.5	
Seal Viton		710235
1994-1990	1781cc/1.8L, 1781cc/1.8L (Turbo)	
Seal		1019S
Repair Sleeve		KWK99298

CRANKSHAFT REAR SEAL

6 Cylinder

2008-2001	2999cc/3.0L	
Seal Viton		710235
1997-1992	3318cc/3.3L	
Seal Viton		710235
1991-1990	2672cc/2.7L	
Seal		1019S
Repair Sleeve		KWK99298

SUBARU TRUCK - SUV, Truck - B9 Tribeca, Baja, Forester

FRONT WHEEL

AWD

2009	Forester	
Hub Unit Bearing		HA590315[2] ²⁵
2009-2006	B9 TRIBECA	
Hub Unit Bearing		HA590150[2] ²⁵
2008-1998	Forester	
Seal (Inner)		1993[2]
Seal (Outer)		225650[2]
Bearing Assy		517008[2]
2006-2003	Baja	
Seal (Inner)		1993[2]
Seal (Outer)		225650[2]
Bearing Assy		517008[2]

REAR WHEEL

AWD

2009	Forester	
Hub Unit Bearing		HA590313[2] ²⁵
2009-2008	B9 TRIBECA	
Hub Unit Bearing		HA590169[2] ²⁵
2008-1998	Forester	
Bearing Assy		513248[2]
Ball Bearing (Opt)		511023[2]
Seal (Inner)		710226[2]
Seal (Intermediate)		225005
Seal (Outer)		710529
2007-2006	B9 TRIBECA	
Hub Unit Bearing		HA590150[2] ²⁵
2006-2003	Baja	
Bearing Module		512183[2]

REAR AXLE

Differential

2002-1998	Forester (Exc. Locking Diff.)	
Bearing Assy		32007X[2]
2002-1998	Forester (Locking Diff.)	
Seal		223255[2]
Bearing Assy		30208M[2]

Pinion

2008-1998	Forester	
Seal		1173
Bearing Assy (Inner)		
(Limited Slip)		32306
Bearing Assy (Inner)		
(Exc. Limited Slip)		32206M
Bearing Assy (Outer)		32305
Ball Bearing (Pilot)		30565
2006-2003	Baja (Auto Trans)	
Bearing Assy (Inner)		32206M
Seal		1173
2006-2003	Baja (Manual Trans)	
Seal		1173
Bearing Assy (Inner)		32306
Bearing Assy (Outer)		32305

CLUTCH

Pilot Bearing

2002-1998	Forester	
Ball Bearing		201CC

²⁵New Item, Check For Availability

Mfg./Year	Model & Location	Part No.	Mfg./Year	Model & Location	Part No.
-----------	------------------	----------	-----------	------------------	----------

SUBARU TRUCK - SUV, Truck - B9 Tribeca, Baja, Forester (cont.)

CLUTCH - 4 CYLINDER

Release Bearing

2002-1998 2457cc/2.5L
Bearing Assy614159

4-SPEED AUTOMATIC TRANSAXLE

Differential

2004-1998 (TZ1A2, TZ102)
Bearing Assy30208M[2]

Torque Converter / Frt Pump

2004-1998 (TZ1A2, TZ102)
Seal225010
Repair SleeveKWK99196

Output Shaft

2008-1998 (TZ1A2, TA102, TZ102)
Seal223050[2]
Repair SleeveKWK99114

Oil Pump

2004-1998 (TZ1A2, TA102, TZ102)
Seal710265

5-SPEED MANUAL TRANSAXLE

Differential

2004-1998 (TY752, TY754)
Bearing Assy30208M[2]

Input Shaft

2004-1998 (TY752, TY754)
Seal222558
Repair SleeveKWK99098

Output Shaft

2004-1998 (TY752, TY754)
Seal223050[2]
Repair SleeveKWK99114

OIL PUMP

4 Cylinder

2009-1998 2457cc/2.5L
Seal710236

6 Cylinder

2007-2006 2474cc/2.5L, 2980cc/3.0L
Seal710236

CAMSHAFT SEAL

4 Cylinder

2006-2004 2457cc/2.5L (DOHC)
Seal Viton (Intake)2012V
2006-1999 2457cc/2.5L (SOHC)
Seal223230[4]
Repair SleeveKWK99128[4]

CRANKSHAFT FRONT SEAL

4 Cylinder

2006-1998 2457cc/2.5L
Seal710236

CRANKSHAFT REAR SEAL

4 Cylinder

2009-1998 2457cc/2.5L
Seal Viton710235

6 Cylinder

2007-2006 2999cc/3.0L
Seal Viton710235

Mfg./Year	Model & Location	Part No.	Mfg./Year	Model & Location	Part No.
SUZUKI - FRONT DRIVE - Aerio, Esteem, Forenza, Reno, Swift, SX4, Verona					

FRONT WHEEL

FWD

2009-2007 SX4	
Ball Bearing	WB000035[2] ²⁵
2008-2005 Forenza	
Ball Bearing	510052[2]
2008-2005 Reno	
Ball Bearing	510052[2]
2007-2002 Aerio	
Ball Bearing	510077[2]
2006-2004 Verona (ABS)	
Hub Unit Bearing	HA590115[2] ²⁵
2006-2004 Verona (Non-ABS)	
Hub Unit Bearing	HA590131[2] ²⁵
2004 Forenza	
Ball Bearing	510052[2]
2002-1995 Esteem	
Seal (Inner)	710394[2]
Seal (Outer)	710393[2]
Ball Bearing	510018[2]
2001-1995 Swift	
Seal (Inner)	710394[2]
Seal (Outer)	710175[2]
Ball Bearing	510001[2]
1994-1990 Swift (Exc. GT, GTI)	
Seal (Inner)	710394[2]
Seal (Outer)	710175[2]
Ball Bearing	510001[2]
1994-1990 Swift (GT, GTI)	
Seal (Inner)	710394[2]
Seal (Outer)	710393[2]
Ball Bearing	510018[2]

AWD

2009-2007 SX4	
Ball Bearing	WB000035[2] ²⁵
2007-2002 Aerio	
Ball Bearing	510077[2]

REAR WHEEL

FWD

2009-2007 SX4	
Hub Unit Bearing	HA590330[2] ²⁵
2008-2005 Reno (ABS)	
Hub Unit Bearing	HA590112[2] ²⁵
2008-2005 Reno (Non-ABS)	
Hub Unit Bearing	HA590113[2] ²⁵
2008-2004 Forenza (Non-ABS)	
Hub Unit Bearing	HA590113[2] ²⁵
2008-2004 Forenza, Verona (ABS)	
Hub Unit Bearing	HA590112[2] ²⁵
2007-2002 Aerio (ABS)	
Hub Unit Bearing	HA590295[2] ²⁵
2006-2004 Verona (Non-ABS)	
Hub Unit Bearing	HA590113[2] ²⁵
2005-2002 Aerio (Non-ABS)	
Hub Unit Bearing	HA590160[2]
2002-1995 Esteem (Non-ABS)	
Hub Unit Bearing	HA590160[2]
2001-1995 Swift (ABS)	
Hub Unit Bearing	512204[2]

REAR WHEEL (cont.)

FWD (cont.)

2001-1995 Swift (Non-ABS)	
Ball Bearing (Inner)	205F[2]
Ball Bearing (Outer)	204F[2]
1994-1990 Swift (Exc. GT & Gti)	
Ball Bearing (Inner)	205F[2]
Ball Bearing (Outer)	204F[2]
1994-1990 Swift GT & GTi	
Hub Unit Bearing	512182[2]

AWD

2009-2007 SX4	
Hub Unit Bearing	HA590331[2] ²⁵
2007-2002 Aerio	
Seal	1188S
Ball Bearing	511034[2] ²⁵

CLUTCH - 4 CYLINDER

Pilot Bearing

2002-1990	
Ball Bearing	200CC

Release Bearing

2002-1990	
Bearing Assy	614082

3-SPEED AUTOMATIC TRANSAXLE

Differential

2001-1995 (Aisin A210)	
Ball Bearing	207[2]
1994-1990 (Aisin A210)(DOHC)	
Ball Bearing	207[2]
1994-1990 (Aisin A210)(SOHC)	
Ball Bearing	207S[2]

Torque Converter

2001-1990 (Aisin A210)	
Seal	223830
Repair Sleeve	KWK99177

Output Shaft

2001-1990 (Aisin A210)	
Seal	223540[2]
Repair Sleeve	KWK99139[2]

Manual Shaft

2001-1990 (Aisin A210)	
Seal	710116

4-SPEED AUTOMATIC TRANSAXLE

Differential

2002-1995 (Aisin 60 42)	
Ball Bearing	207[2]

²⁵New Item, Check For Availability

**SUZUKI - FRONT DRIVE - Aerio, Esteem, Forenza, Reno, Swift, SX4, Verona
(cont.)****4-SPEED AUTOMATIC TRANSAXLE****Torque Converter / Frt Pump**

2002-1999 (Aisin 60 40)	
Seal	710254
2002-1995 (Aisin 60 42)	
Seal	223830
Repair Sleeve	KWK99177

Output Shaft

2007-2004 (42LE)	
Seal	4764[2]

Manual Shaft

2008-2007 (Aisin 60 40)	
Seal	221207
Repair Sleeve	KWK99049
2007-1995 (Aisin 60 42)	
Seal	221207
Repair Sleeve	KWK99049

5-SPEED MANUAL TRANSAXLE**Transaxle Rebuild Kit**

2002-1995 Esteem	
Kit	TRKFS110
2001-1990 Swift	
Kit	TRKFS110

Differential

2002-1990 (MX1)	
Ball Bearing (LH)	207
Ball Bearing (RH)	107WB

Input Shaft

2001-1990 (MX1)	
Seal (RH)	222030
Bearing Assy (RH)	32204[2]
Repair Sleeve	KWK99078

Output Shaft

2002-1990 (MX1)	
Seal (LH)	223552
Seal (RH)	223535
Repair Sleeve	KWK99139[2]

ALTERNATOR

1992-1990	
Ball Bearing (Drive End)	202FF

CAMSHAFT SEAL**4 Cylinder**

2002-1999 1800cc/1.8L (DOHC)	
Seal	710334[2]
Repair Sleeve	KWK99128[2]
2001-1990 1300cc/1.3L	
Seal	710310[2]
Repair Sleeve	KWK99128[2]

CAMSHAFT SEAL (cont.)**4 Cylinder (cont.)**

2000-1992 1590cc/1.6L	
Seal	710310
Repair Sleeve	KWK99128

CRANKSHAFT FRONT SEAL**4 Cylinder**

2008-2007 1995cc/2.0L (DOHC)	
Seal	710521
Repair Sleeve	KWK99177
2006-2004 2300/2.3L	
Seal	710521
2003-2002 2000cc/2.0L	
Seal	710521
Repair Sleeve	KWK99177
2002-1999 1800cc/1.8L (DOHC)	
Seal	710521
Repair Sleeve	KWK99177
2001-1992 1590cc/1.6L	
Seal	710310
Repair Sleeve	KWK99128
2001-1990 1300cc/1.3L	
Seal	710310
Repair Sleeve	KWK99128

CRANKSHAFT REAR SEAL**4 Cylinder**

2008-2004 1995cc/2.0, 2290cc/2.3L	
Seal	710520
2008-2004 1998cc/2.0L, 2000cc/2.0L	
Seal Viton	710237
2002-1999 1800cc/1.8L (DOHC)	
Seal	710520
2001-1992 1590cc/1.6L	
Seal	710334
2001-1990 1300cc/1.3L	
Seal	710334

Mfg./Year Model & Location Part No. Mfg./Year Model & Location Part No.

SUZUKI - SUV - Grand Vitara, Samurai, Sidekick, Vitara, X90, XL7

FRONT WHEEL

FWD

2009-2007 XL7
Hub Unit Bearing HA590332[2]²⁵

RWD

2009-2007 XL7
Hub Unit Bearing HA590333[2]
2008-2006 Grand Vitara
Hub Unit Bearing HA590178[2]²⁵
2005-2001 Vitara, Grand Vitara
Hub Unit Bearing 513193[2]
2005-2001 XL7
Hub Unit Bearing 513193[2]
2000-1999 Vitara, Grand Vitara
Seal (Inner) 710240[2]
Seal (Outer) 710239[2]
Bearing Assy 517009[2]
1999-1996 X90
Seal (Inner) 710240[2]
Seal (Outer) 710239[2]
Bearing Assy 517009[2]
1998-1990 Sidekick
Seal (Inner) 710240[2]
Seal (Outer) 710239[2]
Bearing Assy 517009[2]
1995-1990 Samurai
Seal (Inner) 1948[2]
Cone/Cup LM300849-LM300811[4]³²

4WD

2008-2006 Grand Vitara
Hub Unit Bearing HA590178[2]²⁵
2006-2001 XL7
Hub Unit Bearing 513193[2]
2005-2001 Vitara, Grand Vitara
Hub Unit Bearing 513193[2]
2000-1999 Vitara, Grand Vitara
Seal (Inner) 710240[2]
Seal (Outer) 710239[2]
Bearing Assy 517009[2]
1998-1996 X90
Seal (Inner) 710255[2]
Seal (Outer) 710256[2]
Bearing Assy 517009[2]
1998-1990 Sidekick
Seal (Inner) 710240[2]
Seal (Outer) 710239[2]
Bearing Assy 517009[2]
1995-1990 Samurai
Seal (Inner) 1948[2]
Cone/Cup LM300849-LM300811[4]³²

AWD

2009-2007 XL7
Hub Unit Bearing HA590332[2]²⁵
2000 Grand Vitara
Seal (Inner) 710240[2]
Seal (Outer) 710239[2]
Bearing Assy 517009[2]

REAR WHEEL

FWD

2009-2007 XL7
Hub Unit Bearing HA590333[2]

RWD

2008-2006 Grand Vitara
Hub Unit Bearing HA590178[2]²⁵
2006-2001 XL7
Ball Bearing 511030[2]
2005-1999 Vitara, Grand Vitara
Seal 710522[2]
Ball Bearing 511024[2]
1998-1996 X90
Seal (Inner) 224820[2]
Seal (Outer) 710193[2]
Ball Bearing 511004[2]¹⁵
1998-1990 Sidekick
Seal (Inner) 224820[2]
Seal (Outer) 710193[2]
Ball Bearing 511004[2]¹⁵
1995-1990 Samurai
Seal 224820[2]
Ball Bearing 511002[2]

4WD

2008-2006 Grand Vitara
Hub Unit Bearing HA590178[2]²⁵
2005-1999 Vitara, Grand Vitara
Seal 710522[2]
Ball Bearing 511024[2]
1998-1996 X90
Seal (Inner) 224820[2]
Seal (Outer) 710193[2]
Ball Bearing 511004[2]¹⁵
1998-1990 Sidekick
Seal (Inner) 224820[2]
Seal (Outer) 710193[2]
Ball Bearing 511004[2]¹⁵
1995-1990 Samurai
Seal 224820[2]
Ball Bearing 511002[2]

AWD

2009-2007 XL7
Hub Unit Bearing HA590333[2]
2000 Grand Vitara
Seal 710522[2]
Ball Bearing 511024[2]

FRONT AXLE

Steering Knuckle

2007-1990
Seal (Inner) 710255
Seal (Outer) 710256

¹⁵New Bearing Design, Replaces Collar Replaces Inner & Outer Brg.

²⁵New Item, Check For Availability

³²2 Cups & 2 Cones,

SUZUKI - SUV - Grand Vitara, Samurai, Sidekick, Vitara, X90, XL7 (cont.)**4WD FRONT AXLE****Axle Shaft**

1998-1990 (SJF, SKF)	
Seal	710330[2]
Ball Bearing	206FF[2]

Differential

2005-1990	
Cone/Cup	17887-17831[2]

Pinion

2007-1999 Grand Vitara	
Seal	710523
Bearing Assy (Inner)	30307M
Bearing Assy (Outer)	30306M
2006-2004 XL7	
Seal	710523
Bearing Assy (Inner)	30307M
Bearing Assy (Outer)	30306M
2004-1999 Vitara	
Seal	710523
Bearing Assy (Inner)	30307M
Bearing Assy (Outer)	30306M
1998-1990	
Seal Viton (SJF)	350572
Seal (SKF)	710523
Bearing Assy (Inner)	30307M
Bearing Assy (Outer)	30306M
Repair Sleeve	KWK99147

Steering Knuckle

1998-1990 (SJF, SKF)	
Seal (Inner)	710255
Seal (Outer)	710256

REAR AXLE**Differential**

2005-1990	
Cone/Cup	17887-17831[2]

Pinion

2005-1999	
Seal	710523
Bearing Assy (Inner)	30307M
Bearing Assy (Outer)	30306M
1998-1990	
Seal Viton (SJR)	350572
Seal (SKR)	710523
Bearing Assy (Inner)	30307M
Bearing Assy (Outer)	30306M
Repair Sleeve	KWK99147

TRANSFER CASE REBUILD KIT

1998-1990 Sidekick	
Kit	TRKFS140
1990 Samurai	
Kit	TRKFS120

TRANSFER CASE**Input Shaft**

2005-1990 Sidekick, Vitara	
Seal	223540
Ball Bearing	207[2]
Repair Sleeve	KWK99139
1998-1996 X90	
Seal	223540
Repair Sleeve	KWK99139
1995-1990 Samurai	
Seal (Outer)	223843
Ball Bearing (Outer)	RW122[2]
Repair Sleeve	KWK99147

Front Output Shaft

2005-1990 Sidekick, Vitara	
Ball Bearing (Inner)	306L[2]
Seal (Outer)	1213N
Ball Bearing (Outer)	RW122[2]
Repair Sleeve	KWK99157
1998-1996 X90	
Seal	1213N
Repair Sleeve	KWK99157
1995-1990 Samurai	
Ball Bearing (Inner)	306L[2]
Seal Viton (Outer)	1965
Ball Bearing (Outer)	RW122[2]

Rear Output Shaft

1998-1996 X90	
Seal	1213N
Repair Sleeve	KWK99157
1998-1990 Sidekick	
Seal	1213N
Ball Bearing	RW122[2]
Repair Sleeve	KWK99157
1995-1990 Samurai	
Seal Viton	1965
Ball Bearing	RW122[2]
Repair Sleeve	KWK99147

3-SPEED AUTOMATIC TRANSMISSION**Torque Converter**

1992-1990 (3L30)	
Seal	6712NA
Repair Sleeve	KWK99187

Rear Seal/Ext. Housing

1992-1990 (3L30)	
Seal	473823

Selector Shaft Seal/Man. Shaft

1995-1990 (3L30)	
Seal	8792S

Mfg./Year	Model & Location	Part No.	Mfg./Year	Model & Location	Part No.
SUZUKI - SUV - Grand Vitara, Samurai, Sidekick, Vitara, X90, XL7 (cont.)					

4-SPEED AUTOMATIC TRANSMISSION

Torque Converter

1998-1992 (Aisin O3 72)	
Seal	223830
Repair Sleeve	KWK99147

Rear Seal/Ext. Housing

1998-1992 (Aisin O3 72)	
Seal	710319

Selector Shaft Seal/Man. Shaft

2006-1996 (Aisin O3 72)	
Seal	221207
Repair Sleeve	KWK99049

CLUTCH - 4 CYLINDER

Pilot Bearing

1998-1990	
Ball Bearing	200CC

Release Bearing

1998-1990	
Bearing Assy	614056
Bearing Only	01496

5-SPEED MANUAL TRANSMISSION

Transmission Rebuild Kit

1998-1996 X90	
Kit	TRKFS130
1998-1990 Sidekick	
Kit	TRKFS130
1995-1990 Samurai	
Kit	TRKFS100

Front Input Shaft

2002-1999 Vitara	
Seal	1981
1998-1990 Sidekick	
Seal	222535
Repair Sleeve	KWK99098

Countershaft

1995-1990 Samurai	
Ball Bearing (Rr)	304WB[2]

Rear Output Shaft

1998-1990 Sidekick	
Seal	222580
Repair Sleeve	KWK99098
1995-1990 Samurai	
Ball Bearing (Rr)	305AG[2]

5-SPEED MANUAL TRANSMISSION

Extension Housing

1995-1990 Samurai	
Seal	223215

5-SPEED AUTOMATIC TRANSAXLE

Torque Converter

2008-2007 (AF33)	
Seal	222830
Repair Sleeve	KWK99147

Output Shaft

2007 (AF33)	
Seal	4764[2]

Manual Shaft

2008-2007 (AF33)	
Seal	221207
Repair Sleeve	KWK99049[2]

A/C COMPRESSOR

1992-1990 (Nippondenso)(Axial)	
Ball Bearing	5000KFF[2]

ALTERNATOR

2001-1994 (Nippondenso)	
Ball Bearing (Drive End)	303CC
1991-1990	
Ball Bearing (Drive End)	202FF

CAMSHAFT SEAL

4 Cylinder

2003-1990 1590cc/1.6L	
Seal	710310
Repair Sleeve	KWK99128
1995-1990 1300cc/1.3L	
Seal	710310
Repair Sleeve	KWK99128

CRANKSHAFT FRONT SEAL

4 Cylinder

2003-1999 2000cc/2.0L	
Seal	710521
Repair Sleeve	KWK99177
2001-1990 1590cc/1.6L	
Seal	710310
Repair Sleeve	KWK99128
1998-1996 1800cc/1.8L (DOHC)	
Seal	710521
Repair Sleeve	KWK99177
1995-1990 1300cc/1.3L	
Seal	710310
Repair Sleeve	KWK99128

Mfg./Year	Model & Location	Part No.	Mfg./Year	Model & Location	Part No.
-----------	------------------	----------	-----------	------------------	----------

SUZUKI - SUV - Grand Vitara, Samurai, Sidekick, Vitara, X90, XL7 (cont.)

CRANKSHAFT FRONT SEAL

6 Cylinder

2006-2001	2700cc/2.7L (DOHC)	
Seal		710521
2005-1999	2494cc/2.5L (DOHC)	
Seal		710521
Repair Sleeve		KWK99177

CRANKSHAFT REAR SEAL

4 Cylinder

2003-1999	1995cc/2.0L (DOHC)	
Seal		710520
2002-1990	1590cc/1.6L	
Seal		710334
1998-1996	1800cc/1.8L (DOHC)	
Seal		710520
1995-1990	1300cc/1.3L	
Seal		710334

CRANKSHAFT REAR SEAL

6 Cylinder

2006-2001	2700cc/2.7L (DOHC)	
Seal		710520
2005-1999	2494cc/2.5L (DOHC)	
Seal		710520

TOYOTA - FRONT DRIVE - Avalon, Camry, Celica, Corolla, Echo, Matrix, Paseo, Prius, Solara, Tercel, Yaris

FRONT WHEEL

FWD

2009	Matrix	
Ball Bearing		510070[2]
2009	Matrix	
Ball Bearing		510063[2]
2009-2007	Camry	
Ball Bearing		510063[2]
2009-2006	Yaris (ABS)	
Bearing Assy		WB000004[2] ²⁵
2009-2005	Avalon	
Ball Bearing		510063[2]
2009-2004	Prius	
Hub Unit Bearing		HA590064[2] ²⁵
2009-2003	Corolla	
Ball Bearing		510070[2]
2008-2004	Solara	
Ball Bearing		510063[2]
2008-2003	Matrix	
Ball Bearing		510070[2]
2007-2006	Yaris (Non-ABS)	
Bearing Assy		WB000005[2] ²⁵
2006-2004	Camry	
Ball Bearing		510063[2]
2005-2000	Celica	
Ball Bearing		510070[2]
2005-2000	Echo	
Ball Bearing		510062[2]
2004-1995	Avalon	
Ball Bearing		510006[2]
2003-2001	Prius	
Ball Bearing		510070[2]
2003-1999	Solara	
Ball Bearing		510006[2]
Hub Unit Bearing		HA590302K[2] ⁶⁷
2003-1992	Camry (4 Cyl.)	
Ball Bearing		510006[2]
Hub Unit Bearing		HA590303K[2] ⁶⁷

FRONT WHEEL (cont.)

FWD (cont.)

2003-1992	Camry (6 Cyl.)	
Ball Bearing		510006[2]
Hub Unit Bearing		HA590302K[2] ⁶⁷
2002-1993	Corolla (ABS)	
Seal (Inner)		225673[2]
Seal (Outer)		4898[2]
Hub Unit Bearing (Kit)		518507[2] ⁰⁶
Ball Bearing		510007[2]
2002-1993	Corolla (Non-ABS)	
Seal (Inner)		1993[2]
Seal (Outer)		4898[2]
Hub Unit Bearing (Kit)		518507[2] ⁰⁶
Ball Bearing		510007[2]
1999-1993	Paseo, Tercel	
Seal (Inner)		712938[2]
Seal (Outer)		225410[2]
Ball Bearing		510002[2]
1999-1990	Celica	
Seal (Inner)		4899[2]
Seal (Outer)		225220[2]
Ball Bearing		514002B[2]
1992-1991	Paseo	
Seal (Inner)		225673[2]
Ball Bearing (Inner)		510002[2]
Seal (Outer)		225410[2]
1992-1990	Corolla	
Seal (Inner)		1993[2]
Seal (Outer)		4898[2]
Hub Unit Bearing (Kit)		518507[2] ⁰⁶
Seal Kit (Kit)		5696[2] ¹²
Ball Bearing		510007[2]
1992-1990	Tercel	
Seal (Inner)		225673[2]
Seal (Outer)		225410[2]
Ball Bearing		510002[2]

⁰⁶Kit = 2 Seals, Studed Spindle, Bearing, Plate ¹²Opt = Seal & O-Ring. Incl w/ Hub Unit.

²⁵New Item, Check For Availability ⁶⁷Kit = Flg, Brg, Nut, & Snap Ring

Mfg./Year Model & Location Part No. Mfg./Year Model & Location Part No.

TOYOTA - FRONT DRIVE - Avalon, Camry, Celica, Corolla, Echo, Matrix, Paseo, Prius, Solara, Tercel, Yaris (cont.)

FRONT WHEEL (cont.)

FWD (cont.)

1991-1990 Camry	
Seal (Inner)	4899[2]
Seal (Outer)	225220[2]
Hub Unit Bearing	518506[2] ⁰⁵
Ball Bearing	514002B[2]

AWD

2009 Matrix	
Ball Bearing	510063[2]
2006-2003 Matrix	
Ball Bearing	510070[2]
1993-1990 Celica	
Seal (Inner)	4899[2]
Seal (Outer)	225220[2]
Ball Bearing	514002B[2]
1992-1990 Corolla	
Seal Kit (Kit)	5696[2] ¹²
Seal (Inner)	1993[2]
Seal (Outer)	4898[2]
Hub Unit Bearing (Kit)	518507[2] ⁰⁶
Ball Bearing	510007[2]
1991-1990 Camry	
Seal (Inner)	4899[2]
Seal (Outer)	225220[2]
Hub Unit Bearing	518506[2] ⁰⁵
Ball Bearing	514002B[2]

REAR WHEEL

FWD

2009 Corolla	
Hub Unit Bearing	HA590305[2] ²⁵
2009 Matrix Base	
Hub Unit Bearing	HA590305[2] ²⁵
2009 Matrix S, XR	
Hub Unit Bearing	HA590311[2] ²⁵
2009 Matrix XRS	
Hub Unit Bearing	HA590310[2] ²⁵
2009-2007 Camry	
Hub Unit Bearing (LH)	HA592460
Hub Unit Bearing (RH)	HA592450
2009-2007 Yaris (ABS)	
Hub Unit Bearing	HA590170[2] ²⁵
2009-2007 Yaris (Non-ABS)	
Hub Unit Bearing	HA590172[2] ²⁵
2009-2005 Avalon	
Hub Unit Bearing (LH)	HA592460
Hub Unit Bearing (RH)	HA592450
2009-2004 Prius	
Hub Unit Bearing	HA590055[2] ²⁵
2008-2004 Solara	
Hub Unit Bearing (LH)	HA592460
Hub Unit Bearing (RH)	HA592450
2008-2003 Corolla (ABS)	
Hub Unit Bearing	512217[2] ⁸⁴
2008-2003 Corolla (Non-ABS)	
Hub Unit Bearing	512218[2] ⁸⁴
2008-2003 Matrix (ABS)	
Hub Unit Bearing	512217[2] ⁸⁴

REAR WHEEL (cont.)

FWD (cont.)

2008-2003 Matrix (Non-ABS)	
Hub Unit Bearing	512218[2] ⁸⁴
2006-2002 Camry (ABS)	
Hub Unit Bearing (LH)	HA592460
Hub Unit Bearing (RH)	HA592450
2005-2000 Celica (ABS)	
Hub Unit Bearing	HA590040[2] ²⁵
2005-2000 Celica (Non-ABS)	
Hub Unit Bearing	512218[2] ⁸⁴
2005-2000 Echo (ABS)	
Hub Unit Bearing	HA594245[2]
2005-2000 Echo (Non-ABS)	
Hub Unit Bearing	HA592410[2]
2004-2002 Camry (Non-ABS)	
Hub Unit Bearing	HA596030[2]
2004-1995 Avalon	
Hub Unit Bearing (ABS, Non-ABS)	HA590370[2] ²⁵
Hub Unit Bearing (Non-ABS)	HA590371[2] ⁸³
Bearing Module	512009[2]
2003-2001 Prius	
Hub Unit Bearing	HA590063[2] ²⁵
2003-1999 Solara	
Hub Unit Bearing (ABS, Non-ABS)	HA590370[2] ²⁵
Hub Unit Bearing (Non-ABS)	HA590371[2] ⁸³
Bearing Module	512009[2]
2002-1996 Corolla (ABS)	
Hub Unit Bearing	512184[2]
2002-1993 Corolla (Non-ABS)	
Hub Unit Bearing	512018[2]
2001-1992 Camry	
Hub Unit Bearing (ABS, Non-ABS)	HA590370[2] ²⁵
Hub Unit Bearing (Non-ABS)	HA590371[2] ⁸³
Bearing Module	512009[2]
1999-1994 Celica	
Bearing Module	512137[2]
1999-1992 Paseo	
Seal (Inner)	1174S[2]
Set (Outer)	SET1[2]
Cone	A149[2]
1999-1991 Tercel	
Seal (Inner)	1174S[2]
Set (Outer)	SET1[2]
Cone	A149[2]
1995-1993 Corolla (ABS)	
Hub Unit Bearing	512019[2]
1993-1990 Celica	
Seal	224210
Ball Bearing	513022[2]
1992-1990 Corolla	
Seal	1180S
Ball Bearing	513031[2]
1991-1990 Camry	
Seal	224210
Ball Bearing	513022[2]

⁰⁵Kit = 2 Seals, Studded Spindle, Bearing, Plate ⁰⁶Kit = 2 Seals, Studded Spindle, Bearing, Plate
¹²Opt = Seal & O-Ring. Incl w/ Hub Unit. ²⁵New Item, Check For Availability ⁸³Deplete
422 Inventory ⁸⁴Reorder

Mfg./Year	Model & Location	Part No.	Mfg./Year	Model & Location	Part No.
TOYOTA - FRONT DRIVE - Avalon, Camry, Celica, Corolla, Echo, Matrix, Paseo, Prius, Solara, Tercel, Yaris (cont.)					

REAR WHEEL (cont.)**FWD (cont.)**

1991-1990	Camry Wagon	
Seal	224210
Bearing Module	512009[2]
1990	Tercel	
Seal (Inner)	223605
Bearing Assy (Inner)	32005X[2]
Seal (Outer)	225775
Set (Outer)	SET1

4WD

1991-1990	Camry	
Seal (Inner)	4899[2]
Seal (Outer)	225275[2]
Ball Bearing	514002B[2]

AWD

2009	Matrix (ABS)	
Hub Unit Bearing	HA590294[2] ²⁵
2006-2003	Matrix (ABS)	
Hub Unit Bearing	HA590002[2]
1993-1990	Celica	
Seal (Inner)	225775[2]
Seal (Outer)	225275[2]
Ball Bearing	514002B[2]
1992-1990	Corolla	
Seal	224210
Ball Bearing	88506BR[2]

REAR AXLE**Differential**

1993-1990	Corolla (All Trac)(4WD)	
Set	SET45[2]

Pinion

1993-1990	Camry (All Trac)(4WD)	
Cone/Cup	HM88649-HM88610
Seal (Outer)	1176S
1993-1990	Celica (All Trac)(4WD)	
Cone/Cup	HM88649-HM88610
Seal (Outer)	1176S
1993-1990	Corolla (All Trac)(4WD)	
Cone/Cup	HM88649-HM88610
Seal (Outer)	1176S
Repair Sleeve	KWK99147

TRANSFER CASE REBUILD KIT

1993-1990	S100	
Kit	TRKFT740
1993-1990	S125	
Kit	TRKFT750
1993-1990	S110	
Kit	TRKFT740
1992-1990	S120	
Kit	TRKFT750

TRANSFER CASE**Input Shaft**

1992-1990		
Seal (47MM Shaft)	710143
Seal (61MM Shaft)	710528

Rear Output Shaft

1993-1990	S100, S110, S120	
Seal	1175
Repair Sleeve	KWK99147

Idler Shaft

1992-1990	S110, S120	
Seal (LH)	710528
Seal (RH)	710527

Side Gear

1993-1990	S100	
Seal	710143
1992-1990	S110, S120 (A/T)	
Seal	710137
1992-1990	S110, S120 (M/T)	
Seal	710143

CLUTCH - 4 CYLINDER**Pilot Bearing**

2002-1998	1496cc/1.5L, 1794cc/1.8L, 1796cc/1.8L	
Cylindrical Bearing	MSN5305GTBV ²⁵
1997-1990	1456cc/1.5L, 1496/1.5L, 1587cc/1.6L, 1762cc/1.8L	
Cylindrical Bearing	MSN5305GTBV ²⁵

Release Bearing

2002-2000	1587cc./1.6L, 1762cc./1.8L, 1794cc./1.8L (200mm Cl.)	
Bearing Assy	614152
2002-1992	1587cc/1.6L, 1762cc/1.8L	
Bearing Assy	614152
2001-1992	2164cc./2.2L (225mm Cl.)	
Bearing Assy	614091
1999-1990	2164cc./2.2L (232mm Cl.)	
Bearing Assy	614091
1999-1990	1456cc./1.5L, 1496/1.5L (190mm Cl.)	
Bearing Assy	614043
1998-1990	1998cc./2.0L (DOHC & TURBO)(235mm Cl.)	
Bearing Assy	614084
1994-1992	1453cc./1.5L, (200mm Cl.)	
Bearing Assy	614043
1993-1990	1998cc./2.0L (DOHC & TURBO)(225mm Cl.)	
Bearing Assy	614167
1992-1990	1587cc./1.6L, (225mm Cl.)	
Bearing Assy	614084
1991	1456cc./1.5L, 1587cc./1.6L (200mm Cl.)	
Bearing Assy	614043

²⁵New Item, Check For Availability

Mfg./Year Model & Location Part No. Mfg./Year Model & Location Part No.

TOYOTA - FRONT DRIVE - Avalon, Camry, Celica, Corolla, Echo, Matrix, Paseo, Prius, Solara, Tercel, Yaris (cont.)

CLUTCH - 4 CYLINDER (cont.)

Release Bearing (cont.)

1991-1990	1998cc./2.0L (DOHC)(235mm Cl.)	
	Bearing Assy	614084
1991-1990	1998cc./2.0L (DOHC)(225mm Cl.)	
	Bearing Assy	614147
1990	1456cc./1.5L, (212mm Cl.)	
	Bearing Assy	614043
1990	1587cc./1.6L, (200mm Cl.)	
	Bearing Assy	614043

CLUTCH - 6 CYLINDER

Release Bearing

2001-1992	2958cc./3.0L, 2995cc./3.0L, (225mm Cl.)	
	Bearing Assy	614167
1991-1990	2507cc./2.5L, (235mm Cl.)	
	Bearing Assy	614084

3-SPEED AUTOMATIC TRANSAXLE

Differential

2002-1990	(A130L, A131L, A132L)	
	Seal	710416[2]

Torque Converter

2002-1990	(A55, A55F, A130L, A131L, A132L)	
	Seal	223830
	Repair Sleeve	KWK99147

Output Shaft

2002-1990	(A130L, A131L, A132L)	
	Seal	710110[2]

Pinion

1998-1990	(A132L)	
	Bearing Assy (Rr)	30208M

Manual Shaft

2002-1990	(A130L, A131L, A132L)	
	Seal	221207
	Repair Sleeve	KWK99049

4-SPEED AUTOMATIC TRANSAXLE

Differential

2006-1990	(A140E, A140L, A242L, A245E)	
	Seal	710416[2]

4-SPEED AUTOMATIC TRANSAXLE

Torque Converter / Frt Pump

2006-1990	(A140E, A140L, A240E, A240L, A241E, A241H, A241L, A242L, A243L, A244E, A245E, A246E, A540E, A540H, A541E)	
	Seal	223830
	Repair Sleeve	KWK99147

Input Shaft

2006-1990	(A240E, A240L, A241E, A241H, A241L, A243L, A244E, A246E)	
	Seal	710138
	Repair Sleeve	KWK99139

Output Shaft

2008-2002	(U240E, U241E, U340E, U341E, U341F)	
	Seal	223540[2]
	Repair Sleeve	KWK99139[2]
2008-1990	(A240E, A240L, A241E, A241H, A241L, A242L, A243L, A244E, A245E, A246E)	
	Seal (LH)	710109
	Seal (RH)	710110
2004-1992	(A540E, A541E)	
	Seal (LH)	710112
	Seal (LH)	712551
2001-1990	(A140E, A140L, U241E)	
	Seal	223540[2]
	Repair Sleeve	KWK99139[2]

Pinion

1997-1995	(A242L)	
	Bearing Assy (Rr)	30208M

Manual Shaft

2003-1990	(A140E, A140L, A240E, A240L, A241E, A241H, A241L, A242L, A243L, A244E, A245E, A246E, A540E, A540H, A541E)	
	Seal	221207
	Repair Sleeve	KWK99049

5-SPEED AUTOMATIC TRANSAXLE

Manual Shaft

2007-2004	(U151E)	
	Seal	221207
	Repair Sleeve	KWK99049

Mfg./Year Model & Location Part No. Mfg./Year Model & Location Part No.

TOYOTA - FRONT DRIVE - Avalon, Camry, Celica, Corolla, Echo, Matrix, Paseo, Prius, Solara, Tercel, Yaris (cont.)**4-SPEED MANUAL TRANSAXLE****Differential**

1999-1990 (C141)	
Bearing Assy (LH)	32207M
1990 (Z41, Z42, Z44, Z46)	
Bearing Assy	32007C[2] ¹⁶

Input Shaft

1996-1990 (C140, C141)	
Seal	320603
Ball Bearing	101SS[2]
Repair Sleeve	KWK99098

Output Shaft

1996-1990 (C140, C141)	
Seal (LH)	710109
Seal (RH)	710110

Selector Shaft Seal/Man. Shaft

1996-1990 (C140, C141)	
Seal	1015N
Repair Sleeve	KWK99085

5-SPEED MANUAL TRANSAXLE**Differential**

2004 (C50)	
Cone/Cup (RH)	NP258107-NP773051
2003-1997 (C50)	
Cone/Cup (RH)	NP861151-NP666842
2001-1990 (C150, C151)	
Bearing Assy (LH)	32207M

Input Shaft

2005-2000 (C56)	
Seal	320603
Repair Sleeve	KWK99098
2004-1990 (C50, C51, C52, C150, C151)	
Seal	320603
Ball Bearing	101SS[2]
Repair Sleeve	KWK99098
2001-1990 S50, S51, E53, S53	
Seal	223010
Repair Sleeve	KWK99114
1999-1990 (E50F2, E55F2, E55F5, E56F2, E56F5, E57F5, E150F, S54)	
Seal Viton	710172
Repair Sleeve	KWK99123

Output Shaft

2002-1990 (C50, C51, C52, C150, C151)	
Seal (LH)	710109
Seal (RH)	710110
2001-1990 S50, S51, S53, S54	
Seal	223540[2]
Repair Sleeve	KWK99139[2]

5-SPEED MANUAL TRANSAXLE (cont.)**Output Shaft (cont.)**

1993-1992 (E53)	
Seal (LH)	223540
Repair Sleeve (LH)	KWK99139
Seal Viton (RH)	224026
Repair Sleeve (RH)	KWK99157
1993-1990 (E50F2, E55F2, E55F5)(ABS)	
Seal (LH)	710112
Seal (RH)	710143
1993-1990 (E50F2, E55F2, E55F5)(w/o ABS)	
Seal (LH)	710115
Seal (RH)	710143
1992-1990 (E56F2, E56F5, E57F5)	
Seal (LH)	710115
Seal (RH)	710143
1991-1990 (E52, E150F)	
Seal	710112[2]

Selector Shaft Seal/Man. Shaft

2008-1990 (Exc. S50, S51, S53, S54)	
Seal	1015N
Repair Sleeve	KWK99085
2001-1990 S50, S51, S53, S54	
Seal	221207
Repair Sleeve	KWK99049

Extension Housing

1993-1990 (E50F2, E55F2, E55F5, E56F2, E56F5, E57F5, E150F)	
Seal	1175

6-SPEED MANUAL TRANSAXLE**Input Shaft**

2002-2000	
Seal	320603

ALTERNATOR

1997-1990 (Nippondenso 70 Amp.)	
Ball Bearing (Rear End)	302CC

POWER STEERING**Pitman Shaft**

2002-2000 Corolla	
Seal	221510
1999-1998 Celica, Corolla	
Seal	221510
1997 Celica, Corolla, Paseo, Tercel	
Seal	221510
1996-1990 Camry, Celica, Corolla, Paseo, Tercel, Wagon	
Seal	221510

¹⁶Obsolete

Mfg./Year	Model & Location	Part No.	Mfg./Year	Model & Location	Part No.
TOYOTA - FRONT DRIVE - Avalon, Camry, Celica, Corolla, Echo, Matrix, Paseo, Prius, Solara, Tercel, Yaris (cont.)					

POWER STEERING

Pump Shaft

2002-1997	Avalon, Camry, Corolla	
Seal	710412
1999-1997	Celica	
Seal	710156
1997	Paseo, Tercel	
Seal	710151
1996-1990	Avalon, Corolla	
Seal	710412
1996-1990	Camry, Celica, Corolla, Paseo, Tercel, Wagon	
Seal	710156

Sector Shaft

1996-1990	Camry	
Seal	222820

Worm Shaft

2002-1993	Corolla	
Seal	222630
1999-1990	Celica	
Seal	710303
1992-1990	Corolla	
Seal (Lower)	710155
Seal (Upper)	710154

OIL PUMP

4 Cylinder

2009-2002	2362cc/2.4L	
Seal	221820
2008-1990	1456cc/1.5L, 1497/1.5L	
Seal	710450
2001-1990	1995cc/2.0L, 1998cc/2.0L, 2164cc/2.2L	
Seal	221820
1997-1990	1587cc/1.6L	
Seal	223235

6 Cylinder

2008-1994	2995cc/3.0L	
Seal	224040
Repair Sleeve	KWK99157

CAMSHAFT SEAL

4 Cylinder

2004-1990	1497cc/1.5L, 1587cc/1.6L, 1762cc/1.8L	
Seal	1987S
Repair Sleeve	KWK99139
2001-1990	2164cc/2.2L	
Seal	223801
Repair Sleeve	KWK99147
1994-1990	1452cc/1.5L, 1456cc/1.5L	
Seal	1987S
Repair Sleeve	KWK99139
1993-1990	1998cc/2.0L (Turbo)	
Seal	1987S
Repair Sleeve	KWK99139

CAMSHAFT SEAL (cont.)

4 Cylinder (cont.)

1993-1990	1998cc/2.0L (w/o Turbo)	
Seal	223801
Repair Sleeve	KWK99147

6 Cylinder

2006-2004	3300cc/3.3L	
Seal	223802
2006-1994	2995cc/3.0L	
Seal	223801
Repair Sleeve	KWK99147
1993-1992	2958cc/3.0L	
Seal	223801
Repair Sleeve	KWK99147
1991-1990	2507cc/2.5L	
Seal	223801
Repair Sleeve	KWK99147

CRANKSHAFT FRONT SEAL

4 Cylinder

2009-2002	2362cc/2.4L	
Seal	223802
2008-1990	1456cc/1.5L, 1497/1.5L	
Seal	1987S
Repair Sleeve	KWK99139
2007-1998	1794cc/1.8L, 1796cc/1.8L	
Seal	223800
Repair Sleeve	KWK99147
2001-1992	2164cc/2.2L	
Seal	1953S
Seal Viton	2025
Repair Sleeve	KWK99166
1997-1993	1762cc/1.8L	
Seal	223235
Repair Sleeve	KWK99128
1997-1990	1587cc/1.6L	
Seal	223235
1993-1990	1839cc/1.8L, 1974cc/2.0L, 1995cc/2.0L, 1998cc/2.0L	
Seal	1953S
Seal Viton	2025
Repair Sleeve	KWK99169

6 Cylinder

2006-2004	3300cc/3.3L	
Seal	224020
Repair Sleeve	KWK99157
2004-1992	2959cc/3.0L, 2995cc/3.0L	
Seal	224020
Repair Sleeve	KWK99157
1993-1990	2507cc/2.5L, 2958cc/3.0L	
Seal	224020
Repair Sleeve	KWK99157

CRANKSHAFT REAR SEAL

4 Cylinder

2009-2002	2362cc/2.4L	
Seal Viton	710189

Mfg./Year	Model & Location	Part No.	Mfg./Year	Model & Location	Part No.
-----------	------------------	----------	-----------	------------------	----------

TOYOTA - FRONT DRIVE - Avalon, Camry, Celica, Corolla, Echo, Matrix, Paseo, Prius, Solara, Tercel, Yaris (cont.)

CRANKSHAFT REAR SEAL (cont.)

4 Cylinder (cont.)

2008-2005	1497cc/1.5L (DOHC)	
Seal	228009
2008-1998	1794cc/1.8L 1ZZ-FE	
Seal	710465
2006-2000	1795cc/1.8L GTS / 2ZZGE	
Seal	716102
2004-1990	1456cc/1.5L, 1497/1.5L	
Seal	228015
Repair Sleeve	KWK99315
2001-1990	1998cc/2.0L, 2164cc/2.2L	
Seal	716102
Repair Sleeve	KWK99333
1998-1990	1452cc/1.5L, 1587cc/1.6L, 1762cc/1.8L	
Seal	227045
Repair Sleeve	KWK99272
1993-1990	1998cc/2.0L (Turbo)	
Seal Viton	710189
Repair Sleeve	KWK99349

CRANKSHAFT REAR SEAL

6 Cylinder

2008-1990	2507cc/2.5L, 2958cc/3.0L, 2995cc/3.0L, 3311cc/3.3L, 3456cc/3.5L	
Seal Viton	229210

TOYOTA - REAR DRIVE - Cressida, MR2, Supra

FRONT WHEEL

RWD

2005-1999	MR2	
Hub Unit Bearing	HA595017[2]
1998-1990	Supra	
Seal	1941
Ball Bearing	510017[2]
1995-1990	MR2	
Seal	224210
Ball Bearing	513022[2]
1992-1990	Cressida	
Seal	224870
Ball Bearing	513150[2]

REAR WHEEL

RWD

2005-2000	MR2	
Ball Bearing	510070[2]
1998-1990	Supra	
Seal (Inner)	1935[2]
Seal (Outer)	1928[2]
Ball Bearing	511007[2]
1995-1990	MR2	
Ball Bearing	510006[2]
1992-1990	Cressida	
Seal (Inner)	1935[2]
Seal (Outer)	1928[2]
Ball Bearing	511007[2]

REAR AXLE

Differential Rebuild Kit

1995-1990	(7.5" R.G.)(Exc. Turbo)	
Kit	DRK350

Differential

1992-1990	(7.8" R.G.)	
Seal	710142[2]

Pinion

1998-1993	(7.8" R.G.)	
Seal	710525
1992-1990	(7.8" R.G.)	
Seal	1177
Bearing Assy (Inner)	35028
Bearing Assy (Outer)	30306M
1992-1990	(7.3" R.G.)	
Seal	1177
Bearing Assy (Inner)	32307
Bearing Assy (Outer)	30306M
1992-1990	(7.1" R.G.)	
Seal	1177
Bearing Assy (Inner)	32307
Bearing Assy (Outer)	30306M
1992-1990	(7.5" R.G.)	
Seal	1177
Bearing Assy (Inner)	32307
Bearing Assy (Outer)	30306M

4-SPEED AUTOMATIC TRANSMISSION

Torque Converter

1998-1994	(A340E)	
Seal	223830
Repair Sleeve	KWK99147
1992-1990	(A40D, A42DL, A43D, A43DL, A43DE, A340E)	
Seal	223830
Repair Sleeve	KWK99147

Mfg./Year	Model & Location	Part No.	Mfg./Year	Model & Location	Part No.
TOYOTA - REAR DRIVE - Cressida, MR2, Supra (cont.)					

4-SPEED AUTOMATIC TRANSMISSION

Rear Seal/Ext. Housing

1998-1994 (A340E)	
Seal	3459S
1992-1990 (A340E)	
Seal	3459S

Selector Shaft Seal/Man. Shaft

1998-1994 (A340E)	
Seal	221207
Repair Sleeve	KWK99049
1992-1990 (A340E)	
Seal	221207
Repair Sleeve	KWK99049

CLUTCH - 6 CYLINDER

Pilot Bearing

1998-1994 2997cc/3.0L	
Ball Bearing	201CC
1992-1990 2954/3.0L	
Ball Bearing	201CC
1992-1990 2759cc/2.8L	
Ball Bearing	201CC

CLUTCH - 4 CYLINDER

Release Bearing

1995-1990 1998cc/2.0L	
Bearing Assy	614167
1995-1990 2164cc/2.2L	
Bearing Assy	614091

CLUTCH - 6 CYLINDER

Release Bearing

1998-1994 2997cc/3.0L	
Bearing Assy	614088
1992-1990 2954cc./3.0L (236mm Cl.)	
Bearing Assy	614088
1992-1990 2954cc./3.0L (DOHC & TURBO)(240mm Cl.)	
Bearing Assy	614085

5-SPEED MANUAL TRANSMISSION

Transmission Rebuild Kit

2000-1990 (W55, W56, W58 EFI Motor)	
Kit	TRKFT150

Front Input Shaft

2001-1991 E153	
Seal	710143
1998-1994 (W58)	
Seal	1981
Repair Sleeve	KWK99114
1992-1990 (R154)	
Seal	223253
1992-1990 (W50, W55, W58)	
Seal	1981
Repair Sleeve	KWK99114

5-SPEED MANUAL TRANSMISSION

Rear Output Shaft

1998-1994 (W58)	
Seal	223840
1992-1990 (R154)	
Seal	3459S
1992-1990 (W55, W58)	
Seal	223840

6-SPEED MANUAL TRANSMISSION

Front Input Shaft

1998-1994 (Getrag V160)	
Seal	223608

Rear Output Shaft

1998-1994 (Getrag V160)	
Seal	710364

4-SPEED AUTOMATIC TRANSAXLE

Torque Converter / Frt Pump

1995-1990 (A141E, A240E, A241E)	
Seal	223830
Repair Sleeve	KWK99147

Input Shaft

1995-1990 (A240E, A241E)	
Seal	710138
Repair Sleeve	KWK99139

Output Shaft

1995-1990 (A141E, A240E, A241E)	
Seal (LH)	710109
Seal (RH)	710110

Manual Shaft

1995-1990 (A141E, A240E, A241E)	
Seal	221207
Repair Sleeve	KWK99049

5-SPEED MANUAL TRANSAXLE

Input Shaft

1995-1990 E153	
Seal	710143
1995-1990 S54	
Seal Viton	710172
Repair Sleeve	KWK99172

Output Shaft

1995-1990 E153	
Seal	710112[2]
1995-1990 S54	
Seal	223540[2]
Repair Sleeve	KWK99139

Mfg./Year Model & Location Part No. Mfg./Year Model & Location Part No.

TOYOTA - REAR DRIVE - Cressida, MR2, Supra (cont.)**5-SPEED MANUAL TRANSAXLE****Selector Shaft Seal/Man. Shaft**

1995-1990	S54	
Seal		221207
Repair Sleeve		KWK99049
1995-1990	(C52)	
Seal		1015N
1995-1990	E153	
Seal		1015N

ALTERNATOR

1995-1990	(Nippondenso 70 Amp.)	
Ball Bearing (Rear End)		302CC
1992-1990	(Nippondenso 100 Amp.)	
Ball Bearing (Rear End)		302CC
1992-1990	(Nippondenso 80 Amp.)	
Ball Bearing (Rear End)		302CC

OIL PUMP**4 Cylinder**

1995-1990	1998cc/2.0L, 2164cc/2.2L	
Seal		221820

CAMSHAFT SEAL**4 Cylinder**

1995-1991	1998cc/2.0L (Turbo)	
Seal		1987S
Repair Sleeve		KWK99139
1995-1991	2164cc/2.2L	
Seal		223800
Repair Sleeve		KWK99147

6 Cylinder

1998-1993	2997cc/3.0L	
Seal		710436
1992-1990	2954/3.0L	
Seal		1987S
Repair Sleeve		KWK99139

CRANKSHAFT FRONT SEAL**4 Cylinder**

2005-2000	1796cc./1.8L	
Seal		223802
1995-1991	2164cc/2.2L	
Seal Viton		2025
Repair Sleeve		KWK99166
1995-1990	1998cc/2.0L (DOHC & TURBO)	
Seal Viton		2025
Repair Sleeve		KWK99166

6 Cylinder

1998-1993	2997cc/3.0L (DOHC & TURBO)	
Seal		224663
Repair Sleeve		KWK99181
1992-1990	2954cc/3.0L (DOHC & TURBO)	
Seal		710187

CRANKSHAFT REAR SEAL**4 Cylinder**

2005-2000	1794cc/1.8L 1ZZ-FE	
Seal		710465
1995-1991	1998cc/2.0L (Turbo)	
Seal Viton		710189
Repair Sleeve		KWK99349
1995-1991	2164cc/2.2L	
Seal		716102
Repair Sleeve		KWK99333

6 Cylinder

1998-1993	2997cc/3.0L (DOHC & TURBO)	
Seal Viton		229005
Repair Sleeve		KWK99354
1992-1990	2954cc/3.0L (DOHC & TURBO)	
Seal		228010
Repair Sleeve		KWK99315

Mfg./Year	Model & Location	Part No.	Mfg./Year	Model & Location	Part No.
TOYOTA TRUCK - Minivan, SUV, Truck - FJ Cruiser, Highlander, Landcruiser, Pickup, Previa, RAV4, Sequoia, Sienna, Tacoma, Tundra, T100, 4Runner					

FRONT WHEEL

FWD

2009-2008	Highlander	
	Ball Bearing	WB000024[2] ²⁵
2009-2006	RAV4 (L4)	
	Hub Unit Bearing	HA590165[2] ²⁵
2009-2006	RAV4 (V6)	
	Hub Unit Bearing	HA590168[2] ²⁵
2008-2004	Sienna	
	Ball Bearing	510063[2]
2007-2001	Highlander	
	Ball Bearing	510063[2]
2005-2001	RAV4	
	Ball Bearing	510006[2]
2003-1998	Sienna	
	Ball Bearing	510006[2]
2000-1996	RAV4 (ABS)	
	Seal (Inner)	4899[2]
	Seal (Outer)	225220[2]
	Seal (Intermediate)	5686[2] ²⁰
	Ball Bearing	514002B[2]
2000-1996	RAV4 (Non ABS)	
	Seal (Inner)	4899[2]
	Seal (Outer)	225220[2]
	Seal (Intermediate)	5694[2] ²⁰
	Ball Bearing	514002B[2]

RWD

2009-2008	Sequoia	
	Bearing Module	BM500017[2] ²⁵
2009-2007	FJ Cruiser	
	Bearing Module	BM500007[2] ²⁵
2008-2007	Tundra	
	Bearing Module	BM500017[2] ²⁵
2008-2005	Tacoma (Exc. PreRunner)	
	Taprd Bearing Assy	WB000001[2] ²⁵
2008-2005	Tacoma (PreRunner)	
	Bearing Module	BM500009[2] ²⁵
2008-2003	4Runner	
	Bearing Module	BM500007[2] ²⁵
2007-2001	Sequoia	
	Set	SET29[2]
2006-2000	Tundra	
	Set	SET29[2]
2004-1998	Tacoma (PreRunner)	
	Set	SET29[2]
2004-1995	Tacoma (Exc. PreRunner)	
	Seal (Inner)	1948[2]
	Set (Inner)	SET5[2]
	Set (Outer)	SET3[2]
2002-1996	4Runner	
	Set	SET29[2]
1998-1993	T100	
	Seal (Inner)	1948[2]
	Cone/Cup (Inner)	M38549H-M38510[2]
	Cone/Cup (Outer)	1380H-1328X[2]
1997-1991	Previa	
	Seal (Inner)	225678[2]
	Seal (Outer)	226150[2]
	Bearing Assy	517003[2]

FRONT WHEEL (cont.)

RWD (cont.)

1995-1990	4Runner	
	Seal (Inner)	710092[2]
	Cone/Cup (Inner)	JLM104948-JLM104910[2]
	Set (Outer)	SET47[2]
1995-1990	Pickup (Exc. T100)	
	Seal (Inner)	1948[2]
	Set (Inner)	SET5[2]
	Set (Outer)	SET3[2]
1990	Van Wagon	
	Seal (Inner)	224820[2]
	Set (Inner)	SET6[2]
	Set (Outer)	SET2[2]

4WD

2009-2007	FJ Cruiser	
	Bearing Module	BM500007[2] ²⁵
2009-2006	RAV4 (L4)	
	Hub Unit Bearing	HA590165[2] ²⁵
2009-2006	RAV4 (V6)	
	Hub Unit Bearing	HA590168[2] ²⁵
2008	Land Cruiser	
	Bearing Module	BM500018[2]
2008	Sequoia	
	Bearing Module	BM500017[2] ²⁵
2008-2007	Tundra	
	Bearing Module	BM500017[2] ²⁵
2008-2005	Tacoma	
	Bearing Module	BM500009[2] ²⁵
2008-2003	4Runner	
	Bearing Module	BM500007[2] ²⁵
2007-2001	Sequoia	
	Set	SET29[2]
2007-1998	Land Cruiser	
	Seal (Inner)	710456[2]
	Cone/Cup (Inner)	JLM506849A-JLM506810[2]
	Set (Outer)	SET47[2]
2006-2000	Tundra	
	Set	SET29[2]
	Seal (Outer)	1956S[2]
2004-1995	Tacoma	
	Set	SET29[2]
2002-1996	4Runner	
	Set	SET29[2]
1997-1993	T100	
	Seal (Inner)	710092[2]
	Cone/Cup (Inner)	JLM104948-JLM104910[2]
	Seal (Outer)	710266[2]
	Set (Outer)	SET47[2]
1997-1991	Previa	
	Seal (Inner)	225678[2]
	Seal (Outer)	226150[2]
	Bearing Assy	517003[2]
1997-1990	Land Cruiser	
	Seal (Inner)	226285[2]
	Cone/Cup (Inner)	JLM104948-JLM104910[2]
	Set (Outer)	SET47[2]

²⁰Seal Kit

²⁵New Item, Check For Availability

Mfg./Year	Model & Location	Part No.	Mfg./Year	Model & Location	Part No.
TOYOTA TRUCK - Minivan, SUV, Truck - FJ Cruiser, Highlander, Landcruiser, Pickup, Previa, RAV4, Sequoia, Sienna, Tacoma, Tundra, T100, 4Runner (cont.)					

FRONT WHEEL (cont.)**4WD (cont.)**

1995-1990	4Runner	
Seal (Inner)	710092[2]
Cone/Cup (Inner)	JLM104948-JLM104910[2]
Set (Outer)	SET47[2]
1995-1990	Pickup (Exc. T100)	
Seal (Inner)	710092[2]
Cone/Cup (Inner)	JLM104948-JLM104910[2]
Set (Outer)	SET47[2]
1990	Van	
Seal (Inner)	226610[2]
Set (Outer)	SET47[2]
Bearing Assy	517012[2] ^Z

AWD

2009-2008	Highlander	
Ball Bearing	WB000024[2] ²⁵
2009-2004	Sienna	
Ball Bearing	510063[2]
2007-2001	Highlander	
Ball Bearing	510063[2]
2005-2001	RAV4	
Ball Bearing	510006[2]
2000-1996	RAV4 (ABS)	
Seal (Inner)	4899[2]
Seal (Outer)	225220[2]
Seal (Intermediate)	5694[2] ²⁰
Ball Bearing	514002B[2]
2000-1996	RAV4 (Non ABS)	
Seal (Inner)	4899[2]
Seal (Outer)	225220[2]
Seal (Intermediate)	5686[2] ²⁰
Ball Bearing	514002B[2]
1997-1991	Previa	
Seal (Inner)	225678[2]
Seal (Outer)	226150[2]
Bearing Assy	517003[2]

REAR WHEEL**FWD**

2009-2008	Highlander	
Hub Unit Bearing	HA590287[2] ²⁵
2009-2006	RAV4 (ABS)	
Hub Unit Bearing	HA590173[2] ²⁵
2008-2004	Sienna	
Hub Unit Bearing	512280[2] ²⁵
2007-2004	Highlander	
Hub Unit Bearing (LH)	HA592461 ²⁵
Hub Unit Bearing (RH)	HA592451 ²⁵
2005-1998	RAV4 (ABS)	
Hub Unit Bearing	HA594504[2]
2005-1997	RAV4 (Non ABS)	
Hub Unit Bearing	HA594241[2]
2003-2001	Highlander	
Hub Unit Bearing (LH)	HA592460
Hub Unit Bearing (RH)	HA592450
2003-1998	Sienna (ABS)	
Hub Unit Bearing	512041[2]

REAR WHEEL**RWD**

2009-2007	FJ Cruiser	
Bearing Module (LH)	HA594246
Bearing Module (RH)	HA590050
2008	Sequoia	
Bearing Module	BM500019[2] ²⁵
2008-2007	Tundra	
Bearing Module (LH)	BM500016 ²⁵
Bearing Module (RH)	BM500015 ²⁵
2008-2005	Tacoma	
Hub Unit Bearing (LH)	512294 ²⁵
Hub Unit Bearing (RH)	512295 ²⁵
2008-2003	4Runner	
Bearing Module (LH)	HA594246
Bearing Module (RH)	HA590050
2007-2001	Sequoia	
Hub Unit Bearing	HA594301[2]
2006-2000	Tundra	
Seal (Inner)	1960[2]
Seal (Outer)	SL260003[2] ²⁵
Ball Bearing	511031[2]
2004-2001	Tacoma	
Seal (Inner)	1960[2]
Ball Bearing	511031[2]
Seal (Outer)	SL260003[2] ²⁵
2002-2001	4Runner	
Seal (Inner)	1960[2]
Seal (Outer)	SL260003[2] ²⁵
Ball Bearing	511031[2]
2000-1996	4Runner (ABS)	
Seal (Inner)	1960[2]
Seal (Outer)	1956S[2]
Ball Bearing	511021[2]
2000-1995	Tacoma (ABS)	
Seal (Inner)	1960[2]
Seal (Outer)	1956S[2]
Ball Bearing	511021[2]
2000-1995	Tacoma (Non-ABS)	
Seal (Inner)	1960[2]
Seal (Outer)	1956S[2]
Ball Bearing	RW130R[2]
2000-1990	4Runner (Non-ABS)	
Seal (Inner)	1960[2]
Seal (Outer)	1956S[2]
Ball Bearing	RW130R[2]
1998-1993	T100 (ABS)	
Seal (Inner)	1960[2]
Seal (Outer)	1956S[2]
Ball Bearing	511021[2]
1998-1993	T100 (Non-ABS)	
Seal (Inner)	1960[2]
Seal (Outer)	1956S[2]
Ball Bearing	RW130R[2]
1997-1991	Previa (ABS)(Disc)	
Seal (Inner)	710178[2]
Seal (Outer)	1955[2]
Ball Bearing	510005[2]
1997-1991	Previa (Non-ABS)(Drum)	
Seal (Inner)	710178[2]
Seal (Outer)	1955[2]
Ball Bearing	511001[2]

^ZNon-Cancellable/Non-Returnable²⁰Seal Kit²⁵New Item, Check For Availability

Mfg./Year	Model & Location	Part No.	Mfg./Year	Model & Location	Part No.
TOYOTA TRUCK - Minivan, SUV, Truck - FJ Cruiser, Highlander, Landcruiser, Pickup, Previa, RAV4, Sequoia, Sienna, Tacoma, Tundra, T100, 4Runner (cont.)					

REAR WHEEL (cont.)

RWD (cont.)

1995-1991	Pickup (SRW)(ABS)	
	Seal (Inner)	1960[2]
	Seal (Outer)	1956S[2]
	Ball Bearing	511021[2]
1995-1990	4Runner (ABS ~ 2 Wheel)	
	Seal (Inner)	1960[2]
	Seal (Outer)	1956S[2]
	Ball Bearing	511021[2]
1995-1990	Pickup (DRW)(Full Floating Axle)	
	Seal (Inner)	226285[2]
	Cone/Cup (Inner)	JLM104948-JLM104910[2]
	Seal (Outer)	710076[2]
	Set (Outer)	SET47[2]
1995-1990	Pickup (SRW)(Semi Floating Axle)	
	Seal (Inner)	1960[2]
	Seal (Outer)	1956S[2]
	Ball Bearing	RW130R[2]

4WD

2009-2007	FJ Cruiser	
	Bearing Module (LH)	HA594246
	Bearing Module (RH)	HA590050
2009-2006	RAV4	
	Hub Unit Bearing	HA590201[2] ²⁵
2008	Land Cruiser	
	Bearing Module (LH)	BM500029 ²⁵
	Bearing Module (RH)	BM500030 ²⁵
2008	Sequoia	
	Bearing Module	BM500019[2] ²⁵
2008-2007	Tundra	
	Bearing Module (LH)	BM500016 ²⁵
	Bearing Module (RH)	BM500015 ²⁵
2008-2005	Tacoma	
	Hub Unit Bearing (LH)	512294 ²⁵
	Hub Unit Bearing (RH)	512295 ²⁵
2008-2003	4Runner	
	Bearing Module (LH)	HA594246
	Bearing Module (RH)	HA590050
2007-2001	Sequoia	
	Hub Unit Bearing	HA594301[2]
2007-1998	Land Cruiser	
	Ball Bearing	510011[2]
2006-2000	Tundra	
	Seal (Inner)	1960[2]
	Seal (Outer)	SL260003[2] ²⁵
	Ball Bearing	511031[2]
2004-2001	Tacoma	
	Seal (Inner)	1960[2]
	Seal (Outer)	SL260003[2] ²⁵
	Ball Bearing	511031[2]
2002-2001	4Runner	
	Seal (Inner)	1960[2]
	Seal (Outer)	SL260003[2] ²⁵
	Ball Bearing	511031[2]
2000-1996	4Runner (ABS ~ 4 Wheel)	
	Seal (Inner)	1960[2]
	Seal (Outer)	1956S[2]
	Ball Bearing	511021[2]

REAR WHEEL (cont.)

4WD (cont.)

2000-1995	Tacoma (ABS)	
	Seal (Inner)	1960[2]
	Seal (Outer)	1956S[2]
	Ball Bearing	511021[2]
2000-1995	Tacoma (Non-ABS)	
	Seal (Inner)	1960[2]
	Seal (Outer)	1956S[2]
	Ball Bearing	RW130R[2]
2000-1990	4Runner (Non-ABS)	
	Seal (Inner)	1960[2]
	Seal (Outer)	1956S[2]
	Ball Bearing	RW130R[2]
1998-1993	T100 (ABS)	
	Seal (Inner)	1960[2]
	Seal (Outer)	1956S[2]
	Ball Bearing	511021[2]
1998-1993	T100 (Non-ABS)	
	Seal (Inner)	1960[2]
	Seal (Outer)	1956S[2]
	Ball Bearing	RW130R[2]
1997-1991	Previa (ABS)(Disc)	
	Seal (Inner)	710178[2]
	Seal (Outer)	1955[2]
	Ball Bearing	510005[2]
1997-1991	Previa (Non-ABS)(Drum)	
	Seal (Inner)	710178[2]
	Seal (Outer)	1955[2]
	Ball Bearing	511001[2]
1997-1990	Land Cruiser (Semi Floating Axle)	
	Seal	1959
	Cylindrical Bearing	513008[2]
1997-1990	Land Cruiser (Full Floating Axle)	
	Seal (Inner)	226285
	Cone/Cup (Inner)	JLM104948-JLM104910[2]
	Seal (Outer)	710076
	Set (Outer)	SET47[2]
1995-1991	Pickup (SRW)(ABS)	
	Seal (Inner)	1960[2]
	Seal (Outer)	1956S[2]
	Ball Bearing	511021[2]
1995-1990	4Runner (ABS ~ 2 Wheel)	
	Seal (Inner)	1960[2]
	Seal (Outer)	1956S[2]
	Ball Bearing	511021[2]
1995-1990	Pickup (DRW)(Full Floating Axle)	
	Seal (Inner)	226285
	Cone/Cup (Inner)	JLM104948-JLM104910[2]
	Seal (Outer)	710076
	Set (Outer)	SET47[2]
1990	Pickup (SRW)(Semi Floating Axle)	
	Seal (Inner)	1960[2]
	Seal (Outer)	1956S[2]
	Ball Bearing	RW130R[2]

²⁵New Item, Check For Availability

Mfg./Year	Model & Location	Part No.	Mfg./Year	Model & Location	Part No.
TOYOTA TRUCK - Minivan, SUV, Truck - FJ Cruiser, Highlander, Landcruiser, Pickup, Previa, RAV4, Sequoia, Sienna, Tacoma, Tundra, T100, 4Runner (cont.)					

REAR WHEEL**AWD**

2009-2004	Highlander	
	Hub Unit Bearing	HA590338[2] ²⁵
2009-2004	Sienna	
	Hub Unit Bearing	HA591080[2]
2005-2001	RAV4	
	Hub Unit Bearing	HA594505[2] ²⁵
2003-2001	Highlander	
	Seal (Outer)	225275[2]
	Ball Bearing	514002B[2]
2000-1996	RAV4	
	Bearing Module	512038[2]
1997-1991	Previa (ABS)(Disc)	
	Seal (Inner)	710178[2]
	Seal (Outer)	1955[2]
	Ball Bearing	510005[2]
1997-1991	Previa (Non-ABS)(Drum)	
	Seal (Inner)	710178[2]
	Seal (Outer)	1955[2]
	Ball Bearing	511001[2]

4WD FRONT AXLE**Axle Shaft**

2002-1990	(IFS 7.5", 6.7" R.G.)	
	Ball Bearing	B30[2]

Differential Rebuild Kit

2003-1995	Tacoma (Exc. Locking Diff.)	
	Kit	DRK355A
2003-1990	Pickup (7.5" R.G.)	
	Kit	DRK350
2002-1990	4Runner (7.5" R.G.)	
	Kit	DRK350
1997-1990	Land Cruiser (FJ80)(Exc. Locking Diff.)	
	Kit	DRK356A
1997-1990	Land Cruiser (FJ80)(Locking Diff.)	
	Kit	DRK356

Differential

2002-1991	(8.875" R.G.)	
	Bearing Assy	32010X[2]
1990		
	Seal	710419[2]
	Cone/Cup	17887-17831[2]

Pinion

2008-2005	(8" R.G.)	
	Seal	710525
2004-1990		
	Seal (All)	1177
	Bearing Assy (Inner)	
	(7.5" & 7.8" R.G.)	32307
	Bearing Assy (Outer)	
	(7.5", 7.8" & 9.5" R.G.)	30306M
	Bearing Assy (Inner)	
	(9.25" R.G.)	31308A ⁸³

(9.25" R.G.)	31308 ⁸⁴
1997-1990	(6.7" R.G.)
	Seal
	1176S
	Cone/Cup (Inner)
	HM88649-HM88610
	Cone/Cup (Outer)
	M86649-M86610

Steering Knuckle

1990	(9.25", 9.5" R.G.)
	Bearing Assy
	30303[2]

REAR AXLE**Differential Rebuild Kit**

2008-1996	Tacoma (Locking Diff Prod. From 9/96 On)	
	Kit	DRK354A
2008-1995	T100, Tacoma, Tundra (Exc. Locking Diff.)	
	Kit	DRK355
2003-1990	Pickup (8" R.G.)	
	Kit	DRK351
2000-1990	4Runner (8" R.G.)	
	Kit	DRK351
1997-1990	Land Cruiser (FJ80)(Exc. Locking Diff.)	
	Kit	DRK357A
1997-1990	Land Cruiser (FJ80)(Locking Diff.)	
	Kit	DRK357
1996-1995	Tacoma (Locking Diff Prod. From 9/95 To 9/96)	
	Kit	DRK354
1995-1990	Pickup (7.5" R.G.)(6 Cyl.)	
	Kit	DRK350

Differential

2005-1996	(6.7" R.G.)	
	Seal	710419[2]
	Set	SET45[2]
2005-1991	(8.875" R.G.)	
	Bearing Assy	32010X[2]
1995-1990	(7.1", 7.8", 9.5" R.G.)	
	Cone/Cup	17887-17831[2]

Pinion

2008-2005	(8" R.G.)	
	Seal	710525
2008-1996	(6.7" R.G.)	
	Seal	1176S
	Cone/Cup (Inner)	HM88649-HM88610
	Cone/Cup (Outer)	M86649-M86610
2002-1993	(8.25" R.G.)	
	Seal	710525
	Cone/Cup (Outer)	HM88649-HM88610
2002-1991	(8.875" R.G.)	
	Seal	1177
	Bearing Assy (Inner)	35028
	Bearing Assy (Outer)	30306M
1995-1990	(7.8" R.G.)	
	Seal	1177
	Bearing Assy (Inner)	32307
	Bearing Assy (Outer)	30306M

²⁵New Item, Check For Availability⁸³Deplete Inventory⁸⁴Reorder

Mfg./Year	Model & Location	Part No.	Mfg./Year	Model & Location	Part No.
TOYOTA TRUCK - Minivan, SUV, Truck - FJ Cruiser, Highlander, Landcruiser, Pickup, Previa, RAV4, Sequoia, Sienna, Tacoma, Tundra, T100, 4Runner (cont.)					

REAR AXLE (cont.)

Pinion (cont.)

1990 (7.1" R.G.)	
Seal	1177
Bearing Assy (Inner)	32307
Bearing Assy (Outer)	30306M
1990 (9.5" R.G.)	
Seal	1177
Bearing Assy (Inner)	35028
Bearing Assy (Outer)	30306M

TRANSFER CASE REBUILD KIT

2003-1990 Land Cruiser	
Kit	TRKFT500

TRANSFER CASE

Input Shaft

2004-1990 (RF1A)(M/T)	
Ball Bearing	307L[2]
1997-1990 (HF2A, HF2AV)	
Seal	224810
Repair Sleeve	KWK99189

Front Output Shaft

2004-1990 (VF1A)	
Seal (A/T)	710140
Seal (M/T)	710114
2002-1990	
Seal (RF1A)(A/T)	225874
Seal (RF1A)(M/T)	223840
Ball Bearing (RF1A)(M/T)	308L[2]
1997-1991 (TF1AV)	
Seal	710319
1997-1990 (HF2A, HF2AV)	
Seal	224815
Ball Bearing	208S
Repair Sleeve	KWK99189

Rear Output Shaft

2004-1990 (RF1A)	
Seal	223840
2002-1990 (VF1A)(A/T)	
Seal	710140
2002-1990 (VF1A)(M/T)	
Seal	710114
1997-1991 (TF1AV)	
Seal	710254
1997-1990 (HF2A, HF2AV)	
Seal	710173
Ball Bearing	110CB[2]

Idler Shaft

2004-1990 (RF1A)(M/T)	
Ball Bearing	306L[2]

4-SPEED AUTOMATIC TRANSMISSION

Torque Converter

2003-2000 (A46DE, A46DF, A44DL, A45DL, A340E, A340H, A343F)	
Seal	223830
Repair Sleeve	KWK99147
1999-1990 (A46DE, A46DF, A44DL, A45DL, A340E, A340H, A343F)	
Seal	223830
Repair Sleeve	KWK99147
1997-1990 (A440H, A440L, A442F)	
Seal Viton	2025
Repair Sleeve	KWK99169

Rear Seal/Ext. Housing

2003-1990 (A340E, A340F, A340H, A343F)	
Seal	3459S
1997-1990 (A440H, A440L, A442F)	
Seal	224820
1997-1990 (A46DE, A46DF, A44DL, A45DL)	
Seal	710319

Selector Shaft Seal/Man. Shaft

2008-1990	
Seal	221207
Repair Sleeve	KWK99049

CLUTCH

Pilot Bearing

2002-2001 Highlander	
Ball Bearing	201CC
2002-2001 Sequoia	
Ball Bearing	201CC
2002-2000 Tundra	
Ball Bearing	201CC
2002-1998 Sienna	
Ball Bearing	201CC
2002-1996 RAV4	
Ball Bearing	201CC
2002-1995 Pickup, Tacoma	
Ball Bearing	201CC
2002-1990 Land Cruiser (Gas)	
Ball Bearing	201CC
2002-1990 4Runner	
Ball Bearing	201CC
1998-1993 T100	
Ball Bearing	201CC
1994-1990 Pickup	
Ball Bearing	201CC

Release Bearing

2003-2000 Tundra	
Bearing Assy	614162
2002-2001 Sequoia	
Bearing Assy	614162

Mfg./Year Model & Location Part No. Mfg./Year Model & Location Part No.

TOYOTA TRUCK - Minivan, SUV, Truck - FJ Cruiser, Highlander, Landcruiser, Pickup, Previa, RAV4, Sequoia, Sienna, Tacoma, Tundra, T100, 4Runner (cont.)**CLUTCH (cont.)****Release Bearing (cont.)**

2002-1998	Land Cruiser	
	Bearing Assy	614162
2002-1998	Sienna	
	Bearing Assy	614086
2002-1996	4Runner V6	
	Bearing Assy	614162
2002-1996	RAV4	
	Bearing Assy	614084
2002-1995	Pickup, Tacoma L4	
	Bearing Assy	614088
2002-1995	Pickup, Tacoma V6	
	Bearing Assy	614162
2000-1990	4Runner L4	
	Bearing Assy	614088
1998-1995	T100 V6	
	Bearing Assy	614162
1998-1994	T100 L4	
	Bearing Assy	614088
1995-1990	Pickup (2WD)	
	Bearing Assy	614086
1995-1990	Pickup (4WD)	
	Bearing Assy	614086
1995-1990	4Runner V6	
	Bearing Assy	614086
1994-1993	T100 V6	
	Bearing Assy	614086
1993-1990	Land Cruiser (Gas)	
	Bearing Assy	614086

4-SPEED MANUAL TRANSMISSION**Input Shaft**

1995-1990	(G40, N40, W42, W46)	
	Seal	1981
	Repair Sleeve	KWK99114

Rear Output Shaft

1995-1990	(G40, W46)	
	Seal	223840

5-SPEED MANUAL TRANSMISSION**Transmission Rebuild Kit**

2004-1994	(R150, R151)(From 8/94 On)	
	Kit	TRKFT340
2003-1995	(W59)	
	Kit	TRKFT210
1995-1990	(G57, G59)	
	Kit	TRKFT190
1994-1993	(R150, R151)(Thru 7/94)	
	Kit	TRKFT200

5-SPEED MANUAL TRANSMISSION**Front Input Shaft**

2002-1995	(W55, W56, G58, W58, W59)	
	Seal	1981
	Repair Sleeve	KWK99114
2002-1990	(R150, R150F, R151F, R154)	
	Seal	223253
1994-1990	(G50, G52, G53, G54, G57, G58, G59, W50, W52, W55, W56, W58)	
	Seal	1981
	Repair Sleeve	KWK99114

Countershaft

1995-1990	(R154)	
	Cylindrical Bearing (Frt)	MSN5305GTBV[2] ²⁵

Rear Output Shaft

2002-1995	(W55, W56, G58, W58, W59)	
	Seal	223840
2002-1990	(R150, R150F, R151F, R154)	
	Seal	3459S
1994-1990	(G50, G52, G53, G54, G57, G58, G59, W50, W52, W55, W56, W58)	
	Seal	710319

Selector Shaft Seal/Man. Shaft

2003-1996		
	Seal	1015N

4-SPEED AUTOMATIC TRANSAXLE**Torque Converter / Frt Pump**

2002-1996		
	Seal	223830
	Repair Sleeve	KWK99147

Input Shaft

2002-1996	(A240E, A241E)	
	Seal	710138
	Repair Sleeve	KWK99139

Output Shaft

2008-2001	(U241E)	
	Seal	223540[2]
	Repair Sleeve	KWK99139[2]
2008-2000	(A540E)	
	Seal (LH)	710112
	Seal (RH)	712551
2002-1996	(A241E, A247E, A540E)	
	Seal (LH)	710109
	Seal (RH)	710110
2002-1996	(A540E, A540H)	
	Seal (LH)	712551
	Seal (RH)	710112

²⁵New Item, Check For Availability

Mfg./Year	Model & Location	Part No.	Mfg./Year	Model & Location	Part No.
TOYOTA TRUCK - Minivan, SUV, Truck - FJ Cruiser, Highlander, Landcruiser, Pickup, Previa, RAV4, Sequoia, Sienna, Tacoma, Tundra, T100, 4Runner (cont.)					

4-SPEED AUTOMATIC TRANSAXLE

Manual Shaft

2008-1996	
Seal	221207
Repair Sleeve	KWK99049

5-SPEED AUTOMATIC TRANSAXLE

Manual Shaft

2008-2005	(U151E, U151F)
Seal	221207
Repair Sleeve	KWK99049

5-SPEED MANUAL TRANSAXLE

Transaxle Rebuild Kit

2003-1996	E250
Kit	TRKFT410

DRIVESHAFT SUPPORT

2003-2000	Tundra (4WD)
Hanger Bearing Assy	HB26[2]
2003-1995	Tacoma (RWD)
Hanger Bearing Assy	HB26
2002-1995	Tacoma (PreRunner, 4WD)
Hanger Bearing Assy	HB31
1998-1993	T100 (2WD)
Hanger Bearing Assy	HB26[2]
1998-1993	T100 (4WD)
Hanger Bearing Assy	HB28[2]
1995-1990	Pickup, 4Runner (4WD)
Hanger Bearing Assy	HB24[2]
1995-1990	Pickup, 4Runner (RWD)
Hanger Bearing Assy	
(1 Ton)	HB27
Hanger Bearing Assy	
(1/2 Ton)	HB9

POWER STEERING

Pump Shaft

2002-1998	Land Cruiser, Sienna
Seal	710412
2001-1996	Tacoma, T100, 4Runner (L4 Eng)
Seal	710251
2001-1996	Tacoma, T100, 4Runner (V6 Eng)
Seal	710412
2000-1996	RAV4
Seal	710156
1997-1991	Previa
Seal	710251
1995	4Runner
Seal	710156
1995-1993	Tacoma, T100 (L4 Eng)
Seal	710251
1995-1993	Tacoma, T100 (V6 Eng)
Seal	710412
1994-1990	Land Cruiser, Pickup, 4Runner
Seal	710156

Sector Shaft

1991-1990	Pickup
Seal	223400
1991-1990	Land Cruiser
Seal	223210

Worm Shaft

2000-1996	RAV4
Seal (Lower)	710155
Seal (Upper)	710154

MANUAL STEERING

Pitman Shaft

1997-1993	Tacoma, T100
Seal	221510
1991-1990	Land Cruiser, Pickup, 4Runner
Seal	710343

Sector Shaft

1991-1990	4Runner
Seal	223400
1991-1990	Pickup
Seal	223400

OIL PUMP

6 Cylinder

2008-1998	2995cc/3.0L, 3311cc/3.3L 3378cc/3.4L
Seal	224020
Repair Sleeve	KWK99157

8 Cylinder

2008-1998	4664cc/4.7L
Seal	224020

CAMSHAFT SEAL

4 Cylinder

2003-1996	1998cc/2.0L (DOHC)
Seal	1987S
Repair Sleeve	KWK99139

6 Cylinder

2006-1996	2995cc/3.0L, 3311cc/3.3L 3378cc/3.4L
Seal	223802
Repair Sleeve	KWK99147
1995-1990	2958cc/3.0L
Seal	224205

8 Cylinder

2006-1998	4664cc/4.7L
Seal	223801
Repair Sleeve	KWK99147

Mfg./Year	Model & Location	Part No.	Mfg./Year	Model & Location	Part No.
-----------	------------------	----------	-----------	------------------	----------

TOYOTA TRUCK - Minivan, SUV, Truck - FJ Cruiser, Highlander, Landcruiser, Pickup, Previa, RAV4, Sequoia, Sienna, Tacoma, Tundra, T100, 4Runner (cont.)

CRANKSHAFT FRONT SEAL

4 Cylinder

2008-1996	1998cc/2.0L, 2362cc/2.4L (DOHC)	
	Seal Viton	2025
	Repair Sleeve	KWK99166
2008-1991	2438cc/2.4L, 2694cc/2.7L	
	Seal	224840
	Repair Sleeve	KWK99189
2003-2001	2398cc/2.4L	
	Seal	223802
1995-1990	2366cc/2.4L	
	Seal	710345
	Repair Sleeve	KWK99177
1990	2237cc / 2.2L (4YEC)	
	Seal Viton	2025
	Repair Sleeve	KWK99169

6 Cylinder

2007-2006	3955cc/4.0L	
	Seal	710472
2006-2004	3300cc/3.3L	
	Seal	224020
2004-1990	2958cc/3.0L, 3378cc/3.4L	
	Seal	224020
	Repair Sleeve	KWK99157
1997-1993	4477cc/4.5L	
	Seal	710187
1992-1990	3955cc/4.0L, 4230cc/4.2l	
	Seal	710345
	Repair Sleeve	KWK99177

8 Cylinder

2006-2000	285/4.7L	
	Seal	224020

CRANKSHAFT REAR SEAL

4 Cylinder

2008-2001	2362cc/2.4L	
	Seal Viton	710189
2008-1991	2438cc/2.4L, 2694cc/2.7L	
	Seal Viton	710188
2003-2001	1998cc/2.0L	
	Seal Viton	710189
2000-1996	1998cc/2.0L	
	Seal	716102

CRANKSHAFT REAR SEAL (cont.)

4 Cylinder (cont.)

1995-1990	1858cc/1.9L, 1968cc/2.0L, 2189cc/2.2L, 2237cc/2.2L, 2366cc/2.4L	
	Seal	228010
	Repair Sleeve	KWK99315

6 Cylinder

2008-2004	3300cc/3.3L	
	Seal Viton	229210
2004-1990	2958cc/3.0L, 2995cc/3.0L, 3378cc/3.4L	
	Seal Viton	229210
	Repair Sleeve	KWK99360
1997-1993	4476cc/4.5L	
	Seal	231004
1992-1990	3955cc/4.0L	
	Seal	231052 ¹⁶
	Repair Sleeve	KWK99413

8 Cylinder

2008-1998	4664cc/4.7L	
	Seal Viton	710352
	Repair Sleeve	KWK99364

VOLKSWAGEN - Cabrio, Cabriolet, Corrado, EOS, Fox, Golf, GTI, Jetta, New Beetle, Passat, R32, Rabbit

FRONT WHEEL

FWD

2009-2008	R32	
	Hub Unit Bearing	513262[2] ²⁵
2009-2007	EOS	
	Hub Unit Bearing	513262[2] ²⁵

FRONT WHEEL (cont.)

FWD (cont.)

2009-2006	Jetta	
	Hub Unit Bearing (From 1/2005)	HA590106[2] ²⁵

¹⁶Obsolete

²⁵New Item, Check For Availability

Mfg./Year	Model & Location	Part No.	Mfg./Year	Model & Location	Part No.
VOLKSWAGEN - Cabrio, Cabriolet, Corrado, EOS, Fox, Golf, GTI, Jetta, New Beetle, Passat, R32, Rabbit (cont.)					

FRONT WHEEL (cont.)

FWD (cont.)

2009-2006 Rabbit / GTI	
Hub Unit Bearing	513262[2] ²⁵
Ball Bearing Optional	510003[2]
2009-2005 Passat	
Hub Unit Bearing	HA590106[2] ²⁵
2008-1998 New Beetle	
Ball Bearing	510003[2]
2005-2000 Golf	
Ball Bearing	510003[2]
2005-1999 Jetta	
Ball Bearing (Thru 12/2004)	510003[2]
2004-1998 Passat (4 Cyl.)	
Ball Bearing	510020[2]
2004-1998 Passat (6 Cyl.)	
Ball Bearing	510019[2]
2002-1995 Cabrio	
Ball Bearing	510004[2]
1999-1995 Golf (4 Cyl.)	
Ball Bearing	510003[2]
1999-1995 Golf (6 Cyl.)	
Ball Bearing	510004[2]
1998-1990 Jetta (From 8/1987)(Ch. # J010565)	
Ball Bearing	510004[2]
1997-1990 Passat	
Ball Bearing	510004[2]
1994-1990 Corrado	
Ball Bearing	510004[2]
1994-1990 Golf, GTI (From Ch. # 17J013200)	
Ball Bearing	510004[2]
1993-1990 Fox	
Set	SET39[2]
1993-1990 Cabriolet	
Set	SET35[2]

AWD

2008-2005 Passat	
Hub Unit Bearing	HA590106[2] ²⁵
2004 Golf	
Ball Bearing	510003[2]
2004-2000 Passat (6 Cyl.)	
Ball Bearing	510019[2]

REAR WHEEL

FWD

2009-2007 EOS	
Hub Unit Bearing	HA590159[2] ²⁵
2009-2006 Jetta	
Hub Unit Bearing	512319[2] ²⁵
2009-2006 Passat	
Hub Unit Bearing	512319[2] ²⁵
2009-2006 Rabbit / GTI	
Hub Unit Bearing (VIN Code J)	512012[2]
Hub Unit Bearing (VIN Code K)	HA590159[2] ²⁵

REAR WHEEL (cont.)

FWD (cont.)

2008-1998 New Beetle	
Hub Unit Bearing	512012[2]
2005 Golf	
Hub Unit Bearing	512012[2]
2005-1999 Jetta	
Hub Unit Bearing	512012[2]
2004 Golf (Exc. R32)	
Hub Unit Bearing	512012[2]
2004 Golf (R32)	
Ball Bearing	510003[2]
2004-1998 Passat	
Hub Unit Bearing	512187[2]
2003-1999 Golf	
Hub Unit Bearing	512012[2]
2002-1995 Cabrio	
Seal (Inner)	1962[2]
Set (Outer)	SET1[2]
Set	SET8[2]
1998 Golf, Jetta	
Seal (Inner)	1962
Set (Outer)	SET1[2]
Set	SET8[2]
1997-1990 (Exc. Fox & Synchro Models)	
Seal (Inner)	1962[2]
Set (Inner)	SET8[2]
Set (Outer)	SET1[2]
1993-1990 Fox	
Seal (Inner)	1174S[2]
Set (Inner)	SET8[2]
Set (Outer)	SET1[2]

AWD

2009-2008 R32	
Hub Unit Bearing	HA590106[2] ²⁵
2008-2006 Passat	
Hub Unit Bearing	HA590106[2] ²⁵
2004 Golf	
Ball Bearing	510003[2]
2000 Passat	
Ball Bearing	510019[2]

REAR AXLE

Differential

2002-2001 Passat (AWD)	
Seal (RH)	224520
Cone/Cup (LH)	LM300849-LM300811
Set (RH)	SET45
Repair Sleeve	KWK99177

Pinion

2002-2001 Passat (AWD)	
Cone/Cup (Inner)	HM801346X-HM801310
Cone/Cup (Outer)	M88048-M88010
1993-1990 Fox	
Seal (Front Audi 089)	222535
Seal (Rear Audi 089)	239146

²⁵New Item, Check For Availability

Mfg./Year	Model & Location	Part No.	Mfg./Year	Model & Location	Part No.
VOLKSWAGEN - Cabrio, Cabriolet, Corrado, EOS, Fox, Golf, GTI, Jetta, New Beetle, Passat, R32, Rabbit (cont.)					

REAR AXLE (cont.)**Pinion (cont.)**

1992-1990 (Cabriolet, Jetta, Rabbit, Golf)	
Seal (Rear VW 010)	1174S
Seal (Front VW 010)	223010

CLUTCH - 4 CYLINDER**Pilot Bearing**

2002-1990	
Ndle Bearing	F85265

CLUTCH - 6 CYLINDER**Pilot Bearing**

2002-1998	
Bearing Only	F212285

CLUTCH**Release Bearing**

2002	4 Cyl. 1.8 (220mm Cl.)	
Bearing Assy		614111
2002-2001	4 Cyl. 1.9 (220mm Cl.)	
Bearing Assy		614111
2002-1998	4 Cyl. 1.8 (DOHC)(215mm Cl.)	
Bearing Assy		614111
2002-1998	4 Cyl. 1.8 (DOHC)(228mm Cl.)	
Bearing Assy		614073
2002-1998	4 Cyl. 1.9 (215mm Cl.)	
Bearing Assy		614111
2002-1998	4 Cyl. 2.0 (215mm Cl.)	
Bearing Assy		614111
2002-1993	4 Cyl. 2.0 (210mm Cl.)	
Bearing Assy		614041
2002-1992	6 Cyl. 2.8 (DOHC)(VR6)(228mm Cl.)	
Bearing Assy		614111
1998	4 Cyl. 1.9 (228mm Cl.)	
Bearing Assy		614073
1993-1990	4 Cyl. 2.0 (DOHC)(228mm Cl.)	
Bearing Assy		614111
1993-1990	4 Cyl. 1.8 (210mm Cl.)(VW014)	
Bearing Assy		614015
1992-1990	4 Cyl. 1.8 (SOHC)(228mm Cl.)	
Bearing Assy		614111
1992-1990	4 Cyl. 1.6 (Diesel)(210mm Cl.)	
Bearing Assy		614041
1992-1990	4 Cyl. 1.8 (210mm Cl.)(w/o VW014)	
Bearing Assy		614041
1992-1990	4 Cyl. 2.0 (DOHC)(210mm Cl.)	
Bearing Assy		614041
1992-1990	4 Cyl. 1.8 (DOHC)(210mm Cl.)	
Bearing Assy		614041
1992-1990	Fox (4 Spd.)	
Bearing Only		VW1339C
1991-1990	4 Cyl. 2.0 (228mm Cl.)	
Bearing Assy		614015

5-SPEED MANUAL TRANSMISSION**Selector Shaft Seal/Man. Shaft**

2005-1995	
Seal	221820

3-SPEED AUTOMATIC TRANSAXLE**Torque Converter**

1997-1990	
Seal	3083
Repair Sleeve	KWK99169

Output Shaft

2005-1998 (01V)	
Seal	223510[2]
Repair Sleeve	KWK99139[2]
1993-1990 (087, 089)	
Seal	224520[2]
Repair Sleeve	KWK99177[2]
1992-1990 (010)	
Seal	225010[2]
Repair Sleeve	KWK99196[2]

4-SPEED AUTOMATIC TRANSAXLE**Differential**

2002-1993 (096)	
Cone/Cup	LM29749-LM29710[2]
1997-1993 (097)	
Cone/Cup	LM503349A-LM503310[2]
1997-1990 (095)	
Cone/Cup (LH)	LM300849-LM300811[2]

Torque Converter / Frt Pump

2002-1990 (095, 096)	
Seal	225110
Repair Sleeve	KWK99177
1997-1990 (010, 087, 089, 089E)	
Seal	3083
Repair Sleeve	KWK99169

Output Shaft

1997-1990 (095)	
Seal	225010[2]
Repair Sleeve	KWK99196[2]

Pinion

1997-1993 (097)	
Cone/Cup (Frt)	LM29749-LM29710
Bearing Assy (Rr)	513185

5-SPEED AUTOMATIC TRANSAXLE**Torque Converter**

2002-1998 (ZF5HP19)	
Seal	224052
Repair Sleeve	KWK99157

Mfg./Year Model & Location Part No. Mfg./Year Model & Location Part No.

VOLKSWAGEN - Cabrio, Cabriolet, Corrado, EOS, Fox, Golf, GTI, Jetta, New Beetle, Passat, R32, Rabbit (cont.)

4-SPEED MANUAL TRANSAXLE

Differential

2002-1990 (020)
 Cone/Cup LM29749-LM29710[2]
 1993-1990 (014)
 Cone/Cup LM300849-LM300811[2]

Input Shaft

2002-1990 (020)
 Seal 222240
 Repair Sleeve KWK99085
 1993-1990 (014)
 Seal 222030
 Repair Sleeve KWK99078

Mainshaft

2002-1990 (020)
 Set (RH) SET8[2]

Output Shaft

2002-1990 (020)
 Seal Viton 1965[2]
 Repair Sleeve KWK99146[2]
 1993-1990 (014)
 Seal 224052[2]
 Repair Sleeve KWK99157[2]

Selector Shaft Seal/Man. Shaft

2002-1990 (020)
 Seal 221820

5-SPEED MANUAL TRANSAXLE

Differential

2002-1998 (01A, 012)
 Set (LH) SET45[2]
 Cone/Cup (RH) LM300849-LM300811[2]
 2002-1990 (02A, 02J)
 Cone/Cup LM300849-LM300811[2]

Input Shaft

2002-1990 (01A, 012, 093)
 Seal 222540
 Repair Sleeve KWK99098

Output Shaft

2005-1990 (01A, 012, 093)
 Seal 224520[2]
 Repair Sleeve KWK99177[2]
 2002-1998 (02J)
 Seal 1181[2]
 Repair Sleeve KWK99189[2]
 1998-1990 (02A)
 Seal 710147[2]
 Repair Sleeve KWK99157[2]

CAMSHAFT SEAL

4 Cylinder

2002-1990
 Seal 3476S[2]
 Repair Sleeve KWK99128[2]

6 Cylinder

2002-1998 2771cc/2.8L
 Seal 3476S[2]
 Repair Sleeve KWK99128[2]
 2002-1992 2792cc/2.8L (DOHC)
 Seal 3476S[4]
 Repair Sleeve KWK99128[4]

CRANKSHAFT FRONT SEAL

4 Cylinder

2006-1990 1781cc/1.8L, 1896cc/1.9L,
 1984cc/2.0L
 Seal 3476S
 Repair Sleeve KWK99128

6 Cylinder

2005-1992 2771cc/2.8L, 2792cc/2.8L
 (DOHC)
 Seal Viton 1108
 Repair Sleeve KWK99139

CRANKSHAFT REAR SEAL

4 Cylinder

2006-1993 1.9L Diesel
 Seal 716102
 2005-2004 2.0L Diesel
 Seal 716102
 2005-2003 2.0L Gas
 Seal 716102
 2005-1990 1.8L (DOHC)
 Seal 716102
 Repair Sleeve KWK99333

6 Cylinder

2005-1992 2771cc/2.8L, 2792cc/2.8L
 (DOHC)
 Seal 716102
 Repair Sleeve KWK99333

8 Cylinder

2004-2002 4.0L
 Seal 716102

Mfg./Year	Model & Location	Part No.	Mfg./Year	Model & Location	Part No.
-----------	------------------	----------	-----------	------------------	----------

VOLKSWAGEN - Phaeton**FRONT WHEEL****4WD**

2006-2004

Bearing ModuleBM500012[2]²⁵**REAR WHEEL****4WD**

2006-2004

Bearing ModuleBM500012[2]²⁵**6-SPEED AUTOMATIC TRANSAXLE****Torque Converter**

2006-2004

Seal 224510

Repair SleeveKWK99177

Output Shaft

2006-2004 (09L)

Seal 223510[2]

Repair SleeveKWK99139[2]

CRANKSHAFT FRONT SEAL**8 Cylinder**

2005-2004 4172cc/4.2L

Seal Viton 1108

Repair SleeveKWK99139

CRANKSHAFT REAR SEAL**8 Cylinder**

2006-2004 4.2L

Seal 716102

VOLKSWAGEN - EuroVan, Transporter, Van, Vanagon**FRONT WHEEL****FWD**

2003-1998 EuroVan

Ball Bearing 510051[2]

1991-1990 Vanagon

Seal (Inner) 225500[2]

Cone/Cup (Inner) LM300849-LM300811[2]

Set (Outer) SET12[2]

4WD

1991-1990 Vanagon

Seal 226515[2]

Ball Bearing 513180[2]

REAR WHEEL**RWD**

2003-1992 EuroVan

Ball Bearing 510051[2]

1991-1990

Seal 1208S[2]

Ball Bearing (Outer) RW111[2]

Ball Bearing (Inner) 207[2]

CLUTCH**Release Bearing**

1991-1990 4 Cyl. 2.0 (228mm Cl.)

Bearing Assy 614015

3-SPEED AUTOMATIC TRANSAXLE**Differential**

1991-1990 (003, 090)

Cone/Cup LM300849-LM300811[2]

Torque Converter

1991-1990 (003, 090)

Seal 3051N

Repair SleeveKWK99169

Output Shaft

1991-1990 (003, 090)

Seal 224520[2]

Repair SleeveKWK99177[2]

Pinion

1991-1990 (003, 090)

Cone/Cup M86649-M86610[2]

Seal (Rr) 239146

Seal (Frt) 223010

Repair SleeveKWK99114

4-SPEED AUTOMATIC TRANSAXLE**Torque Converter / Frt Pump**

2003-1993 (098, 01P)

Seal 225110

²⁵New Item, Check For Availability

Mfg./Year Model & Location Part No. Mfg./Year Model & Location Part No.

VOLKSWAGEN - EuroVan, Transporter, Van, Vanagon (cont.)

4-SPEED AUTOMATIC TRANSAXLE

Output Shaft

2003-1993 (098, 01P)
Seal 224520[2]

5-SPEED MANUAL TRANSAXLE

Differential

1991-1990 (094)
Bearing Assy 32010X[2]

Input Shaft

1991-1990 (094)
Seal 222050
Repair Sleeve KWK99085

Output Shaft

1991-1990 (094)
Seal 1943[2]
Repair Sleeve KWK99177[2]

DRIVESHAFT SUPPORT

1991-1990 Vanagon
Ball Bearing (Frt) 107WB[2]
Ball Bearing (Rr) 206WB[2]

CAMSHAFT SEAL

4 Cylinder

1991-1990 1.5L, 1.6L, 1.7L (Incl. Diesels),
2.0L
Seal 3476S
Repair Sleeve KWK99128

5 Cylinder

1996-1992 2.5L
Seal 3476S
Repair Sleeve KWK99128

6 Cylinder

2002-1997 2.8L
Seal 3476S[2]
Repair Sleeve KWK99128[2]

CRANKSHAFT FRONT SEAL

5 Cylinder

1996-1992 2.5L
Seal Viton 1108
Repair Sleeve KWK99139

CRANKSHAFT FRONT SEAL

6 Cylinder

2003-1997 2.8L
Seal Viton 1108
Repair Sleeve KWK99139

CRANKSHAFT REAR SEAL

4 Cylinder

1991-1990 1.8L, 1.9L, 2.0L, 2.1L
Seal 227530
Repair Sleeve KWK99294

6 Cylinder

2003-1997 2.8L
Seal 716102
Repair Sleeve KWK99333

Mfg./Year	Model & Location	Part No.	Mfg./Year	Model & Location	Part No.
-----------	------------------	----------	-----------	------------------	----------

VOLKSWAGEN - SUV - Touareg**FRONT WHEEL****AWD**

2006-2004

Ball Bearing 510082[2]²⁵**REAR WHEEL****AWD**

2006-2004

Ball Bearing 510082[2]²⁵**CRANKSHAFT FRONT SEAL****8 Cylinder**

2007-2004 4172cc/4.2L

Seal Viton 1108

Repair Sleeve KWK99139

CRANKSHAFT REAR SEAL**8 Cylinder**

2007-2005 4.2L

Seal 716102

VOLVO - ALL**FRONT WHEEL****FWD**

2009-2008 C30

Hub Unit Bearing HA590212[2]²⁵

2009-2008 V70

Hub Unit Bearing HA590234[2]²⁵

2009-2007 S80

Hub Unit Bearing HA590234[2]²⁵

2009-2006 C70

Hub Unit Bearing HA590323[2]²⁵

2009-2006 S60

Hub Unit Bearing HA590187[2]²⁵

2009-2005 V50

Hub Unit Bearing HA590212[2]²⁵

2009-2004 S40 (New Style)

Hub Unit Bearing HA590323[2]²⁵

2007-2000 V70

Hub Unit Bearing 513175[2]

2005-1999 S60, S80 Ser.

Hub Unit Bearing 513194[2]

2004-2000 S40, V40 (Old Style)

Ball Bearing 510029[2]

2004-1999 C70, S70, Ser.

Hub Unit Bearing 513175[2]

1998 C70, S70, V70

Hub Unit Bearing HA594181[2]

1997-1994 850

Hub Unit Bearing HA594181[2]

1993 850

Hub Unit Bearing HA595894[2]

RWD

1998-1994 960 Ser., S90, V90

Hub Unit Bearing HA590241K[2]

1995-1991 940 (Non-ABS)

Hub Unit Bearing 513128[2]

1994-1990 760, 780, 940 Ser. (ABS)

Hub Unit Bearing HA590056K[2]⁷¹**FRONT WHEEL (cont.)****RWD (cont.)**

1993-1990 240, 260 Ser.

Seal (Inner) 482126[2]

Set (Inner) SET17[2]

Set (Outer) SET16[2]

1992-1991 740 (Non-ABS)

Hub Unit Bearing 513128[2]

1991-1990 780 (Non-ABS)

Hub Unit Bearing 513128[2]

1990 740 Ser.

Seal (Inner) 710215[2]

Set (Inner) SET17[2]

Set (Outer) SET16[2]

1990 760 (Non-ABS)

Hub Unit Bearing 513128[2]

AWD

2009-2008 XC70

Hub Unit Bearing HA590234[2]²⁵

2009-2007 S80

Hub Unit Bearing HA590234[2]²⁵

2009-2006 S60

Hub Unit Bearing HA590187[2]²⁵

2009-2005 S40 (New Style)

Hub Unit Bearing HA590323[2]²⁵

2009-2005 V50

Hub Unit Bearing HA590323[2]²⁵

2007-2000 V70, XC70

Hub Unit Bearing 513194[2]

2005-2004 S60, S80 Ser.

Hub Unit Bearing 513194[2]

2000-1999 V70

Hub Unit Bearing 513175[2]

1998 V70

Hub Unit Bearing HA594181[2]

1997 850

Hub Unit Bearing HA594181[2]

²⁵New Item, Check For Availability⁷¹Kit = Brg, 48 Tooth Ring, Dust Cap, & Nut

Mfg./Year	Model & Location	Part No.	Mfg./Year	Model & Location	Part No.
-----------	------------------	----------	-----------	------------------	----------

VOLVO - ALL (cont.)

REAR WHEEL

FWD

2009	C70	
Hub Unit Bearing	HA590322[2] ²⁵
2009	S40 (New Style)	
Hub Unit Bearing	HA590322[2] ²⁵
2009	V50	
Hub Unit Bearing	HA590322[2] ²⁵
2009-2008	C30	
Hub Unit Bearing	HA590192[2] ²⁵
2009-2008	V70	
Hub Unit Bearing	HA590337[2]
2009-2007	S80	
Hub Unit Bearing	HA590337[2]
2009-2001	S60	
Hub Unit Bearing	HA590389[2]
2008-2006	C70	
Hub Unit Bearing	HA590192[2] ²⁵
2008-2005	V50	
Hub Unit Bearing	HA590192[2] ²⁵
2008-2004	S40 (New Style)	
Hub Unit Bearing	HA590192[2] ²⁵
2006-1999	S80	
Hub Unit Bearing	HA590389[2]
2004-2001	C70	
Hub Unit Bearing	HA597957[2]
2003-2000	S40, V40 (Old Style)	
Hub Unit Bearing	HA590257[2]
2000-1993	C70, S70, Ser.	
Hub Unit Bearing	HA597957[2]
1997-1993	850	
Hub Unit Bearing	HA597957[2]

RWD

1998	S90, V90	
Hub Unit Bearing	512234[2] ¹⁶
Ball Bearing	513130[2]
1997-1995	960 Ser.	
Hub Unit Bearing	512234[2] ¹⁶
Ball Bearing	513130[2]
1995	940 Ser.	
Ball Bearing	513130[2]
1994-1991	940 Ser., 960 Ser.	
Seal	473238[2]
Cylindrical Bearing	RW131R[2]
1993-1990	240 Ser.	
Seal (Inner)	1955[2]
Seal (Outer)	9912S[2]
1992-1990	740 (Exc. Traction Control)	
Seal (Inner)	1176S[2]
Seal (Outer)	9912S[2]
1992-1990	740 Ser. (Traction Control)	
Seal (Inner)	1955[2]
Seal (Outer)	9912S[2]
1990	760	
Ball Bearing	513130[2]

AWD

2009-2008	XC70	
Hub Unit Bearing	HA590220[2] ²⁵
2009-2005	S40 (New Style)	
Hub Unit Bearing	HA590321[2] ²⁵

REAR WHEEL (cont.)

AWD (cont.)

2009-2005	V50	
Hub Unit Bearing	HA590321[2] ²⁵
2009-2002	S60	
Hub Unit Bearing	HA590218[2] ²⁵
2007	S80	
Hub Unit Bearing	HA590220[2] ²⁵
2007-2001	V70	
Hub Unit Bearing	HA590218[2] ²⁵
2006-2004	S80	
Hub Unit Bearing	HA590218[2] ²⁵
2000-1997	S70, V70, 850	
Ball Bearing	513130[2]

REAR AXLE

Differential Rebuild Kit

1993-1990	(1030 Axle)	
Kit	DRK338

Differential

1997-1990	(1045 Axle)	
Set	SET45[2]
1997-1990	(Exc. 1045 Axle)	
Cone/Cup	LM501349-LM501314[2]

Pinion

2001-1999	(AWD)	
Seal Viton	4941V
1998-1990		
Seal (All)	5778
Cone/Cup (Inner)	(Dana/Spicer M27, M30, 1030)	HM88649-HM88610
Cone/Cup (Inner)	(1031, 1041, 1045 Axle)	HM89449-HM89410
Cone/Cup (Outer) (All)	M86647-M86610
Repair Sleeve (All)	KWK99155

CLUTCH - 4 CYLINDER

Pilot Bearing

1996-1990		
Ball Bearing	202FF

CLUTCH - 6 CYLINDER

Pilot Bearing

1997-1992		
Ball Bearing	202FF

CLUTCH - 4 CYLINDER

Release Bearing

1995-1990	240 Ser. 740 Ser. 940	
Bearing Assy	614039

¹⁶Obsolete ²⁵New Item, Check For Availability

Mfg./Year	Model & Location	Part No.	Mfg./Year	Model & Location	Part No.
-----------	------------------	----------	-----------	------------------	----------

VOLVO - ALL (cont.)**CLUTCH - 6 CYLINDER****Release Bearing**

1990 740 GLE, 760 GLE
Bearing Assy 614039

4-SPEED MANUAL TRANSMISSION**Input Shaft**

1996-1990 (M45)
Seal 222820
Ball Bearing 207SL[2]
Repair Sleeve KWK99111

Countershaft

1996-1990 (M45)
Set SET4[2]

Rear Output Shaft

1996-1990 (M45)
Seal 224010

5-SPEED MANUAL TRANSMISSION**Front Input Shaft**

1996-1990
Seal 222820
Repair Sleeve KWK99111

Countershaft

1996-1990
Set (Center) SET4[2]
Set (Rr) SET17[2]

Rear Output Shaft

1996-1990
Seal 1962

4-SPEED AUTOMATIC TRANSAXLE**Torque Converter / Frt Pump**

2006-1999 (4T65 E)
Seal 4072N
Repair Sleeve KWK99328
2002-1993 (Aisin)
Seal 223830
Repair Sleeve KWK99147

Output Shaft

2006-1999 (4T65 E)
Seal (LH) 100165
Seal (RH) 3543
Repair Sleeve KWK99139
2002-1993 (Aisin)
Seal (LH) 224025
Seal (RH) 710112

4-SPEED AUTOMATIC TRANSAXLE**Manual Shaft**

2006-1999 (4T65 E)
Seal 8792S
2004-1992 (Aisin)
Seal 221207
Repair Sleeve KWK99049

5-SPEED AUTOMATIC TRANSAXLE**Manual Shaft**

2008-2001 (Aisin 55-51SN)
Seal 221207
Repair Sleeve KWK99049

5-SPEED MANUAL TRANSMISSION**Input Shaft**

1997-1993
Bearing Assy (Inner) 32005X[2]
Bearing Assy (Outer) 32007X[2]

Output Shaft

1997-1993
Seal 224040[2]
Repair Sleeve KWK99157[2]

A/C COMPRESSOR

1990 (A6)(Axial)
Ball Bearing 907257[2]

ALTERNATOR

1992-1990 (Bosch 70 Amp.)
Ball Bearing (Drive End) 303CC
Ball Bearing (Rear End) 201CC
1990 (Bosch 90 Amp.)
Ball Bearing (Drive End) 303CC
Ball Bearing (Rear End) 201CC

DRIVESHAFT SUPPORT

1996-1994
Ball Bearing 109FF[2]
1993-1990 (Type 03 driveshaft)
Ball Bearing 109FF[2]
1993-1990 240 & 260 Ser. (45mm
driveshaft)
Ball Bearing 109FF[2]
1992-1990 (Type 03 driveshaft)
Ball Bearing 107DD[2]

MANUAL STEERING**Pitman Shaft**

1990 (Saginaw pump)
Seal 7013S

Mfg./Year Model & Location Part No. Mfg./Year Model & Location Part No.

VOLVO - ALL (cont.)

AUXILIARY SHAFT

4 Cylinder

2002-2000 1948cc/1.9L (DOHC)(Turbo)
 Seal 223020
 Repair Sleeve KWK99114
 1995-1990 1780cc/1.8L, 1990cc/2.0L,
 2127cc/2.1L, 2316cc/2.3L
 Seal 1172S
 Repair Sleeve KWK99139

CAMSHAFT SEAL

4 Cylinder

2002-2000 1948cc/1.9L (DOHC)(Turbo)
 Seal 321460
 Repair Sleeve KWK99179
 1996-1990 2127cc/2.1L, 2316cc/2.3L
 Seal 1172S
 Repair Sleeve KWK99139

5 Cylinder

2002-1993 2319cc/2.3L, 2435cc/2.4L
 Seal (Frt) 321460[2]
 Repair Sleeve (Frt) KWK99179[2]
 Seal (Rr) 223020[2]
 Repair Sleeve (Rr) KWK99114[2]

6 Cylinder

2002-1992 2922cc/2.9L (DOHC)
 Seal (Frt) 321460[2]
 Repair Sleeve (Frt) KWK99179[2]
 Seal (Rr) 223020[2]
 Repair Sleeve (Rr) KWK99114[2]

CRANKSHAFT FRONT SEAL

4 Cylinder

2004-2000 1948cc/1.9L
 Seal 223601
 Repair Sleeve KWK99146
 1996-1990 2127cc/2.1L, 2316cc/2.3L
 Seal Viton 710190
 1995-1994 2320cc/2.3L (SOHC)
 Seal Viton 710190

5 Cylinder

2008-1993 2319cc/2.3L, 2435cc/2.4L
 Seal 223601
 Repair Sleeve KWK99146

CRANKSHAFT FRONT SEAL

6 Cylinder

2005-1992 2917cc/2.9L (DOHC)
 Seal 223601
 Repair Sleeve KWK99146

CRANKSHAFT REAR SEAL

4 Cylinder

1996-1990 1780cc/1.8L, 1990cc/2.0L,
 2127cc/2.1L, 2316cc/2.3L
 Seal Viton 229210

5 Cylinder

2008-2005 2401cc/2.4 (DOHC),
 2435cc/2.4 (DOHC),
 2500cc/2.5 (DOHC)
 Seal Viton 229210

6 Cylinder

1990 2849cc/2.8L
 Seal 228010
 Repair Sleeve KWK99315

VOLVO - SUV - XC90

FRONT WHEEL

FWD

2009-2007 (From Ch. # 354877)
 Hub Unit Bearing HA590312[2]²⁵
 2007-2003 (Thru Ch. # 354876)
 Hub Unit Bearing HA590223[2]²⁵

FRONT WHEEL

AWD

2009-2007 (From Ch. # 354877)
 Hub Unit Bearing HA590312[2]²⁵
 2007-2003 (Thru Ch. # 354876)
 Hub Unit Bearing HA590223[2]²⁵

²⁵New Item, Check For Availability

Mfg./Year	Model & Location	Part No.	Mfg./Year	Model & Location	Part No.
-----------	------------------	----------	-----------	------------------	----------

VOLVO - SUV - XC90 (cont.)**REAR WHEEL****FWD**

2009-2006 (From Ch. # 254382)	
Hub Unit Bearing	HA590289[2] ²⁵
2006-2003 (Thru Ch. # 254381)	
Hub Unit Bearing	HA590218[2] ²⁵

AWD

2009-2003	
Hub Unit Bearing	HA590232[2] ²⁵

4-SPEED AUTOMATIC TRANSMISSION**Torque Converter**

2006-2003 (4T65 E)	
Seal	4072N

Selector Shaft Seal/Man. Shaft

2007-2003 (4T65 E)	
Seal	8792S

Output Shaft

2007-2003 (4T65 E)	
Seal (LH)	100165
Seal (RH)	3543
Repair Sleeve	KWK99139

5-SPEED AUTOMATIC TRANSMISSION**Torque Converter**

2007-2003 (Aisin 55-51SN)	
Seal	222830

5-SPEED AUTOMATIC TRANSMISSION**Selector Shaft Seal/Man. Shaft**

2007-2003 (Aisin 55-51SN)	
Seal	221207
Repair Sleeve	KWK99049

CRANKSHAFT FRONT SEAL**6 Cylinder**

2005-2003 2922cc/2.9L (DOHC)	
Seal	223601
Repair Sleeve	KWK99146

YUGO - ALL**FRONT WHEEL****FWD**

1992-1990	
Ball Bearing	513116[2]

REAR WHEEL**FWD**

1992-1990	
Ball Bearing	513116[2]

CLUTCH**Release Bearing**

1992-1990	
Bearing Only	FI1710C

5-SPEED MANUAL TRANSAXLE**Input Shaft**

1992-1990	
Seal	222240
Repair Sleeve	KWK99085

5-SPEED MANUAL TRANSAXLE**Output Shaft**

1992-1990	
Ball Bearing (Drive End)	203S[2]
Ball Bearing (Rear End)	201SS[2]
Seal	222510[2]
Repair Sleeve	KWK99098

ALTERNATOR

1992-1990	
Ball Bearing (Drive End)	203S
1992-1990	
Ball Bearing (Rear End)	201SS

CRANKSHAFT FRONT SEAL**4 Cylinder**

1992-1990	
Seal	224025
Repair Sleeve	KWK99157

²⁵New Item, Check For Availability

HUB UNIT BEARING / BEARING MODULE TECHNOLOGY SECTION

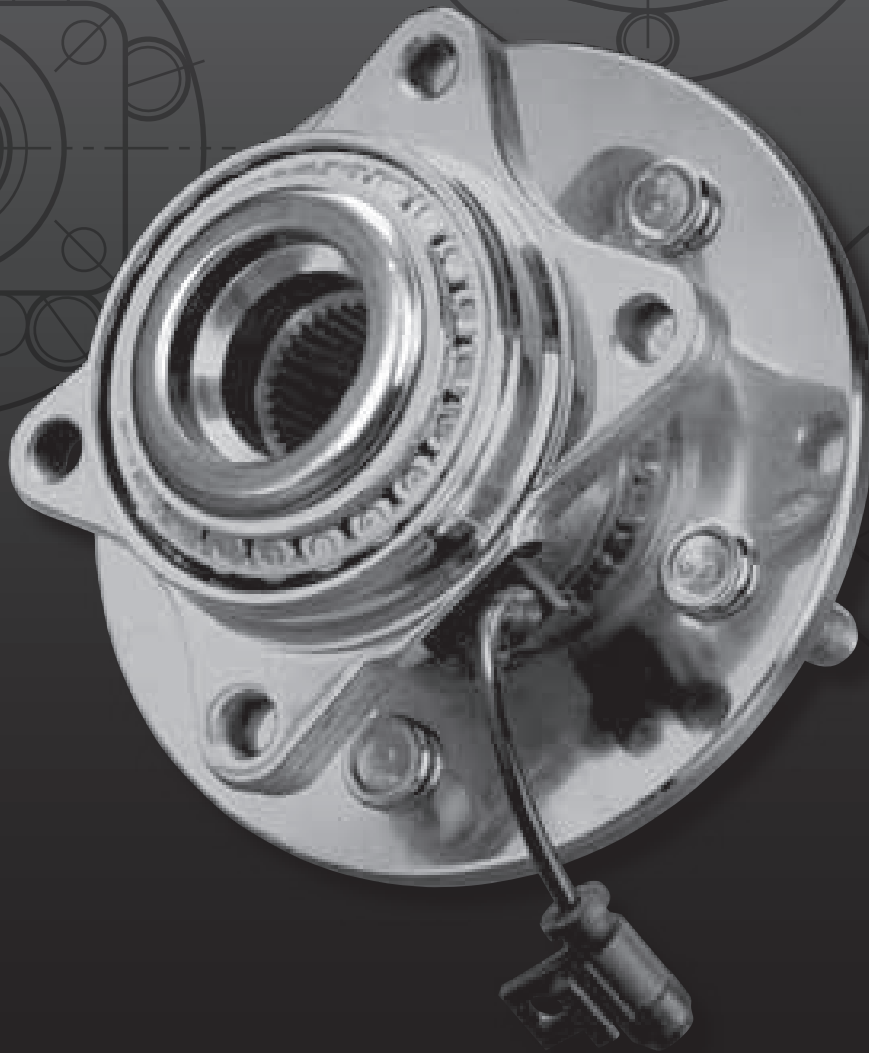

KEYS TO CHOOSING THE RIGHT HUB UNIT BEARING / BEARING MODULE

- 1)** Original design ensures appropriate application performance. A Gen 3 in an original Gen 2 design is not necessarily better.
- 2)** Gen 3 hub unit bearings have integral raceways on the hub and flanged bearing, not just the flanged bearing.
- 3)** Simply because a hub unit bearing contains an integral raceway does not make it a Gen 3. Some non-manufacturers market hub unit bearings as Gen 3 because they contain integral raceways when they actually contain the characteristics of Gen 1 and/or Gen 2 hub unit bearings.
- 4)** All wheel-end designs are driven at the concept or design stage of the OE process. Various generations are utilized including Gen 1, Gen 2 and Gen 3 designs. Not all generations are capable of converting to Gen 3.
- 5)** While there are Gen 3 hub unit bearings on rear wheels, most of them are utilized on the front wheels of passenger cars, light trucks, and SUVs.
- 6)** Most rear wheel applications still utilize Gen 1 and Gen 2 style hub unit bearings as well as cylindrical bearings.
- 7)** Even though a hub unit bearing looks like the original design and its external dimensions are the same, it does not mean the hub unit bearing will perform like the original. In the absence of industry standards, such product may not meet original equipment composition including steel grade (forgings, castings, wheel studs, etc.), heat-treat or internal geometry specifications. Can you trust the design of a non-manufacturer?
- 8)** Timken has chosen to utilize Gen 1 tapered bearing designs for some Gen 2 ball applications due to the increased capacity and enhanced performance of the tapered bearing.
- 9)** Tapered bearings and hub unit bearings have greater load and capacity ratings than like-size ball bearing alternatives.
- 10)** Tapered bearing designs can be used in ball applications but ball bearings can rarely be used in tapered designs due to capacity and performance requirements.

HUB UNIT BEARING GENERATIONS: BALL BEARING TYPE

GEN 1

Double-Row Angular Contact Bearing

Features:

- Pre-set internal clearance / pre-load
- Pre-lubricated
- Integrated seal – sealed for life
- Integral double outer race

Benefits:

- Eliminates pre-load adjustment at installation
- Minimizes axial space requirements
- Compact / reduced envelope dimension
- Maintenance free – self-contained
- Optimizes bearing life and rigidity within the available space



GEN 2

Single-Flange Angular Contact Bearing

Features:

- Pre-set internal clearance / pre-load
- Pre-lubricated
- Integrated seal – sealed for life
- Integral raceways in outer ring
- Flanged outer ring

Benefits:

- Easier installation
- Eliminates pre-load adjustment at assembly
- Minimizes axial space requirements
- Compact / reduced space
- Maintenance free – self-contained
- Optimizes bearing life and rigidity within the available space

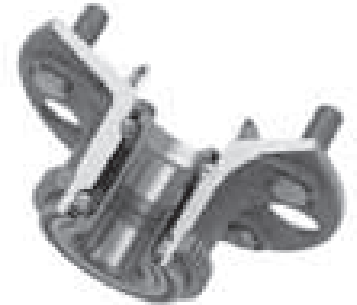

GEN 2

Double-Flange Angular Contact Bearing

Features:

- Pre-set internal clearance / pre-load
- Pre-lubricated
- Integrated seal – sealed for life
- Integral outer ring / raceways
- Flanged inner and outer rings

Benefits:

- Easier installation
- Eliminates pre-load adjustment at assembly
- Minimizes axial space requirements
- Compact / reduced space
- Maintenance free – self-contained
- Optimizes bearing life and rigidity within the available space



GEN 3

Double-Flange Angular Contact Bearing

Features:

- Pre-set internal clearance / pre-load
- Pre-lubricated
- Integrated seal – sealed for life
- Integral inner ring / outboard raceway
- Flanged inner and outer rings

Benefits:

- Easier installation
- Eliminates pre-load adjustment at assembly
- Minimizes axial space requirements
- Compact / reduced space
- Maintenance free – self-contained
- Optimizes bearing life and rigidity within the available space



HUB UNIT BEARING GENERATIONS: TAPERED ROLLER BEARING TYPE

GEN 1

Double-Row Tapered Bearing

Features:

- Pre-set internal clearance / pre-load
- Pre-lubricated
- Integrated seal – sealed for life
- Integral double cup



Benefits:

- Eliminates pre-load adjustment at installation
- Minimizes axial space requirements
- Compact / reduced envelope dimension
- Maintenance free – self-contained
- Optimizes bearing life and rigidity within the available space
- Greater load and capacity ratings than ball versions

GEN 2

Double-Flange Tapered Bearing

Features:

- Pre-set internal clearance / pre-load
- Pre-lubricated
- Integrated seal – sealed for life
- Integral raceways in flanged cup

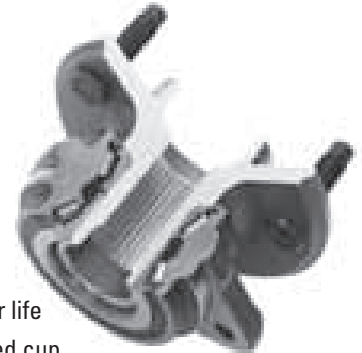

Benefits:

- Ease of installation – bolts direct to knuckle
- Eliminates pre-load adjustment at assembly
- Minimizes axial space requirements
- Compact / reduced space
- Maintenance free – self-contained
- Optimizes bearing life and rigidity within the available space
- Greater load and capacity ratings than ball versions

GEN 2.5

Double-Flange Tapered Bearing

Features:

- Pre-set internal clearance / pre-load
- Pre-lubricated
- Integrated seal – sealed for life
- Integral raceways in flanged cup
- FORMED HUB™ – patented technology



Benefits:

- Ease of installation – bolts direct to knuckle
- Eliminates pre-load adjustment at assembly
- Minimizes axial space requirements
- Compact / reduced space
- Pre-clamped / self-retained
- Maintenance free – self-contained
- Optimizes bearing life and rigidity within the available space
- Greater load and capacity ratings than ball versions

GEN 3

Double-Flange Tapered Bearing

Features:

- Pre-set internal clearance / pre-load
- Pre-lubricated
- Integrated seal – sealed for life
- Integral raceways in flanged cup
- Integral outboard raceway on hub
- Flanged inner and outer ring
- FORMED HUB™ – patented technology

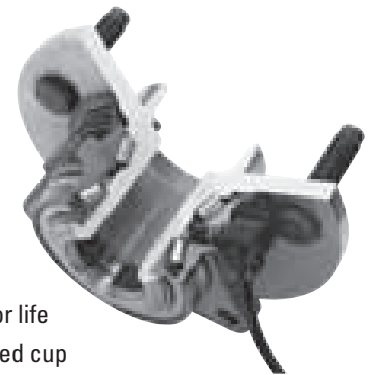

Benefits:

- Ease of installation – bolts direct to knuckle
- Eliminates pre-load adjustment at assembly
- Minimizes axial space requirements
- Pre-clamped / self-retained
- Compact / reduced space
- Maintenance free – self-contained
- Optimizes bearing life and rigidity within the available space
- Greater load and capacity ratings than ball versions

HUB UNIT BEARING / BEARING MODULE - CROSS REFERENCE

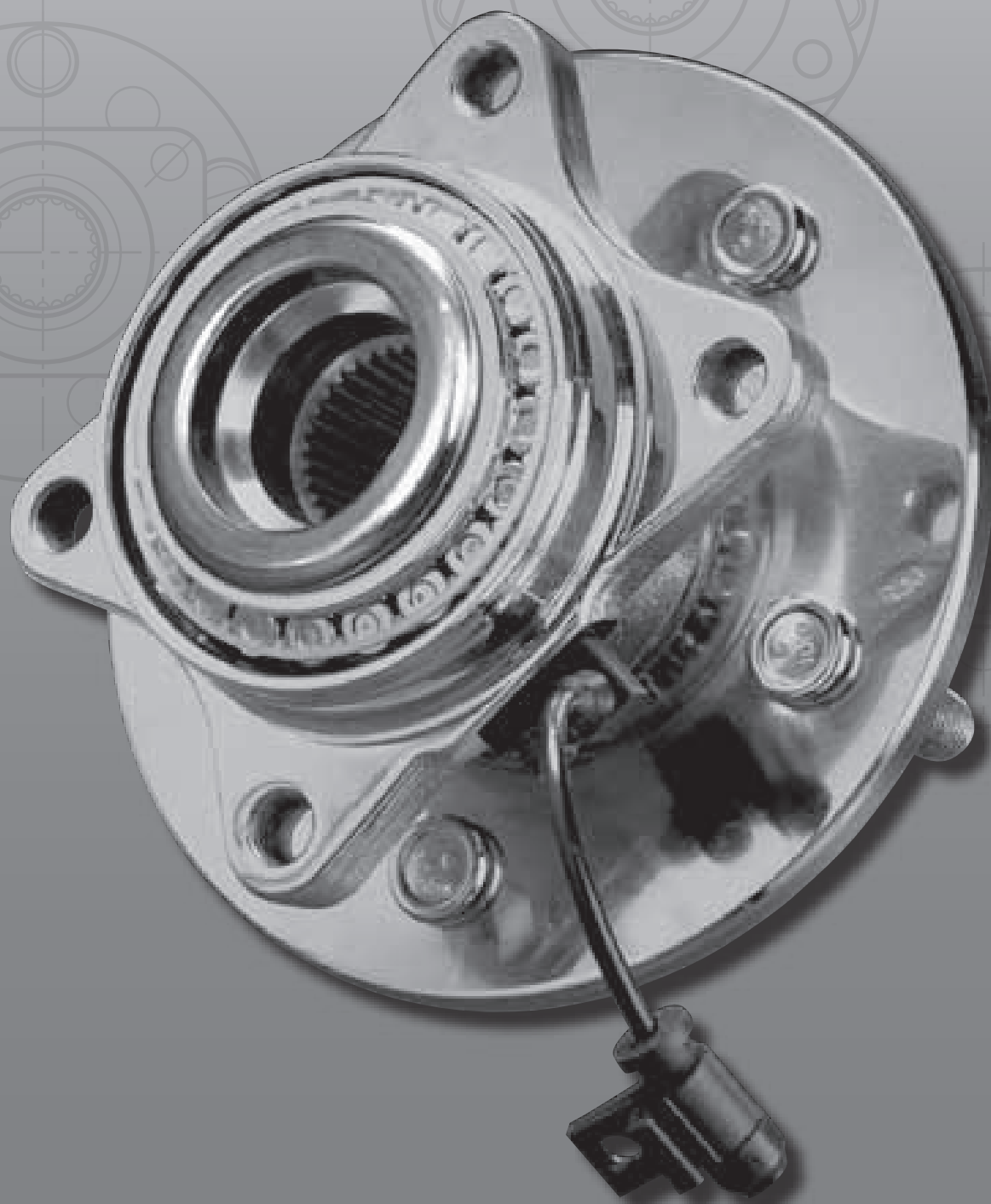

HUB UNIT BEARING / BEARING MODULE - CROSS REFERENCE - FM TO TIMKEN

HUB UNIT BEARING / BEARING MODULE TECHNOLOGY

Federal Mogul Number	Timken Number	Part Description
510038	510038	Bearing Module
511010	511010	Bearing Module
511011	511011	Bearing Module
511012	511012	Bearing Module
511037	HA590241	Hub Unit Bearing
511038	HA590235	Hub Unit Bearing
512000	512000	Hub Unit Bearing
512001	512001	Hub Unit Bearing
512002	512002	Hub Unit Bearing
512003	512003	Hub Unit Bearing
512004	512004	Hub Unit Bearing
512005	512005	Hub Unit Bearing
512006	512006	Hub Unit Bearing
512007	512007	Hub Unit Bearing
512008	512008	Hub Unit Bearing
512009	512009	Bearing Module
512010	512010	Hub Unit Bearing
512011	512011	Hub Unit Bearing
512012	512012	Hub Unit Bearing
512013	512013	Hub Unit Bearing
512014	512014	Bearing Module
512016	512016	Hub Unit Bearing
512017	512017	Hub Unit Bearing
512018	512018	Hub Unit Bearing
512019	512019	Hub Unit Bearing
512020	512020	Hub Unit Bearing
512021	512021	Hub Unit Bearing
512022	512022	Hub Unit Bearing
512023	512023	Hub Unit Bearing
512024	512024	Hub Unit Bearing
512025	512025	Hub Unit Bearing
512026	512026	Hub Unit Bearing
512027	512027	Hub Unit Bearing
512028	512028	Hub Unit Bearing
512029	512029	Hub Unit Bearing
512030	512029	Hub Unit Bearing
512030	512030	Hub Unit Bearing
512031	512031	Hub Unit Bearing
512032	512032	Hub Unit Bearing
512033	512033	Hub Unit Bearing
512034	513105	Hub Unit Bearing
512036	512036	Hub Unit Bearing

Federal Mogul Number	Timken Number	Part Description
512037	512037	Hub Unit Bearing
512038	512038	Bearing Module
512039	512039	Hub Unit Bearing
512040	512040	Hub Unit Bearing
512041	512041	Hub Unit Bearing
512078	512078	Hub Unit Bearing
512105	512105	Hub Unit Bearing
512106	512106	Hub Unit Bearing
512107	512107	Hub Unit Bearing
512118	512118	Hub Unit Bearing
512119	512119	Hub Unit Bearing
512120	512120	Hub Unit Bearing
512121	512121	Hub Unit Bearing
512122	512122	Hub Unit Bearing
512123	512123	Hub Unit Bearing
512124	512124	Hub Unit Bearing
512125	512125	Hub Unit Bearing
512133	512133	Hub Unit Bearing
512136	HA590306	Hub Unit Bearing
512137	512137	Bearing Module
512140	512140	Hub Unit Bearing
512144	512144	Hub Unit Bearing
512145	512145	Hub Unit Bearing
512146	512146	Hub Unit Bearing
512147	512147	Hub Unit Bearing
512148	512148	Hub Unit Bearing
512149	512149	Hub Unit Bearing
512150	512150	Hub Unit Bearing
512151	512151	Hub Unit Bearing
512152	512152	Hub Unit Bearing
512153	512153	Hub Unit Bearing
512154	512154	Hub Unit Bearing
512155	512155	Hub Unit Bearing
512156	512156	Hub Unit Bearing
512157	512157	Hub Unit Bearing
512158	512158	Hub Unit Bearing
512159	512159	Hub Unit Bearing
512160	512160	Hub Unit Bearing
512161	512161	Hub Unit Bearing
512162	512162	Hub Unit Bearing
512163	512163	Hub Unit Bearing
512164	512164	Hub Unit Bearing

Every reasonable effort has been made to ensure the accuracy of the information contained in this writing, but no liability is accepted for errors, omissions or for any other reason.

HUB UNIT BEARING / BEARING MODULE - CROSS REFERENCE - FM TO TIMKEN

continued

Federal Mogul Number	Timken Number	Part Description
512165	512165	Hub Unit Bearing
512166	512166	Bearing Module
512167	512167	Hub Unit Bearing
512168	512168	Hub Unit Bearing
512169	512169	Hub Unit Bearing
512170	512170	Hub Unit Bearing
512171	512171	Hub Unit Bearing
512172	512172	Hub Unit Bearing
512173	512173	Hub Unit Bearing
512174	512174	Hub Unit Bearing
512175	512175	Hub Unit Bearing
512176	512176	Hub Unit Bearing
512177	512177	Hub Unit Bearing
512178	512178	Hub Unit Bearing
512179	512179	Hub Unit Bearing
512180	512180	Hub Unit Bearing
512181	512181	Bearing Module
512182	512182	Hub Unit Bearing
512183	512183	Bearing Module
512184	512184	Hub Unit Bearing
512185	512185	Hub Unit Bearing
512186	512186	Hub Unit Bearing
512187	512187	Hub Unit Bearing
512188	512188	Hub Unit Bearing
512189	512189	Hub Unit Bearing
512190	512190	Hub Unit Bearing
512191	512191	Hub Unit Bearing
512192	512192	Hub Unit Bearing
512193	512193	Hub Unit Bearing
512194	512194	Hub Unit Bearing
512195	512195	Hub Unit Bearing
512196	512196	Hub Unit Bearing
512197	512197	Hub Unit Bearing
512198	512198	Hub Unit Bearing
512199	512199	Hub Unit Bearing
512200	512200	Hub Unit Bearing
512201	512201	Hub Unit Bearing
512202	512202	Hub Unit Bearing
512203	512203	Hub Unit Bearing
512204	512204	Hub Unit Bearing
512205	HA591050	Hub Unit Bearing
512206	HA592460	Hub Unit Bearing

Federal Mogul Number	Timken Number	Part Description
512207	HA592450	Hub Unit Bearing
512208	HA596030	Hub Unit Bearing
512209	HA594245	Hub Unit Bearing
512210	HA592410	Hub Unit Bearing
512211	HA594301	Hub Unit Bearing
512212	HA594504	Hub Unit Bearing
512213	HA594241	Hub Unit Bearing
512215	512215	Hub Unit Bearing
512216	512216	Hub Unit Bearing
512217	512217	Hub Unit Bearing
512218	512218	Hub Unit Bearing
512219	HA590057	Hub Unit Bearing
512220	512220	Hub Unit Bearing
512221	512221	Hub Unit Bearing
512222	512222	Hub Unit Bearing
512223	512223	Hub Unit Bearing
512225	512225	Hub Unit Bearing
512226	BM500010	Bearing Module
512227	HA594246	Bearing Module
512228	HA590050	Bearing Module
512229	512229	Hub Unit Bearing
512230	512230	Hub Unit Bearing
512231	512231	Hub Unit Bearing
512232	512232	Hub Unit Bearing
512233	HA590389	Hub Unit Bearing
512234	512234	Hub Unit Bearing
512235	512235	Hub Unit Bearing
512236	512236	Hub Unit Bearing
512237	512237	Hub Unit Bearing
512238	512238	Hub Unit Bearing
512239	512239	Hub Unit Bearing
512240	HA592210	Bearing Module
512241	HA590160	Hub Unit Bearing
512242	512242	Hub Unit Bearing
512243	HA590079	Hub Unit Bearing
512244	HA590092	Hub Unit Bearing
512245	HA590074	Hub Unit Bearing
512246	HA590091	Hub Unit Bearing
512247	HA590066	Hub Unit Bearing
512248	HA590067	Hub Unit Bearing
512249	HA590082	Hub Unit Bearing
512250	HA590088	Hub Unit Bearing

HUB UNIT BEARING / BEARING MODULE - CROSS REFERENCE - FM TO TIMKEN

continued

Federal Mogul Number	Timken Number	Part Description
512251	512251	Hub Unit Bearing
512252	HA590257	Hub Unit Bearing
512253	HA590218	Hub Unit Bearing
512254	HA597957	Hub Unit Bearing
512255	512255	Hub Unit Bearing
512256	HA590164	Hub Unit Bearing
512257	HA590152	Hub Unit Bearing
512258	HA590009	Hub Unit Bearing
512259	HA590005	Hub Unit Bearing
512260	BM500003	Bearing Module
512261	BM500003	Bearing Module
512262	BM500002	Bearing Module
512263	BM500000	Bearing Module
512264	HA590008	Hub Unit Bearing
512265	512265	Hub Unit Bearing
512266	512266	Hub Unit Bearing
512267	512267	Hub Unit Bearing
512268	HA590109	Hub Unit Bearing
512269	513131	Hub Unit Bearing
512270	512270	Hub Unit Bearing
512271	HA590100	Hub Unit Bearing
512271	HA590095	Hub Unit Bearing
512272	HA590095	Hub Unit Bearing
512273	HA590232	Hub Unit Bearing
512274	HA590128	Hub Unit Bearing
512275	HA590129	Hub Unit Bearing
512276	HA590104	Hub Unit Bearing
512277	HA590101	Hub Unit Bearing
512280	512280	Hub Unit Bearing
512281	HA591080	Hub Unit Bearing
512282	HA592461	Hub Unit Bearing
512283	HA592451	Hub Unit Bearing
512284	HA590338	Hub Unit Bearing
512285	HA590080	Hub Unit Bearing
512286	HA590010	Hub Unit Bearing
512287	HA590081	Hub Unit Bearing
512288	HA590209	Hub Unit Bearing
512289	HA590143	Hub Unit Bearing
512290	HA590144	Hub Unit Bearing
512291	HA590120	Hub Unit Bearing
512292	HA590111	Hub Unit Bearing
512293	HA590119	Hub Unit Bearing

Federal Mogul Number	Timken Number	Part Description
512294	512294	Hub Unit Bearing
512295	512295	Hub Unit Bearing
512296	HA590038	Hub Unit Bearing
512299	512299	Hub Unit Bearing
512300	HA590029	Hub Unit Bearing
512301	HA590031	Hub Unit Bearing
512302	HA590141	Hub Unit Bearing
512303	HA590110	Hub Unit Bearing
512304	HA590161	Hub Unit Bearing
512305	512305	Bearing Module
512306	HA590174	Hub Unit Bearing
512308	HA590116	Hub Unit Bearing
512309	HA590158	Hub Unit Bearing
512310	HA590370	Hub Unit Bearing
512311	HA590371	Hub Unit Bearing
512313	HA590022	Hub Unit Bearing
512314	HA590149	Hub Unit Bearing
512315	HA590089	Hub Unit Bearing
512316	HA590112	Hub Unit Bearing
512317	HA590113	Hub Unit Bearing
512320	HA590151	Hub Unit Bearing
512321	HA590146	Hub Unit Bearing
512322	512322	Hub Unit Bearing
512323	512323	Hub Unit Bearing
512325	HA590184	Hub Unit Bearing
512326	512326	Hub Unit Bearing
512327	HA590019	Hub Unit Bearing
512328	HA590169	Hub Unit Bearing
512329	HA590040	Hub Unit Bearing
512331	HA590221	Hub Unit Bearing
512332	HA590216	Hub Unit Bearing
512333	HA590230	Hub Unit Bearing
512334	HA590180	Hub Unit Bearing
512335	HA590183	Hub Unit Bearing
512336	HA590159	Hub Unit Bearing
512337	HA590136	Hub Unit Bearing
512339	HA590103	Hub Unit Bearing
512340	512340	Hub Unit Bearing
512341	HA590179	Hub Unit Bearing
512344	HA590190	Hub Unit Bearing
512347	HA590099	Hub Unit Bearing
512349	HA590195	Hub Unit Bearing

HUB UNIT BEARING / BEARING MODULE - CROSS REFERENCE - FM TO TIMKEN

continued

Federal Mogul Number	Timken Number	Part Description
512353	HA590202	Hub Unit Bearing
513003	513003	Hub Unit Bearing
513004K	513004K	Hub Unit Bearing
513009	513009	Hub Unit Bearing
513010	513010	Hub Unit Bearing
513011K	513011K	Hub Unit Bearing
513012	513012	Hub Unit Bearing
513013	513013	Hub Unit Bearing
513016K	513016K	Hub Unit Bearing
513017K	513017K	Hub Unit Bearing
513018	513018	Hub Unit Bearing
513019	513019	Hub Unit Bearing
513020	513020	Hub Unit Bearing
513030	513030	Hub Unit Bearing
513033	513033	Hub Unit Bearing
513034	513034	Hub Unit Bearing
513035	513035	Hub Unit Bearing
513038	513038	Hub Unit Bearing
513039	513039	Hub Unit Bearing
513040	513040	Hub Unit Bearing
513041	513041	Hub Unit Bearing
513042	513042	Hub Unit Bearing
513044	513044	Hub Unit Bearing
513048	513048	Hub Unit Bearing
513049	513049	Hub Unit Bearing
513050	513050	Hub Unit Bearing
513059	513059	Hub Unit Bearing
513061	513061	Hub Unit Bearing
513062	513062	Hub Unit Bearing
513063	513063	Hub Unit Bearing
513070	513070	Hub Unit Bearing
513072	513072	Hub Unit Bearing
513074	513074	Hub Unit Bearing
513075	513075	Hub Unit Bearing
513076	513076	Hub Unit Bearing
513077	513077	Hub Unit Bearing
513078	513078	Hub Unit Bearing
513079	513080	Hub Unit Bearing
513080	513080	Hub Unit Bearing
513081	513081	Hub Unit Bearing
513082	513082	Hub Unit Bearing
513084	513084	Hub Unit Bearing

Federal Mogul Number	Timken Number	Part Description
513085	513085	Hub Unit Bearing
513087	513087	Hub Unit Bearing
513088	513088	Hub Unit Bearing
513089	513089	Hub Unit Bearing
513090	513090	Hub Unit Bearing
513091	513092	Hub Unit Bearing
513092	513092	Hub Unit Bearing
513093	513093	Bearing Module
513094	513094	Hub Unit Bearing
513095	513095	Hub Unit Bearing
513096	513096	Hub Unit Bearing
513098	513098	Bearing Module
513099	513099	Bearing Module
513100	513100	Hub Unit Bearing
513104	513104	Hub Unit Bearing
513105	513105	Hub Unit Bearing
513107	513107	Hub Unit Bearing
513109	513109	Hub Unit Bearing
513111	513111	Hub Unit Bearing
513114	513131	Hub Unit Bearing
513115	513115	Hub Unit Bearing
513117	513138	Hub Unit Bearing
513121	513121	Hub Unit Bearing
513122	513122	Hub Unit Bearing
513123	513123	Hub Unit Bearing
513124	513124	Hub Unit Bearing
513125	513125	Hub Unit Bearing
513125	HA590308	Hub Unit Bearing
513126	513126	Hub Unit Bearing
513127	513127	Hub Unit Bearing
513128	513128	Hub Unit Bearing
513129	HA590177	Hub Unit Bearing
513131	513131	Hub Unit Bearing
513132	513132	Hub Unit Bearing
513133	513133	Hub Unit Bearing
513135	513135	Bearing Module
513137	513137	Hub Unit Bearing
513138	513138	Hub Unit Bearing
513139	513139	Hub Unit Bearing
513142	513142	Hub Unit Bearing
513152	513152	Hub Unit Bearing
513153	513131	Hub Unit Bearing

HUB UNIT BEARING / BEARING MODULE - CROSS REFERENCE - FM TO TIMKEN

continued

Federal Mogul Number	Timken Number	Part Description
513155	513155	Hub Unit Bearing
513156	513156	Hub Unit Bearing
513157	513157	Hub Unit Bearing
513158	HA597449	Hub Unit Bearing
513159	HA598679	Hub Unit Bearing
513160	513160	Hub Unit Bearing
513161	BM513161	Bearing Module
513162	HA595017	Hub Unit Bearing
513163	HA593550	Hub Unit Bearing
513164	HA596467	Hub Unit Bearing
513165	HA590653	Hub Unit Bearing
513166	HA590644	Hub Unit Bearing
513167	HA590213	Hub Unit Bearing
513169	HA590224	Hub Unit Bearing
513170	HA590056K	Hub Unit Bearing
513171	HA592519	Hub Unit Bearing
513172	HA593427	Hub Unit Bearing
513173	513173	Hub Unit Bearing
513174	HA594181	Hub Unit Bearing
513175	513175	Hub Unit Bearing
513176	HA599455L	Hub Unit Bearing
513177	HA599455R	Hub Unit Bearing
513178	HA599467	Hub Unit Bearing
513179	513179	Hub Unit Bearing
513183	513094	Hub Unit Bearing
513186	513186	Hub Unit Bearing
513187	513187	Hub Unit Bearing
513188	513188	Hub Unit Bearing
513189	513189	Hub Unit Bearing
513190	513190	Hub Unit Bearing
513191	513191	Hub Unit Bearing
513192	513192	Hub Unit Bearing
513193	513193	Hub Unit Bearing
513194	513194	Hub Unit Bearing
513195	HA590241K	Hub Unit Bearing
513196	513196	Hub Unit Bearing
513197	HA590077	Hub Unit Bearing
513198	HA590078	Hub Unit Bearing
513199	HA590093	Hub Unit Bearing
513200	SP450300	Hub Unit Bearing
513201	HA590208	Hub Unit Bearing
513202	513202	Hub Unit Bearing

Federal Mogul Number	Timken Number	Part Description
513203	HA590085	Hub Unit Bearing
513204	HA590068	Hub Unit Bearing
513205	HA590069	Hub Unit Bearing
513206	HA590086	Hub Unit Bearing
513207	HA590033	Hub Unit Bearing
513208	HA590223	Hub Unit Bearing
513209	513209	Hub Unit Bearing
513210	513210	Hub Unit Bearing
513211	HA590097	Hub Unit Bearing
513212	HA590072	Hub Unit Bearing
513213	HA590055K	Hub Unit Bearing
513214	HA590070	Hub Unit Bearing
513215	HA590071	Hub Unit Bearing
513216	HA595894	Hub Unit Bearing
513217	HA590006	Hub Unit Bearing
513218	HA590007	Hub Unit Bearing
513219	HA590108	Hub Unit Bearing
513220	HA590118	Hub Unit Bearing
513221	HA590017	Hub Unit Bearing
513222	HA590026	Hub Unit Bearing
513223	HA590028	Hub Unit Bearing
513224	HA590030	Hub Unit Bearing
513225	HA590142	Hub Unit Bearing
513226	513226	Hub Unit Bearing
513227	BM500012	Bearing Module
513228	HA590034	Hub Unit Bearing
513229	HA590035	Hub Unit Bearing
513230	513230	Hub Unit Bearing
513231	HA590197	Hub Unit Bearing
513232	HA590024	Hub Unit Bearing
513233	HA590025	Hub Unit Bearing
513234	HA590036	Hub Unit Bearing
513235	HA590048	Hub Unit Bearing
513236	HA590157	Hub Unit Bearing
513237	HA590087	Hub Unit Bearing
513238	HA590049	Hub Unit Bearing
513239	HA590150	Hub Unit Bearing
513250	HA590115	Hub Unit Bearing
513251	HA590131	Hub Unit Bearing
513252	HA590147	Hub Unit Bearing
513253	HA590106	Hub Unit Bearing
513254	HA590162	Hub Unit Bearing

HUB UNIT BEARING / BEARING MODULE - CROSS REFERENCE - FM TO TIMKEN

continued

Federal Mogul Number	Timken Number	Part Description
513255	513255	Hub Unit Bearing
513255	HA590212	Hub Unit Bearing
513257	HA590165	Hub Unit Bearing
513258	HA590168	Hub Unit Bearing
513259	HA590186	Hub Unit Bearing
513260	HA590185	Hub Unit Bearing
513261	HA590217	Hub Unit Bearing
513262	513262	Hub Unit Bearing
513263	HA590219	Hub Unit Bearing
513264	HA590214	Hub Unit Bearing
513265	HA590064	Hub Unit Bearing
513266	513266	Hub Unit Bearing
515000	515000	Hub Unit Bearing
515001	515001	Hub Unit Bearing
515002	515002	Hub Unit Bearing
515003	SP450200	Hub Unit Bearing
515004	SP550201	Hub Unit Bearing
515005	515005	Hub Unit Bearing
515006	515006	Hub Unit Bearing
515007	HA599361	Hub Unit Bearing
515008	SP450101	Hub Unit Bearing
515009	SP450100	Hub Unit Bearing
515010	SP550200	Hub Unit Bearing
515011	HA597851	Hub Unit Bearing
515012	HA590020	Hub Unit Bearing
515013	SP450201	Hub Unit Bearing
515014	515014	Hub Unit Bearing
515015	SP580301	Hub Unit Bearing
515016	SP580300	Hub Unit Bearing
515017	515017	Hub Unit Bearing
515018	HA591339	Hub Unit Bearing
515019	SP550302	Hub Unit Bearing
515019	SP550303	Hub Unit Bearing
515019	SP550308	Hub Unit Bearing
515020	515020	Hub Unit Bearing
515021	515021	Hub Unit Bearing
515022	515022	Hub Unit Bearing
515023	SP550100	Hub Unit Bearing
515024	SP550300	Hub Unit Bearing
515024	SP550301	Hub Unit Bearing
515024	SP550307	Hub Unit Bearing
515025	515025	Hub Unit Bearing

Federal Mogul Number	Timken Number	Part Description
515026	515026	Hub Unit Bearing
515027	515027	Hub Unit Bearing
515028	515028	Hub Unit Bearing
515029	515029	Hub Unit Bearing
515030	515030	Hub Unit Bearing
515031	515031	Hub Unit Bearing
515032	HA599528	Hub Unit Bearing
515033	HA599406	Hub Unit Bearing
515034	SP580101	Hub Unit Bearing
515035	SP580100	Hub Unit Bearing
515036	SP500300	Hub Unit Bearing
515037	HA591339	Hub Unit Bearing
515038	HA599863	Hub Unit Bearing
515039	SP550102	Hub Unit Bearing
515040	BM500007	Bearing Module
515041	SP580303	Hub Unit Bearing
515041	SP580302	Hub Unit Bearing
515042	SP550206	Hub Unit Bearing
515043	SP550202	Hub Unit Bearing
515044	HA590307	Hub Unit Bearing
515046	SP550207	Hub Unit Bearing
515047	SP550208	Hub Unit Bearing
515048	SP580302	Hub Unit Bearing
515049	SP550101	Hub Unit Bearing
515050	SP470201	Hub Unit Bearing
515051	SP450202	Hub Unit Bearing
515052	SP450202	Hub Unit Bearing
515053	SP550305	Hub Unit Bearing
515054	SP550306	Hub Unit Bearing
515056	SP580205	Hub Unit Bearing
515057	515025	Hub Unit Bearing
515058	SP580304	Hub Unit Bearing
515059	HA590352	Hub Unit Bearing
515059	HA590227	Hub Unit Bearing
515060	HA590353	Hub Unit Bearing
515061	HA590032	Hub Unit Bearing
515062	HA590503	Hub Unit Bearing
515063	HA590203	Hub Unit Bearing
515064	SP450702	Hub Unit Bearing
515065	SP450701	Hub Unit Bearing
515066	SP500701	Hub Unit Bearing
515067	HA500601	Hub Unit Bearing

HUB UNIT BEARING / BEARING MODULE - CROSS REFERENCE - FM TO TIMKEN

continued

Federal Mogul Number	Timken Number	Part Description
515068	SP580103	Hub Unit Bearing
515069	SP580102	Hub Unit Bearing
515070	HA590018	Hub Unit Bearing
515071	SP450301	Hub Unit Bearing
515072	HA500100	Hub Unit Bearing
515073	SP500100	Hub Unit Bearing
515074	HA590145	Hub Unit Bearing
515075	SP580204	Hub Unit Bearing
515076	HA590132	Hub Unit Bearing
515077	HA590425	Hub Unit Bearing
515078	HA590156	Hub Unit Bearing
515079	SP550207	Hub Unit Bearing
515080	SP550208	Hub Unit Bearing
515081	SP940200	Hub Unit Bearing
515082	SP940201	Hub Unit Bearing
515083	SP940202	Hub Unit Bearing
515084	HA590001	Hub Unit Bearing
515085	SP580307	Hub Unit Bearing
515086	SP580305	Hub Unit Bearing
515087	SP580308	Hub Unit Bearing
515087	SP580311	Hub Unit Bearing
515088	SP580311	Hub Unit Bearing
515088	SP580309	Hub Unit Bearing
515089	SP550103	Hub Unit Bearing
515090	HA590206	Hub Unit Bearing
518500	518500	Hub Unit Bearing
518501	518501	Hub Unit Bearing
518502	518502	Hub Unit Bearing
518503	518503	Hub Unit Bearing
518504	518504	Hub Unit Bearing
518505	518505	Hub Unit Bearing
518506	518506	Hub Unit Bearing
518507	518507	Hub Unit Bearing
518508	HA590303K	Hub Unit Bearing
518509	HA590302K	Hub Unit Bearing
518510	HA590263K	Hub Unit Bearing
518511	HA590181K	Hub Unit Bearing
518512	HA590182K	Hub Unit Bearing
518513	HA590155K	Hub Unit Bearing
518514	HA590156K	Hub Unit Bearing
518515	HA590286K	Hub Unit Bearing
520000	520000	Hub Unit Bearing

Federal Mogul Number	Timken Number	Part Description
520100	520100	Hub Unit Bearing
521000	HA590259K	Hub Unit Bearing
541001	SP550203	Hub Unit Bearing
541002	BM500005	Bearing Module
541003	HA500701	Hub Unit Bearing
541004	SP500702	Hub Unit Bearing
541005	HA590003	Hub Unit Bearing
541006	HA590004	Hub Unit Bearing
541007	HA590016	Hub Unit Bearing

HUB UNIT BEARING / BEARING MODULE - CROSS REFERENCE - SKF TO TIMKEN

SKF Number	Timken Number	Part Description
BR930000	518500	Hub Unit Bearing
BR930001	518501	Hub Unit Bearing
BR930002	518502	Hub Unit Bearing
BR930003	513077	Hub Unit Bearing
BR930004	513076	Hub Unit Bearing
BR930007	513070	Hub Unit Bearing
BR930007	513078	Hub Unit Bearing
BR930008	513082	Hub Unit Bearing
BR930010	513033	Hub Unit Bearing
BR930012	512015	Hub Unit Bearing
BR930013	513075	Hub Unit Bearing
BR930014	513084	Hub Unit Bearing
BR930016	513003	Hub Unit Bearing
BR930017	512037	Hub Unit Bearing
BR930021K	513074	Hub Unit Bearing
BR930022K	513016K	Hub Unit Bearing
BR930023	513019	Hub Unit Bearing
BR930024	513020	Hub Unit Bearing
BR930025	513049	Hub Unit Bearing
BR930026	513018	Hub Unit Bearing
BR930026	512221	Hub Unit Bearing
BR930026	HA590074	Hub Unit Bearing
BR930027	513048	Hub Unit Bearing
BR930028K	513017K	Hub Unit Bearing
BR930029	513038	Hub Unit Bearing
BR930030	513039	Hub Unit Bearing
BR930032	513050	Hub Unit Bearing
BR930033	513035	Hub Unit Bearing
BR930034K	513004K	Hub Unit Bearing
BR930035	515002	Hub Unit Bearing
BR930037	512011	Hub Unit Bearing
BR930038	512010	Hub Unit Bearing
BR930039	513040	Hub Unit Bearing
BR930040	513107	Hub Unit Bearing
BR930043	513030	Hub Unit Bearing
BR930045	513109	Hub Unit Bearing
BR930048	513092	Hub Unit Bearing
BR930049	513041	Hub Unit Bearing
BR930050	513111	Hub Unit Bearing
BR930050	513095	Hub Unit Bearing
BR930052K	513013	Hub Unit Bearing
BR930053	512000	Hub Unit Bearing
BR930054	513128	Hub Unit Bearing
BR930055K	HA590055K	Hub Unit Bearing

SKF Number	Timken Number	Part Description
BR930056K	HA590056K	Hub Unit Bearing
BR930057	HA590057	Hub Unit Bearing
BR930059	512033	Hub Unit Bearing
BR930060	513104	Hub Unit Bearing
BR930061	513059	Hub Unit Bearing
BR930064	513061	Hub Unit Bearing
BR930065	513085	Hub Unit Bearing
BR930066	512157	Hub Unit Bearing
BR930067	512156	Hub Unit Bearing
BR930068	513062	Hub Unit Bearing
BR930069	512155	Hub Unit Bearing
BR930070	512001	Hub Unit Bearing
BR930071	512179	Hub Unit Bearing
BR930072	513063	Hub Unit Bearing
BR930073	512005	Hub Unit Bearing
BR930074	512003	Hub Unit Bearing
BR930075	512237	Hub Unit Bearing
BR930075	512150	Hub Unit Bearing
BR930075	HA590092	Hub Unit Bearing
BR930076	513087	Hub Unit Bearing
BR930077	513088	Hub Unit Bearing
BR930078	512078	Hub Unit Bearing
BR930079	512144	Hub Unit Bearing
BR930080	513137	Hub Unit Bearing
BR930081	512223	Hub Unit Bearing
BR930083K	513044	Hub Unit Bearing
BR930087	513042	Hub Unit Bearing
BR930088	513009	Hub Unit Bearing
BR930089	512002	Hub Unit Bearing
BR930090	513010	Hub Unit Bearing
BR930091K	513011K	Hub Unit Bearing
BR930093	513012	Hub Unit Bearing
BR930094	515001	Hub Unit Bearing
BR930096	512004	Hub Unit Bearing
BR930097	513124	Hub Unit Bearing
BR930098	512152	Hub Unit Bearing
BR930099	513139	Hub Unit Bearing
BR930100	513127	Hub Unit Bearing
BR930101	512146	Hub Unit Bearing
BR930102	HA590102	Hub Unit Bearing
BR930103	512147	Hub Unit Bearing
BR930105	512105	Hub Unit Bearing
BR930106	512106	Hub Unit Bearing
BR930106	512164	Hub Unit Bearing

HUB UNIT BEARING / BEARING MODULE - CROSS REFERENCE - SKF TO TIMKEN

continued

SKF Number	Timken Number	Part Description
BR930107	HA590038	Hub Unit Bearing
BR930107	512107	Hub Unit Bearing
BR930108	512012	Hub Unit Bearing
BR930113	513105	Hub Unit Bearing
BR930114	513131	Hub Unit Bearing
BR930115	512182	Hub Unit Bearing
BR930116	515000	Hub Unit Bearing
BR930118	512118	Hub Unit Bearing
BR930119	512119	Hub Unit Bearing
BR930120	513080	Hub Unit Bearing
BR930120	512122	Hub Unit Bearing
BR930122	512031	Hub Unit Bearing
BR930123	512008	Hub Unit Bearing
BR930124	513081	Hub Unit Bearing
BR930126	512032	Hub Unit Bearing
BR930127	512034	Hub Unit Bearing
BR930128	513034	Hub Unit Bearing
BR930129	512020	Hub Unit Bearing
BR930130	512016	Hub Unit Bearing
BR930134	512025	Hub Unit Bearing
BR930136	512172	Hub Unit Bearing
BR930138	513138	Hub Unit Bearing
BR930143	513152	Hub Unit Bearing
BR930144	HA593427	Hub Unit Bearing
BR930144	HA593247	Hub Unit Bearing
BR930145	512151	Hub Unit Bearing
BR930148	513187	Hub Unit Bearing
BR930150	512024	Hub Unit Bearing
BR930151K	520000	Hub Unit Bearing
BR930152K	520100	Hub Unit Bearing
BR930153K	518503	Hub Unit Bearing
BR930154K	518504	Hub Unit Bearing
BR930155K	HA590155K	Hub Unit Bearing
BR930156K	HA590156K	Hub Unit Bearing
BR930159	512180	Hub Unit Bearing
BR930160	HA590160	Hub Unit Bearing
BR930161	513125	Hub Unit Bearing
BR930162	513096	Hub Unit Bearing
BR930163	513094	Hub Unit Bearing
BR930164	HA592519	Hub Unit Bearing
BR930165	512200	Hub Unit Bearing
BR930166K	518505	Hub Unit Bearing
BR930167	512176	Hub Unit Bearing
BR930168	513202	Hub Unit Bearing

SKF Number	Timken Number	Part Description
BR930169	HA596467	Hub Unit Bearing
BR930170	512039	Hub Unit Bearing
BR930171	512181	Bearing Module
BR930172	512136	Bearing Module
BR930172	HA590306	Hub Unit Bearing
BR930173	512167	Hub Unit Bearing
BR930174	512120	Hub Unit Bearing
BR930175	512027	Hub Unit Bearing
BR930175	512165	Hub Unit Bearing
BR930176	512133	Hub Unit Bearing
BR930178	512124	Hub Unit Bearing
BR930179	513100	Hub Unit Bearing
BR930180	512028	Hub Unit Bearing
BR930181K	HA590181K	Hub Unit Bearing
BR930182K	HA590182K	Hub Unit Bearing
BR930183	512242	Hub Unit Bearing
BR930183	512022	Hub Unit Bearing
BR930184	HA590085	Hub Unit Bearing
BR930184	513160	Hub Unit Bearing
BR930185	512123	Hub Unit Bearing
BR930186	513090	Hub Unit Bearing
BR930188	512030	Hub Unit Bearing
BR930189	512029	Hub Unit Bearing
BR930190K	513089	Hub Unit Bearing
BR930191	512006	Hub Unit Bearing
BR930192	513072	Hub Unit Bearing
BR930193	512125	Hub Unit Bearing
BR930194	512154	Hub Unit Bearing
BR930195	512021	Hub Unit Bearing
BR930196	512023	Hub Unit Bearing
BR930197	HA590197	Hub Unit Bearing
BR930198	512153	Hub Unit Bearing
BR930199	512220	Hub Unit Bearing
BR930200K	518506	Hub Unit Bearing
BR930202	512137	Bearing Module
BR930203	HA590203	Hub Unit Bearing
BR930204	SP450101	Hub Unit Bearing
BR930205	SP450100	Hub Unit Bearing
BR930206	512013	Hub Unit Bearing
BR930207	HA599361	Hub Unit Bearing
BR930208	SP550201	Hub Unit Bearing
BR930209	SP550308	Hub Unit Bearing
BR930209	SP550303	Hub Unit Bearing
BR930209	SP550302	Hub Unit Bearing

HUB UNIT BEARING / BEARING MODULE - CROSS REFERENCE - SKF TO TIMKEN

continued

SKF Number	Timken Number	Part Description
BR930210	512235	Hub Unit Bearing
BR930212	512036	Hub Unit Bearing
BR930213	HA590213	Hub Unit Bearing
BR930214	513157	Hub Unit Bearing
BR930215	513123	Hub Unit Bearing
BR930216	513122	Hub Unit Bearing
BR930218	515017	Hub Unit Bearing
BR930219	HA597449	Hub Unit Bearing
BR930220	513135	Bearing Module
BR930222	512162	Hub Unit Bearing
BR930223	512149	Hub Unit Bearing
BR930224	HA599455L	Hub Unit Bearing
BR930225	HA599455R	Hub Unit Bearing
BR930226	513126	Hub Unit Bearing
BR930227	512145	Hub Unit Bearing
BR930228	512232	Hub Unit Bearing
BR930229	512121	Hub Unit Bearing
BR930230	512168	Hub Unit Bearing
BR930231	512171	Hub Unit Bearing
BR930232	HA596030	Hub Unit Bearing
BR930233	512186	Hub Unit Bearing
BR930234	512177	Hub Unit Bearing
BR930235	512173	Hub Unit Bearing
BR930236	515031	Hub Unit Bearing
BR930237	513155	Hub Unit Bearing
BR930238	512158	Hub Unit Bearing
BR930240	HA590240	Hub Unit Bearing
BR930241K	HA590241K	Hub Unit Bearing
BR930242	HA597957	Hub Unit Bearing
BR930243	512161	Hub Unit Bearing
BR930245	HA595894	Hub Unit Bearing
BR930246	513156	Hub Unit Bearing
BR930247K	HA594460K	Hub Unit Bearing
BR930248	HA590248	Hub Unit Bearing
BR930249	HA594181	Hub Unit Bearing
BR930250	513115	Hub Unit Bearing
BR930252	SP450200	Hub Unit Bearing
BR930253	512191	Hub Unit Bearing
BR930254	512174	Hub Unit Bearing
BR930255	512175	Hub Unit Bearing
BR930256	515006	Hub Unit Bearing
BR930257	HA590257	Hub Unit Bearing
BR930258	512040	Hub Unit Bearing
BR930259K	HA590259K	Hub Unit Bearing

SKF Number	Timken Number	Part Description
BR930260	512195	Hub Unit Bearing
BR930261	513142	Hub Unit Bearing
BR930262	HA590188	Hub Unit Bearing
BR930263K	HA590263K	Hub Unit Bearing
BR930265	515005	Hub Unit Bearing
BR930266	HA592450	Hub Unit Bearing
BR930267	HA592460	Hub Unit Bearing
BR930268	512185	Hub Unit Bearing
BR930269	513175	Hub Unit Bearing
BR930271	512148	Hub Unit Bearing
BR930272	513131	Hub Unit Bearing
BR930273	512160	Hub Unit Bearing
BR930275	512026	Hub Unit Bearing
BR930276	512178	Hub Unit Bearing
BR930277	513194	Hub Unit Bearing
BR930278	512169	Hub Unit Bearing
BR930279	512170	Hub Unit Bearing
BR930280	512193	Hub Unit Bearing
BR930281	512192	Hub Unit Bearing
BR930282	512190	Hub Unit Bearing
BR930283	512191	Hub Unit Bearing
BR930284	HA500100	Hub Unit Bearing
BR930285	SP500100	Hub Unit Bearing
BR930286	HA590286K	Hub Unit Bearing
BR930287	512189	Hub Unit Bearing
BR930288	512194	Hub Unit Bearing
BR930289	513209	Hub Unit Bearing
BR930290	512187	Hub Unit Bearing
BR930291	HA595017	Hub Unit Bearing
BR930292	HA594301	Hub Unit Bearing
BR930293	HA593550	Hub Unit Bearing
BR930294	HA591050	Hub Unit Bearing
BR930295	HA590201	Hub Unit Bearing
BR930296	HA594504	Hub Unit Bearing
BR930298	513186	Hub Unit Bearing
BR930298	512222	Hub Unit Bearing
BR930299	512239	Hub Unit Bearing
BR930300K	518507	Hub Unit Bearing
BR930301K	HA590301K	Hub Unit Bearing
BR930302K	HA590302K	Hub Unit Bearing
BR930303K	HA590303K	Hub Unit Bearing
BR930304	SP500300	Hub Unit Bearing
BR930305	SP550102	Hub Unit Bearing
BR930306	513196	Hub Unit Bearing

HUB UNIT BEARING / BEARING MODULE - CROSS REFERENCE - SKF TO TIMKEN

continued

SKF Number	Timken Number	Part Description
BR930307	HA590307	Hub Unit Bearing
BR930308	513193	Hub Unit Bearing
BR930309	512216	Hub Unit Bearing
BR930310	512215	Hub Unit Bearing
BR930311	512238	Hub Unit Bearing
BR930312	512236	Hub Unit Bearing
BR930313	HA590077	Hub Unit Bearing
BR930314	HA590071	Hub Unit Bearing
BR930315	HA590069	Hub Unit Bearing
BR930316	HA590068	Hub Unit Bearing
BR930317	HA590070	Hub Unit Bearing
BR930318	SP550200	Hub Unit Bearing
BR930319	BM500003	Bearing Module
BR930320	512267	Hub Unit Bearing
BR930321	512265	Hub Unit Bearing
BR930323	513190	Hub Unit Bearing
BR930324	HA590040	Hub Unit Bearing
BR930324	512217	Hub Unit Bearing
BR930325	HA599467	Hub Unit Bearing
BR930326	513189	Hub Unit Bearing
BR930327	512229	Hub Unit Bearing
BR930328	512230	Hub Unit Bearing
BR930329	512218	Hub Unit Bearing
BR930334	HA590184	Hub Unit Bearing
BR930335	HA598679	Hub Unit Bearing
BR930336	512018	Hub Unit Bearing
BR930337	512019	Hub Unit Bearing
BR930338	HA590338	Hub Unit Bearing
BR930339	512041	Hub Unit Bearing
BR930339	HA591080	Hub Unit Bearing
BR930340	HA590152	Hub Unit Bearing
BR930341	515026	Hub Unit Bearing
BR930342	515027	Hub Unit Bearing
BR930343	SP450201	Hub Unit Bearing
BR930344	515014	Hub Unit Bearing
BR930346	SP550300	Hub Unit Bearing
BR930346	SP550307	Hub Unit Bearing
BR930346	SP550301	Hub Unit Bearing
BR930347	HA590010	Hub Unit Bearing
BR930349	HA590308	Hub Unit Bearing
BR930350	513132	Hub Unit Bearing
BR930352	HA590352	Hub Unit Bearing
BR930353	HA590353	Hub Unit Bearing
BR930354	513133	Hub Unit Bearing

SKF Number	Timken Number	Part Description
BR930355	HA590208	Hub Unit Bearing
BR930356	HA590209	Hub Unit Bearing
BR930357	HA592410	Hub Unit Bearing
BR930358	HA594245	Hub Unit Bearing
BR930359	HA590030	Hub Unit Bearing
BR930360	HA599406	Hub Unit Bearing
BR930361	HA599528	Hub Unit Bearing
BR930362	512202	Hub Unit Bearing
BR930362	512201	Hub Unit Bearing
BR930364	HA590067	Hub Unit Bearing
BR930365	HA590066	Hub Unit Bearing
BR930366	512163	Hub Unit Bearing
BR930367	512196	Hub Unit Bearing
BR930368	HA590082	Hub Unit Bearing
BR930369	HA590081	Hub Unit Bearing
BR930370	HA590370	Hub Unit Bearing
BR930371	HA590371	Hub Unit Bearing
BR930372	HA590007	Hub Unit Bearing
BR930373	HA590006	Hub Unit Bearing
BR930374	513226	Hub Unit Bearing
BR930375	HA590161	Hub Unit Bearing
BR930376	HA592461	Hub Unit Bearing
BR930377	HA592451	Hub Unit Bearing
BR930378	512197	Hub Unit Bearing
BR930379	HA590110	Hub Unit Bearing
BR930380	HA590008	Hub Unit Bearing
BR930381	HA590009	Hub Unit Bearing
BR930382	HA590005	Hub Unit Bearing
BR930383	512188	Hub Unit Bearing
BR930384	HA590290	Hub Unit Bearing
BR930386	512270	Hub Unit Bearing
BR930388	513173	Hub Unit Bearing
BR930389	HA590218	Hub Unit Bearing
BR930390	HA590644	Hub Unit Bearing
BR930391	HA590653	Hub Unit Bearing
BR930392	HA590389	Hub Unit Bearing
BR930394	513192	Hub Unit Bearing
BR930395	513191	Hub Unit Bearing
BR930396	513210	Hub Unit Bearing
BR930397	513188	Hub Unit Bearing
BR930398	512198	Hub Unit Bearing
BR930399	512199	Hub Unit Bearing
BR930400	HA597851	Hub Unit Bearing
BR930401	512295	Hub Unit Bearing

HUB UNIT BEARING / BEARING MODULE - CROSS REFERENCE - SKF TO TIMKEN

continued

SKF Number	Timken Number	Part Description
BR930402	512294	Hub Unit Bearing
BR930403	HA590111	Hub Unit Bearing
BR930403	512203	Hub Unit Bearing
BR930404	SP580303	Hub Unit Bearing
BR930405	HA590020	Hub Unit Bearing
BR930406	HA591339	Hub Unit Bearing
BR930407	SP580101	Hub Unit Bearing
BR930408	SP580100	Hub Unit Bearing
BR930409	HA599863	Hub Unit Bearing
BR930410	SP550100	Hub Unit Bearing
BR930411	HA590100	Hub Unit Bearing
BR930412	HA590095	Hub Unit Bearing
BR930413	HA590108	Hub Unit Bearing
BR930413	HA590177	Hub Unit Bearing
BR930414	HA590120	Hub Unit Bearing
BR930415	SP550101	Hub Unit Bearing
BR930416	SP580304	Hub Unit Bearing
BR930417	SP550305	Hub Unit Bearing
BR930417	SP450301	Hub Unit Bearing
BR930418	515022	Hub Unit Bearing
BR930419	515030	Hub Unit Bearing
BR930420	515020	Hub Unit Bearing
BR930421	515025	Hub Unit Bearing
BR930422	515028	Hub Unit Bearing
BR930423	515029	Hub Unit Bearing
BR930424	515021	Hub Unit Bearing
BR930425	HA590425	Hub Unit Bearing
BR930426	SP580204	Hub Unit Bearing
BR930427	HA590132	Hub Unit Bearing
BR930428	HA590233	Hub Unit Bearing
BR930430	HA590080	Hub Unit Bearing
BR930431	HA590143	Hub Unit Bearing
BR930432	HA590144	Hub Unit Bearing
BR930434	HA592210	Bearing Module
BR930435	HA590024	Hub Unit Bearing
BR930436	512184	Hub Unit Bearing
BR930437	512280	Hub Unit Bearing
BR930438	SP580205	Hub Unit Bearing
BR930439	HA590104	Hub Unit Bearing
BR930440	HA590101	Hub Unit Bearing
BR930441	HA590145	Hub Unit Bearing
BR930444	512166	Bearing Module
BR930445	512231	Hub Unit Bearing
BR930446	HA590031	Hub Unit Bearing

SKF Number	Timken Number	Part Description
BR930447	HA590142	Hub Unit Bearing
BR930448	HA590029	Hub Unit Bearing
BR930449	512299	Hub Unit Bearing
BR930450	HA590028	Hub Unit Bearing
BR930451	HA590018	Hub Unit Bearing
BR930452	SP450202	Hub Unit Bearing
BR930453	SP550202	Hub Unit Bearing
BR930456	SP470201	Hub Unit Bearing
BR930457	SP550206	Hub Unit Bearing
BR930459	SP550208	Hub Unit Bearing
BR930461	HA590141	Hub Unit Bearing
BR930463	HA590109	Hub Unit Bearing
BR930464	HA590131	Hub Unit Bearing
BR930465	HA590025	Hub Unit Bearing
BR930466	HA590115	Hub Unit Bearing
BR930467	HA590113	Hub Unit Bearing
BR930469	HA590112	Hub Unit Bearing
BR930470	513188	Hub Unit Bearing
BR930471	HA590149	Hub Unit Bearing
BR930472	HA590048	Hub Unit Bearing
BR930473	HA590118	Hub Unit Bearing
BR930474	HA590119	Hub Unit Bearing
BR930475	SP550103	Hub Unit Bearing
BR930476	HA590000	Hub Unit Bearing
BR930479	512266	Hub Unit Bearing
BR930488	HA590088	Hub Unit Bearing
BR930489	HA590021	Hub Unit Bearing
BR930490	HA590021	Hub Unit Bearing
BR930490	HA590022	Hub Unit Bearing
BR930491	SP580103	Hub Unit Bearing
BR930492	SP580102	Hub Unit Bearing
BR930493	HA590017	Hub Unit Bearing
BR930494	HA590026	Hub Unit Bearing
BR930497	SP450300	Hub Unit Bearing
BR930498	HA590129	Hub Unit Bearing
BR930499	HA590128	Hub Unit Bearing
BR930500	512251	Hub Unit Bearing
BR930502	HA590032	Hub Unit Bearing
BR930503	HA590503	Hub Unit Bearing
BR930504	HA590223	Hub Unit Bearing
BR930505	HA590232	Hub Unit Bearing
BR930506	513230	Hub Unit Bearing
BR930507	HA590166	Hub Unit Bearing
BR930508	HA590273	Hub Unit Bearing

HUB UNIT BEARING / BEARING MODULE - CROSS REFERENCE - SKF TO TIMKEN

continued

SKF Number	Timken Number	Part Description
BR930512	512159	Hub Unit Bearing
BR930513	HA590033	Hub Unit Bearing
BR930514	HA590035	Hub Unit Bearing
BR930515	HA590034	Hub Unit Bearing
BR930522	HA590174	Hub Unit Bearing
BR930523	HA590244	Hub Unit Bearing
BR930532	HA590227	Hub Unit Bearing
BR930548K	HA590093	Hub Unit Bearing
BR930548K	513179	Hub Unit Bearing
BR930548K	513121	Hub Unit Bearing
BR930600K	HA590600K	Hub Unit Bearing
BR930604	HA500601	Hub Unit Bearing
BR930605	HA500701	Hub Unit Bearing
BR930609	HA590216	Hub Unit Bearing
BR930611	HA590001	Hub Unit Bearing
BR930613	512323	Hub Unit Bearing
BR930620	512255	Hub Unit Bearing
BR930622	513262	Hub Unit Bearing
BR930623	HA590159	Hub Unit Bearing
BR930625	SP500702	Hub Unit Bearing
BR930627	HA590157	Hub Unit Bearing
BR930629	512322	Hub Unit Bearing
BR930633	HA590103	Hub Unit Bearing
BR930634	HA590036	Hub Unit Bearing
BR930635	SP550203	Hub Unit Bearing
BR930636	HA590183	Hub Unit Bearing
BR930637	SP500701	Hub Unit Bearing
BR930638	SP450702	Hub Unit Bearing
BR930640	HA590136	Hub Unit Bearing
BR930641	HA590064	Hub Unit Bearing
BR930642	HA590186	Hub Unit Bearing
BR930643	HA590185	Hub Unit Bearing
BR930644	HA590217	Hub Unit Bearing
BR930645	HA590274	Hub Unit Bearing
BR930646	512326	Hub Unit Bearing
BR930647	HA590052	Hub Unit Bearing
BR930648	HA590221	Hub Unit Bearing
BR930649	HA590230	Hub Unit Bearing
BR930650	HA590204	Hub Unit Bearing
BR930652	512340	Hub Unit Bearing
BR930653	HA590179	Hub Unit Bearing
BR930655	HA590250	Hub Unit Bearing
BR930656	HA590251	Hub Unit Bearing
BR930657	HA590045	Hub Unit Bearing

SKF Number	Timken Number	Part Description
BR930659	SP450702	Hub Unit Bearing
BR930664	HA590279	Hub Unit Bearing
BR930671	SP550309	Hub Unit Bearing
BR930675	HA590212	Hub Unit Bearing
BR930678	HA590150	Hub Unit Bearing
BR930679	HA590027	Hub Unit Bearing
BR930683	HA590276	Hub Unit Bearing
FW142	513093	Bearing Module
FW156	513098	Bearing Module
FW158	513099	Bearing Module
FW179	512305	Bearing Module
FW182	513135	Bearing Module
FW184	510038	Bearing Module
FW194	BM500007	Bearing Module
FW195	BM513161	Bearing Module
FWB29	513077	Hub Unit Bearing
GRW100	512038	Bearing Module
GRW160	512014	Bearing Module
GRW168	512009	Bearing Module
GRW176	512181	Bearing Module
GRW219	512234	Hub Unit Bearing
GRW233	511012	Bearing Module
GRW241	512183	Bearing Module
GRW270	HA590050	Bearing Module
GRW271	HA594246	Bearing Module
GRW272	BM500004	Bearing Module
GRW273	BM500005	Bearing Module
GRW309	511011	Bearing Module
GRW310	511010	Bearing Module
GRW311	511011	Bearing Module
GRW494	BM500010	Bearing Module
GRW495	512225	Hub Unit Bearing

HUB UNIT BEARING / BEARING MODULE TECHNOLOGY

HUB UNIT BEARING / BEARING MODULE - BUYER'S GUIDE

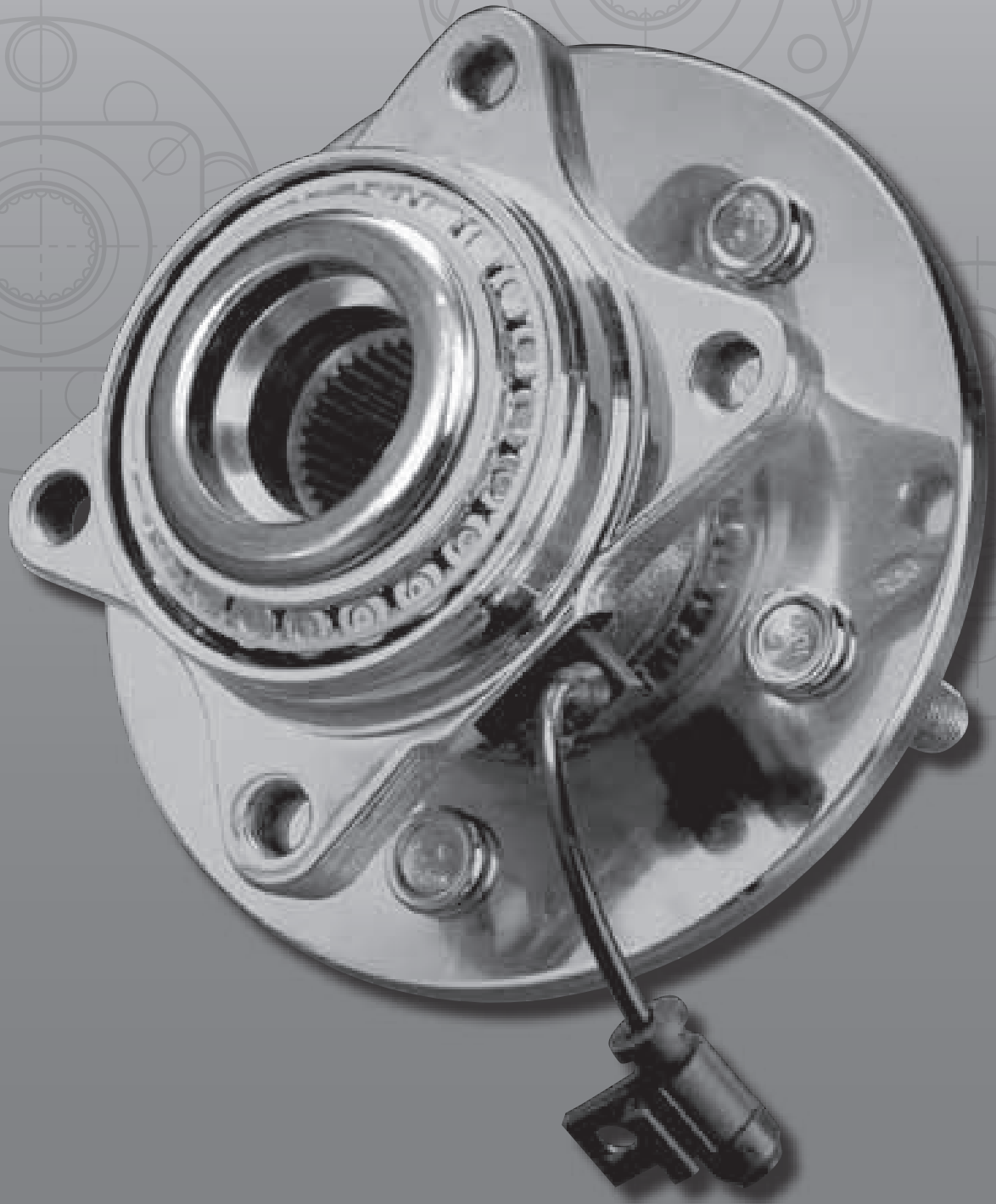

POPULARITY (POP) CODE DEFINITIONS

Code	Description	Code	Description	Code	Description
A	Fast	FW	Fleet Warehouse	TA	Tractor Fast
B	Good	IA	Import Fast	TB	Tractor Good
C	Medium	IB	Import Good	TC	Tractor Medium
D	Fair	IC	Import Medium	TD	Tractor Fair
F	Fleet	ID	Import Fair	TN	Tractor New
FA	Fleet Fast	IW	Import Warehouse	TW	Tractor Warehouse
FB	Fleet Good	N	New*	W	Warehouse
FC	Fleet Medium	O	Obsolete*	Z	Non-Cancellable, Non-Returnable*
FD	Fleet Fair	S	Superseded		

* Check for Availability

ABBREVIATIONS USED TO INDICATE CAR AND TRUCK MANUFACTURERS

ACU Car:	Acura Car AWD/FWD	BUI SUV:	Buick SUV AWD/FWD/RWD	DEL:	Delorean RWD
ACU SUV:	Acura SUV AWD/FWD	CAD Car FD:	Cadillac Car FWD	DES:	Desoto RWD
ALF Car:	Alfa Romeo Car RWD	CAD Car RD:	Cadillac Car AWD/RWD	DOD Car FD:	Dodge Car AWD/FWD
AMC Car:	American Motors-Eagle Car RWD	CAD TK:	Cadillac SUV, Truck AWD/RWD	DOD Car RD:	Dodge Car AWD/RWD
AST Car:	Aston Martin Car RWD	CHK Car:	Checker Car RWD	DOD IM Car:	Dodge Import Car AWD/FWD/RWD
AUD Car:	Audi Car AWD/FWD/RWD	CHE Car FD:	Chevy Car FWD	DOD MVan:	Dodge Minivan AWD/FWD
AUD SUV:	Audi SUV AWD/FWD	CHE Car RD:	Chevy Car RWD	DOD LT:	Dodge Lt Truck, SUV 4WD/RWD
AUS Car:	Austin Car RWD	CHE IM Car:	Chevy Import Car FWD	DOD CUV:	Dodge CUV AWD/FWD
AUH Car:	Austin Healey Car RWD	CHE IM SUV:	Chevy Import SUV 4WD/RWD	DOD TK 1/2:	Dodge Truck 1/2 Ton 4WD/RWD
AVA Car:	Avanti II Car RWD	CHE LT:	Chevy Lt Truck 4WD/AWD/FWD/RWD	DOD TK 3/4:	Dodge Truck 3/4 Ton 4WD/RWD
BEN Car:	Bentley Car RWD	CHE TK 1/2:	Chevy Truck 1/2 Ton 4WD/AWD/RWD	DOD TK 1:	Dodge Truck 1 Ton 4WD/RWD
MIN Car:	Mini Cooper Car FWD	CHE TK 3/4:	Chevy Truck 3/4 Ton 4WD/RWD	DOD TK 1+:	Dodge Truck 1 1/2 - 2 1/2 Ton 4WD/RWD
BMW1 Car:	BMW 1 & 2 Series Car RWD	CHE TK 1:	Chevy Truck 1Ton 4WD/RWD	EAG:	Eagle 4WD/AWD/FWD
BMW3 Car:	BMW 3 Series Car AWD/RWD	CHE TK 1+:	Chev Truck 1 1/2 - 2 1/2 Ton 4WD/RWD	FER:	Ferrari RWD
BMW4 Car:	BMW 4 Series Car RWD	CHR Car FD:	Chrysler Car AWD/FWD	FIA:	Fiat FWD/RWD
BMW5 Car:	BMW 5 Series Car AWD/RWD	CHR Car RD:	Chrysler Car AWD/RWD	FOR Car FD:	Ford Car FWD
BMW6 Car:	BMW 6 Series Car AWD/RWD	CHR IM Car:	Chrysler Import Car FWD	FOR Car AD:	Ford Car AWD
BMW7 Car:	BMW 7 Series Car RWD	CHR CUV:	Chrysler CUV AWD/FWD	FOR Car RD:	Ford Car RWD
BMW8 Car:	BMW 8 Series Car RWD	CHR MVan:	Chrysler Minivan AWD/FWD	FOR ANT:	Ford Antique RWD
BMW SUV:	BMW SUV AWD	DAE Car:	Daewoo Car FWD	FOR IM Car:	Ford Import Car FWD
BUI Car FD:	Buick Car FWD	DAI Car:	Daihatsu Car FWD	FOR LT:	Ford Lt Truck, Lt SUV 4WD/AWD/FWD/RWD
BUI Car RD:	Buick Car RWD	DAI SUV:	Daihatsu SUV 4WD	FOR MVan:	Ford Minivan FWD
BUI MVan:	Buick Minivan AWD/FWD				

FOR FSUV:	Ford Full Size SUV 4WD/RWD	LOT:	Lotus RWD	PON Car RD:	Pontiac Car RWD
FOR TK 1/2:	Ford Truck 1/2 Ton 4WD/RWD	MAS:	Maserati RWD	PON IM:	Pontiac Import FWD
FOR TK 3/4:	Ford Truck 3/4 Ton 4WD/RWD	MAZ Car FD:	Mazda Car FWD	PON SUV:	Pontiac SUV AWD/FWD
FOR TK 1:	Ford Truck 1 Ton 4WD/RWD	MAZ Car RD:	Mazda Car RWD	PON MVan:	Pontiac Minivan AWD/FWD
FOR TK 1+:	Ford Truck 1 1/2 - 2 1/2 Ton 4WD/RWD	MAZ TK:	Mazda SUV, Truck 4WD/AWD/RWD	POR:	Porsche Car AWD/RWD
GEO Car:	Geo Cars FWD	MER Car:	Mercedes Benz Car AWD/RWD	POR SUV:	Porsche SUV AWD
GEO TK:	Geo SUV, 4WD/RWD	MER SUV:	Mercedes Benz SUV 4WD/AWD	REL:	Reliant RWD
GMC TK:	GMC Truck 1 1/2 - 2 1/2 Ton 4WD/RWD	MRC Car FD:	Mercury Car FWD	REN:	Renault FWD
GRU:	Grumman RWD	MRC Car AD:	Mercury Car AWD	ROL:	Rolls Royce RWD
HEN:	Henry J	MRC Car RD:	Mercury Car RWD	ROV SUV:	Rover SUV 4WD/AWD
HON Car:	Honda Car 4WD/FWD/RWD	MRC SUV:	Mercury SUV 4WD/AWD/RWD	SAA:	Saab AWD/FWD
HON TK:	Honda Truck, Minivan, SUV 4WD/AWD/FWD/RWD	MRC Mvan:	Mercury Minivan FWD	SAT Car:	Saturn Car FWD/RWD
HUD:	Hudson RWD	MRK:	Merkur RWD	SAT SUV:	Saturn SUV AWD/FWD
HUM:	Hummer 4WD/RWD	MET:	Metropolitan RWD	SCI:	Scion FWD
HYU Car FD:	Hyundai Car FWD	MG:	M.G. RWD	SIM:	Simca RWD
HYU Car RD:	Hyundai Car RWD	MIT Car FD:	Mitsubishi Car AWD/FWD	STU Car:	Studebaker Car RWD
HYU TK:	Hyundai Truck, Minivan, SUV 4WD/AWD/FWD/RWD	MIT Car RD:	Mitsubishi Car RWD	STU TK:	Studebaker Truck RWD
INF Car FD:	Infiniti Car FWD	MIT TK:	Mitsubishi Minivan, SUV, Truck AWD/FWD	SUB Car AD:	Subaru Car 4WD/AWD/FWD
INF Car RD:	Infiniti Car RWD/AWD	MOR:	Morgan RWD	SUB TK AD:	Subaru Truck 4WD/AWD
INF SUV:	Infiniti SUV 4WD/AWD/RWD	MRR:	Morris RWD	SUN:	Sunbeam RWD
INT SUV:	International SUV 4WD/RWD	NAS:	Nash RWD	SUZ Car:	Suzuki Car AWD/FWD
INT TK:	International Truck 4WD/RWD	NIS Car FD:	Nissan Car 4WD/AWD/FWD	SUZ SUV:	Suzuki SUV 4WD/AWD/FWD/RWD
ISU Car FD:	Isuzu Car FWD	NIS Car RD:	Nissan Car RWD	TOY Car FD:	Toyota Car AWD/FWD
ISU Car RD:	Isuzu Car RWD	NIS TK:	Nissan CUV, Minivan, SUV AWD/FWD	TOY Car RD:	Toyota Car RWD
ISU TK:	Isuzu Truck, Minivan, SUV 4WD/FWD/RWD	NIS TK PU:	Nissan Truck 4WD/RWD	TOY TK:	Toyota Minivan, SUV, Truck 4WD/AWD/FWD/RWD
JAG:	Jaguar AWD/RWD	OLD Car FD:	Oldsmobile Car FWD/RWD	TRI:	Triumph RWD
JEE:	Jeep 4WD/RWD	OLD Car RD:	Oldsmobile Car RWD	VKS Car:	Volkswagen Car 4WD/AWD/FWD/RWD
KIA Car:	Kia Car FWD	OLD TK:	Oldsmobile Minivan, SUV 4WD/AWD/FWD	VKS SUV:	Volkswagen SUV AWD
KIA SUV:	Kia SUV 4WD/RWD	PAC:	Packard RWD	VLV:	Volvo AWD/FWD/RWD
LAM:	Lamborghini RWD	PEU:	Peugeot FWD/RWD	VLV SUV:	Volvo SUV AWD/FWD
LAN:	Lancia FWD/RWD	PLY Car FD:	Plymouth Car FWD	YUG:	Yugo FWD
LEX Car FD:	Lexus Car FWD	PLY Car RD:	Plymouth Car RWD		
LEX Car RD:	Lexus Car RWD	PLY IM:	Plymouth Import		
LEX SUV:	Lexus SUV 4WD/FWD	PLY MVan:	Plymouth Minivan AWD/FWD		
LIN Car FD:	Lincoln Car FWD	PLY TK:	Plymouth Truck 1 1/2 - 1 Ton 4WD/RWD		
LIN Car RD:	Lincoln Car RWD	PON Car FD:	Pontiac Car FWD		
LIN TK:	Lincoln Truck 4WD/AWD/RWD	PON Car AD:	Pontiac Car AWD/FWD		

HUB UNIT BEARING / BEARING MODULE - BUYER'S GUIDE

HUB UNIT BEARING / BEARING MODULE TECHNOLOGY

Timken Part No.	On Hand	Pop Code	Per Car Qty	Application
SP450100			1	FRONT WHEEL-4WD DOD LT (1997-04)
SP450101			1	FRONT WHEEL-4WD DOD LT (1997-04)
SP450200			2	FRONT WHEEL-4WD FOR LT (1995-02), MRC SUV (1997-01), FRONT WHEEL-AWD MRC SUV (1997-01)
SP450201			2	FRONT WHEEL-4WD FOR LT (2000-02), MAZ TK (2000-02)
SP450202			2	FRONT WHEEL-4WD FOR LT (2003-08), MAZ TK (2003-09)
SP450300			2	FRONT WHEEL-RWD CHE LT (1998-05)
SP450301			2	FRONT WHEEL-RWD CAD TK (2002-05), CHE TK1/2 (1999-07), CHE TK3/4 (2003-05)
SP450303		N	2	FRONT WHEEL-RWD CAD TK (2007-08), CHE TK1/2 (2007-08)
SP450701			2	FRONT WHEEL-4WD NIS TK PU (2005-08)
SP450702			2	FRONT WHEEL-RWD NIS TK PU (2005-08)
SP470200		N	2	FRONT WHEEL-RWD FOR LT (2002-05), FRONT WHEEL-4WD FOR LT (2002-05), FRONT WHEEL-AWD LIN TK (2003-05), FRONT WHEEL-RWD MRC SUV (2002-05), FRONT WHEEL-4WD MRC SUV (2002-05), FRONT WHEEL-AWD MRC SUV (2002-05)
SP470201			2	FRONT WHEEL-RWD FOR LT (2002-05), FRONT WHEEL-4WD FOR LT (2002-05), FRONT WHEEL-AWD LIN TK (2003-05), FRONT WHEEL-RWD MRC SUV (2002-05), FRONT WHEEL-4WD MRC SUV (2002-05), FRONT WHEEL-AWD MRC SUV (2002-05)
BM500000			2	REAR WHEEL-FWD HON TK (2003-05), REAR WHEEL-4WD HON TK (2003-05)
BM500001		N	2	REAR WHEEL-RWD BMW6 Car (2006-07)
BM500002			2	REAR WHEEL-FWD HON TK (2003-03), REAR WHEEL-4WD HON TK (2003-03)
BM500003			2	REAR WHEEL-FWD HON TK (2004-08), REAR WHEEL-4WD HON TK (2004-08)
BM500004			2	REAR WHEEL-RWD INF Car RD (2002-06)
BM500005		N	2	REAR WHEEL-RWD INF SUV (2003-08), REAR WHEEL-AWD INF SUV (2003-08)
BM500006			2	REAR WHEEL-RWD INF Car RD (2003-07), NIS Car RD (2003-06), REAR WHEEL-AWD INF Car RD (2004-07)
BM500007			2	FRONT WHEEL-RWD TOY TK (2003-09), FRONT WHEEL-4WD TOY TK (2003-09), LEX SUV (2003-08)
BM500009		N	2	FRONT WHEEL-RWD TOY TK (2005-06), FRONT WHEEL-4WD TOY TK (2005-06)
BM500010			2	REAR WHEEL-RWD BMW5 Car (2006-08), BMW6 Car (2004-07), BMW7 Car (2002-08), REAR WHEEL-AWD BMW5 Car (2006-09), BMW SUV (2000-09)
BM500012		N	2	FRONT WHEEL-AWD AUD Car (2002-09), REAR WHEEL-FWD AUD Car (2006-06), REAR WHEEL-AWD AUD Car (2004-09), FRONT WHEEL-4WD VKS Car (2004-06), REAR WHEEL-4WD VKS Car (2004-06)

Timken Part No.	On Hand	Pop Code	Per Car Qty	Application
BM500013		N	2	FRONT WHEEL-AWD INF Car RD (2004-06)
BM500014		N	1	REAR WHEEL-FWD HON TK (2006-08), REAR WHEEL-4WD HON TK (2006-08)
BM500015		N	1	REAR WHEEL-RWD TOY TK (2007-08), REAR WHEEL-4WD TOY TK (2007-08)
BM500016		N	1	REAR WHEEL-RWD TOY TK (2007-08), REAR WHEEL-4WD TOY TK (2007-08)
BM500017		N	2	FRONT WHEEL-RWD TOY TK (2007-08), FRONT WHEEL-4WD TOY TK (2007-08)
BM500018		N	2	FRONT WHEEL-4WD TOY TK (2008-08), LEX SUV (2008-08)
BM500019		N	2	REAR WHEEL-RWD TOY TK (2008-08), REAR WHEEL-4WD TOY TK (2008-08)
BM500022		N	2	REAR WHEEL-RWD NIS TK PU (2005-08)
BM500029		N	1	REAR WHEEL-4WD TOY TK (2008-08)
BM500030		N	1	REAR WHEEL-4WD TOY TK (2008-08)
HA500100			1	FRONT WHEEL-RWD DOD TK1/2 (2002-08), FRONT WHEEL-4WD DOD TK1/2 (2002-08)
SP500100			2	FRONT WHEEL-RWD DOD TK1/2 (2002-08), FRONT WHEEL-4WD DOD TK1/2 (2002-08)
SP500101			2	FRONT WHEEL-RWD DOD TK1/2 (2002-08), FRONT WHEEL-4WD DOD TK1/2 (2006-08)
SP500300		N	2	FRONT WHEEL-RWD CAD TK (2006-06), FRONT WHEEL-4WD CAD TK (2002-06), CHE TK1/2 (1999-08), FRONT WHEEL-AWD CAD TK (2002-06), CHE TK1/2 (2001-09), REAR WHEEL-AWD CHE TK1/2 (1999-06)
SP500301		N	2	FRONT WHEEL-4WD CHE TK1/2 (2007-08), FRONT WHEEL-AWD CAD TK (2007-09), CHE TK1/2 (2007-07)
HA500601			2	FRONT WHEEL-4WD ROV SUV (2005-07)
HA500701			2	REAR WHEEL-RWD NIS TK PU (2005-08)
SP500701			2	FRONT WHEEL-RWD NIS TK PU (2004-08), FRONT WHEEL-4WD NIS TK PU (2004-07), FRONT WHEEL-RWD INF SUV (2004-07), FRONT WHEEL-4WD INF SUV (2004-07)
SP500702			2	REAR WHEEL-RWD NIS TK PU (2004-08), INF SUV (2004-08), REAR WHEEL-4WD INF SUV (2004-09)
SP500703		N	2	FRONT WHEEL-RWD NIS TK PU (2008-08), FRONT WHEEL-4WD NIS TK PU (2008-08), FRONT WHEEL-RWD INF SUV (2008-09), FRONT WHEEL-4WD INF SUV (2008-09)
512000		D	2	REAR WHEEL-FWD SAT Car (1991-02)
512001		B	2	REAR WHEEL-FWD BUI Car FD (1991-98), CHE Car FD (1992-05), OLD Car FD (1985-98), PON Car FD (1991-05)
512002			2	REAR WHEEL-FWD SAT Car (1991-02)
512003			2	REAR WHEEL-FWD BUI Car FD (1991-05), CAD Car FD (1991-05), CHE Car FD (1997-01), OLD Car FD (1991-03), PON Car FD (1999-05)
512005		O	2	REAR WHEEL-FWD CAD Car FD (1990-93)

Every reasonable effort has been made to ensure the accuracy of the information contained in this writing, but no liability is accepted for errors, omissions or for any other reason.

HUB UNIT BEARING / BEARING MODULE - BUYER'S GUIDE *continued*

Timken Part No.	On Hand	Pop Code	Per Car Qty	Application
512006			2	REAR WHEEL-FWD CAD Car FD (1993-02)
512008			2	REAR WHEEL-FWD ACU Car (1991-95)
512009		IW	2	REAR WHEEL-FWD LEX Car FD (1992-01), TOY Car FD (1987-04), LEX SUV (1999-03)
512010		W	2	REAR WHEEL-FWD EAG (1990-94), MIT Car FD (1990-96), PLY IM (1990-94)
512011		W	2	REAR WHEEL-FWD EAG (1990-94), MIT Car FD (1960-96), PLY IM (1990-94)
512012			2	REAR WHEEL-FWD AUD Car (2000-06), VKS Car (1998-06)
512013			2	REAR WHEEL-FWD PLY Car FD (1998-99), DOD Car FD (1998-99)
512014			2	REAR WHEEL-RWD NIS Car RD (1989-98)
512016		IW	2	REAR WHEEL-FWD NIS Car FD (1990-01)
512017			2	REAR WHEEL-FWD PEU (1989-92)
512018		D	2	REAR WHEEL-FWD CHE IM Car (1998-02), GEO Car (1993-97), TOY Car FD (1993-02)
512019		O	2	REAR WHEEL-FWD GEO Car (1993-95), TOY Car FD (1993-95)
512020			2	REAR WHEEL-FWD HON Car (1994-97)
512021			2	REAR WHEEL-FWD PLY Car FD (1995-95), DOD Car FD (1995-97)
512022			2	REAR WHEEL-FWD HON Car (1992-96)
512023			2	REAR WHEEL-FWD PLY Car FD (1995-97), DOD Car FD (1995-97)
512024			2	REAR WHEEL-FWD FOR Car FD (1995-00), MRC Car FD (1995-02)
512025		IW	2	REAR WHEEL-FWD NIS Car FD (1991-99)
512026			2	REAR WHEEL-FWD HYU Car FD (1992-98)
512027			2	REAR WHEEL-FWD HYU Car FD (1995-96)
512029			2	REAR WHEEL-FWD CHR Car FD (1993-04), EAG (1993-98), DOD Car FD (1993-04)
512031			2	REAR WHEEL-FWD ACU Car (1992-94)
512032			2	REAR WHEEL-FWD HON Car (1991-93)
512033			2	REAR WHEEL-FWD DOD IM Car (1993-95), EAG (1993-96), PLY IM (1993-94)
512036			2	REAR WHEEL-FWD SUB Car AD (1990-97)
512037			2	REAR WHEEL-FWD EAG (1991-92)
512038			2	REAR WHEEL-AWD TOY TK (1996-00)
512039			2	REAR WHEEL-FWD DOD IM Car (1991-96), MIT Car FD (1991-98)
512040			2	REAR WHEEL-FWD EAG (1992-96), MIT Car FD (1992-95), PLY IM (1992-94)

Timken Part No.	On Hand	Pop Code	Per Car Qty	Application
512041			2	REAR WHEEL-FWD TOY TK (1998-03)
512078		W	2	REAR WHEEL-FWD BUI Car FD (1994-96), CHE LT (1992-05), OLD Car FD (1994-96), OLD TK (1992-04), PON MVan (1992-04)
512105			2	REAR WHEEL-FWD FOR Car FD (1990-92), LIN Car FD (1990-92), MRC Car FD (1990-92)
512106		W	2	REAR WHEEL-FWD FOR Car FD (1990-00), MRC Car FD (1990-00)
512107		D	2	REAR WHEEL-FWD FOR Car FD (1993-04), LIN Car FD (1993-02), MRC Car FD (1993-04)
512118			2	FRONT WHEEL-RWD MAZ Car RD (1993-95), REAR WHEEL-FWD FOR Car FD (1993-97), MAZ Car FD (1993-00)
512119			2	REAR WHEEL-FWD FOR Car FD (1993-97), MAZ Car FD (1993-02)
512120			2	REAR WHEEL-FWD ACU Car (1995-98)
512121			2	REAR WHEEL-FWD ACU Car (1996-98)
512122			2	REAR WHEEL-FWD HON Car (1991-97)
512123			2	REAR WHEEL-FWD ACU Car (1996-04), HON TK (1998-98)
512124			2	REAR WHEEL-FWD HON TK (1995-97), ISU TK (1996-99)
512125			2	REAR WHEEL-AWD CHR MVan (1992-95), DOD MVan (1991-93), PLY MVan (1991-95)
512133			2	REAR WHEEL-FWD CHR Car FD (1995-97), PLY Car FD (1996-97), DOD Car FD (1995-97)
512136			2	REAR WHEEL-FWD CHR Car FD (1996-05), EAG (1995-98), MIT Car FD (1995-05), DOD Car FD (1995-05)
512137			2	REAR WHEEL-FWD TOY Car FD (1994-99)
512144			2	REAR WHEEL-FWD HON Car (1997-01)
512145			2	REAR WHEEL-FWD SAA (1994-02)
512146		O	2	REAR WHEEL-FWD SAA (1990-98)
512147			2	REAR WHEEL-FWD SAA (1982-87)
512148			2	REAR WHEEL-FWD DOD IM Car (1993-95), EAG (1993-96), MIT Car FD (1993-02), PLY IM (1993-94)
512149			2	REAR WHEEL-FWD FOR MVan (1997-03)
512150		S	2	REAR WHEEL-FWD BUI Car FD (1997-02), CHE LT (1997-05), OLD Car FD (1998-99), PON Car FD (1997-02), REAR WHEEL-RWD OLD Car FD (1998-02), REAR WHEEL-FWD PON MVan (1997-05)
512151			2	REAR WHEEL-FWD BUI Car FD (1996-03), CHE Car FD (1997-01), OLD Car FD (1997-97)
512152			2	REAR WHEEL-FWD CHE Car FD (2002-05), OLD Car FD (1999-04), PON Car FD (1999-05)
512153			2	REAR WHEEL-RWD CHE Car RD (1997-08), CAD Car RD (2004-08)

HUB UNIT BEARING / BEARING MODULE - BUYER'S GUIDE *continued*

HUB UNIT BEARING / BEARING MODULE TECHNOLOGY

Timken Part No.	On Hand	Pop Code	Per Car Qty	Application
512154			2	REAR WHEEL-FWD CHR Car FD (1995-06), PLY Car FD (1996-00), DOD Car FD (1995-06)
512155			2	REAR WHEEL-FWD CHR MVan (1996-00), DOD MVan (1996-00), PLY MVan (1996-00)
512156			2	REAR WHEEL-FWD CHR MVan (1996-00), DOD MVan (1996-00), PLY MVan (1996-00)
512157			2	REAR WHEEL-AWD CHR MVan (1997-04), DOD MVan (1996-04)
512158			2	REAR WHEEL-FWD EAG (1991-93), MIT Car FD (1989-93)
512159			2	REAR WHEEL-FWD DAE Car (1999-02)
512160			2	REAR WHEEL-FWD HYU Car FD (1996-01)
512161			2	REAR WHEEL-FWD FOR Car FD (1994-03), MAZ Car FD (1992-00), MRC Car FD (1994-99)
512162			2	REAR WHEEL-FWD FOR Car FD (2000-00), MRC Car FD (2000-00)
512163			2	REAR WHEEL-FWD FOR Car FD (2001-07), MRC Car FD (2001-05)
512164			2	REAR WHEEL-FWD FOR Car FD (2001-07), MRC Car FD (2001-05)
512165			2	REAR WHEEL-FWD HYU Car FD (1997-99)
512166		N	1	REAR WHEEL-FWD HON TK (1998-01), REAR WHEEL-4WD HON TK (1997-01)
512167			2	REAR WHEEL-FWD CHR Car FD (2000-02), CHR MVan (2001-08), PLY Car FD (2000-01), DOD Car FD (2000-05)
512168			2	REAR WHEEL-FWD CHR MVan (2001-02)
512169			2	REAR WHEEL-FWD CHR MVan (2001-07), DOD MVan (2001-07)
512170			2	REAR WHEEL-FWD CHR MVan (2001-07), DOD MVan (2001-07)
512171			2	REAR WHEEL-FWD GEO Car (1990-93), ISU Car FD (1990-93), REAR WHEEL-AWD ISU Car FD (1991-92)
512172			2	REAR WHEEL-FWD ACU Car (1997-99), HON Car (1994-97)
512173			2	REAR WHEEL-FWD ACU Car (2001-03)
512174			2	REAR WHEEL-FWD HON Car (2001-05)
512175			2	REAR WHEEL-FWD HON Car (2001-05)
512176			2	REAR WHEEL-FWD HON Car (1998-02)
512178			2	REAR WHEEL-FWD HON Car (1998-02)
512179			2	REAR WHEEL-FWD ACU Car (1999-03), HON Car (1998-02)
512180			2	REAR WHEEL-FWD HON TK (1999-04)
512181			2	REAR WHEEL-AWD EAG (1995-98), MIT Car FD (1995-06)
512182			2	REAR WHEEL-FWD SUZ Car (1989-94)

Timken Part No.	On Hand	Pop Code	Per Car Qty	Application
512183			2	REAR WHEEL-AWD SUB Car AD (2000-04), SUB TK AD (2003-06)
512185			2	REAR WHEEL-FWD MIT Car FD (1997-02)
512186			2	REAR WHEEL-FWD MAZ Car FD (1998-02)
512187			2	REAR WHEEL-FWD VKS Car (1998-04)
512188			2	REAR WHEEL-FWD ACU Car (2004-08), HON Car (2003-07)
512189			2	REAR WHEEL-FWD HYU Car FD (2001-05)
512190			2	REAR WHEEL-FWD HYU Car FD (1999-05), KIA Car (2001-06)
512191			2	REAR WHEEL-FWD HYU Car FD (1999-05), KIA Car (2001-06)
512192			2	REAR WHEEL-FWD HYU Car FD (2000-05)
512193			2	REAR WHEEL-FWD HYU Car FD (2000-05)
512194			2	REAR WHEEL-FWD HYU Car FD (2001-06)
512195			2	REAR WHEEL-FWD HYU Car FD (2001-06)
512196			2	REAR WHEEL-FWD HYU TK (2001-06)
512197			2	REAR WHEEL-FWD HYU TK (2001-06)
512198			2	REAR WHEEL-FWD HYU Car FD (2003-06)
512199			2	REAR WHEEL-FWD HYU Car FD (2003-05)
512200			2	REAR WHEEL-FWD KIA Car (1994-04)
512201			2	REAR WHEEL-FWD NIS Car FD (2002-06)
512202			2	REAR WHEEL-FWD NIS Car FD (2002-06)
512203			2	REAR WHEEL-FWD INF Car FD (2000-04), NIS Car FD (2000-03)
512204			2	REAR WHEEL-FWD CHE IM Car (1998-01), GEO Car (1995-97), SUZ Car (1995-01)
512215		S	2	REAR WHEEL-FWD PON Car AD (2003-07)
512217			2	REAR WHEEL-FWD PON Car AD (2003-08), TOY Car FD (2003-08)
512218			2	REAR WHEEL-FWD PON Car AD (2003-07), TOY Car FD (2000-08)
512220			2	REAR WHEEL-FWD CHR Car FD (1998-06), PLY Car FD (1998-00), DOD Car FD (1998-06)
512221			2	REAR WHEEL-FWD BUI Car FD (2003-05), CHE Car FD (2000-05), PON Car FD (2003-03), PON SUV (2003-05)
512222			2	REAR WHEEL-FWD BUI SUV (2002-07)
512223			2	REAR WHEEL-RWD CAD Car RD (2003-08)
512225			2	REAR WHEEL-RWD BMW5 Car (1997-08), REAR WHEEL-AWD BMW5 Car (2006-09)

HUB UNIT BEARING / BEARING MODULE - BUYER'S GUIDE *continued*

Timken Part No.	On Hand	Pop Code	Per Car Qty	Application
512229			2	REAR WHEEL-FWD CHE LT (2005-06), PON SUV (2006-07), SAT SUV (2002-07), REAR WHEEL-AWD CHE LT (2005-06), PON SUV (2006-06), SAT SUV (2002-07)
512230			2	REAR WHEEL-FWD CHE LT (2005-06), PON SUV (2006-07), SAT SUV (2002-07), REAR WHEEL-AWD SAT SUV (2002-07)
512231			2	REAR WHEEL-FWD AUD Car (2002-08), REAR WHEEL-AWD AUD Car (2005-06)
512232			2	REAR WHEEL-FWD SAA (2000-07)
512234		0	2	REAR WHEEL-RWD VLV (1995-98)
512235			2	REAR WHEEL-FWD MIT Car FD (1994-96)
512236			2	REAR WHEEL-FWD BUI SUV (2003-07)
512237			2	REAR WHEEL-FWD BUI Car FD (1997-05), CHE Car FD (2000-05), CHE LT (1997-05), OLD Car FD (1998-99), PON Car FD (1997-03), PON SUV (2001-05), REAR WHEEL-RWD OLD Car FD (1998-02), REAR WHEEL-FWD PON MVan (1997-05)
512238			2	REAR WHEEL-FWD SAT Car (2000-04)
512239			2	REAR WHEEL-FWD SAT Car (2000-04)
512242			2	REAR WHEEL-FWD HON Car (1992-96)
512251			2	REAR WHEEL-FWD KIA Car (2000-01)
512255		N	2	REAR WHEEL-FWD ACU Car (1997-01)
512265		N	2	REAR WHEEL-FWD HYU Car FD (2006-08), KIA Car (2006-07)
512266		N	2	REAR WHEEL-FWD HYU Car FD (2006-08), KIA Car (2006-07)
512267			2	REAR WHEEL-FWD HYU TK (2005-08), KIA SUV (2005-09)
512270			2	REAR WHEEL-FWD MAZ TK (2000-06), REAR WHEEL-RWD MAZ TK (2000-06)
512280		N	2	REAR WHEEL-FWD TOY TK (2004-05)
512294			2	REAR WHEEL-RWD TOY TK (2005-06), REAR WHEEL-4WD TOY TK (2005-06)
512295			2	REAR WHEEL-RWD TOY TK (2005-06), REAR WHEEL-4WD TOY TK (2005-06)
512299		N	2	REAR WHEEL-FWD FOR Car FD (2005-08), FOR Car AD (2005-07), MRC Car FD (2008-09), MRC Car AD (2005-07)
512305		N	2	FRONT WHEEL-FWD AUD Car (2000-08), FRONT WHEEL-AWD AUD Car (2000-09)
512319		N	2	REAR WHEEL-FWD AUD Car (2008-09), VKS Car (2006-09)
512322		N	2	REAR WHEEL-FWD HON Car (2006-08)
512323		N	2	REAR WHEEL-FWD HON Car (2007-08)
512324		N	2	REAR WHEEL-FWD HYU Car FD (2008-08)

Timken Part No.	On Hand	Pop Code	Per Car Qty	Application
512326		N	2	REAR WHEEL-FWD HYU TK (2007-08)
512340		N	2	REAR WHEEL-FWD HYU Car FD (2007-08)
513003			2	REAR WHEEL-FWD BUI Car FD (1982-89), CHE Car FD (1982-89), OLD Car FD (1980-89), PON Car AD (1982-89)
513004K		Z	2	FRONT WHEEL-FWD BUI Car FD (1982-84), CAD Car FD (1982-84), CHE Car FD (1982-84), OLD Car FD (1982-84), PON Car FD (1982-84)
513010		0	2	REAR WHEEL-FWD BUI Car FD (1979-85), OLD Car FD (1979-85)
513011K		D	2	FRONT WHEEL-FWD BUI Car FD (1980-89), CHE Car FD (1980-89), OLD Car FD (1980-89), PON Car FD (1980-84), PON Car AD (1982-89), REAR WHEEL-RWD PON Car RD (1984-88)
513012		D	2	REAR WHEEL-FWD BUI Car FD (1980-91), CAD Car FD (1982-88), CHE Car FD (1980-05), OLD Car FD (1982-91), PON Car FD (1980-05)
513013		D	2	FRONT WHEEL-FWD BUI Car FD (1979-85), CAD Car FD (1979-85), OLD Car FD (1979-85), FRONT WHEEL-4WD CHE LT (1983-93)
513016K		B	2	FRONT WHEEL-FWD BUI Car FD (1983-93), CAD Car FD (1985-93), CHE Car FD (1983-90), CHE LT (1990-91), OLD Car FD (1980-93), PON Car FD (1987-91), PON Car AD (1982-91), FRONT WHEEL-AWD PON Car AD (1989-90), REAR WHEEL-AWD PON Car AD (1989-90), FRONT WHEEL-FWD OLD TK (1990-91), PON MVan (1990-91)
513017K		A	2	FRONT WHEEL-FWD BUI Car FD (1984-98), CAD Car FD (1984-88), CHE Car FD (1984-05), OLD Car FD (1984-98), PON Car FD (1984-05)
513018		C	2	REAR WHEEL-FWD BUI Car FD (1983-93), CAD Car FD (1985-93), CHE Car FD (1983-02), CHE LT (1990-91), OLD Car FD (1983-94), PON Car FD (1987-96), PON Car AD (1983-91), OLD TK (1990-91), PON MVan (1990-91)
513019			2	FRONT WHEEL-RWD CHE Car RD (1984-90)
513020		W	2	REAR WHEEL-RWD CHE Car RD (1984-96)
513030		D	2	REAR WHEEL-FWD FOR Car FD (1990-03), MAZ Car FD (1990-03), MRC Car FD (1991-99)
513033		ID	2	REAR WHEEL-FWD ACU Car (1990-93), HON Car (1986-91)
513034			2	REAR WHEEL-FWD HON Car (1984-84)
513035		IC	2	REAR WHEEL-FWD HON Car (1985-00)
513038		0	2	REAR WHEEL-FWD CAD Car FD (1986-86)
513039			2	REAR WHEEL-FWD PON Car AD (1989-90)
513041		W	2	REAR WHEEL-FWD BUI Car FD (1987-90), CAD Car FD (1987-90), OLD Car FD (1987-90), PON Car FD (1987-90)
513042			2	REAR WHEEL-FWD BUI Car FD (1988-91), OLD Car FD (1988-91), PON Car FD (1988-91)
513044		A	2	FRONT WHEEL-FWD BUI Car FD (1988-96), CHE Car FD (1990-01), OLD Car FD (1988-97), PON Car FD (1988-96)

HUB UNIT BEARING / BEARING MODULE - BUYER'S GUIDE *continued*

HUB UNIT BEARING / BEARING MODULE TECHNOLOGY

Timken Part No.	On Hand	Pop Code	Per Car Qty	Application
513049			2	REAR WHEEL-FWD ACU Car (1987-90)
513050			2	REAR WHEEL-FWD ACU Car (1986-89)
513059		D	2	FRONT WHEEL-FWD BUI Car FD (1989-91), CAD Car FD (1989-92), OLD Car FD (1989-91)
513061		C	2	FRONT WHEEL-4WD CHE LT (1991-97), FRONT WHEEL-AWD CHE LT (1991-92), FRONT WHEEL-4WD OLD TK (1991-96)
513062		W	2	REAR WHEEL-FWD BUI Car FD (1991-99), CAD Car FD (1991-93), OLD Car FD (1991-99), PON Car FD (1991-99)
513063			2	FRONT WHEEL-FWD CAD Car FD (1990-93)
513070		W	2	REAR WHEEL-FWD EAG (1989-92), DOD Car FD (1990-91)
513074		C	2	FRONT WHEEL-FWD CHR MVan (1990-95), DOD MVan (1989-95), FRONT WHEEL-AWD DOD MVan (1991-93), FRONT WHEEL-FWD PLY MVan (1989-95), FRONT WHEEL-AWD PLY MVan (1991-95)
513075		B	2	FRONT WHEEL-FWD CHR Car FD (1989-95), CHR MVan (1991-95), DOD MVan (1991-95), PLY Car FD (1991-95), FRONT WHEEL-AWD DOD MVan (1991-93), FRONT WHEEL-FWD DOD Car FD (1989-95), PLY MVan (1991-95)
513076			2	FRONT WHEEL-RWD FOR Car RD (1989-90), MRC Car RD (1989-90)
513077		W	2	FRONT WHEEL-RWD FOR Car RD (1989-90), MRC Car RD (1989-90)
513080		ID	2	REAR WHEEL-FWD HON Car (1990-97)
513081		W	2	REAR WHEEL-FWD HON Car (1990-93)
513082		D	2	FRONT WHEEL-4WD DOD LT (1987-90)
513084		C	2	FRONT WHEEL-RWD JEE (1989-99), FRONT WHEEL-4WD JEE (1990-99)
513085			2	FRONT WHEEL-RWD CHE Car RD (1991-96)
513087		B	2	FRONT WHEEL-FWD BUI Car FD (1992-99), CAD Car FD (1992-96), CHE LT (1992-96), OLD Car FD (1992-99), PON Car FD (1992-99), OLD TK (1992-96), PON MVan (1992-96)
513088		D	2	FRONT WHEEL-FWD BUI Car FD (1992-92), CAD Car FD (1992-93), OLD Car FD (1992-93), PON Car FD (1992-92)
513089		C	2	FRONT WHEEL-FWD CHR Car FD (1993-04), EAG (1993-97), REAR WHEEL-RWD CHR Car RD (2001-02), PLY Car RD (1997-01), FRONT WHEEL-FWD DOD Car FD (1993-04) ABS tone ring on halfshaft assy, not on bearing. 93-04 New shaft with tone ring required. TT9000077 (tech tip)
513090		W	2	FRONT WHEEL-RWD AVA Car (2001-04), CHE Car RD (1993-02), PON Car RD (1993-02)
513092		D	2	FRONT WHEEL-RWD FOR Car RD (1991-97), LIN Car RD (1993-98), MRC Car RD (1991-97)
513093		IW	2	FRONT WHEEL-FWD ACU Car (1992-94)

Timken Part No.	On Hand	Pop Code	Per Car Qty	Application
513094			2	FRONT WHEEL-RWD BMW3 Car (1988-91), BMW5 Car (1982-88), BMW6 Car (1983-89), BMW7 Car (1986-87)
513096			2	FRONT WHEEL-RWD BMW5 Car (1989-93), BMW7 Car (1987-91), BMW8 Car (1991-92)
513098		IA	2	FRONT WHEEL-FWD ACU Car (1997-99), HON Car (1990-97)
513099			2	FRONT WHEEL-RWD ACU Car (1991-05)
513100		A	2	FRONT WHEEL-FWD FOR Car FD (1996-07), LIN Car FD (1995-02), MRC Car FD (1996-05)
513104		C	2	FRONT WHEEL-RWD FOR Car RD (1992-97), LIN Car RD (1992-97), MRC Car RD (1992-97)
513105		IW	2	REAR WHEEL-FWD ACU Car (1990-01), HON Car (1993-00)
513107		B	2	FRONT WHEEL-4WD JEE (1984-89)
513109			2	FRONT WHEEL-RWD DOD Car RD (1992-95), FRONT WHEEL-4WD DOD LT (1990-96), REAR WHEEL-RWD DOD Car RD (1992-08)
513111		ID	2	FRONT WHEEL-RWD BMW3 Car (1984-91)
513115		W	2	FRONT WHEEL-RWD FOR Car RD (1994-04)
513121			2	FRONT WHEEL-FWD BUI Car FD (1997-02), CAD Car FD (1997-01), CHE Car FD (2000-01), CHE LT (1997-01), OLD Car FD (1996-01), PON Car FD (1997-01), REAR WHEEL-AWD BUI SUV (2002-06), CHE LT (2002-05), PON SUV (2001-05), FRONT WHEEL-FWD OLD TK (1997-01), PON MVan (1997-01), REAR WHEEL-AWD OLD TK (2002-04), PON MVan (2002-05)
513122			2	FRONT WHEEL-FWD CHR MVan (1996-00), DOD MVan (1996-00), PLY MVan (1996-00)
513123			2	FRONT WHEEL-FWD CHR MVan (1996-07), DOD MVan (1996-07), FRONT WHEEL-RWD CHR Car RD (2001-02), PLY Car RD (1997-01), FRONT WHEEL-FWD PLY MVan (1996-00)
513124		W	2	FRONT WHEEL-4WD CHE LT (1997-05), ISU TK (1998-00), FRONT WHEEL-AWD CHE LT (1997-97), FRONT WHEEL-4WD OLD TK (1997-01)
513125			2	FRONT WHEEL-RWD BMW3 Car (1992-05), BMW5 Car (1991-95), BMW7 Car (1992-94), BMW8 Car (1992-97)
513126			2	FRONT WHEEL-FWD SAA (1990-98)
513127			2	FRONT WHEEL-FWD SAA (1986-89)
513128			2	FRONT WHEEL-RWD VLV (1988-95)
513131			2	FRONT WHEEL-FWD MAZ Car RD (1992-95), MAZ TK (1989-98), FRONT WHEEL-RWD MAZ TK (1989-98), REAR WHEEL-FWD MAZ Car FD (2001-02), MAZ TK (2000-06), REAR WHEEL-RWD MAZ TK (2000-06)
513132			2	FRONT WHEEL-RWD DOD Car RD (1996-08)
513133			2	FRONT WHEEL-AWD DOD IM Car (1991-96), MIT Car FD (1991-06)
513135			2	FRONT WHEEL-FWD MIT Car FD (1996-03)

HUB UNIT BEARING / BEARING MODULE - BUYER'S GUIDE *continued*

Timken Part No.	On Hand	Pop Code	Per Car Qty	Application
513137			2	FRONT WHEEL-FWD CHE Car FD (1997-05), OLD Car FD (1999-04), PON Car FD (1999-05)
513138			2	FRONT WHEEL-FWD CHR Car FD (1995-06), PLY Car FD (1996-00), DOD Car FD (1995-06)
513139			2	FRONT WHEEL-RWD CHE Car RD (1997-08), CAD Car RD (2004-08)
513142			2	REAR WHEEL-FWD EAG (1988-89)
513152			2	FRONT WHEEL-RWD MAZ Car RD (1990-05)
513155			2	FRONT WHEEL-RWD MAZ Car RD (1991-05)
513156			2	FRONT WHEEL-FWD FOR MVan (1999-03)
513157			2	FRONT WHEEL-FWD CHR Car FD (1995-05), EAG (1995-98), MIT Car FD (1995-07), FRONT WHEEL-AWD EAG (1995-98), MIT Car FD (1995-99), FRONT WHEEL-FWD DOD Car FD (1995-05)
513160		S	2	FRONT WHEEL-FWD BUI Car FD (2003-04), CHE Car FD (1997-05), CHE LT (2003-05), PON MVan (2003-03)
BM513161			2	FRONT WHEEL-FWD HON Car (2000-06)
513161				
513173			2	FRONT WHEEL-RWD BMW7 Car (2002-08)
513175			2	FRONT WHEEL-FWD VLV (1999-07), FRONT WHEEL-AWD VLV (1999-00)
513179			2	FRONT WHEEL-FWD BUI Car FD (2001-05), CAD Car FD (2001-05), CHE Car FD (2002-05), CHE LT (2001-05), OLD Car FD (2001-03), PON Car FD (2001-05), OLD TK (2001-04), PON MVan (2001-05), FRONT WHEEL-AWD OLD TK (2002-04), PON MVan (2002-05)
513186			2	FRONT WHEEL-RWD CAD Car RD (2003-08)
513187			2	FRONT WHEEL-FWD BUI SUV (2002-07), CHE LT (2002-04), PON SUV (2001-05), FRONT WHEEL-AWD PON SUV (2001-05)
513188			2	FRONT WHEEL-RWD BUI SUV (2004-07), CHE LT (2002-07), ISU TK (2003-08), FRONT WHEEL-4WD CHE LT (2002-09), ISU TK (2003-08), FRONT WHEEL-AWD BUI SUV (2004-07), SAA (2005-08), FRONT WHEEL-4WD OLD TK (2002-04)
513189			2	FRONT WHEEL-FWD CHE LT (2005-06), PON SUV (2006-07), SAT SUV (2002-07), FRONT WHEEL-AWD CHE LT (2005-06), PON SUV (2006-06), SAT SUV (2002-07)
513190			2	FRONT WHEEL-FWD CHE LT (2005-06), PON SUV (2006-07), SAT SUV (2002-07), FRONT WHEEL-AWD CHE LT (2005-06), PON SUV (2006-06), SAT SUV (2002-07)
513191			2	FRONT WHEEL-FWD SAA (2003-06), FRONT WHEEL-AWD SAA (2008-09)
513192			2	FRONT WHEEL-FWD SAA (2002-07)
513193			2	FRONT WHEEL-RWD SUZ SUV (2001-05), FRONT WHEEL-4WD SUZ SUV (2001-06), FRONT WHEEL-RWD CHE IM SUV (2001-04), FRONT WHEEL-4WD CHE IM SUV (2001-04)

Timken Part No.	On Hand	Pop Code	Per Car Qty	Application
513194			2	FRONT WHEEL-FWD VLV (1999-07), FRONT WHEEL-AWD VLV (2000-07)
513196			2	FRONT WHEEL-RWD FOR Car RD (2003-05), LIN Car RD (2003-05), MRC Car RD (2003-03)
513202			2	FRONT WHEEL-RWD FOR Car RD (1997-02), LIN Car RD (1997-02), MRC Car RD (1997-02)
513209		N	2	FRONT WHEEL-RWD BMW5 Car (2000-03)
513210		N	2	FRONT WHEEL-RWD BMW5 Car (2004-08), BMW6 Car (2004-08), FRONT WHEEL-AWD BMW5 Car (2006-09)
513226		N	2	FRONT WHEEL-FWD MIN Car (2002-08)
513230		N	2	FRONT WHEEL-RWD FOR Car RD (2005-08), LIN Car RD (2006-08), MRC Car RD (2004-08)
513256		N	2	FRONT WHEEL-FWD HYU TK (2007-08), FRONT WHEEL-AWD HYU TK (2007-09), REAR WHEEL-AWD HYU TK (2007-09)
513262		N	2	FRONT WHEEL-FWD AUD Car (2009-09), FRONT WHEEL-AWD AUD Car (2006-09), FRONT WHEEL-FWD VKS Car (2006-09)
513266		N	2	FRONT WHEEL-FWD HYU TK (2007-08), FRONT WHEEL-AWD HYU TK (2007-09)
515000		D	2	FRONT WHEEL-4WD FOR LT (1990-97)
515001		C	2	FRONT WHEEL-4WD CHE TK1/2 (1988-94), CHE TK3/4 (1988-94)
515002		B	2	FRONT WHEEL-4WD CHE TK1/2 (1988-91)
515005			2	FRONT WHEEL-AWD CHE LT (1990-94)
515006		B	2	FRONT WHEEL-4WD DOD TK1/2 (1994-99)
515014			2	FRONT WHEEL-4WD FOR LT (2000-08), MAZ TK (2000-08)
515017			2	FRONT WHEEL-4WD FOR TK1/2 (1997-00)
515020			2	FRONT WHEEL-4WD FOR FSUV (2000-05), FOR TK3/4 (1999-04), FOR TK1 (1999-04), FOR TK1+ (1999-04)
515021			2	FRONT WHEEL-4WD FOR TK3/4 (1999-04), FOR TK1 (1999-04), FOR TK1+ (1999-04)
515022			2	FRONT WHEEL-4WD FOR TK1/2 (2000-03), FOR TK3/4 (1997-99)
515025			2	FRONT WHEEL-4WD FOR TK1 (1999-04), FOR TK1+ (1999-04)
515026			2	FRONT WHEEL-4WD FOR LT (1998-00), MAZ TK (1998-00)
515027			2	FRONT WHEEL-4WD FOR LT (1998-00), MAZ TK (1998-00)
515028			2	FRONT WHEEL-4WD FOR TK1/2 (2000-03)
515029			2	FRONT WHEEL-4WD FOR TK1/2 (2000-03)
515030		B	2	FRONT WHEEL-4WD FOR TK1/2 (2000-03), FOR TK3/4 (1997-99)
515031			2	FRONT WHEEL-4WD FOR FSUV (2000-02), LIN TK (2000-02)

HUB UNIT BEARING / BEARING MODULE - BUYER'S GUIDE *continued*

HUB UNIT BEARING / BEARING MODULE TECHNOLOGY

Timken Part No.	On Hand	Pop Code	Per Car Qty	Application
518500		D	2	FRONT WHEEL-FWD CHR Car FD (1982-83), PLY Car FD (1978-90), DOD Car FD (1979-90)
518501		D	2	FRONT WHEEL-FWD CHR Car FD (1984-90), CHR IM Car (1989-91), CHR MVan (1988-90), DOD MVan (1984-90), PLY Car FD (1984-90), DOD Car FD (1984-90), PLY MVan (1984-90)
518502		C	2	FRONT WHEEL-FWD CHR Car FD (1984-90), CHR IM Car (1989-91), CHR MVan (1988-90), DOD MVan (1984-90), PLY Car FD (1984-90), DOD Car FD (1984-90), PLY MVan (1984-90)
518503		C	2	FRONT WHEEL-FWD FOR Car FD (1983-94), FRONT WHEEL-AWD FOR Car AD (1983-94), FRONT WHEEL-FWD MRC Car FD (1983-87), MRC Car AD (1984-94), FRONT WHEEL-AWD MRC Car AD (1984-94)
518504		W	2	FRONT WHEEL-FWD HON Car (1981-83)
518505			2	FRONT WHEEL-FWD HON Car (1986-89)
518506			2	FRONT WHEEL-FWD TOY Car FD (1983-91), FRONT WHEEL-AWD TOY Car FD (1983-91)
518507			2	FRONT WHEEL-FWD CHE IM Car (1998-02), GEO Car (1993-97), TOY Car FD (1988-02), FRONT WHEEL-AWD TOY Car FD (1988-92)
520000		C	2	FRONT WHEEL-FWD FOR Car FD (1986-91), LIN Car FD (1988-91), MRC Car FD (1986-91)
520100		D	2	FRONT WHEEL-FWD FOR Car FD (1991-95), LIN Car FD (1991-94), MRC Car FD (1991-95)
SP550100			1	FRONT WHEEL-4WD DOD TK1/2 (1997-99)
SP550101			1	FRONT WHEEL-4WD DOD TK1/2 (1997-99)
SP550102			2	FRONT WHEEL-4WD DOD TK1/2 (2000-01)
SP550103			2	FRONT WHEEL-RWD DOD TK3/4 (2003-05), DOD TK1 (2003-05)
SP550104		N	2	FRONT WHEEL-RWD DOD TK1/2 (2006-08), DOD TK3/4 (2006-08), DOD TK1 (2006-08)
SP550200			2	FRONT WHEEL-4WD FOR TK1/2 (1997-00)
SP550201			2	FRONT WHEEL-4WD FOR FSUV (1997-00), LIN TK (1998-00)
SP550202			2	FRONT WHEEL-4WD FOR FSUV (2003-06), LIN TK (2003-06)
SP550203			2	REAR WHEEL-RWD FOR FSUV (2003-06), LIN TK (2003-06), REAR WHEEL-4WD LIN TK (2003-06)
SP550206		N	2	FRONT WHEEL-RWD FOR FSUV (2003-06), LIN TK (2003-06)
SP550207		N	2	FRONT WHEEL-4WD FOR TK1/2 (2004-05), LIN TK (2006-08)
SP550208		N	2	FRONT WHEEL-4WD FOR TK1/2 (2005-08), LIN TK (2006-08)
SP550209		N	2	REAR WHEEL-RWD FOR FSUV (2007-08), LIN TK (2007-08), REAR WHEEL-4WD LIN TK (2007-09)
SP550210		N	2	FRONT WHEEL-4WD FOR FSUV (2007-08), LIN TK (2007-08)
SP550211		N	2	FRONT WHEEL-RWD FOR FSUV (2007-08), LIN TK (2007-08)

Timken Part No.	On Hand	Pop Code	Per Car Qty	Application
SP550212		N	2	FRONT WHEEL-4WD FOR TK1/2 (2004-05)
SP550213		N	2	FRONT WHEEL-4WD FOR TK1/2 (2004-05)
SP550214		N	2	FRONT WHEEL-4WD FOR TK1/2 (2009-09)
SP550215		N	2	FRONT WHEEL-RWD FOR TK1/2 (2009-09), FRONT WHEEL-4WD FOR TK1/2 (2009-09)
SP550216		N	2	FRONT WHEEL-RWD FOR TK1/2 (2009-09)
SP550300		S	2	FRONT WHEEL-RWD CAD TK (1999-00), FRONT WHEEL-4WD CAD TK (1999-00), CHE TK3/4 (1995-00)
SP550301		S	2	FRONT WHEEL-4WD CAD TK (1999-00), CHE TK3/4 (1995-00)
SP550305		S	2	FRONT WHEEL-RWD CAD TK (2002-05), CHE TK1/2 (2000-07), CHE TK3/4 (2003-05)
SP550307			2	FRONT WHEEL-RWD CAD TK (1999-00), FRONT WHEEL-4WD CAD TK (1999-06), CHE TK1/2 (1995-99), FRONT WHEEL-AWD CAD TK (2006-06), FRONT WHEEL-4WD CHE TK3/4 (1995-00)
SP550308			2	FRONT WHEEL-AWD CHE LT (1995-02)
SP550309			1	FRONT WHEEL-AWD CHE LT (2003-05)
SP550310			1	FRONT WHEEL-AWD CHE LT (2003-05)
SP550311		N	2	FRONT WHEEL-4WD HUM (2006-07)
SP580100			1	FRONT WHEEL-4WD DOD TK3/4 (1998-99)
SP580101			1	FRONT WHEEL-4WD DOD TK3/4 (1998-99)
SP580102			1	FRONT WHEEL-4WD DOD TK1 (1998-99)
SP580103			1	FRONT WHEEL-4WD DOD TK1 (1998-99)
SP580204			2	FRONT WHEEL-4WD FOR TK3/4 (1999-99), FOR TK1 (1999-99), FOR TK1+ (1999-99)
SP580205			2	FRONT WHEEL-4WD FOR FSUV (2000-05), FOR TK3/4 (1999-04), FOR TK1 (1999-04), FOR TK1+ (1999-04)
SP580300			2	FRONT WHEEL-4WD CHE TK1 (1995-95), CHE TK3/4 (1995-95)
SP580301			2	FRONT WHEEL-4WD CHE TK1 (1995-95), CHE TK3/4 (1995-95)
SP580302			2	FRONT WHEEL-4WD CHE TK1/2 (1996-99), CHE TK1 (1996-00), CHE TK3/4 (1996-00)
SP580303			2	FRONT WHEEL-4WD CHE TK1/2 (1996-99), CHE TK1 (1996-00), CHE TK3/4 (1996-00)
SP580304		S	2	FRONT WHEEL-4WD CHE TK1/2 (2001-07), CHE TK1 (2004-07), HUM (2003-07), FRONT WHEEL-AWD HUM (2003-03), FRONT WHEEL-4WD CHE TK3/4 (1999-07)
SP580305		S	2	FRONT WHEEL-RWD CHE TK3/4 (2001-07)
SP580306		S	2	FRONT WHEEL-RWD CHE TK3/4 (2001-06)
SP580307		S	2	FRONT WHEEL-RWD CHE TK3/4 (1999-00)

HUB UNIT BEARING / BEARING MODULE - BUYER'S GUIDE *continued*

Timken Part No.	On Hand	Pop Code	Per Car Qty	Application
SP580308		S	2	FRONT WHEEL-RWD CHE TK1 (2001-07)
SP580309		S	2	FRONT WHEEL-4WD CHE TK1 (2001-06)
SP580310		N	2	FRONT WHEEL-RWD CHE TK1/2 (2001-07), FRONT WHEEL-4WD CHE TK1/2 (2001-07), CHE TK1 (2004-07), HUM (2003-07), FRONT WHEEL-AWD HUM (2003-03), FRONT WHEEL-RWD CHE TK3/4 (2001-07), FRONT WHEEL-4WD CHE TK3/4 (1999-09)
SP580311		N	2	FRONT WHEEL-RWD CHE TK1 (2001-07), FRONT WHEEL-4WD CHE TK1 (2001-07)
SP580312		N	2	FRONT WHEEL-4WD HUM (2008-09), FRONT WHEEL-RWD CHE TK3/4 (2008-08), FRONT WHEEL-4WD CHE TK3/4 (2008-08)
SP580313		N	2	FRONT WHEEL-RWD CHE TK1 (2008-08), FRONT WHEEL-4WD CHE TK1 (2008-08)
HA590000			2	FRONT WHEEL-RWD DOD TK3/4 (2000-02), DOD TK1 (2000-02)
HA590001			2	FRONT WHEEL-RWD DOD TK1/2 (2000-01)
HA590002			2	REAR WHEEL-AWD PON Car AD (2003-06), TOY Car FD (2003-06)
HA590003		N	2	REAR WHEEL-RWD CHE TK1/2 (2002-05)
HA590004			2	REAR WHEEL-RWD CHE TK3/4 (2003-05), REAR WHEEL-4WD CHE TK3/4 (2003-05)
HA590005			2	REAR WHEEL-FWD ACU Car (2002-06), HON Car (2004-05)
HA590006			2	FRONT WHEEL-RWD PON Car RD (2004-06) R. H. Application FRONT WHEEL
HA590007			2	FRONT WHEEL-RWD PON Car RD (2004-06) L. H. Application FRONT WHEEL
HA590009			2	REAR WHEEL-FWD HON Car (2002-03)
HA590010			2	REAR WHEEL-FWD KIA Car (2004-06)
HA590011			2	REAR WHEEL-FWD KIA Car (2002-05)
HA590012			2	REAR WHEEL-FWD KIA Car (2002-03)
HA590013			2	REAR WHEEL-FWD KIA Car (2003-05)
HA590016		N	2	REAR WHEEL-FWD KIA Car (2006-08), HYU TK (2007-08)
HA590017			2	FRONT WHEEL-RWD AVA Car (2005-07), FOR Car RD (2005-08)
HA590018			2	FRONT WHEEL-RWD DOD TK1 (1994-99), FRONT WHEEL-4WD DOD TK1 (1994-99)
HA590019			2	REAR WHEEL-FWD ACU Car (2004-08), HON Car (2005-07)
HA590020			2	FRONT WHEEL-4WD DOD TK3/4 (1994-99)
HA590021			2	REAR WHEEL-FWD FOR MVan (2004-07), MRC Mvan (2004-07)
HA590022		S	1	REAR WHEEL-FWD FOR MVan (2004-07), MRC Mvan (2004-07)
HA590023			1	FRONT WHEEL-4WD CHE LT (2004-08), ISU TK (2006-08)

Timken Part No.	On Hand	Pop Code	Per Car Qty	Application
HA590024			2	FRONT WHEEL-FWD FOR MVan (2004-07), MRC Mvan (2004-07)
HA590025			2	FRONT WHEEL-FWD FOR MVan (2004-07), MRC Mvan (2004-07)
HA590026			2	FRONT WHEEL-RWD FOR Car RD (2005-08)
HA590027			2	FRONT WHEEL-RWD INF Car RD (2003-07), NIS Car RD (2003-08)
HA590028			2	FRONT WHEEL-FWD FOR Car FD (2005-08), FOR Car AD (2005-07), FRONT WHEEL-AWD FOR Car AD (2005-09), FRONT WHEEL-FWD MRC Car FD (2008-08), MRC Car AD (2005-07), FRONT WHEEL-AWD MRC Car FD (2008-09), MRC Car AD (2005-07)
HA590029			2	REAR WHEEL-4WD FOR Car FD (2005-08), REAR WHEEL-AWD FOR Car AD (2005-09), MRC Car FD (2008-09), MRC Car AD (2005-07)
HA590030			2	FRONT WHEEL-RWD CHR Car RD (2005-08), DOD Car RD (2005-08)
HA590032			2	FRONT WHEEL-4WD DOD TK3/4 (2003-05), DOD TK1 (2003-05)
HA590033			2	FRONT WHEEL-RWD DOD LT (2004-05), FRONT WHEEL-4WD DOD LT (2004-05)
HA590034			2	FRONT WHEEL-RWD DOD LT (2005-08), MIT TK (2006-08), FRONT WHEEL-4WD DOD LT (2005-08), MIT TK (2006-08), FRONT WHEEL-AWD MIT TK (2006-06)
HA590035			2	FRONT WHEEL-RWD DOD LT (2005-08), MIT TK (2006-08), FRONT WHEEL-4WD DOD LT (2005-08), MIT TK (2006-08), FRONT WHEEL-AWD MIT TK (2006-06)
HA590036			2	FRONT WHEEL-RWD JEE (2005-08), FRONT WHEEL-4WD JEE (2005-08)
HA590038			2	REAR WHEEL-FWD FOR Car FD (2005-07), MRC Car FD (2005-05)
HA590039			2	REAR WHEEL-4WD MIT TK (2001-06)
HA590040			2	REAR WHEEL-FWD SCI (2005-07), TOY Car FD (2000-05)
HA590041		N	2	REAR WHEEL-FWD MAZ TK (2007-08)
HA590043			2	REAR WHEEL-FWD NIS Car FD (1998-01)
HA590044			2	REAR WHEEL-AWD NIS TK (2003-07)
HA590045			2	REAR WHEEL-FWD NIS TK (2003-07)
HA590046			2	FRONT WHEEL-FWD NIS TK (2003-08), FRONT WHEEL-AWD NIS TK (2003-08)
HA590047			2	REAR WHEEL-FWD NIS Car FD (1998-01)
HA590048		S	2	FRONT WHEEL-FWD BUI SUV (2003-07), PON SUV (2003-05), FRONT WHEEL-AWD PON SUV (2003-05)
HA590049			2	FRONT WHEEL-RWD CAD Car RD (2005-07), FRONT WHEEL-AWD CAD Car RD (2005-09)
HA590050			2	REAR WHEEL-RWD TOY TK (2003-09), REAR WHEEL-4WD TOY TK (2003-09), LEX SUV (2003-08)

HUB UNIT BEARING / BEARING MODULE - BUYER'S GUIDE *continued*

HUB UNIT BEARING / BEARING MODULE TECHNOLOGY

Timken Part No.	On Hand	Pop Code	Per Car Qty	Application
HA590052		N	2	REAR WHEEL-FWD KIA Car (2008-08)
HA590053			2	FRONT WHEEL-RWD CHE LT (2004-08)
HA590054			2	FRONT WHEEL-RWD CHE LT (2004-08), ISU TK (2006-08)
HA590055			2	REAR WHEEL-FWD TOY Car FD (2004-06)
HA590055K			2	FRONT WHEEL-RWD VLV (1988-88)
HA590056		N	2	REAR WHEEL-AWD MAZ TK (2007-09)
HA590056K			2	FRONT WHEEL-RWD VLV (1989-94)
HA590057			2	REAR WHEEL-FWD MRC Mvan (1997-02), NIS TK (1999-02)
HA590058			2	FRONT WHEEL-RWD CHE LT (2004-08), ISU TK (2006-08)
HA590059			2	FRONT WHEEL-RWD CHE LT (2004-08), ISU TK (2006-08)
HA590060			1	FRONT WHEEL-4WD CHE LT (2004-08), ISU TK (2006-08)
HA590061			2	FRONT WHEEL-RWD CHE LT (2004-08)
HA590062			2	FRONT WHEEL-RWD CHE LT (2004-08), ISU TK (2006-08)
HA590063			2	REAR WHEEL-FWD TOY Car FD (2001-03)
HA590064			2	FRONT WHEEL-FWD TOY Car FD (2004-06)
HA590066			2	REAR WHEEL-FWD CHE Car FD (2005-08), PON Car FD (2007-08), SAT Car (2003-07)
HA590067			2	REAR WHEEL-FWD CHE Car FD (2005-08), PON Car FD (2007-08), SAT Car (2003-07)
HA590068			2	FRONT WHEEL-FWD CHE Car FD (2005-08), PON Car FD (2007-08), SAT Car (2003-07)
HA590069			2	FRONT WHEEL-FWD CHE Car FD (2005-08), PON Car FD (2007-08), SAT Car (2003-07)
HA590070			2	FRONT WHEEL-FWD CHE Car FD (2004-08), PON Car FD (2005-08), SAT Car (2007-09)
HA590071			2	FRONT WHEEL-FWD CHE Car FD (2004-08), PON Car FD (2006-07)
HA590072			2	FRONT WHEEL-FWD MAZ Car FD (2004-06)
HA590074			2	REAR WHEEL-FWD BUI Car FD (2005-08), CHE Car FD (2006-07), PON Car FD (2004-08)
HA590077			2	FRONT WHEEL-RWD CAD TK (2004-09), CAD Car RD (2004-08), FRONT WHEEL-AWD CAD Car RD (2005-09)
HA590078			2	FRONT WHEEL-AWD CAD TK (2004-09)
HA590079			2	REAR WHEEL-RWD CAD TK (2004-09), REAR WHEEL-AWD CAD TK (2004-09), REAR WHEEL-RWD CAD Car RD (2005-08)
HA590080			2	REAR WHEEL-FWD CHE Car FD (2004-08), PON Car FD (2005-08)
HA590081			2	REAR WHEEL-FWD CHE Car FD (2004-07), PON Car FD (2005-08), SAT Car (2007-09)

Timken Part No.	On Hand	Pop Code	Per Car Qty	Application
HA590082			2	REAR WHEEL-RWD CAD Car RD (2004-07)
HA590085			2	FRONT WHEEL-FWD BUI Car FD (2003-08), BUI SUV (2003-07), CHE Car FD (1997-07), CHE LT (2003-05), PON Car FD (2001-08), PON SUV (2003-05), FRONT WHEEL-AWD PON SUV (2003-05), FRONT WHEEL-FWD PON MVan (2003-03)
HA590086			2	FRONT WHEEL-FWD CHE Car FD (2005-08), CHE LT (2006-08), PON Car FD (2007-08), SAT Car (2004-07)
HA590087			2	FRONT WHEEL-FWD CHE LT (2006-08)
HA590088			2	REAR WHEEL-FWD CHE Car FD (2005-09), CHE LT (2006-08), PON Car FD (2007-09), SAT Car (2004-07)
HA590089			2	REAR WHEEL-FWD CHE LT (2006-08)
HA590091			2	REAR WHEEL-FWD BUI MVan (2005-05), CHE LT (2005-05), SAT SUV (2005-05), PON MVan (2005-06)
HA590092			2	REAR WHEEL-FWD BUI Car FD (2005-08), BUI MVan (2005-05), CHE Car FD (2006-07), CHE LT (2005-05), PON Car FD (2004-08), SAT SUV (2005-05), PON MVan (2005-06)
HA590093			2	FRONT WHEEL-FWD BUI Car FD (2005-08), BUI MVan (2005-05), CAD Car FD (2006-08), CHE Car FD (2006-08), CHE LT (2005-05), PON Car FD (2004-08), SAT SUV (2005-05), FRONT WHEEL-AWD BUI MVan (2005-05), CHE LT (2005-05), SAT SUV (2005-05), REAR WHEEL-AWD BUI MVan (2005-05), CHE LT (2005-05), SAT SUV (2005-05), FRONT WHEEL-FWD PON MVan (2005-05), FRONT WHEEL-AWD PON MVan (2005-05), REAR WHEEL-AWD PON MVan (2005-05)
HA590095			2	REAR WHEEL-FWD FOR Car FD (2006-09), LIN Car FD (2006-08), MAZ Car FD (2005-08), MRC Car AD (2006-09)
HA590096			2	FRONT WHEEL-RWD MAZ Car RD (2004-08)
HA590097			2	FRONT WHEEL-FWD MAZ Car FD (2004-08)
HA590098			2	REAR WHEEL-FWD MAZ Car FD (2004-06)
HA590099			2	REAR WHEEL-FWD MAZ Car FD (2004-08)
HA590100			2	REAR WHEEL-FWD LIN Car FD (2006-08), MAZ Car FD (2003-08), MRC Car AD (2006-09)
HA590101			2	REAR WHEEL-FWD MIT Car FD (2002-06)
HA590102		0	2	REAR WHEEL-FWD SAA (1986-89)
HA590103			2	REAR WHEEL-FWD MIT Car FD (2004-06), MIT TK (2003-06)
HA590104			2	REAR WHEEL-FWD MIT Car FD (2002-06)
HA590106		N	2	FRONT WHEEL-FWD AUD Car (2008-09), FRONT WHEEL-AWD AUD Car (2008-09), REAR WHEEL-AWD AUD Car (2008-09), FRONT WHEEL-FWD VKS Car (2005-09), FRONT WHEEL-AWD VKS Car (2005-08), REAR WHEEL-AWD VKS Car (2006-09)
HA590107			2	REAR WHEEL-FWD MIT Car FD (1997-04)

HUB UNIT BEARING / BEARING MODULE - BUYER'S GUIDE *continued*

Timken Part No.	On Hand	Pop Code	Per Car Qty	Application
HA590108			2	FRONT WHEEL-FWD MIT Car FD (2004-08), MIT TK (2004-09), FRONT WHEEL-AWD MIT TK (2004-06)
HA590109			2	REAR WHEEL-FWD NIS TK (2004-08)
HA590110			2	REAR WHEEL-FWD NIS Car FD (2000-06)
HA590111			2	REAR WHEEL-FWD NIS Car FD (2004-08)
HA590112			2	REAR WHEEL-FWD SUZ Car (2004-08)
HA590113			2	REAR WHEEL-FWD SUZ Car (2004-08)
HA590115			2	FRONT WHEEL-FWD SUZ Car (2004-05)
HA590116		N	2	REAR WHEEL-FWD BUI MVan (2007-07), CHE LT (2006-06), SAT SUV (2006-07)
HA590118			2	FRONT WHEEL-FWD SUB Car AD (2005-08), FRONT WHEEL-AWD SUB Car AD (2005-08)
HA590119			2	REAR WHEEL-AWD SUB Car AD (2005-09)
HA590120			2	REAR WHEEL-AWD MIT TK (2004-09)
HA590123			2	REAR WHEEL-FWD INF Car FD (1999-02)
HA590124			2	FRONT WHEEL-RWD INF SUV (2003-08)
HA590125			2	FRONT WHEEL-AWD INF SUV (2003-08)
HA590126			2	FRONT WHEEL-RWD INF Car RD (2002-06)
HA590127			2	FRONT WHEEL-RWD INF Car RD (2003-03)
HA590128			2	REAR WHEEL-FWD MIT Car FD (2004-07)
HA590129		N	2	REAR WHEEL-FWD MIT Car FD (2004-06)
HA590131		N	2	FRONT WHEEL-FWD SUZ Car (2004-05)
HA590132			2	FRONT WHEEL-4WD FOR TK3/4 (1999-99), FOR TK1 (1999-99), FOR TK1+ (1999-99)
HA590136		N	2	REAR WHEEL-RWD LEX Car RD (2006-08), REAR WHEEL-AWD LEX Car RD (2006-09)
HA590137		N	2	FRONT WHEEL-RWD LEX Car RD (2006-08)
HA590138		N	2	FRONT WHEEL-RWD LEX Car RD (2006-08)
HA590139		N	2	FRONT WHEEL-AWD LEX Car RD (2006-08)
HA590140		N	2	FRONT WHEEL-AWD LEX Car RD (2006-08)
HA590141			2	REAR WHEEL-RWD JEE (2005-08)
HA590142			2	FRONT WHEEL-AWD CHR Car RD (2005-09), DOD Car RD (2005-08), REAR WHEEL-RWD CHR Car RD (2005-08), DOD Car RD (2005-08), REAR WHEEL-AWD CHR Car RD (2005-09), DOD Car RD (2005-08)
HA590143		N	2	REAR WHEEL-FWD MIT TK (2004-09)
HA590144		N	2	REAR WHEEL-FWD MIT TK (2004-05)

Timken Part No.	On Hand	Pop Code	Per Car Qty	Application
HA590145			2	FRONT WHEEL-4WD MIT TK (2001-06)
HA590146			2	REAR WHEEL-AWD ACU Car (2005-08)
HA590147			2	FRONT WHEEL-AWD ACU Car (2005-08)
HA590149		N	2	REAR WHEEL-FWD BUI Car FD (2006-08), CAD Car FD (2006-08)
HA590150		N	2	FRONT WHEEL-AWD SUB TK AD (2006-09), REAR WHEEL-AWD SUB TK AD (2006-07)
HA590151		N	2	REAR WHEEL-FWD HON TK (2005-08)
HA590152		N	2	REAR WHEEL-FWD HON Car (2006-08)
HA590153		N	2	REAR WHEEL-FWD NIS Car FD (1997-99)
HA590154		N	2	REAR WHEEL-FWD NIS Car FD (1995-99)
HA590155K			2	FRONT WHEEL-FWD SAT Car (1991-93)
HA590156		N	2	FRONT WHEEL-RWD FOR LT (2006-08), FRONT WHEEL-4WD FOR LT (2006-08)
HA590156K			2	FRONT WHEEL-FWD SAT Car (1994-02)
HA590156		N	2	FRONT WHEEL-RWD MRC SUV (2006-08), FRONT WHEEL-4WD MRC SUV (2006-08), FRONT WHEEL-AWD MRC SUV (2006-09)
HA590157		N	2	FRONT WHEEL-FWD BUI MVan (2006-07), CHE LT (2006-08), SAT SUV (2006-07), FRONT WHEEL-AWD BUI MVan (2006-06), CHE LT (2006-08), SAT SUV (2006-07), REAR WHEEL-AWD BUI MVan (2006-06), CHE LT (2006-06), SAT SUV (2006-06), FRONT WHEEL-FWD PON MVan (2006-06), FRONT WHEEL-AWD PON MVan (2006-06), REAR WHEEL-AWD PON MVan (2006-06)
HA590158		N	2	REAR WHEEL-FWD BUI MVan (2006-06), CHE LT (2006-08)
HA590159		N	2	REAR WHEEL-FWD AUD Car (2006-09), VKS Car (2006-09)
HA590160			2	REAR WHEEL-FWD SUZ Car (1995-05)
HA590161		N	2	REAR WHEEL-FWD MIN Car (2002-08)
HA590162		N	2	FRONT WHEEL-RWD BMW3 Car (2006-08), BMW1 Car (2008-08)
HA590163		N	2	FRONT WHEEL-RWD BMW5 Car (2006-08), BMW6 Car (2006-08)
HA590164		N	2	REAR WHEEL-FWD HON Car (2006-07)
HA590165		N	2	FRONT WHEEL-FWD SCI (2004-09), TOY TK (2006-07), FRONT WHEEL-4WD TOY TK (2006-07)
HA590166		N	2	FRONT WHEEL-4WD DOD TK1/2 (2006-08), DOD TK3/4 (2006-08), DOD TK1 (2006-08)
HA590167		N	2	FRONT WHEEL-RWD CAD Car RD (2006-08)
HA590168		N	2	FRONT WHEEL-FWD TOY TK (2006-07), FRONT WHEEL-4WD TOY TK (2006-07)
HA590169		N	2	REAR WHEEL-AWD SUB TK AD (2008-09)

HUB UNIT BEARING / BEARING MODULE - BUYER'S GUIDE *continued*

HUB UNIT BEARING / BEARING MODULE TECHNOLOGY

Timken Part No.	On Hand	Pop Code	Per Car Qty	Application
HA590170		N	2	REAR WHEEL-FWD TOY Car FD (2007-07)
HA590171		N	2	REAR WHEEL-RWD INF Car RD (2006-06)
HA590172		N	2	REAR WHEEL-FWD TOY Car FD (2007-07)
HA590173		N	2	REAR WHEEL-FWD TOY TK (2006-07)
HA590174		N	2	REAR WHEEL-AWD JAG (2002-07)
HA590175		N	2	REAR WHEEL-RWD INF Car RD (2006-07)
HA590176		N	2	FRONT WHEEL-RWD INF Car RD (2006-08), INF SUV (2008-08)
HA590177		N	2	FRONT WHEEL-FWD MIT Car FD (2006-08), MIT TK (2005-07), FRONT WHEEL-AWD MIT TK (2006-09)
HA590178		N	2	FRONT WHEEL-RWD SUZ SUV (2006-08), FRONT WHEEL-4WD SUZ SUV (2006-07), REAR WHEEL-RWD SUZ SUV (2006-07), REAR WHEEL-4WD SUZ SUV (2006-08)
HA590179		N	2	REAR WHEEL-FWD HYU Car FD (2006-08), KIA Car (2007-09)
HA590180		N	2	REAR WHEEL-FWD FOR LT (2007-08), LIN TK (2007-08)
HA590181K			2	FRONT WHEEL-FWD PLY Car FD (1995-99), DOD Car FD (1995-99)
HA590182K			2	FRONT WHEEL-FWD PLY Car FD (1995-99), DOD Car FD (1995-99)
HA590183		N	2	REAR WHEEL-AWD FOR LT (2007-09), LIN TK (2007-09)
HA590184		N	2	REAR WHEEL-FWD HYU Car FD (2006-08), KIA Car (2006-09)
HA590185		N	2	FRONT WHEEL-RWD PON Car RD (2007-08), REAR WHEEL-RWD PON Car RD (2007-08)
HA590186		N	2	FRONT WHEEL-RWD PON Car RD (2006-08), SAT Car (2007-08), REAR WHEEL-RWD PON Car RD (2006-08), SAT Car (2007-08)
HA590187		N	2	FRONT WHEEL-FWD VLV (2006-08), FRONT WHEEL-AWD VLV (2006-09)
HA590188		N	2	REAR WHEEL-FWD KIA Car (2004-08)
HA590190		N	2	REAR WHEEL-FWD HON TK (2007-08)
HA590192		N	2	REAR WHEEL-FWD VLV (2004-08)
HA590193		N	2	REAR WHEEL-AWD MAZ TK (2007-09)
HA590194		N	2	REAR WHEEL-FWD KIA Car (2004-08)
HA590195		N	2	REAR WHEEL-FWD MAZ TK (2007-08)
HA590197			2	FRONT WHEEL-FWD CHR MVan (1988-88), DOD MVan (1988-88), PLY MVan (1988-88)
HA590198		N	2	FRONT WHEEL-FWD AUD Car (2006-08)
HA590199		N	2	FRONT WHEEL-RWD MAZ Car RD (2006-08)
HA590200		N	2	REAR WHEEL-FWD HYU Car FD (2007-08)

Timken Part No.	On Hand	Pop Code	Per Car Qty	Application
HA590201		N	2	REAR WHEEL-4WD TOY TK (2006-07)
HA590203			2	FRONT WHEEL-4WD DOD TK3/4 (2000-02), DOD TK1 (2000-02)
HA590204		N	2	REAR WHEEL-4WD HON TK (2007-08), REAR WHEEL-AWD ACU SUV (2007-08)
HA590205		N	2	FRONT WHEEL-RWD MAZ Car RD (2006-08)
HA590206		N	2	FRONT WHEEL-FWD KIA Car (2006-08), HYU TK (2007-08)
HA590208			2	FRONT WHEEL-FWD CHR CUV (2004-06), FRONT WHEEL-AWD CHR CUV (2004-06)
HA590209			2	REAR WHEEL-FWD CHR CUV (2004-06), REAR WHEEL-AWD CHR CUV (2004-06)
HA590212		N	2	FRONT WHEEL-FWD VLV (2005-09)
HA590213			2	FRONT WHEEL-RWD FOR Car RD (2002-05), LIN Car RD (2000-06)
HA590214		N	2	FRONT WHEEL-FWD CHR Car FD (2007-08), DOD Car FD (2008-08)
HA590216		N	2	REAR WHEEL-FWD CHR Car FD (2007-08), REAR WHEEL-RWD JEE (2007-08), REAR WHEEL-FWD DOD Car FD (2007-08), REAR WHEEL-AWD DOD Car FD (2008-08)
HA590217		N	2	FRONT WHEEL-FWD CHR CUV (2007-08), FRONT WHEEL-AWD CHR CUV (2007-08)
HA590218		N	2	REAR WHEEL-AWD VLV (2001-09), REAR WHEEL-FWD VLV SUV (2003-06)
HA590219		N	2	FRONT WHEEL-FWD CHR Car FD (2007-08), DOD Car FD (2008-08), FRONT WHEEL-AWD DOD Car FD (2008-08)
HA590220		N	2	REAR WHEEL-AWD VLV (2007-09)
HA590221		N	2	REAR WHEEL-FWD CHR Car FD (2007-08), DOD Car FD (2007-08)
HA590223		N	2	FRONT WHEEL-FWD VLV SUV (2003-07), FRONT WHEEL-AWD VLV SUV (2003-07)
HA590224		O	1	FRONT WHEEL-RWD JAG (2000-06)
HA590226		N	2	FRONT WHEEL-AWD INF Car RD (2006-09), FRONT WHEEL-4WD INF SUV (2008-08)
HA590227		N	2	FRONT WHEEL-FWD BUI SUV (2008-08), CHE LT (2007-08), SAT SUV (2007-09), FRONT WHEEL-AWD BUI SUV (2008-09), CHE LT (2007-08), SAT SUV (2007-09), REAR WHEEL-FWD BUI SUV (2008-09), CHE LT (2007-08), SAT SUV (2007-08), REAR WHEEL-AWD BUI SUV (2008-09), CHE LT (2007-08), SAT SUV (2007-09)
HA590228		N	2	FRONT WHEEL-AWD ACU SUV (2007-08)
HA590229		N	2	REAR WHEEL-AWD ACU SUV (2007-08)
HA590230		N	2	REAR WHEEL-4WD JEE (2007-08), REAR WHEEL-AWD DOD Car FD (2007-08)
HA590232		N	2	REAR WHEEL-AWD VLV SUV (2003-09)
HA590233		N	2	FRONT WHEEL-RWD FOR TK3/4 (1999-04), FOR TK1 (1999-04), FOR TK1+ (1999-04)

HUB UNIT BEARING / BEARING MODULE - BUYER'S GUIDE *continued*

Timken Part No.	On Hand	Pop Code	Per Car Qty	Application
HA590234		N	2	FRONT WHEEL-FWD VLV (2007-09), FRONT WHEEL-AWD VLV (2007-09)
HA590235		N	2	
HA590236		N	2	FRONT WHEEL-FWD NIS TK (2009-09), FRONT WHEEL-AWD NIS TK (2009-09)
HA590237		N	2	REAR WHEEL-FWD NIS TK (2009-09)
HA590238		N	2	REAR WHEEL-AWD NIS TK (2009-09)
HA590239		N	2	FRONT WHEEL-FWD NIS TK (2008-09), FRONT WHEEL-AWD NIS TK (2008-09)
HA590240			2	FRONT WHEEL-FWD MIT Car FD (1994-03)
HA590241		N	2	REAR WHEEL-FWD NIS TK (2008-09)
HA590241K			2	FRONT WHEEL-RWD VLV (1994-98)
HA590242		N	2	FRONT WHEEL-RWD JEE (2007-08), FRONT WHEEL-4WD JEE (2007-08)
HA590243		N	2	FRONT WHEEL-FWD CHR MVan (2008-08), DOD MVan (2008-08)
HA590244		N	2	FRONT WHEEL-RWD CHR MVan (2007-09), DOD LT (2006-08), FRONT WHEEL-4WD CHR MVan (2007-09), DOD LT (2006-08)
HA590245		N	2	FRONT WHEEL-RWD DOD LT (2007-08), FRONT WHEEL-4WD DOD LT (2007-08)
HA590247		N	2	REAR WHEEL-FWD MIT TK (2007-09)
HA590250		N	2	FRONT WHEEL-FWD NIS Car FD (2007-08)
HA590251		N	2	FRONT WHEEL-FWD NIS Car FD (2007-08)
HA590252		N	2	FRONT WHEEL-FWD NIS Car FD (2007-09)
HA590253		N	2	REAR WHEEL-FWD NIS Car FD (2007-09)
HA590254		N	2	REAR WHEEL-FWD NIS Car FD (2007-07)
HA590255		N	2	REAR WHEEL-RWD INF Car RD (2007-08), REAR WHEEL-AWD INF Car RD (2007-09), REAR WHEEL-RWD INF SUV (2008-08), REAR WHEEL-4WD INF SUV (2008-09)
HA590256		N	2	REAR WHEEL-FWD MIT TK (2008-09)
HA590257			2	REAR WHEEL-FWD VLV (2000-04)
HA590258		N	2	REAR WHEEL-AWD MIT TK (2008-09)
HA590259K			2	FRONT WHEEL-RWD LIN TK (2003-05), REAR WHEEL-RWD FOR LT (2002-08), REAR WHEEL-4WD FOR LT (2002-08), REAR WHEEL-AWD LIN TK (2003-05), REAR WHEEL-RWD MRC SUV (2002-05), REAR WHEEL-4WD MRC SUV (2002-05), REAR WHEEL-AWD MRC SUV (2002-05)
HA590260		N	2	FRONT WHEEL-RWD CAD Car RD (2008-09), FRONT WHEEL-AWD CAD Car RD (2008-09), REAR WHEEL-RWD CAD Car RD (2008-08)

Timken Part No.	On Hand	Pop Code	Per Car Qty	Application
HA590261		N	2	FRONT WHEEL-FWD FOR LT (2009-09), LIN Car FD (2009-09), FRONT WHEEL-AWD FOR LT (2009-09), LIN Car FD (2009-09), REAR WHEEL-FWD FOR LT (2009-09), LIN Car FD (2009-09), REAR WHEEL-AWD FOR LT (2009-09), LIN Car FD (2009-09)
HA590262		N	2	FRONT WHEEL-FWD CHE LT (2007-09), PON SUV (2007-09), SAT SUV (2008-09), FRONT WHEEL-AWD CHE LT (2007-09), PON SUV (2007-09), SAT SUV (2008-09)
HA590263K			2	FRONT WHEEL-FWD FOR Car FD (2000-08)
HA590264		N	2	REAR WHEEL-FWD CHE LT (2007-09), SAT SUV (2008-09), REAR WHEEL-AWD CHE LT (2007-09), PON SUV (2007-09), SAT SUV (2008-09)
HA590265		N	1	FRONT WHEEL-RWD LEX Car RD (2007-08)
HA590267		N	2	FRONT WHEEL-AWD LEX Car RD (2008-09)
HA590268		S	2	REAR WHEEL-RWD LEX Car RD (2008-09), REAR WHEEL-AWD LEX Car RD (2008-09)
HA590269		N	2	REAR WHEEL-RWD LEX Car RD (2007-08), REAR WHEEL-AWD LEX Car RD (2007-08)
HA590270		N	1	FRONT WHEEL-RWD LEX Car RD (2007-08)
HA590271		N	2	FRONT WHEEL-AWD MIT Car FD (2008-08)
HA590273		N	2	FRONT WHEEL-RWD DOD TK1+ (2008-08), FRONT WHEEL-4WD DOD TK1+ (2008-08)
HA590274		N	2	REAR WHEEL-FWD CHR CUV (2007-08), REAR WHEEL-AWD CHR CUV (2007-08)
HA590275		N	2	REAR WHEEL-AWD MIT Car FD (2008-08)
HA590276		N	2	FRONT WHEEL-FWD NIS Car FD (2007-08)
HA590277		N	2	FRONT WHEEL-FWD NIS Car FD (2007-08)
HA590278		N	2	FRONT WHEEL-FWD NIS Car FD (2007-08)
HA590279		N	2	REAR WHEEL-FWD NIS Car FD (2007-08)
HA590280		N	2	REAR WHEEL-FWD NIS Car FD (2007-08)
HA590281		N	2	REAR WHEEL-FWD NIS Car FD (2007-08)
HA590284		N	2	FRONT WHEEL-RWD NIS TK PU (2009-09), FRONT WHEEL-4WD NIS TK PU (2009-09)
HA590285		N	2	FRONT WHEEL-FWD NIS Car FD (2007-09)
HA590286		N	2	REAR WHEEL-FWD NIS Car FD (2007-09)
HA590286K		N	2	FRONT WHEEL-FWD FOR LT (2001-08), MAZ TK (2001-08), FRONT WHEEL-4WD FOR LT (2001-08), MAZ TK (2001-08), FRONT WHEEL-AWD MAZ TK (2005-06), FRONT WHEEL-FWD MRC SUV (2005-08), FRONT WHEEL-4WD MRC SUV (2005-09)
HA590287		N	2	REAR WHEEL-FWD TOY TK (2008-09)
HA590288		N	2	REAR WHEEL-FWD NIS Car FD (2007-09)
HA590289		O	2	REAR WHEEL-FWD VLV SUV (2006-09)

HUB UNIT BEARING / BEARING MODULE - BUYER'S GUIDE *continued*

HUB UNIT BEARING / BEARING MODULE TECHNOLOGY

Timken Part No.	On Hand	Pop Code	Per Car Qty	Application
HA590290		N	2	REAR WHEEL-FWD SAA (2003-08), REAR WHEEL-AWD SAA (2008-09)
HA590294		N	2	REAR WHEEL-AWD PON Car AD (2009-09), TOY Car FD (2009-09)
HA590295		N	2	REAR WHEEL-FWD SUZ Car (2002-07)
HA590297		N	2	FRONT WHEEL-FWD SAT Car (2008-09)
HA590299		N	2	FRONT WHEEL-RWD PON Car RD (2008-09)
HA590300		N	2	FRONT WHEEL-RWD CHE LT (2004-09)
HA590301K			2	FRONT WHEEL-FWD TOY Car FD (1987-88)
HA590302K			2	FRONT WHEEL-FWD TOY Car FD (1992-03)
HA590303K			2	FRONT WHEEL-FWD TOY Car FD (1992-03)
HA590304		N	2	FRONT WHEEL-4WD CHE LT (2004-09)
HA590305		N	2	REAR WHEEL-FWD PON Car AD (2009-09), TOY Car FD (2009-09)
HA590306			2	REAR WHEEL-FWD CHR Car FD (1996-05), EAG (1995-98), MIT Car FD (1995-05), DOD Car FD (1995-05)
HA590307			2	FRONT WHEEL-RWD CHE LT (2003-05)
HA590308			2	FRONT WHEEL-RWD BMW3 Car (1998-00), BMW4 Car (2003-08)
HA590310		N	2	REAR WHEEL-FWD PON Car AD (2009-09), TOY Car FD (2009-09)
HA590311		N	2	REAR WHEEL-FWD PON Car AD (2009-09), TOY Car FD (2009-09)
HA590312		N	2	FRONT WHEEL-FWD VLV SUV (2007-09), FRONT WHEEL-AWD VLV SUV (2007-09)
HA590313		N	2	REAR WHEEL-AWD SUB Car AD (2008-09), SUB TK AD (2009-09)
HA590314		N	2	REAR WHEEL-AWD SUB Car AD (2008-09)
HA590315		N	2	FRONT WHEEL-AWD SUB Car AD (2008-09), SUB TK AD (2009-09)
HA590316		N	2	FRONT WHEEL-AWD SUB Car AD (2008-09)
HA590317		N	2	REAR WHEEL-FWD CHR MVan (2008-08), DOD MVan (2008-09)
HA590321		N	2	REAR WHEEL-AWD VLV (2004-09)
HA590322		N	2	REAR WHEEL-FWD VLV (2009-09)
HA590323		N	2	FRONT WHEEL-FWD VLV (2004-08), FRONT WHEEL-AWD VLV (2004-09)
HA590324		N	2	FRONT WHEEL-FWD HYU Car FD (2009-09)
HA590325		N	2	REAR WHEEL-FWD HYU Car FD (2009-09)
HA590326		N	2	REAR WHEEL-FWD HYU Car FD (2009-09)
HA590327		N	2	FRONT WHEEL-4WD KIA SUV (2009-09), REAR WHEEL-4WD KIA SUV (2009-09)

Timken Part No.	On Hand	Pop Code	Per Car Qty	Application
HA590328		N	2	REAR WHEEL-RWD KIA SUV (2009-09)
HA590329		N	2	FRONT WHEEL-RWD KIA SUV (2009-09)
HA590330		N	2	REAR WHEEL-FWD SUZ Car (2007-09)
HA590331		N	2	REAR WHEEL-AWD SUZ Car (2007-09)
HA590332		N	2	FRONT WHEEL-FWD SUZ SUV (2007-09), FRONT WHEEL-AWD SUZ SUV (2007-09)
HA590333		N	2	FRONT WHEEL-RWD SUZ SUV (2007-09), REAR WHEEL-FWD SUZ SUV (2007-09), REAR WHEEL-AWD SUZ SUV (2007-09)
HA590335		N	2	REAR WHEEL-FWD FOR LT (2009-09), LIN TK (2009-09)
HA590336		N	2	REAR WHEEL-FWD MAZ Car FD (2009-09)
HA590337		N	2	REAR WHEEL-FWD VLV (2007-09)
HA590338			2	REAR WHEEL-AWD TOY TK (2004-09), REAR WHEEL-4WD LEX SUV (2004-08)
HA590352			2	FRONT WHEEL-RWD CHE TK1 (2003-09), CHE TK3/4 (1999-09)
HA590353			2	FRONT WHEEL-RWD CHE TK1 (2003-06)
HA590370			2	REAR WHEEL-FWD TOY Car FD (1992-04)
HA590371		N	2	REAR WHEEL-FWD TOY Car FD (1992-04)
HA590389			2	REAR WHEEL-FWD VLV (1999-08)
HA590425			2	FRONT WHEEL-4WD FOR TK3/4 (1999-99), FOR TK1 (1999-99), FOR TK1+ (1999-99)
HA590503			2	FRONT WHEEL-4WD DOD TK3/4 (2000-02)
HA590600K		N	2	FRONT WHEEL-FWD INF Car FD (2000-04), NIS Car FD (2000-08)
HA590644		0	2	FRONT WHEEL-4WD HON TK (2002-02), ISU TK (2002-04)
HA590653			2	FRONT WHEEL-RWD ISU TK (2002-04)
HA591050			2	REAR WHEEL-RWD LEX Car RD (2001-06), REAR WHEEL-AWD LEX Car RD (2001-06)
HA591080			2	REAR WHEEL-AWD TOY TK (2004-09)
HA591339			2	FRONT WHEEL-4WD CHE TK1 (1988-94), CHE TK3/4 (1987-94)
HA592210			1	REAR WHEEL-FWD HON TK (1998-01), REAR WHEEL-4WD HON TK (1997-01)
HA592410			2	REAR WHEEL-FWD TOY Car FD (2000-05)
HA592450			1	REAR WHEEL-FWD LEX Car FD (2002-08), TOY Car FD (2002-09), TOY TK (2001-03)
HA592451			2	REAR WHEEL-FWD TOY TK (2004-07), LEX SUV (2004-08)
HA592460			2	REAR WHEEL-FWD LEX Car FD (2002-08), TOY Car FD (2002-09), TOY TK (2001-03)
HA592461			2	REAR WHEEL-FWD TOY TK (2004-07), LEX SUV (2004-08)

HUB UNIT BEARING / BEARING MODULE - BUYER'S GUIDE *continued*

Timken Part No.	On Hand	Pop Code	Per Car Qty	Application
HA592519			2	FRONT WHEEL-RWD BMW7 Car (1995-01)
HA593427			2	FRONT WHEEL-RWD BMW5 Car (1997-05), BMW8 Car (2000-03)
HA593550			2	FRONT WHEEL-RWD LEX Car RD (2001-06)
HA594181			2	FRONT WHEEL-FWD VLV (1994-98), FRONT WHEEL-AWD VLV (1997-98)
HA594241			2	REAR WHEEL-FWD TOY TK (1997-05)
HA594245			2	REAR WHEEL-FWD SCI (2004-06), TOY Car FD (2000-05)
HA594246			2	REAR WHEEL-RWD TOY TK (2003-09), REAR WHEEL-4WD TOY TK (2003-09), LEX SUV (2003-08)
HA594301			2	REAR WHEEL-RWD TOY TK (2001-06), REAR WHEEL-4WD TOY TK (2001-07)
HA594460K			2	FRONT WHEEL-FWD HON Car (1988-90)
HA594504			2	REAR WHEEL-FWD TOY TK (1998-05)
HA594505			2	REAR WHEEL-AWD TOY TK (2001-05)
HA595017			2	FRONT WHEEL-RWD TOY Car RD (1999-05)
HA595894			2	FRONT WHEEL-FWD VLV (1993-93)
HA596030			2	REAR WHEEL-FWD TOY Car FD (2002-04)
HA596467			2	FRONT WHEEL-RWD CAD Car RD (1997-01)
HA597449			2	FRONT WHEEL-RWD JEE (1999-01), FRONT WHEEL-4WD JEE (1999-06)
HA597851			2	FRONT WHEEL-4WD DOD TK3/4 (1994-99)
HA597957			2	REAR WHEEL-FWD VLV (1993-04)
HA598679			2	FRONT WHEEL-RWD JEE (1999-04), FRONT WHEEL-4WD JEE (1999-04)
HA599361			2	FRONT WHEEL-4WD DOD LT (1997-04)
HA599406			2	FRONT WHEEL-RWD DOD LT (1997-04)
HA599455L			2	FRONT WHEEL-RWD JEE (2002-08), FRONT WHEEL-4WD JEE (2002-07)
HA599455R			2	FRONT WHEEL-RWD JEE (2002-08), FRONT WHEEL-4WD JEE (2002-07)
HA599467			2	FRONT WHEEL-RWD JEE (2002-05), FRONT WHEEL-4WD JEE (2002-05)
HA599528			2	FRONT WHEEL-RWD DOD LT (1997-04)
HA599863			2	FRONT WHEEL-4WD DOD TK1/2 (2000-01)
SP940200		N	2	FRONT WHEEL-4WD FOR TK3/4 (2005-08), FOR TK1 (2005-08)
SP940201		N	2	FRONT WHEEL-4WD FOR TK1 (2005-08)
SP940202		N	2	FRONT WHEEL-4WD FOR TK1+ (2005-08)

Timken Part No.	On Hand	Pop Code	Per Car Qty	Application
SP940203		N	2	FRONT WHEEL-RWD FOR TK3/4 (2005-09), FOR TK1 (2005-09), FOR TK1+ (2005-08)
SP940204		N	2	FRONT WHEEL-4WD FOR TK1 (2008-08)

HUB UNIT BEARING / BEARING MODULE - DIAGRAMS AND SPECIFICATIONS

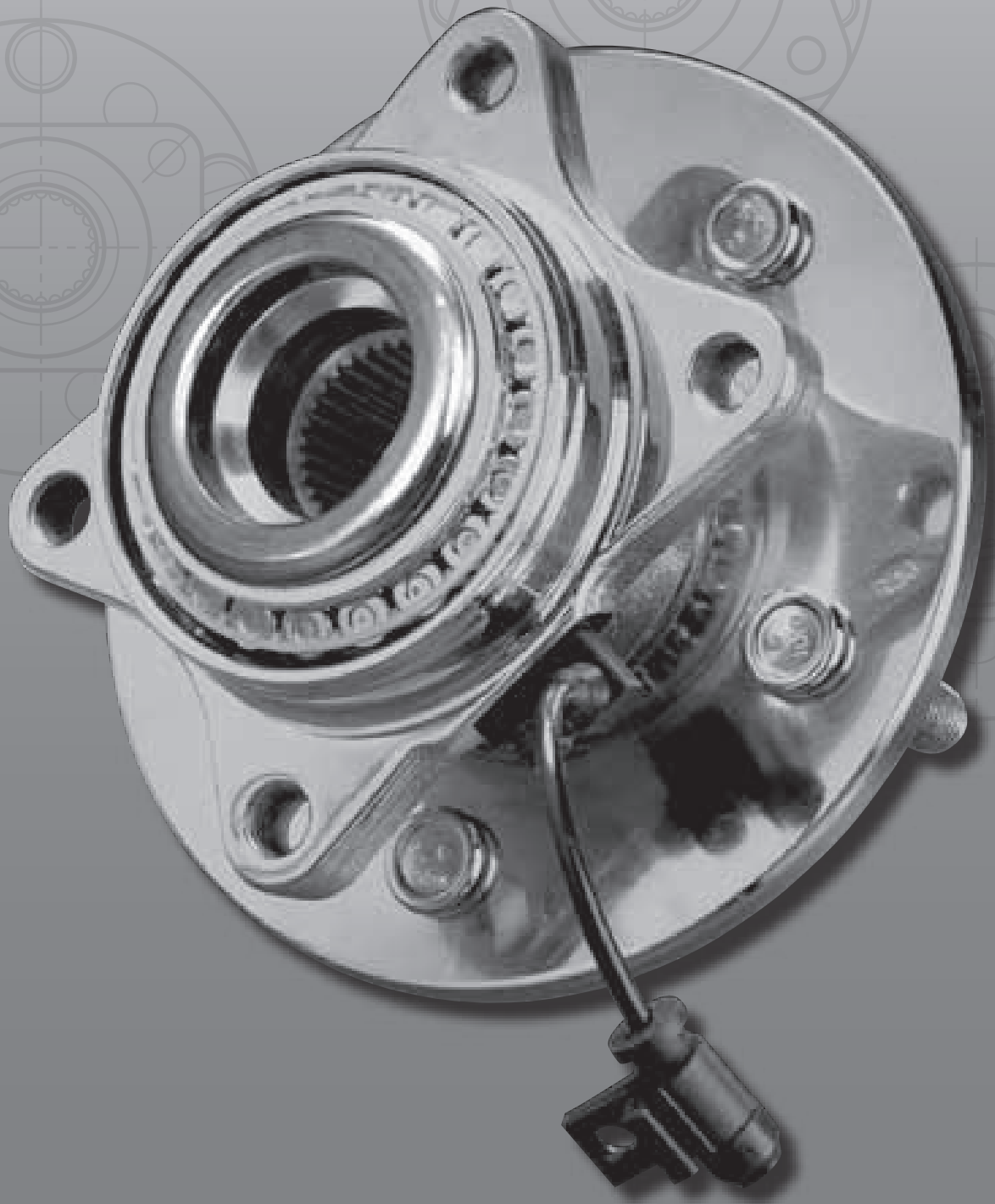

HUB UNIT BEARING DIAGRAMS

DRIVEN HUB UNIT BEARINGS

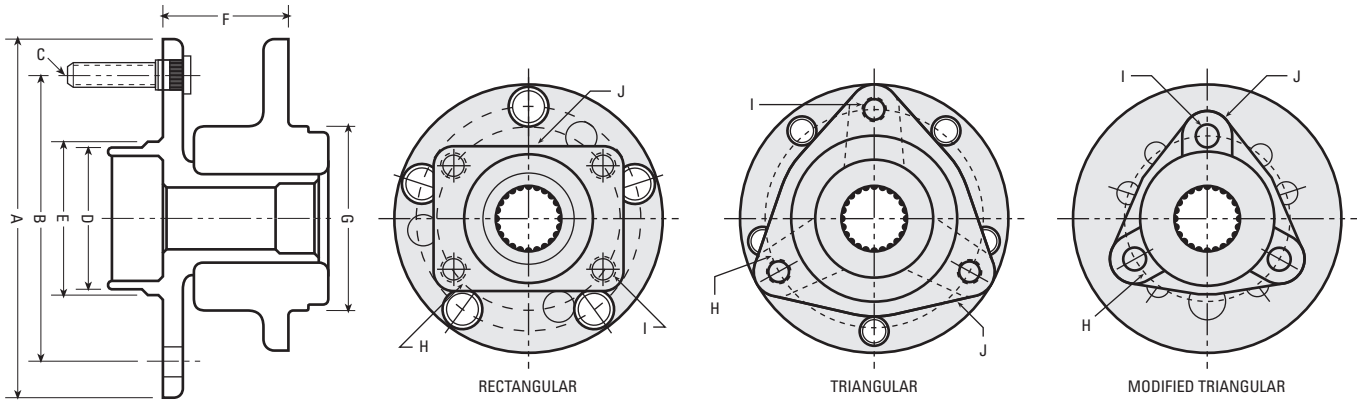

NON-DRIVEN HUB UNIT BEARINGS

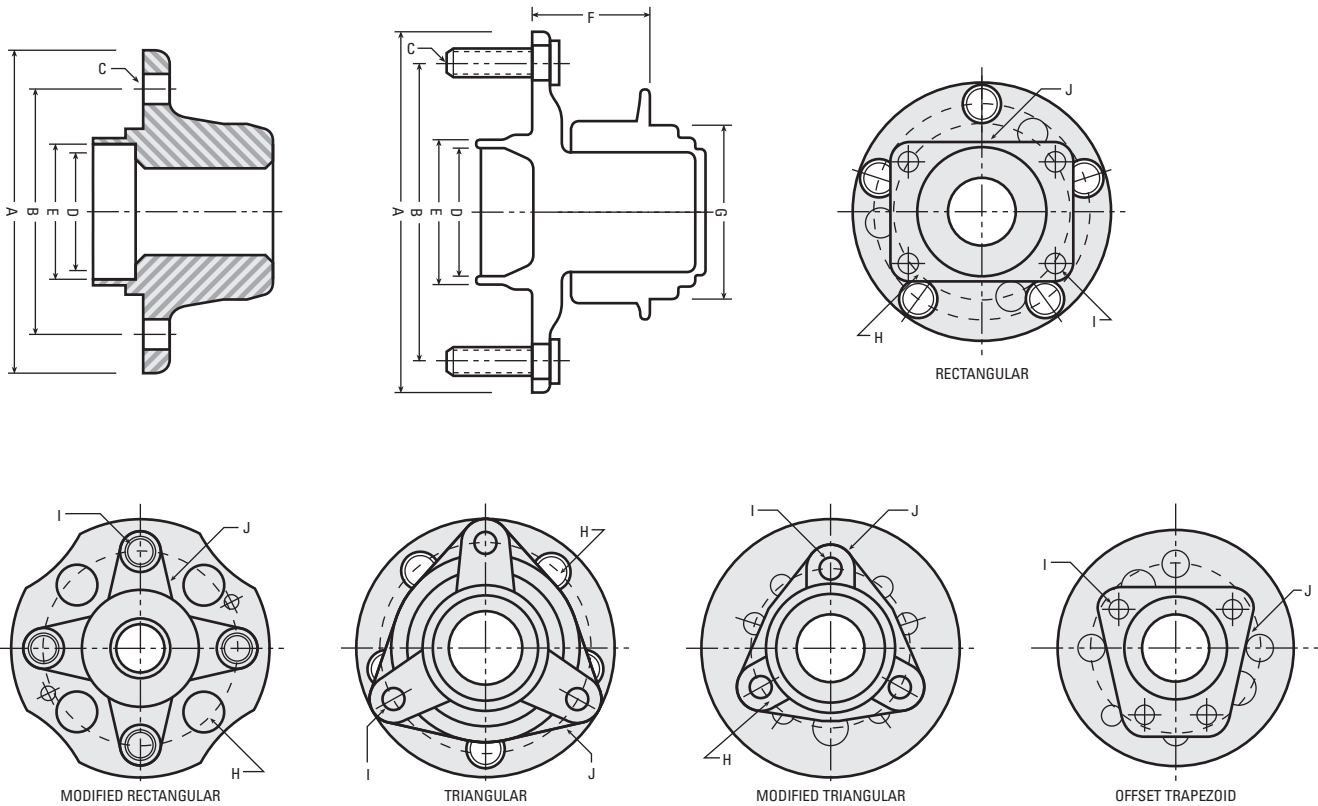

HUB UNIT BEARING / BEARING MODULE TECHNOLOGY

HUB UNIT BEARING / BEARING MODULE - NUMERICAL LISTING

Timken Part No.		Flange Dia	Bolt Circle Dia	Bolt Size (Qty)	Wheel Pilot Dia	Brake Pilot Dia	Flange Offset	Hub Pilot Dia	Bolt Circle Dia	Bolt Hole Size (Qty)	Flange Shape	No. Of Spline	ABS (Y/N)
		A	B	C	D	E	F	G	H	I	J		
510038	*	-	-	-	-	-	-	3.39	4.13	M10x1.25 (4)	Modified Trapezoid	-	N
		-	-	-	-	-	-	86.00	105.00				
511010	*	-	-	-	-	-	-	3.19	-	-	Modified Rectangle	-	-
		-	-	-	-	-	-	81.00	-				
511011	*	-	-	-	-	-	-	3.19	4.33	M12X1.25 (4)	Modified Rectangle	-	N
		-	-	-	-	-	-	81.00	110.00				
511012	*	-	-	-	-	-	-	3.54	5.96	-	Modified Rectangle	-	N
		-	-	-	-	-	-	90.00	151.38				
512000		5.43	3.94	M12x1.5 (4)	2.24	2.26	2.56	2.40	-	0.43 11.00(4)	Modified Trapezoid	-	N
		138.00	100.00		57.00	57.49	65.14	61.00	-				
512001		5.43	3.94	M12x1.5 (5)	2.24	2.26	2.56	2.40	-	0.43 11.00(4)	Modified Trapezoid	-	Y
		138.00	100.00		57.00	57.49	65.14	61.00	-				
512002		5.43	3.94	M12x1.5 (4)	2.24	2.26	2.56	2.40	-	0.43 11.00(4)	Modified Trapezoid	-	Y
		138.00	100.00		57.00	57.49	65.14	61.00	-				
512003		5.93	4.53	M12x1.5 (5)	2.76	2.78	2.56	2.83	3.96	0.47 11.94(4)	Rectangle	-	Y
		150.50	115.00		70.10	70.60	65.14	71.80	100.60				
512004		5.93	4.53	M12x1.5 (5)	2.76	2.78	2.56	2.83	3.96	0.47 11.94(4)	Rectangle	-	Y
		150.50	115.00		70.10	70.60	65.14	71.80	100.60				
512005		6.14	4.53	M12x1.5 (5)	2.76	2.78	2.72	2.83	-	0.47 11.94(4)	Rectangle	-	N
		156.00	115.00		70.14	70.63	69.10	71.80	-				
512006		5.93	4.53	M12x1.5 (5)	2.76	2.78	2.56	2.83	3.96	0.47 11.94(4)	Rectangle	-	Y
		150.50	115.00		70.10	70.60	65.14	71.80	100.60				
512007		5.55	3.94	M12x1.5 (4)	1.89	2.20	2.24	-	-	-	-	-	N
		141.00	100.00		48.00	56.00	57.00	-	-				
512008		5.77	4.50	M12x1.5 (5)	2.76	2.76	2.44	-	-	-	-	-	Y
		146.50	114.30		70.00	70.00	62.00	-	-				
512009	*	-	-	-	-	-	2.04	-	3.90	0.41 10.50(4)	Modified Trapezoid	-	N
		-	-	-	-	-	51.80	-	99.00				
512010		5.51	4.50	M12x1.5 (5)	2.64	3.54	-	-	-	-	-	-	N
		140.00	114.30		67.00	90.00	-	-	-				
512011		5.51	4.50	M12x1.5 (5)	2.64	3.55	-	-	-	-	-	-	Y
		140.00	114.30		67.00	90.00	-	-	-				
512012		4.72	3.94	M14x1.5 (5)	2.24	2.56	1.61	-	-	-	-	-	Y
		120.00	100.00		57.00	65.00	41.00	-	-				
512013		5.31	3.94	M12X1.5 (5)	2.24	2.26	2.06	-	-	-	-	-	Y
		135.00	100.00		56.90	57.30	52.40	-	-				
512014	*	-	-	-	-	-	1.77	3.19	4.33	M12x1.25 (4)	Modified Rectangle	-	N
		-	-	-	-	-	45.00	81.00	110.00				
512015		5.83	4.50	-	2.60	2.68	2.54	-	-	-	-	-	N
		148.00	114.30		(5)	66.00	68.00	64.50	-				

*Denotes a Bearing Module

Every reasonable effort has been made to ensure the accuracy of the information contained in this writing, but no liability is accepted for errors, omissions or for any other reason.

HUB UNIT BEARING / BEARING MODULE - NUMERICAL LISTING

continued

Timken Part No.	Flange Dia	Bolt Circle Dia	Bolt Size (Qty)	Wheel Pilot Dia	Brake Pilot Dia	Flange Offset	Hub Pilot Dia	Bolt Circle Dia	Bolt Hole Size (Qty)	Flange Shape	No. Of Spline	ABS (Y/N)
	A	B	C	D	E	F	G	H	I	J		
512016	5.83	4.50	M12x1.25 (4)	2.60	2.68	1.93	2.83	-	-	-	-	N
	148.00	114.30		66.00	68.00	49.00	72.00	-	-	-	-	N
512017	5.08	4.25	M12x1.25 (4)	2.56	2.80	1.65	3.01	-	-	-	-	N
	129.10	108.00		64.98	71.03	42.00	76.50	-	-	-	-	N
512018	5.51	3.94	M12x1.5 (4)	2.13	2.17	2.94	-	3.82	0.41 10.50(4)	Modified Trapezoid	-	N
	140.00	100.00		54.00	55.00	74.70	-	97.00				
512019	5.51	3.94	M12x1.5 (4)	2.13	2.17	2.94	-	3.82	0.413 10.49(4)	Modified Trapezoid	-	Y
	140.00	100.00		54.00	55.00	74.70	-	97.00				
512020	5.98	4.50	M12x1.5 (4)	2.52	2.52	2.20	-	-	-	-	-	Y
	152.00	114.30		64.00	64.00	56.00	-	-				
512021	5.31	3.94	M12x1.5 (4)	2.24	2.26	2.06	-	-	-	-	-	Y
	135.00	100.00		56.90	57.35	52.40	-	-				
512022	5.47	4.50	M12x1.5 (4)	2.52	2.52	2.35	-	-	-	-	-	Y
	139.00	114.30		64.00	64.00	59.70	-	-				
512023	5.31	3.94	M12x1.5 (5)	2.24	2.26	2.06	-	-	-	-	-	Y
	135.00	100.00		56.90	57.35	52.40	-	-				
512024	5.35	4.25	M12x1.5 (4)	2.49	2.50	2.03	3.27	-	-	-	-	Y
	135.00	108.00		63.20	63.50	51.50	83.00	-				
512025	5.28	3.94	0.551 14(4)	2.32	2.68	2.07	-	-	-	-	-	N
	134.00	100.00		59.00	68.00	52.50	-	-				
512026	5.47	4.50	M12x1.5 (4)	2.64	3.54	1.99	-	-	-	-	-	Y
	139.00	114.30		67.00	90.00	50.50	-	-				
512027	5.47	4.50	M12x1.5 (4)	2.64	3.54	1.99	-	-	-	-	-	Y
	139.00	114.30		67.00	90.00	50.50	-	-				
512029	5.51	4.50	M12x1.5 (5)	2.81	2.88	1.63	-	-	-	-	-	Y
	140.00	114.30		71.37	73.41	41.15	-	-				
512031	5.98	4.50	M12x1.5 (4)	2.52	2.52	2.80	-	-	-	-	-	Y
	152.00	114.30		64.00	64.00	71.00	-	-				
512032	5.98	4.50	M12x1.5 (4)	2.52	2.52	2.20	-	-	-	-	-	Y
	152.00	114.30		64.00	64.00	56.00	-	-				
512033	4.92	3.94	M12x1.5 (4)	2.20	2.52	2.22	-	-	-	-	-	N
	125.00	100.00		56.00	64.00	56.50	-	-				
512036	4.96	3.94	M12x1.25 (5)	2.20	2.28	2.54	2.48	-	-	-	-	N
	126.00	100.00		56.00	58.00	64.50	63.00	-				
512037	5.51	4.50	M12x1.5 (4)	-	-	2.22	-	-	-	-	-	N
	140.00	114.30		-	-	56.50	-	-				
512038	*	-	-	-	-	2.16	-	4.17	0.41 10.50(4)	Modified Trapezoid	-	N
	-	-		-	-	54.80	-	106.00				
512039	5.51	4.50	M12x1.5 (5)	2.64	2.64	2.24	3.03	-	-	-	-	N
	140.00	114.30		67.00	67.00	57.00	77.00	-				

*Denotes a Bearing Module

HUB UNIT BEARING / BEARING MODULE - NUMERICAL LISTING

continued

Timken Part No.	Flange Dia	Bolt Circle Dia	Bolt Size (Qty)	Wheel Pilot Dia	Brake Pilot Dia	Flange Offset	Hub Pilot Dia	Bolt Circle Dia	Bolt Hole Size (Qty)	Flange Shape	No. Of Spline	ABS (Y/N)
	A	B	C	D	E	F	G	H	I	J		
512040	5.52	4.50	-	2.64	2.64	2.22	2.62	-	-	-	-	Y
	140.20	114.30	(4)	67.00	67.00	56.50	66.50	-	-	-	-	
512041	6.02	4.50	M12x1.5	2.36	2.44	3.09	3.30	-	0.41	Modified	-	Y
	153.00	114.30	(5)	60.00	62.00	78.60	83.88	-	10.50(4)	Trapezoid	-	
512078	5.93	4.53	M12x1.5	2.76	2.78	2.56	2.83	3.96	0.47	Rectangle	-	Y
	150.50	115.00	(5)	70.10	70.60	65.14	71.80	100.60	11.94(4)	-	-	
512105	5.49	4.25	M12x1.5	2.49	2.54	2.29	-	-	-	-	-	Y
	139.50	107.95	(5)	63.26	64.42	58.06	-	-	-	-	-	
512106	5.47	4.25	M12x1.5	2.49	2.54	2.27	2.91	-	-	-	-	N
	139.00	107.95	(5)	63.22	64.38	57.76	74.00	-	-	-	-	
512107	5.47	4.25	M12x1.5	2.49	2.53	2.15	-	-	-	-	-	Y
	139.00	107.95	(5)	63.22	64.38	54.58	-	-	-	-	-	
512118	5.51	4.50	M12x1.5	2.64	2.83	2.32	2.80	-	-	-	-	Y
	140.00	114.30	(5)	67.00	72.00	59.00	71.00	-	-	-	-	
512119	5.51	4.50	M12x1.5	2.64	2.83	2.32	2.80	-	-	-	-	N
	140.00	114.30	(5)	67.00	72.00	59.00	71.00	-	-	-	-	
512120	5.98	4.50	M12x1.5	2.52	2.52	2.80	-	-	-	-	-	Y
	152.00	114.30	(4)	64.00	64.00	71.00	-	-	-	-	-	
512121	5.98	4.50	M12x1.5	2.52	2.52	2.80	-	-	-	-	-	Y
	152.00	114.30	(5)	64.00	64.00	71.00	-	-	-	-	-	
512122	5.98	4.50	M12x1.5	2.52	2.52	2.20	2.80	-	-	-	-	N
	152.00	114.30	(4)	64.00	64.00	56.00	71.00	-	-	-	-	
512123	5.77	4.50	M12x1.5	2.52	2.76	2.44	-	-	-	-	-	Y
	146.50	114.30	(5)	64.00	70.00	62.00	-	-	-	-	-	
512124	5.77	4.50	M12x1.5	2.52	2.76	2.44	-	-	-	-	-	Y
	146.50	114.30	(5)	64.00	70.00	62.00	-	-	-	-	-	
512125	5.45	4.50	M12x1.5	2.81	2.83	2.33	3.39	4.25	-	-	-	N
	138.43	114.30	(5)	71.83	71.83	59.11	85.98	108.12	-	-	-	
512133	5.32	3.74	M12x1.5	2.24	2.28	-	2.60	-	-	-	-	Y
	135.20	95.07	(5)	56.90	58.01	-	66.04	-	-	-	-	
512136	*	-	-	-	-	-	2.68	3.54	M10x1.25	Modified	-	N
	-	-	-	-	-	-	68.00	90.00	(4)	Trapezoid	-	
512137	*	-	-	-	-	-	2.56	3.90	0.413	Modified	-	N
	-	-	-	-	-	-	65.00	99.00	10.49(4)	Trapezoid	-	
512144	5.98	4.50	M12x1.5	2.52	2.52	2.20	-	-	-	-	-	Y
	152.00	114.30	(5)	64.00	64.00	56.00	-	-	-	-	-	
512145	5.51	4.13	-	2.58	2.56	-	-	4.14	0.41	-	-	Y
	140.00	105.00	(5)	65.43	65.10	-	-	105.23	10.34(4)	-	-	
512146	5.15	4.27	-	2.55	2.68	-	-	-	-	-	-	Y
	130.84	108.52	(4)	64.77	67.95	-	-	-	-	-	-	

*Denotes a Bearing Module

HUB UNIT BEARING / BEARING MODULE - NUMERICAL LISTING

continued

Timken Part No.	Flange Dia	Bolt Circle Dia	Bolt Size (Qty)	Wheel Pilot Dia	Brake Pilot Dia	Flange Offset	Hub Pilot Dia	Bolt Circle Dia	Bolt Hole Size (Qty)	Flange Shape	No. Of Spline	ABS (Y/N)
	A	B	C	D	E	F	G	H	I	J		
512147	5.37	4.51	1/2-20 (4)	2.81	3.38	2.26	-	-	-	-	-	N
	136.27	114.52		71.37	85.85	57.46	-	-				
512148	4.92	3.94	M12x1.5 (4)	2.20	2.52	2.22	-	-	-	-	-	N
	125.00	100.00		56.00	64.00	56.50	-	-				
512149	5.47	4.25	M12x1.5 (5)	2.49	2.54	2.15	2.91	-	-	-	-	Y
	139.00	107.95		63.22	64.38	54.58	74.00	-				
512150	5.93	4.53	M12x1.5 (5)	2.76	2.78	2.56	2.83	3.96	.47 11.94(4)	Rectangle	-	Y
	150.50	115.00		70.10	70.60	65.14	71.80	100.60				
512151	5.93	4.53	M12x1.5 (5)	2.76	2.78	2.56	2.83	3.96	0.47 11.94(4)	Rectangle	-	Y
	150.50	115.00		70.10	70.60	65.14	71.80	100.60				
512152	5.93	4.53	M12x1.5 (5)	2.76	2.78	2.56	2.83	3.96	0.47 11.94(4)	Rectangle	-	Y
	150.50	115.00		70.10	70.60	65.14	71.80	100.60				
512153	5.73	4.75	M12x1.5 (5)	2.76	2.78	1.66	3.60	4.57	M12x1.75 (3)	Modified Triangle	30	Y
	145.50	120.65		70.10	70.60	42.06	91.42	116.00				
512154	5.32	3.74	M12x1.5 (5)	2.24	2.25	-	2.60	-	-	-	-	N
	135.20	95.07		56.90	57.25	-	66.04	-				
512155	4.96	3.94	M12x1.5 (5)	2.24	2.26	1.89	3.39	-	M12x1.5 (4)	Modified Rectangle	-	Y
	126.00	100.00		56.80	57.30	48.00	86.00	-				
512156	5.51	4.50	M12x1.5 (5)	2.81	2.83	1.89	3.39	-	M12x1.5 (4)	Modified Rectangle	-	Y
	140.00	114.30		71.40	71.90	48.00	86.00	-				
512157	5.46	4.26	M12x1.35 (5)	2.78	2.82	1.88	3.38	3.51	0.41 10.41(4)	Modified Rectangle	-	N
	138.87	108.38		70.73	71.62	47.94	85.95	89.15				
512158	5.51	4.50	M12x1.5 (4)	2.64	2.64	2.55	3.03	-	-	-	-	N
	140.00	114.30		67.00	67.00	64.70	77.00	-				
512159	5.47	4.50	M12x1.5 (5)	2.23	2.23	2.45	2.64	-	-	-	-	Y
	139.00	114.30		56.51	56.51	62.20	67.00	-				
512160	5.47	4.50	M12x1.5 (4)	2.64	2.99	1.92	2.64	-	-	-	-	Y
	139.00	114.30		67.00	76.00	48.80	67.00	-				
512161	4.80	3.94	M12x1.5 (4)	2.13	2.17	2.20	-	-	-	-	-	Y
	122.00	100.00		54.00	55.00	56.00	-	-				
512162	5.47	4.25	M12x1.5 (5)	2.49	2.54	2.27	-	-	-	-	-	Y
	139.00	107.95		63.22	64.38	57.76	-	-				
512163	5.47	4.25	M12x1.5 (5)	2.49	2.53	2.15	-	-	-	-	-	Y
	139.00	107.95		63.22	64.38	54.58	-	-				
512164	5.47	4.25	M12x1.5 (5)	2.49	2.53	2.15	2.91	-	-	-	-	N
	139.00	107.95		63.22	64.38	54.58	74.00	-				
512165	5.47	4.50	M12x1.5 (4)	2.64	2.99	1.99	-	-	-	-	-	Y
	139.00	114.30		67.00	76.00	50.50	-	-				
512166	-	4.17	M10x1.25 -	3.17	3.17	-	-	-	-	Modified Polygon	-	N
	-	106.00		80.60	80.60	-	-	-				

*Denotes a Bearing Module

HUB UNIT BEARING / BEARING MODULE TECHNOLOGY

HUB UNIT BEARING / BEARING MODULE - NUMERICAL LISTING

continued

Timken Part No.	Flange Dia	Bolt Circle Dia	Bolt Size (Qty)	Wheel Pilot Dia	Brake Pilot Dia	Flange Offset	Hub Pilot Dia	Bolt Circle Dia	Bolt Hole Size (Qty)	Flange Shape	No. Of Spline	ABS (Y/N)
	A	B	C	D	E	F	G	H	I	J		
512167	5.31	3.94	-	2.24	2.26	2.26	-	-	-	-	-	Y
	135.00	100.00	(5)	56.90	57.35	57.50	-	-	-	-	-	
512168	5.31	3.94	-	2.24	2.26	2.26	-	-	-	-	-	Y
	135.00	100.00	(5)	56.90	57.35	57.50	-	-	-	-	-	
512169	5.51	4.50	M12x1.5	2.81	2.83	1.89	3.39	-	M12x1.5	Modified Rectangle	-	Y
	140.00	114.30	(5)	71.40	71.90	48.00	86.00	-	(4)			
512170	5.51	4.50	M12x1.5	2.81	2.83	1.89	3.39	-	M12x1.5	Modified Rectangle	-	N
	140.00	114.30	(5)	71.40	71.90	48.00	86.00	-	(4)			
512171	4.80	3.94	M12x1.5	2.22	2.24	2.52	-	3.06	M10x1.25	Square	-	N
	122.00	100.00	(4)	56.50	57.00	64.00	-	77.78	(4)			
512172	5.98	4.50	M12x1.5	2.52	2.52	2.20	-	-	-	-	-	Y
	152.00	114.30	(4)	64.00	64.00	56.00	-	-	-	-	-	
512173	5.98	4.50	M12x1.5	2.52	2.52	2.48	-	-	-	-	-	Y
	152.00	114.30	(5)	64.00	64.00	63.00	-	-	-	-	-	
512174	5.47	3.94	M12x1.5	2.20	2.40	2.20	2.60	-	-	-	-	N
	139.00	100.00	(4)	56.00	61.00	56.00	66.00	-	-	-	-	
512175	5.47	3.94	M12x1.5	2.20	2.40	2.20	-	-	-	-	-	Y
	139.00	100.00	(4)	56.00	61.00	56.00	-	-	-	-	-	
512176	5.98	4.50	M12x1.5	2.52	2.52	2.20	2.60	-	-	-	-	N
	152.00	114.30	(4)	64.00	64.00	56.00	66.00	-	-	-	-	
512177	5.98	4.50	M12x1.5	2.52	2.52	2.20	-	-	-	-	-	Y
	152.00	114.30	(4)	64.00	64.00	56.00	-	-	-	-	-	
512178	5.98	4.50	M12x1.5	2.52	2.52	2.20	-	-	-	-	-	Y
	152.00	114.30	(4)	64.00	64.00	56.00	-	-	-	-	-	
512179	5.98	4.50	M12x1.5	2.52	2.52	2.20	-	-	-	-	-	Y
	152.00	114.30	(5)	64.00	64.00	56.00	-	-	-	-	-	
512180	5.98	4.50	-	2.52	2.52	2.44	2.87	-	-	-	-	Y
	152.00	114.30	(5)	64.00	64.00	62.00	73.00	-	-	-	-	
512181	*	-	-	-	-	-	3.31	4.07	M10x1.25	Modified Rectangle	-	N
		-	-	-	-	-	84.00	103.32	(4)			
512182	5.28	4.50	M12x1.25	2.36	2.52	1.95	2.48	-	-	-	-	N
	134.00	114.30	(4)	60.00	64.00	49.50	63.00	-	-	-	-	
512183	*	-	-	-	-	-	3.31	4.21	M12x1.25	Modified Rectangle	-	N
		-	-	-	-	-	84.00	106.96	(4)			
512184	5.51	3.94	M12x1.5	2.13	2.17	2.94	2.40	3.82	-	Modified Trapezoid	-	Y
	140.00	100.00	(4)	54.00	55.00	74.70	60.96	97.00	(4)			
512185	4.92	-	-	2.28	2.52	2.22	2.10	-	-	-	-	N
	125.00	-	(4)	58.00	64.00	56.50	57.30	-	-	-	-	
512186	5.51	4.50	-	2.64	2.84	2.33	2.80	-	-	-	-	Y
	140.00	114.30	(5)	67.00	72.00	59.21	71.00	-	-	-	-	

*Denotes a Bearing Module

HUB UNIT BEARING / BEARING MODULE - NUMERICAL LISTING

continued

Timken Part No.	Flange Dia	Bolt Circle Dia	Bolt Size (Qty)	Wheel Pilot Dia	Brake Pilot Dia	Flange Offset	Hub Pilot Dia	Bolt Circle Dia	Bolt Hole Size (Qty)	Flange Shape	No. Of Spline	ABS (Y/N)
	A	B	C	D	E	F	G	H	I	J		
512187	5.16	4.41	-	2.24	2.68	2.76	-	3.74	-	Modified Pentagon	-	N
	131.00	112.00	(5)	57.00	68.00	70.00	-	95.00	(5)			
512188	5.49	4.50	M12x1.5 (5)	2.52	2.52	2.21	-	-	-	-	-	Y
	139.50	114.30		64.00	64.00	56.00	-	-				
512189	5.83	4.50	M12x1.5 (5)	2.64	2.99	2.32	2.60	3.94	M10x1.25 (4)	Modified Rectangle	-	Y
	148.00	114.30		67.00	76.00	59.00	66.00	100.00				
512190	5.83	4.50	M12x1.5 (4)	2.64	2.99	2.32	2.60	3.94	M10x1.25 (4)	Modified Rectangle	-	Y
	148.00	114.30		67.00	76.00	59.00	66.00	100.00				
512191	5.83	4.50	M12x1.5 (4)	2.64	2.99	2.32	2.60	3.94	M10x1.25 (4)	Modified Rectangle	-	N
	148.00	114.30		67.00	76.00	59.00	66.00	100.00				
512192	5.51	3.94	M12x1.5 (4)	2.13	2.46	-	2.76	-	-	-	-	Y
	140.00	100.00		54.00	62.50	-	70.00	-				
512193	5.51	3.94	M12x1.5 (4)	2.13	2.46	1.99	2.76	-	-	-	-	N
	140.00	100.00		54.00	62.50	50.50	70.00	-				
512194	5.47	4.50	M12x1.5 (4)	2.64	2.99	2.00	2.91	-	-	-	-	N
	139.00	114.30		67.00	76.00	50.50	74.00	-				
512195	5.47	4.50	M12x1.5 (4)	2.64	2.99	2.00	2.91	-	-	-	-	Y
	139.00	114.30		67.00	76.00	50.50	74.00	-				
512196	5.83	4.50	M12x1.5 (5)	2.64	2.99	-	3.07	-	-	-	-	Y
	148.00	114.30		67.00	76.00	-	78.00	-				
512197	5.83	4.50	M12x1.5 (5)	2.64	2.99	-	3.07	-	-	-	-	N
	148.00	114.30		67.00	76.00	-	78.00	-				
512198	5.47	4.50	M12x1.5 (5)	2.64	2.99	-	2.91	-	-	-	-	Y
	139.00	114.30		67.00	76.00	-	74.00	-				
512199	5.47	4.50	M12x1.5 (5)	2.64	2.99	-	2.91	-	-	-	-	N
	139.00	114.30		67.00	76.00	-	74.00	-				
512200	4.79	3.95	M12x1.5 (4)	2.20	2.27	-	2.64	-	-	-	-	N
	121.62	100.27		55.94	57.68	-	67.09	-				
512201	5.83	4.50	M12x1.25 (5)	2.60	2.68	2.72	3.35	4.21	M12x1.25 (4)	Modified Trapezoid	-	Y
	148.00	114.30		66.00	68.00	69.00	85.20	107.00				
512203	5.83	4.50	M12x1.25 (5)	2.60	2.68	-	-	-	-	-	-	N
	148.00	114.30		66.00	68.00	-	-	-				
512204	5.28	4.50	M12x1.25 (4)	2.36	2.52	1.89	2.36	-	-	-	-	Y
	134.00	114.30		60.00	64.00	48.00	60.00	-				
512215	5.31	3.94	M12x1.5 (5)	2.13	2.17	2.15	2.91	3.66	-	Modified Trapezoid	-	Y
	135.00	100.00		54.00	55.00	54.50	74.00	93.00	(4)			
512216	5.31	3.94	M12x1.5 (5)	2.13	2.17	2.15	2.91	3.66	-	Modified Trapezoid	-	N
	135.00	100.00		54.00	55.00	54.50	74.00	93.00	(4)			
512217	5.31	3.94	M12x1.5 (5)	2.13	2.17	2.15	2.91	3.66	M10x1.25 (4)	Modified Trapezoid	-	Y
	135.00	100.00		54.00	55.00	54.50	74.00	93.00				

*Denotes a Bearing Module

HUB UNIT BEARING / BEARING MODULE - NUMERICAL LISTING

continued

Timken Part No.	Flange Dia	Bolt Circle Dia	Bolt Size (Qty)	Wheel Pilot Dia	Brake Pilot Dia	Flange Offset	Hub Pilot Dia	Bolt Circle Dia	Bolt Hole Size (Qty)	Flange Shape	No. Of Spline	ABS (Y/N)
	A	B	C	D	E	F	G	H	I	J		
512218	5.31	3.94	M12x1.5 (5)	2.13	2.17	2.15	2.91	3.66	M10x1.25 (4)	Modified Trapezoid	-	N
	135.00	100.00		54.00	55.00	54.50	74.00	93.00				
512219	5.87	4.30	M12x1.5 (5)	2.60	2.91	-	-	-	-	-	-	Y
	148.97	109.11		65.91	73.85	-	-	-				
512220	5.33	3.98	M12x1.5 (5)	2.24	2.33	-	-	-	-	-	-	Y
	135.31	101.08		56.90	59.15	-	-	-				
512221	5.93	4.53	M12x1.5 (5)	2.76	2.78	2.56	2.83	3.96	0.47 11.94(4)	Rectangle	-	N
	150.50	115.00		70.10	70.60	65.14	71.80	100.60				
512222	5.73	4.53	M12x1.5 (5)	2.76	2.78	1.66	3.60	4.57	M12x1.75 (3)	Modified Triangle	-	Y
	145.50	115.00		70.10	70.60	42.18	91.42	116.00				
512223	5.73	4.53	M12x1.5 (5)	2.76	2.78	1.66	3.60	4.57	M12x1.75 (3)	Modified Triangle	30	Y
	145.50	115.00		70.10	70.60	42.18	91.42	116.00				
512229	5.91	4.53	M12x1.5 (5)	2.76	2.78	3.25	3.11	-	M10x1.5 (4)	Rectangle	33	Y
	150.00	115.00		70.10	70.60	82.60	79.00	-				
512230	5.91	4.53	M12x1.5 (5)	2.76	2.78	3.25	3.11	-	M10x1.5 (4)	Rectangle	33	N
	150.00	115.00		70.10	70.60	82.60	79.00	-				
512232	5.51	4.13	-	2.58	2.56	-	-	-	-	-	-	Y
	140.00	105.00		(5)	65.43	65.10	-	-				
512235	5.52	4.46	M12x1.5 (4)	2.64	3.55	-	2.82	-	-	-	-	Y
	140.11	113.33		66.93	90.12	-	71.66	-				
512236	5.73	4.53	M12x1.5 (5)	2.76	2.78	1.66	3.60	4.57	M12x1.75 (3)	Modified Triangle	-	N
	145.50	115.00		70.10	70.60	42.06	91.42	116.00				
512237	5.93	4.53	M12x1.5 (5)	2.76	2.78	2.56	2.83	3.96	0.47 11.94(4)	Rectangle	-	Y
	150.50	115.00		70.10	70.60	65.14	71.80	100.60				
512238	5.51	4.33	M12x1.5 (5)	2.56	2.58	3.07	2.36	-	M10x1.25 (4)	Modified Trapezoid	-	Y
	140.00	110.00		64.99	65.47	78.00	60.00	-				
512239	5.51	4.33	M12x1.5 (5)	2.56	2.58	3.07	2.36	-	M10x1.25 (4)	Modified Trapezoid	-	N
	140.00	110.00		64.99	65.47	78.00	60.00	-				
512242	5.47	4.50	M12x1.5 (4)	2.52	2.52	2.35	2.60	-	-	-	-	N
	139.00	114.30		64.00	64.00	59.70	66.00	-				
512255	5.47	4.50	M12x1.5 (5)	2.52	2.52	2.21	-	-	-	-	-	Y
	139.00	114.30		64.00	64.00	56.00	-	-				
512265	5.83	4.50	M12x1.5 (5)	2.64	2.99	2.32	2.87	3.94	M10x1.25 (4)	Modified Rectangle	-	Y
	148.00	114.30		67.00	76.00	59.00	73.00	100.00				
512270	5.51	4.50	M12x1.5 (5)	2.64	2.83	2.40	3.07	-	-	-	-	N
	140.00	114.30		67.00	72.00	61.00	78.00	-				
512280	5.98	4.50	M12x1.5 (5)	2.36	2.44	2.72	3.31	4.09	0.414 10.52(4)	Offset Trapezoid	-	Y
	152.00	114.30		60.00	62.00	69.00	84.00	104.00				
512299	5.74	4.50	1/2-20 (5)	2.49	2.68	1.71	3.43	4.43	M12x1.75 (4)	Modified Rectangle	-	Y
	145.70	114.30		63.24	67.96	43.50	87.20	112.48				

*Denotes a Bearing Module

HUB UNIT BEARING / BEARING MODULE - NUMERICAL LISTING

continued

Timken Part No.		Flange Dia	Bolt Circle Dia	Bolt Size (Qty)	Wheel Pilot Dia	Brake Pilot Dia	Flange Offset	Hub Pilot Dia	Bolt Circle Dia	Bolt Hole Size (Qty)	Flange Shape	No. Of Spline	ABS (Y/N)
		A	B	C	D	E	F	G	H	I	J		
512305	*	-	-	-	-	-	-	1.76	4.21	M12X1.5 (4)	Modified Rectangle	-	N
		-	-	-	-	-	-	44.68	107.00				
512322		5.98	4.50	M12X1.5 (5)	2.52	2.52	2.30	2.76	3.94	M10X1.25 (4)	Modified Trapezoid	-	Y
		152.00	114.30		64.00	64.00	58.50	70.00	100.00				
512323		5.47	3.94	M12X1.5 (4)	2.21	61.00	2.21	-	-	-	-	-	Y
		139.00	100.00		56.00	2.40	56.00	-	-				
512324		5.53	3.92	M12X1.5 (4)	2.12	2.46	2.28	2.64	3.63	M10X1.25 (4)	Modified Rectangle	-	Y
		140.02	99.68		53.94	62.47	57.98	66.92	92.08				
512326		5.47	4.50	M12X1.5 (5)	2.64	2.72	2.10	3.62	4.50	M12X1.25 (4)	Modified Square	-	Y
		139.00	114.30		67.00	69.00	53.40	92.00	114.30				
512340		5.83	4.50	M12X1.5 (5)	2.64	2.99	2.32	2.87	3.94	M10X1.25 (4)	Modified Rectangle	-	Y
		148.00	114.30		67.00	76.00	59.00	73.00	100.00				
513003		5.43	3.94	M12x1.5 (5)	2.24	2.26	2.56	2.83	3.96	0.47 11.94(4)	Rectangle	-	N
		138.00	100.00		57.00	57.49	65.14	71.80	100.60				
513004K		4.92	3.94	M12x1.5 (5)	2.24	2.30	1.70	2.89	3.86	0.43 11.00(3)	Modified Triangle	33	N
		125.00	100.00		57.00	58.33	43.18	73.50	98.00				
513010		5.77	4.75	M12x1.5 (5)	2.76	2.78	2.72	2.83	-	0.47 11.91(4)	Rectangle	-	N
		146.56	120.65		71.10	70.60	69.00	71.80	-				
513011K		4.94	3.94	M12x1.5 (5)	2.25	2.27	1.65	2.80	4.02	0.5 12.70(3)	Modified Triangle	33	N
		125.40	100.00		57.02	57.73	41.91	71.00	102.01				
513012		5.43	3.94	M12x1.5 (5)	2.24	2.26	2.55	2.40	-	0.42 10.75(4)	Offset Trapezoid	-	N
		138.00	100.00		56.96	57.46	64.76	60.92	-				
513013		5.69	4.75	M12x1.5 (5)	2.76	2.78	1.86	3.21	4.75	M12x1.75 (3)	Modified Triangle	27	N
		144.50	120.65		70.10	70.60	47.28	81.50	120.65				
513016K		5.73	4.53	M12x1.5 (5)	2.76	2.78	1.66	3.55	4.57	0.51 12.96(3)	Modified Triangle	27	N
		145.50	115.00		70.10	70.60	42.18	90.05	116.00				
513017K		4.92	3.94	M12x1.5 (5)	2.24	2.30	1.75	2.89	3.86	0.51 12.96(3)	Modified Triangle	33	N
		125.00	100.00		57.00	58.33	44.43	73.50	98.00				
513018		5.93	4.53	M12x1.5 (5)	2.76	2.78	2.56	2.83	3.96	0.47 11.94(4)	Rectangle	-	N
		150.50	115.00		70.10	70.60	65.14	71.80	100.60				
513019		5.79	4.75	M12x1.5 (5)	2.76	2.78	2.72	2.83	3.96	0.46 11.69(4)	Rectangle	-	Y
		147.00	120.65		70.10	70.60	68.95	71.76	100.60				
513020		5.59	4.75	M12x1.5 (5)	2.76	2.78	1.86	3.62	4.75	M12x1.75 (3)	Modified Triangle	27	N
		142.10	120.65		70.10	70.60	47.28	91.98	120.65				
513030		4.80	3.94	M12x1.5 (4)	2.13	2.17	2.20	2.56	-	-	-	-	N
		122.00	100.00		54.00	55.00	56.00	65.00	-				
513033		5.35	3.94	M12x1.5 (4)	2.21	2.40	-	2.60	-	-	-	-	N
		136.00	100.00		56.00	61.00	-	66.00	-				
513034		5.28	3.94	M12x1.5 (4)	2.20	2.40	1.95	2.36	-	-	-	-	N
		134.00	100.00		56.00	61.00	49.50	60.00	-				

*Denotes a Bearing Module

HUB UNIT BEARING / BEARING MODULE - NUMERICAL LISTING

continued

Timken Part No.	Flange Dia	Bolt Circle Dia	Bolt Size (Qty)	Wheel Pilot Dia	Brake Pilot Dia	Flange Offset	Hub Pilot Dia	Bolt Circle Dia	Bolt Hole Size (Qty)	Flange Shape	No. Of Spline	ABS (Y/N)
	A	B	C	D	E	F	G	H	I	J		
513035	5.28	3.94	M12x1.5 (4)	2.20	2.40	1.95	2.46	-	-	-	-	N
	134.00	100.00		56.00	61.00	49.50	62.50	-				
513038	5.93	4.53	M12x1.5 (5)	2.76	2.78	2.56	2.83	3.96	0.47 11.94(4)	Rectangle	-	Y
	150.50	115.00		70.10	70.60	65.14	71.80	100.60				
513039	5.93	4.53	M12x1.5 (5)	2.76	2.78	2.56	2.83	3.96	0.47 11.94(4)	Rectangle	-	Y
	150.50	115.00		70.10	70.60	65.14	71.80	100.60				
513041	5.93	4.53	M12x1.5 (5)	2.76	2.78	2.56	2.83	3.96	0.47 11.94(4)	Rectangle	-	Y
	150.50	115.00		70.10	70.60	65.14	71.80	100.60				
513042	5.93	4.53	M12x1.5 (5)	2.76	2.78	2.56	2.83	3.96	0.47 11.94(4)	Rectangle	-	Y
	150.50	115.00		70.10	70.60	65.14	71.80	100.60				
513044	5.69	4.53	M12x1.5 (5)	2.76	2.78	1.77	4.69	5.75	M10x1.5 (4)	Modified Trapezoid	33	N
	144.50	115.00		70.14	70.63	45.02	119.04	146.00				
513049	5.47	4.50	M12x1.5 (4)	2.52	2.52	2.17	2.80	-	-	-	-	Y
	139.00	114.30		64.00	64.00	55.00	71.00	-				
513050	5.28	3.94	M12x1.5 (4)	2.20	2.40	1.95	2.46	-	-	-	-	N
	134.00	100.00		56.00	61.00	49.50	62.50	-				
513059	5.73	4.53	M12x1.5 (5)	2.76	2.78	1.66	3.55	4.57	0.51 12.96(3)	Modified Triangle	33	N
	145.50	115.00		70.10	70.60	42.18	90.05	116.00				
513061	5.69	4.75	M12x1.5 (5)	2.76	2.78	1.86	3.21	4.75	M12x1.75 (3)	Modified Triangle	27	Y
	144.50	120.65		70.10	70.60	47.28	81.50	120.65				
513062	5.93	4.53	M12x1.5 (5)	2.76	2.78	2.56	2.83	3.96	0.47 11.94(4)	Rectangle	-	Y
	150.50	115.00		70.10	70.60	65.14	71.80	100.60				
513063	5.77	4.53	M12x1.5 (5)	2.76	2.78	1.66	3.55	4.57	0.51 12.95(3)	Modified Rectangle	33	N
	146.51	115.01		70.13	70.64	42.16	90.04	116.00				
513070	5.24	4.25	M12x1.5 (5)	2.36	2.60	-	2.80	-	-	-	-	N
	133.00	107.95		60.00	66.00	-	71.00	-				
513074	5.51	4.50	M12x1.5 (5)	2.81	2.89	1.47	3.40	4.41	M10x1.5 (4)	Modified Rectangle	26	N
	140.00	114.30		71.30	73.32	37.50	86.45	112.00				
513075	4.97	3.94	M12x1.5 (5)	2.24	2.40	1.48	3.43	4.41	M10x1.5 (4)	Rectangle	26	N
	126.25	100.00		56.90	60.93	37.60	87.05	112.00				
513076	5.48	4.25	M12x1.5 (5)	2.49	2.53	-	-	-	-	-	-	Y
	139.00	107.95		63.20	64.30	-	-	-				
513077	-	4.25	M12x1.5 (5)	2.49	2.53	-	-	-	-	-	-	N
	-	107.95		63.20	64.28	-	-	-				
513078	5.24	3.94	M12x1.5 (4)	2.36	2.60	-	2.80	-	-	Rectangle	-	N
	133.00	100.00		60.00	66.00	-	71.00	-				
513080	5.98	4.50	M12x1.5 (4)	2.52	2.52	2.20	2.60	-	-	-	-	N
	152.00	114.30		64.00	64.00	56.00	66.00	-				
513081	5.98	4.50	M12x1.5 (4)	2.52	2.52	2.20	2.60	-	-	-	-	Y
	152.00	114.30		64.00	64.00	56.00	66.00	-				

*Denotes a Bearing Module

HUB UNIT BEARING / BEARING MODULE - NUMERICAL LISTING

continued

Timken Part No.	Flange Dia	Bolt Circle Dia	Bolt Size (Qty)	Wheel Pilot Dia	Brake Pilot Dia	Flange Offset	Hub Pilot Dia	Bolt Circle Dia	Bolt Hole Size (Qty)	Flange Shape	No. Of Spline	ABS (Y/N)
	A	B	C	D	E	F	G	H	I	J		
513082	5.70	4.50	1/2-20 (5)	2.81	2.88	2.12	3.39	4.50	1/2-20 (4)	Circular	26	N
	144.78	114.30		71.32	73.25	53.72	85.98	114.30				
513084	6.06	4.50	1/2-20 (5)	2.81	2.83	2.13	3.94	4.75	M12x1.75 (3)	Modified Triangle	27	N
	153.97	114.30		71.42	71.88	54.18	100.13	120.65				
513085	5.79	4.75	M12x1.5 (5)	2.76	2.78	2.71	2.83	3.96	0.47 11.94(4)	Rectangle	-	Y
	147.00	120.65		70.10	70.60	68.95	71.76	100.60				
513087	5.73	4.53	M12x1.5 (5)	2.76	2.78	1.66	3.60	4.57	0.51 12.96(3)	Modified Triangle	33	Y
	145.50	115.00		70.10	70.60	42.18	91.42	116.00				
513088	5.73	4.53	M12x1.5 (5)	2.76	2.78	1.66	3.60	4.57	0.51 12.96(3)	Modified Triangle	33	N
	145.50	115.00		70.10	70.60	42.18	91.42	116.00				
513089	5.73	4.50	M12x1.5 (5)	2.81	2.89	1.66	3.58	4.57	M12x1.75 (3)	Modified Triangle	33	N
	145.50	114.30		71.42	73.28	42.06	91.00	116.00				
513090	5.79	4.75	M12x1.5 (5)	2.76	2.78	2.71	2.82	3.96	M10x1.5 (4)	Rectangle	-	Y
	147.00	120.65		70.10	70.60	68.72	71.72	100.60				
513092	5.47	4.25	M12x1.5 (5)	2.49	2.80	1.87	-	-	-	-	-	Y
	139.00	107.95		63.26	71.00	47.60	-	-				
513093	*	-	-	-	-	-	3.27	-	M10x1.25 (4)	Modified Trapezoid	-	N
	-	102.00		-	-	-	83.00	-				
513094	5.63	4.72	M12x1.5 (5)	2.85	2.95	-	-	-	-	Circle	-	Y
	143.00	120.00		72.50	75.00	-	-	-				
513096	5.47	4.72	M12x1.5 (5)	2.85	3.10	-	-	-	-	-	-	Y
	139.00	120.00		72.44	78.79	-	-	-				
513098	*	-	-	-	-	-	3.27	4.02	M10x1.25 (4)	Modified Trapezoid	-	N
	-	-		-	-	-	83.00	102.00				
513099	*	-	-	-	-	-	3.31	4.17	M10x1.25 (4)	Modified Trapezoid	-	N
	-	-		-	-	-	84.00	106.00				
513100	5.47	4.25	M12x1.5 (5)	2.49	2.79	1.41	3.37	4.41	M12x1.75 (3)	Modified Triangle	26	N
	139.00	107.95		63.23	70.97	35.90	85.50	112.00				
513104	5.94	4.50	1/2-20 (5)	2.77	2.82	2.05	3.07	-	-	-	-	Y
	151.00	114.30		70.47	71.63	52.00	78.00	-				
513105	5.35	3.94	M12x1.5 (4)	2.20	2.40	2.17	-	-	-	-	-	Y
	136.00	100.00		56.00	61.00	55.00	-	-				
513107	5.67	4.50	1/2-20 (5)	2.81	2.83	1.81	3.94	4.75	M12x1.75 (3)	Modified Triangle	27	N
	144.00	114.30		71.30	71.83	46.00	100.00	120.65				
513109	5.68	4.50	1/2-20 (6)	2.82	2.88	2.11	3.82	4.50	1/2-20 (4)	Rectangle	31	N
	144.00	114.30		71.43	73.00	54.00	97.00	114.30				
513111	4.72	3.94	-	2.24	2.60	1.65	2.60	-	-	-	-	Y
	120.00	100.00		(4)	57.00	66.00	42.00	66.00				
513114	5.51	4.50	M12x1.5 (5)	2.64	2.83	2.40	3.07	-	-	-	-	Y
	140.00	114.30		67.00	72.00	61.00	78.00	-				

*Denotes a Bearing Module

HUB UNIT BEARING / BEARING MODULE - NUMERICAL LISTING

continued

Timken Part No.	Flange Dia	Bolt Circle Dia	Bolt Size (Qty)	Wheel Pilot Dia	Brake Pilot Dia	Flange Offset	Hub Pilot Dia	Bolt Circle Dia	Bolt Hole Size (Qty)	Flange Shape	No. Of Spline	ABS (Y/N)
	A	B	C	D	E	F	G	H	I	J		
513115	5.47	4.50	1/2-20 (5)	2.78	2.80	1.87	3.15	-	-	-	-	Y
	139.00	114.30		70.50	71.00	47.60	80.00	-	-	-	-	Y
513121	5.73	4.53	M12x1.5 (5)	2.76	2.78	1.66	3.59	4.57	M12x1.75 (3)	Modified Triangle	33	Y
	145.50	115.00		70.10	70.60	42.06	91.25	116.00				
513122	4.96	3.94	M12x1.5 (5)	2.24	2.40	1.47	3.43	4.41	M10x1.5 (4)	Rectangle	26	N
	26.00	100.00		56.80	60.80	37.30	87.00	112.00				
513123	5.49	4.50	M12x1.5 (5)	2.81	2.88	1.47	3.43	4.41	M10x1.5 (4)	Rectangle	26	N
	139.32	114.30		71.32	73.25	37.50	87.00	112.00				
513124	5.69	4.75	M12x1.5 (5)	2.76	2.78	1.85	3.62	4.75	M12x1.75 (3)	Modified Triangle	27	Y
	144.50	120.65		70.10	70.60	47.00	91.98	120.65				
513125	5.63	4.72	M12x1.5 (5)	2.83	3.11	-	-	-	-	-	48	Y
	143.00	120.00		72.00	79.00	-	-	-				
513126	5.14	4.27	0.492 12.50(4)	2.68	2.56	1.46	3.26	4.06	0.334 8.48(4)	Rectangle	26	N
	130.58	108.36		67.95	64.90	37.01	82.88	103.23				
513127	5.18	4.23	-	2.56	2.67	1.46	3.18	4.06	0.41 10.54(4)	Rectangle	26	N
	131.47	107.54		64.92	67.92	37.11	80.84	103.23				
513128	5.39	4.25	M12x1.5 (5)	2.56	2.68	-	-	-	-	-	-	N
	136.86	107.95		64.97	67.95	-	-	-				
513131	5.51	4.50	M12x1.5 (5)	2.64	2.83	2.40	3.07	-	-	-	-	Y
	140.00	114.30		67.00	72.00	61.00	78.00	-				
513132	5.47	4.50	M12x1.5 (6)	2.81	2.90	1.50	3.43	4.41	0.314 7.98(4)	Rectangle	-	N
	138.99	114.30		71.32	73.56	38.10	87.02	111.88				
513133	5.47	4.50	M12x1.5 (5)	2.72	2.72	1.52	3.43	4.41	M12x1.25 (4)	Modified Rectangle	27	N
	139.00	114.30		69.00	69.00	38.50	87.00	112.00				
513135	*	-	-	-	-	-	3.23	4.17	M12x1.25 (4)	Modified Trapezoid	-	N
	-	-		-	-	-	82.00	106.00				
513137	5.73	4.53	M12x1.5 (5)	2.76	2.78	1.46	3.60	4.57	M12x1.75 (3)	Modified Triangle	30	Y
	145.50	115.00		70.10	70.60	37.10	91.42	116.00				
513138	4.96	3.94	M12x1.5 (5)	2.24	2.40	1.48	3.43	4.33	M12x1.75 (3)	Modified Triangle	26	N
	125.91	100.00		56.79	60.83	37.47	87.00	110.01				
513139	5.73	4.75	M12x1.5 (5)	2.76	2.78	1.66	3.60	4.57	M12x1.75 (3)	Modified Triangle	-	Y
	145.50	120.65		70.10	70.60	42.18	91.42	116.00				
513142	5.24	3.94	M12x1.5 (4)	2.36	2.60	-	2.79	-	-	-	-	N
	132.99	100.00		59.99	65.99	-	70.76	-				
513152	4.80	3.94	M12x1.5 (4)	2.13	2.17	2.13	2.40	-	-	-	-	N
	122.00	100.00		54.00	55.00	54.00	61.00	-				
513153	5.51	4.50	M12x1.5 (5)	2.64	2.83	2.40	3.07	-	-	-	-	Y
	140.00	114.30		67.00	72.00	61.00	78.00	-				
513155	4.80	3.94	M12x1.5 (4)	2.13	2.17	2.13	-	-	-	-	-	Y
	122.00	100.00		54.00	55.00	54.00	-	-				

*Denotes a Bearing Module

HUB UNIT BEARING / BEARING MODULE - NUMERICAL LISTING

continued

Timken Part No.	Flange Dia	Bolt Circle Dia	Bolt Size (Qty)	Wheel Pilot Dia	Brake Pilot Dia	Flange Offset	Hub Pilot Dia	Bolt Circle Dia	Bolt Hole Size (Qty)	Flange Shape	No. Of Spline	ABS (Y/N)
	A	B	C	D	E	F	G	H	I	J		
513156	5.47	4.25	M12x1.5 (5)	2.49	2.77	1.63	3.29	4.49	M12x1.75 (3)	Modified Triangle	26	N
	139.00	107.95		63.23	70.37	41.45	83.50	114.00				
513157	5.59	4.50	M12x1.5 (5)	2.63	2.71	1.60	2.52	4.17	M12x1.25 (4)	Modified Trapezoid	-	N
	142.00	114.30		66.90	68.88	40.62	64.00	106.00				
513160	5.73	4.53	M12x1.5 (5)	2.76	2.78	1.66	3.60	4.57	M12x1.75 (3)	Modified Triangle	33	N
	145.50	115.00		70.10	70.60	42.18	91.42	116.00				
513178	6.04	4.47	M12x1.5 (5)	2.81	2.86	2.12	3.74	4.63	-	Modified Triangle	-	N
	153.47	113.47		71.42	72.64	53.87	94.89	117.58				
513179	5.73	4.53	M12x1.5 (5)	2.76	2.78	1.66	3.60	4.57	M12x1.75 (3)	Modified Triangle	33	Y
	145.50	115.00		70.10	70.60	42.18	91.42	116.00				
513186	5.73	4.53	M12x1.5 (5)	2.76	2.78	1.66	3.60	4.57	M12x1.75 (3)	Modified Triangle	-	Y
	145.50	115.00		70.10	70.60	42.18	91.42	116.00				
513187	5.73	4.53	M12x1.5 (5)	2.76	2.78	1.66	3.60	4.57	M12x1.75 (3)	Modified Triangle	33	Y
	145.50	115.00		70.10	70.60	42.06	91.42	116.00				
513188	5.94	5.00	M12x1.5 (6)	3.06	3.11	1.85	3.62	4.75	M12x1.75 (3)	Modified Triangle	27	Y
	150.75	127.00		77.78	78.98	47.00	91.98	120.65				
513189	5.91	4.53	M12x1.5 (5)	2.76	2.78	2.99	3.59	4.57	M12x1.75 (3)	Modified Triangle	-	Y
	150.00	115.00		70.10	70.60	76.01	91.25	116.00				
513190	5.91	4.53	M12x1.5 (5)	2.76	2.78	2.99	3.59	4.57	M12x1.75 (3)	Modified Triangle	-	N
	150.00	115.00		70.10	70.60	76.01	91.25	116.00				
513193	6.69	5.50	M12x1.5 (5)	4.13	4.26	-	3.10	-	-	-	-	Y
	170.00	139.70		105.00	108.25	-	78.65	-				
513194	5.34	4.08	-	2.55	2.70	1.69	3.44	4.08	-	Modified Rectangle	-	N
	135.64	103.58		(5)	64.82	68.58	43.00	87.43				
513196	5.95	4.45	-	2.75	2.98	1.41	3.43	3.86	-	Modified Rectangle	-	Y
	151.00	112.92		(5)	69.93	75.58	35.76	87.06				
513202	5.96	4.25	M12x2.4 (5)	2.77	2.83	2.17	-	-	-	-	-	Y
	151.53	107.95		70.51	71.90	55.32	-	-				
513226	5.41	3.94	M12x1.5 (4)	2.21	2.52	1.73	3.19	4.02	M10x1.5 (4)	Modified Trapezoid	26	Y
	137.50	100.00		56.00	64.00	44.00	81.00	102.00				
513230	5.95	4.50	1/2-20 (5)	2.77	2.82	1.50	3.52	4.40	M12x1.75 (4)	Modified Rectangle	-	Y
	151.18	114.30		70.46	71.70	37.99	89.45	111.66				
513256	5.47	4.50	M12x1.5 (5)	2.64	2.72	2.10	3.62	4.50	M12x1.25 (4)	Modified Rectangle	-	N
	139.00	114.30		67.00	69.00	53.40	92.00	114.30				
513266	139.00	4.50	M12x1.5 (5)	2.64	2.72	2.10	3.62	4.50	M12x1.25 (4)	Modified Square	-	N
	5.47	114.30		67.00	69.00	53.40	92.00	114.30				
515000	5.69	4.50	1/2-20 (5)	2.51	2.54	2.02	3.94	4.75	M12x1.75 (3)	Modified Triangle	26	N
	144.50	114.30		63.80	64.40	51.30	100.00	120.60				
515001	7.16	5.50	M14x1.5 (6)	3.06	3.08	2.23	3.91	4.96	0.58 14.73(3)	Modified Triangle	33	N
	181.76	139.70		77.60	78.11	56.74	99.31	125.98				

*Denotes a Bearing Module

HUB UNIT BEARING / BEARING MODULE TECHNOLOGY

HUB UNIT BEARING / BEARING MODULE - NUMERICAL LISTING

continued

Timken Part No.	Flange Dia	Bolt Circle Dia	Bolt Size (Qty)	Wheel Pilot Dia	Brake Pilot Dia	Flange Offset	Hub Pilot Dia	Bolt Circle Dia	Bolt Hole Size (Qty)	Flange Shape	No. Of Spline	ABS (Y/N)
	A	B	C	D	E	F	G	H	I	J		
515002	7.17	5.50	M14x1.5 (6)	3.06	3.08	1.99	3.91	4.96	0.58 14.73(3)	Modified Triangle	33	N
	181.99	139.70		77.60	78.11	50.55	99.31	125.98				
515005	6.72	5.00	1/2-20 (5)	3.06	3.09	2.93	3.85	4.96	0.58 14.73(3)	Modified Triangle	33	Y
	170.69	127.00		77.60	78.36	74.30	97.71	125.98				
515006	6.78	5.50	1/2-20 (5)	3.06	3.09	2.03	3.91	4.96	M14x1.5 (3)	Modified Triangle	33	N
	172.09	139.70		77.72	78.49	51.44	99.31	125.98				
515014	5.88	4.50	1/2-20 (5)	2.77	2.82	2.21	3.94	4.74	M12X1.75 (3)	Modified Triangle	27	N
	149.40	114.30		70.36	71.62	56.13	100.00	120.40				
515017	7.17	5.32	M12X1.75 (5)	3.42	3.54	1.94	3.91	4.96	M14x1.5 (3)	Modified Triangle	33	N
	181.99	135.03		86.74	89.97	49.28	99.31	125.88				
515020	7.99	6.69	M14X2 (8)	4.92	5.08	2.15	4.48	5.51	M14X1.5 (4)	Square	55	Y
	203.00	170.00		124.97	129.01	54.50	113.90	140.00				
515021	7.99	6.69	M14x2 (8)	4.92	5.08	2.15	4.48	5.51	M14x1.5 (4)	Square	55	N
	203.00	170.00		124.97	129.01	54.50	113.90	140.00				
515022	7.13	5.91	M12X1.75 (7)	3.41	3.64	1.95	3.91	4.96	M14x1.5 (3)	Modified Triangle	33	N
	181.00	150.00		86.72	92.35	49.65	99.34	126.00				
515025	7.99	6.69	M14X2 (8)	4.92	5.08	2.15	4.48	5.51	M14X1.5 (4)	Square	55	Y
	203.00	170.00		124.97	129.01	54.50	113.90	140.00				
515026	5.88	4.50	1/2-20 (5)	2.78	2.84	2.21	3.94	4.75	M12X1.75 (3)	Modified Triangle	42	N
	149.40	114.30		70.61	72.14	56.13	100.08	120.65				
515027	5.88	4.50	1/2-20 (5)	2.78	2.84	2.21	3.94	4.75	M12X1.75 (3)	Modified Triangle	42	Y
	149.40	114.30		70.61	72.14	56.13	100.08	120.65				
515028	7.13	5.31	M14X2 (5)	3.42	3.42	1.95	3.91	4.96	M14x1.5 (3)	Modified Triangle	33	N
	181.00	135.00		86.87	86.87	49.53	99.31	125.98				
515029	7.13	5.32	M14X2 (5)	3.41	3.54	1.96	3.91	4.96	M14X1.5 (3)	Modified Triangle	33	Y
	181.00	135.00		86.72	89.90	49.65	99.34	126.00				
515030	7.14	5.91	M12X1.75 (7)	3.42	3.63	1.94	3.91	4.96	- (3)	Modified Triangle	33	Y
	181.35	150.00		86.74	92.20	49.28	99.31	126.00				
515031	7.13	5.31	M14X2.0 (5)	3.41	3.64	1.95	3.91	4.96	- (3)	Modified Triangle	33	Y
	181.00	135.00		86.72	92.35	49.56	99.34	126.00				
518500	4.80	3.94	M12x1.5 (4)	2.24	2.40	-	2.99	3.70	M8x1.25 (3)	-	26	N
	122.00	100.00		56.85	60.87	-	76.00	94.00				
518501	4.96	3.94	M12x1.5 (4)	2.24	2.40	-	2.99	4.46	M8x1.25 (3)	-	26	N
	126.00	100.00		56.85	60.87	-	76.00	113.00				
518502	4.96	3.94	M12x1.5 (5)	2.24	2.40	-	2.99	4.46	M8x1.25 (3)	-	26	N
	126.00	100.00		56.85	60.87	-	76.00	113.00				
518503	2.49	4.25	M12x1.5 (4)	2.49	2.49	3.06	-	-	-	-	26	N
	63.35	107.95		63.12	63.35	77.72	-	-				
518504	4.72	3.94	M12x1.5 (4)	2.20	2.93	-	-	-	-	-	24	N
	120.00	100.00		55.84	60.80	-	-	-				

*Denotes a Bearing Module

HUB UNIT BEARING / BEARING MODULE - NUMERICAL LISTING

continued

Timken Part No.		Flange Dia	Bolt Circle Dia	Bolt Size (Qty)	Wheel Pilot Dia	Brake Pilot Dia	Flange Offset	Hub Pilot Dia	Bolt Circle Dia	Bolt Hole Size (Qty)	Flange Shape	No. Of Spline	ABS (Y/N)
		A	B	C	D	E	F	G	H	I	J		
518505		4.80	3.94	M12x1.5 (4)	2.21	2.42	-	-	-	-	-	-	N
		122.00	100.00		56.23	61.44	-	-	-				
518506		4.88	3.94	M12x1.5 (5)	2.13	-	-	1.49	-	-	-	26	N
		123.95	100.00		53.98	-	-	37.99	-				
518507		4.88	3.94	M12x1.5 (4)	2.13	2.19	-	-	-	-	-	26	N
		123.95	100.00		54.05	54.97	-	-	-				
520000		5.49	4.25	M12x1.5 (5)	2.50	2.54	2.40	-	-	-	-	26	N
		139.32	107.95		63.37	64.39	60.99	-	-				
520100		5.49	4.25	M12x1.5 (5)	2.49	2.79	2.23	-	-	-	-	26	N
		139.32	107.95		63.25	70.94	56.67	-	-				
BM500000	*	-	-	-	-	-	-	3.17	4.72	M10X1.25 (3)	Modified Polygon	-	Y
		-	-	-	-	-	-	80.60	120.00				
BM500001	*	-	-	-	-	-	-	3.54	4.17	M12X1.5 (4)	Modified Square	-	Y
		-	-	-	-	-	-	90.00	106.00				
BM500002	*	-	-	-	-	-	-	3.17	4.72	M10X1.25 (3)	Modified Polygon	-	Y
		-	-	-	-	-	-	80.60	120.00				
BM500003	*	-	-	-	-	-	-	3.17	4.72	M10X1.25 (3)	Modified Polygon	-	Y
		-	-	-	-	-	-	80.60	120.00				
BM500005	*	-	-	-	-	-	-	3.30	4.21	M12X1.25 (4)	Modified Rectangle	-	N
		-	-	-	-	-	-	83.86	106.96				
BM500006	*	-	-	-	-	-	-	3.31	4.21	-	Modified Trapezoid	-	Y
		-	-	-	-	-	-	84.00	107.00				
BM500007	*	-	-	-	-	-	-	3.78	5.20	0.492 (4)	Rectangle	-	-
		-	-	-	-	-	-	96.00	132.00				
BM500009	*	-	-	-	-	-	-	3.78	5.21	0.49 12.45(4)	Square	-	Y
		-	-	-	-	-	-	95.98	132.40				
BM500012	*	-	-	-	-	-	-	3.62	4.50	M12X1.5 (4)	Modified Rectangle	-	Y
		-	-	-	-	-	-	91.98	114.30				
BM500014	*	-	-	-	-	-	-	3.17	4.70	M10X1.25 (3)	Modified Polygon	-	N
		-	-	-	-	-	-	80.55	119.45				
BM500015	*	-	-	-	-	-	-	3.94	5.55	0.47 11.35(4)	Modified Polygon	-	Y
		-	-	-	-	-	-	99.94	141.06				
BM500016	*	-	-	-	-	-	-	3.93	5.55	0.474 12.04(4)	Modified Polygon	-	Y
		-	-	-	-	-	-	99.92	141.06				
BM500017	*	-	-	-	-	-	-	4.17	5.72	0.489 12.42(4)	Modified Square	-	Y
		-	-	-	-	-	-	105.99	145.24				
BM500018	*	-	-	-	-	-	-	4.17	5.71	0.500 12.7(4)	Modified Square	-	Y
		-	-	-	-	-	-	106.00	145.00				
BM500019	*	-	-	-	-	-	-	4.17	5.55	M12X1.25 (4)	Modified Square	-	Y
		-	-	-	-	-	-	106.00	141.00				

*Denotes a Bearing Module

HUB UNIT BEARING / BEARING MODULE TECHNOLOGY

HUB UNIT BEARING / BEARING MODULE - NUMERICAL LISTING

continued

Timken Part No.		Flange Dia	Bolt Circle Dia	Bolt Size (Qty)	Wheel Pilot Dia	Brake Pilot Dia	Flange Offset	Hub Pilot Dia	Bolt Circle Dia	Bolt Hole Size (Qty)	Flange Shape	No. Of Spline	ABS (Y/N)
		A	B	C	D	E	F	G	H	I	J		
BM500022	*	-	-	-	-	-	-	3.43	4.50	0.409 10.4(4)	Modified Rectangle	-	N
		-	-	-	-	-	-	87.00	114.30				
BM500029	*	-	-	-	-	-	-	3.94	5.51	0.477 12.12(4)	Modified Trapezoid	-	Y
		-	-	-	-	-	-	100.00	140.00				
BM500030	*	-	-	-	-	-	-	3.94	5.51	0.472 12(4)	Modified Trapezoid	-	Y
		-	-	-	-	-	-	100.00	140.00				
BM513161	*	-	-	-	-	-	-	2.72	3.66	M10X1.25 (4)	Modified Rectangle	-	N
		-	-	-	-	-	-	69.00	93.00				
HA500100		7.22	5.50	9/16-18 (5)	3.06	3.09	1.85	3.54	4.96	M14x1.5 (3)	Modified Triangle	33	N
		183.30	139.70		77.76	78.42	47.08	90.04	126.00				
HA500701		5.83	4.50	-	2.60	2.68	2.72	3.50	4.49	M12X1.25 (4)	Modified Rectangle	32	N
		148.00	114.30		(6)	65.91	67.95	69.00	89.00				
HA590001		7.10	5.50	1/2-20 (5)	3.06	3.13	-	-	-	-	-	-	Y
		180.41	139.71		77.78	79.60	-	-	-				
HA590002		5.32	3.93	M12x1.5 (5)	2.13	2.18	2.18	2.91	3.65	M10x1.25 (4)	Modified Rectangle	26	N
		135.00	99.76		54.03	55.30	55.40	73.96	92.68				
HA590003		7.12	5.50	M14x1.5 (6)	2.90	3.08	2.15	4.17	5.51	-	Square	37	N
		180.78	139.70		73.75	78.26	54.65	105.91	140.00				
HA590004		7.85	6.50	M14x1.5 (8)	4.44	4.61	2.40	4.17	5.73	M12x1.75	-	37	N
		199.40	165.10		112.73	117.00	60.98	105.87	145.56				
HA590005		5.98	4.50	M12X1.5 (5)	2.52	2.52	-	-	-	-	-	-	Y
		152.00	114.30		64.00	64.00	-	-	-				
HA590006		5.51	4.72	(5)	2.74	2.82	1.69	2.99	4.25	M12X1.75 (3)	Modified Circle	-	Y
		140.00	120.00		-	69.50	71.50	43.00	76.00				
HA590008		5.28	3.94	M12x1.5 (4)	2.21	2.40	-	-	-	-	-	-	Y
		134.00	100.00		56.00	61.00	-	-	-				
HA590009		5.47	3.94	M12x1.5 (4)	2.21	2.40	2.21	-	-	-	-	-	Y
		139.00	100.00		56.06	61.00	56.00	-	-				
HA590010		5.83	4.50	M12x1.5 (5)	2.64	2.99	2.52	2.83	3.94	M12x1.25 (4)	Modified Trapezoid	-	Y
		148.00	114.30		67.00	76.00	64.00	72.00	100.00				
HA590012		5.63	4.50	M12x1.5 (5)	2.64	2.80	-	-	-	-	-	-	Y
		143.00	114.30		66.95	71.00	-	-	-				
HA590013		5.63	4.50	M12x1.5 (5)	2.64	2.80	-	-	-	-	-	-	Y
		143.00	114.30		66.93	71.07	-	-	-				
HA590014		5.51	4.50	M12x1.5 (5)	2.64	2.83	-	-	-	-	-	-	Y
		140.00	114.30		67.00	72.00	-	-	-				
HA590016		6.35	5.49	M12x1.5 (6)	3.63	3.79	-	3.30	4.24	-	Trapezoid	-	Y
		161.35	139.49		92.28	96.28	-	83.85	107.79				
HA590017		5.83	4.50	1/2-20 (5)	2.77	2.80	-	-	-	-	-	-	Y
		148.00	114.30		70.48	71.12	-	-	-				

*Denotes a Bearing Module

HUB UNIT BEARING / BEARING MODULE - NUMERICAL LISTING

continued

Timken Part No.	Flange Dia	Bolt Circle Dia	Bolt Size (Qty)	Wheel Pilot Dia	Brake Pilot Dia	Flange Offset	Hub Pilot Dia	Bolt Circle Dia	Bolt Hole Size (Qty)	Flange Shape	No. Of Spline	ABS (Y/N)
	A	B	C	D	E	F	G	H	I	J		
HA590018	8.19	6.50	9/16-18 (8)	4.59	-	2.69	4.48	5.51	M14X1.5 (4)	Rectangle	33	N
	208.00	165.10		116.64		68.25	113.86	140.00				
HA590019	5.49	4.50	M12x1.5 (5)	2.52	2.52	2.32	2.91	3.94	M10x1.25 (4)	Modified Trapezoid	-	Y
	139.50	114.30		64.00	64.00	58.80	74.00	100.00				
HA590020	8.42	6.50	0.60 15.24(8)	4.77	-	2.97	4.48	5.50	M14x1.5 (4)	Square	33	N
	213.87	165.10		121.16	-	75.31	113.89	139.70				
HA590021	6.14	4.50	1/2-20 (5)	2.49	2.54	2.40	2.91	4.28	M12x1.75 (4)	Offset Trapezoid	-	Y
	156.00	114.30		63.22	64.38	60.83	74.00	108.81				
HA590022	6.15	4.50	1/2-20 (5)	2.49	2.54	2.41	2.91	4.24	M12X1.75 (4)	Offset Trapezoid	-	Y
	156.20	114.30		63.26	64.62	61.13	73.96	107.58				
HA590023	7.25	5.50	M12x1.5 (6)	3.92	3.94	2.65	3.35	4.41	M12x1.75 (4)	Rectangle	27	Y
	184.16	139.70		99.50	100.01	67.23	84.97	112.06				
HA590024	6.15	4.50	1/2-20 (5)	2.49	2.80	1.64	3.60	4.57	M12x1.75 (3)	Modified Triangle	26	Y
	156.20	114.30		63.27	71.17	41.63	91.52	116.14				
HA590025	6.14	4.50	1/2-20 (5)	2.49	2.81	1.68	3.60	4.53	M12X1.75 (3)	Modified Triangle	26	Y
	156.00	114.30		63.32	71.46	42.76	91.50	115.06				
HA590026	5.83	4.50	1/2-20 (5)	2.78	2.84	-	3.15	-	-	-	-	N
	148.00	114.30		70.61	72.14	-	80.04	-				
HA590027	5.35	4.50	M12x1.25 (5)	2.60	2.68	1.61	3.31	4.21	M12x1.25 (4)	Rectangle	-	Y
	136.00	114.30		66.00	68.00	40.85	84.00	107.00				
HA590028	5.75	4.50	1/2-20 (5)	2.49	2.68	1.69	3.37	4.41	M12x1.75 (4)	Modified Rectangle	38	Y
	146.00	114.30		63.23	68.00	43.00	85.50	112.00				
HA590029	5.75	4.50	1/2-20 (5)	2.49	2.68	2.32	-	4.45	M12X1.75 (4)	Modified Trapezoid	38	Y
	146.00	114.30		63.23	68.00	58.90	-	113.00				
HA590030	5.90	4.53	M14x1.5 (5)	2.81	2.86	-	-	-	-	-	-	Y
	149.85	115.00		71.42	72.77	-	-	-				
HA590032	8.08	6.50	9/16-18 (8)	4.77	4.81	2.15	4.49	5.59	M14x1.5 (4)	Square	33	Y
	205.17	165.10		121.07	122.30	54.60	114.17	141.99				
HA590033	7.20	5.50	9/16x18 (5)	3.06	3.09	1.94	4.13	5.24	M14x1.5 (3)	Modified Triangle	33	Y
	183.00	139.70		77.66	78.37	49.15	105.00	133.00				
HA590034	7.21	5.50	9/16-18 (5)	3.06	3.09	1.94	4.13	5.31	M14x1.5 (3)	Modified Triangle	33	N
	183.00	139.70		77.67	78.38	49.35	105.02	134.88				
HA590035	7.21	5.50	9/16-18 (5)	3.06	3.09	1.93	4.14	5.30	M14x1.5 (3)	Modified Triangle	33	Y
	183.00	139.70		77.67	78.40	48.95	105.04	134.66				
HA590036	6.48	5.00	1/2-20 (5)	2.81	2.83	2.04	3.94	4.83	M12x1.75 (3)	Modified Triangle	29	Y
	164.67	127.00		71.41	71.96	51.90	100.12	122.79				
HA590038	5.47	4.25	M12x1.5 (5)	2.49	2.53	-	-	-	-	-	-	Y
	139.00	107.95		63.22	64.38	-	-	-				
HA590039	6.66	5.50	M12x1.5 (6)	2.63	3.70	2.43	3.59	4.63	M12x1.25 (4)	Modified Rectangle	33	N
	169.19	139.70		66.86	93.98	61.78	91.06	117.57				

*Denotes a Bearing Module

HUB UNIT BEARING / BEARING MODULE TECHNOLOGY

HUB UNIT BEARING / BEARING MODULE - NUMERICAL LISTING

continued

Timken Part No.	Flange Dia	Bolt Circle Dia	Bolt Size (Qty)	Wheel Pilot Dia	Brake Pilot Dia	Flange Offset	Hub Pilot Dia	Bolt Circle Dia	Bolt Hole Size (Qty)	Flange Shape	No. Of Spline	ABS (Y/N)
	A	B	C	D	E	F	G	H	I	J		
HA590040	5.32	3.94	M12x1.5 (5)	2.13	2.17	2.17	2.91	3.66	M10x1.25 (4)	Modified Trapezoid	-	Y
	135.00	100.00		54.00	55.00	54.50	74.00	93.00				
HA590041	5.50	4.50	M12x1.5 (5)	2.64	2.84	2.48	3.08	4.26	M14x1.5 (4)	Offset Trapezoid	-	Y
	139.78	114.30		67.00	72.00	62.94	78.10	108.28				
HA590043	5.83	4.50	M12x1.25 (4)	2.60	2.68	-	-	-	-	-	-	Y
	148.00	114.30		65.94	68.03	-	-	-				
HA590044	5.83	4.50	M12x1.25 (5)	2.60	2.68	2.72	3.31	4.21	M12x1.25 (4)	Rectangle	29	Y
	148.00	114.30		66.00	68.00	69.00	84.00	107.00				
HA590045	5.83	4.50	M12x1.25 (5)	2.60	2.68	2.72	3.31	4.21	M12x1.25 (4)	Modified Rectangle	-	Y
	148.00	114.30		66.00	68.00	69.00	84.00	107.00				
HA590046	5.35	4.50	M12x1.25 (5)	2.60	2.68	1.60	3.66	4.72	M12x1.25 (4)	Rectangle	29	Y
	136.00	114.30		65.95	68.12	40.72	92.98	119.88				
HA590047	5.83	4.50	M12x1.25 (4)	2.60	2.68	-	-	-	-	-	-	Y
	148.00	114.30		66.05	68.10	-	-	-				
HA590048	5.73	4.54	M12x1.5 (5)	2.76	2.78	1.66	3.59	4.62	M12x1.75 (3)	Modified Triangle	33	N
	145.50	115.25		70.23	70.61	42.10	91.19	117.36				
HA590049	5.73	4.53	M12x1.5 (5)	2.76	2.78	1.66	3.60	4.57	M12x1.75 (3)	Modified Triangle	30	Y
	145.50	115.00		70.10	70.60	42.06	91.42	116.00				
HA590050	*	-	-	-	-	-	3.94	5.51	12.8(2)-12(2) (4)	Trapezoid	-	Y
	-	-		-	-	-	100.00	140.00				
HA590052	5.82	4.50	M12x1.5 (5)	2.64	2.99	2.33	2.87	3.94	M10x1.75 (4)	Modified Rectangle	-	Y
	147.82	114.30		67.00	76.00	59.05	72.96	100.00				
HA590053	7.25	5.50	M12x1.5 (6)	3.91	3.93	2.65	3.35	4.44	M12x1.75 (4)	Rectangle	-	Y
	184.16	139.70		99.43	99.94	67.35	85.08	112.73				
HA590054	7.25	5.50	M12x1.5 (6)	3.92	3.94	2.65	3.35	4.45	M12x1.75 (4)	Rectangle	-	Y
	184.16	139.70		99.51	100.18	67.42	84.97	113.04				
HA590055	5.31	3.94	M12x1.5 (5)	2.13	2.17	2.15	2.91	3.73	M10x1.25 (4)	Offset Trapezoid	-	Y
	134.92	100.00		54.02	54.98	54.50	73.97	94.77				
HA590055K	5.39	4.25	M12x1.5 (5)	2.56	2.68	-	1.40	-	-	-	-	Y
	136.86	107.95		64.97	67.95	-	35.43	-				
HA590056	5.50	4.50	M12x1.5 (5)	2.64	2.84	2.48	3.07	4.27	M14x1.5 (4)	Offset Trapezoid	28	N
	139.76	114.30		67.00	72.00	62.95	78.00	108.44				
HA590056K	5.39	4.25	M12x1.5 (5)	2.56	2.68	-	-	-	-	-	-	Y
	136.86	107.95		64.97	67.95	-	-	-				
HA590057	6.00	4.50	M12x1.25 (5)	2.60	2.91	-	-	-	-	-	-	Y
	152.50	114.30		65.95	73.95	-	-	-				
HA590058	7.25	5.50	M12x1.5 (6)	3.92	3.94	2.65	3.35	4.43	M12x1.75 (4)	Rectangle	-	Y
	184.16	139.70		99.53	100.03	67.35	84.98	112.60				
HA590059	7.25	5.50	M12x1.5 (6)	3.92	3.94	2.64	3.35	4.42	M12x1.75 (4)	Rectangle	-	Y
	184.16	139.70		99.50	100.02	67.12	85.05	112.25				

*Denotes a Bearing Module

HUB UNIT BEARING / BEARING MODULE - NUMERICAL LISTING

continued

Timken Part No.	Flange Dia	Bolt Circle Dia	Bolt Size (Qty)	Wheel Pilot Dia	Brake Pilot Dia	Flange Offset	Hub Pilot Dia	Bolt Circle Dia	Bolt Hole Size (Qty)	Flange Shape	No. Of Spline	ABS (Y/N)
	A	B	C	D	E	F	G	H	I	J		
HA590060	7.25	5.50	M12x1.5 (6)	3.92	3.94	2.65	3.35	4.44	M12x1.75 (4)	Rectangle	27	Y
	184.16	139.70		99.52	100.08	67.40	85.02	112.73				
HA590061	7.25	5.50	M12x1.5 (6)	3.92	3.94	2.65	3.35	4.44	M12x1.75 (4)	Rectangle	-	Y
	184.16	139.70		99.56	100.13	67.30	84.99	112.70				
HA590062	7.25	5.50	M12x1.5 (6)	3.92	3.94	2.65	3.35	4.45	M12x1.75 (4)	Rectangle	-	Y
	184.16	139.70		99.53	100.09	67.26	85.02	113.04				
HA590063	5.32	3.94	M12x1.5 (4)	2.13	2.17	2.15	2.91	3.72	M10x1.25 (4)	Modified Trapezoid	-	Y
	135.00	100.00		54.02	55.02	54.60	73.94	94.40				
HA590064	4.92	3.94	M12x1.5 (5)	2.13	2.17	1.65	3.07	4.06	M10x1.25 (4)	Modified Trapezoid	26	N
	125.00	100.00		54.00	55.00	42.00	78.00	103.00				
HA590065	5.69	4.75	M12x1.5 (5)	2.76	2.78	1.85	3.62	4.75	M12x1.75 (3)	Modified Triangle	27	N
	144.50	120.65		70.10	70.60	47.00	91.98	120.65				
HA590066	5.51	3.94	M12x1.5 (4)	2.22	2.24	3.08	2.36	-	M10x1.5 (4)	Modified Trapezoid	-	Y
	140.00	100.00		56.49	56.96	78.35	60.00	-				
HA590067	5.51	3.94	M12x1.5 (4)	2.22	2.24	3.08	2.36	-	M10x1.5 (4)	Modified Trapezoid	-	N
	140.00	100.00		56.49	56.96	78.35	60.00	-				
HA590068	5.20	3.94	M12x1.5 (4)	2.22	2.36	1.53	3.35	4.33	M12x1.75 (3)	Modified Triangle	33	Y
	132.13	100.00		56.49	59.95	38.95	85.00	110.00				
HA590069	5.20	3.94	M12x1.5 (4)	2.22	2.36	1.53	3.35	4.33	M12x1.75 (3)	Modified Triangle	33	N
	132.13	100.00		56.49	59.95	38.95	85.00	110.00				
HA590070	5.39	4.33	M12x1.5 (5)	2.56	2.58	1.54	3.54	4.49	-	Modified Triangle	30	Y
	137.00	110.00		64.97	65.45	39.00	90.00	114.00				
HA590071	5.39	4.33	M12x1.5 (5)	2.56	2.58	1.54	3.54	4.49	M12x1.75 (3)	Modified Triangle	30	N
	137.00	110.00		64.97	65.45	39.00	90.00	114.00				
HA590072	5.43	4.50	M12x1.5 (5)	2.63	2.84	-	-	-	-	-	36	N
	138.00	114.30		66.92	72.01	-	-	-				
HA590074	5.93	4.53	M12x1.5 (5)	2.76	2.78	2.55	2.83	3.96	-	Rectangle	-	N
	150.50	115.00		70.10	70.60	64.76	71.76	100.60				
HA590077	5.73	4.53	M12x1.5 (6)	2.76	2.78	1.66	3.60	4.57	M12x1.75 (3)	Modified Triangle	-	Y
	145.50	115.00		70.10	70.60	42.06	91.42	116.00				
HA590078	5.73	4.53	M12x1.5 (6)	2.76	2.78	1.66	3.60	4.57	M12x1.75 (3)	Modified Triangle	30	Y
	145.50	115.00		70.10	70.60	42.06	91.42	116.00				
HA590079	5.73	4.53	M12x1.5 (6)	2.76	2.78	1.66	3.60	4.57	M12x1.75 (3)	Modified Triangle	30	Y
	145.50	115.00		70.10	70.60	42.06	91.42	116.00				
HA590080	5.51	4.33	M12x1.5 (5)	2.56	2.58	3.09	2.36	-	M10x1.5 (4)	Modified Trapezoid	-	Y
	140.00	110.00		64.97	65.45	78.50	60.00	-				
HA590081	5.51	4.33	M12x1.5 (5)	2.56	2.58	3.09	2.36	3.31	M10x1.5 (4)	Offset Trapezoid	-	N
	140.00	110.00		64.97	65.45	78.50	60.00	84.00				
HA590082	5.73	4.53	M12x1.5 (6)	2.76	2.78	1.66	3.60	4.57	M12x1.75 (3)	Modified Triangle	30	Y
	145.50	115.00		70.10	70.60	42.06	91.42	116.00				

*Denotes a Bearing Module

HUB UNIT BEARING / BEARING MODULE - NUMERICAL LISTING

continued

Timken Part No.	Flange Dia	Bolt Circle Dia	Bolt Size (Qty)	Wheel Pilot Dia	Brake Pilot Dia	Flange Offset	Hub Pilot Dia	Bolt Circle Dia	Bolt Hole Size (Qty)	Flange Shape	No. Of Spline	ABS (Y/N)
	A	B	C	D	E	F	G	H	I	J		
HA590083	5.73	4.75	M12x1.5 (5)	2.76	2.78	1.66	3.60	4.57	M12x1.75 (3)	Modified Triangle	-	Y
	145.50	120.65		70.10	70.60	42.06	91.42	116.00				
HA590084	5.73	4.75	M12x1.5 (5)	2.76	2.78	1.66	3.60	4.57	M12x1.75 (3)	Modified Triangle	30	Y
	145.50	120.65		70.10	70.60	42.06	91.42	116.00				
HA590085	5.73	4.53	M12x1.5 (5)	2.76	2.78	1.66	3.60	4.57	M12x1.75 (3)	Modified Triangle	33	N
	145.50	115.00		70.10	70.60	42.06	91.42	116.00				
HA590086	5.39	4.33	M12x1.5 (5)	2.56	2.58	1.53	3.35	4.33	M12x1.75 (3)	Modified Triangle	33	Y
	137.00	110.00		64.97	65.45	38.95	85.00	110.00				
HA590087	5.39	4.33	M12x1.5 (5)	2.56	2.58	1.53	3.35	4.33	M12x1.75 (3)	Modified Triangle	33	N
	137.00	110.00		64.97	65.45	38.95	85.00	110.00				
HA590088	5.51	4.33	M12x1.5 (5)	2.56	2.58	3.09	2.36	3.31	M10x1.5 (4)	Modified Trapezoid	-	Y
	140.00	110.00		64.97	65.45	78.36	60.00	84.05				
HA590089	5.51	4.33	M12x1.5 (5)	2.56	2.58	3.09	2.36	3.31	M10x1.5 (4)	Modified Trapezoid	-	N
	140.00	110.00		64.97	65.45	78.36	60.00	84.05				
HA590090	5.73	4.53	M12x1.5 (5)	2.76	2.78	1.66	3.60	4.57	M12x1.75 (3)	Modified Triangle	30	Y
	145.50	115.00		70.10	70.60	42.06	91.42	116.00				
HA590091	5.73	4.53	M12x1.5 (5)	2.76	2.78	1.66	3.60	4.57	M12x1.75 (3)	Modified Triangle	-	Y
	145.50	115.00		70.10	70.60	42.06	91.42	116.00				
HA590092	5.93	4.53	M12x1.5 (5)	2.76	2.78	2.55	2.83	3.96	0.46 11.69(4)	Rectangle	-	Y
	150.50	115.00		70.10	70.60	65.14	71.76	100.60				
HA590093	5.73	4.53	M12x1.5 (5)	2.76	2.78	1.66	3.59	4.57	M12x1.75 (3)	Modified Triangle	33	Y
	145.50	115.00		70.10	70.60	42.06	91.25	116.00				
HA590095	5.50	4.50	M12x1.5 (5)	2.64	2.84	-	-	-	-	-	-	N
	140.00	114.30		67.00	72.00	-	-	-				
HA590096	5.51	4.50	M12x1.5 (5)	2.64	2.84	2.15	2.91	3.75	M10x1.25 (4)	Modified Trapezoid	-	Y
	140.00	114.30		67.02	72.12	54.71	73.94	95.28				
HA590097	5.43	4.50	M12x1.5 (5)	2.64	2.83	-	-	-	-	-	36	Y
	138.00	114.30		67.08	71.97	-	-	-				
HA590098	5.59	4.53	M12x1.5 (5)	2.64	2.84	2.48	2.91	3.88	M10x1.25 (4)	Modified Trapezoid	-	N
	142.00	115.00		67.00	72.00	63.10	74.00	98.48				
HA590099	5.59	4.50	M12x1.5 (5)	2.64	2.84	2.48	2.91	3.82	M10x1.25 (4)	Modified Trapezoid	-	Y
	142.00	114.30		67.00	72.00	63.10	74.00	96.96				
HA590100	5.51	4.50	M12x1.5 (5)	2.64	2.84	-	-	-	-	-	-	Y
	140.00	114.30		67.00	72.00	-	-	-				
HA590101	5.43	4.50	M12x1.5 (4)	2.64	3.54	-	-	-	-	-	-	Y
	138.00	114.30		66.95	90.03	-	-	-				
HA590102	5.15	-	(4)	2.55	2.67	-	-	-	-	-	-	N
	130.71	-		64.85	67.84	-	-	-				
HA590103	5.41	4.50	M12x1.5 (5)	3.32	3.54	-	-	-	-	-	-	Y
	137.50	114.30		67.00	90.00	-	-	-				

*Denotes a Bearing Module

HUB UNIT BEARING / BEARING MODULE - NUMERICAL LISTING

continued

Timken Part No.	Flange Dia	Bolt Circle Dia	Bolt Size (Qty)	Wheel Pilot Dia	Brake Pilot Dia	Flange Offset	Hub Pilot Dia	Bolt Circle Dia	Bolt Hole Size (Qty)	Flange Shape	No. Of Spline	ABS (Y/N)
	A	B	C	D	E	F	G	H	I	J		
HA590104	4.84	3.94	M12x1.5 (4)	2.21	2.52	-	-	-	-	-	-	Y
	123.00	100.00		56.00	64.00	-	-	-				
HA590106	5.39	4.48	M14x1.5 (5)	2.24	2.56	1.89	3.35	4.22	M12x1.5 (4)	Modified Rectangle	36	Y
	136.83	113.83		57.00	65.00	48.00	85.00	107.27				
HA590107	5.39	4.50	M12x1.5 (5)	2.64	3.54	2.35	2.60	3.56	M10x1.25 (4)	Modified Trapezoid	-	Y
	137.00	114.30		66.94	89.99	59.70	66.03	90.30				
HA590108	5.59	4.50	M12x1.5 (5)	2.64	2.72	1.60	3.43	4.42	M12x1.25 (4)	Modified Rectangle	27	N
	142.00	114.30		67.00	69.00	40.60	87.00	112.30				
HA590109	5.83	4.50	M12x1.25 (5)	2.60	2.68	2.72	3.31	4.21	M12x1.25 (4)	Rectangle	-	Y
	148.00	114.30		66.00	68.00	69.00	84.00	107.00				
HA590110	5.83	4.50	0.52 13.20(4)	2.60	2.68	-	-	-	-	-	-	N
	148.00	114.30		66.01	67.96	-	-	-				
HA590111	5.83	4.50	M12x1.25 (5)	2.60	2.68	2.72	3.35	4.21	M12x1.25 (4)	Modified Trapezoid	-	Y
	148.00	114.30		66.00	68.00	69.00	85.20	107.00				
HA590112	5.47	4.50	M12x1.5 (4)	2.22	2.36	2.48	2.59	3.39	M10x1.25 (4)	Modified Trapezoid	-	Y
	139.00	114.30		56.46	59.94	62.98	65.85	86.22				
HA590113	5.47	4.50	M12x1.5 (4)	2.22	2.36	2.48	2.59	3.45	M10x1.25 (4)	Modified Trapezoid	-	N
	139.00	114.30		56.50	59.96	63.05	65.82	87.58				
HA590114	5.47	4.50	M12x1.5 (4)	2.22	2.36	2.51	2.60	3.45	M10x1.25 (4)	Modified Trapezoid	-	N
	139.00	114.30		56.47	59.97	63.70	65.92	87.52				
HA590115	5.47	4.50	M12x1.5 (4)	2.23	2.36	1.46	3.59	4.50	M12x1.5 (3)	Modified Triangle	28	Y
	139.00	114.30		56.58	60.03	37.05	91.29	114.25				
HA590116	5.93	4.53	M12x1.5 (6)	2.76	2.78	2.56	2.83	3.97	-	Rectangle	-	Y
	150.59	115.02		70.00	70.61	65.00	71.80	100.70				
HA590118	4.88	3.94	M12x1.25 (5)	2.22	2.28	1.93	2.99	-	M12x1.25 (4)	Modified Trapezoid	27	Y
	124.05	100.00		56.32	58.02	49.08	75.93	-				
HA590119	4.88	3.93	M12x1.25 (5)	2.21	2.28	2.58	3.31	4.21	M12x1.25 (4)	Rectangle	25	Y
	124.05	99.93		56.03	57.98	65.60	83.98	106.88				
HA590120	5.43	4.50	M12x1.5 (5)	2.64	2.72	2.33	3.47	4.41	M12x1.25 (4)	Modified Trapezoid	25	N
	138.00	114.30		67.00	69.00	59.20	88.00	112.00				
HA590122	5.58	4.50	M12x1.25 (5)	2.59	2.67	-	-	-	-	-	-	Y
	141.73	114.30		65.90	67.94	-	-	-				
HA590123	5.83	4.50	M12x1.25 (4)	2.60	2.68	-	-	-	-	-	-	Y
	148.00	114.30		65.93	67.95	-	-	-				
HA590124	5.35	4.50	M12x1.25 (5)	2.60	2.67	1.61	3.66	4.71	M12x1.25 (4)	Rectangle	-	Y
	136.00	114.30		65.95	67.92	40.77	92.97	119.58				
HA590125	5.35	4.50	M12x1.25 (5)	2.60	2.68	1.60	3.66	4.72	M12x1.25 (4)	Rectangle	27	Y
	136.00	114.30		65.96	67.95	40.65	92.96	119.85				
HA590126	5.51	4.50	M12x1.25 (5)	2.59	2.68	-	-	-	-	-	-	Y
	140.00	114.30		65.89	67.95	-	-	-				

*Denotes a Bearing Module

HUB UNIT BEARING / BEARING MODULE TECHNOLOGY

HUB UNIT BEARING / BEARING MODULE - NUMERICAL LISTING

continued

Timken Part No.	Flange Dia	Bolt Circle Dia	Bolt Size (Qty)	Wheel Pilot Dia	Brake Pilot Dia	Flange Offset	Hub Pilot Dia	Bolt Circle Dia	Bolt Hole Size (Qty)	Flange Shape	No. Of Spline	ABS (Y/N)
	A	B	C	D	E	F	G	H	I	J		
HA590127	5.35	4.50	M12x1.25 (5)	2.60	2.68	1.60	3.31	4.21	M12x1.25 (4)	Modified Trapezoid	-	Y
	136.00	114.30		66.00	68.00	40.75	84.00	107.00				
HA590128	5.43	4.50	M12x1.5 (5)	2.67	2.72	2.32	2.56	3.54	M10x1.25 (4)	Modified Trapezoid	-	Y
	138.00	114.30		67.00	69.00	59.00	65.00	90.00				
HA590129	5.43	4.50	M12x1.5 (5)	2.64	2.72	2.32	-	-	M10x1.25 (4)	Modified Rectangle	-	N
	138.00	114.30		67.00	69.00	59.00	-	-				
HA590131	5.48	4.50	M12x1.5 (4)	2.22	2.36	1.46	3.57	4.50	M12x1.5 (3)	Triangle	28	N
	139.08	114.30		56.50	59.95	37.18	90.67	114.30				
HA590132	7.99	6.69	M14x2 (8)	4.92	5.08	2.03	4.48	5.51	M14x1.5 (4)	Square	55	N
	203.00	170.00		124.97	129.01	51.50	113.90	140.00				
HA590136	6.07	4.50	M12x1.5 (5)	2.36	2.44	2.66	3.31	4.38	M12x1.25 (4)	Modified Trapezoid	30	Y
	154.24	114.23		60.04	61.98	67.43	83.97	111.34				
HA590137	5.51	4.51	M12x1.5 (5)	2.36	2.44	2.17	2.91	4.46	M12x1.25 (4)	Modified Trapezoid	-	Y
	139.87	114.50		60.01	61.99	55.00	73.90	113.40				
HA590138	5.51	4.51	M12x1.5 (5)	2.36	2.44	2.17	2.91	4.46	M12x1.25 (4)	Modified Trapezoid	-	Y
	139.97	114.60		60.03	61.98	55.10	73.92	113.28				
HA590139	5.51	4.50	M12x1.5 (5)	2.36	2.44	1.97	3.54	5.20	M12x1.25 (4)	Modified Trapezoid	30	Y
	140.00	114.19		60.00	62.00	50.00	90.00	132.00				
HA590140	5.51	4.50	M12x1.5 (5)	2.36	2.44	1.97	3.54	6.06	M12x1.25 (4)	Modified Trapezoid	30	Y
	140.00	114.30		60.00	62.00	50.00	90.00	154.00				
HA590142	5.91	4.53	M14x1.5 (5)	2.81	2.85	2.37	3.56	4.33	M10x1.5 (4)	Modified Rectangle	27	N
	150.00	115.00		71.40	72.50	60.30	90.40	110.00				
HA590143	5.43	4.50	M12x1.5 (5)	2.64	2.72	2.33	3.47	4.41	M12x1.25 (4)	Modified Trapezoid	-	Y
	138.00	114.30		67.00	59.00	59.20	88.00	112.00				
HA590144	5.43	4.50	M12x1.5 (5)	2.64	2.72	2.33	3.47	4.41	M12x1.25 (4)	Modified Trapezoid	-	N
	138.00	114.30		67.00	69.00	59.20	88.00	112.00				
HA590145	6.66	5.50	M12x1.5 (6)	2.64	3.70	1.48	3.39	4.39	M12x1.25 (4)	Modified Square	30	N
	169.24	139.78		67.00	94.00	37.53	86.00	111.55				
HA590146	6.00	4.72	M14x1.5 (5)	2.52	2.76	2.40	3.21	4.29	M12x1.25 (4)	Modified Rectangle	28	Y
	152.50	120.00		64.00	70.00	60.90	81.60	109.00				
HA590147	6.00	4.72	M14x1.5 (5)	2.52	2.76	1.87	3.59	5.08	M12x1.25 (4)	Offset Trapezoid	30	Y
	152.50	120.00		64.00	70.00	47.50	91.10	129.00				
HA590149	5.93	4.52	M12x1.5 (5)	2.76	2.78	2.56	2.83	3.96	-	Rectangle	-	Y
	150.73	114.80		70.00	70.60	65.00	71.75	100.56				
HA590150	5.43	4.50	M12x1.25 (5)	2.21	2.28	1.83	3.31	-	M12x1.25 (4)	Offset Trapezoid	27	Y
	138.00	114.30		56.00	58.00	46.50	84.00	-				
HA590151	6.30	4.72	M14x1.5 (5)	2.52	2.76	2.45	3.47	4.41	M12x1.25 (4)	Modified Rectangle	-	N
	160.00	120.00		64.00	70.00	62.20	88.00	112.00				
HA590152	5.49	4.50	M12x1.5 (5)	2.52	2.52	2.17	2.76	3.40	M10x1.25 (4)	Modified Rectangle	-	Y
	139.50	114.30		64.00	64.00	55.10	70.00	100.00				

*Denotes a Bearing Module

HUB UNIT BEARING / BEARING MODULE TECHNOLOGY

HUB UNIT BEARING / BEARING MODULE - NUMERICAL LISTING

continued

Timken Part No.	Flange Dia	Bolt Circle Dia	Bolt Size (Qty)	Wheel Pilot Dia	Brake Pilot Dia	Flange Offset	Hub Pilot Dia	Bolt Circle Dia	Bolt Hole Size (Qty)	Flange Shape	No. Of Spline	ABS (Y/N)
	A	B	C	D	E	F	G	H	I	J		
HA590153	5.83	4.50	M12X1.5 (5)	2.60	2.68	-	2.64	-	-	-	-	Y
	148.00	114.30		66.00	68.00	-	67.00	-				
HA590154	5.83	4.50	M12X1.25 (5)	2.60	2.68	-	2.64	-	-	-	-	N
	148.00	114.30		66.00	68.00	-	67.00	-				
HA590155K	5.43	3.94	M12x1.5 (4)	2.24	2.35	-	1.54	-	-	-	31	N
	137.87	100.00		56.90	59.69	-	39.07	-				
HA590156	6.30	4.50	1/2-20 (5)	2.77	3.23	1.92	3.35	4.45	(3)	Triangle	27	Y
	160.00	114.30		70.45	82.00	48.80	85.00	113.00				
HA590156K	5.43	3.94	M12x1.5 (4)	2.24	2.35	-	1.54	-	-	-	33	N
	137.92	100.00		56.99	59.74	-	39.00	-				
HA590158	5.73	4.50	M12X1.5 (6)	2.76	2.78	1.65	3.59	4.63	M12X1.75 (3)	Modified Triangle	-	Y
	145.42	114.34		70.02	70.54	42.00	91.28	117.48				
HA590159	-	-	-	-	-	-	-	4.46	M14X1.5 (5)	Circle	-	Y
	-	-	-	-	-	-	-	113.20				
HA590160	5.12	3.94	M12X1.25mm (4)	2.13	2.28	-	-	-	-	-	-	N
	130.00	100.00		54.00	58.00	-	-	-				
HA590161	5.41	3.94	M12X1.5 (4)	2.21	2.52	2.22	2.91	3.70	M10X1.5 (4)	Modified Square	-	Y
	137.29	100.00		56.00	64.00	56.47	74.00	94.00				
HA590162	5.79	4.75	M12X1.5 (5)	2.85	3.11	2.01	3.54	4.16	M12X1.5 (4)	Modified Square	-	N
	146.98	120.58		72.48	79.02	51.08	89.94	105.77				
HA590163	5.63	4.74	- (5)	2.86	3.11	2.00	3.54	4.16	M12X1.5 (4)	Modified Square	-	Y
	143.00	120.32		72.54	79.00	50.86	90.00	105.76				
HA590164	5.49	4.50	M12X1.5 (5)	2.52	2.52	2.17	2.76	3.94	M10X1.25 (4)	Modified Rectangle	-	Y
	139.50	114.30		64.00	64.00	55.10	70.00	100.00				
HA590165	5.47	4.50	M12X1.5 (5)	2.36	2.44	1.87	3.54	4.56	M12X1.25 (4)	Modified Trapezoid	26	Y
	139.00	114.30		60.00	62.00	47.50	90.00	115.72				
HA590166	8.07	6.49	9/16-18 (8)	4.76	4.80	2.16	4.48	5.53	M14X1.5 (4)	Modified Square	33	Y
	205.00	164.78		121.00	122.00	54.85	113.83	140.49				
HA590167	5.72	4.54	M12X1.5 (6)	2.75	2.78	1.67	3.59	4.66	M12X1.75 (3)	Modified Triangle	30	Y
	145.18	115.26		70.18	70.70	42.30	91.30	118.46				
HA590168	5.47	4.50	M12X1.5 (5)	2.36	2.44	1.87	3.54	4.56	M12X1.25 (4)	Modified Trapezoid	30	Y
	138.87	114.30		60.00	62.00	47.48	90.00	115.89				
HA590169	5.43	4.50	M12X1.25 (5)	2.21	2.28	2.50	3.31	4.33	M12X1.25 (4)	Modified Rectangle	27	Y
	138.00	114.30		56.00	58.00	63.45	84.00	110.00				
HA590170	5.32	3.94	M12X1.5 (4)	2.13	2.17	-	2.91	3.80	0.489 12.43(4)	Modified Trapezoid	-	Y
	135.00	100.00		54.00	55.00	-	74.00	96.50				
HA590171	5.83	4.50	M12X1.25 (5)	2.60	2.68	2.68	3.31	4.23	M12X1.25 (4)	Modified Rectangle	32	N
	148.00	114.30		66.00	68.00	69.17	84.00	107.38				
HA590172	5.32	3.94	M12X1.5 (4)	2.13	2.17	2.36	2.91	3.84	0.489 12.42(4)	Modified Trapezoid	-	N
	135.00	100.00		54.00	55.00	60.00	74.00	97.66				

*Denotes a Bearing Module

HUB UNIT BEARING / BEARING MODULE TECHNOLOGY

HUB UNIT BEARING / BEARING MODULE - NUMERICAL LISTING

continued

Timken Part No.	Flange Dia	Bolt Circle Dia	Bolt Size (Qty)	Wheel Pilot Dia	Brake Pilot Dia	Flange Offset	Hub Pilot Dia	Bolt Circle Dia	Bolt Hole Size (Qty)	Flange Shape	No. Of Spline	ABS (Y/N)
	A	B	C	D	E	F	G	H	I	J		
HA590173	5.98	4.46	M12X1.5 (5)	2.36	2.44	2.36	2.99	3.87	M12X1.25 (4)	Offset Trapezoid	-	Y
	151.90	113.20		60.03	62.02	59.96	75.87	98.20				
HA590174	5.35	4.25	M12X1.5 (5)	2.49	2.50	2.48	3.27	4.50	0.43 10.8(4)	Modified Trapezoid	26	N
	136.00	108.00		63.24	63.49	63.00	83.00	114.30				
HA590175	2.58	2.68	M12X1.25 (5)	2.60	2.64	1.15	3.31	4.21	M12X1.25 (4)	Modified Rectangle	29	N
	147.58	68.00		66.00	67.00	29.21	84.00	107.00				
HA590176	5.35	4.50	M12X1.25 (5)	2.60	2.68	1.61	3.66	4.72	M12X1.25 (4)	Modified Rectangle	-	Y
	136.00	114.30		66.00	68.00	41.00	93.00	120.00				
HA590177	5.59	4.50	M12X1.5 (5)	2.64	2.72	1.61	3.43	4.41	M12X1.25 (4)	Modified Rectangle	27	N
	142.00	114.30		67.00	69.00	41.00	87.00	112.00				
HA590178	5.67	4.50	M12X1.25 (5)		2.44	2.11	3.31	4.32	M10X1.25 (4)	Modified Rectangle	28	Y
	144.00	114.30			62.00	53.50	84.00	109.80				
HA590179	5.83	4.50	M12X1.5 (5)	2.64	2.99	2.32	2.95	3.94	M10X1.25 (4)	Modified Rectangle	-	Y
	148.00	114.30		67.00	76.00	59.00	73.00	100.00				
HA590180	5.51	4.50	1/2-20 (5)	2.78	2.84	2.48	3.07	4.23	M14X2 (4)	Modified Trapezoid	-	Y
	140.00	114.30		70.62	72.00	63.00	78.00	107.35				
HA590181K	4.95	3.94	M12x1.5 (4)	2.24	2.40	-	-	-	-	-	23	N
	125.80	100.00		56.90	60.90	-	-	-				
HA590182K	4.95	3.94	M12x1.5 (5)	2.24	2.40	-	-	-	-	-	23	N
	125.80	100.00		56.90	60.90	-	-	-				
HA590183	5.50	4.50	1/2-20 (5)	2.77	2.84	2.48	3.07	4.22	M14X2 (4)	Modified Trapezoid	28	N
	139.73	114.30		70.47	72.00	63.00	78.00	107.30				
HA590184	5.51	3.94	M12X1.5 (4)	2.13	2.46	2.28	2.64	3.62	- (4)	Modified Rectangle	-	N
	140.00	100.00		54.00	62.50	58.00	67.00	92.00				
HA590185	5.40	4.33	M12X1.5 (5)	2.56	2.76	1.54	3.54	4.64	M12X1.75 (3)	Modified Triangle	30	N
	137.11	110.00		65.00	70.00	39.00	90.00	117.80				
HA590186	5.39	4.33	M12X1.5 (5)	2.56	2.76	1.54	3.54	4.57	M12X1.75 (3)	Modified Triangle	30	Y
	137.00	110.00		65.00	70.00	39.00	90.00	116.00				
HA590187	5.34	4.26	M14X1.5 (5)	2.56	2.68	1.69	3.44	4.44	M12X1.75 (4)	Modified Rectangle	36	N
	135.62	108.11		65.00	68.00	43.00	87.41	112.68				
HA590188	5.47	4.50	M12X1.5 (4)	2.64	2.99	1.99	2.91	-	-	-	-	N
	139.00	114.30		67.00	76.00	50.50	74.00	-				
HA590190	5.98	4.50	M12X1.5 (5)	2.52	3.20	2.42	3.22	4.11	M12X1.5 (4)	Modified Square	-	Y
	151.81	114.30		64.00	81.30	61.42	81.84	104.28				
HA590192	5.35	4.24	M12X1.5 (5)	2.50	2.49	2.48	2.91	3.86	M10X1.5 (4)	Modified Square	-	Y
	136.00	107.72		63.49	63.23	63.00	74.00	98.00				
HA590193	5.51	4.50	-	2.64	2.84	2.48	3.07	4.17	M12X1.25 (4)	Offset Trapezoid	-	N
	140.00	114.30		67.00	72.00	63.00	78.00	106.00				
HA590194	5.47	4.50	M12X1.5 (4)	2.64	2.99	-	-	-	-	-	-	Y
	139.00	114.30		67.00	76.00	-	-	-				

*Denotes a Bearing Module

HUB UNIT BEARING / BEARING MODULE - NUMERICAL LISTING

continued

Timken Part No.	Flange Dia	Bolt Circle Dia	Bolt Size (Qty)	Wheel Pilot Dia	Brake Pilot Dia	Flange Offset	Hub Pilot Dia	Bolt Circle Dia	Bolt Hole Size (Qty)	Flange Shape	No. Of Spline	ABS (Y/N)
	A	B	C	D	E	F	G	H	I	J		
HA590195	5.51	4.50	-	2.64	2.84	2.48	3.07	4.17	M12X1.25 (4)	Offset Trapezoid	-	Y
	140.00	114.30	(5)	67.00	72.00	63.00	78.00	106.00				
HA590197	5.50	4.50	M12X1.5 (5)	2.81	2.89	1.48	3.43	4.41	-	Modified Rectangle	26	N
	139.70	114.30		71.37	73.28	37.47	87.00	112.01				
HA590198	5.37	4.44	M14X1.5 (5)	2.24	2.56	1.89	3.15	4.10	M12X1.5 (3)	Triangle	36	Y
	136.36	112.69		57.00	65.00	48.00	80.00	104.22				
HA590199	5.50	4.50	M12X1.5 (5)	2.64	3.20	2.15	2.91	3.70	M10X1.5 (4)	Modified Trapezoid	-	N
	139.81	114.30		67.00	81.30	54.50	74.00	94.00				
HA590200	5.51	4.50	M12X1.5 (5)	2.64	2.99	-	-	-	-	-	-	Y
	140.00	114.30		67.00	76.00	-	-	-				
HA590201	5.98	4.50	M12X1.5 (5)	2.36	2.44	2.36	2.99	3.87	M12X1.25 (4)	Offset Trapezoid	26	Y
	152.00	114.30		60.00	62.00	60.00	76.00	98.23				
HA590202	5.49	4.50	M12X1.5 (5)	2.52	2.52	2.33	2.84	4.00	M12X1.25 (4)	Modified Square	-	Y
	139.50	114.30		64.00	64.00	58.80	72.00	101.60				
HA590203	8.08	6.50	9/16-18 (8)	4.82	4.81	2.14	4.49	5.50	M14X1.5 (4)	Modified Rectangle	33	Y
	205.18	165.10		121.00	122.18	54.33	114.00	139.70				
HA590204	5.98	4.50	M12X1.5 (5)	2.52	2.52	2.42	3.23	4.12	M12X1.25 (4)	Modified Square	28	Y
	152.00	114.30		64.00	64.00	61.40	82.00	104.65				
HA590205	5.51	4.50	M12X1.5 (5)	2.64	2.84	2.15	2.91	3.71	M10X1.25 (4)	Modified Trapezoid	-	Y
	140.00	114.30		67.00	72.00	54.48	74.00	94.30				
HA590206	6.35	5.51	M12X1.5 (6)	3.63	3.79	1.91	3.50	4.85	M14X1.5 (3)	Modified Triangle	31	N
	161.32	139.85		92.21	96.30	48.40	89.00	123.14				
HA590207	5.35	4.26	M12X1.5 (5)	2.49	2.50	2.49	2.91	7.78	M10X1.5 (4)	Modified Square	-	Y
	136.00	108.13		63.14	63.42	63.14	74.00	97.67				
HA590208	6.59	5.00	M12X1.5 (5)	2.81	3.22	1.91	3.35	4.33	M10X1.5 (4)	Modified Rectangle	-	Y
	167.45	127.00		71.43	81.90	48.60	85.00	110.00				
HA590209	6.59	5.00	M12X1.5 (5)	2.81	3.22	1.91	3.35	4.33	M10X1.5 (4)	Rectangle	-	Y
	157.45	127.00		71.43	81.90	48.60	85.00	110.00				
HA590212	5.17	4.25	M12X1.5 (5)	2.49	2.50	-	-	-	-	-	36	Y
	131.34	107.00		63.15	63.48	-	-	-				
HA590214	5.56	4.50	M12X1.5 (5)	2.64	2.72	1.92	3.35	4.33	M10X1.5 (4)	Modified Trapezoid	32	N
	141.33	114.30		67.00	69.00	48.63	85.00	110.00				
HA590216	5.51	4.50	M12X1.5 (5)	2.64	3.15	2.39	2.91	3.89	M12X1.25 (4)	Modified Rectangle	-	Y
	140.00	114.30		67.00	80.00	60.60	74.00	98.83				
HA590217	6.59	5.00	M12X1.5 (5)	2.81	3.22	1.91	3.35	4.33	M10X1.5 (4)	Modified Rectangle	32	Y
	167.45	127.00		71.43	81.90	48.50	85.00	110.00				
HA590218	5.34	4.26	M14X1.5 (5)	2.64	2.68	2.33	3.44	4.50	M12X1.75 (4)	Offset Trapezoid	34	Y
	135.72	108.19		67.00	68.00	59.18	87.41	114.30				
HA590219	5.56	4.50	M12X1.5 (5)	2.64	2.72	1.92	3.35	4.33	M10X1.5 (4)	Modified Rectangle	32	Y
	141.30	114.30		67.00	69.00	48.67	85.00	110.00				

*Denotes a Bearing Module

HUB UNIT BEARING / BEARING MODULE TECHNOLOGY

HUB UNIT BEARING / BEARING MODULE - NUMERICAL LISTING

continued

Timken Part No.	Flange Dia	Bolt Circle Dia	Bolt Size (Qty)	Wheel Pilot Dia	Brake Pilot Dia	Flange Offset	Hub Pilot Dia	Bolt Circle Dia	Bolt Hole Size (Qty)	Flange Shape	No. Of Spline	ABS (Y/N)
	A	B	C	D	E	F	G	H	I	J		
HA590220	5.35	4.21	M14X1.5 (5)	2.49	2.50	2.48	3.20	4.40	M12X1.5 (4)	Modified Rectangle	36	N
	136.00	107.00		63.23	63.49	63.00	81.38	111.63				
HA590221	5.51	4.50	M12X1.5 (5)	2.64	3.15	2.39	2.91	3.90	M12X1.25 (4)	Modified Rectangle	-	N
	140.00	114.30		67.00	80.00	60.60	74.00	99.00				
HA590222	5.35	4.25	M14X1.5 (5)	2.49	2.50	2.52	3.20	4.41	M12X1.5 (4)	Modified Rectangle	-	Y
	136.00	108.00		63.24	63.48	64.00	81.34	111.88				
HA590223	5.34	4.26	M14X1.5 (5)	2.64	2.68	1.70	3.54	4.40	M12X1.75 (4)	Modified Rectangle	36	N
	135.72	108.17		67.00	68.00	43.15	90.00	111.77				
HA590226	5.35	4.50	M12X1.25 (5)	2.68	2.60	1.60	3.66	4.74	M12X1.25 (4)	Modified Rectangle	27	Y
	136.00	114.30		68.00	66.00	40.68	93.00	120.37				
HA590227	6.65	5.20	M14X1.5 (6)	2.93	2.97	1.86	3.74	4.76	M12X1.75 (3)	Modified Triangle	33	Y
	168.83	132.00		74.34	75.55	47.15	95.00	120.82				
HA590228	5.98	4.72	M14X1.5 (5)	2.52	2.76	1.86	3.50	4.92	M12X1.25 (4)	Modified Rectangle	30	Y
	152.00	120.00		64.00	70.00	47.20	88.80	124.96				
HA590229	6.30	4.72	M12X1.25 (5)	2.52	2.76	2.45	3.51	4.41	M12X1.25 (4)	Modified Rectangle	28	Y
	160.00	120.00		64.00	70.00	62.20	89.20	112.00				
HA590230	5.51	4.50	M12X1.5 (5)	2.64	3.15	2.39	2.91	3.90	M12X1.25 (4)	Modified Rectangle	25	Y
	140.00	114.30		67.00	80.00	60.60	74.00	99.00				
HA590232	5.35	4.23	M14X1.5 (5)	2.64	2.68	2.32	3.44	4.47	M12X1.75 (4)	Modified Trapezoid	36	Y
	135.76	107.42		67.00	68.00	58.80	87.44	113.51				
HA590233	7.99	6.69	M14X2 (8)	4.91	5.08	2.17	4.49	5.50	M14X1.5 (4)	Modified Square	-	Y
	203.00	169.80		124.82	129.00	55.14	114.00	139.78				
HA590234	5.37	4.24	M14X1.5 (5)	2.49	2.50	-	-	-	-	-	40	Y
	136.46	107.69		63.30	63.46	-	-	-				
HA590235	5.78	4.50	M12X1.25 (5)	2.60	2.68	2.72	3.31	4.21	M12X1.25 (4)	Modified Rectangle	25	N
	146.81	114.30		66.00	68.00	69.00	84.00	107.00				
HA590236	5.35	4.50	M12X1.25 (5)	2.60	2.68	1.60	3.66	4.72	M12X1.25 (4)	Modified Rectangle	32	Y
	136.00	114.30		66.00	68.00	40.68	93.00	120.00				
HA590237	5.83	4.50	M12X1.25 (5)	2.60	2.68	2.72	3.31	4.21	M12X1.25 (4)	Modified Rectangle	-	Y
	148.00	114.30		66.00	68.00	69.00	84.00	107.00				
HA590238	5.83	4.50	M12X1.25 (5)	2.60	2.68	2.72	3.31	4.25	M12X1.25 (4)	Modified Rectangle	29	Y
	148.00	114.30		66.00	68.00	69.00	84.00	106.84				
HA590239	5.35	4.50	M12X1.25 (5)	2.60	2.68	1.60	3.15	4.06	M12X1.25 (4)	Modified Rectangle	29	Y
	136.00	114.30		66.00	68.00	40.66	80.00	103.00				
HA590240	5.63	4.50	M12X1.5 (4)	2.63	2.71	1.60	3.31	4.17	M12X1.25 (4)	Modified Rectangle	25	N
	143.00	114.30		66.80	68.88	40.59	84.00	106.00				
HA590241	5.83	4.50	M12X1.25 (5)	2.60	2.68	2.72	3.31	4.21	M12X1.25 (4)	Modified Rectangle	-	Y
	148.00	114.30		66.00	68.00	69.00	84.00	107.00				
HA590241K	5.35	4.04	-	2.55	2.69	-	2.93	-	-	-	-	Y
	135.79	102.45		(5)	64.80	68.38	-	74.42				

*Denotes a Bearing Module

HUB UNIT BEARING / BEARING MODULE - NUMERICAL LISTING

continued

Timken Part No.	Flange Dia	Bolt Circle Dia	Bolt Size (Qty)	Wheel Pilot Dia	Brake Pilot Dia	Flange Offset	Hub Pilot Dia	Bolt Circle Dia	Bolt Hole Size (Qty)	Flange Shape	No. Of Spline	ABS (Y/N)
	A	B	C	D	E	F	G	H	I	J		
HA590242	6.36	4.98	1/2-20 (5)	2.81	2.80	1.91	3.94	4.81	M12X1.75 (4)	Modified Triangle	32	Y
	161.52	126.48		71.45	71.00	48.56	100.15	122.15				
HA590243	6.37	5.00	M12X1.5 (5)	2.81	2.85	1.92	3.35	4.34	M10X1.5 (4)	Modified Rectangle	32	Y
	161.74	127.00		71.41	72.44	48.68	85.00	110.20				
HA590244	7.21	5.50	9/16-18 (5)	3.06	3.09	1.92	4.15	5.25	M14X1.5 (3)	Modified Triangle	33	Y
	183.00	139.68		77.74	78.40	48.69	105.36	133.28				
HA590245	6.08	4.50	1/2-20 (5)	2.81	2.84	1.91	3.62	4.77	M12X1.5 (3)	Modified Triangle	33	Y
	154.36	114.30		71.40	72.00	48.60	92.00	121.10				
HA590247	5.53	4.50	M12X1.5 (5)	2.64	3.20	2.33	2.28	4.39	M12X1.25 (4)	Modified Rectangle	-	Y
	140.52	114.30		67.00	81.30	59.13	58.00	111.54				
HA590248	5.47	4.75	M12x2 (5)	2.80	2.89	1.48	3.43	4.25	-	(4) Rectangle	26	N
	139.00	120.65		71.12	73.41	37.59	87.00	107.95				
HA590249	5.53	4.50	M12X1.5 (5)	2.21	3.15	2.33	3.47	4.41	M12X1.25 (4)	Modified Rectangle	27	Y
	140.51	114.30		56.00	80.00	59.14	88.00	112.00				
HA590250	5.35	4.50	M12X1.25 (5)	2.60	2.68	1.60	3.66	4.72	M12X1.25 (4)	Modified Rectangle	29	Y
	136.00	114.30		66.00	68.00	40.70	93.00	120.00				
HA590251	5.35	4.50	M12X1.25 (5)	2.60	2.68	1.60	3.66	4.72	M12X1.25 (4)	Rectangle	29	N
	136.00	114.30		66.00	68.00	40.70	93.00	120.00				
HA590252	5.35	4.50	M12X1.25 (5)	2.60	2.68	1.60	3.66	4.72	M12X1.25 (4)	Modified Rectangle	32	Y
	136.00	114.30		66.00	68.00	40.70	93.00	120.00				
HA590253	5.83	4.50	M12X1.5 (5)	2.60	2.68	2.72	3.31	4.21	M12X1.25 (4)	Modified Rectangle	-	Y
	148.00	114.30		66.00	68.00	69.00	84.00	107.00				
HA590254	5.83	4.50	M12X1.5 (5)	2.60	2.68	2.72	3.31	4.21	M12X1.25 (4)	Modified Rectangle	-	Y
	148.00	114.30		66.00	68.00	69.00	84.00	107.00				
HA590255	5.73	4.50	M12X1.25 (5)	2.60	2.68	2.72	3.70	4.20	M12X1.25 (4)	Modified Rectangle	32	N
	145.56	114.30		66.00	68.00	69.00	94.00	106.65				
HA590256	5.53	4.50	M12X1.5 (5)	2.64	3.15	2.39	2.91	3.88	M12X1.25 (4)	Modified Rectangle	-	Y
	140.55	114.30		67.00	80.00	60.58	74.00	98.55				
HA590257	5.52	3.14	M12X1.5 (4)	2.64	2.72	-	2.75	-	-	-	-	N
	140.18	79.87		66.99	69.00	-	69.81	-				
HA590258	5.53	4.50	M12X1.5 (5)	2.64	3.15	2.39	2.91	3.88	M12X1.25 (4)	Modified Rectangle	25	Y
	140.52	114.30		67.00	80.00	60.58	74.00	98.56				
HA590259K	6.30	4.49	1/2-20 (5)	2.77	3.22	-	-	-	-	-	-	N
	160.00	114.00		70.47	81.90	-	-	-				
HA590260	6.18	4.73	M14X1.5 (5)	2.63	2.65	1.65	3.59	4.63	M12X1.75 (3)	Modified Triangle	30	Y
	157.00	120.11		66.82	67.32	41.94	91.24	117.52				
HA590261	5.74	4.50	1/2-20 (5)	2.49	2.28	1.69	3.63	4.71	M12X1.5 (4)	Modified Rectangle	38	Y
	145.77	114.30		63.25	58.00	42.95	92.12	119.59				
HA590262	5.95	4.50	M12X1.5 (5)	2.76	2.78	1.65	3.59	4.50	M12X1.75 (3)	Modified Triangle	30	Y
	151.00	114.30		70.00	70.59	42.02	91.17	114.30				

*Denotes a Bearing Module

HUB UNIT BEARING / BEARING MODULE TECHNOLOGY

HUB UNIT BEARING / BEARING MODULE - NUMERICAL LISTING

continued

Timken Part No.	Flange Dia	Bolt Circle Dia	Bolt Size (Qty)	Wheel Pilot Dia	Brake Pilot Dia	Flange Offset	Hub Pilot Dia	Bolt Circle Dia	Bolt Hole Size (Qty)	Flange Shape	No. Of Spline	ABS (Y/N)
	A	B	C	D	E	F	G	H	I	J		
HA590263K	5.17	4.25	M12X1.5 (4)	2.49	2.50	-	-	-	-	-	-	Y
	131.30	108.00		63.25	63.50	-	-	-				
HA590264	5.95	4.50	M12X1.5 (5)	2.76	2.78	2.55	3.30	4.18	M10X1.5 (4)	Modified Square	30	Y
	151.00	114.30		70.00	70.56	64.78	83.92	106.09				
HA590265	6.22	4.72	M14X1.5 (5)	2.36	2.44	1.65	3.07	4.33	M12X1.25 (4)	Modified Rectangle	-	Y
	157.90	120.00		60.00	62.00	42.00	77.84	110.00				
HA590267	6.22	4.72	M14X1.5 (5)	2.36	2.44	2.05	3.74	5118.00	M12X1.25 (4)	Modified Trapezoid	30	Y
	158.00	120.00		60.00	62.00	52.12	95.00	130.00				
HA590269	6.22	4.72	M14X1.5 (5)	2.36	2.44	2.71	3.44	4.41	M12X1.25 (4)	Modified Square	30	Y
	158.00	120.00		60.00	62.00	68.80	87.36	112.00				
HA590270	6.22	4.72	M14X1.5 (5)	2.36	2.44	1.65	3.07	4.33	M12X1.25 (4)	Modified Trapezoid	-	Y
	158.00	120.00		60.00	62.00	41.95	77.84	110.00				
HA590271	5.47	4.50	M12X1.5 (5)	2.60	2.72	1.52	3.43	4.41	M12X1.25 (4)	Modified Square	29	Y
	139.00	114.30		66.00	69.00	38.50	87.00	112.00				
HA590273	7.88	6.69	M14X1.5 (10)	4.75	4.92	2.23	4.72	6.50	M14X1.5 (4)	Modified Square	35	Y
	200.00	170.00		120.65	125.00	56.70	120.00	165.10				
HA590274	6.59	5.00	M12X1.5 (5)	2.81	3.22	1.91	3.35	4.33	M10X1.5 (4)	Modified Rectangle	32	Y
	167.49	127.00		71.43	81.86	48.60	85.00	110.00				
HA590275	5.53	4.50	M12X1.5 (5)	2.64	3.15	2.33	3.47	4.41	M12X1.25 (4)	Modified Trapezoid	27	Y
	140.50	114.30		67.00	80.00	59.18	88.00	112.00				
HA590276	5.37	4.50	M12X1.25 (4)	2.60	2.60	1.60	3.15	4.06	M12X1.25 (4)	Modified Rectangle	29	N
	136.29	114.30		66.00	66.00	40.70	80.00	103.00				
HA590277	5.35	4.50	M12X1.25 (4)	2.60	2.68	1.60	3.15	4.06	M12X1.25 (4)	Modified Rectangle	29	Y
	136.00	114.30		66.00	68.00	40.60	80.00	103.00				
HA590278	5.35	4.50	M12X1.25 (5)	2.60	2.68	1.60	3.15	4.06	M12X1.25 (4)	Modified Rectangle	29	Y
	136.00	114.30		66.00	68.00	40.70	80.00	103.00				
HA590279	5.82	4.50	M12X1.25 (4)	2.60	2.68	2.72	3.31	4.21	M12X1.25 (4)	Modified Rectangle	-	N
	147.80	114.30		66.00	68.00	69.00	84.00	107.00				
HA590280	5.82	4.50	M12X1.25 (4)	2.60	2.68	2.72	3.31	4.25	M12X1.25 (4)	Modified Rectangle	-	Y
	147.79	114.30		66.00	68.00	69.00	84.00	108.00				
HA590281	5.84	4.50	M12X1.25 (5)	2.60	2.68	2.72	3.31	4.21	M12X1.25 (4)	Modified Rectangle	-	Y
	148.44	114.30		66.00	68.00	69.00	84.00	107.00				
HA590282	6.73	5.50	M12X1.25 (6)	3.06	3.54	1.79	3.50	4.75	M14X1.5 (3)	Triangle	29	Y
	171.00	139.70		77.68	90.00	45.42	89.00	120.66				
HA590284	6.73	5.50	M12X1.25 (6)	3.06	3.54	1.79	3.50	4.75	M14X1.5 (3)	Triangle	29	Y
	171.00	139.70		77.67	90.00	45.44	89.00	120.65				
HA590285	5.35	4.50	M12X1.25 (4)	2.60	2.68	1.60	3.15	4.13	M12X1.25 (3)	Modified Triangle	25	N
	136.00	114.30		66.00	68.00	40.68	80.00	104.78				
HA590286	5.83	4.50	M12X1.25 (4)	2.60	2.68	2.72	2.72	3.62	M10X1.25 (4)	Modified Trapezoid	-	N
	148.11	114.30		66.00	68.00	68.96	69.00	92.00				

*Denotes a Bearing Module

HUB UNIT BEARING / BEARING MODULE - NUMERICAL LISTING

continued

Timken Part No.	Flange Dia	Bolt Circle Dia	Bolt Size (Qty)	Wheel Pilot Dia	Brake Pilot Dia	Flange Offset	Hub Pilot Dia	Bolt Circle Dia	Bolt Hole Size (Qty)	Flange Shape	No. Of Spline	ABS (Y/N)
	A	B	C	D	E	F	G	H	I	J		
HA590286K	5.50	4.51	M12X1.5 (5)	2.64	2.83	-	-	-	-	-	28	N
	139.68	114.53		66.98	71.97	-	-	-	-	-		
HA590287	5.98	4.50	M12X1.5 (5)	2.44	2.44	2.84	3.30	4.33	0.492 12.50(4)	Modified Trapezoid	-	Y
	151.85	114.30		62.00	62.00	72.06	83.91	110.00				
HA590288	5.83	4.50	M12X1.25 (4)	2.60	2.68	2.72	2.72	3.58	M10X1.25 (4)	Modified Trapezoid	-	Y
	148.00	114.30		66.00	68.00	69.00	69.00	91.00				
HA590289	5.35	4.25	M14X1.5 (5)	2.64	2.68	2.32	3.44	4.50	M12X1.75 (4)	Modified Trapezoid	-	Y
	135.78	108.00		67.00	68.00	59.00	87.42	114.30				
HA590297	5.50	4.50	M12X1.5 (5)	2.64	2.84	-	-	-	-	-	-	N
	139.70	114.30		67.02	72.00	-	-	-				
HA590299	5.69	4.72	M14X1.5 (5)	2.63	2.65	1.65	3.58	4.53	M12X1.75 (3)	Modified Triangle	-	Y
	144.50	120.00		66.81	67.31	42.00	91.00	115.00				
HA590300	7.25	5.51	M12X1.5 (6)	3.91	3.94	2.65	3.35	4.41	M12X1.75 (4)	Modified Rectangle	-	Y
	184.16	140.00		99.42	100.00	67.20	85.00	112.00				
HA590301K	5.00	3.60	M12x1.5 (4)	2.13	2.13	-	-	-	-	-	26	N
	127.00	91.44		53.98	53.98	-	-	-				
HA590302K	5.47	4.50	M12X1.5 (5)	2.36	2.43	-	-	-	-	-	30	N
	139.00	114.30		59.90	61.80	-	-	-				
HA590303K	5.47	4.50	M12X1.5 (5)	2.36	2.43	-	-	-	-	-	26	N
	139.00	114.30		59.90	61.80	-	-	-				
HA590304	7.25	5.51	M12X1.5 (6)	3.92	3.94	2.65	3.35	4.41	M12X1.75 (4)	Modified Rectangle	27	Y
	184.12	140.00		99.54	100.00	67.24	85.00	112.00				
HA590305	5.32	3.94	M12X1.5 (5)	2.13	2.17	2.36	2.91	3.94	M12X1.25 (4)	Modified Trapezoid	-	Y
	135.00	100.00		54.00	55.00	60.00	74.00	100.00				
HA590306	5.43	4.50	M12X1.5 (5)	2.60	3.54	2.40	2.60	3.54	M10X1.25 (4)	Modified Rectangle	-	Y
	138.00	114.30		66.04	89.92	60.96	66.04	90.00				
HA590308	5.63	4.72	M12X1.5 (5)	2.85	3.11	-	-	-	-	-	-	Y
	143.00	120.00		72.50	79.00	-	-	-				
HA590310	5.98	4.50	M12X1.5 (5)	2.36	2.44	2.36	2.91	3.62	M10X1.25 (4)	Modified Trapezoid	-	Y
	152.00	114.30		60.00	62.00	60.00	74.00	92.00				
HA590311	5.98	4.50	M12X1.5 (5)	2.36	2.44	2.36	2.91	3.90	M12X1.25 (4)	Modified Trapezoid	-	Y
	152.00	114.30		60.00	62.00	60.00	74.00	99.00				
HA590312	5.35	4.25	M14X1.5 (5)	2.64	2.68	1.69	3.54	4.41	M12X1.75 (4)	Modified Rectangle	40	N
	135.76	108.00		67.00	68.00	43.00	90.00	112.00				
HA590313	4.88	3.94	M12X1.25 (5)	2.21	2.28	2.62	3.31	4.33	M12X1.25 (4)	Modified Rectangle	27	Y
	124.00	100.00		56.00	58.00	66.46	84.00	110.00				
HA590314	5.43	4.50	M12X1.25 (5)	2.21	2.28	2.62	3.31	4.33	M12X1.25 (4)	Modified Rectangle	27	Y
	138.00	114.30		56.00	58.00	66.53	84.00	110.00				
HA590315	4.88	3.94	M12X1.25 (5)	2.21	2.28	1.93	2.99	-	M12X1.25 (4)	Modified Trapezoid	27	Y
	124.00	100.00		56.00	58.00	49.00	76.00	-				

*Denotes a Bearing Module

HUB UNIT BEARING / BEARING MODULE TECHNOLOGY

HUB UNIT BEARING / BEARING MODULE - NUMERICAL LISTING

continued

Timken Part No.	Flange Dia	Bolt Circle Dia	Bolt Size (Qty)	Wheel Pilot Dia	Brake Pilot Dia	Flange Offset	Hub Pilot Dia	Bolt Circle Dia	Bolt Hole Size (Qty)	Flange Shape	No. Of Spline	ABS (Y/N)
	A	B	C	D	E	F	G	H	I	J		
HA590316	5.43	4.50	M12X1.25 (5)	2.21	2.28	1.83	3.31	-	M12X1.25 (4)	Modified Trapezoid	27	Y
	138.00	114.30		56.00	58.00	46.43	84.00	-				
HA590317	6.37	5.00	M12X1.5 (5)	2.81	2.85	1.91	3.35	4.33	M10X1.5 (4)	Modified Rectangle	-	Y
	161.77	127.00		71.43	72.44	48.50	85.00	110.00				
HA590321	5.35	4.25	M12X1.2 (5)	2.49	2.50	2.48	3.27	4.41	0.425 10.8(4)	Modified Trapezoid	36	Y
	135.82	108.00		63.25	63.50	63.00	83.00	112.00				
HA590322	5.35	3.85	M12X1.5 (5)	2.49	2.50	2.49	2.91	3.84	M10X1.5 (4)	Modified Square	-	Y
	136.00	97.75		63.20	63.50	63.12	74.00	97.49				
HA590323	5.17	4.25	M12X1.5 (5)	2.49	2.50	-	-	-	-	-	36	Y
	131.37	108.00		63.20	63.50	-	-	-				
HA590324	5.47	4.50	M12X1.5 (5)	2.64	2.72	2.10	3.15	4.42	M12X1.25 (4)	Modified Rectangle	-	Y
	139.00	114.30		67.00	69.00	53.25	80.00	112.20				
HA590325	5.83	4.50	M12X1.5 (5)	2.64	2.99	2.32	2.87	3.94	M10X1.25 (4)	Modified Rectangle	-	Y
	148.00	114.30		67.00	76.00	59.00	73.00	100.00				
HA590326	5.47	4.50	M12X1.5 (5)	2.64	2.72	2.09	3.54	4.50	M12X1.25 (4)	Modified Rectangle	30	N
	139.00	114.30		67.00	69.00	53.15	90.00	114.30				
HA590327	5.49	4.50	M12X1.5 (6)	2.64	2.72	2.10	3.62	4.50	M12X1.25 (4)	Modified Rectangle	30	N
	139.44	114.30		67.00	69.00	53.31	92.00	114.30				
HA590335	5.50	4.50	1/2-20 (5)	2.77	2.84	2.48	3.07	4.15	1/2-13 (4)	Modified Trapezoid	-	Y
	139.70	114.30		70.42	72.00	63.00	78.00	105.48				
HA590336	5.50	4.50	M12X1.5 (5)	2.64	2.84	2.48	3.07	4.17	M12X1.25 (4)	Modified Trapezoid	-	Y
	139.76	114.30		67.00	72.00	63.00	78.00	106.00				
HA590337	5.35	4.25	M14X1.5 (5)	2.49	2.50	2.48	3.20	4.41	M12X1.5 (4)	Modified Rectangle	-	Y
	136.00	108.00		63.24	63.50	63.00	81.36	112.00				
HA590352	7.85	6.50	M14x1.5 (8)	4.59	4.64	2.57	4.16	5.51	M14X1.5 (4)	Modified Square	-	Y
	199.30	165.10		116.64	117.84	65.35	105.68	140.00				
HA590353	7.85	6.50	M14x1.5 (8)	4.59	4.64	2.57	4.17	5.51	M14X1.5 (4)	Modified Square	-	Y
	199.30	165.10		116.64	117.84	65.35	105.79	140.00				
HA590370	5.98	4.53	M12X1.5 (5)	2.36	2.44	2.94	-	3.90	0.413 10.5(4)	Offset Trapezoid	-	Y
	151.90	115.00		59.97	61.93	74.69	-	99.00				
HA590371	5.98	4.50	M12X1.5 (5)	2.37	2.44	2.94	-	3.87	0.398 10.11(4)	Modified Trapezoid	-	N
	151.90	114.18		60.10	61.98	74.68	-	98.16				
HA590425	7.99	6.69	M14X2 (8)	4.92	5.08	2.03	4.48	5.51	M14X1.5 (4)	Square	55	Y
	203.00	170.00		124.91	129.01	51.50	113.80	140.00				
HA590653	6.54	5.50	M12x1.5 (6)	3.94	3.98	3.01	3.27	4.49	M12x1.25 (4)	Modified Rectangle	-	Y
	166.00	139.70		100.00	101.00	76.50	83.00	113.00				
HA591050	6.06	4.50	M12x1.5 (5)	2.36	2.44	2.66	3.31	4.41	M12x1.25 (4)	Rectangle	-	N
	154.00	114.30		60.00	62.00	67.50	84.00	112.00				
HA591080	5.98	4.50	- (5)	2.36	2.44	2.72	3.31	4.17	0.421 10.7(4)	Modified Trapezoid	26	N
	152.00	114.30		60.00	62.00	69.00	84.00	106.00				

*Denotes a Bearing Module

HUB UNIT BEARING / BEARING MODULE - NUMERICAL LISTING

continued

Timken Part No.		Flange Dia	Bolt Circle Dia	Bolt Size (Qty)	Wheel Pilot Dia	Brake Pilot Dia	Flange Offset	Hub Pilot Dia	Bolt Circle Dia	Bolt Hole Size (Qty)	Flange Shape	No. Of Spline	ABS (Y/N)
		A	B	C	D	E	F	G	H	I	J		
HA591339		8.19	6.50	.600 15.24(8)	4.59	-	2.69	4.17	-	M14x1.5 (4)	Modified Square	33	N
		208.00	165.10		116.59	-	68.33	105.79	-				
HA592210	*	-	-	-	-	-	-	3.31	4.72	M12X1.25 (3)	Modified Polygon	-	N
		-	-		-	-	-	84.00	120.00				
HA592410		5.32	3.94	M12X1.5 (4)	2.13	2.17	2.15	2.64	-	M10X1.25 (4)	Offset Trapezoid	-	N
		135.00	100.00		54.00	55.00	54.50	67.00	-				
HA592450		5.98	4.50	-	2.36	2.44	2.93	2.91	3.90	0.413 10.50(4)	Modified Trapezoid	-	Y
		152.00	114.30		(5)	60.00	62.00	74.50	74.00				
HA592451		5.98	4.50	M12X1.5 (5)	2.36	2.44	2.84	3.30	4.36	-	Modified Trapezoid	-	Y
		152.00	114.30		60.00	62.00	72.06	83.79	110.61				
HA592460		5.98	4.50	M12X1.5 (5)	2.36	2.44	2.93	2.91	3.90	0.413 10.50(4)	Modified Trapezoid	-	Y
		152.00	114.30		60.00	62.00	74.50	74.00	99.00				
HA592461		5.98	4.50	M12X1.5 (5)	2.37	2.44	2.84	3.30	4.34	-	Modified Trapezoid	-	Y
		151.88	114.32		60.31	62.07	72.04	83.82	110.14				
HA592519		5.47	4.72	M12x1.5 (5)	2.85	3.11	1.77	3.22	-	-	-	-	N
		139.00	120.00		72.50	79.00	45.00	81.70	-				
HA593427		5.47	4.72	M12x1.5 (5)	2.91	3.11	2.00	3.54	-	M12x1.5 (4)	-	-	N
		139.00	120.00		74.00	79.00	50.75	90.00	-				
HA593550		5.51	4.50	M12x1.5 (5)	2.36	2.44	2.17	2.91	4.41	M12x1.25 (4)	Modified Rectangle	-	Y
		140.00	114.30		60.00	62.00	55.00	74.00	112.00				
HA594181		5.35	4.25	M12 (5)	2.56	2.68	1.69	3.29	4.06	M12 (4)	Modified Rectangle	-	N
		136.00	108.00		65.00	68.00	43.00	83.50	103.00				
HA594241		5.98	4.50	-	2.36	2.44	2.72	3.31	4.17	0.42 10.70(4)	Modified Trapezoid	-	N
		152.00	114.30		(5)	60.00	62.00	69.00	84.00				
HA594245		5.31	3.94	M12x1.5 (4)	2.13	2.17	2.15	2.64	3.62	M10x1.25 (4)	Modified Trapezoid	-	Y
		135.00	100.00		54.00	55.00	54.50	67.00	92.00				
HA594246	*	-	-	-	-	-	-	3.94	5.51	-	Modified Trapezoid	-	N
		-	-		-	-	-	100.00	140.00				
HA594301	*	-	-	-	-	-	-	4.17	5.51	0.47,0.50 12(2),12.8(2)	Offset Trapezoid	-	N
		-	-		-	-	-	106.00	140.00				
HA594460K		5.45	3.94	M12x1.5 (4)	2.21	2.39	-	-	-	-	-	26	N
		138.50	100.00		56.08	60.86	-	-	-				
HA594504		5.98	4.50	-	2.36	2.44	2.72	3.31	4.17	0.42 10.70(4)	Modified Trapezoid	-	Y
		152.00	114.30		(5)	60.00	62.00	69.00	84.00				
HA594505		5.98	4.49	M12X1.5 (5)	2.36	3.20	2.72	3.30	4.27	0.417 10.60(4)	Modified Trapezoid	26	N
		151.98	114.16		60.02	81.30	69.00	83.87	108.36				
HA595017		4.92	3.94	-	2.13	2.17	2.19	2.64	3.62	M10x1.25 (4)	Modified Rectangle	-	Y
		125.00	100.00		(4)	54.00	55.00	55.50	67.00				
HA595894		5.35	4.25	M12 (4)	2.56	2.68	1.69	3.27	4.06	M12 (4)	Modified Rectangle	-	N
		136.00	108.00		65.00	68.00	43.00	83.00	103.00				

*Denotes a Bearing Module

HUB UNIT BEARING / BEARING MODULE - NUMERICAL LISTING

continued

Timken Part No.		Flange Dia	Bolt Circle Dia	Bolt Size (Qty)	Wheel Pilot Dia	Brake Pilot Dia	Flange Offset	Hub Pilot Dia	Bolt Circle Dia	Bolt Hole Size (Qty)	Flange Shape	No. Of Spline	ABS (Y/N)
		A	B	C	D	E	F	G	H	I	J		
HA596030		5.98	4.50	M12X1.5 (5)	2.36	2.44	2.93	2.91	3.90	0.413 10.49(4)	Modified Trapezoid	-	N
		152.00	114.30		60.00	62.00	74.50	74.00	99.00				
HA596060	*	-	-	-	-	-	-	3.78	5.20	0.49 12.45(4)	Rectangle	-	N
		-	-		-	-	-	96.00	132.00				
HA596467		5.39	4.33	M12X1.5 (5)	2.56	2.76	-	2.99	-	-	-	-	Y
		137.00	110.00		65.00	70.00	-	76.00	-				
HA597060	*	-	-	-	-	-	-	3.78	5.20	0.492 12.5(4)	Rectangle	-	N
		-	-		-	-	-	96.00	132.00				
HA597449		5.98	4.50	1/2-20 (5)	2.81	2.83	1.91	3.70	4.75	M12x1.75 (3)	Modified Triangle	27	N
		152.00	114.30		71.43	71.93	48.46	94.00	120.65				
HA597851		8.19	6.50	.600 15.24(8)	4.77	-	2.20	3.91	-	M14x1.5 (3)	Modified Triangle	33	N
		208.00	165.10		121.06	-	55.88	99.19	-				
HA597957		5.35	4.25	.394 10.01(5)	2.56	2.69	-	3.01	-	-	-	-	Y
		135.99	107.95		64.97	68.40	-	76.38	-				
HA598679		6.49	5.00	1/2-20 (5)	2.81	2.83	2.12	3.94	4.75	M12x1.75 (3)	Modified Triangle	27	N
		164.75	127.00		71.43	71.93	53.80	100.13	120.65				
HA599361		6.31	4.50	- (6)	2.81	2.89	2.11	3.50	-	M14x1.5 (3)	Modified Triangle	31	N
		160.27	114.30		71.37	73.41	53.49	88.90	-				
HA599406		6.31	4.50	1/2-20 (6)	2.81	2.89	2.27	-	-	-	-	-	Y
		160.27	114.30		71.37	73.28	57.68	-	-				
HA599455L		-	-	1/2-20 (5)	-	-	-	3.94	-	M12x1.75 (3)	Modified Triangle	-	Y
		-	-		-	-	-	100.13	-				
HA599455R		-	-	1/2-20 (5)	-	-	-	3.94	-	M12x1.75 (3)	Modified Triangle	-	Y
		-	-		-	-	-	100.13	-				
HA599467		-	-	1/2-20 (5)	-	-	-	3.94	-	M12x1.75 (3)	Modified Triangle	-	N
		-	-		-	-	-	100.13	-				
HA599528		6.31	4.50	1/2-20 (6)	2.81	2.89	2.27	-	-	-	-	-	N
		160.27	114.30		71.37	73.28	57.68	-	-				
HA599863		7.20	5.50	1/2-20 (5)	3.06	3.09	1.99	3.91	4.96	M14X1.5 (3)	Modified Triangle	33	N
		183.00	139.70		77.66	78.40	50.64	99.30	126.00				
SP450100		6.31	4.50	- (6)	2.81	2.89	2.11	3.50	-	M14x1.5 (3)	Modified Triangle	31	Y
		160.27	114.30		71.37	73.41	53.49	88.90	-				
SP450101		6.31	4.50	- (6)	2.81	2.89	2.11	3.50	-	M14x1.5 (3)	Modified Triangle	31	Y
		160.27	114.30		71.37	73.41	53.49	88.90	-				
SP450200		5.93	4.50	1/2-20 (5)	2.77	2.83	2.22	3.94	4.75	M12x1.75 (3)	Modified Triangle	27	Y
		150.50	114.30		70.46	71.88	56.26	100.08	120.65				
SP450201		5.88	4.50	M12X1.75 (5)	2.77	2.83	2.21	3.94	5.23	1/2-20 (3)	Modified Triangle	-	Y
		149.40	114.30		70.40	71.88	56.10	100.10	132.86				
SP450202		5.88	4.50	1/2-20 (5)	2.77	2.84	2.22	3.94	5.23	M12x1.75 (3)	Modified Triangle	27	Y
		149.44	114.30		70.40	72.11	56.38	100.10	132.86				

*Denotes a Bearing Module

HUB UNIT BEARING / BEARING MODULE - NUMERICAL LISTING

continued

Timken Part No.	Flange Dia	Bolt Circle Dia	Bolt Size (Qty)	Wheel Pilot Dia	Brake Pilot Dia	Flange Offset	Hub Pilot Dia	Bolt Circle Dia	Bolt Hole Size (Qty)	Flange Shape	No. Of Spline	ABS (Y/N)
	A	B	C	D	E	F	G	H	I	J		
SP450300	5.76	4.75	M12x1.5 (5)	2.76	2.78	1.86	3.51	4.75	- (3)	Modified Triangle	-	Y
	146.40	120.65		70.16	70.63	47.21	89.08	120.65				
SP450301	7.06	5.50	M14X1.5 (6)	3.07	3.09	1.98	3.91	4.96	M14X1.5 (3)	Triangle	-	Y
	179.30	139.70		77.90	78.45	50.18	99.34	126.00				
SP450303	7.03	5.50	M14X1.5 (6)	3.06	3.09	1.98	3.91	4.96	M14X1.5 (3)	Triangle	-	Y
	178.50	139.70		77.81	78.44	50.18	99.34	126.00				
SP450701	5.51	4.50	- (6)	2.60	2.68	1.82	3.66	4.72	M12X1.25 (4)	Modified Rectangle	29	Y
	140.00	114.30		65.91	67.95	46.10	93.00	120.00				
SP450702	5.51	4.50	- (6)	2.60	2.68	1.82	3.66	4.72	M12X1.25 (4)	Modified Rectangle	-	Y
	140.00	114.30		65.91	67.95	46.10	93.00	120.00				
SP470200	6.30	4.50	1/2-20 (5)	2.78	3.23	1.93	3.35	4.33	M12X1.75 (3)	Modified Triangle	27	Y
	160.00	114.30		70.51	81.94	48.95	85.08	110.00				
SP470201	6.30	4.50	1/2-20 (5)	2.78	3.23	1.93	3.35	4.33	M12X1.75 (3)	Modified Triangle	27	Y
	160.00	114.30		70.51	81.94	48.95	85.08	110.00				
SP500100	7.22	5.50	9/16-18 (5)	3.06	3.09	1.85	3.54	4.96	M14x1.5 (3)	Modified Triangle	33	Y
	183.30	139.70		77.76	78.42	47.08	90.04	126.00				
SP500101	7.21	5.50	9/16-18 (5)	3.06	3.09	1.84	3.54	4.96	M14X1.5 (3)	Modified Triangle	33	Y
	183.04	139.70		77.75	78.36	46.71	90.02	126.00				
SP500300	7.09	5.50	M14x1.5 (6)	3.06	3.09	1.96	3.91	4.06	M14x1.5 (3)	Modified Triangle	33	Y
	180.00	139.70		77.84	78.36	50.00	99.31	103.12				
SP500301	5.50	5.50	M14X1.5 (6)	3.06	3.09	1.98	3.91	4.96	M14X1.5 (3)	Triangle	33	Y
	139.70	139.70		77.81	78.40	50.18	99.34	126.00				
SP500701	6.75	6.75	- (6)	3.06	3.23	1.80	3.50	4.75	M14X1.5 (3)	Triangle	29	Y
	171.50	171.50		77.70	82.04	45.80	89.04	120.65				
SP500702	6.75	5.50	M12X1.25 (6)	3.06	3.23	2.23	3.50	4.49	M12X1.75 (4)	Modified Square	32	Y
	171.50	139.70		77.70	82.04	56.74	89.04	114.00				
SP500703	6.75	5.50	M12X1.25 (6)	3.06	3.55	1.80	3.51	4.75	M14X1.5 (3)	Modified Triangle	29	Y
	171.50	139.70		77.70	90.04	45.80	89.04	120.65				
SP550100	6.78	5.50	1/2-20 (5)	3.06	3.09	2.01	3.91	4.96	M14x1.5 (3)	Modified Triangle	33	Y
	172.00	139.70		77.72	78.49	50.98	99.31	125.98				
SP550101	6.78	5.50	1/2-20 (5)	3.06	3.09	2.01	3.91	4.96	M14x1.5 (3)	Modified Triangle	33	Y
	172.00	139.70		77.72	78.49	50.98	99.31	125.98				
SP550102	7.20	5.50	1/2-20 (5)	3.06	3.09	2.23	3.91	4.96	M14x1.5 (3)	Modified Triangle	33	Y
	183.00	139.70		77.66	78.37	56.64	99.31	126.00				
SP550103	8.09	6.50	9/16-18 (8)	4.77	4.81	1.98	3.91	4.96	M14X1.5 (3)	Triangle	-	Y
	205.50	165.10		121.08	122.28	50.18	99.34	126.00				
SP550104	8.08	6.48	9/16-18 (8)	4.77	4.81	1.99	3.91	5.04	M14X1.5 (3)	Modified Triangle	-	Y
	205.18	164.67		121.03	122.23	50.45	99.30	128.00				
SP550200	7.17	5.32	- (5)	3.42	3.54	1.94	3.91	4.96	M14x1.5 (3)	Modified Triangle	33	Y
	182.00	135.03		86.74	89.97	49.28	99.31	125.88				

*Denotes a Bearing Module

HUB UNIT BEARING / BEARING MODULE TECHNOLOGY

HUB UNIT BEARING / BEARING MODULE - NUMERICAL LISTING

continued

Timken Part No.	Flange Dia	Bolt Circle Dia	Bolt Size (Qty)	Wheel Pilot Dia	Brake Pilot Dia	Flange Offset	Hub Pilot Dia	Bolt Circle Dia	Bolt Hole Size (Qty)	Flange Shape	No. Of Spline	ABS (Y/N)
	A	B	C	D	E	F	G	H	I	J		
SP550201	7.13	5.32	-	3.42	3.64	1.96	3.91	4.96	M14x1.5 (3)	Modified Triangle	33	Y
	181.20	135.03	(5)	86.74	92.33	49.71	99.31	125.88				
SP550202	7.20	5.28	M14x2.0 (6)	3.42	3.54	1.79	3.90	6.32	M14x1.5 (4)	Square	-	Y
	183.00	134.00		86.80	90.00	45.50	99.00	160.50				
SP550203	7.20	5.31	M14x2.0 (6)	3.43	3.54	2.19	3.91	5.38	M14x1.5 (4)	Rectangle	33	Y
	182.84	134.76		87.03	90.01	55.75	99.35	136.76				
SP550206	7.22	5.32	M14X2 (6)	3.42	3.54	1.81	3.91	6.30	M14X1.5 (4)	Modified Square	-	Y
	183.50	135.00		86.80	90.03	46.00	99.34	160.00				
SP550207	7.21	5.32	M14X2 (6)	3.42	3.54	1.81	3.91	6.30	M14X1.5 (4)	Modified Square	45	Y
	183.00	135.00		86.80	90.03	46.00	99.34	160.00				
SP550208	7.48	5.91	M14X2 (7)	3.42	3.54	1.81	3.91	6.30	M14X1.5 (4)	Modified Square	45	Y
	190.00	150.00		86.80	90.03	46.00	99.34	160.00				
SP550209	7.20	5.32	M14X2 (6)	3.42	3.54	2.19	3.91	5.37	M14X1.5 (4)	Modified Rectangle	33	Y
	182.83	135.21		86.98	89.98	55.56	99.35	136.29				
SP550210	7.21	5.32	M14X2 (6)	3.42	3.54	1.81	3.91	6.30	M14X1.5 (4)	Modified Square	45	Y
	183.00	135.00		86.80	90.03	46.00	99.34	160.00				
SP550211	7.21	5.32	M14X2 (6)	3.42	3.54	1.81	3.91	6.30	M14X1.5 (4)	Modified Square	-	Y
	183.00	135.00		86.80	90.03	46.00	99.34	160.00				
SP550212	7.21	5.32	M14X2 (6)	3.42	3.55	1.81	3.91	6.30	M14X1.5 (4)	Modified Square	45	Y
	183.00	135.00		86.80	90.26	46.00	99.34	160.00				
SP550213	7.48	5.91	M14X2 (7)	3.42	3.54	1.81	3.91	6.30	M14X1.5 (4)	Modified Square	45	Y
	190.00	150.00		86.80	90.03	46.00	99.34	160.00				
SP550214	7.21	5.32	M14X2 (6)	3.42	3.54	1.81	3.91	6.30	M14X1.5 (4)	Modified Square	45	Y
	183.00	135.00		86.80	90.03	46.00	99.34	160.00				
SP550215	7.48	5.91	M14X2 (7)	3.42	3.54	1.81	3.91	6.30	M14X1.5 (4)	Modified Square	45	Y
	190.00	150.00		86.80	90.03	46.00	99.34	160.00				
SP550216	7.21	5.32	M14X2 (6)	3.42	3.54	1.81	3.91	6.30	M14X1.5 (4)	Modified Square	-	Y
	183.00	135.00		86.80	90.03	46.00	99.34	160.00				
SP550307	7.17	5.50	M14x1.5 (6)	3.06	3.09	2.23	3.91	5.00	-	Modified Triangle	33	Y
	181.99	139.70		77.60	78.37	56.64	99.31	127.00				
SP550308	6.31	5.00	M14x1.5 (5)	3.06	3.09	2.94	3.91	5.00	-	Modified Triangle	33	Y
	160.27	127.00		77.66	78.37	74.68	99.31	127.00				
SP550309	7.09	5.50	M14x1.5 (6)	3.08	3.09	1.97	3.91	4.91	M14x1.5 (3)	Modified Triangle	33	Y
	180.00	139.70		78.24	78.46	50.09	99.35	124.80				
SP550310	7.09	5.50	M14x1.5 (6)	3.08	3.09	1.96	3.91	4.94	M14x1.5 (3)	Modified Triangle	33	Y
	180.00	139.70		78.32	78.60	49.90	99.32	125.42				
SP550311	7.04	5.50	M12X1.5 (6)	3.94	3.96	1.98	3.91	4.96	M14X1.5 (3)	Modified Triangle	33	Y
	178.70	139.70		99.99	100.67	50.20	99.34	126.00				
SP580100	8.37	6.50	9/16x18 (8)	4.77	-	2.97	4.48	5.51	M14x1.5 (4)	Rectangle	33	Y
	212.50	165.10		121.04	-	75.52	113.86	140.00				

*Denotes a Bearing Module

HUB UNIT BEARING / BEARING MODULE - NUMERICAL LISTING

continued

Timken Part No.	Flange Dia	Bolt Circle Dia	Bolt Size (Qty)	Wheel Pilot Dia	Brake Pilot Dia	Flange Offset	Hub Pilot Dia	Bolt Circle Dia	Bolt Hole Size (Qty)	Flange Shape	No. Of Spline	ABS (Y/N)
	A	B	C	D	E	F	G	H	I	J		
SP580101	8.37	6.50	9/16x18 (8)	4.77	-	2.97	4.48	5.51	M14x1.5 (4)	Rectangle	33	Y
	212.50	165.10		121.04	-	75.52	113.86	140.00				
SP580102	8.19	6.50	9/16x18 (8)	4.59	-	2.69	4.48	5.51	M14x1.5 (4)	Rectangle	33	Y
	208.00	165.10		116.64	-	68.25	113.86	140.00				
SP580103	8.19	6.50	9/16x18 (8)	4.59	-	2.69	4.48	5.51	M14x1.5 (4)	Rectangle	33	Y
	208.00	165.10		116.64	-	68.25	113.86	140.00				
SP580204	7.99	6.69	M14x2 (8)	4.92	5.08	2.03	4.48	5.51	M14x1.5 (4)	Square	55	Y
	203.00	170.00		124.97	129.01	51.50	113.90	140.00				
SP580205	7.99	6.69	M14x1.5 (8)	4.92	5.08	2.15	4.48	5.51	M14x1.5 (4)	Square	55	Y
	203.00	170.00		124.97	129.01	54.50	113.90	140.00				
SP580300	8.19	6.50	0.6 15.24(8)	4.59	-	2.69	4.17	5.51	M14x1.5 (4)	Rectangle	33	Y
	208.03	165.10		116.59	-	68.33	105.79	140.00				
SP580301	8.19	6.50	0.6 15.24(8)	4.59	-	2.69	4.17	-	M14x1.5 (4)	Rectangle	33	Y
	208.03	165.10		116.59	-	68.33	105.79	-				
SP580302	8.19	6.50	0.6 15.24(8)	4.59	-	2.69	4.17	-	M14x1.5 (4)	Rectangle	33	Y
	208.03	165.10		116.59	-	68.33	105.79	-				
SP580303	8.19	6.50	0.6 15.24(8)	4.59	-	2.69	4.17	-	M14x1.5 (4)	Rectangle	33	Y
	208.03	165.10		116.59	-	68.33	105.79	-				
SP580304	7.85	6.50	M14x1.5 (8)	4.59	4.65	2.68	4.17	5.51	-	Rectangle	33	Y
	208.00	165.10		116.64	118.11	68.00	105.80	140.00				
SP580305	7.85	6.50	M14x1.5 (8)	4.59	4.65	2.31	4.17	5.51	M14x1.5 (4)	Square	-	Y
	199.40	165.10		116.64	118.11	58.60	105.80	140.00				
SP580306	7.85	6.50	M14x1.5 (8)	4.59	4.65	2.30	4.17	5.51	M14x1.5 (4)	Square	-	Y
	199.40	165.10		116.64	118.11	58.35	105.80	140.00				
SP580307	7.85	6.50	M14x1.5 (8)	4.59	4.65	2.58	4.17	5.51	M14x1.5 (4)	Modified Square	-	Y
	199.40	165.10		116.64	118.11	65.55	105.80	140.00				
SP580308	7.85	6.50	M14x1.5 (8)	4.59	4.65	2.28	4.17	5.51	M14x1.5 (4)	Square	-	Y
	199.40	165.10		116.64	118.11	57.94	105.80	140.00				
SP580309	7.85	6.50	M14x1.5 (8)	4.59	4.65	2.29	4.17	5.51	M14x1.5 (4)	Square	33	Y
	199.40	165.10		116.64	118.11	58.25	105.80	140.00				
SP580310	7.85	6.50	M14x1.5 (8)	4.59	4.64	2.30	4.17	5.51	M14x1.5 (4)	Modified Square	33	Y
	199.30	165.10		116.69	117.89	58.35	105.84	140.00				
SP580311	7.85	6.50	M14x1.5 (8)	4.59	4.64	2.30	4.17	5.51	M14x1.5 (4)	Modified Square	33	Y
	199.30	165.10		116.69	117.89	58.35	105.84	140.00				
SP580312	7.85	6.50	M14x1.5 (8)	4.59	4.64	2.30	4.17	5.51	M14x1.5 (4)	Modified Square	33	Y
	199.30	165.10		116.69	117.89	58.35	105.84	140.00				
SP580313	7.85	6.50	M14x1.5 (8)	4.59	4.64	2.30	4.17	5.51	M14x1.5 (4)	Modified Square	33	Y
	199.30	165.10		116.69	117.89	58.35	105.84	140.00				
SP940200	7.99	6.69	M14x1.5 (8)	4.92	5.08	1.83	5.51	6.50	M14x1.5 (4)	Square	32	Y
	203.00	170.00		125.00	129.05	46.50	140.04	165.00				

*Denotes a Bearing Module

HUB UNIT BEARING / BEARING MODULE TECHNOLOGY

HUB UNIT BEARING / BEARING MODULE - NUMERICAL LISTING

continued

Timken Part No.	Flange Dia	Bolt Circle Dia	Bolt Size (Qty)	Wheel Pilot Dia	Brake Pilot Dia	Flange Offset	Hub Pilot Dia	Bolt Circle Dia	Bolt Hole Size (Qty)	Flange Shape	No. Of Spline	ABS (Y/N)
	A	B	C	D	E	F	G	H	I	J		
SP940201	7.99	6.69	M14X2 (8)	4.92	5.08	1.83	5.51	6.50	M14X1.5 (4)	Square	32	Y
	203.00	170.00		125.00	129.05	46.50	140.04	165.00				
SP940202	7.99	6.69	M14X2 (10)	4.92	5.08	1.83	5.51	6.50	M14X1.5 (4)	Square	32	Y
	203.00	170.00		125.00	129.05	46.50	140.04	165.00				
SP940203	7.99	6.69	M14X2 (10)	4.92	5.08	46.50	5.51	6.50	M14X1.5 (4)	Square	-	Y
	203.00	170.00		125.00	129.05	1.83	140.04	165.00				
SP940204	7.99	6.69	M14X2 (8)	4.92	5.08	1.83	5.51	6.50	M14X1.5 (4)	Square	32	Y
	203.00	170.00		125.00	129.05	46.50	140.04	165.00				

*Denotes a Bearing Module

**HUB UNIT BEARING / BEARING MODULE -
PHOTOS AND INSTALLATION SKILL LEVELS**

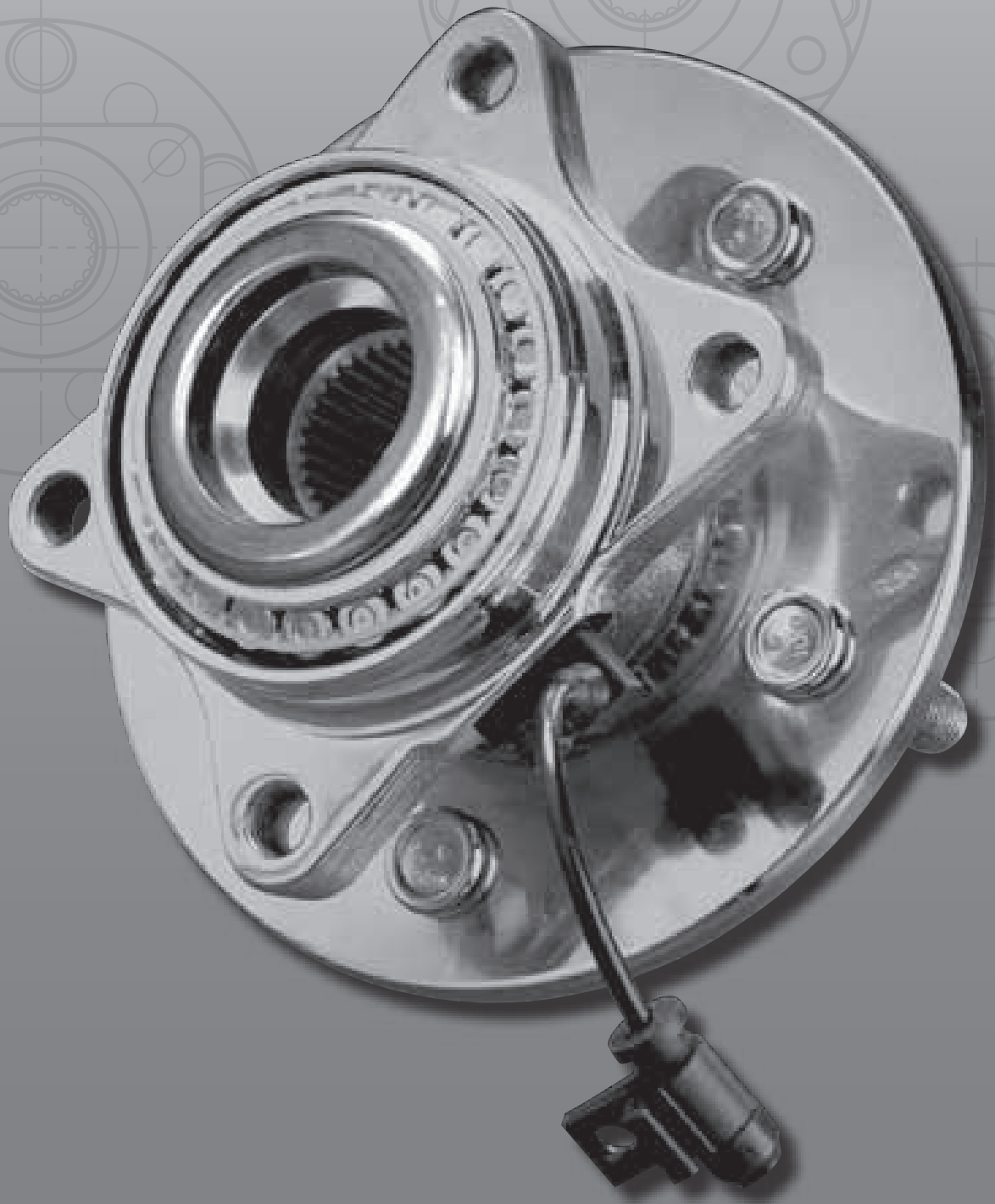

HUB UNIT BEARING / BEARING MODULE - PHOTOS AND INSTALLATION SKILL LEVELS

This section provides image references for part identification and also shows the 'skill level' required for each part installation. Some hub unit bearings and bearing modules require special tools and/or equipment such as a hydraulic press, which may not be found in the standard shop environment. In the example below, the 'skill level' is shown at the bottom right of the image.

Detailed product specifications for each hub unit bearing and bearing module contained in this section are available in the Hub Unit Bearing/Bearing Module – Diagrams and Specifications Section.

Example of how to use this section:

SP580310

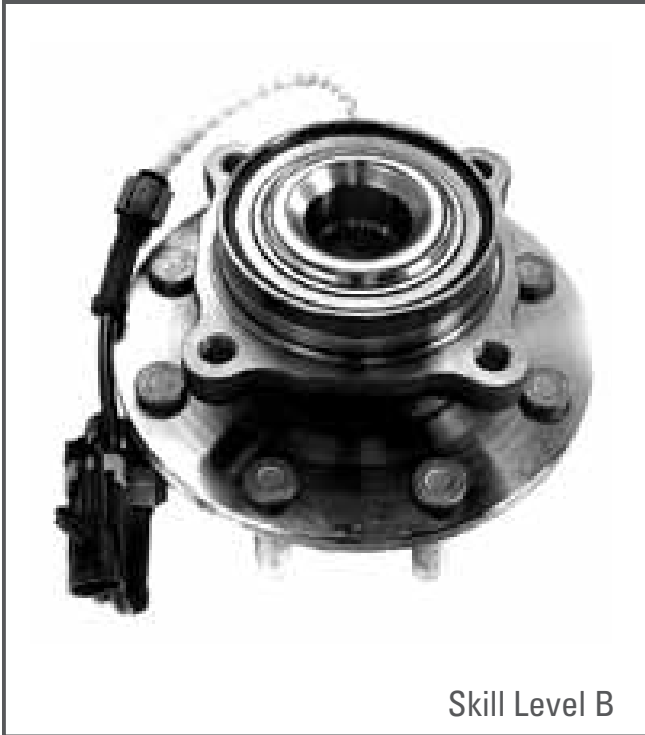

Skill Level A

High, professional technician and/or previous repair experience - may require special tools, equipment or processes.

Skill Level B

Moderate, above average mechanical skills.

Skill Level C

Low, basic automotive repair experience - average mechanical skills.

⚠ WARNING *Failure to observe the following warnings could create a risk of serious injury.*

Proper maintenance and handling procedures are critical. Always follow installation instructions and maintain proper lubrication.

Never spin a bearing with compressed air. The rollers may be forcefully expelled.

Do not attempt to disassemble and reassemble hub unit bearings and bearing modules. Improper reassembly could lead to failure.

HUB UNIT BEARING / BEARING MODULE - PHOTOS AND INSTALLATION SKILL LEVELS

510038	511011	511012
 <p data-bbox="496 890 613 915">Skill Level A</p>	 <p data-bbox="943 890 1060 915">Skill Level A</p>	 <p data-bbox="1386 890 1503 915">Skill Level A</p>
512000	512001	512002
 <p data-bbox="496 1404 613 1430">Skill Level B</p>	 <p data-bbox="943 1404 1060 1430">Skill Level B</p>	 <p data-bbox="1386 1404 1503 1430">Skill Level B</p>
512003	512004	512006
 <p data-bbox="496 1919 613 1944">Skill Level B</p>	 <p data-bbox="943 1919 1060 1944">Skill Level B</p>	 <p data-bbox="1386 1919 1503 1944">Skill Level B</p>

HUB UNIT BEARING / BEARING MODULE - PHOTOS AND INSTALLATION SKILL LEVELS

HUB UNIT BEARING / BEARING MODULE TECHNOLOGY

512008	512009	512010
 <p>Skill Level B</p>	 <p>Skill Level A</p>	 <p>Skill Level B</p>
512011	512012	512013
 <p>Skill Level B</p>	 <p>Skill Level B</p>	 <p>Skill Level B</p>
512014	512016	512017
 <p>Skill Level A</p>	 <p>Skill Level B</p>	 <p>Skill Level B</p>

**HUB UNIT BEARING / BEARING MODULE -
PHOTOS AND INSTALLATION SKILL LEVELS**

512018	512019	512020
 <p data-bbox="496 890 613 915">Skill Level B</p>	 <p data-bbox="940 890 1057 915">Skill Level B</p>	 <p data-bbox="1386 890 1503 915">Skill Level B</p>
512021	512022	512023
 <p data-bbox="496 1404 613 1430">Skill Level B</p>	 <p data-bbox="940 1404 1057 1430">Skill Level B</p>	 <p data-bbox="1386 1404 1503 1430">Skill Level B</p>
512024	512025	512026
 <p data-bbox="496 1917 613 1942">Skill Level B</p>	 <p data-bbox="940 1917 1057 1942">Skill Level B</p>	 <p data-bbox="1386 1917 1503 1942">Skill Level B</p>

HUB UNIT BEARING / BEARING MODULE - PHOTOS AND INSTALLATION SKILL LEVELS

HUB UNIT BEARING / BEARING MODULE TECHNOLOGY

<p>512027</p>  <p>Skill Level B</p>	<p>512029</p>  <p>Skill Level B</p>	<p>512031</p>  <p>Skill Level B</p>
<p>512032</p>  <p>Skill Level B</p>	<p>512033</p>  <p>Skill Level B</p>	<p>512036</p>  <p>Skill Level B</p>
<p>512037</p>  <p>Skill Level B</p>	<p>512038</p>  <p>Skill Level A</p>	<p>512039</p>  <p>Skill Level B</p>

**HUB UNIT BEARING / BEARING MODULE -
PHOTOS AND INSTALLATION SKILL LEVELS**

<p>512040</p>  <p>Skill Level B</p>	<p>512041</p>  <p>Skill Level B</p>	<p>512078</p>  <p>Skill Level B</p>
<p>512105</p>  <p>Skill Level B</p>	<p>512106</p>  <p>Skill Level B</p>	<p>512107</p>  <p>Skill Level B</p>
<p>512118</p>  <p>Skill Level B</p>	<p>512119</p>  <p>Skill Level B</p>	<p>512120</p>  <p>Skill Level B</p>

HUB UNIT BEARING / BEARING MODULE - PHOTOS AND INSTALLATION SKILL LEVELS

HUB UNIT BEARING / BEARING MODULE TECHNOLOGY

512121	512122	512123
 <p data-bbox="399 890 516 915">Skill Level B</p>	 <p data-bbox="846 890 963 915">Skill Level B</p>	 <p data-bbox="1292 890 1409 915">Skill Level B</p>
512124	512125	512133
 <p data-bbox="399 1402 516 1428">Skill Level B</p>	 <p data-bbox="846 1402 963 1428">Skill Level B</p>	 <p data-bbox="1292 1402 1409 1428">Skill Level B</p>
512136	512137	512140
 <p data-bbox="399 1917 516 1942">Skill Level A</p>	 <p data-bbox="846 1917 963 1942">Skill Level A</p>	 <p data-bbox="1292 1917 1409 1942">Skill Level B</p>

HUB UNIT BEARING / BEARING MODULE - PHOTOS AND INSTALLATION SKILL LEVELS

<p>512144</p>  <p>Skill Level B</p>	<p>512145</p>  <p>Skill Level B</p>	<p>512147</p>  <p>Skill Level B</p>
<p>512148</p>  <p>Skill Level B</p>	<p>512149</p>  <p>Skill Level B</p>	<p>512151</p>  <p>Skill Level B</p>
<p>512152</p>  <p>Skill Level B</p>	<p>512153</p>  <p>Skill Level B</p>	<p>512154</p>  <p>Skill Level B</p>

HUB UNIT BEARING / BEARING MODULE TECHNOLOGY

HUB UNIT BEARING / BEARING MODULE - PHOTOS AND INSTALLATION SKILL LEVELS

HUB UNIT BEARING / BEARING MODULE TECHNOLOGY

<p>512155</p>  <p>Skill Level B</p>	<p>512156</p>  <p>Skill Level B</p>	<p>512157</p>  <p>Skill Level B</p>
<p>512158</p>  <p>Skill Level B</p>	<p>512159</p>  <p>Skill Level B</p>	<p>512160</p>  <p>Skill Level B</p>
<p>512161</p>  <p>Skill Level B</p>	<p>512162</p>  <p>Skill Level B</p>	<p>512163</p>  <p>Skill Level B</p>

**HUB UNIT BEARING / BEARING MODULE -
PHOTOS AND INSTALLATION SKILL LEVELS**

512164	512165	512166
 <p data-bbox="496 890 613 915">Skill Level B</p>	 <p data-bbox="943 890 1060 915">Skill Level B</p>	 <p data-bbox="1386 890 1503 915">Skill Level A</p>
512167	512168	512169
 <p data-bbox="496 1402 613 1428">Skill Level B</p>	 <p data-bbox="943 1402 1060 1428">Skill Level B</p>	 <p data-bbox="1386 1402 1503 1428">Skill Level B</p>
512170	512171	512172
 <p data-bbox="496 1919 613 1944">Skill Level B</p>	 <p data-bbox="943 1919 1060 1944">Skill Level B</p>	 <p data-bbox="1386 1919 1503 1944">Skill Level B</p>

HUB UNIT BEARING / BEARING MODULE - PHOTOS AND INSTALLATION SKILL LEVELS

HUB UNIT BEARING / BEARING MODULE TECHNOLOGY

<p>512173</p>  <p>Skill Level B</p>	<p>512174</p>  <p>Skill Level B</p>	<p>512175</p>  <p>Skill Level B</p>
<p>512176</p>  <p>Skill Level B</p>	<p>512177</p>  <p>Skill Level B</p>	<p>512178</p>  <p>Skill Level B</p>
<p>512179</p>  <p>Skill Level B</p>	<p>512180</p>  <p>Skill Level B</p>	<p>512181</p>  <p>Skill Level A</p>

HUB UNIT BEARING / BEARING MODULE - PHOTOS AND INSTALLATION SKILL LEVELS

512182	512183	512184
 <p>Skill Level B</p>	 <p>Skill Level A</p>	 <p>Skill Level B</p>
512185	512186	512187
 <p>Skill Level B</p>	 <p>Skill Level B</p>	 <p>Skill Level B</p>
512188	512189	512190
 <p>Skill Level B</p>	 <p>Skill Level B</p>	 <p>Skill Level B</p>

HUB UNIT BEARING / BEARING MODULE - PHOTOS AND INSTALLATION SKILL LEVELS

HUB UNIT BEARING / BEARING MODULE TECHNOLOGY

<p>512191</p>  <p>Skill Level B</p>	<p>512192</p>  <p>Skill Level B</p>	<p>512193</p>  <p>Skill Level B</p>
<p>512194</p>  <p>Skill Level B</p>	<p>512195</p>  <p>Skill Level B</p>	<p>512196</p>  <p>Skill Level B</p>
<p>512197</p>  <p>Skill Level B</p>	<p>512198</p>  <p>Skill Level B</p>	<p>512199</p>  <p>Skill Level B</p>

**HUB UNIT BEARING / BEARING MODULE -
PHOTOS AND INSTALLATION SKILL LEVELS**

<p>512200</p>  <p>Skill Level B</p>	<p>512201</p>  <p>Skill Level B</p>	<p>512202</p>  <p>Skill Level B</p>
<p>512203</p>  <p>Skill Level B</p>	<p>512204</p>  <p>Skill Level B</p>	<p>512217</p>  <p>Skill Level B</p>
<p>512218</p>  <p>Skill Level B</p>	<p>512220</p>  <p>Skill Level B</p>	<p>512221</p>  <p>Skill Level B</p>

HUB UNIT BEARING / BEARING MODULE TECHNOLOGY

HUB UNIT BEARING / BEARING MODULE - PHOTOS AND INSTALLATION SKILL LEVELS

HUB UNIT BEARING / BEARING MODULE TECHNOLOGY

512222	512223	512225
 <p data-bbox="402 890 516 915">Skill Level B</p>	 <p data-bbox="846 890 959 915">Skill Level B</p>	 <p data-bbox="1292 890 1406 915">Skill Level B</p>
512229	512230	512231
 <p data-bbox="402 1404 516 1430">Skill Level B</p>	 <p data-bbox="846 1404 959 1430">Skill Level B</p>	 <p data-bbox="1292 1404 1406 1430">Skill Level B</p>
512232	512235	512236
 <p data-bbox="402 1919 516 1944">Skill Level B</p>	 <p data-bbox="846 1919 959 1944">Skill Level B</p>	 <p data-bbox="1292 1919 1406 1944">Skill Level B</p>

**HUB UNIT BEARING / BEARING MODULE -
PHOTOS AND INSTALLATION SKILL LEVELS**

512237	512238	512239
 <p data-bbox="495 892 613 913">Skill Level B</p>	 <p data-bbox="941 892 1060 913">Skill Level B</p>	 <p data-bbox="1386 892 1505 913">Skill Level B</p>
512242	512251	512265
 <p data-bbox="495 1407 613 1428">Skill Level B</p>	 <p data-bbox="941 1407 1060 1428">Skill Level B</p>	 <p data-bbox="1386 1407 1505 1428">Skill Level B</p>
512267	512270	512280
 <p data-bbox="495 1921 613 1942">Skill Level B</p>	 <p data-bbox="941 1921 1060 1942">Skill Level B</p>	 <p data-bbox="1386 1921 1505 1942">Skill Level B</p>

HUB UNIT BEARING / BEARING MODULE TECHNOLOGY

HUB UNIT BEARING / BEARING MODULE - PHOTOS AND INSTALLATION SKILL LEVELS

HUB UNIT BEARING / BEARING MODULE TECHNOLOGY

512294	512295	512299
 <p>Skill Level A</p>	 <p>Skill Level A</p>	 <p>Skill Level B</p>
512305	512322	512323
 <p>Skill Level A</p>	 <p>Skill Level B</p>	 <p>Skill Level B</p>
512324	512326	512340
 <p>Skill Level B</p>	 <p>Skill Level B</p>	 <p>Skill Level B</p>

HUB UNIT BEARING / BEARING MODULE - PHOTOS AND INSTALLATION SKILL LEVELS

513003	513004K	513011K
 <p data-bbox="496 890 613 915">Skill Level B</p>	 <p data-bbox="943 890 1060 915">Skill Level B</p>	 <p data-bbox="1386 890 1503 915">Skill Level B</p>
513012	513013	513016K
 <p data-bbox="496 1409 613 1434">Skill Level B</p>	 <p data-bbox="943 1409 1060 1434">Skill Level B</p>	 <p data-bbox="1386 1409 1503 1434">Skill Level B</p>
513017K	513018	513019
 <p data-bbox="496 1921 613 1946">Skill Level B</p>	 <p data-bbox="943 1921 1060 1946">Skill Level B</p>	 <p data-bbox="1386 1921 1503 1946">Skill Level B</p>

HUB UNIT BEARING / BEARING MODULE - PHOTOS AND INSTALLATION SKILL LEVELS

HUB UNIT BEARING / BEARING MODULE TECHNOLOGY

513020	513030	513033
 <p>Skill Level B</p>	 <p>Skill Level B</p>	 <p>Skill Level B</p>
513034	513035	513039
 <p>Skill Level B</p>	 <p>Skill Level B</p>	 <p>Skill Level B</p>
513041	513042	513044
 <p>Skill Level B</p>	 <p>Skill Level B</p>	 <p>Skill Level B</p>

HUB UNIT BEARING / BEARING MODULE - PHOTOS AND INSTALLATION SKILL LEVELS

<p>513049</p>  <p>Skill Level B</p>	<p>513050</p>  <p>Skill Level B</p>	<p>513059</p>  <p>Skill Level B</p>
<p>513061</p>  <p>Skill Level B</p>	<p>513062</p>  <p>Skill Level B</p>	<p>513063</p>  <p>Skill Level B</p>
<p>513070</p>  <p>Skill Level B</p>	<p>513074</p>  <p>Skill Level B</p>	<p>513075</p>  <p>Skill Level B</p>

HUB UNIT BEARING / BEARING MODULE TECHNOLOGY

HUB UNIT BEARING / BEARING MODULE - PHOTOS AND INSTALLATION SKILL LEVELS

HUB UNIT BEARING / BEARING MODULE TECHNOLOGY

<p>513076</p>  <p>Skill Level B</p>	<p>513077</p>  <p>Skill Level B</p>	<p>513078</p>  <p>Skill Level B</p>
<p>513080</p>  <p>Skill Level B</p>	<p>513081</p>  <p>Skill Level B</p>	<p>513082</p>  <p>Skill Level B</p>
<p>513084</p>  <p>Skill Level B</p>	<p>513085</p>  <p>Skill Level B</p>	<p>513087</p>  <p>Skill Level B</p>

**HUB UNIT BEARING / BEARING MODULE -
PHOTOS AND INSTALLATION SKILL LEVELS**

513088	513089	513090
 <p data-bbox="496 890 613 915">Skill Level B</p>	 <p data-bbox="940 890 1057 915">Skill Level B</p>	 <p data-bbox="1385 890 1502 915">Skill Level B</p>
513092	513093	513094
 <p data-bbox="496 1404 613 1430">Skill Level B</p>	 <p data-bbox="940 1404 1057 1430">Skill Level A</p>	 <p data-bbox="1385 1404 1502 1430">Skill Level B</p>
513096	513098	513099
 <p data-bbox="496 1919 613 1944">Skill Level B</p>	 <p data-bbox="940 1919 1057 1944">Skill Level A</p>	 <p data-bbox="1385 1919 1502 1944">Skill Level A</p>

HUB UNIT BEARING / BEARING MODULE - PHOTOS AND INSTALLATION SKILL LEVELS

HUB UNIT BEARING / BEARING MODULE TECHNOLOGY

<p>513100</p>  <p>Skill Level B</p>	<p>513104</p>  <p>Skill Level B</p>	<p>513105</p>  <p>Skill Level B</p>
<p>513107</p>  <p>Skill Level B</p>	<p>513109</p>  <p>Skill Level B</p>	<p>513111</p>  <p>Skill Level B</p>
<p>513115</p>  <p>Skill Level B</p>	<p>513121</p>  <p>Skill Level B</p>	<p>513122</p>  <p>Skill Level B</p>

**HUB UNIT BEARING / BEARING MODULE -
PHOTOS AND INSTALLATION SKILL LEVELS**

<p>513123</p>  <p>Skill Level B</p>	<p>513124</p>  <p>Skill Level B</p>	<p>513125</p>  <p>Skill Level B</p>
<p>513126</p>  <p>Skill Level B</p>	<p>513127</p>  <p>Skill Level B</p>	<p>513128</p>  <p>Skill Level B</p>
<p>513131</p>  <p>Skill Level B</p>	<p>513132</p>  <p>Skill Level B</p>	<p>513133</p>  <p>Skill Level B</p>

HUB UNIT BEARING / BEARING MODULE - PHOTOS AND INSTALLATION SKILL LEVELS

HUB UNIT BEARING / BEARING MODULE TECHNOLOGY

<p>513135</p>  <p>Skill Level A</p>	<p>513137</p>  <p>Skill Level B</p>	<p>513138</p>  <p>Skill Level B</p>
<p>513139</p>  <p>Skill Level B</p>	<p>513142</p>  <p>Skill Level B</p>	<p>513152</p>  <p>Skill Level B</p>
<p>513155</p>  <p>Skill Level B</p>	<p>513156</p>  <p>Skill Level B</p>	<p>513157</p>  <p>Skill Level B</p>

HUB UNIT BEARING / BEARING MODULE - PHOTOS AND INSTALLATION SKILL LEVELS

513173	513175	513179
 <p data-bbox="493 890 610 915">Skill Level B</p>	 <p data-bbox="940 890 1057 915">Skill Level B</p>	 <p data-bbox="1386 890 1503 915">Skill Level B</p>
513186	513187	513188
 <p data-bbox="493 1398 610 1423">Skill Level B</p>	 <p data-bbox="940 1398 1057 1423">Skill Level B</p>	 <p data-bbox="1386 1398 1503 1423">Skill Level B</p>
513189	513190	513191
 <p data-bbox="493 1917 610 1942">Skill Level B</p>	 <p data-bbox="940 1917 1057 1942">Skill Level B</p>	 <p data-bbox="1386 1917 1503 1942">Skill Level B</p>

HUB UNIT BEARING / BEARING MODULE TECHNOLOGY

HUB UNIT BEARING / BEARING MODULE - PHOTOS AND INSTALLATION SKILL LEVELS

513192



Skill Level B

513193



Skill Level B

513194



Skill Level B

513196



Skill Level B

513202



Skill Level B

513226



Skill Level B

513230



Skill Level B

513256



Skill Level B

513266



Skill Level B

HUB UNIT BEARING / BEARING MODULE - PHOTOS AND INSTALLATION SKILL LEVELS

515000	515001	515002
 <p data-bbox="496 890 613 915">Skill Level B</p>	 <p data-bbox="940 890 1057 915">Skill Level B</p>	 <p data-bbox="1386 890 1503 915">Skill Level B</p>
515005	515006	515014
 <p data-bbox="496 1402 613 1428">Skill Level B</p>	 <p data-bbox="940 1402 1057 1428">Skill Level B</p>	 <p data-bbox="1386 1402 1503 1428">Skill Level B</p>
515017	515020	515021
 <p data-bbox="496 1919 613 1944">Skill Level B</p>	 <p data-bbox="940 1919 1057 1944">Skill Level B</p>	 <p data-bbox="1386 1919 1503 1944">Skill Level B</p>









HUB UNIT BEARING / BEARING MODULE TECHNOLOGY

HUB UNIT BEARING / BEARING MODULE - PHOTOS AND INSTALLATION SKILL LEVELS

HUB UNIT BEARING / BEARING MODULE TECHNOLOGY

<p>515022</p>  <p>Skill Level B</p>	<p>515025</p>  <p>Skill Level B</p>	<p>515026</p>  <p>Skill Level B</p>
<p>515027</p>  <p>Skill Level B</p>	<p>515028</p>  <p>Skill Level B</p>	<p>515029</p>  <p>Skill Level B</p>
<p>515030</p>  <p>Skill Level B</p>	<p>515031</p>  <p>Skill Level B</p>	<p>518500</p>  <p>Skill Level B</p>

**HUB UNIT BEARING / BEARING MODULE -
PHOTOS AND INSTALLATION SKILL LEVELS**

518501	518502	518503
 <p data-bbox="493 890 613 915">Skill Level B</p>	 <p data-bbox="938 890 1058 915">Skill Level B</p>	 <p data-bbox="1383 890 1503 915">Skill Level A</p>
518504	518505	518506
 <p data-bbox="493 1402 613 1428">Skill Level A</p>	 <p data-bbox="938 1402 1058 1428">Skill Level A</p>	 <p data-bbox="1383 1402 1503 1428">Skill Level A</p>
518507	520000	520100
 <p data-bbox="493 1919 613 1944">Skill Level A</p>	 <p data-bbox="938 1919 1058 1944">Skill Level A</p>	 <p data-bbox="1383 1919 1503 1944">Skill Level A</p>

HUB UNIT BEARING / BEARING MODULE - PHOTOS AND INSTALLATION SKILL LEVELS

HUB UNIT BEARING / BEARING MODULE TECHNOLOGY

BM500000	BM500001	BM500002
 <p data-bbox="399 890 516 915">Skill Level A</p>	 <p data-bbox="846 890 963 915">Skill Level A</p>	 <p data-bbox="1292 890 1409 915">Skill Level A</p>
BM500003	BM500004	BM500005
 <p data-bbox="399 1402 516 1428">Skill Level A</p>	 <p data-bbox="846 1402 963 1428">Skill Level A</p>	 <p data-bbox="1292 1402 1409 1428">Skill Level A</p>
BM500006	BM500007	BM500009
 <p data-bbox="399 1919 516 1944">Skill Level A</p>	 <p data-bbox="846 1919 963 1944">Skill Level A</p>	 <p data-bbox="1292 1919 1409 1944">Skill Level A</p>

HUB UNIT BEARING / BEARING MODULE - PHOTOS AND INSTALLATION SKILL LEVELS

BM500010	BM500012	BM500013
 <p data-bbox="496 890 613 915">Skill Level A</p>	 <p data-bbox="943 890 1060 915">Skill Level A</p>	 <p data-bbox="1386 890 1503 915">Skill Level A</p>
BM500014	BM500015	BM500016
 <p data-bbox="496 1404 613 1430">Skill Level A</p>	 <p data-bbox="943 1404 1060 1430">Skill Level A</p>	 <p data-bbox="1386 1404 1503 1430">Skill Level A</p>
BM500017	BM500018	BM500019
 <p data-bbox="496 1919 613 1944">Skill Level A</p>	 <p data-bbox="943 1919 1060 1944">Skill Level A</p>	 <p data-bbox="1386 1919 1503 1944">Skill Level A</p>

HUB UNIT BEARING / BEARING MODULE - PHOTOS AND INSTALLATION SKILL LEVELS

HUB UNIT BEARING / BEARING MODULE TECHNOLOGY

BM500022	BM500029	BM500030
 <p data-bbox="397 892 511 919">Skill Level A</p>	 <p data-bbox="844 892 958 919">Skill Level A</p>	 <p data-bbox="1291 892 1404 919">Skill Level A</p>
BM513161	HA500100	HA500601
 <p data-bbox="397 1407 511 1434">Skill Level A</p>	 <p data-bbox="844 1407 958 1434">Skill Level B</p>	 <p data-bbox="1291 1407 1404 1434">Skill Level B</p>
HA500701	HA590000	HA590001
 <p data-bbox="397 1921 511 1948">Skill Level B</p>	 <p data-bbox="844 1921 958 1948">Skill Level B</p>	 <p data-bbox="1291 1921 1404 1948">Skill Level B</p>

HUB UNIT BEARING / BEARING MODULE - PHOTOS AND INSTALLATION SKILL LEVELS

HA590002	HA590003	HA590004
 <p data-bbox="495 892 609 919">Skill Level B</p>	 <p data-bbox="933 892 1047 919">Skill Level B</p>	 <p data-bbox="1380 892 1494 919">Skill Level B</p>
HA590005	HA590006	HA590007
 <p data-bbox="495 1407 609 1434">Skill Level B</p>	 <p data-bbox="933 1407 1047 1434">Skill Level B</p>	 <p data-bbox="1380 1407 1494 1434">Skill Level B</p>
HA590008	HA590009	HA590010
 <p data-bbox="495 1921 609 1948">Skill Level B</p>	 <p data-bbox="933 1921 1047 1948">Skill Level B</p>	 <p data-bbox="1380 1921 1494 1948">Skill Level B</p>

HUB UNIT BEARING / BEARING MODULE TECHNOLOGY

HUB UNIT BEARING / BEARING MODULE - PHOTOS AND INSTALLATION SKILL LEVELS

HUB UNIT BEARING / BEARING MODULE TECHNOLOGY

HA590012	HA590013	HA590014
 <p data-bbox="399 890 516 915">Skill Level B</p>	 <p data-bbox="846 890 963 915">Skill Level B</p>	 <p data-bbox="1289 890 1406 915">Skill Level B</p>
HA590016	HA590017	HA590018
 <p data-bbox="399 1404 516 1430">Skill Level B</p>	 <p data-bbox="846 1404 963 1430">Skill Level B</p>	 <p data-bbox="1289 1404 1406 1430">Skill Level B</p>
HA590019	HA590020	HA590021
 <p data-bbox="399 1919 516 1944">Skill Level B</p>	 <p data-bbox="846 1919 963 1944">Skill Level A</p>	 <p data-bbox="1289 1919 1406 1944">Skill Level B</p>

**HUB UNIT BEARING / BEARING MODULE -
PHOTOS AND INSTALLATION SKILL LEVELS**

HA590022	HA590023	HA590024
 <p data-bbox="496 890 613 915">Skill Level B</p>	 <p data-bbox="943 890 1060 915">Skill Level B</p>	 <p data-bbox="1386 890 1503 915">Skill Level B</p>
HA590025	HA590026	HA590027
 <p data-bbox="496 1402 613 1428">Skill Level B</p>	 <p data-bbox="943 1402 1060 1428">Skill Level B</p>	 <p data-bbox="1386 1402 1503 1428">Skill Level B</p>
HA590028	HA590029	HA590030
 <p data-bbox="496 1919 613 1944">Skill Level B</p>	 <p data-bbox="943 1919 1060 1944">Skill Level B</p>	 <p data-bbox="1386 1919 1503 1944">Skill Level B</p>

HUB UNIT BEARING / BEARING MODULE TECHNOLOGY

HUB UNIT BEARING / BEARING MODULE - PHOTOS AND INSTALLATION SKILL LEVELS

HUB UNIT BEARING / BEARING MODULE TECHNOLOGY

HA590031	HA590032	HA590033
 <p data-bbox="399 890 516 915">Skill Level B</p>	 <p data-bbox="846 890 963 915">Skill Level B</p>	 <p data-bbox="1292 890 1409 915">Skill Level B</p>
HA590034	HA590035	HA590036
 <p data-bbox="399 1402 516 1428">Skill Level B</p>	 <p data-bbox="846 1402 963 1428">Skill Level B</p>	 <p data-bbox="1292 1402 1409 1428">Skill Level B</p>
HA590038	HA590039	HA590040
 <p data-bbox="399 1917 516 1942">Skill Level B</p>	 <p data-bbox="846 1917 963 1942">Skill Level B</p>	 <p data-bbox="1292 1917 1409 1942">Skill Level B</p>

**HUB UNIT BEARING / BEARING MODULE -
PHOTOS AND INSTALLATION SKILL LEVELS**

HA590041	HA590043	HA590044
 <p data-bbox="496 890 613 915">Skill Level B</p>	 <p data-bbox="943 890 1060 915">Skill Level B</p>	 <p data-bbox="1386 890 1503 915">Skill Level B</p>
HA590045	HA590046	HA590047
 <p data-bbox="496 1404 613 1430">Skill Level B</p>	 <p data-bbox="943 1404 1060 1430">Skill Level B</p>	 <p data-bbox="1386 1404 1503 1430">Skill Level B</p>
HA590048	HA590049	HA590050
 <p data-bbox="496 1919 613 1944">Skill Level B</p>	 <p data-bbox="943 1919 1060 1944">Skill Level B</p>	 <p data-bbox="1386 1919 1503 1944">Skill Level A</p>

HUB UNIT BEARING / BEARING MODULE TECHNOLOGY

HUB UNIT BEARING / BEARING MODULE - PHOTOS AND INSTALLATION SKILL LEVELS

HUB UNIT BEARING / BEARING MODULE TECHNOLOGY

HA590052	HA590053	HA590054
 <p>Skill Level B</p>	 <p>Skill Level B</p>	 <p>Skill Level B</p>
HA590055	HA590055K	HA590056
 <p>Skill Level B</p>	 <p>Skill Level B</p>	 <p>Skill Level B</p>
HA590056K	HA590057	HA590058
 <p>Skill Level B</p>	 <p>Skill Level B</p>	 <p>Skill Level B</p>

**HUB UNIT BEARING / BEARING MODULE -
PHOTOS AND INSTALLATION SKILL LEVELS**









HA590059	HA590060	HA590061
 <p data-bbox="496 890 610 915">Skill Level B</p>	 <p data-bbox="938 890 1052 915">Skill Level B</p>	 <p data-bbox="1386 890 1500 915">Skill Level B</p>
HA590062	HA590063	HA590064
 <p data-bbox="496 1404 610 1430">Skill Level B</p>	 <p data-bbox="938 1404 1052 1430">Skill Level B</p>	 <p data-bbox="1386 1404 1500 1430">Skill Level B</p>
HA590065	HA590066	HA590067
 <p data-bbox="496 1919 610 1944">Skill Level B</p>	 <p data-bbox="938 1919 1052 1944">Skill Level B</p>	 <p data-bbox="1386 1919 1500 1944">Skill Level B</p>

HUB UNIT BEARING / BEARING MODULE - PHOTOS AND INSTALLATION SKILL LEVELS

HUB UNIT BEARING / BEARING MODULE TECHNOLOGY

HA590068	HA590069	HA590070
 <p>Skill Level B</p>	 <p>Skill Level B</p>	 <p>Skill Level B</p>
HA590071	HA590072	HA590074
 <p>Skill Level B</p>	 <p>Skill Level A</p>	 <p>Skill Level B</p>
HA590075	HA590077	HA590078
 <p>Skill Level B</p>	 <p>Skill Level B</p>	 <p>Skill Level B</p>

HUB UNIT BEARING / BEARING MODULE - PHOTOS AND INSTALLATION SKILL LEVELS

<p>HA590079</p>  <p>Skill Level B</p>	<p>HA590080</p>  <p>Skill Level B</p>	<p>HA590081</p>  <p>Skill Level B</p>
<p>HA590082</p>  <p>Skill Level B</p>	<p>HA590084</p>  <p>Skill Level B</p>	<p>HA590085</p>  <p>Skill Level B</p>
<p>HA590086</p>  <p>Skill Level B</p>	<p>HA590087</p>  <p>Skill Level B</p>	<p>HA590088</p>  <p>Skill Level B</p>

HUB UNIT BEARING / BEARING MODULE TECHNOLOGY

HUB UNIT BEARING / BEARING MODULE - PHOTOS AND INSTALLATION SKILL LEVELS

HA590089	HA590091	HA590092
 <p data-bbox="397 890 516 915">Skill Level B</p>	 <p data-bbox="846 890 964 915">Skill Level B</p>	 <p data-bbox="1291 890 1409 915">Skill Level B</p>
HA590093	HA590095	HA590096
 <p data-bbox="397 1407 516 1432">Skill Level B</p>	 <p data-bbox="846 1407 964 1432">Skill Level B</p>	 <p data-bbox="1291 1407 1409 1432">Skill Level B</p>
HA590097	HA590098	HA590099
 <p data-bbox="397 1919 516 1944">Skill Level A</p>	 <p data-bbox="846 1919 964 1944">Skill Level B</p>	 <p data-bbox="1291 1919 1409 1944">Skill Level B</p>

HUB UNIT BEARING / BEARING MODULE - PHOTOS AND INSTALLATION SKILL LEVELS

HA590100	HA590101	HA590103
 <p data-bbox="496 890 613 915">Skill Level B</p>	 <p data-bbox="940 890 1057 915">Skill Level B</p>	 <p data-bbox="1383 890 1500 915">Skill Level B</p>
HA590104	HA590106	HA590107
 <p data-bbox="496 1400 613 1425">Skill Level B</p>	 <p data-bbox="940 1400 1057 1425">Skill Level B</p>	 <p data-bbox="1383 1400 1500 1425">Skill Level B</p>
HA590108	HA590109	HA590110
 <p data-bbox="496 1917 613 1942">Skill Level B</p>	 <p data-bbox="940 1917 1057 1942">Skill Level B</p>	 <p data-bbox="1383 1917 1500 1942">Skill Level B</p>

HUB UNIT BEARING / BEARING MODULE TECHNOLOGY

HUB UNIT BEARING / BEARING MODULE - PHOTOS AND INSTALLATION SKILL LEVELS

HUB UNIT BEARING / BEARING MODULE TECHNOLOGY

<p>HA590111</p>  <p>Skill Level B</p>	<p>HA590112</p>  <p>Skill Level B</p>	<p>HA590113</p>  <p>Skill Level B</p>
<p>HA590114</p>  <p>Skill Level B</p>	<p>HA590115</p>  <p>Skill Level B</p>	<p>HA590116</p>  <p>Skill Level B</p>
<p>HA590118</p>  <p>Skill Level B</p>	<p>HA590119</p>  <p>Skill Level B</p>	<p>HA590120</p>  <p>Skill Level B</p>







**HUB UNIT BEARING / BEARING MODULE -
PHOTOS AND INSTALLATION SKILL LEVELS**

HA590123	HA590124	HA590125
 <p data-bbox="496 890 610 915">Skill Level B</p>	 <p data-bbox="938 890 1052 915">Skill Level B</p>	 <p data-bbox="1386 890 1500 915">Skill Level B</p>
HA590126	HA590127	HA590128
 <p data-bbox="496 1404 610 1430">Skill Level B</p>	 <p data-bbox="938 1404 1052 1430">Skill Level B</p>	 <p data-bbox="1386 1404 1500 1430">Skill Level B</p>
HA590129	HA590131	HA590132
 <p data-bbox="496 1917 610 1942">Skill Level B</p>	 <p data-bbox="938 1917 1052 1942">Skill Level B</p>	 <p data-bbox="1386 1917 1500 1942">Skill Level B</p>

HUB UNIT BEARING / BEARING MODULE TECHNOLOGY

HUB UNIT BEARING / BEARING MODULE - PHOTOS AND INSTALLATION SKILL LEVELS

HUB UNIT BEARING / BEARING MODULE TECHNOLOGY

HA590136	HA590137	HA590138
 <p data-bbox="399 890 516 915">Skill Level B</p>	 <p data-bbox="846 890 963 915">Skill Level B</p>	 <p data-bbox="1292 890 1409 915">Skill Level B</p>
HA590139	HA590140	HA590141
 <p data-bbox="399 1407 516 1432">Skill Level B</p>	 <p data-bbox="846 1407 963 1432">Skill Level B</p>	 <p data-bbox="1292 1407 1409 1432">Skill Level B</p>
HA590142	HA590143	HA590144
 <p data-bbox="399 1919 516 1944">Skill Level B</p>	 <p data-bbox="846 1919 963 1944">Skill Level B</p>	 <p data-bbox="1292 1919 1409 1944">Skill Level B</p>

**HUB UNIT BEARING / BEARING MODULE -
PHOTOS AND INSTALLATION SKILL LEVELS**

HA590145	HA590146	HA590147
 <p data-bbox="495 892 613 919">Skill Level B</p>	 <p data-bbox="941 892 1060 919">Skill Level B</p>	 <p data-bbox="1388 892 1507 919">Skill Level B</p>
HA590149	HA590150	HA590151
 <p data-bbox="495 1407 613 1434">Skill Level B</p>	 <p data-bbox="941 1407 1060 1434">Skill Level B</p>	 <p data-bbox="1388 1407 1507 1434">Skill Level B</p>
HA590152	HA590153	HA590154
 <p data-bbox="495 1921 613 1948">Skill Level B</p>	 <p data-bbox="941 1921 1060 1948">Skill Level B</p>	 <p data-bbox="1388 1921 1507 1948">Skill Level B</p>

HUB UNIT BEARING / BEARING MODULE TECHNOLOGY

HUB UNIT BEARING / BEARING MODULE - PHOTOS AND INSTALLATION SKILL LEVELS

HUB UNIT BEARING / BEARING MODULE TECHNOLOGY

HA590155	HA590155K	HA590156
 <p>Skill Level B</p>	 <p>Skill Level A</p>	 <p>Skill Level B</p>
HA590156K	HA590157	HA590158
 <p>Skill Level A</p>	 <p>Skill Level B</p>	 <p>Skill Level B</p>
HA590159	HA590160	HA590161
 <p>Skill Level B</p>	 <p>Skill Level B</p>	 <p>Skill Level B</p>

HUB UNIT BEARING / BEARING MODULE - PHOTOS AND INSTALLATION SKILL LEVELS

HA590162	HA590163	HA590164
 <p data-bbox="493 890 613 915">Skill Level B</p>	 <p data-bbox="937 890 1057 915">Skill Level B</p>	 <p data-bbox="1380 890 1500 915">Skill Level B</p>
HA590165	HA590166	HA590167
 <p data-bbox="493 1404 613 1430">Skill Level B</p>	 <p data-bbox="937 1404 1057 1430">Skill Level B</p>	 <p data-bbox="1380 1404 1500 1430">Skill Level B</p>
HA590168	HA590169	HA590170
 <p data-bbox="493 1917 613 1942">Skill Level B</p>	 <p data-bbox="937 1917 1057 1942">Skill Level B</p>	 <p data-bbox="1380 1917 1500 1942">Skill Level B</p>

HUB UNIT BEARING / BEARING MODULE TECHNOLOGY

HUB UNIT BEARING / BEARING MODULE - PHOTOS AND INSTALLATION SKILL LEVELS

HUB UNIT BEARING / BEARING MODULE TECHNOLOGY

HA590171	HA590172	HA590173
 <p data-bbox="399 890 516 915">Skill Level B</p>	 <p data-bbox="841 890 958 915">Skill Level B</p>	 <p data-bbox="1286 890 1403 915">Skill Level B</p>
HA590174	HA590175	HA590176
 <p data-bbox="399 1407 516 1432">Skill Level B</p>	 <p data-bbox="841 1407 958 1432">Skill Level B</p>	 <p data-bbox="1286 1407 1403 1432">Skill Level B</p>
HA590177	HA590178	HA590179
 <p data-bbox="399 1921 516 1946">Skill Level B</p>	 <p data-bbox="841 1921 958 1946">Skill Level B</p>	 <p data-bbox="1286 1921 1403 1946">Skill Level B</p>

**HUB UNIT BEARING / BEARING MODULE -
PHOTOS AND INSTALLATION SKILL LEVELS**

HA590180	HA590181K	HA590182K
 <p data-bbox="496 890 610 915">Skill Level B</p>	 <p data-bbox="943 890 1057 915">Skill Level A</p>	 <p data-bbox="1386 890 1500 915">Skill Level A</p>
HA590183	HA590184	HA590185
 <p data-bbox="496 1409 610 1434">Skill Level B</p>	 <p data-bbox="943 1409 1057 1434">Skill Level B</p>	 <p data-bbox="1386 1409 1500 1434">Skill Level B</p>
HA590186	HA590187	HA590188
 <p data-bbox="496 1919 610 1944">Skill Level B</p>	 <p data-bbox="943 1919 1057 1944">Skill Level B</p>	 <p data-bbox="1386 1919 1500 1944">Skill Level B</p>

HUB UNIT BEARING / BEARING MODULE - PHOTOS AND INSTALLATION SKILL LEVELS

HUB UNIT BEARING / BEARING MODULE TECHNOLOGY

HA590190	HA590192	HA590193
 <p data-bbox="399 890 516 915">Skill Level B</p>	 <p data-bbox="846 890 963 915">Skill Level B</p>	 <p data-bbox="1292 890 1409 915">Skill Level B</p>
HA590194	HA590195	HA590197
 <p data-bbox="399 1402 516 1428">Skill Level B</p>	 <p data-bbox="846 1402 963 1428">Skill Level B</p>	 <p data-bbox="1292 1402 1409 1428">Skill Level B</p>
HA590198	HA590199	HA590200
 <p data-bbox="399 1919 516 1944">Skill Level B</p>	 <p data-bbox="846 1919 963 1944">Skill Level B</p>	 <p data-bbox="1292 1919 1409 1944">Skill Level B</p>

HUB UNIT BEARING / BEARING MODULE - PHOTOS AND INSTALLATION SKILL LEVELS

HA590201	HA590202	HA590203
 <p data-bbox="496 890 613 915">Skill Level B</p>	 <p data-bbox="943 890 1060 915">Skill Level B</p>	 <p data-bbox="1390 890 1507 915">Skill Level B</p>
HA590204	HA590205	HA590206
 <p data-bbox="496 1402 613 1428">Skill Level B</p>	 <p data-bbox="943 1402 1060 1428">Skill Level B</p>	 <p data-bbox="1390 1402 1507 1428">Skill Level B</p>
HA590207	HA590208	HA590209
 <p data-bbox="496 1919 613 1944">Skill Level B</p>	 <p data-bbox="943 1919 1060 1944">Skill Level B</p>	 <p data-bbox="1390 1919 1507 1944">Skill Level B</p>

HUB UNIT BEARING / BEARING MODULE TECHNOLOGY

HUB UNIT BEARING / BEARING MODULE - PHOTOS AND INSTALLATION SKILL LEVELS

HUB UNIT BEARING / BEARING MODULE TECHNOLOGY

HA590212	HA590213	HA590214
 <p data-bbox="399 890 516 915">Skill Level A</p>	 <p data-bbox="846 890 963 915">Skill Level B</p>	 <p data-bbox="1292 890 1409 915">Skill Level B</p>
HA590216	HA590217	HA590218
 <p data-bbox="399 1404 516 1430">Skill Level B</p>	 <p data-bbox="846 1404 963 1430">Skill Level B</p>	 <p data-bbox="1292 1404 1409 1430">Skill Level B</p>
HA590219	HA590220	HA590221
 <p data-bbox="399 1919 516 1944">Skill Level B</p>	 <p data-bbox="846 1919 963 1944">Skill Level B</p>	 <p data-bbox="1292 1919 1409 1944">Skill Level B</p>

HUB UNIT BEARING / BEARING MODULE - PHOTOS AND INSTALLATION SKILL LEVELS









<p>HA590222</p>  <p>Skill Level B</p>	<p>HA590223</p>  <p>Skill Level B</p>	<p>HA590224</p>  <p>Skill Level B</p>
<p>HA590226</p>  <p>Skill Level B</p>	<p>HA590227</p>  <p>Skill Level B</p>	<p>HA590228</p>  <p>Skill Level B</p>
<p>HA590229</p>  <p>Skill Level B</p>	<p>HA590230</p>  <p>Skill Level B</p>	<p>HA590231</p>  <p>Skill Level B</p>

HUB UNIT BEARING / BEARING MODULE TECHNOLOGY

HUB UNIT BEARING / BEARING MODULE - PHOTOS AND INSTALLATION SKILL LEVELS

HA590232	HA590233	HA590234
 <p data-bbox="399 890 516 915">Skill Level B</p>	 <p data-bbox="846 890 963 915">Skill Level B</p>	 <p data-bbox="1289 890 1406 915">Skill Level A</p>
HA590235	HA590236	HA590237
 <p data-bbox="399 1404 516 1430">Skill Level B</p>	 <p data-bbox="846 1404 963 1430">Skill Level B</p>	 <p data-bbox="1289 1404 1406 1430">Skill Level B</p>
HA590238	HA590239	HA590240
 <p data-bbox="399 1919 516 1944">Skill Level B</p>	 <p data-bbox="846 1919 963 1944">Skill Level B</p>	 <p data-bbox="1289 1919 1406 1944">Skill Level B</p>

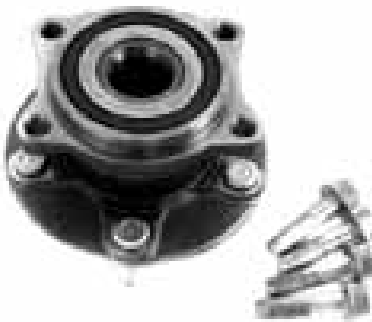
HUB UNIT BEARING / BEARING MODULE - PHOTOS AND INSTALLATION SKILL LEVELS

HA590241	HA590241K	HA590242
 <p data-bbox="495 890 613 915">Skill Level B</p>	 <p data-bbox="941 890 1060 915">Skill Level B</p>	 <p data-bbox="1386 890 1505 915">Skill Level B</p>
HA590243	HA590244	HA590245
 <p data-bbox="495 1404 613 1430">Skill Level B</p>	 <p data-bbox="941 1404 1060 1430">Skill Level B</p>	 <p data-bbox="1386 1404 1505 1430">Skill Level B</p>
HA590247	HA590249	HA590250
 <p data-bbox="495 1919 613 1944">Skill Level B</p>	 <p data-bbox="941 1919 1060 1944">Skill Level B</p>	 <p data-bbox="1386 1919 1505 1944">Skill Level B</p>

HUB UNIT BEARING / BEARING MODULE TECHNOLOGY

HUB UNIT BEARING / BEARING MODULE - PHOTOS AND INSTALLATION SKILL LEVELS

HUB UNIT BEARING / BEARING MODULE TECHNOLOGY

HA590251	HA590252	HA590253
 <p data-bbox="397 892 516 919">Skill Level B</p>	 <p data-bbox="846 892 964 919">Skill Level B</p>	 <p data-bbox="1284 892 1403 919">Skill Level B</p>
HA590254	HA590255	HA590256
 <p data-bbox="397 1407 516 1434">Skill Level B</p>	 <p data-bbox="846 1407 964 1434">Skill Level B</p>	 <p data-bbox="1284 1407 1403 1434">Skill Level B</p>
HA590257	HA590258	HA590259K
 <p data-bbox="397 1921 516 1948">Skill Level B</p>	 <p data-bbox="846 1921 964 1948">Skill Level B</p>	 <p data-bbox="1284 1921 1403 1948">Skill Level A</p>









**HUB UNIT BEARING / BEARING MODULE -
PHOTOS AND INSTALLATION SKILL LEVELS**

<p>HA590260</p>  <p>Skill Level B</p>	<p>HA590261</p>  <p>Skill Level B</p>	<p>HA590262</p>  <p>Skill Level B</p>
<p>HA590263K</p>  <p>Skill Level A</p>	<p>HA590264</p>  <p>Skill Level B</p>	<p>HA590265</p>  <p>Skill Level B</p>
<p>HA590267</p>  <p>Skill Level B</p>	<p>HA590269</p>  <p>Skill Level B</p>	<p>HA590270</p>  <p>Skill Level B</p>

HUB UNIT BEARING / BEARING MODULE TECHNOLOGY

HUB UNIT BEARING / BEARING MODULE - PHOTOS AND INSTALLATION SKILL LEVELS

HUB UNIT BEARING / BEARING MODULE TECHNOLOGY

HA590271	HA590273	HA590274
 <p data-bbox="397 890 516 915">Skill Level B</p>	 <p data-bbox="846 890 964 915">Skill Level B</p>	 <p data-bbox="1292 890 1411 915">Skill Level B</p>
HA590275	HA590276	HA590277
 <p data-bbox="397 1404 516 1430">Skill Level A</p>	 <p data-bbox="846 1404 964 1430">Skill Level B</p>	 <p data-bbox="1292 1404 1411 1430">Skill Level B</p>
HA590278	HA590279	HA590280
 <p data-bbox="397 1919 516 1944">Skill Level B</p>	 <p data-bbox="846 1919 964 1944">Skill Level B</p>	 <p data-bbox="1292 1919 1411 1944">Skill Level B</p>

**HUB UNIT BEARING / BEARING MODULE -
PHOTOS AND INSTALLATION SKILL LEVELS**

<p>HA590281</p>  <p>Skill Level B</p>	<p>HA590284</p>  <p>Skill Level B</p>	<p>HA590285</p>  <p>Skill Level B</p>
<p>HA590286</p>  <p>Skill Level B</p>	<p>HA590286K</p>  <p>Skill Level A</p>	<p>HA590287</p>  <p>Skill Level B</p>
<p>HA590288</p>  <p>Skill Level B</p>	<p>HA590289</p>  <p>Skill Level B</p>	<p>HA590299</p>  <p>Skill Level B</p>

HUB UNIT BEARING / BEARING MODULE TECHNOLOGY

HUB UNIT BEARING / BEARING MODULE - PHOTOS AND INSTALLATION SKILL LEVELS

HUB UNIT BEARING / BEARING MODULE TECHNOLOGY

HA590300	HA590301K	HA590302K
 <p data-bbox="402 890 516 915">Skill Level B</p>	 <p data-bbox="846 890 959 915">Skill Level A</p>	 <p data-bbox="1289 890 1403 915">Skill Level A</p>
HA590303K	HA590304	HA590305
 <p data-bbox="402 1404 516 1430">Skill Level A</p>	 <p data-bbox="846 1404 959 1430">Skill Level B</p>	 <p data-bbox="1289 1404 1403 1430">Skill Level B</p>
HA590306	HA590307	HA590308
 <p data-bbox="402 1919 516 1944">Skill Level B</p>	 <p data-bbox="846 1919 959 1944">Skill Level B</p>	 <p data-bbox="1289 1919 1403 1944">Skill Level B</p>

HUB UNIT BEARING / BEARING MODULE - PHOTOS AND INSTALLATION SKILL LEVELS

<p>HA590310</p>  <p>Skill Level B</p>	<p>HA590311</p>  <p>Skill Level B</p>	<p>HA590312</p>  <p>Skill Level B</p>
<p>HA590313</p>  <p>Skill Level B</p>	<p>HA590314</p>  <p>Skill Level B</p>	<p>HA590315</p>  <p>Skill Level B</p>
<p>HA590316</p>  <p>Skill Level B</p>	<p>HA590317</p>  <p>Skill Level B</p>	<p>HA590321</p>  <p>Skill Level B</p>

HUB UNIT BEARING / BEARING MODULE - PHOTOS AND INSTALLATION SKILL LEVELS

HA590322



Skill Level B

HA590323



Skill Level A

HA590324



Skill Level B

HA590325



Skill Level B

HA590326



Skill Level B

HA590327



Skill Level B

HA590335



Skill Level B

HA590336



Skill Level B

HA590337



Skill Level B

**HUB UNIT BEARING / BEARING MODULE -
PHOTOS AND INSTALLATION SKILL LEVELS**

<p>HA590338</p>  <p>Skill Level B</p>	<p>HA590352</p>  <p>Skill Level B</p>	<p>HA590353</p>  <p>Skill Level B</p>
<p>HA590370</p>  <p>Skill Level B</p>	<p>HA590371</p>  <p>Skill Level B</p>	<p>HA590389</p>  <p>Skill Level B</p>
<p>HA590425</p>  <p>Skill Level B</p>	<p>HA590503</p>  <p>Skill Level B</p>	<p>HA590644</p>  <p>Skill Level B</p>

HUB UNIT BEARING / BEARING MODULE TECHNOLOGY

HUB UNIT BEARING / BEARING MODULE - PHOTOS AND INSTALLATION SKILL LEVELS

<p>HA590653</p>  <p>Skill Level B</p>	<p>HA591050</p>  <p>Skill Level B</p>	<p>HA591080</p>  <p>Skill Level B</p>
<p>HA591339</p>  <p>Skill Level A</p>	<p>HA592210</p>  <p>Skill Level A</p>	<p>HA592410</p>  <p>Skill Level B</p>
<p>HA592450</p>  <p>Skill Level B</p>	<p>HA592451</p>  <p>Skill Level B</p>	<p>HA592460</p>  <p>Skill Level B</p>

HUB UNIT BEARING / BEARING MODULE - PHOTOS AND INSTALLATION SKILL LEVELS

<p>HA592461</p>  <p>Skill Level B</p>	<p>HA592519</p>  <p>Skill Level B</p>	<p>HA593427</p>  <p>Skill Level B</p>
<p>HA593550</p>  <p>Skill Level B</p>	<p>HA594181</p>  <p>Skill Level B</p>	<p>HA594241</p>  <p>Skill Level B</p>
<p>HA594245</p>  <p>Skill Level B</p>	<p>HA594246</p>  <p>Skill Level A</p>	<p>HA594301</p>  <p>Skill Level A</p>

HUB UNIT BEARING / BEARING MODULE - PHOTOS AND INSTALLATION SKILL LEVELS

HUB UNIT BEARING / BEARING MODULE TECHNOLOGY

HA594460K	HA594504	HA594505
 <p>Skill Level A</p>	 <p>Skill Level B</p>	 <p>Skill Level B</p>
HA595017	HA595894	HA596030
 <p>Skill Level B</p>	 <p>Skill Level B</p>	 <p>Skill Level B</p>
HA596467	HA597449	HA597851
 <p>Skill Level B</p>	 <p>Skill Level B</p>	 <p>Skill Level A</p>









HUB UNIT BEARING / BEARING MODULE - PHOTOS AND INSTALLATION SKILL LEVELS

HA597957	HA598679	HA599138
 <p data-bbox="495 892 609 919">Skill Level B</p>	 <p data-bbox="938 892 1052 919">Skill Level B</p>	 <p data-bbox="1388 892 1502 919">Skill Level A</p>
HA599361	HA599406	HA599455L
 <p data-bbox="495 1407 609 1434">Skill Level B</p>	 <p data-bbox="938 1407 1052 1434">Skill Level B</p>	 <p data-bbox="1388 1407 1502 1434">Skill Level B</p>
HA599455R	HA599467	HA599528
 <p data-bbox="495 1921 609 1948">Skill Level B</p>	 <p data-bbox="938 1921 1052 1948">Skill Level B</p>	 <p data-bbox="1388 1921 1502 1948">Skill Level B</p>









HUB UNIT BEARING / BEARING MODULE TECHNOLOGY

HUB UNIT BEARING / BEARING MODULE - PHOTOS AND INSTALLATION SKILL LEVELS

HUB UNIT BEARING / BEARING MODULE TECHNOLOGY









<p>HA599863</p>  <p>Skill Level B</p>	<p>SP450100</p>  <p>Skill Level B</p>	<p>SP450101</p>  <p>Skill Level B</p>
<p>SP450200</p>  <p>Skill Level B</p>	<p>SP450201</p>  <p>Skill Level B</p>	<p>SP450202</p>  <p>Skill Level B</p>
<p>SP450203</p>  <p>Skill Level B</p>	<p>SP450300</p>  <p>Skill Level B</p>	<p>SP450301</p>  <p>Skill Level B</p>

**HUB UNIT BEARING / BEARING MODULE -
PHOTOS AND INSTALLATION SKILL LEVELS**









SP450701	SP450702	SP470201
 <p data-bbox="493 890 612 915">Skill Level B</p>	 <p data-bbox="940 890 1058 915">Skill Level B</p>	 <p data-bbox="1386 890 1505 915">Skill Level B</p>
SP500100	SP500101	SP500300
 <p data-bbox="493 1404 612 1430">Skill Level B</p>	 <p data-bbox="940 1404 1058 1430">Skill Level B</p>	 <p data-bbox="1386 1404 1505 1430">Skill Level B</p>
SP500701	SP500702	SP500703
 <p data-bbox="493 1919 612 1944">Skill Level B</p>	 <p data-bbox="940 1919 1058 1944">Skill Level B</p>	 <p data-bbox="1386 1919 1505 1944">Skill Level B</p>

HUB UNIT BEARING / BEARING MODULE - PHOTOS AND INSTALLATION SKILL LEVELS

HUB UNIT BEARING / BEARING MODULE TECHNOLOGY

<p>SP550100</p>  <p>Skill Level B</p>	<p>SP550101</p>  <p>Skill Level B</p>	<p>SP550102</p>  <p>Skill Level B</p>
<p>SP550103</p>  <p>Skill Level B</p>	<p>SP550104</p>  <p>Skill Level B</p>	<p>SP550200</p>  <p>Skill Level B</p>
<p>SP550201</p>  <p>Skill Level B</p>	<p>SP550202</p>  <p>Skill Level B</p>	<p>SP550203</p>  <p>Skill Level B</p>









HUB UNIT BEARING / BEARING MODULE - PHOTOS AND INSTALLATION SKILL LEVELS

<p>SP550206</p>  <p>Skill Level B</p>	<p>SP550207</p>  <p>Skill Level B</p>	<p>SP550208</p>  <p>Skill Level B</p>
<p>SP550209</p>  <p>Skill Level B</p>	<p>SP550210</p>  <p>Skill Level B</p>	<p>SP550211</p>  <p>Skill Level B</p>
<p>SP550212</p>  <p>Skill Level B</p>	<p>SP550214</p>  <p>Skill Level B</p>	<p>SP550215</p>  <p>Skill Level B</p>





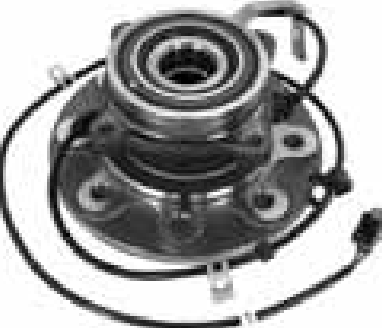



HUB UNIT BEARING / BEARING MODULE TECHNOLOGY

HUB UNIT BEARING / BEARING MODULE - PHOTOS AND INSTALLATION SKILL LEVELS

HUB UNIT BEARING / BEARING MODULE TECHNOLOGY

SP550216	SP550307	SP550308
 <p data-bbox="402 890 516 915">Skill Level B</p>	 <p data-bbox="846 890 959 915">Skill Level B</p>	 <p data-bbox="1295 890 1409 915">Skill Level B</p>
SP550309	SP550310	SP550311
 <p data-bbox="402 1402 516 1428">Skill Level B</p>	 <p data-bbox="846 1402 959 1428">Skill Level B</p>	 <p data-bbox="1295 1402 1409 1428">Skill Level B</p>
SP580100	SP580101	SP580102
 <p data-bbox="402 1919 516 1944">Skill Level A</p>	 <p data-bbox="846 1919 959 1944">Skill Level A</p>	 <p data-bbox="1295 1919 1409 1944">Skill Level A</p>

HUB UNIT BEARING / BEARING MODULE - PHOTOS AND INSTALLATION SKILL LEVELS

<p>SP580103</p>  <p>Skill Level A</p>	<p>SP580204</p>  <p>Skill Level B</p>	<p>SP580205</p>  <p>Skill Level B</p>
<p>SP580300</p>  <p>Skill Level A</p>	<p>SP580301</p>  <p>Skill Level A</p>	<p>SP580302</p>  <p>Skill Level A</p>
<p>SP580303</p>  <p>Skill Level A</p>	<p>SP580304</p>  <p>Skill Level B</p>	<p>SP580310</p>  <p>Skill Level B</p>

HUB UNIT BEARING / BEARING MODULE TECHNOLOGY

HUB UNIT BEARING / BEARING MODULE - PHOTOS AND INSTALLATION SKILL LEVELS

HUB UNIT BEARING / BEARING MODULE TECHNOLOGY

SP580311	SP580312	SP580313
 <p>Skill Level B</p>	 <p>Skill Level B</p>	 <p>Skill Level B</p>
SP940200	SP940201	SP940202
 <p>Skill Level B</p>	 <p>Skill Level B</p>	 <p>Skill Level B</p>
SP940203	SP940204	
 <p>Skill Level B</p>	 <p>Skill Level B</p>	

REMOVING AND INSTALLING A HUB UNIT BEARING



Timken continues to lead the hub evolution by manufacturing hub unit bearings that are uncompromised in quality, reliability and consistency. Proper hub unit bearing removal and installation procedures can enhance the performance and life of hubs, axles, wheels, brakes and other components. Following are general recommendations for removing and installing hub unit bearings.

Hub Unit Bearing Removal

1. Raise vehicle and remove lug nuts and wheel.



2. Remove the brake caliper and rotor. The brake caliper should be supported, not hanging freely.

3. Remove the axle nut using an axle nut socket. Use the vehicle manufacturer's instructions regarding nut replacement.



4. If applicable, disconnect the ABS sensor wire from its mating connector point usually located in the wheel well or on the chassis frame. Also, disconnect the sensor wire from the clips that are used to properly position the

sensor wire in the wheel well or frame. Before removing, make a note of the proper orientation and positioning of the sensor wire and bearing.

5. Remove the bolts that attach the bearing to the steering knuckle. A puller may be required to remove the hub unit bearing from the knuckle. Care should be taken not to damage the knuckle or axle shaft.

6. Clean and inspect the steering knuckle. Use a fine file, wire brush, emery cloth or honing stone as appropriate to remove any debris, nicks or burrs.

continued

Hub Unit Bearing Installation



1. First, insert the new hub unit bearing into the steering knuckle. Check the positioning of the splines on the axle shaft as the hub unit bearing is inserted into the knuckle.

Note: Carefully position the

two components so the splines are not damaged during this process. Never force the hub assembly on the shaft or strike with a hammer.

2. Torque the knuckle-bearing mounting bolts to the vehicle manufacturer's specification using a torque wrench. An impact wrench is not recommended because it does not reliably impart the proper torque.

3. If applicable, connect the new ABS sensor that comes already attached to the new bearing to its mating connection point and clips in the wheel well and frame area.



impart the proper torque.

4. Install the axle nut. Tighten the nut to the vehicle manufacturer's torque specification using a torque wrench. An impact wrench is not recommended because it does not reliably



5. Replace the brake rotor and brake caliper. All components should be clean from debris and burrs.

recommendations regarding torque specification and retorquing requirements.

6. Replace the wheel and torque the lug nuts. Follow the vehicle manufacturer's

⚠ WARNING *Failure to observe the following warnings could create a risk of serious injury.*

Proper maintenance and handling procedures are critical. Always follow installation instructions and maintain proper lubrication.
Never spin a bearing with compressed air. The rolling elements may be forcefully expelled.

This information is not intended to substitute for the specific recommendations of your equipment suppliers. Every reasonable effort has been made to ensure the accuracy of the information contained in this writing, but no liability is accepted for errors, omissions or for any other reason.

This information was originally presented in Automotive TechTips Volume 1, Issue 1 (2008).

REMOVIENDO E INSTALANDO UN ENSAMBLE DE MAZA



Timken se mantiene como líder en la evolución de la maza diseñando y manufacturando ensambles que destacan por su calidad, confiabilidad y desempeño. El correcto procedimiento de montaje y desmontaje ayuda a mejorar la vida desempeño de las mazas, ejes, llantas, frenos y algunos otros componentes que forman parte del sistema de las ruedas. A continuación te presentamos algunas recomendaciones generales para remover e instalar adecuadamente los ensambles de mazas.

Desmontaje De La Maza

1. Levanta el vehículo y retira los birlos y la llanta.



2. Retira el rotor y el caliper de los frenos, el caliper del freno debe quedar sujeto y no colgando.

3. Remueve la tuerca del eje utilizando una llave de tuercas para eje. Revisa las recomendaciones del fabricante respecto al reemplazo de tuercas.



4. Si aplica, desconecta el cable del sensor del sistema ABS de su punto conector, generalmente localizado en el soporte de la rueda o en el

marco del chasis. También desconecta el cable del sensor de los clips que se utilizan para posicionarlo correctamente en el soporte de la rueda o en el marco. Antes de retirarlo, revisa la orientación correcta y posicionamiento del cable del sensor y del rodamiento.

5. Retira los tornillos que sujetan el rodamiento al manguito de la dirección. Ayúdate con un extractor para remover la maza del manguito. Ten mucho cuidado de no dañar al manguito o a la flecha del eje.

6. Limpia bien el manguito de la dirección de cualquier rebaba o basura.

continued

Instalación De La Maza



1. Inserta el ensamble de maza nuevo dentro del manguito de dirección. Revisa la posición de las ranuras longitudinales en la flecha del eje mientras insertas la maza. Coloca los dos componentes para que

las ranuras longitudinales no se dañen durante la instalación de la maza. Importante: nunca forces la maza para meterla en el eje y mucho menos la golpees con un martillo.

2. Aprieta los tornillos de montaje del rodamiento en el manguito de acuerdo a las especificaciones descritas por el fabricante del vehículo. No uses llaves de impacto (pistolas neumáticas), se requiere el torque adecuado recomendado por el fabricante.

3. Si aplica, conecta el nuevo sensor del sistema de frenos ABS que ya viene junto con el en su punto de contacto correspondiente y fija al soporte de la rueda.



4. Instala la tuerca del eje. Aprieta la tuerca conforme a las especificaciones del fabricante utilizando una llave torquímetro. No uses llaves de impacto (pistolas neumáticas), se requiere el torque adecuado recomendado por el fabricante.



5. Coloca el rotor y el caliper del freno. Antes de reinstalar cualquier componente debes de limpiarlos bien y retirar toda rebaba y basura.

6. Coloca la llanta y ajusta sus tuercas. Sigue las recomendaciones del fabricante respecto a las especificaciones de apriete.

⚠ ADVERTENCIA Ignorar estas advertencias puede crear el riesgo de daños severos

Las prácticas de manejo y mantenimiento son críticas. Siga siempre las instrucciones de instalación y mantenga la lubricación apropiada. Nunca gire un rodamiento con aire comprimido. Los elementos rodantes pueden salir expulsados.

Esta información no pretende sustituir las recomendaciones específicas de los proveedores de sus equipos.

Hemos hecho un gran esfuerzo para asegurar la exactitud de la información contenida en el presente, sin embargo, no nos hacemos responsables por errores, omisiones o por cualquier otra razón.

Esta información fue originalmente presentada en el TechTips Automotriz Volumen 1, Número 1 (2008).

CHECKING A HUB UNIT BEARING



It can be a challenging task to properly diagnose a damaged hub unit bearing. This information will help you to recognize common causes of noise generation and know how to examine a hub unit bearing.

Sources of Unfamiliar Noises:

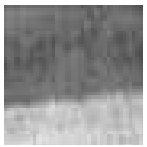

Roads with uneven characteristics



Tread design

Often this can be attributed to road surface conditions such as newly paved roads or roads with uneven surface characteristics, which can cause unusual and intensified noises. The tread design, composition and wear patterns of vehicle tires can be another source of unfamiliar noise. Unusual wear patterns are generally caused by lack of tire rotation, poor alignment, improper pressure or worn suspension parts. After eliminating noise generation caused by road surface conditions, tire design and wear patterns, it's time to make a more detailed examination of the wheel assemblies as well as the hub unit bearings.



1. The first step is to verify the source of any unfamiliar noise. Often this can be attributed to road surface conditions such as newly paved roads or roads with uneven surface characteristics, which can cause unusual and intensified noises. The tread design, composition and wear patterns of vehicle tires can be another source of unfamiliar noise. Unusual wear patterns are generally caused by lack of tire rotation, poor alignment, improper pressure or worn suspension parts. After eliminating noise generation caused by road surface conditions, tire design and wear patterns, it's time to make a more detailed examination of the wheel assemblies as well as the hub unit bearings.
2. Prior to checking a hub unit bearing, make sure you have the proper tools.



3. Perform a hand rotation check on the wheel. Next, grasp the wheel at the 3 o'clock and 9 o'clock positions. Push while oscillating and also pull while oscillating the wheel. Perform a second check, following this same procedure, grasping the wheel at the 12 and 6 o'clock positions. In addition, listen and feel for roughness. After making all preliminary inspections, check the hub unit bearing more precisely.

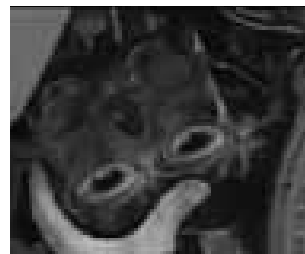

4. If applicable, remove the wheel cover to access the lug nuts. Remove the lug nuts and the wheel and tire assembly. Next, remove the caliper from the caliper mounting bracket. To prevent damage to the brake line due to the weight of the caliper, make sure the caliper is properly supported with either an "S" hook or a piece of wire.



5. Remove the caliper mounting bracket and then remove the brake rotor.

continued



6. Rotate the hub unit bearing by hand. Bearings normally do not loosen up under typical use. If the hub unit bearing appears to be loose the bearing may be damaged, the axle nut may have backed off, or the axle nut may not have been

properly clamped. Any roughness, looseness or noise from the bearing is an indication that the bearing is damaged and needs to be replaced.



7. To check a hub unit bearing's internal clearance, a dial indicator with a magnetic base is required. To obtain accurate readings from the dial indicator it is important to thoroughly clean and smooth the surfaces where the dial

indicator base and tip will be placed. Carefully use a fine file, wire brush, emery cloth or honing stone as appropriate to remove any debris, nicks or burrs.

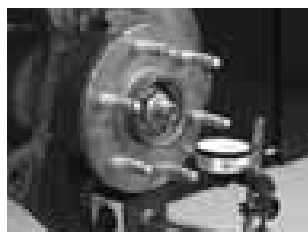

8. The dial indicator base should be placed rigidly on the knuckle or a secure portion of the suspension. When setting the dial indicator tip, the indicator itself should have

ample travel for the variation around the face. Position the indicator tip perpendicular on the wheel pilot as close to the center of the hub unit bearing as possible. This will provide the most accurate results.



9. Grasp the wheel flange at the 3 o'clock and 9 o'clock positions, and push while oscillating the hub unit bearing approximately 90° side-to-side at least five times. Set the dial indicator to zero. Next, pull while oscillating the hub unit

bearing approximately 90° side-to-side at least five times. Proper loading and oscillation is necessary in order to fully seat the bearings.



10. Observe the total indicator movement. If it exceeds 0.004", replace the hub unit bearing.

⚠ WARNING Failure to observe the following warnings could create a risk of serious injury.

Proper maintenance and handling procedures are critical. Always follow installation instructions and maintain proper lubrication.

Never spin a bearing with compressed air. The rolling elements may be forcefully expelled.

This information is not intended to substitute for the specific recommendations of your equipment suppliers.

Every reasonable effort has been made to ensure the accuracy of the information contained in this writing, but no liability is accepted for errors, omissions or for any other reason.

This information was originally presented in Automotive TechTips Volume 3, Issue 1 (2004).

REVISANDO UN ENSAMBLE DE MAZA



Diagnosticar apropiadamente un ensamble de maza dañado puede ser todo un reto. Esta información le ayudará a reconocer las causas comunes generadoras de ruidos y aprenderá a examinar correctamente un ensamble de maza.

1. El primer paso es detectar el origen de cualquier ruido que Fuentes de ruidos extraños:

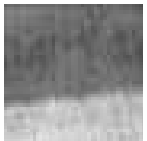

Pavimentos con superficies irregulares



Dibujo de la llanta

no sea familiar. Comúnmente, se atribuye a las condiciones del pavimento, como calles recién pavimentadas o irregularidades en la superficie que provocan ruidos inusuales y bastante notorios. El dibujo de las llantas, su composición y patrones de desgaste son también fuente de ruidos extraños.

El patrón irregular de una llanta es causado, generalmente, por falta de rotación de la rueda, mala alineación, presión incorrecta o desgaste en alguno de los componentes de la suspensión. Después de eliminar éstas causas como generadoras de ruido, es necesario examinar detalladamente el sistema de la rueda y el ensamble de la maza.

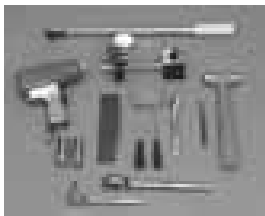

2. Antes de iniciar la revisión de la maza asegúrese de tener a la mano la herramienta adecuada.



3. Realice una rotación manual de la llanta. Sujete la llanta colocando las manos en las posiciones de las 3:00 y las 9:00 de las manecillas del reloj. Empuje y jale la llanta mientras la gira. Haga una segunda revisión, pero ahora sujetando

la rueda en las posiciones de las 12:00 y las 6:00. Revise que no haya resistencia o que no raspen los componentes. Después de esta inspección preliminar proceda a examinar el ensamble de la maza.



4. Quite el tapón de la rueda, saque los birlos y retire la llanta. Quite el caliper de su soporte. Para no dañar el cable del freno con el peso del caliper, sujételo con un gancho "S" o con un pedazo de alambre.



5. Retire el soporte del caliper y después el rotor del freno.

continued



6. Gire con la mano el ensamble de la maza. Normalmente el rodamiento de la maza no se afloja con el uso común. Si se encuentra flojo, puede ser que esté dañado, que la tuerca del eje se haya barrido o que haya sido

apretada incorrectamente. Cualquier roce, ruido o aflojamiento en el rodamiento indica que se encuentra dañado y que necesita reemplazarse.



7. Para revisar el juego lateral del rodamiento de la maza se necesita un calibrador de base magnética. Para obtener lecturas precisas, es indispensable que las superficies donde se colocará el calibrador estén limpias. Cuidadosamente,

con una lija fina, un cepillo suave de alambre o una piedra pómez, elimine toda rebaba, astilla o muesca que pueda existir.



8. La base del calibrador debe colocarse firmemente en la base de la maza o en alguna parte fija de la suspensión. Cuando fije la punta del sensor, asegúrese que tenga suficiente carrera para cubrir

la medición. Coloque la punta del sensor lo más cerca posible del centro de la maza y de manera perpendicular a la cara del disco. Esto brindará resultados más precisos.



9. Sujete la orilla de la maza en las posiciones de las 3:00 y las 9:00, empuje mientras la oscila aproximadamente a 90° de lado a lado, repítalo cinco veces. Después, jale la maza mientras la gira también a 90° de lado a lado, cinco veces. La

oscilación y la carga apropiada son necesarias para asentar los rodamientos.



10. Observe el movimiento del indicador, si excede los 0.004", reemplace la maza por una nueva.

⚠ ADVERTENCIA Ignorar estas advertencias puede crear el riesgo de daños severos

Las prácticas de manejo y mantenimiento son críticas. Siga siempre las instrucciones de instalación y mantenga la lubricación apropiada. Nunca gire un rodamiento con aire comprimido. Los elementos rodantes pueden salir expulsados.

Esta información no pretende sustituir las recomendaciones específicas de los proveedores de sus equipos. Hemos hecho un gran esfuerzo para asegurar la exactitud de la información contenida en el presente, sin embargo, no nos hacemos responsables por errores, omisiones o por cualquier otra razón.

Esta información fue originalmente presentada en el TechTips Automotriz Volumen 3, Número 1 (2004).

REMOVING A HUB UNIT BEARING AND STEERING KNUCKLE

Guidelines for a Passenger Car Front Wheel-End Application



Timken continues to lead the hub unit bearing evolution by providing assemblies that are uncompromised in quality, reliability and consistency. Proper hub unit bearing removal and installation procedures can enhance the performance and life of hub unit bearings, axles, wheels, brakes and other components. Following are guidelines for removing and installing a hub unit bearing on a passenger car front wheel-end application.



1. Raise the vehicle. If applicable, remove the wheel cover to access the lug nuts. Remove the lug nuts and the wheel and tire assembly.



3. Remove the brake rotor. Follow the vehicle manufacturer's recommendations for rotor inspection and reuse.



2. Next, remove the caliper and the caliper mounting bracket. To prevent damage to the brake line due to the weight of the caliper, make sure the caliper is properly supported with either an "S" hook or a piece of wire.



4. Using an axle nut socket, remove the axle nut. Always refer to the vehicle manufacturer's instructions regarding nut replacement.

continued



5. Remove the upper tie rod using the proper tool.



6. If applicable, disconnect the ABS sensor wire from its mating connector point and secure the sensor cable to prevent it from being damaged.

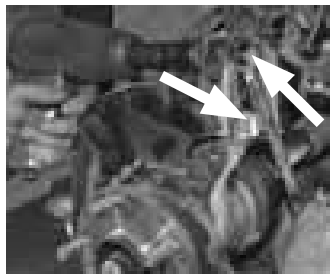

7. Remove strut mounting bolts.

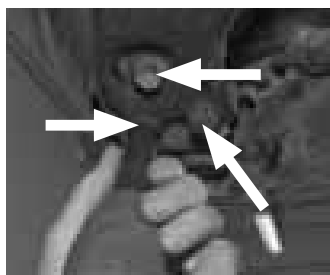

8. Remove the lower ball joint bolts.



9. A puller may be necessary to separate the axle shaft from the hub unit bearing and remove the knuckle assembly from the vehicle.

⚠ WARNING Failure to observe the following warnings could create a risk of serious injury.

Proper maintenance and handling procedures are critical. Always follow installation instructions and maintain proper lubrication.

Never spin a bearing with compressed air. The rolling elements may be forcefully expelled.

This information is not intended to substitute for the specific recommendations of your equipment suppliers.

Every reasonable effort has been made to ensure the accuracy of the information contained in this writing, but no liability is accepted for errors, omissions or for any other reason.

This information was originally presented in Automotive TechTips Volume 6, Issue 2 (2008).

BEARING REMOVAL AND INSTALLATION

Guidelines for a Passenger Car Front Wheel-End Application



Timken continues to lead the hub unit bearing evolution by providing assemblies that are uncompromised in quality, reliability and consistency. Proper hub unit bearing removal and installation procedures can enhance the performance and life of hub unit bearings, axles, wheels, brakes and other components. Following are guidelines for removing and installing a hub unit bearing on a passenger car front wheel-end application.

Removal

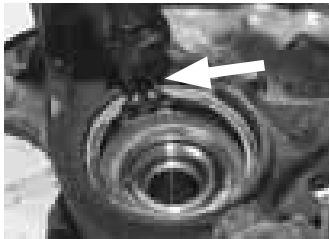

1. Using a pair of snap ring pliers, remove the bearing retaining snap ring from the steering knuckle.



3. Remove the disk brake dust cover.

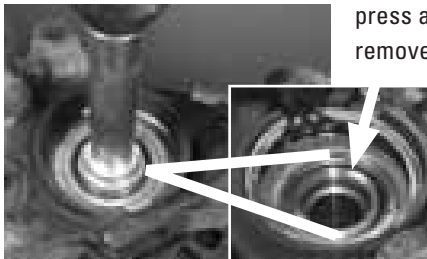

2. Using an appropriate press and support fixture, remove the hub stud from the bearing.



4. Using an appropriate press and support fixture, remove the bearing from the steering knuckle.

continued

Installation



1. Clean the steering knuckle of any debris or burrs. Carefully use a fine file, wire brush, emery cloth or honing stone as appropriate to remove any debris, nicks or burrs.

Inspect the surfaces against which the new bearing will seat for wear and burrs.

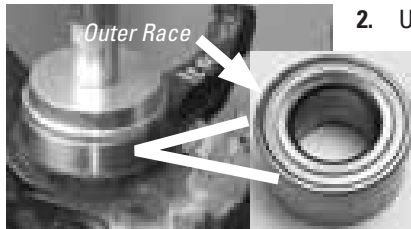

2. Using an appropriate press and support fixture, press the new bearing into the steering knuckle. The outside diameter of the tooling surface

must be large enough to support the outer race of the bearing assembly when applying force.



3. Using a pair of snap ring pliers, install the new bearing retaining snap ring into the steering knuckle.



4. Install the disc brake dust cover. Torque the bolts to the vehicle manufacturer's specifications using a torque wrench.

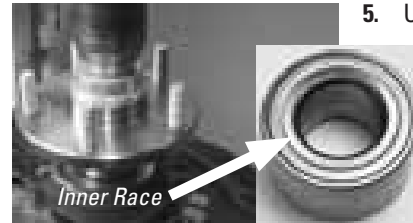

5. Using an appropriate press and support fixture, press the new hub stud assembly (supplied with the kit) into the new bearing assembly.

NOTE: The bearing inner race must be supported when pressing the new hub stud assembly into the new bearing assembly. Failure to follow this note could cause damage to the bearing rolling elements and raceways.

⚠ WARNING Failure to observe the following warnings could create a risk of serious injury.

Proper maintenance and handling procedures are critical. Always follow installation instructions and maintain proper lubrication.

Never spin a bearing with compressed air. The rolling elements may be forcefully expelled.

This information is not intended to substitute for the specific recommendations of your equipment suppliers.

Every reasonable effort has been made to ensure the accuracy of the information contained in this writing, but no liability is accepted for errors, omissions or for any other reason.

This information was originally presented in Automotive TechTips Volume 6, Issue 3 (2008).

INSTALLING A HUB UNIT BEARING AND STEERING KNUCKLE

Guidelines for a Passenger Car Front Wheel-End Application

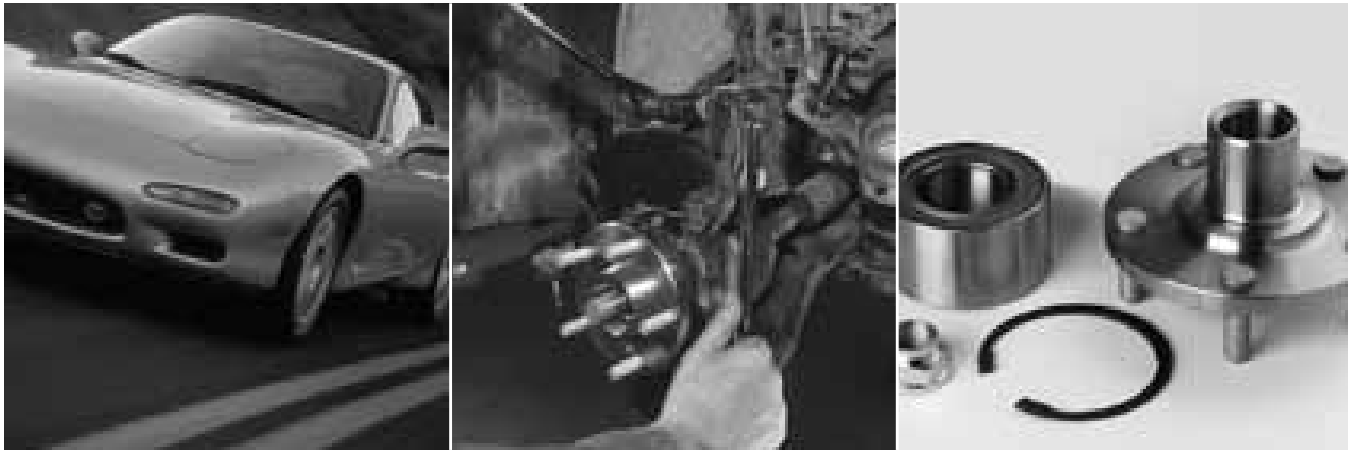

Timken continues to lead the hub unit bearing evolution by providing assemblies that are uncompromised in quality, reliability and consistency. Proper hub unit bearing removal and installation procedures can enhance the performance and life of hub unit bearings, axles, wheels, brakes and other components. Following are guidelines for removing and installing a hub unit bearing on a passenger car front wheel-end application.

HUB UNIT BEARING / BEARING MODULE TECHNOLOGY



1. Inspect the surface of the axle shaft, spline teeth and tone wheel for wear. Use a fine file, wire brush, emery cloth or honing stone as appropriate to remove any debris, nicks or burrs.

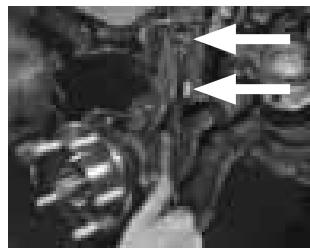

3. Install the strut mounting bolts that attach the steering knuckle to the strut assembly and torque them to the vehicle manufacturer's specifications using a torque wrench.



2. Carefully check the positioning of the splines on the axle shaft while installing the steering knuckle. The proper positioning of these two components is critical so that the splines are not damaged.

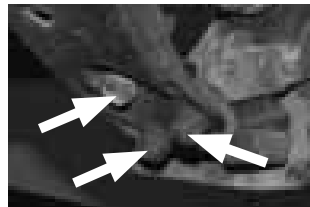

4. Install the bolts that attach the lower ball joint to the lower control arm and torque them to the vehicle manufacturer's specifications using a torque wrench.

NOTE: Never force the hub unit bearing onto the shaft or strike with a hammer.

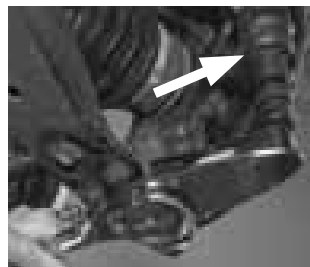

5. Attach the lower ball joint to the lower control arm and install the nut. Torque the nut to the vehicle manufacturer's specifications using a torque wrench.

continued



6. Secure the nut using a new cotter pin.



7. If applicable, be sure to properly attach the ABS sensor cable to the vehicle. Connect the sensor to its mating connection point.



8. Ensure that the brake rotor, caliper mounting bracket and caliper are free of debris and burrs. Install the brake rotor. Follow the vehicle manufacturer's recommendations for rotor inspection and reuse.



9. Install the caliper mounting bracket. Torque the bolts to the vehicle manufacturer's specifications.

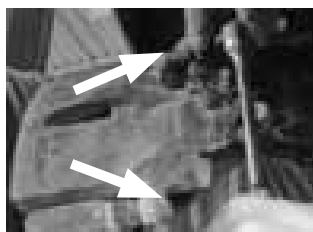

10. Next, install the caliper on the caliper mounting bracket, being careful not to damage the rubber boots. Place the manufacturer's recommended lubricant on the caliper bolts. Install the bolts to the vehicle manufacturer's torque specifications.



11. Prior to installing the axle nut, apply the brake to prevent axle rotation or damage to transmission and transaxle components. This can be accomplished by using either

a brake pedal depressor or having an assistant depress the brake pedal.



12. Install the axle nut. Follow the vehicle manufacturer's instructions for proper tightening of the axle nut.



13. Secure the axle nut with the locking procedure specified by the vehicle manufacturer.



14. Replace the wheel and tire assembly. Install the lug nuts. Follow the vehicle manufacturer's instructions for lug nut tightening sequence, torque specifications and, if applicable, retorquing requirements.

⚠ WARNING Failure to observe the following warnings could create a risk of serious injury.

Proper maintenance and handling procedures are critical. Always follow installation instructions and maintain proper lubrication.

Never spin a bearing with compressed air. The rolling elements may be forcefully expelled.

This information is not intended to substitute for the specific recommendations of your equipment suppliers.

Every reasonable effort has been made to ensure the accuracy of the information contained in this writing, but no liability is accepted for errors, omissions or for any other reason.

This information was originally presented in Automotive TechTips Volume 6, Issue 4 (2008).

WHEEL BEARING REPLACEMENT



Proper wheel bearing removal and installation is essential in avoiding premature damage to bearings and surrounding components. The following are the steps for replacing tapered single-row wheel bearings in passenger cars and light trucks.

1. Wheel end disassembly



Follow the vehicle manufacturer's recommended procedure to remove the tire and wheel assembly, disk brake caliper, dust cap, cotter pin, adjusting nut and washers.

Pull the rotor/hub assembly toward you to loosen the outer bearing cone assembly. Then remove the outer bearing cone assembly. Pull the rotor/hub assembly off the spindle; the inner bearing cone assembly, inner cup, outer cup and seal will come with it.

Before removing the inner bearing cone assembly from the rotor/hub assembly, use a seal puller to remove the seal. Discard the seal after removal. Remove the inner cup and the outer cup from the housing with a cup driver or mild steel bar.

2. Clean and inspect hubs and spindles



Remove all old lubricant from the rotor/hub assembly and spindle, then clean the rotor/hub assembly and spindle with kerosene or mineral oil. Inspect the spindle for wear.

Use a fine file, wire brush, emery cloth or honing stone as appropriate to remove any debris, nicks or burrs.

Follow the vehicle manufacturer's recommendation for permissible spindle wear. A light grease coating on the cone seats will make installation easier and prevent fretting.

3. Install cups



Use a cup driver or mild steel bar to press or drive the new inner cup and outer cup into the hub/rotor assembly until they are solidly seated against the hub shoulders. Be careful not to damage the cup surfaces. Never use a bearing cone assembly to drive a cup.

4. Lubricate



Pack the inner bearing cone assembly with grease. A mechanical grease packer is recommended. Place the bearing cone assembly, small end down, into the grease packer funnel. Plug the bore

continued

of the large end of the bearing cone assembly with the conical retainer. Firmly press down on the conical retainer. This enables the grease to be forced between the rollers, cage and cone. Smear excess grease on the outside of the bearing cone assembly.

Pack grease in the hub cavity between the inner and outer cups. Also, liberally coat the hub cap inner wall with grease; this layer combats moisture and retains the grease in the inner and outer bearing cone assemblies.

5. Install grease seal



The grease seal must be replaced when it leaks or when bearings are being repacked or replaced. Install the inner bearing cone assembly in the hub, then the new seal. Make sure the seal lips are pointed

in the right direction following the vehicle manufacturer's specification. Use the proper seal installation tool.

6. Install rotor/hub assembly



Slide the rotor/hub assembly back over the spindle, being careful not to damage the seal against the spindle. Pack the outer bearing cone assembly with grease following the procedure outlined in the first

paragraph of Step 4. Install the outer bearing cone assembly, washer and adjusting nut on the spindle.

7. Bearing adjustment



Use a torque wrench to tighten the adjusting nut to 50 ft. lbs. while turning the rotor. Back off the adjusting nut 1 full turn. Then retorque the nut to 10 ft. lbs. while turning the rotor. Next, back off the adjusting nut

¼ turn. Lock the nut with a new cotter pin.

8. Check bearing adjustment



Use a dial indicator to measure end play. Mount the indicator base as close to the center of the hub/rotor as possible. With the indicator tip against the end of the spindle, set the indicator at zero. Grasp the rotor at 3 o'clock and

9 o'clock. Push the rotor in while oscillating and read the dial indicator. Then pull the rotor out while oscillating and read the dial indicator again. The bearing end-play is equal to the total indicator movement, which should be between 0.001" and 0.007". If not, repeat steps 7 and 8. Reinstall all components as the vehicle manufacturer recommends.

⚠ WARNING Failure to observe the following warnings could create a risk of serious injury.

Proper maintenance and handling procedures are critical. Always follow installation instructions and maintain proper lubrication.

Never spin a bearing with compressed air. The rollers may be forcefully expelled.

Failure to back off the adjusting nut may cause the bearing to run hot and be damaged, which could cause wheel to lock or come off during operation.

⚠ CAUTION Failure to follow this caution could create a risk of injury.

If a hammer and bar are used for installation or removal of a part, use a mild steel bar (e.g., 1010 or 1020 grade). Mild steel bars are less likely to cause release of high speed fragments from the hammer or bar or the part being removed.

This information is not intended to substitute for the specific recommendations of your equipment suppliers.

Every reasonable effort has been made to ensure the accuracy of the information contained in this writing, but no liability is accepted for errors, omissions or for any other reason.

This information was originally presented in Automotive TechTips Volume 1, Issue 3 (2008).

SEAL AND SHAFT INSTALLATION PROCEDURES



The subject of installation is commonly overlooked when selecting a seal for an application. Improper installation is one of the major causes of premature seal failure. To assist the installation, the seal should be prelubricated with grease or oil to reduce sliding friction of contact surfaces. This also helps protect the seal lips during initial run-in. An installation tool should always be used when installing a seal. Using a tool improves ease of installation and reduces the possibility of seal cocking (non-perpendicular to shaft). A hydraulic or pneumatic press is recommended to supply the necessary force to install the seal. Following are examples of both recommended and improper installation methods.

Shaft Installation

To help minimize possible damage to the seal, the advisable sequence of installation is to install the seal over the shaft and then into the housing bore. *Note: A shaft with the proper chamfer angle also will help to minimize possible damage to the seal.* When installing a seal over a keyway or spline, employ a sleeve to protect the seal lip from cuts.

Seal Installation Over Shaft Splines

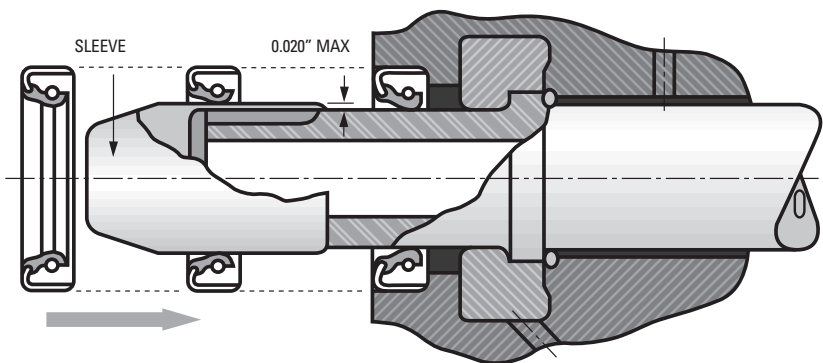

Heavy Weight Housing

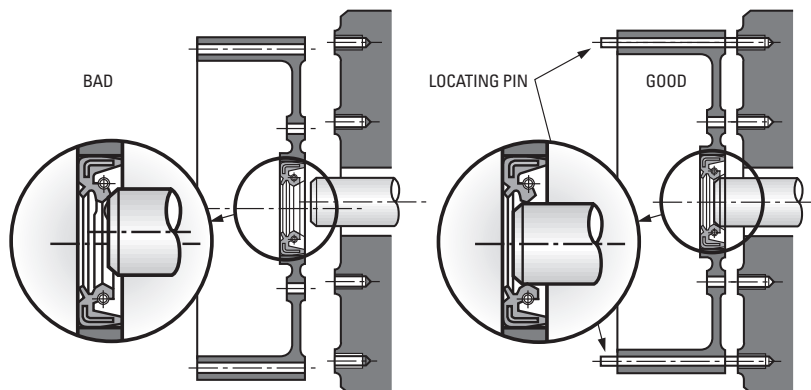

continued

Where the shaft must be installed through the seal, centering guides for the shaft help to prevent lip deformation and dislodging of the spring. When possible, the shaft should be rotated as it passes through the seal to reduce sliding friction.

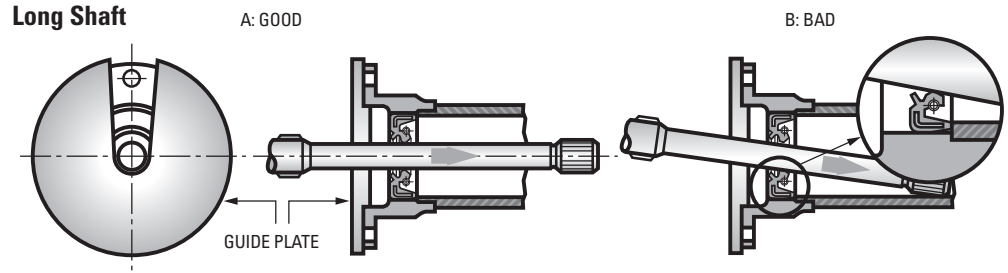

Seal Installation

In each preferred method, installation load is absorbed by either the housing or the bottom plate to prevent seal damage and to assist in locating the seal properly within the bore.

Acceptable

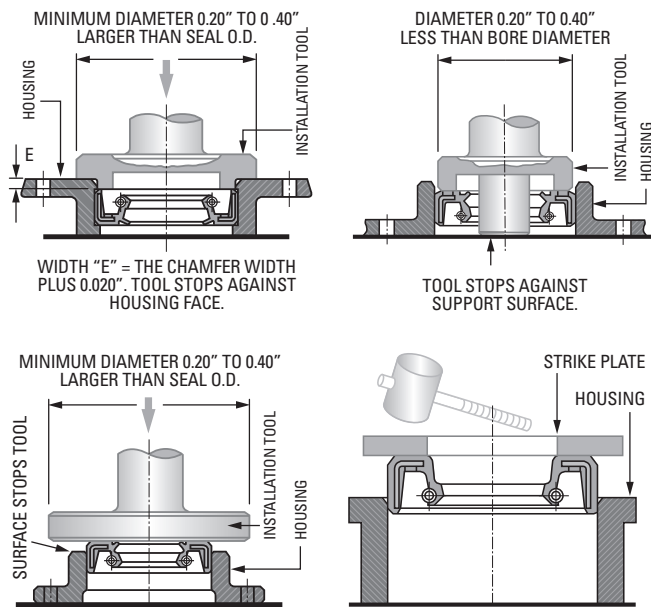

Improper

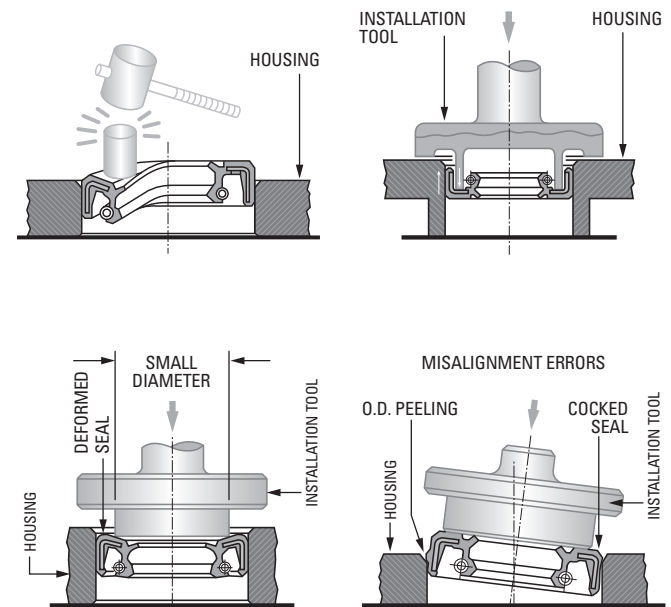

All technical information and illustrations in this writing were provided by and printed with the permission of Freudenberg-NOK.
© Freudenberg-NOK 2000.

⚠ WARNING Failure to observe the following warning could create a risk of serious injury.

Proper maintenance and handling procedures are critical. Always follow installation instructions and maintain proper lubrication.

This information is not intended to substitute for the specific recommendations of your equipment suppliers.

Every reasonable effort has been made to ensure the accuracy of the information contained in this writing, but no liability is accepted for errors, omissions or for any other reason.

This information was originally presented in Automotive TechTips Volume 1, Issue 2 (2003).

REAR WHEEL REPAIR PACKAGE BEARINGS

Timken® Rear Wheel Repair Package Bearings are designed to replace the original bearings and seals on axles that are still in good operating condition, but whose original bearings and/or seal contact paths are not suitable for continued use. The extra-wide repair bearing repositions the rollers and seal to ride on unworn portions of the axle, closer to the flange. Lubrication is accomplished through the axle tube by differential fluid, just as in the original equipment design. These bearings are more economical than replacing the shaft and feature:

- A compact bearing design, which allows for a high load capacity.
- Simplified mounting.



Six Part Numbers Available (Cylindrical Roller Bearings)

Timken Part Number	
TF01561R	Replaces R1561TV bearing and seal used on Ford and Dodge 1.700" axles.
TGM1561R	Replaces R1561TV bearing and seal used on GM 1.700" axles.
TRP1559TV	Replaces R1559TV bearing and seal used on GM, Ford and Chrysler 1.618" axles, with a 12-bolt differential cover.
TRP1563TAV	Replaces R1563TAV bearing and seal used on GM, Ford and Chrysler 1.399" axles, with a 10-bolt differential cover.
TRP57509	Replaces 513023 bearing and seal used on a variety of GM axles.
TRP59047	Replaces 513067 bearing and seal used on a variety of GM axles with a 8.5" ring gear.

Cross Reference

Timken Part Number	Federal-Mogul Part Number	SKF Part Number
TF01561R	RP 1561-FO	R15651-F
TGM1561R	RP 1561-GM	R1561-G
TRP1559TV	RP 6408	R1559
TRP1563TAV	RP 5707	R1563
TRP57509	RP 5130123	R57509
TRP59047	RP 513067	R59407

INSTALLATION INSTRUCTIONS - REAR WHEEL REPAIR PACKAGE BEARINGS

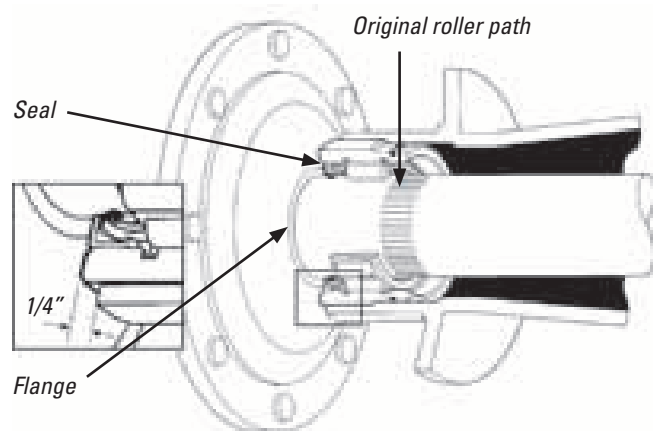

Before Installation

Assess the axle shaft's general condition; not all axles are fit for reuse. Look for any signs of damage or wear.

DO NOT REUSE axles that exhibit the following conditions:

- **BENT OR DISTORTED AXLES**, even if they could be straightened.
- **DISCOLORED AXLES**. Discoloration (usually blue or black) may result from overheating while in operation.
- **AXLES WITH SURFACE CRACKS**. Surface cracks may indicate impending failure; cracks may grow and cause weakening of the axle or complete breakage.
- **NOTICEABLE WEAR ON AXLES** at the original bearing path. Wear may be indicated by a worn groove, heavy corrosion or surface spalling. *NOTE: Axles unfit for reuse are not limited to those exhibiting these conditions; other conditions of distress may also render an axle unfit for reuse.*

Installation Procedure

1. Follow the vehicle manufacturer's procedures for disassembling the axle, seal and bearing.
2. Clean and polish the axle between the flange and the original roller path using a fine grade emery paper. Smooth any nicks or burrs. The repair bearing and seal will ride on this area. Check the axle housing and clean it as necessary. *NOTE: DO NOT reuse any axles which are distorted or bent, discolored, have surface cracks or have noticeable wear at the original bearing path.*
3. Remove the replacement bearing from its box and remove its protective wrapping.
4. Install the bearing in the axle housing with the seal facing out. Use an installation tool that rides on the face of the bearing. If you use the wrong installation tool, you will damage the seal, which may cause a failure. No force should be applied to the seal. Once an axle shaft seal has been removed, never reuse it.
5. Reinstall the axle following the vehicle manufacturer's assembly procedures.
6. Finally, fill the differential with fluid to the level recommended by the vehicle manufacturer.

⚠ WARNING Failure to observe the following warnings could create a risk of serious injury.

Proper maintenance and handling procedures are critical. Always follow installation instructions and maintain proper lubrication.

This information is not intended to substitute for the specific recommendations of your equipment suppliers.

Every reasonable effort has been made to ensure the accuracy of the information contained in this writing, but no liability is accepted for errors, omissions or for any other reason.

TRAILER WHEEL BEARING KITS

Everything You Need in One Package

With constant exposure to elements like water, mud, grime and rough road conditions, your trailer wheel bearings can take a real beating. Corrosion and improper maintenance can dramatically decrease bearing life, leading to expensive damage to equipment, as well as lost work or leisure time. Don't take chances – replace your trailer wheel bearings before you have problems.

Timken® Trailer Wheel Bearing Kits provide everything you need to install a new wheel bearing in one convenient package. Two quality Timken® bearings, a grease seal, cotter pin and petroleum-based bearing grease are included in a complete kit to help assure durability and performance reliability.

Timken Trailer Wheel Bearing Kits are available for the axle sizes shown in the chart on the right.

Trailer Hub Assembly

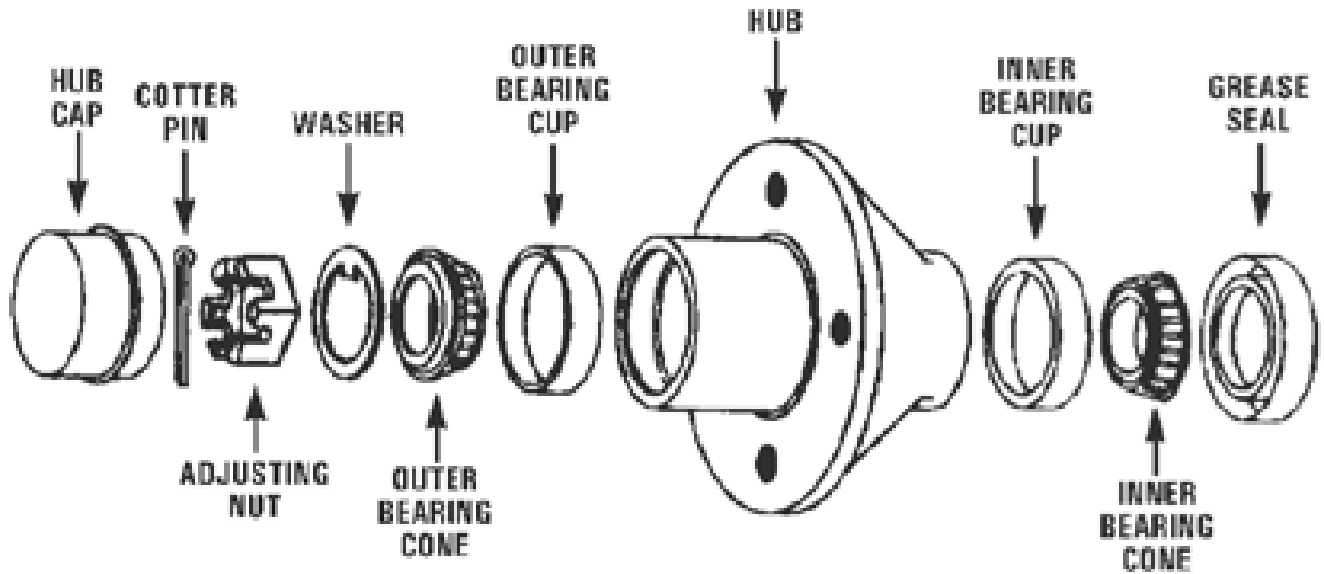

TRAILER WHEEL BEARING KITS

Axle Size	Timken Kit Number	Component Description	Bore	O.D.	Width	Qty
1" Straight Axle	BT100	SET14				2
		L44643 (Cone)	1.000		0.580	
		L44610 (Cup)		1.980	0.420	
		203025 (Seal)	1.218	1.983	0.406	1
		Cotter Pin				1
		Grease Pack				1
1" Straight Axle	BT101	SET14				2
		L44643 (Cone)	1.000		0.580	
		L44610 (Cup)		1.980	0.420	
		7781S (Seal)	1.250	1.987	0.250	1
		Cotter Pin				1
		Grease Pack				1
1-1/4" Straight Axle	BT114	SET6				2
		LM67048 (Cone)	1.250		0.660	
		LM67010 (Cup)		2.328	0.465	
		203013 (Seal)	1.500	2.332	0.406	1
		Cotter Pin				1
		Grease Pack				1
1-1/16" Straight Axle	BT116	SET4				2
		L44649 (Cone)	1.0625		0.580	
		L44610 (Cup)		1.980	0.420	
		203029 (Seal)	1.250	1.983	0.406	1
		Cotter Pin				1
		Grease Pack				1
3/4" Straight Axle	BT134	SET2				2
		LM11949 (Cone)	0.750		0.655	
		LM11910 (Cup)		1.781	0.475	
		204020 (Seal)	1.125	1.785	0.468	1
		Cotter Pin				1
		Grease Pack				1
1-1/4" x 3/4" Tapered Axle	BT214	SET6				1
		LM67048 (Cone)	1.250		0.660	
		LM67010 (Cup)		2.328	0.465	
		SET2				1
		LM11949 (Cone)	0.750		0.655	
		LM11910 (Cup)		1.781	0.475	
		203013 (Seal)	1.500	2.332	0.406	1
		Cotter Pin				1
Grease Pack				1		
1-1/16" x 3/4" Tapered Axle	BT216	SET4				1
		L44649 (Cone)	1.0625		0.580	
		L44610 (Cup)		1.980	0.420	
		SET2				1
		LM11949 (Cone)	0.750		0.655	
		LM11910 (Cup)		1.781	0.475	
		203029 (Seal)	1.250	1.983	0.406	1
		Cotter Pin				1
Grease Pack				1		
1-3/8" x 1-1/16" Tapered Axle	BT238	SET17				1
		L68149 (Cone)	1.377		0.660	
		L68111 (Cup)		2.3612	0.470	
		SET4				1
		L44649 (Cone)	1.0625		0.580	
		L44610 (Cup)		1.980	0.420	
		204502 (Seal)	1.750	2.565	0.250	1
		Cotter Pin				1
Grease Pack				1		

MILEMATE®

ONE SIMPLE GOAL: Keep Your Trucks Up and Moving

Timken® MileMate® sets – the original matched wheel bearing sets – are designed to keep your trucks up and moving. Our 44 matched cup and cone sets are built for superior results and less downtime. When you use the original MileMate sets from Timken, you know you're getting bearing sets specifically designed for your application that meet or exceed the original equipment manufacturer's specifications. This includes the ConMet® PreSet® and Spicer® LMS™, as well as the new wide single tire applications.



Features

- Made from quality Timken certified steel
- Perfectly matched sets for correct installation every time
- Original equipment technology

Benefits

- Matched sets mean less inventory and the correct bearing parts to perform the job all in one box
- Lengthens maintenance intervals
- Optimizes bearing performance
- Allows bearings to carry evenly distributed loads
- Original equipment on ConMet PreSet and Spicer LMS enhances performance

Timken Proprietary "NP" Part Numbers

Meeting the growing original and aftermarket performance demands.

Features

- Enhanced surfaces
- Proprietary Timken design
- More precise internal bearing geometry
- Exceed industry standards

Benefits

- Designed to provide longer life and reliability
- Many heavy-duty, pre-adjusted hubs are serviceable such as ConMet PreSet and Spicer LMS
- Rebuilding with Timken proprietary parts ensures you get all the advantages that were originally engineered into the heavy-duty, pre-adjusted hub systems
- Specifically designed to handle the 2" outset loads of the Michelin® X One™ and Bridgestone® Greatec™ wide single tires

Timken Set Number	Timken Part Number	Popular Manufacturers
SET401	580 / 572	ArvinMeritor / Dana / IHC / Mack / WhiteGMC
SET402	582 / 572	ArvinMeritor / Dana / Mack
SET403	594A / 592A	ArvinMeritor / Dana / IHC
SET404	598A / 592A	ArvinMeritor / Dana / Mack / WhiteGMC
SET405	663 / 653	ArvinMeritor / Clark / Dana / IHC / Mack / Standard / Volvo
SET406	3782 / 3720	ArvinMeritor / Dana / Ford / IHC / WhiteGMC
SET407	28682 / 28622	Dana / IHC
SET408	39590 / 39520	ArvinMeritor / Dana / IHC
SET409	45280 / 45220	Mack
SET410	45284 / 45220	ArvinMeritor / Dodge / Ford / GMC
SET411	47686 / 47620	ArvinMeritor / Dana / FWD / IHC
SET412	HM212047 / HM212011	ArvinMeritor / Dodge / Ford / GMC / Isuzu
SET413	HM212049 / HM212011	ArvinMeritor / Clark / Dana / Fruehauf / Hendrickson / IHC / IMT / Mack / Standard / WhiteGMC
SET414	HM218248 / HM218210	ArvinMeritor / Dana / Hendrickson / IMT / Kay-Brunner / Standard
SET415	HM518445 / HM518410	ArvinMeritor / Dana / Fruehauf / Hendrickson / MIT
SET416	45291 / 45220	ArvinMeritor / Dana
SET417	47890 / 47820	ArvinMeritor / IHC / Oshkosh / Standard
SET418	H715334 / H715311	ArvinMeritor / Oshkosh
SET419	H715343 / H715311	ArvinMeritor / IHC / Oshkosh
SET420	H715345 / H715311	ArvinMeritor / IHC / Mack / WhiteGMC
SET421	HM516449A / HM516410	Mack
SET422	HM516449C / HM516410	Mack
SET423	6461A / 6420	ArvinMeritor / Dana / Dodge / Ford / Mack
SET424	555-S / 552A	ArvinMeritor / Dana / Dodge / Ford / IHC / Mack
SET425	567 / 563	ArvinMeritor / Dana / Dodge / Ford / IHC / Iveco / Mack / Oshkosh / Standard
SET426	47679 / 47620	Mack
SET427*	NP899357 / NP026773	ConMet PreSet Steer / N Trailer
SET428*	NP874005 / NP435398	ConMet PreSet Steer
SET429*	NP034946 / NP363298	ConMet PreSet Drive
SET430*	NP840302 / NP053874	ConMet PreSet Drive
SET431*	NP965350 / NP503727	ConMet PreSet N Trailer
SET432*	NP174964 / NP593561	ConMet PreSet P Trailer
SET433*	NP431952 / NP378092	Dana LMS Steer / N Trailer
SET434*	NP555065 / NP720703	Dana LMS Steer
SET435*	NP568900 / NP107783	Dana LMS Drive
SET436*	NP577914 / NP975161	Dana LMS Drive
SET437*	NP022333 / NP250023	Dana LMS N Trailer
SET438*	NP417549 / NP156827	Dana LMS P Trailer
SET439	HM212049X / HM212011	Volvo Steer
SET440*	NP454049 / NP454011	ArvinMeritor / Dana / Hendrickson / IMT
SET441*	NP454248 / NP454210	ArvinMeritor / Dana / Hendrickson / IMT
SET442*	NP454580 / NP454572	ArvinMeritor / Dana / Hendrickson / IMT
SET443*	NP454594 / NP454592	ArvinMeritor / Dana / Hendrickson / IMT
SET444*	NP454445 / NP454410	ArvinMeritor / Dana / Hendrickson / IMT



* Proprietary Timken Part Numbers

MILEMATE®: FRENCH CANADIAN

UN OBJECTIF SIMPLE : Maintenir vos camions en bon état de marche

Les ensembles de roulements de roues assortis originaux Timken® MileMate® sont conçus pour maintenir vos camions en bon état de marche. Nos 44 ensembles de cuvettes et de cônes assortis vous offrent des performances exceptionnelles et réduisent les temps d'arrêts. Les ensembles de roulements MileMate de Timken sont spécifiquement conçus pour vos applications et respectent, ou même dépassent, les spécifications du fabricant d'équipement. Cela couvre les moyeux ConMet® PreSet® et Spicer® LMS™, ainsi que les nouveaux roulements pour pneus uniques à bande large.



Caractéristiques

- Fabriqués en acier certifié Timken de qualité
- Les ensembles sont parfaitement assortis pour être toujours correctement installés
- Technologie d'équipement originale

Avantages

- Les roulements assortis sont fournis dans le même emballage et vous permettent de réduire vos inventaires
- Intervalles de maintenance moins fréquentes
- Optimisation de la performance des roulements
- Les roulements peuvent supporter des charges mieux réparties
- L'équipement d'origine des ensembles ConMet PreSet et Spicer LMS améliore la performance

Numéros de pièces « NP » exclusifs de Timken

Pour satisfaire les besoins croissants en performance des marchés d'origine et secondaires

Caractéristiques

- Surfaces améliorées
- Conception exclusive de Timken
- Une géométrie de roulement interne plus précise
- Dépassent les normes de l'industrie

Avantages

- Conçus pour une plus grande fiabilité et durée de vie
- De nombreux moyeux industriels pré réglés, tels que ConMet PreSet et Spicer LMS, peuvent être réparés
- En rebâtissant avec des pièces exclusives Timken, vous profitez des avantages d'origine des systèmes de moyeux industriels pré réglés
- Conçus spécifiquement pour permettre un déport externe de 2 po des pneus à bande large Michelin® X One™ et Bridgestone® Greatec™

MILEMATE®: SPANISH

UNA META SIMPLE: Mantener a sus camiones en movimiento

Los sets Timken® MileMate® – conjuntos de rodamientos para ruedas con especificaciones de Equipo Original – están diseñados para mantener a sus camiones en movimiento. Nuestros 44 sets de cono y taza, están diseñados para ofrecer resultados superiores y menores tiempos muertos. Cuando usted utiliza los sets originales MileMate de Timken, sabe que está obteniendo conjuntos de rodamientos específicamente diseñados para sus aplicaciones, y que cumplen o exceden las especificaciones del fabricante de equipo original. Entre éstas, se incluyen aquellas para las mazas ConMet® PreSet® y Spicer® LMS™, así como las nuevas aplicaciones de neumáticos anchos.



Características

- Fabricados con acero de calidad certificado por Timken
- Conjuntos perfectamente emparejados para obtener siempre una instalación correcta
- Tecnología de Equipo Original

Beneficios

- Los sets favorecen un menor inventario ya que incluyen ambas partes en un mismo empaque
- Prolongan el intervalo entre mantenimientos
- Optimizan el rendimiento de los rodamientos
- Permiten al rodamiento la distribución uniforme de la carga
- Aumentan el rendimiento de equipos originales con ConMet PreSet y Spicer LMS

Números de parte “NP” exclusivos de Timken

Cumpliendo con las exigencias de desempeño de Equipo Original y del mercado de repuesto.

Características

- Superficies mejoradas
- Diseño exclusivo de Timken
- Geometría interna del rodamiento más precisa
- Superan los estándares de la industria

Beneficios

- Diseñados para ofrecer confiabilidad y mayor vida útil
- Muchas de las mazas pre ajustadas para servicio pesado ConMet PreSet y Spicer LMS son susceptibles de mantenimiento
- Las reparaciones con piezas originales Timken aseguran que obtenga todas las ventajas que ofrecen los sistemas de mazas pre ajustadas para servicio pesado con ingeniería de Equipo Original
- Específicamente diseñados para manejar las cargas con 2” fuera de su centro, de los neumáticos anchos Michelin® X One™ y Bridgestone® Greatec™

DRIVELINE CENTER SUPPORT BEARINGS

Timken® Driveline Center Support Bearings are interchangeable with all major truck applications. The part numbers listed below can equip the most popular light-duty pickups, vans, mid-size trucks, school buses and heavy-duty highway vehicles.

Timken Driveline Center Support Bearings are constructed with frames made from reinforced heavy-gauge, cold-rolled steel for added strength, which helps increase durability and service life. The bearing inserts are pre-greased and sealed, with a second grease barrier applied between the sealed bearing and dust shield to help maximize protection.



Cross Reference						
Timken Part Number	DT Components Part Number	Dana-Spicer® Part Number	Federal Mogul Part Number	Meritor® Part Number	NEAPCO® Part Number	SKF Part Number
HB206FF	HB210527-X	210527-X	HB206-FF	CB210527-X	210527-X	HB206-FF
HB88107B	HB210088-1X	210088-1X	HB88107-B	CB210088-1X	21008-1X	HB88107-B
HB88107C	HB210090-1X	210090-1X	HB88107-C	CB210090-1X	210090-1X	HB88107-C
HB88107D	HB210367-1X	210367-1X	HB88107-D	CB210367-1X	210367-1X	HB88107-D
HB88107E	HB210370-1X	210370-1X	HB88107-E	CB210370-1X	210370-1X	HB88107-E
HB88508AB	HB210866-1X	210866-1X	HB88508-AB	CB210866-1X	210866-1X	HB88508-AB
HB88508B	HB210433-1X	210433-1X	HB88508-B	CB210433-1X	210433-1X	HB88508-B
HB88508C	HB210140-1X	210140-1X	HB88508-C	CB210140-1X	210140-1X	HB88508-C
HB88508D	HB210144-1X	210144-1X	HB88508-D	CB210144-1X	210144-1X	HB88508-D
HB88508E	HB210391-1X	210391-1X	HB88508-E	CB210391-1X	210391-1X	HB88508-E
HB88509A	HB210084-2X	210084-2X	HM88509-A	CB210084-2X	210084-2X	HB88509-A
HB88509C	HB210207-1X	210207-1X	HB88509-C	CB210207-1X	210207-1X	HB88509-C
HB88510	HB210121-1X	210121-1X	HB88510	CB210121-1X	210121-1X	HB88510
HB88510S	HB210881-1X	210881-1X	HB88510-S	CB210881-1X	210881-1X	HB88510-S
HB88512AHD	HB210661-1X	210661-1X	HB88512-AHD	CB210661-1X	210661-1X	HB88512-A
HB88512ASHD	HB210875-1X	210875-1X	HB88512-AS	CB210875-1X	210875-1X	HB88512-AS

SUPERSEDED PART NUMBERS

Old Number	New Number	Old Number	New Number	Old Number	New Number	Old Number	New Number
1577	613002	510066	SET35	HA590048	HA590085	SP550306	SP450301
1697C	614037	511010	511011	HA590073	HA590092	SP580304	SP580310
2012S	2012V	512030	512029	HA590075	HA590093	SP580305	SP580310
223250	710414	512215	512217	HA590083	513139	SP580306	SP580310
223430	710417	512216	512218	HA590114	HA590113	SP580307	HA590352
223610	710197	513091	513092	HA590225	WB000003	SP580308	SP580311
30211	30211M	513160	HA590085	HA590248	513123	SP580309	SP580311
30310A	30310	614071	614009	HA590268	HA590269	SP580306	SP580310
32014	32014XM	6808N	9316	HA590494	BM500010	SP580307	HA590352
32309	32309M	710335	471847N	MSNB5305GTBV	MSN5305GTBV	SP580308	SP580311
33213	33213M	716445	3698	SP450203	SP450202	SP580309	SP580311
450009	471466	BM500011	WB000003	SP470200	SP470201		
455369	416273	FC1723C	1773	SP550304	SP500300		
4635	4635V	HA590031	HA590142	SP550305	SP450301		

OBSOLETE PART NUMBERS

204BBAG	513010	B33	SP580308
205RRUN	513038	C672Q	SP580309
2061	513072	DRK335J	T47R
221925	513091	DS210TTF	TCRK231A
222242	513151	F213118	TCRK233
231052	5690	F47R	TCRK241A
307LI	5957S	FC67945	TCRK241D
32007C	614026	HA590102	TCRK242A
5068	614096	HA590224	TCRK243
511005	614098	HA590289	TCRK241A
512005	614123	HA590644	TCRK241D
512019	614166	LM48510P	TCRK242A
512105	710422	PB38	TCRK243
512146	8537	Q13367	
512234	88131R	SK450201	

NON-CANCELLABLE, NON-RETURNABLE PART NUMBERS

02830	47622BW	BT134A	KA11424Z
14120A	47622W	BT214	KA11820Z
14C	49520W	BT216	KA11950Z
15115	49522	C5107EV	KA11985Z
1530	49580	CTL3500	KB11786Y
16150	513001	H913843	L44600LB-902A3
17481-90010	513004K	H914841	LM11749
17481-90011	513029	HH506349	LM11919
1780	513045	HH914447	LM48511A
17883	513047	HM212049A	LM48514
18352	513245	HM801311	LM48548C
23691	517004WB	HM804849	LM67047
24	517006	HM807048	LM814845
25576	517012	HM88644A	M201047S
26822A	5521	HM903244	M514546
26880	5557	HM903249A	M533310
26882T	5577	JL69345	M533349S
2789	562	JL69349A	M802047
28622A	575	JLM104942A	M86648
30313	5752	JLM104945	M88040
31590	593X	JLM503319	NP174964
32219	594R	JLM508710	NP503727
32312B	613S	JLM508748	NP593561
33018	623S	JLM603013Z	SET21
36990	65501	JLM603048F	SET22
36X	66585	JLM67042	SET251
3733	66588	JM205149AS	SET27
3820W	66589	JM511910	SET28
3822RB-90030	683XA	JM714210	SET30
385AX	68709	JP10049	SET33
38A	750A	JP12049	SET48
39575	752A	JW4549	SET80
40	754W	JW6010	SET92
416	774BW	JW6049	WB108AT
42350	78250AC	JXC25743C	WB133AT
42590	9180	JXC25743D	X33208
45285-90011	9181	KA11020Z	XAB33212
452B	9221B	KA11035Z	Y32009X
453XB	B12235YK	KA11360Z	Y32207
455A	BT114A	KA11410Z	Y33208

BSAC 1990 & NEWER - 2010 CATALOG COMMENT CARD
(Please type or print clearly)

Page No. _____

1. Comments: _____

2. Is this catalog your primary reference for Timken products? If not, what is? _____

3. What should we include in updates of this catalog? _____

4. What section (list page numbers) do you use the most in the catalog? _____

Company Name _____

Address _____

City _____ State/Province _____ Zip/Postal Code _____ Country _____

Name and Title _____

Phone _____ E-mail address _____ Date _____

Do not use this card to order catalogs.
For more on The Timken Company, visit us on the internet at www.timken.com or www.imkeninfo.com or send an e-mail to auto.am@timken.com.



BSAC 1990 & NEWER - 2010 CATALOG COMMENT CARD
(Please type or print clearly)

Page No. _____

1. Comments: _____

2. Is this catalog your primary reference for Timken products? If not, what is? _____

3. What should we include in updates of this catalog? _____

4. What section (list page numbers) do you use the most in the catalog? _____

Company Name _____

Address _____

City _____ State/Province _____ Zip/Postal Code _____ Country _____

Name and Title _____

Phone _____ E-mail address _____ Date _____

Do not use this card to order catalogs.
For more on The Timken Company, visit us on the internet at www.timken.com or www.imkeninfo.com or send an e-mail to auto.am@timken.com.

BSAC 1990 & NEWER - 2010 CATALOG COMMENT CARD
(Please type or print clearly)

Page No. _____

1. Comments: _____

2. Is this catalog your primary reference for Timken products? If not, what is? _____

3. What should we include in updates of this catalog? _____

4. What section (list page numbers) do you use the most in the catalog? _____

Company Name _____

Address _____

City _____ State/Province _____ Zip/Postal Code _____ Country _____

Name and Title _____

Phone _____ E-mail address _____ Date _____

Do not use this card to order catalogs.
For more on The Timken Company, visit us on the internet at www.timken.com or www.imkeninfo.com or send an e-mail to auto.am@timken.com.



BSAC 1990 & NEWER - 2010 CATALOG COMMENT CARD
(Please type or print clearly)

Page No. _____

1. Comments: _____

2. Is this catalog your primary reference for Timken products? If not, what is? _____

3. What should we include in updates of this catalog? _____

4. What section (list page numbers) do you use the most in the catalog? _____

Company Name _____

Address _____

City _____ State/Province _____ Zip/Postal Code _____ Country _____

Name and Title _____

Phone _____ E-mail address _____ Date _____

Do not use this card to order catalogs.
For more on The Timken Company, visit us on the internet at www.timken.com or www.imkeninfo.com or send an e-mail to auto.am@timken.com.





POSTNET
EXTENSION
MAIL PERMIT
NO. 3085
CANTON, OH

BUSINESS REPLY MAIL

POSTAGE WILL BE PAID BY ADDRESSEE

AUTOMOTIVE AFTERMARKET - GCH 10
THE TIMKEN CO
1835 DUEBER AVE SW
CANTON OH 44706 USA



POSTNET
EXTENSION
MAIL PERMIT
NO. 3085
CANTON, OH

BUSINESS REPLY MAIL

POSTAGE WILL BE PAID BY ADDRESSEE

AUTOMOTIVE AFTERMARKET - GCH 10
THE TIMKEN CO
1835 DUEBER AVE SW
CANTON OH 44706 USA



POSTNET
EXTENSION
MAIL PERMIT
NO. 3085
CANTON, OH

BUSINESS REPLY MAIL

POSTAGE WILL BE PAID BY ADDRESSEE

AUTOMOTIVE AFTERMARKET - GCH 10
THE TIMKEN CO
1835 DUEBER AVE SW
CANTON OH 44706 USA



POSTNET
EXTENSION
MAIL PERMIT
NO. 3085
CANTON, OH

BUSINESS REPLY MAIL

POSTAGE WILL BE PAID BY ADDRESSEE

AUTOMOTIVE AFTERMARKET - GCH 10
THE TIMKEN CO
1835 DUEBER AVE SW
CANTON OH 44706 USA



SET INTERCHANGE

Interchange Data			
Bearing Set Numbers			Bearing Numbers
Timken	SKF	Federal Mogul	Cone / Cup
SET1	BR1	A-1	LM11749 / LM11710
SET2	BR2	A-2	LM11949 / LM11910
SET3	BR3	A-3	M12649 / M12610
SET4	BR4	A-4	L44649 / L44610
SET5	BR5	A-5	LM48548 / LM48510
SET6	BR6	A-6	LM67048 / LM67010
SET7	BR7	A-7	M201047 / M201011 with locking collar
SET8	BR8	A-15	L45449 / L45410
SET9	BR9	A-9	U298 / U261L with locking collar
SET10	BR10	A-10	U399 / U360L with locking collar
SET11	BR11	A-18	JL69349 / JL69310
SET12	BR12	A-12	LM12749 / LM12710
SET12F	NA	NA	LM12749F / LM12710
SET12FP	NA	NA	LM12749FP / LM12710P
SET13	BR13	A-13	L68149 / L68110
SET14	BR14	A-14	L44643 / L44610
SET15	BR15	A-19	07100 / 07196
SET16	BR16	A-16	LM12749 / LM12711
SET17	BR17	A-17	L68149 / L68111
SET20	BR20	A-20	U399A / U365L with locking collar and seal
SET21	BR21	A-21	1988 / 1922
SET22	BR22	A-29	2 of (LM67045) / 2 of (LM67010-Z)
SET23	BR23	A-23	LM104949E-904A2

Interchange Data			
Bearing Set Numbers			Bearing Numbers
Timken	SKF	Federal Mogul	Cone / Cup
SET24	BR24	A-31	JL68145 / JL68111-Z - Sold as set only
SET25	BR25	A-22	JLM506848E-90K02
SET26	BR26	A-40	JLM104946 / JLM104910-Z
SET27	BR31	A-24	Components - Not sold separately
SET28	BR28	A-28	J15585 / 15520
SET30	BR30	A-30	JLM67042 / LM67010 Sold as set only
SET32	BR32	A-32	Components - Not sold separately
SET33	BR33	A-33	Components - Not sold separately
SET34	BR34	A-34	LM12748F / LM12710
SET35	B35	B35	JRM3534-90U01
SET36	BR36	A-36	LM603049 / LM603012
SET37	BR37	A-37	LM603049 / LM603011
SET38	BR38	A-38	LM104949 / LM104911
SET39	FW113	B38	JRM3939-90U08
SET40	B39	B39	JRM4040A-90U02 - When depleted use B39
SET41	BR41	A-41	Components - Not sold separately
SET42	BR42	A-42	JLM506849A / JLM506811
SET43	BR43	A-43	Components - Not sold separately
SET45	BR35	A-35	LM501349 / LM501310
SET46	BR39	A-39	JL26749F / JL26710
SET47	BR50	NA	LM102949 / LM102910
SET48	B42	513006	JRM4042-90UA1 - When depleted use 513006
SET49	FW115	513058	JRM4249-90UA1

MILEMATE® MATCHED WHEEL BEARING SETS

Timken Set Number	Timken Part Number	Timken Set Number	Timken Part Number	Timken Set Number	Timken Part Number
SET401	580 / 572	SET416	45291 / 45220	SET431*	NP965350 / NP503727
SET402	582 / 572	SET417	47890 / 47820	SET432*	NP174964 / NP593561
SET403	594A / 592A	SET418	H715334 / H715311	SET433*	NP431952 / NP378092
SET404	598A / 592A	SET419	H715343 / H715311	SET434*	NP555065 / NP720703
SET405	663 / 653	SET420	H715345 / H715311	SET435*	NP568900 / NP107783
SET406	3782 / 3720	SET421	HM516449A / HM516410	SET436*	NP577914 / NP975161
SET407	28682 / 28622	SET422	HM516449C / HM516410	SET437*	NP022333 / NP250023
SET408	39590 / 39520	SET423	6461A / 6420	SET438*	NP417549 / NP156827
SET409	45280 / 45220	SET424	555-S / 552A	SET439*	HM212049X / HM212011
SET410	45284 / 45220	SET425	567 / 563	SET440*	NP454049 / NP454011
SET411	47686 / 47620	SET426	47679 / 47620	SET441*	NP454248 / NP454210
SET412	HM212047 / HM212011	SET427*	NP899357 / NP026773	SET442*	NP454580 / NP454572
SET413	HM212049 / HM212011	SET428*	NP874005 / NP435398	SET443*	NP454594 / NP454592
SET414	HM218248 / HM218210	SET429*	NP034946 / NP363298	SET444*	NP454445 / NP454410
SET415	HM518445 / HM518410	SET430*	NP840302 / NP053874		

* Proprietary Timken Part Numbers

US \$15

PRODUCT OFFERING

HUB UNIT BEARINGS

- *ABS Hub Unit Bearings*
- *ABS Hub Unit Bearings with SENSOR-PAC™ Bearings*
- *Non-ABS Hub Unit Bearings*
- *Non-ABS Hub Unit Bearings with UNIPAC™ Bearings*
- *Non-ABS Hub Unit Bearings with UNIPAC-PLUS™ Bearings*

BEARINGS

- *Ball Bearings*
- *Clutch Release Bearings*
- *Cylindrical Bearings*
- *Cylindrical Axle Repair Bearings*
- *Driveline Center Support Bearings*
- *Needle Bearings*
- *Tapered Bearings*

SEALS

- *Automotive*
- *Industrial*
- *Light- and Heavy-Duty Oil Bath Seals*
- *Metric*

SPECIALTY KITS

- *KWIK-SLEEVES™ Shaft Repair Kits*
- *Sensor Kits*
- *DT Components® Drivetrain Products*
- *Differential Kits*
- *MileMate® Matched Wheel Bearing Sets*
- *Transmission Kits*
- *Transaxle & Transfer Case Kits*
- *Trailer Kits with Standard Bearings*
- *Automotive Wheel Bearing Grease*
- *Set-Right™ Heavy-Duty Hub Rebuild Kits*



TIMKEN
Where You Turn

www.timken.com

Timken® is the registered trademark of
The Timken Company.

The registered and unregistered trademarks in this
catalog are the property of their respective owners.

© 2009 The Timken Company
Printed in U.S.A.
50M 10-09-29 Order No. 7564