

# Emerson Power Transmission

[www.emerson-ept.com](http://www.emerson-ept.com)

BROWNING  
KOP-FLEX  
McGILL  
MORSE  
ROLLWAY  
SEALMASTER  
U.S. GEARMOTORS

Part of  
something  
**Bigger...**



BEARINGS



COMPONENTS



COUPLINGS



GEARING



CRES CZ  
(Page 10)



CRES CAMROL® Bearing  
Stainless Steel  
(Page 12)



EMERSON® MXP  
Motorized Pulleys  
(Page 26)



KOP-FLEX® Universal Joints  
(Page 29)



TORQTAPER® Plus  
(Page 34)



RAIDER®  
Stainless Steel  
(Page 30)



CbN Series  
3000  
(Page 32)

# New and Problem Solving Products from...

## Emerson Power Transmission

[www.emerson-ept.com](http://www.emerson-ept.com)

# McGILL®

# ROLLWAY®

# SEALMASTER®

## BEARING PRODUCTS

SEALMASTER Ball Bearings .....	6 and 7
SEALMASTER Roller Bearings .....	8 and 9
BROWNING Mounted Bearings .....	10 and 11
McGILL Cam Followers .....	12 and 13
McGILL Needle & Spherical Roller Bearings .....	14
McGILL Aerospace Bearings .....	15
ROLLWAY Heavy-Duty Bearings .....	16 and 17

## COMPONENT PRODUCTS

BROWNING V-Drives .....	18 and 19
BROWNING Synchronous Drives .....	20
BROWNING/MORSE Clutches .....	21
MORSE Chain .....	22
BROWNING Sprockets .....	23
MORSE Conveying Components .....	24
BROWNING Open Gearing .....	25
EMERSON® MXP™ Motorized Conveyor Pulleys .....	26

## COUPLING PRODUCTS

BROWNING/MORSE/KOP-FLEX Couplings .....	27
KOP-FLEX Couplings .....	28 and 29

## GEARING PRODUCTS

MORSE Worm Gearing .....	30 and 31
USGM Helical & Worm Gearing .....	32 and 33
BROWNING Helical Gearing .....	34 and 35

*Browning*®

*MORSE*®

KOP-FLEX®



# Emerson Power Transmission

**EPT's extensive capabilities keep you moving at the speed of eBusiness...**

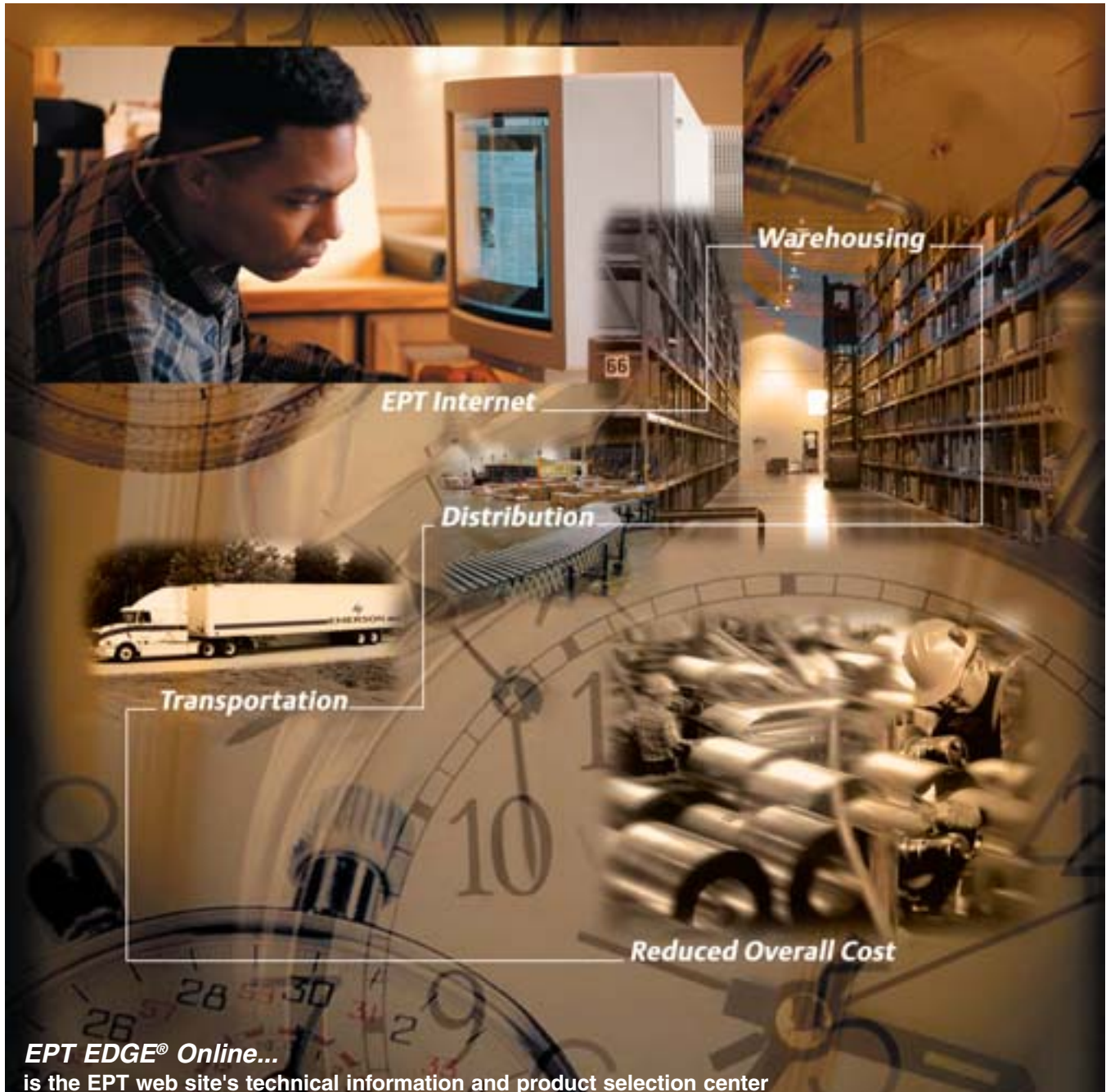

## **EPT EDGE® Online...**

is the EPT web site's technical information and product selection center

- ✓ eCatalog
- ✓ Product selection
- ✓ Smart interchange
- ✓ CAD
- ✓ Help desk
- ✓ Product literature
- ✓ Engineered solutions

## **EPT's authorized distributors...**

are connected to EPT in order to serve you better ✓ eLINK ✓ EDI ✓ EDGE® JIT

# Part of something Bigger...

*We know that you look for more from your supplier than the minimum requirements and a low price. To succeed in today's global environment, you weigh all factors and choose the best value. And that's what you'll get when you choose Emerson Power Transmission.*

- Seven rock-solid **Brands**
- **Online Tools** that are the envy of the industry
- **Technical Resources** that boost your output
- **Customer Service** that puts you first
- A **Distributor Network** that's everywhere you are
- **Global Savvy** that brings you the best the world has to offer

**Browning**<sup>®</sup>

**KOP-FLEX**<sup>®</sup>

**MCGILL**<sup>®</sup>

**Morse**<sup>®</sup>

**R**ROLLWAY<sup>®</sup>

**SEALMASTER**<sup>®</sup>



EMERSON POWER TRANSMISSION

## SEALMASTER® GOLD LINE BEARINGS OFFER A HIGH-PERFORMANCE SOLUTION WITHOUT COMPROMISE

The reason why these mounted ball bearings are the *“World’s most specified”*: they perform. With fewer failures, less downtime, increased productivity and longer life, these bearings save time and money in a variety of ways. No other commercially marketed bearing combines the exclusive engineering features and resultant user benefits with the surpassing quality of this bearing line. No other standard bearing offers the broadest selection of in-stock sizes.

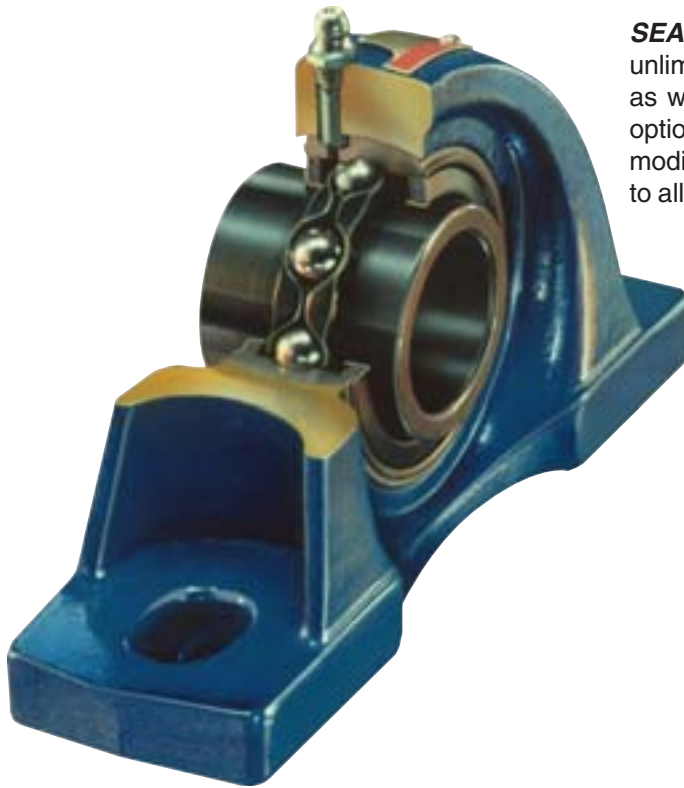

**SEALMASTER Ball Bearings** are available with an almost unlimited selection of **“custom design”** features and options, as well as specially-engineered bearing types. Choose from optional construction materials and a wide range of mechanical modification and engineering adaptations, all carefully selected to allow you to satisfy your particular application requirements:

- A variety of shaft locking devices
- A broad selection of bearing seals
- Special internal and external fit-ups
- Special and premium lubricants
- Special housing configurations
- Corrosion-resistant platings / coatings
- Many other options / modifications

### Patented SKWEZLOC® Locking Collar centers the shaft in the bearing bore... Secures the shaft with improved concentricity

SEALMASTER bearings with SKWEZLOC® Locking Collars run quieter - a quality you equate with better performance and longer bearing life. This feature also allows operation at higher speeds than setscrew or eccentric locking designs.

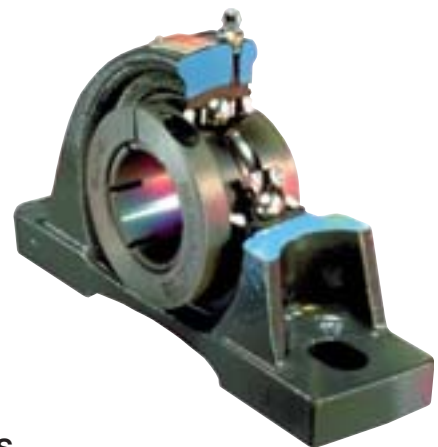

#### GOLD LINE MOUNTED BALL BEARINGS

Series	Type Locking	Bore Sizes			
		Pillow Blocks	Flange Blocks	Cartridge Units	Take-Up Units
Standard Duty	Setscrew	1/2 - 3 7/16"	1/2 - 2 15/16"	1/2 - 3/16"	1/2 - 3 7/16"
		20-80mm	20-70mm	30-80mm	20-80mm
	Skwezloc	3/4 - 2 7/16"	3/4 - 2 7/16"	1 1/8 - 2 7/16"	1 5/16 - 2 7/16"
Medium Duty	Setscrew	1 5/16 - 4 15/16"	1 5/16 - 4 15/16"	15/16 - 4"	15/16 - 4"
	Skwezloc	1 - 2 1/4"	1 - 2 1/4"	1 - 2 1/4"	

# BALL BEARING PRODUCTS



## Corrosion Resistant Mounted Ball Bearings...

**CRES** stands for **Corrosion Resistant Engineered Solutions**... a new look at corrosion resistant power transmission components. CRES Mounted Ball Bearing products start with the latest in corrosion resistance technology coupled with advanced industry-minded features driven by industry-focused leaders. Our engineers designed CRES around the notion that a “family” of corrosion resistant products spanning the spectrum of performance and value will provide customers flexibility and latitude to specify the solution when and where they see fit.

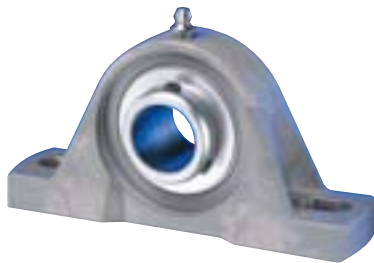

**TDC GOLD**

Composite housing & thin dense chrome coated insert.



**CR GOLD**

316 series stainless steel housing & black oxide coated insert.



**BEV GOLD**

316 series stainless steel housing & thin dense chrome coated insert.

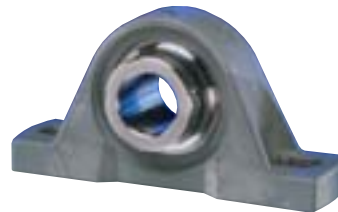

**SLIC MOUNT**

Composite housing, 316 series stainless steel & polymer bushing Insert.

## CORROSION RESISTANT MOUNTED BALL BEARINGS

Series	Type Locking	Bore Sizes				Housing Material
		Pillow Blocks	Flange 2 & 4 Bolt	Tapped Base	Flange Bracket	
TDC GOLD	Setscrew	3/4" - 1 1/2"	3/4" - 1 1/2"	3/4" - 1 1/2"	-	Composite
CR GOLD	Setscrew	3/4" - 2"	3/4" - 2"	-	3/4" - 1 7/16"	316 Series Stainless Steel
BEV GOLD	Setscrew	3/4" - 2 7/16"	3/4" - 2 7/16"	-	3/4" - 1 7/16"	316 Series Stainless Steel
SLIC MOUNT	Setscrew	1/2" 1 1/2"	1/2" 1 1/2"	1/2" 1 1/2"	-	Composite

## Original SEALMASTER®

**Paver Bearings...** SEALMASTER branded paver bearings are available for asphalt construction equipment. For over fifty years SEALMASTER has been a well-known and well-respected name in the paving industry. Emerson Power Transmission engineers have worked with original equipment manufacturers to design a bearing to withstand the harsh environments of the paving industry. SEALMASTER Paver Bearings incorporate the most innovative materials and technologies, including patented seal technology, to extend the bearing life in abrasive and high-temp applications.



## SEALMASTER RPB

### TAPERED ROLLER BEARINGS... TOUGH AS THEY COME!

*The industry's only heavy-duty bearing units of this type in this compact size range... with unitized, self-aligning replaceable cartridge inserts*

RPB Series Bearings handle combination radial and thrust loads in a broad range of severe duty services... from aggregates to chemical processing... in sawmills and pulp and paper mills... and many more. They provide reliability and performance... with longer service life and increased productivity, reduced maintenance and downtime even under the demanding conditions encountered in these rugged applications.

**Select from more configurations, more sizes for maximum choice**

Choose two and four-bolt pillow blocks in bore sizes from 1 3/16" - 5", flange units piloted flanges and "One-size-fits-all" cartridge inserts in the full range of bore sizes, 1 3/16"-5". All are available for quick shipment from stock.

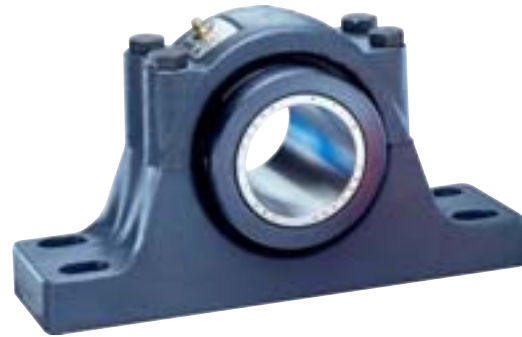
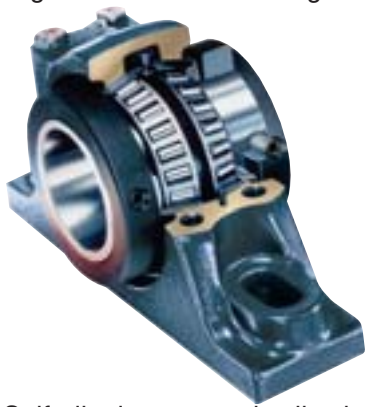

**RPB...** Self-aligning tapered roller bearings offer key features designed to enhance equipment performance and prolong service life.

- Tapered roller bearings - accommodates both radial and thrust loads
- Race mounted felt labyrinth seals with rotating flinger - directs contamination away from the sealing surfaces and provides a tight fit to exclude foreign material
- 3 degree misalignment capability - reduces stress on bearing components
- Alignment pin - ensures positive lubrication and prevents outer race rotation
- Two concentric collars - anchors the bearing to the shaft with four set screws

**RPBXT/ERPBT...** This line of four-bolt roller bearing pillow blocks is available in bore sizes from 2 1/4" through 5". They are interchangeable with SAF style pillow block mounting dimensions and offer users significant cost saving advantages.

- Shaft-ready for easier and faster installation - no assembly required
- Factory adjusted clearance, sealed and lubricated - reduces installation cost
- Quick insert changes out - lowers downtime cost

#### TAPERED ROLLER BEARINGS

Series	Setscrew Locking Collars	Bore Sizes		
		Pillow Blocks	Flange Blocks	Cartridge Units
<b>RPB</b> Split cast Iron housing, fixed & expansion type	Double Single	1 3/16 - 5" 1 3/4 - 3 15/16"	1 3/16 - 4 " 1 3/4 - 4"	1 3/16 - 5"
<b>DRPB</b> Split high-base to shaft-fixed & expansion type	Double Single	1 3/4 - 4" 1 3/4 - 4"	-	-
<b>SPB</b> Split cast steel housings	Double	1 1/2 - 5"	-	-
<b>RPBXT/ERPBT</b> Split cast iron housings expansion & non expansion types	Double	2 1/4 - 5"	-	-
<b>RFB, RFP</b> Split cast iron housings	Double Single	-	1 3/16 - 4 1/2" 1 3/16 - 4 1/2"	1 3/16 - 5" 1 3/16 - 5"



# ROLLER BEARING PRODUCTS



## SEALMASTER SLEEVLLOC<sup>SM</sup> SPHERICAL ROLLER BEARINGS

Incorporates an advanced multi-tapered sleeve arrangement with distinct advantages over collar mounted and other types of adapter locking styles. SLEEVLLOC<sup>SM</sup> Spherical Roller Bearings combine the features of adapter locking in the same housings as unit collar mounted units thus making replacement easy and quick. SLEEVLLOC<sup>SM</sup> Spherical Roller Bearings feature a totally self-contained locking mechanism.

### SPHERICAL ROLLER BEARINGS

Series	Housing Material	Bore Sizes				
		Pillow Blocks	Flange Blocks	Flange Cartridges	Take ups	Flange Brackets
2000	Cast Iron	1 7/16 - 4	1 7/16 - 4	1 7/16 - 4	1 15/16 - 4	1 7/16, 1 15/16, 2 7/16
3000	Ductile Iron	1 15/16 - 4	1 15/16 - 4	1 15/16 - 4	-	-

## SEALMASTER<sup>®</sup> ROD ENDS AND SPHERICAL BEARINGS

*Provide precise motion transfer in linkage applications*

Emerson Power Transmission offers a complete line of SEALMASTER branded precision and commercial series rod ends and spherical bearings for industrial applications. SEALMASTER<sup>®</sup> Rod Ends offer increased fatigue strength, improved resistance to wear and pound out, closely manufactured fits, and self-lubricating DELRIN and TEFLON liners.

These bearings are offered in a broad variety of designs and styles and are available in both male and female configuration, and two and three piece construction. Many bore diameters, thread sizes and application-matched materials are available.



### ROD ENDS

Series	Bore Size	Race Material	Construction
AE/ARE/ARE-20	3/16 - 3/4"	Steel	3 Piece
TR/TRE	3/16 - 1"	Steel	3 Piece
CFF-T/CFM-T	3/16 - 1"	Teflon Liner	2 Piece
TF/TM	3/16 - 3/4"	Bronze	3 Piece
CFF/CFM	3/16 - 1"	Steel	2 Piece
CTFD/CTMD	3/16 - 3/4"	Delrin	3 Piece

### SPHERICAL BEARINGS

SBG	3/16 - 1"	Bronze	2 Piece
SBG-S	3/16 - 1"	H.T. Steel	2 Piece
SBG-SA	1/2 - 1"	H.T. Steel	2 Piece
SBG-SS	3/16 - 1"	Stainless Steel	2 Piece
COR	3/16 - 1"	Stainless Steel, Heat Treated	2 Piece
COM	3/16 - 1"	Steel	2 Piece
FLBG	3/16 - 1"	Bronze	3 Piece
BTS-LS	3/4 - 1 1/2"	Steel	2 Piece
BH-LS	1 - 2"	Steel	2 Piece

DELRIN & TEFLON are registered trademarks of the DuPont Company.





## BROWNING® MOUNTED BALL BEARINGS...

Are segmented into three series ranging from intermediate duty for lightly loaded applications to medium duty for heavier loads:

**100** = Intermediate Duty, **200** = Normal Duty, **300** = Medium Duty



### BALL BEARING UNITS

Series	Locking	Available Options				Bore Size			
		AH	NK	SS	D	Pillow Blocks (High, Low & Tapped Base)	Flange Blocks (2, 3, 4 Bolt)	Flange Cartridges	Take-Up Units
100	Set Screw			✓	✓	1/2" - 2 3/16"	1/2" - 2 3/16"	N/A	3/4" - 2 3/16"
	Eccentric			✓	✓	1/2" - 2 3/16"	1/2" - 2 3/16"	N/A	1/2" - 2 3/16"
200	Set Screw					1/2" - 2 15/16"	1/2" - 2 15/16"	1 1/8" - 2 11/16"	1/2" - 2 7/16"
	Eccentric	⊗	Ⓝ			1/2" - 2 15/16"	1/2" - 2 15/16"	N/A	3/4" - 2 7/16"
	BOA		Ⓝ			3/4" - 2 7/16"	3/4" - 2 7/16"	1 1/8" - 2 7/16"	N/A
300	Set Screw	⊗				1" - 3 15/16"	1" - 3 15/16"	1" - 3 15/16"	1" - 3"
	BOA	⊗				1" - 2 3/16"	1" - 2 3/16"	1" - 2 3/16"	N/A

AH = Air Handling NK = Nickel Plating SS = Stamped Steel Housing D = Ductile Iron Housing

## Corrosion Resistant Mounted Ball Bearings...

**CRES** stands for **Corrosion Resistant Engineered Solutions**... a new look at corrosion resistant power transmission components. CRES Mounted Ball Bearing products start with the latest in corrosion resistance technology coupled with advanced industry-minded features driven by industry-focused leaders. Our engineers designed CRES around the notion that a "family" of corrosion resistant products spanning the spectrum of performance and value will provide customers flexibility and latitude to specify the correct solution when and where they see fit.



**CRES CZ**

Composite housing & zinc coated insert



**CRES CS**

Composite housing & 400 series stainless steel insert

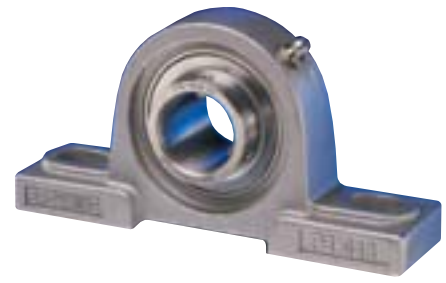

**CRES SS**

300 series stainless steel housing & 400 series stainless steel insert

### CORROSION RESISTANT MOUNTED BALL BEARINGS

Series	Type Locking	Bore Sizes			Housing Material
		Pillow Blocks	Flange 2 & 4 Bolt	Tapped Base	
CRES CZ	Setscrew	3/4" - 1 1/2"	3/4" - 1 1/2"	3/4" - 1 1/2"	Composite
CRES CS	Setscrew	3/4" - 1 1/2"	3/4" - 1 1/2"	3/4" - 1 1/2"	Composite
CRES SS	Setscrew	3/4" - 1 1/2"	3/4" - 1 1/2"	3/4" - 1 1/2"	300 Series Stainless Steel

# MOUNTED BEARINGS

**BROWNING BEARING TECHNOLOGY PAYS OFF WHERE IT COUNTS MOST...**

## **BROWNING® SPHERICAL BEARINGS 1100/1101 Series**

**Housings...** 1001 Series cast iron is dimensionally interchangeable with the 1000 Series set screw locking spherical roller bearings from BROWNING.

1101 Series ductile iron is dimensionally interchangeable with the old style 1100 Series.



**1100/1101 Pillow Blocks...** New and improved 1100/1101 Series Pillow Blocks have a solid base beneath the bolt holes and thicker mounting feet.

**1100/1101 Four Bolt Flanges...** New and improved 1100/1101 Series Square Four Bolt Flange design contains more material to withstand shock loads and vibration normally found in sawmill applications.

**1100/1101 Flange Cartridges...** New and improved 1100/1101 Series Flange Cartridges have thicker bolt hole mounting pads. Withdrawal holes in the housing help remove the units from their mounting structure during replacement.

### TAPERED ROLLER BEARINGS

Series	Locking	Features				Bore Size			
		E	SA	SH	D	Pillow Blocks (2 & 4 Bolt)	Flange Blocks (4 Bolt)	Flange Cartridges	Take-Up Units
900	Eccentric				✓	1" - 5"	1" - 4 1/2"	1" - 3 1/2"	1 7/8" - 4"
E920	Set Screw					1 3/16" - 5"	1 3/16" - 4"	N/A	1 3/8" - 4 7/16"
950	Eccentric	✓	✓	✓	✓	1 7/16" - 5"	1 7/16" - 5"	N/A	N/A
970	Set Screw	✓	✓	✓	✓	1 3/8" - 5"	1 3/8" - 5"	N/A	N/A

E = Expansion Available SA = Self Aligning SH = Split Housing D = Ductile Iron Housing

### SPHERICAL ROLLER BEARINGS

Series	Locking	Features					Bore Size			
		E	SA	SH	CI	D	Pillow Blocks (2 & 4 Bolt)	Flange Blocks (3 & 4 Bolt)	Flange Cartridges	Take-Up Units
1000	Set Screw	✓	✓		✓		1" - 5"	1 3/8" - 4"	1 7/16" - 4"	1 15/16" - 4"
1001	Eccentric	✓	✓		✓		1 15/16" - 3 15/16"	1 15/16" - 3 15/16"	1 15/16" - 3 15/16"	N/A
1100	Set Screw	✓	✓			✓	1 15/16" - 3 1/2"	1 15/16" - 3 1/2"	1 15/16" - 4"	N/A
1101	Eccentric	✓	✓			✓	1 15/16" - 3 15/16"	1 15/16" - 3 15/16"	1 15/16" - 3 15/16"	N/A
22200	Cylindrical	✓	✓	✓		*	3" - 8 5/16"	N/A	N/A	N/A
22500	Adapter	✓	✓	✓		*	2 7/16" - 8"	N/A	N/A	N/A

E = Expansion Available SA = Self Aligning SH = Split Housing CI = Cast Iron D = Ductile Iron Housing  
\*Cast Steel Housing Available

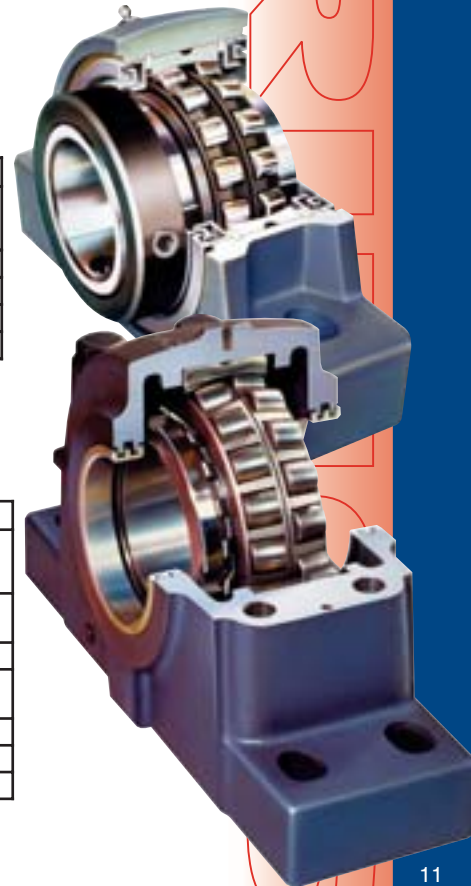

BROWNING

## NO OTHER COMPANY COMES CLOSE TO MATCHING OUR BREADTH OF LINE, OR OUR UNIQUE CAPABILITIES IN SOLVING APPLICATION PROBLEMS...

When you're looking for the right cam follower for your application, come to *the company that invented cam followers: McGILL*. Since 1937 we have expanded our line to over 1,400 different configurations, more than any other manufacturer. In addition, our engineers have extensive experience in solving customers problems.



**CF...** Series stud type CAMROL bearings are designed for cantilever (overhung) mounting. Available in both inch and metric sizes.



CF-CR Series  
CYR-CR Series

**NEW!**

**CRES CAMROL® Bearings...** Utilize stainless steel construction to help solve your corrosion problems. The cam followers are specially designed to be used in the food, beverage, and pharmaceutical industries or in any applications where water or washdown may be present.

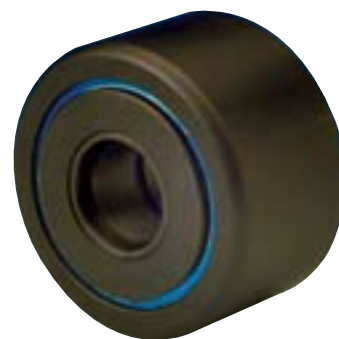

**CYR...** Series yoke type CAMROL bearings are designed for straddle (yoke) mounting on a customer furnished shaft. Available in both inch and metric sizes.

### CAMROL Cam Follower Bearings...

Cam followers all have heavy outer rings to withstand the intermittent shock and heavy loads associated with cam applications and linear guide applications. All standard CAMROL bearings have a black oxide finish on all external surfaces to extend life by helping inhibit rust. Choose from a wide range of sizes and optional features, including the LUBRI-DISC® Seal which extend bearing life by reducing internal bearing friction, retaining lubrication and helping keep out contaminants.

#### CAMROL CAM FOLLOWER BEARINGS <sup>1,2</sup>

Series	Outer Ring Diameter Size Range	Optional Sealing	Type	Internal Construction
CF	1/2 - 10"	LUBRI-DISC® seal	Standard or Eccentric Stud with Screw Driver Slot or Hex Hole	Full Complement of Needle Rollers
CFH	1/2 - 7"	LUBRI-DISC® seal	Heavy Stud, with Screw Driver Slot or Hex Hole	Full Complement of Needle Rollers
CYR	3/4 - 10"	LUBRI-DISC® seal	Yoke	Full Complement of Needle Rollers
BCF-S	1/2 - 4"	LUBRI-DISC® seal	Standard or Eccentric Stud with Screw Driver Slot or Hex Hole	Non-Metallic Bushing
BCYR-S	3/4 - 4"	LUBRI-DISC® seal	Yoke	Non-Metallic Bushing
MCF®	13 - 90 (mm)	LUBRI-DISC® seal	Standard or Eccentric Stud with Screw Driver Slot or Hex Hole	Full Complement or Caged Needle Rollers
MCYR®	Diameter 16 - 90 (mm)	LUBRI-DISC® seal	Yoke	Full Complement or Caged Needle Rollers
MCFD®	35 - 90 (mm)	Shield	Standard Stud with screwdriver slot	Full Complement Cylindrical Rollers
MCYRD®	Diameter 35 - 90 (mm)	Shield	Yoke	Full Complement Cylindrical Rollers
SDCF	1 - 4	Heavy-Duty Seal	Standard Stud	Needle Rollers with Retainer
SDMCF	25 - 100 (mm)	LUBRI-DISC® seal	Standard Stud	Needle Rollers with Retainer
CF-CR	1/2 - 2	LUBRI-DISC® seal	Standard or Eccentric Stud with Hex Hole	Full Complement of Needle Rollers
CYR-CR	3/4 - 2	LUBRI-DISC® seal	Yoke	Full Complement of Needle Rollers
CFD	1 1/4 - 6	Rubber Lip Seals	Standard Stud with Hex Hole	Double Row of Cylindrical Rollers
CYRD	1 1/4 - 6	Rubber Lip Seals	Yoke	Double Row of Cylindrical Rollers

1. Outer race shape may be cylindrical or crowned on all types.

2. Most sizes can be relubricated; consult factory for grease specifications.

# CAM FOLLOWERS

**Special-Duty CAMROL® Bearings...** Designed for tough environments and loaded with features. McGILL engineers designed these bearings especially for situations involving lube-for-life conditions and dirty environments such as automotive welding applications.



**SDCF Series**  
**SDMCF Series**

**Heavy-Duty CAMROL® Bearings...** Utilize a double row of cylindrical rollers for situations involving thrust loads, contamination or maintenance-free operation. Heavy-Duty CAMROL® Bearings provide significant operational life increases over standard cam follower in some situations.

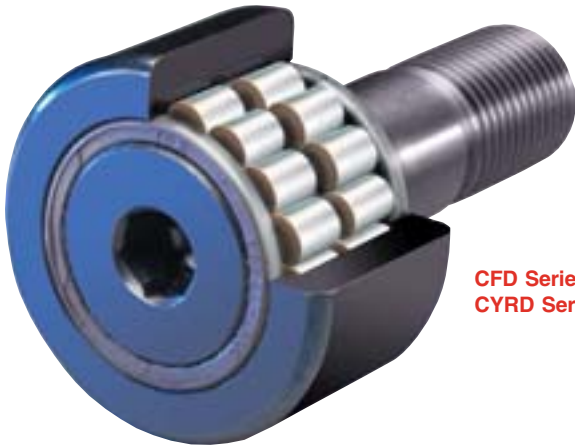

**CFD Series**  
**CYRD Series**

**NEW!**

**Yoke TRAKROL® Bearings...** are designed for yoke (straddle) mounting on a shaft and utilize tapered roller bearings. Available in three standard configurations.

**VCYR Series**



**FCYR Series**

**PCYR Series**

**TRAKROL® Track Roller Bearings...**

TRAKROL Bearings from McGILL are built with features and performance characteristics not available with needle roller bearings. They are double-sealed for more demanding environments and built for longer life under combination radial and thrust loads. Sizes 1 1/2" - 2 3/4" O.D. feature heavy-duty ball bearings; sizes 3" - 8" feature tapered roller bearing construction. All sizes have large lubrication reservoirs for extended maintenance-free operation.



**PCF Series** TRAKROL bearing, with plain OD.



**FCF Series** TRAKROL bearing, with flanged OD.



**VCF Series** TRAKROL bearing, with V-groove OD.

## TRAKROL TRACK ROLLER, AND GUIDE BEARINGS\*

Type	Series	Roller	OD Shape	Seals
Standard or Eccentric Stud	PCF	1 1/2" - 8"	Plain Cylindrical	Rubber Lip Seals and End Plug
	VCF	3 1/2" - 8 1/2"	V-Grooved	
	FCF	1 1/2" - 8"	Flange	
Yoke	PCYR	3" - 6"	Plain Cylindrical	Rubber Lip Seals
	VCYR	4 1/2" - 6 1/2"	V-Grooved	
	FCYR	3" - 6"	Flange	

\* Standard operating temperature range is -30°F to 225°F.



## McGILL NEEDLE AND SPHERICAL BEARINGS STAND OUT IN YOUR HEAVY-DUTY APPLICATIONS

### CAGEROL® And GUIDEROL®

#### Heavy-Duty Needle Bearings...

McGILL has a broad variety of heavy-duty needle bearings, with two series to choose from: CAGEROL and GUIDEROL bearings.



**CAGEROL®** Needle bearings are designed to accommodate higher speeds and some misalignment. Crowned rollers help increase the load rating of the bearings and steel cages provide accurate roller guidance.



**GUIDEROL®** Needle bearings utilize a full complement of needle rollers extending virtually the complete width of the outer race. They are designed for tough applications requiring higher static load capacity and more radial rigidity.

### CAGEROL AND GUIDEROL HEAVY-DUTY NEEDLE BEARINGS

Series*	Outer Race OD Size Range	Inner Race Bore Size	NeedleRoller Type
Cagerol (MR)	1 1/8 - 11 1/8"	3/8 - 8"	Caged
Cagerol Sealed (MR)	1 1/8 - 5 1/4"	3/8 - 3 3/4"	Caged
Guiderol (GR)	1 - 11 1/8"	3/8 - 8"	Full Complement
Guiderol Sealed (GR)	1 1/8 - 5 1/4"	3/8 - 3 3/4"	Full Complement
MI	Inner Race Only	3/8 - 8"	N/A

\* Outer ring and roller assemblies (MR) or (GR) and associated inner rings (MI) are packed and shipped separately. Each type has its own number and both outer and inner numbers should be specified when ordering a complete bearing.

### SPHERE-ROL® Bearings...

The industry's only "off the shelf" spherical roller bearing series with seals.

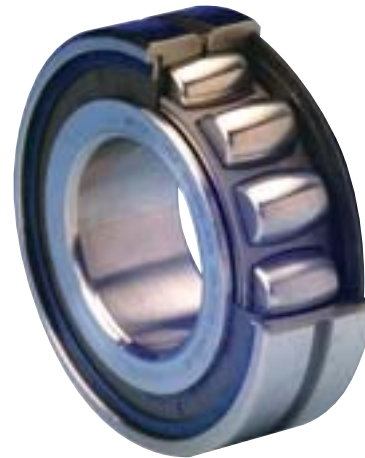

Invented by McGILL engineers over 30 years ago, SPHERE-ROL bearings utilize a single row of spherical rollers which provide a wide variety of advantages. High capacities, high limiting speeds, longer life under more misalignment and protection from contaminants - All these features allow more design flexibility than typically possible with ordinary two-row designs.

### Reduce your costs with SPHERE-ROL bearings

Seals on SPHERE-ROL bearings extend bearing life by helping keep lubricant in and contaminants out. The result is often a **total cost savings**: reduced downtime for maintenance and less frequent bearing replacement.

### Dimensionally interchangeable with unsealed designs

The dimensions of SPHERE-ROL bearings with integral NYLAPLATE® seals meet ABMA/ISO specifications.

**Choose from three seal types to fit your application:**

#### NYLAPLATE® Seals

#### NYLAPLATE® High temperature seals

#### LAMBDA® Seals

### SPHERE-ROL SPHERICAL ROLLER BEARINGS

Series	Bore	Outside Diameters
22200	.5906 - 5.9055" 15 - 150mm	1.3780 - 10.6299 35 - 270mm
22300	1.5748 - 3.9370" 40 - 100mm	3.5433 - 8.4646" 90 - 215mm

# AEROSPACE BEARINGS

## Aircraft and special engineered-to-the-application bearings...

When standard off-the-shelf bearings can't provide the performance and flexibility you require, you can redesign the application... or McGILL engineers can provide a creative solution through innovative engineering. So whether it's modifying an existing standard design or developing a complete made to order special, McGILL products can provide practical, reliable and economic solutions to your bearing applications.



## Aircraft track roller and housing mounted airframe bearings...

McGILL's aircraft bearings are custom engineered for specific applications on both fixed wing aircraft and helicopters for military and commercial services. They meet a broad variety of U.S. Military specifications, as well as numerous world-wide aircraft quality standards.



### AIRCRAFT TRACK ROLLER AND HOUSING MOUNTED AIRFRAME BEARINGS

Series	Military Standard Number MS	Bore Size	Outer Ring OD Size Range
NBF	24465	.1900 - 2.7500"	.7500 - 5.000"
NBL	24466	.3750 - 2.0000"	1.1250 - 3.8750"
AFC	21438	.1900 - 2.7500"	.7500 - 5.000"
AL	21439	.3750 - 2.0000"	1.1250 - 3.8750"
NBE	24463	.1900 - .3125	.8750 - 1.0625"
NBK	24464	.3750 - 3.500"	1.1875 - 4.8750
NBC	24461	.1900 - 4.000"	.6875 - 4.8750"
HRS Cylindrical OD	21432	Integral Stud	.5000 - 1.1250"
CHRS Crowned OD	21447	Integral Stud	.5000 - 1.1250"

McGILL BEARINGS

***ROLLWAY offers a wide array of cylindrical, spherical and thrust bearings that are the answer to your toughest application problems. Whether you're extruding food products or making the metals that keep America moving, ROLLWAY has engineered bearings for your application. These are just a few of our problem solving bearings...***

The name "ROLLWAY" has been synonymous with precision and quality craftsmanship on heavy-duty roller bearings since 1908, offering more than 2,000 different bearing products with sizes ranging up to 42 inch outside diameters. The ongoing mission of ROLLWAY traditionally has been the advancement of bearing technology. To that end, the company has maintained a strong position of leadership in industrial, military, and aerospace markets.



## **ROLLWAY Cylindrical Radial Roller Bearings**

- Standard Series - 1000, 5000, 100, 5100, 1200, 5200, 6200, 1300, 5300, 400
- Extra Capacity Series - 200, 2200, 300, 2300
- Steel Cage Journal Bearings - Metric 200 & 300 series
- Custom Engineered Bearings up to 42" outside diameter

## **ROLLWAY Roller Thrust Bearings**

- Inch Series Cylindrical Roller Designs; single acting, single acting aligning, double acting, double acting aligning
- Tandem Roller Bearings; inch and metric design with 2 to 8 stages
- Tapered Roller Bearing Designs; TTHD double taper and T-flat (TTVF)
- Custom Engineered Bearings up to 42" outside

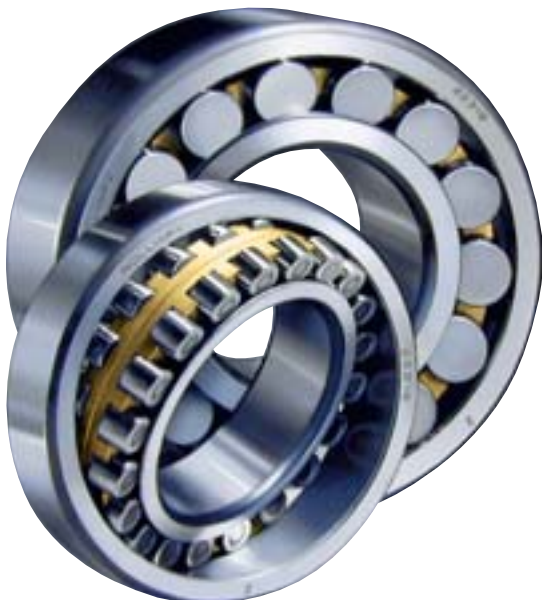

## **ROLLWAY Spherical Roller Bearings**

- Double Row Spherical Roller Bearings
- Industry Standard Metric Designs
- Bearing Quality Steel
- Machined Retainers



# HEAVY-DUTY BEARINGS

## ***Tapered Roller Thrust Bearings are engineered for efficient operation in your application***

These rugged, reliable bearings feature true rolling motion, with the vertex of the conical sections meeting at the bearing axis. Rollers are crowned for optimum contact stress patterns, and the large ends of the rollers are spherically ground. These bearings are widely used in extruders, oil well swivels, coal crushers, metal rolling mills (in mill screw-down applications), pulp refiners and many other heavy duty applications. They are ideal for OEM, replacement or conversion use.

## ***Extra-capacity metric cylindrical roller bearings***

No longer do producers or users of internationally-made machinery have to look overseas for quality metric bearings.

Typical applications include: off-highway equipment, industrial gearboxes, extrusion equipment, electric motors, hydraulic pumps and a wide range of other heavy-duty services.

## ***ROLLWAY Bearings high quality, high performance, high Value***

ROLLWAY has a rich history of providing engineered solutions to your bearing problems. Our engineering staff welcomes the opportunity to design custom and special bearings for your demanding applications.

### **Modifications include:**

- Non-typical sizes, up to 42" outside diameter
- Anti-Rotation features - Notches, slots and holes
- Special materials
  - Plates and rollers - M-50 tool steel carburizing steel and VIMVAR grade steels
  - Retainers - Brass, cast iron and phenolic
- Special retainer design for high speed applications
- Thin dense nodular chrome plate (TDC) special custom designs in low quantities
- Special custom designs in low quantities



BEARINGS



**A COMPLETE SELECTION OF BROWNING PRODUCTS LEADS TO THE RIGHT V-BELT FOR EVERY APPLICATION**

The extensive BROWNING V-drive line means maximum economy, versatility and prompt availability for your every application — truly the *right drive every time...for every service*

**BROWNING B5V®... The most significant advance in belt drives since the V-groove!**

With the introduction of the revolutionary B5V line, BROWNING brings up-to-the-minute technology to drive design, operation and inventory control. Now — more than ever — when you specify BROWNING, you select from the most extensive V-belt drive line in the world.

- **New combination groove B5V®** - with 170 plus components covering 10-125 HP range. Mix and match with conventional A, B and 5V components



**CLASSICAL GRIPBELT SHEAVES -- BUSHING TYPE**

Belt Size	Sheave	Grooves	DD/PD*	Bore Range
A	AKH	1-2	2.8-18.0	1/2"-1 1/2"
	AK**	1-2	1.8-18.0	3/8-1 7/16
	TA	1-4	3.0-24.5	1/2-2 11/16
A-B	BKH	1-3	2.8-18.4	1/2-1 1/2
	BK**	1-3	2.2-18.4	3/8-1 7/16
	TB	1-6	A-3.0-37.5	1/2-2 11/16
		B	2-10	B-3.4-38.0 A-5.0-37.5 B-5.4-38.0
A-B-5V	B5V	1-6	A-3.8-27.3 B-4.2-27.8 5V-4.3-27.5	1/2-2 7/16
C	TC	1-6	7.0-24.0	3/4-2 11/16
	C	1-12	5.6-50.0	1/2-5
D	D	4-12	12.0-48.0	1 3/8-5
<b>"358" GRIPBELT SHEAVES</b>				
3V	3V	1-10	2.6-33.45	3/8-4 1/4
	3V**	1-4	2.6-3.3	5/8-1 3/8
5V	5V	1-10	4.3-49.9	1/2-5
8V	8V	4-16	12.3-63.8	1 11/16-7 7/16

\* Datum Dia. for A-B-C-D, Pitch Dia. for "358".

\*\* Finished Bore Type.

# WORLD-FAMOUS V-DRIVES

- **Multiple groove sheaves** available in over 2100 stock sizes, far more than from any other manufacturer
- **Cast iron sheaves** - Over 3000 AK/BK size and bore combinations in stock, in-shaft ready bushing type and finished bore
- **"358" Sheaves** stocked in a range of fixed and variable pitch sizes
- **Variable speed sheaves** through 750 HP, precision balanced to provide smooth vibration-free performance

## VARIABLE SPEED SHEAVES

Type	Groove	Belt	DD/PD	Bore Range	
VL	Fin. Bore	1	3L, 4L/A, 5L/B	1.6-3.8	1/2-7/8"
VM	Fin. Bore	1	3L, 4L/A, 5L/B	1.9-4.7	1/2-7/8"
VP	Fin. Bore	1-2	3L, 4L/A, 5L/B, 5V	1.4-7.4	1/2-1 5/8"
LVP	Bushing	1-2	A, B, 5V	4.2-8.4	1/2-1 3/4"
	Fin. Bore	1-2	A, B, 5V	3.4-8.4	7/8-1 7/8"
MVP	Bushing	2-6	A, B, C, 5V	5.9-12.5	3/4-2 5/8"
	Fin. Bore	3-10	A, B, C, 5V, 8V	3.4-17.2	7/8-4 3/4"

## COMPANION SHEAVES

Type	Groove	Belt Size	DD/PD	Bore Range	
MVP	Bushing Type	3-6	A, B, C, D, 5V, 8V	4.6-52.8	1/2-7 7/16"

- **FHP drives** - Economical sheaves of pressed steel, zinc alloy and formed steel for lighter duty applications

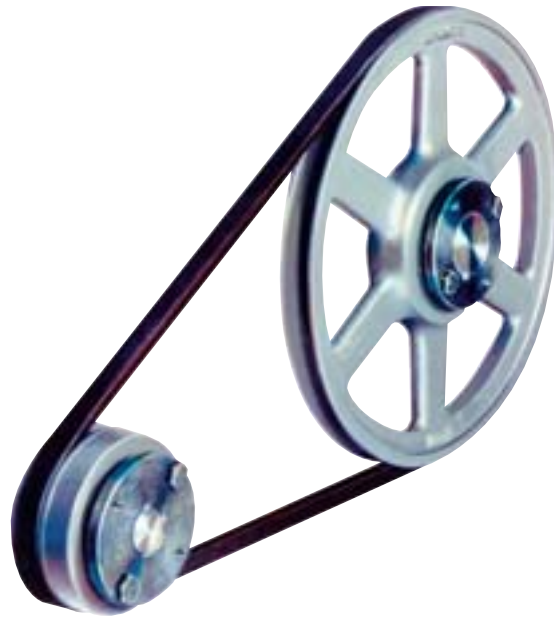

## FHP BELTS

Type	2L	3L	4L	5L
FHP	080-345	110-630	170-1000	230-1000

## SINGLE GROOVE SHEAVES, Finished Bore

Type	Belt	DD/PD	Bore Range	
Bar Steel & Pressed Steel	AS, BS	4L/A, 5LB	1.25-18.4	1/2-1 7/16"
Die Cast	AZ, BZ, SCZ*	3L, 4L, 5L	1.25-13.75	3/8-1"
Lightweight Cast Iron (air moving)	OL, AL, AM	3L, 4L/A	4.8-14.0	1/2-1"

\* Step Cone Sheave.

- **Poly-V®**, the multiple V-belt in a single unit -- eliminates belt matching, provides more horsepower in same space or same horsepower in less space. Over 400 stock sheave sizes, 1/4 HP and up

## POLY-V® DRIVES

Cross Section	Grooves	Pitch Dia.	Bore Range*	Pitch Lengths
J-3/32" Rib	4-6	1.25-1.90"	FB 3/8-1"	18.0-98.0"
	4-16	2.00-10.60	3/8-2 11/16"	
L-3/16" Rib	6-20	3.00-30.00	1/2-3 3/4"	520.0-145.5
M-3/8" Rib	6-20	7.00-44.00	3/4-4 1/4"	90.0-198.0

\* FB = Finished Bore. Others are bushing type.

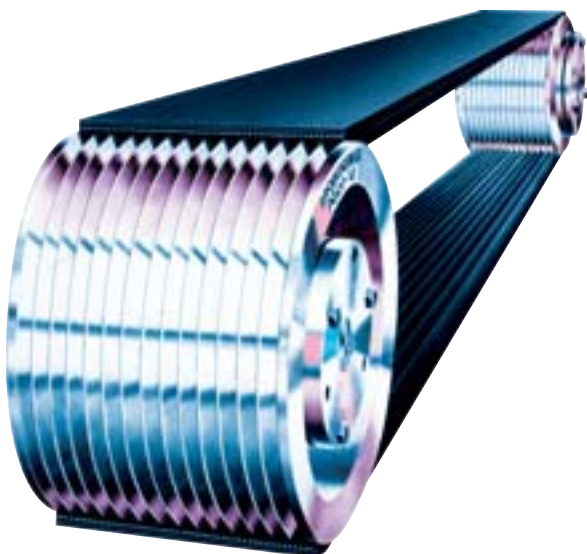

Poly-V is a registered trademark of Goodyear Tire & Rubber Co.

COMPLEMENT



**MORE HORSEPOWER  
PER DOLLAR...**

The **BROWNING RPP® PANTHER® Synchronous Drives** provide up to 200% more horsepower than similar sizes of HPT® Belts. The advanced belt design will allow the product to provide *More Horsepower Per Dollar* than traditional synchronous belt drive products.

### RPP® PANTHER® SYNCHRONOUS BELT DRIVES

Pitch	Sprockets		Belts	
	Grooves	Bore Range	Width	Length
8 mm	22-192	1/2-4 1/4	12, 22, 35, 60 mm	480-4400 mm
14 mm	28-216	1/2-7 7/16	20, 42, 65, 90, 120, mm	966-4956 mm

### Advantages include:

- High Performance
- High Efficiency
- Synchronization
- High Speed Drive
- Environmentally Cleaner
- No Lubrication Required
- Durable
- Versatile
- Tough
- Specials Availability

Note: PANTHER®, and RPP® are registered trademarks of DAYCO Products, Inc. and are used by Emerson Power Transmission under license from DAYCO.

The **BROWNING HPT® Synchronous Drive line** offers a wide range of HP and speeds, from very low speeds — 10 RPM or less — to speed well over 5,000 RPM, with horsepower ratings from fractional to more than 200 HP.

### Features and benefits include:

- Significantly quieter operation
- New parabolic tooth profile
- Glass fiber cord tension member
- Neoprene rubber body
- Nylon facing fabric
- Positive drive, no slip
- Lower belt tensions
- No lubrication required
- Fully interchangeable with competitive types



### HPT SYNCHRONOUS BELT DRIVES

Pitch	Sprockets		Belts	
	Grooves	Bore Range	Width	Length
8 mm	22 - 192	1/2 - 3 1/2	20, 30, 50, 85 mm	480 - 4400 mm
14 mm	28 - 216	1/2 - 5 1/2	40, 55, 85, 115, 170 mm	966 - 6860 mm

**Gearbelt® Drives** are offered in five stock pitches to handle a wide range of loads, speeds and applications.

### Advantages include:

- Constant speed
- High modulus strength member
- Freedom from initial belt tension
- Compact design
- Lightweight
- Less heat

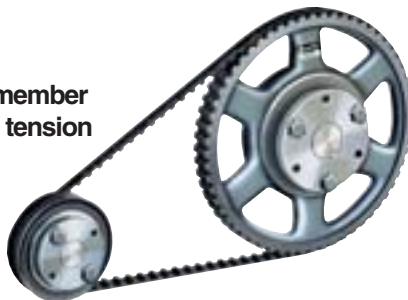

### GEARBELT DRIVES

Pitch	Gearbelt Pulleys		Gearbelts			
	Grooves	Bore Range*	Belt Width	Pitch Length	No. Teeth	
XL	1/5"	10-72	MB 3/16-1"	1/4-5/16-3/8***	6.0"-26.0"	30-130
		10-17	FB 3/8-1"			
L	3/8"	18-40	MB 1/2-2 3/8	1/2-3/4"	12.375-60.0	33-160
		18-120	3/8-1 3/4			
		14-30	MB 5/8-2 3/8			
H	1/2"	14-156	3/8-3 3/4	3/4-1-1 1/2-2-3***	24.0-170.00	48-340
		18-26	MB 1-3 3/4			
XH	7/8"	18-120	3/4-4 1/4		50.75-175.0	58-200
		18-90	1 1/8-5	2-3-4-5-6-8		

**BROWNING HPT® and Gearbelt® Drives** offer a choice of the popular SPLIT TAPER™ bushing or QD® bushing for sprockets/pulleys. The **RPP® PANTHER® Drives** offer only the SPLIT TAPER™ bushing.

\*MB = Minimum Bore. FB = Finished Bore. Others are Bushing Type.

\*\*Double Gearbelts available in XL, L, & H sizes.

## MORSE CLUTCHES...

Choose from the industry's broadest line of conveyor backstop, overrunning, indexing and overload designs

### Typical applications include:

- Machining centers
- Printing presses
- Packaging equipment
- Conveyors
- Standby drives
- Pump applications
- HVAC
- Food processing
- Construction
- Steelmaking

### Cam and Roller-Ramp Clutches

The MORSE line of precision Cam and Roller-Ramp clutches, available in ten series, offers one of the most versatile and complete selections in the industry. These are designed to perform three basic modes of operation: overrunning, indexing and backstopping. Compared to competitive clutches of similar designs, MORSE offers exceptional speed, torque and service life in a variety of applications: from small business machines to high horsepower conveyors.



MORSE Cam and Roller-Ramp clutches are also referred to as freewheels, sprag or one way clutches. They have hundreds of uses.

High Temperature poly-acrylic lip seals for long life and low maintenance

Precision ball bearings provide smooth-running dependable operation

Exclusive patented venting design through inner race reduces drag resistance and permits higher overrunning speeds

Full range of bore sizes through 6.437", torque range through 25,000 ft/lbs.

Clutch races of high-quality alloy steel, precision ground to provide accurate cam action

Precision finished cams of high-speed steel provide extra long wear and fatigue life

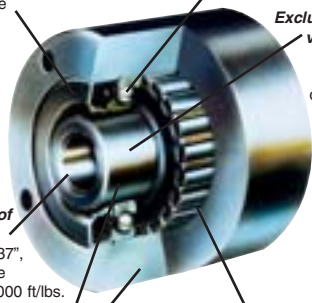

### CONVEYOR BACKSTOP CLUTCHES...

CB Series backstop clutches are extremely low maintenance because of a unique seal design and synthetic grease lubrication. The advanced engineering concepts of this rugged clutch have been proven in the field on the most demanding conveyor, bucket elevator and other applications for over 20 years. Mounted to a head shaft CB Series clutches prevent unwanted reverse rotation.



## MORSE & BROWNING

### Overload safety devices...

1. **BROWNING TORQ/GARD®** Overload Clutches help protect the entire drive train of your machinery from damage due to excessive torque generated by overloads and jamming. Instant reaction when torque exceeds preset limits provides protection far superior to that of clutches employing friction surfaces.
2. **BROWNING TORQ/PRO™** Ball Detent Overload Clutches are designed to protect from overload situations and the resultant potential damage and downtime. They have many of the same features described above and serve a wide range of general overload applications.
3. **BROWNING & MORSE TORQUE LIMITERS** Are proven friction overload protection devices. These units provide a simple, compact, easily adjustable and durable mechanism used successfully in many types of applications.
4. **BROWNING SHEAR PIN HUBS** Are designed to prevent damage to machinery due to sudden overload or jamming by shearing a necked pin at a predetermined load.



### SPECIFICATIONS AND RANGES

Type	Bore Range		Torque Range (Ft/Lbs)
	Inch	Metric	
<b>Cam/Roller-Ramp</b>			
Backstop	.425 - 13.5	8 - 340mm	3.5 - 250,000
Overrunning	.425 - 6.437	8 - 150mm	3.5 - 25,000
Indexing	.425 - 6.437	8 - 150mm	3.5 - 25,000
<b>CB Conveyor Backstop</b>	-	60 - 340mm	6,500 - 250,000
<b>KK® Clutches</b>	-	17 - 35mm	30 - 175
<b>OVERLOAD SAFETY DEVICES</b>			
<b>TORQ/GARD®</b> Overload Clutch	.375 - 2.437	12 - 55mm	1 - 675
<b>TORQ/PRO™</b> Ball Detent Overload Clutch	.375 - 2.75	12 - 70mm	7 - 795
<b>Torque Limiter</b>	.375 - 4.875	-	1 - 6,300
<b>Shear Pin Hubs</b>	.375 - 5.000	-	78 - 21,572

MORSE

## MORSE CHAIN... LINKS YOU TO A WORLD OF MAXIMUM PERFORMANCE, MINIMUM COSTS

### MORSE Roller and other Chain products provide your strongest link to savings

No other company offers all these exclusive cost-saving features and benefits in reliable chain drives. You can select from a full range of pre-stressed roller chain: standard and heavy series, single and multiple strand; custom conveyor chain with a variety of attachments; specialty chain; HV inverted tooth and SC Silent Chain, plus many more specialized designs.

All chain is manufactured to precision standards utilizing world-class technology. The designed-in, built-in quality and superior American manufacturing methods produce MORSE brand chains with higher horsepower ratings. This means you can design a more compact new drive, or benefit from a higher service factor on an existing one, obtain longer chain/drive life with reduced maintenance, and reduce original purchase price and overall costs. The potential for savings is significant. Check out these top-quality features and resultant benefits. **See catalog DC98 condensed for the full story or OFC-99 for our oilfield offering.**

#### ASME/ANSI ROLLER CHAIN

Single Strand	Pitch
Standard series .....	25-200
Heavy series .....	60-200
High strength .....	60-200
Lubed for life .....	40-80
MOR-Twist .....	140-160
Standard attachment .....	25-160
<b>Double Pitch Conveyor</b>	
Standard roller .....	2040-2120
Large roller .....	2042-2122
Double pitch attachment .....	C2040-C2122
<b>Other</b>	
Leaf .....	BL4-BL16
Rollerless hoist .....	60-100
Wrench .....	50
Agricultural .....	80
Thermoplastic .....	25-40
HV inverted tooth chain .....	3/8-2
SC silent chain .....	3/16-1
Stainless steel .....	25-80
Nickel plated .....	35-60
Moisture guard .....	35-80
Custom moisture guard .....	Most sizes/styles
Pre-lubricated .....	40-80
<b>MULTI FLEX</b> .....	100-200
<b>Multiple strand standard</b>	
Double, triple, quadruple .....	35-200
Quintuple, sextuple, octuple .....	60-160
Heavy	
Double, triple, quadruple .....	60-200
Quintuple, sextuple .....	60-160
Pre-lubricated double .....	40-50

**One piece - coaxial design**  
concentric design provides exceptional dimensional characteristics, reduces wear and provides longer life

**Shot peened rollers** for optimal wall thickness, finer finish, more impact strength

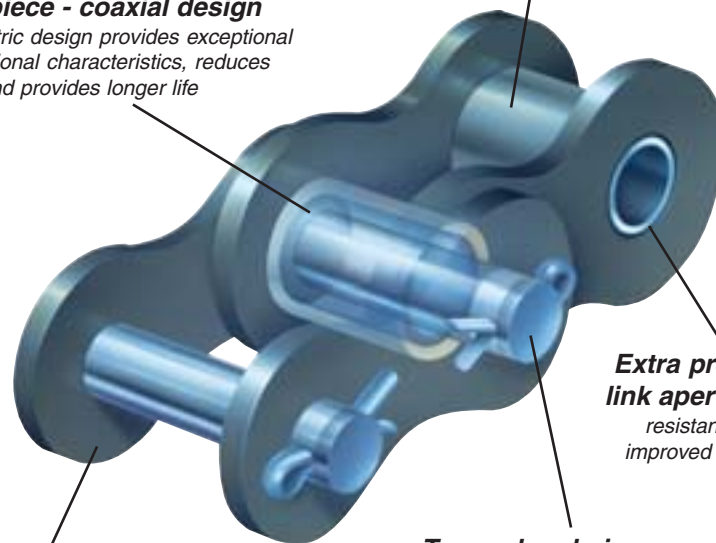

**Extra processing of link apertures** - fatigue resistant surface finish, improved pin contact and retention

**Parallel punched link plates**  
natural barrier to fatigue cracks

**Tapered end pins** - smooth trouble-free assembly, helps prevent link-plate damage

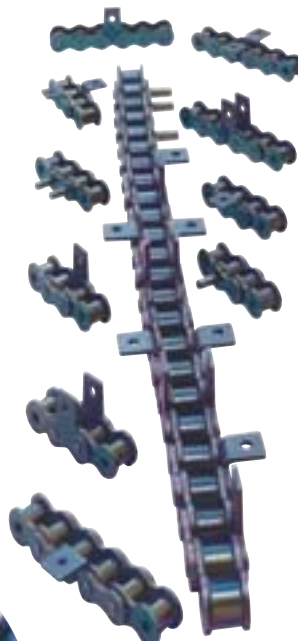

**MORSE Attachment Chain** is offered in a significant breadth of line — 35 to 160, C2040 to C2122, with excellent custom design capabilities. The MORSE “Specialty Chain Center” is a dedicated facility with its own staff of specialists that provides custom products faster to meet today’s market requirements. Request **Specialty and Attachment Chain Design Manual ATC-00**.

**Corrosion Resistant Moisture Guard** Chain offers high strength and durability with economical corrosion protection. Stocked in sizes 35-80. Request **CRC-99**.

**BROWNING Chain** offers value-priced ASME performance.

## BROWNING OFFERS THE WORLD'S LARGEST SELECTION OF APPLICATION-MATCHED, SHAFT-READY SPROCKETS

*That's your assurance of maximum drive efficiency at the lowest evaluated cost*

You can choose from the world's largest selection of high-quality, shaft-ready sprockets to solve all your application problems. In-stock hardened sprockets, a BROWNING specialty, are warranted to last at least twice as long as the standard (unhardened) mild steel sprockets they replace. The result is increased chain life and reduced downtime.

Additionally, you have the industry's broadest selection of sprocket mounting choices. Sprockets are available with three types of bushings to ensure secure mounting to shaft:

- Patented **SPLIT TAPER™** Bushing — available in inch and metric sizes, as well as with spline bores; bore range 1/4-10"
- **Q-D®** Bushing in 1/16 inch increments and metric sizes
- **TAPER BORE™** in the same configurations
- Finished Bore Sprockets are provided with Hardened Teeth and 2 Setscrews for driver sprockets, (30 teeth and smaller)
- Minimum Bore Sprockets are provided from stock to allow for our customers' requirements for simple modifications with same day delivery service
- Browning continues to provide custom sprockets for a variety of applications up through 60" diameters
- The combination of the above provides one of the broadest selection of stock sprockets in the industry



SPLIT TAPER™ Bushing



Q-D® Bushing



TAPER BORE™ Bushing



Bushing type hardened sprocket and BROWNING's exclusive warranty: Twice the life of a standard sprocket.

### STANDARD & HARDENED SPROCKETS

TYPE	No. Strands	Pitch Range	Bore Range	Hardened Teeth
Bushing Type	1	35-200	3/8-5"	Up to 30 teeth
	2	35-160	3/8-5 7/8	Up to 30 teeth
	3	35-100	1/2-4 1/2	-
Finished Bore	1	35-80	3/8-2 15/16	Up to 30 teeth
Type B Min. Bore	1	25-200	1/4-6 1/2	-
	2	35-200	1/2-7	-
Type A Steel Plate	1	25-200	Stock Bores	-

### OTHER SPROCKETS

Double Single Sprockets	1	40-100	3/8-3 3/4	All
Extended Pitch Sprockets	1	2040-2080	3/8-2 11/16	-
		2040-2082	5/8-3	-
		2102	1 1/4-3	-
Shear Pin Sprockets & Hubs	1	40-160	3/8-5	-
Torque Limiters & Sprockets	-	35-80	1/2-2 1/2	-

To ensure optimum quality and reliability, BROWNING uses precision gear checking quality techniques in manufacturing these sprockets.

\* Split Taper - #40 & #50 pitch only, balance of all bushed sprockets - up through 30 teeth.



## MORSE OFFERS THREE LINES OF FULLY-INTEGRATED CONVEYING COMPONENTS

*These high quality, high performance systems handle a multiplicity of tough container handling tasks... Offers users optimum versatility, variety and value*

### 1. ULTOP® Family Of Conveyor Modules...

The **ULTIMATE** in container handling... Built for speed and smooth performance.

**Addressing today's HOT ISSUES in beverage plants...**

- Increased speed of production lines
- Improved product stability, even with light weight products
- Dry running, eliminate soap lubricants
- Reduced downtime and maintenance
- Active Transfer Modules for smooth, continuous product transfer at 90 degree corners

### 2. MATVEYOR™ Modular Plastic Belts...

Brickable width plastic belting with materials to match the conveying application.

- **Series 1010** Light duty 1" pitch products ideally suited to a wide variety of general package and container handling applications
- **Series 3000** Heavy duty 2" pitch belts applicable for larger warmers, coolers accumulation, and general conveying
- **Series 5000** Modularity in a Turn Style Belt Ideal for many food production and processing applications

### 3. TOPVEYOR® Conveying Chain...

The **TOP** choice for problem-solving. *Tops in interchangeability and specialty chain choices.*

- Carbon and stainless steel chains
- Advanced thermo-plastic materials
- Straight running, side flexing and multi-flex
- High friction and gripper pads
- Split and solid sprockets

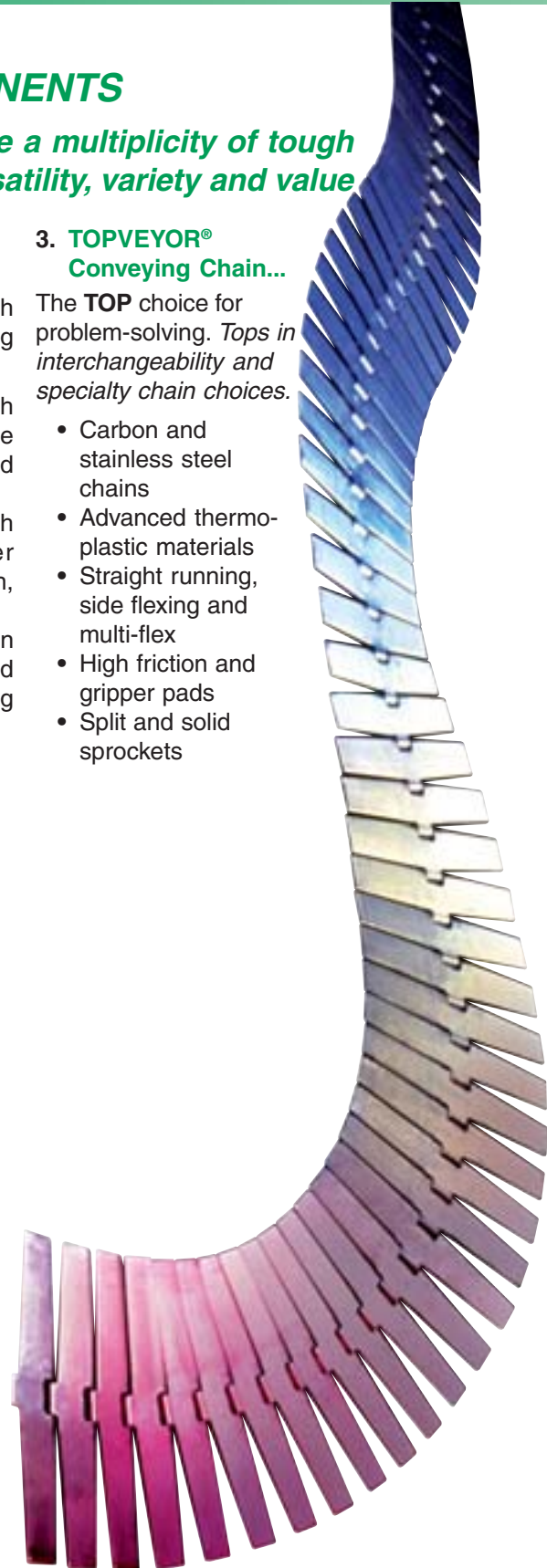
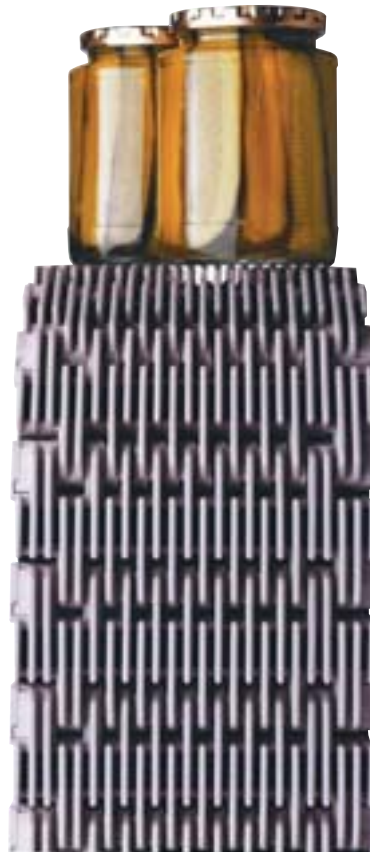
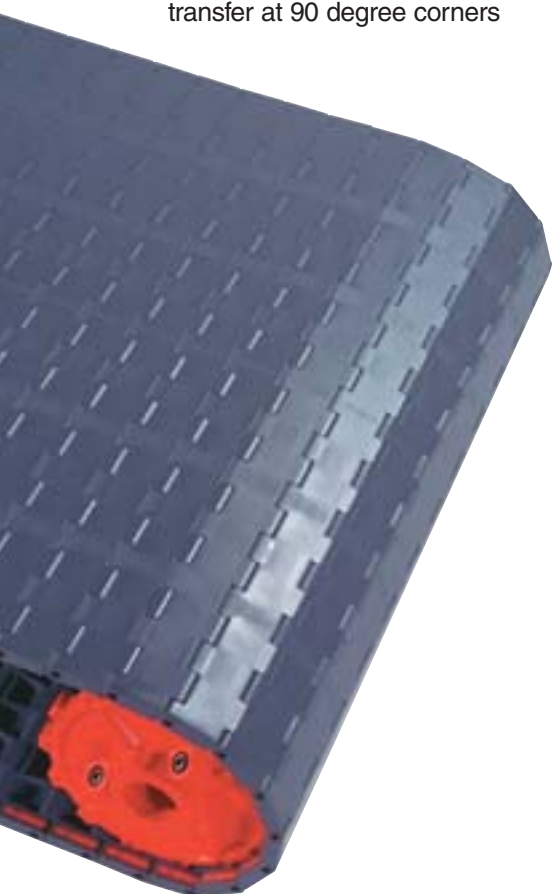



## Experience The Power...

Over 2,000 BROWNING stock gears help you to "Get In Gear" for greater productivity

• **Spur • Miter • Bevel • Change • Helical • Worm • Rack...** The most comprehensive lines of off-the-shelf gears in industry.

These gears are available in 20° pressure angle from 20 to 4 dp, and 14 1/2° pressure angle from 48 to 3 dp... all designed to increase output, reduce cost and avoid special designs.

- Thousands of shaft-ready finished bore and bushing types (a BROWNING exclusive) eliminate rework costs, and improved running precision
- More stock sizes made of steel... you get weldability plus greater strength, at cast iron prices
- Extra tooth depth and larger radii provide stronger teeth, a deeper lubrication reservoir and more clearance
- Many helical and bevel gears are available hardened for longer life. Most worms are hardened and ground
- Many odd number of teeth sizes available
- Custom gear capabilities -- up to 60" diameter and 17" face

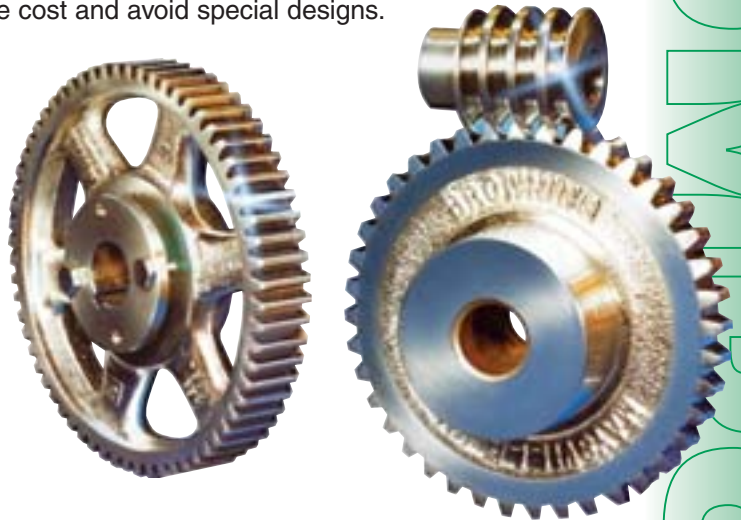

### SPUR GEARS

Type	Material	Pressure Angle	Pitch Range	Tooth Range	Bore Range
Min. Bore Fin. Bore Bushing Type	Steel & Cast Iron	14 1/2	32-3	11-200	3/16"-4 1/4"
		20	20-4	12-240	3/8-4 1/4
Change Gear	Steel	14 1/2	20-8	20-129	5/8-1 3/8*
Rack	Brass/Steel	14 1/2-20	48-3	-	-
Min. Bore	Non-Metallic	14 1/2	16-5	12-96	3/8-2 1/4
Stem Pinions	Steel	14 1/2	20-6	6-10	-

### BEVEL & MITER GEARS

Bevel	Steel	20	20-3	10-96	3/16-3
Miter	Steel	20	32-4	12-32	3/16-3
Spiral Bevel	Steel	20	14-8	16-34	1/2-1 1/2
Spiral Miter	Steel	20	12-5	15-28	1/2-1 3/8

### WORMS & WORM GEARS

Worm Gears	Cast Iron & Bronze	14 1/2	32-3	20-128	3/16-2 7/8
		20	32-6	20-128	3/16-1 13/16
		25	32-6	20-100	3/16-1 13/16
Worms	Steel	14 1/2	32-3	1-4	3/16-1 1/2
		20	32-6	threads	
		25	32-6		

### HELICAL GEARS

Helical (45° angle) - Steel	14 1/2	24-6	8-72	3/16-1 1/4
-----------------------------	--------	------	------	------------

\* Bushing bore range for Change Gears is 7/16 - 1 1/8".

# EMERSON® MOTORIZED CONVEYOR PULLEYS

COMPONENTS

## EMERSON® MXP™ MOTORIZED CONVEYOR PULLEYS OFFER COST SAVINGS FEATURES IN A COMPACT, SELF-CONTAINED DRIVE SYSTEM

All drive components... electric motor, gears, support bearings, pulley components and miscellaneous parts such as lubrication seals, etc. ... are encased within the MXP™ pulley. This provides a more compact, quieter, safer drive system with fewer exposed moving parts that saves maintenance and installation costs. These pulleys are lighter in weight than the systems they are designed to replace, and protected from dirt, grit and other contaminants. They are less costly to install, requiring up to 75% less installation time, and they operate at a significantly lower noise level.

Available sizes range from 1/2 to 30 HP, 6.500" to 20" O.D. and up to 63" face widths, to cover a broad range of applications including...

- Packaging Conveyors
- Baggage Handling Conveyors
- Portable Crusher Conveyors
- Food Processing Conveyors
- Radial Stacker Conveyors
- Aggregate Portable Plant Conveyors



### Seal Guard Option

In demanding, abrasive environments, seal guards provide added protection to pulleys by providing a barrier against particulate contamination, protecting the pulley's radial lip shaft seals. Seal guards operate with or without grease and include a replaceable, synthetic rubber v-ring and a protective metal case.

SIZE	HORSEPOWER	AVAILABLE STANDARD PULLEY FACE WIDTHS	
		ACTUAL (STD)	NOMINAL
MX06	1/2, 1, 1 1/2	17.72 - 45.28	18 - 46
MX08	1, 1 1/2, 2, 3, 5	21.65 - 45.28	22 - 46
MX12	3, 5, 7 1/2, 10	25.59 - 62.99	26 - 63
MX16	5, 7 1/2, 10, 15	31.50 - 62.99	32 - 63
MX20	10, 15, 20, 25, 30	37.00 - 63.00	37 - 63

**A PRODUCT FOR EVERY APPLICATION... LIGHT, MEDIUM AND HEAVY-DUTY SERVICE**

**Choose the coupling that's MATCHED to your application... From EPT'S broad line selection**

EPT offers a variety of coupling options. Many offer unique problem-solving designs and are available in minimum bore, finished bore and bushing types as indicated in the table below. Bushings utilize patented **SPLIT TAPER™** construction, BROWNING's exclusive *easy-on, easy-off* design. Whichever coupling you choose, you're sure to be *well connected*.



OTHER EPT COUPLINGS

Coupling Types		Bore Sizes	Maximum HP @ 1800 RPM
Pin	Finished Bore-Die Cast	1/4" - 1 5/8"	9.6
	Finished Bore-Steel	3/8" - 1 1/4"	5.5
	Bushing Type-Steel	3/8" - 3 3/4"	68.7
Jaw	Finished Bore	3/8" - 2 3/8"	180.0
	Bushing Type	3/8" - 2 3/8"	144.0
Chain	Finished Bore	1/2" - 2 3/8"	146.0
	Bushing Type	3/8" - 4 1/4"	588.0
	Minimum Bore	1/2" - 3 1/2"	588.0
Ever-Flex®	Finished Bore	3/8" - 1 3/4"	74.6
	Bushing Type	3/8" - 4 1/4"	476.7
	Minimum Bore	3/8" - 3 1/4"	203.2
Gear	Rough Bore	3/4" 8 7/8"	1020/100 RPM
Sleeve	Finished Bore	1/4" - 1 3/8"	-
	Bushing Bore	3/8" - 2"	-
		11/16"	-
Rigid	Bushing Type	3/8" - 3 3/4"	-
Kop-Grid®	Rough Bore	1/2" - 7 1/4"	6385
	Finished Bore	1/2" - 7"	6385
	Bushing Type	3/8" - 5 1/2"	5328
Coupling Types		Bore Sizes	Maximum HP @ 1000 RPM
MORFLEX®	Finished Bore	9/16" - 3 1/4"	379.80
	Minimum Bore	3/8" - 2"	



### Morflex® Coupling...

Used where considerable misalignment may occur; couplings are torsionally flexible while compensating for misalignment. They also cushion shock loads and vibration.



## YOU'LL ALWAYS MAKE THE CORRECT CONNECTION WHEN YOU SPECIFY OPTIMUM-QUALITY EPT COUPLINGS

Choose from more than 25,000 combinations of types, sizes and bores... Most available from stock

Industry world-wide depends on KOP-FLEX® Couplings for a broad range of heavy-duty applications...

Well over 80-years of research and development, design, engineering and manufacturing experience in this industry stands behind the well-known KOP-FLEX brand name. KOP-FLEX is one of the largest producers of flexible disc, diaphragm, gear, flexible grid and resilient shaft couplings in the international marketplace.

KOP-FLEX Couplings technology -- from the latest CAD/CAE/CAM techniques to the use of space-age materials -- provides reliable products of the highest quality, **to stringent ISO 9001 quality standards**. These rugged couplings are widely utilized to satisfy a variety of demanding applications from pumps to compressors, in petrochemical, process, pulp and paper and metal producing facilities, and many other industries.



Unitized Flexible Disc Pack

### KOP-FLEX Flexible Disc Couplings... A new generation of designs...

- Never need lubrication
- Koplon coated disc available as an option
- Proven disc design
- Easy to-install
- Accommodate shaft misalignments
- Unitized pre-assembled disc packs



KDI Closed-Coupled Flexible Disc Coupling

### KOP-FLEX KD Series Couplings...

Readily transmit mechanical power in applications such as pumps, compressors, air conditioning and refrigeration equipment, fans and blowers and other rotating machinery. Available in a wide range of sizes and types.

### KOP-FLEX High Performance Couplings...

Available in four disc styles and three diaphragm styles. Designed and manufactured to meet API 671. These couplings are engineered to accommodate a broad range of demanding operating conditions: boiler feed pumps, centrifugal and axial compressors, generator sets, test stands, gas and steam turbines, marine drives, etc... The KOP-FLEX HP disc and diaphragm coupling is the preferred choice for demanding turbo machinery applications. Superior quality and a wide variety of standard and custom designs backed by unsurpassed engineering expertise combine to make KOP-FLEX the industry leader. **Visit [www.kopflex.com](http://www.kopflex.com) for details.**

- Inherent fail-safe designs
- Koplon coated flexible disc elements for maximum life
- Factory assembled
- Dynamically balanced



RM Series

MS Series

RZ Series

MP Series



KOP-FLEX®  
Reduced Moment  
High Performance  
Disc Coupling



Size #5.5 MDM-J  
diaphragm coupling

## KOP-GRID® Tapered Grid Couplings...

KOP-GRID flexible shaft couplings provide reliable, long-life transmission of mechanical power through a time and use-proven design of utilizing a tapered, shot peened steel grid to transmit torque from driving to driven equipment shafts; they compensate for misalignment and provide the added benefit of absorbing shock and smoothing machinery vibration. Other benefits include:

- Cost-saving interchangeability with competition
- Off-the-shelf availability
- Easy installation and maintenance

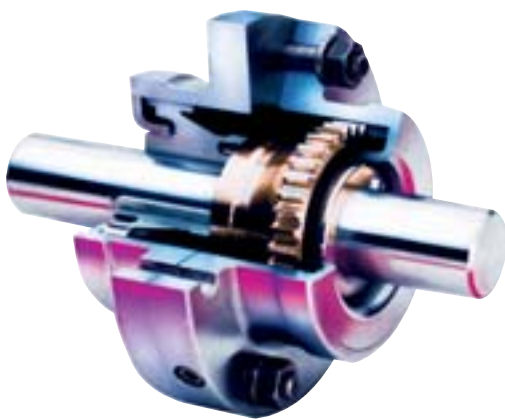

## The FAST's® Gear Type Coupling...

This unique coupling design dates back to 1918. Because the gear type coupling will reliably transmit more torque-per-pound and per-inch of diameter than any other flexible coupling, it is widely specified and used world-wide in a diversity of medium to heavy-duty industrial drives. Gear couplings provide long and economical operating life, and the patented Fast's design, with its lifetime **All-Metal End Ring** provides up to 300% greater lubricant capacity which means less maintenance.

**KOP-FLEX Universal Joints...** Flange universal joints are a new product to the KOP-FLEX line up of couplings and large universal driveshafts. Designed for rugged industrial and off-road vehicle environments with standard features unmatched by competitive designs.

- Size range from 58 mm (2.3 inches) to 390 mm (15.4 inches)
- Available from stock for quick delivery
- Most major components are interchangeable with competitive units
- 4 point lubrication available as standard feature on most sizes
- Cost-saving repair and refurbishment service available

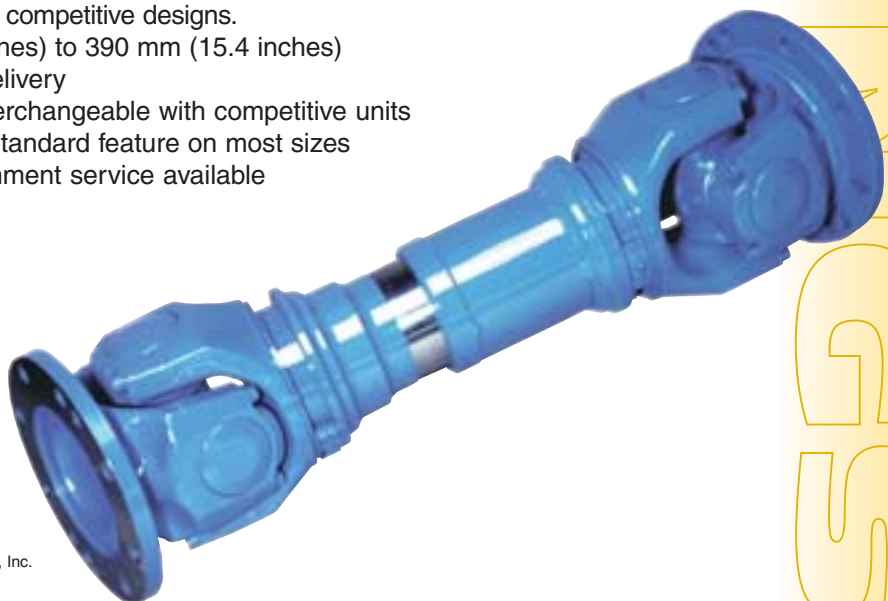

## EXPERIENCE THE MORSE WORM GEAR ADVANTAGE:

- Complete worm gear offering from 1" through 11" center distance – The right drive for every application
- Commercially available bearings and seals make maintenance trouble-free
- Off-the-shelf availability on most units and stocked in over 2500 locations in North America



### COBRA™

- Integral SealTite™ expansion chamber - eliminates internal pressure buildup and oil leaks
- Compact, light-weight design, cool-running, resists rust, corrosion
- Maintenance-free, factory-filled with synthetic lubricant, sealed for life
- Flexible mounting – Integral feet on 4 sides, face mount register front and rear
- Available in 4 models to fit every application:
  - **U**, Shaft input, shaft output
  - **Q**, NEMA-C input, shaft output
  - **UH**, Shaft input, hollow output
  - **QH**, NEMA-C input, hollow output

## RAIDER®

- Modular design provides over 10 million configurations from stock components
- Double sealing capability on input and output shafts
- Dimensionally interchangeable with major industry competitors
- Units ship filled with oil

**NEW!**

- Stainless Steel RAIDER® available for the ultimate in corrosion resistance



### RAIDER® AND COBRA™ GEAR REDUCERS

Type	Center Distance	Ratios	Output Torque At 1750 RPM
<b>RAIDER® SERIES</b>			
Single Reduction	1.00 - 6.00	5:1 - 60:1	82 - 8894
Double Reduction	1.33 - 6.00	25:1 - 3600:1	203 - 22416
<b>COBRA™ SERIES</b>			
Single Reduction	1.33 - 3.75	5:1 - 60:1	183 - 3270

## POWERGEAR®

- Heavy duty worm gear speed reducers with output torque capacities up to 132,000 in/lbs
- Broad size range 1" through 11" center distance available
- Rugged housings, bearings and shafts combine to provide a high capacity product
- Four major product offerings:
  - **G Series**, C-Face input
  - **W Series**, Shaft input, shaft output style
  - **V Series**, Vertical output shaft design
  - **S Series**, Shaft mounted worm gear reducer
- Wide variety of styles offered in single and double reduction

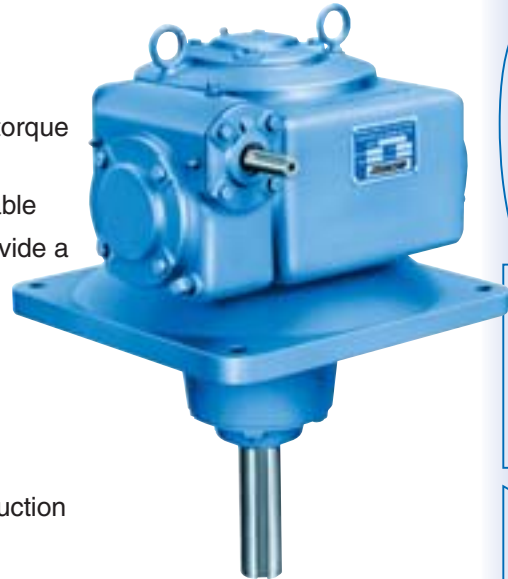

**DVX Series**  
Vertical Output Shaft Design



**G Series**  
C-Face Input



**W Series**  
Shaft Input, Shaft Output

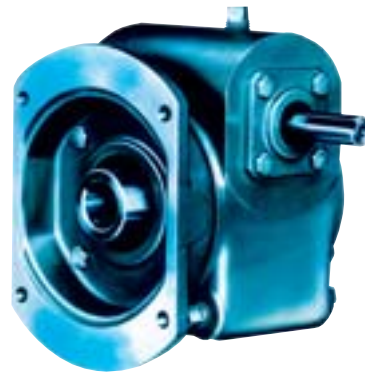

**S Series**  
Shaftmounted Worm Gear Reducer

### WORM GEAR SPEED REDUCERS

Type	Center Distance	Ratios	Output Torque in/lbs. At 1750 RPM
<b>G SERIES</b>			
Single Reduction	1.33 - 6.00	5:1 - 60:1	165 - 9438
Double Reduction	1.33 - 6.00	75:1 - 3600:1	264 - 23662
<b>W SERIES</b>			
Single Reduction	1.00 - 10.0	5:1 - 60:1	92 - 29673
Double Reduction	2.00 - 10.0	75:1 - 3600:1	881 - 101397
<b>V SERIES</b>			
Single Reduction	1.75 - 11.00"	5:1 - 60:1	359 - 36195
Double Reduction	2.0 - 11.00"	75:1 - 3600:1	487 - 132729
<b>S SERIES</b>			
Single Reduction	1.75 - 6.0	5:1 - 60:1	359 - 9438
Double Reduction	1.75 - 6.0	75:1 - 3600:1	640 - 23662

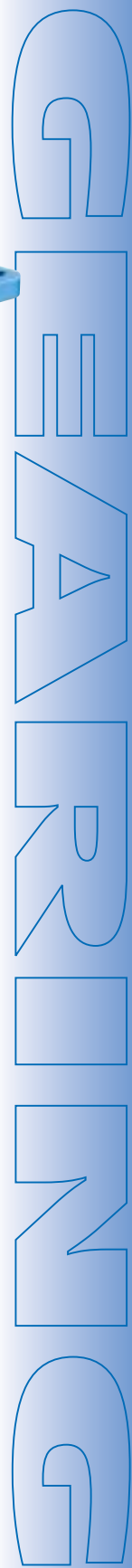



## SERIES 2000/3000 GEARMOTORS AND SPEED REDUCERS EXPERIENCE THE SERIES 2000/3000 ADVANTAGE:

- **Broad range of gearing and input styles** – Gearmotor, input shaft, C-Face, scoop
- **Innovative self locking tapered shaft connection** allows on-site motor replacement without removing oil or primary pinion. Provides gearmotor economy with C-Face convenience
- **Broadest line of motor ends** – TEFC (single phase and 3 phase), explosion proof, Corro-Duty®, inverter duty, brakemotor. Stocked at over 300 distributors and priced at C-Face levels

**NEW!**

- **Series 3000** – CbN Inline helical offers best torque capacity available

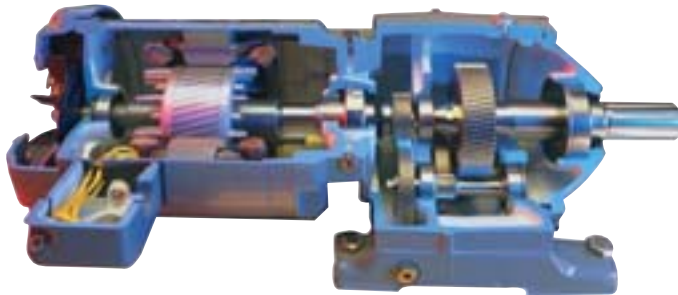

### CbN – Inline Helical

- Output torque through 145,000 In. Lbs
- 1/12HP through 75HP gearmotors
- Ratios from 0.8:1 to 6,300:1
- Footed and flange mounting

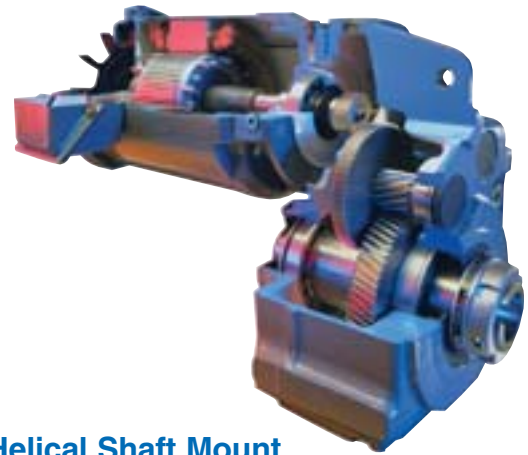

### MbN – Helical Shaft Mount

- Tapered bushed and finished bore designs
- 1/3HP through 50HP gearmotors
- Output torque through 48,000 In. Lbs
- Ratios from 3.15:1 to 6,300:1

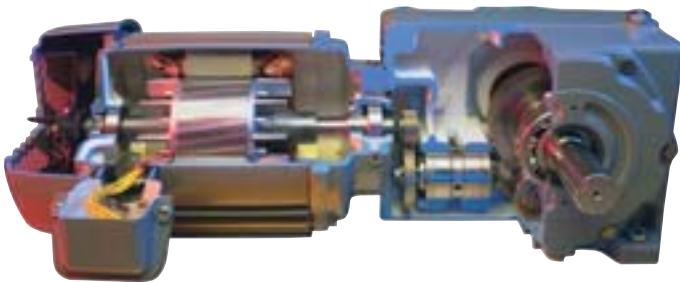

### OtN – Right Angle Helical Bevel

- Output torque through 88,000 In. Lbs
- 1/3HP through 50HP gearmotors
- Ratios from 9:1 to 7,100:1
- Footed, face or flange mounting
- Solid or hollow output shaft available

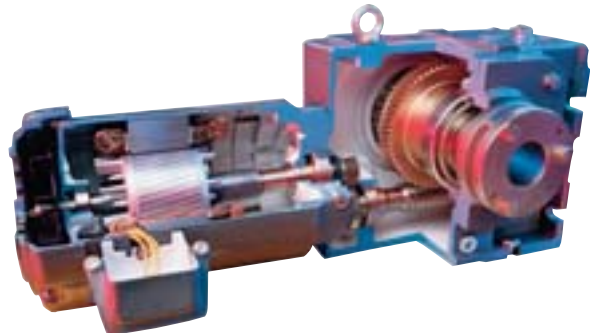

### HWN – Right Angle Helical Worm

- Output torque through 24,000 In. Lbs
- 1/6HP to 10HP gearmotors
- Tapered bushed, finished bore and keyed output shafts
- Ratios from 8.0:1 to 12,500:1
- Dimensional interchange to leading competitors



# HELICAL & WORM GEARING

## Series 1000 Fractional Horsepower AC & DC Gearmotors:

The new Series 1000 gearmotor line is designed to complement existing CbN and HWN products. These fractional HP AC & DC Gearmotors incorporate compact envelopes and efficient economical solutions for demanding applications.

**NEW!**



### CbN

- 1/2 to 3/4 HP
- Footed, face & flanged mounted
- Available in AC and DC motors
- Synthetic SHC 629 lubricant
- 3.15 to 315:1 ratios

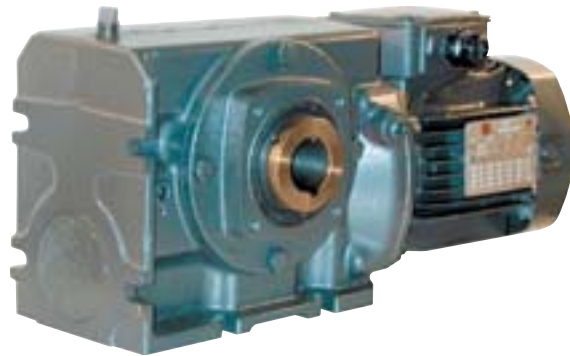

### HWN

- 1/6 to 3/4 HP
- Hollow and solid output shafts
- Footed, face & flanged mounted
- Available in AC and DC motors
- Synthetic SHC 634 lubricant
- 12.5 to 315:1 ratios



**NEW!**

**Variable Speed Gearmotors thru 5HP**

## IRA Syncrogear Worm & Worm Helical Gearmotors & Speed Reducers...

- Utilize same motor end as series 2000/3000 gearmotors
- Foot & flange mount worm and worm helical available
- Torque range Up To 3500 in. lbs
- Innovative self-locking taper shaft connection (motor to gear) allows on-site replacement without removing oil or primary pinion



## **TORQ TAPER® Plus** **NEW!** **BROWNING SHAFT MOUNT REVERSIBLE MOUNTING SYSTEM...**

### **Compare these unique TORQTAPER® Plus features...**

Unlike competitive bushing systems that mount from only one side of the reducer, or require two separate bushings, TORQTAPER® Plus uses a single tapered bushing that easily installs from either front or back – depending on your space limitations and available shaft length. This patent-pending feature makes replacement of any competitive unit a breeze.

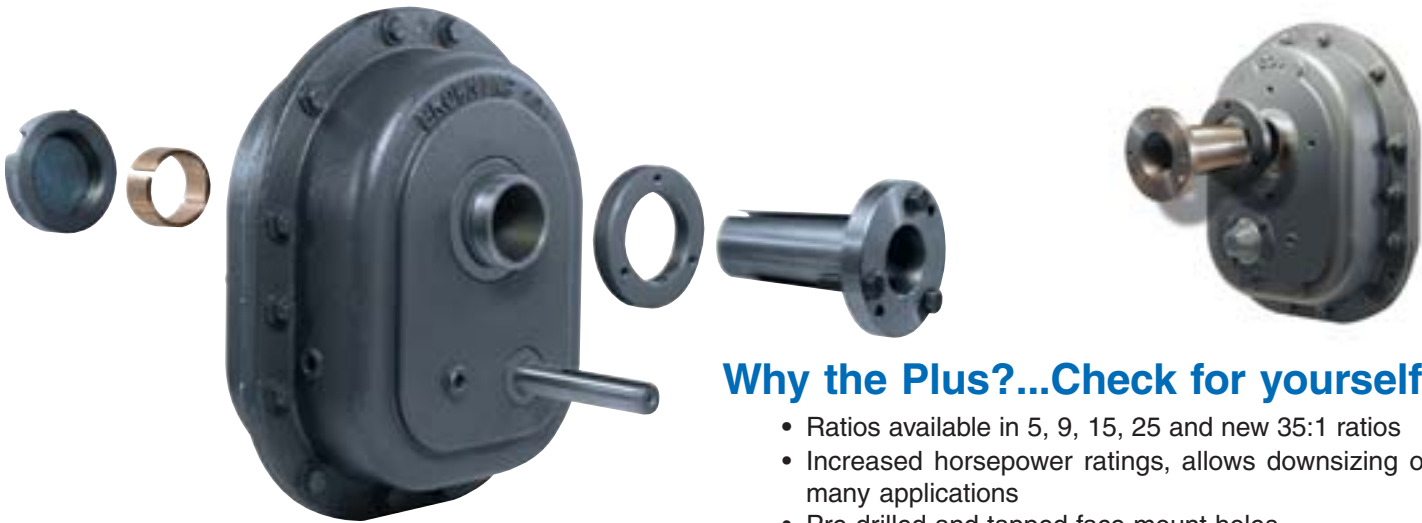

### **Why the Plus?...Check for yourself**

- Ratios available in 5, 9, 15, 25 and new 35:1 ratios
- Increased horsepower ratings, allows downsizing on many applications
- Pre-drilled and tapped face mount holes
- Screw conveyor drives and accessories available

## **PlanetPower®**

### **Planetary Reducers**

- Designed for heavy shock loads
- Compact low profile design
- Balanced gear sets
- High capacity bearings throughout



### **Cast Iron Right Angle Bevel Gearboxes**

- Ratings to 135 HP
- 1:1 to 2:1 ratios
- 6 sizes
- Aluminum right angle (ARA) also available with ratings to 7.5 horsepower

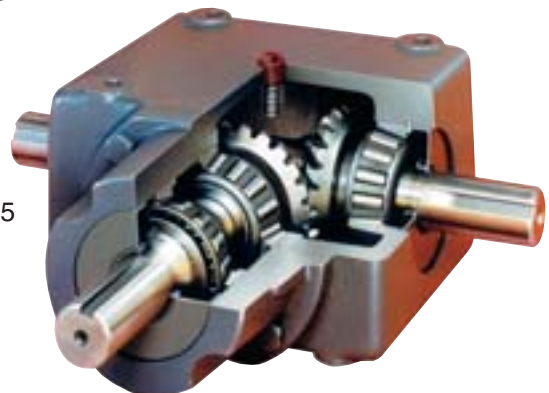



## **Parallel Shaft, Right Angle & Hollow Bore Speed Reducers:**

- Standard and custom units available
- Hollow bores & hollow bores with shrink disc
- Torque ratings up to 11 million inch pounds
- Cast iron and steel housings
- Class 12 gearing resulting in lower sound and vibration levels



## **Custom Solutions:**

*EPT is your source for custom enclosed gearboxes limited only by the imagination*

- Gear types — Helical, worm, spiral bevel, bevel, spur & combination gearboxes
- Housing materials — Fabricated steel, cast iron, ductile iron, aluminum & stainless steel

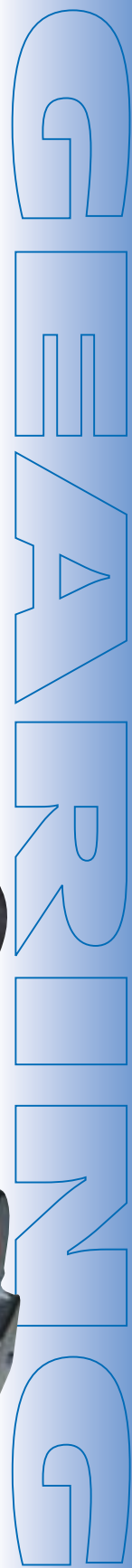

# Visit us at...

# www.emerson-ept.com

FOR ORDERING INFORMATION,  
CONTACT YOUR AUTHORIZED  
EPT DISTRIBUTOR OR  
EPT CUSTOMER SERVICE

**EMERSON POWER TRANSMISSION**  
Maysville, KY 41056  
Telephone 1-800-626-2120  
606-564-2011  
Fax 1-800-262-3292  
606-564-2052

**EMERSON POWER TRANSMISSION**  
7120 New Buffington Rd.  
P.O. Box 728  
Florence, KY 41022  
Telephone 1-800-626-2120  
859-342-7900  
Fax 1-800-262-3292  
859-342-5652

**EMERSON POWER TRANSMISSION – WEST**  
3553 Placentia Ct.  
Chino, CA 91710  
Telephone 1-800-626-2120  
909-591-9561  
Fax 1-800-262-3292  
909-628-1983

#### OTHER EPT CUSTOMER SERVICE CENTERS

**EMERSON POWER TRANSMISSION – EXPORT**  
7120 New Buffington Rd.  
Florence, KY 41042  
Telephone 859-727-5273  
Fax 859-727-0721

**EMERSON POWER TRANSMISSION – CANADA**  
16 Main Street  
Unionville, ONT L3R 2E4  
Telephone 1-800-268-4149  
905-294-9330  
Fax 1-800-668-9005

**KOP-FLEX , INC.**  
P.O. Box 1696  
Baltimore, MD 21203  
Telephone 1-800-626-2120  
Telephone Plant 410-768-2000  
Fax 1-800-262-3292

**McGILL MANUFACTURING CO., INC.**  
909 North Lafayette St.  
Valparaiso, IN 46383  
Telephone 1-800-626-2120  
219-465-2200  
Fax 1-800-262-3292  
219-465-2290

#### APPLICATION CONSIDERATIONS

The proper selection and application of power transmission products and components, including the related area of product safety, is the responsibility of the customer. Operating and performance requirements and potential associated issues will vary appreciably depending upon the use and application of such products and components. The scope of the technical and application information included in this publication is necessarily limited. Unusual operating environments and conditions, lubrication requirements, loading supports, and other factors can materially affect the application and operating results of the products and components and the customer should carefully review its requirements. Any technical advice or review furnished by Emerson Power Transmission Corporation and its divisions with respect to the use of products and components is given in good faith and without charge, and Emerson assumes no obligation or liability for the advice given, or results obtained, all such advice and review being given and accepted at customer's risk.

For a copy of our **Standard Terms and Conditions of Sale, Disclaimers of Warranty, Limitation of Liability and Remedy**, please contact EPT Customer Service at 1-800-626-2120. These terms and conditions of sale, disclaimers and limitations of liability apply to any person who may buy, acquire or use an Emerson Power Transmission Corporation product referred to herein, including any person who buys from a licensed distributor of these branded products.