



*Standard catalog*



RMB

**The RMB Group is head quartered in Biel-Bienne, Switzerland (CH) where the company started miniature bearing manufacturing activities in 1932.**

Today, the RMB Group is a multi business company, leading the market in miniature bearings, innovative high precision micro-mechanics and micro-mechatronic solutions. It as 600 employees and four manufacturing / assembly facilities, 2 in Switzerland, and one each in Germany and the Czech Republic.

The RMB Group has a world wide sales presence and is structured in 3 business units to better serve our customer's needs.

The 3 Business Units are: **Miniature Bearings Division, Micro Precision Systems and Micro Precision Parts.**

The **Miniature Bearings Division (MBD)** is focused on offering high precision miniature bearings, miniature precision ball screws and ball bushing. The bearings are manufactured in various configurations as per standard dimensional norms as well as per custom design. RMB bearings are recognized as the world wide leader in high end applications, able to match the most demanding applications.

The **Micro Precision Systems (MPS)** business unit, with its incomparable competence in engineering, manufacturing and assembly, offers complete solutions in micro-mechatronic applications. The same miniature precision skills and capabilities that allowed RMB to be the first miniature bearing manufacturer allowed them to launch smoovy® - a product that covers a range of the smallest micro drive systems available today and has won major awards around the world.

The **Micro Precision Parts (MPP)** division offers high precision manufacturing skills and a scope of experience gained in nearly 70 years of turning, grinding and honing high volume parts with constant quality and precision levels within tenths of a micron. The MPP division has the advantage of being a full scale supplier capable of managing all critical steps starting from incoming inspection of raw material, through turning, heat treatment, grinding to the lapping and polishing processes.



<b>1</b>	<i>Introduction</i>
<b>2-3</b>	<i>RMB numbering system</i>
<b>4</b>	<i>Quality assurance</i>
<b>5</b>	<i>Cleanliness</i>
<b>6</b>	<i>Research &amp; development / Engineering</i>
<b>7</b>	<i>Materials for rings</i>
<b>8</b>	<i>Closures</i>
<b>9</b>	<i>Preload and duplex mounting</i>
<b>10-11</b>	<i>Cages</i>
<b>12-13</b>	<i>Limits of dimensional and functional accuracy of radial bearings</i>
<b>14</b>	<i>Radial / axial play and contact angle</i>
<b>15</b>	<i>Sensitivity</i>
<b>16</b>	<i>Starting torque</i>
<b>17</b>	<i>Code for grading by dimensional groups</i>
<b>18-19</b>	<i>Lubrication</i>
<b>20</b>	<i>Mounting advice</i>
<b>21</b>	<i>Shaft and housing tolerances</i>
<b>22</b>	<i>Mating parts design advice</i>
<b>23</b>	<i>Calculation of loads</i>
<b>24-31</b>	<i>Calculation of the theoretical life expectancy of a ball bearings</i>
<b>32</b>	<i>Packaging</i>

## Index

---

	<i>Radial single row ball bearings, metric series: Open <b>R, UL</b>. Closed <b>RV, ULV, ULZT, ULZ, RX, RF</b></i>		<i>Flanged angular contact separable ball bearings, metric series: <b>RKA</b></i>
<b>34-37</b>		<b>56-57</b>	
	<i>Radial single row ball bearings inch series: Open <b>R, UL</b> Closed <b>RV, ULV, ULZ, RX, RF</b></i>		<i>Flanged angular contact separable ball bearings, inch series: <b>RKA</b></i>
<b>38-41</b>		<b>56-57</b>	
	<i>Radial single row ball bearings with modified outer ring dimension, inch series: Closed <b>MV, MVT, MZ, MX, MF</b></i>		<i>Thrust ball bearings, metric series: <b>B</b></i>
<b>42-43</b>		<b>58</b>	
	<i>Standard and flanged radial single row ball bearings with extended inner ring, inch series: Open <b>RU, ULU, RKU, ULKU</b> Closed <b>ULUZ, ULKUZ</b></i>		<i>Miniature precision balls</i>
<b>44-45</b>		<b>59</b>	
	<i>Flanged radial single row ball bearings, metric series: Open <b>RK, ULK, ULKW</b> Closed <b>RKV, ULKZ, RKX, RKF</b></i>		<i>Miniature precision linear bearings: <b>L</b></i>
<b>46-47</b>		<b>60</b>	
	<i>Flanged radial single row ball bearings, inch series: Open <b>RK, ULK</b> Closed <b>ULKZ, RKX, RKF</b></i>		<i>Miniature precision ball screws: <b>ED</b></i>
<b>48-51</b>		<b>61</b>	
	<i>Angular contact separable ball bearings, metric series: <b>RA</b></i>		<i>Circlips for shafts and  housings: <b>WSR, BSR</b></i>
<b>52-53</b>		<b>62-63</b>	
	<i>Angular contact separable ball bearings, inch series: <b>RA</b></i>		<i>Precision spring washers: <b>FS</b></i>
<b>54-55</b>		<b>64-65</b>	
			<i>Precision shims: <b>PS</b></i>
		<b>66-67</b>	



**RMB, Roulements Miniatures Bienne, has been a worldwide leader in design, engineering, manufacturing and assembly of precision miniature bearings for 70 years.**

In 1932, RMB pioneered the development of the world's first miniature bearing. In no part of the world other than the heart of Switzerland with its innate micro-mechanical precision skills would it have been possible to achieve and maintain this supremacy.

Leadership in high-precision miniature bearing applications cannot happen in a day. The mindset required to constantly overcome technological limits with innovative solutions, along with our vast experience in miniaturization, work to keep us and our partners a step ahead of the competition. The result of this continuous improvement is a superb bearing design for better performance either within the standard catalog range or with a dedicated special design. It is not by chance that RMB has developed many unique miniature bearing designs and has many patents to show for this effort.

RMB also views vertical integration as a significant advantage in producing miniature bearings to our exacting tolerances. We prefer to manufacture all of our components for our bearings, including balls, retainers, rings, shields and seals. We also have our own dedicated heat treat facilities to ensure a consistent product. This gives us an advantage for both quality and delivery.

The RMB Group provides a benefit for our customers with our worldwide presence, working through either our affiliates or highly qualified distributors. Our well-trained sales engineers, together with our distributors are at your disposal to create a partnership to design the most reliable technical solution to your demanding application.

Customizing can be done either employing standard catalog bearings with slightly varied specifications or developing a highly sophisticated special bearing designed specifically to meet your requirements.

RMB is proud to have been chosen as a preferred partner by many high tech companies recognized around the world. We will do whatever is needed to achieve the highest precision or cost effective solution to any miniature or subminiature application.

Our latest catalog will guide you through a good part of our standard metric or inch miniature bearing range. Please contact our sales offices to get more detailed information on the products shown in this catalog or to get further information on the availability of bearings not listed in the following pages. We manufacture many special sizes and configurations, and it would have been impossible to have all of them appear in our catalog.

The RMB Group, with its depth of research and development along with our application and sales engineers, is at your disposal to design a product to meet your toughest requirements for standard and special miniature bearings, miniature ball screws, and ball bushing.

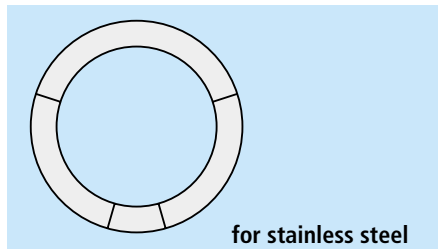
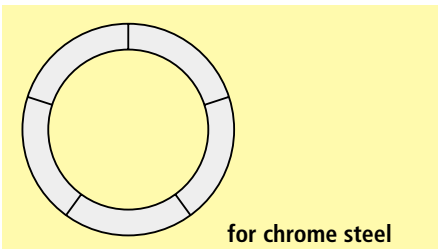

### RMB numbering system for bearings

Basic reference	Material	Features	Duplexed bearings	Ball cages	Precision grade	Radial play
UL 3006	X			-48	-A5P	-6/10
ULKZ 4008	X	.1c			-A7P	-
RKF 310	X	.1v			-P5P	-11/20
R 6190	X			-237BB	-P4P	-2/5
ULKU 8012	X			-48	-A9P	-2/10
RA 4012	X			-257SX	-A7P	
R 5160			.9d/1000		-GYRO	-16/20
Types listed Example :UL=type 3006=basic size of bearing bore and O.D in 1/32 of an inch or in millimeters for metric series.	X=AISI 440 C Stainless steel.  No suffix is required for chrome steel AISI 52100	.1= 1 closure only.  .1c= 1 closure, flanged side  .1v= 1 closure only, side opposite flange	Type of Mounting / Preload .9f= face to face. .9d= back to back. .9t= tandem 1000= preload of 10[N] > page 9	Type, number of balls and material. Standard cage is not mentioned in the reference. Third digit when present means number of balls. > page 10, 11	Dimensional and functional accuracy are according to ABEC or ISO Grades > page 12, 13	Lower/upper limits expressed in microns Standard radial play of 6/15 [µm] is not included in the reference. > page 14

### Miniature precision balls

Example of reference:

**2.381X/G3-P2**

Legend :

- 2.381X/G3-P2** = Nominal ball diameter in [mm]
- 2.381X/G3-P2** = Material: «X» for stainless steel  
«blank» for Chrome steel
- 2.381X/G3-P2** = Precision quality ISO grade 3
- 2.381X/G3-P2** = Ball calibration: P = «Plus» (+)  
M = «Minus» (-)  
NO = Nominal (0)  
Number = caliber in [µm]



Axial play	Contact angle	Torque	Noise level	Coding of bores and outside dia	Special instruction	Lubrication
		-10/75D		-S2	-J...	-L23
-L50/100						-G48
			-10/174			-G48/20
				-SB1.25/0C		G18/...mg
					-J...	-L96
	-20/25°					-L23
				-S1.25/BB	-J...	-L23
Lower/upper limits expressed in [µm]. Example: L50/100 = axial play of 50 to 100 µm (.002" to .004") > page 14	Lower/upper limit > page 14	Limit/axial load. D= starting torque.  10/75D= starting torque of 10 µNm > page 15, 16	Limit/method of measurement.	Coding by dimensional groups. > page 17	Letter J followed by a number refers to an internal document and covers any requirement that cannot be expressed by the preceding suffixes.	Lubrication code L = oil G = grease Example: -G48/20 = grease G48, dispersion 20% -G18/...mg = grease G18, dose...mg. > page 18

## Miniature precision ball screw

Example of reference:

**ED 513XV501X**

Legend :

- ED** 513X/V501X = Ball nut. (EDD = Two ball nuts).
- ED** 513X/V501X = 4 x pitch of ball nut thread.
- ED** 513X/V501X = Outer diameter of ball nut.
- ED** 513X/V501X = Ball nut in stainless steel material.
- ED** 513X/V501X = Ground precision screw.
- ED** 513X/V501X = 4 x pitch of screw thread.
- ED** 513X/V501X = Screw drawing number.
- ED** 513X/V501X = Screw in stainless steel material.

## Miniature linear ball bushing

Example of reference:

**L 204X-L23ar**

Legend:

- L** 204X-L23ar = Linear ball bushing.
- L** 204X-L23ar = Dimension: First digit bore = 2[mm].
- L** 204X-L23ar = Second 2 digits outer diameter = 4[mm].
- L** 204X-L23ar = Stainless steel material.
- L** 204X-L23ar = Lubricant: L = Oil G = Grease.
- L** 204X-L23ar = Type of lubricant.
- L** 204X-L23ar = Rust protection, dipped in oil.

**RMB's internal quality system was created many years ago in anticipation of international standards. Our first Approval Certificate was issued in 1961 by the British Ministry of Aviation. Our version of that certification was revised from the "CAA", the Civil Aviation Authority.**

In order to fulfill various government, customer and RMB requirements, RMB has constantly improved its Quality System. This led to obtaining the British Standard Institution Certificate based on "BS 5750 Part 2" in 1989, which is the equivalent to the ISO 9002 standard.

On January 25, 1995, RMB was awarded the "SQS" Certificate based on the ISO 9001/EN29001 standard as well as the "EQNet" which is the European Network for quality System Assessment and Certification.

In 1994 we received our certification from "QUALIFAS" it recognizes us as a supplier to the French Aeronautical and Space Industries.

We are currently pursuing QS9000 approval in order to maintain and improve our supply of parts to the automotive industry from our Micro Precision Parts division.

In addition to these certificates RMB has obtained many approvals from high-tech customers as proof of the constant striving for incomparable quality at all levels of our business.

Quality Control is something of an art at RMB and is an integral part of every manufacturing stage. It starts with the careful selection of the raw material supplier, and inspection of this material to established standards as well as the company's own, even more, demanding standards. This is followed by the strict quality control of each component using SPC at every stage of manufacture prior to final inspection and shipping.

RMB's miniature bearing manufacturing facilities are designed and maintained to achieve the highest possible level of quality. Only the most highly specialized machines, inspection and test equipment obtainable - much of it designed or modified by RMB engineers - are used throughout the manufacturing, assembly, inspection and testing procedures. Strict environmental control for cleanliness, humidity and temperature is adhered to throughout all RMB's plants.

Quality Control Systems applied by RMB meet or exceed the requirements of MIL-Q-9858A. All inspection sampling methods are based on ISO 2859 which is equal to MIL-STD-105 standard.

Complete traceability of bearings and their component parts are available according to the requirements of the various international quality standards.

**Cleanliness is essential for proper performance of bearings but is particularly important for miniature bearings.**

RMB achieves this cleanliness by:

- Complete temperature and humidity control and air filtration of all production departments.
- Ultrasonic cleaning of all components after each stage of manufacture.
- Cleaning of all component parts by our special methods, just prior to assembly.
- The assembly of bearings in class 10,000 clean rooms under class 100 laminar flow benches.
- Strict observation of clean room procedures for all personnel working therein.
- The cleaning of assembled product by processes specially designed and perfected by RMB for miniature bearings.
- The use of special filtered lubricants.
- The packing of finished bearings in clean pouches or tubes, hermetically sealed.

These examples give an indication of the effort RMB make to supply their customers with bearings to the highest degree of cleanliness. Our customers also need to maintain this attention to detail. This may be achieved by observing the following points:

- All mating parts must be manufactured to correct tolerances as recommended in this catalog.
- The surface finishes of these parts must be satisfactory for the application in question and all components must be free of burrs, corrosion, etc.

- Any cleaning prior to final assembly should be done outside of the assembly area, with special attention paid to ensure the cleaned parts do not become contaminated during the transport process to the assembly area.
- The bearings should be assembled in a space arranged for this purpose and separate from other departments. It should, if possible, conform to clean room standards, with a dust free atmosphere and temperature and humidity control. Machining should not be done in the same room.
- The personnel employed in the assembly of miniature bearings should be subject to special rules of cleanliness. It is normal practice to equip them with coveralls or gowns and headdress of special non-fibrous material. It should be strictly forbidden to smoke, eat, wear makeup, etc. within the confines of the clean room.
- Bearings should remain in their protective packaging until just prior to assembly. If the package contains several bearings, it should be opened in such a way that only one bearing may be taken out at a time.
- Bearings should be handled with tweezers or other special tools. One should never touch high precision miniature bearings with fingers unprotected by rubber or plastic finger cots or gloves.

Naturally, the more demanding the end application, the more stringently the guidelines above need to be enforced.

## Research and Development

At RMB, the Miniature Bearing R&D team has one goal: to develop the most reliable miniature bearings for constantly improving customer product requirements to achieve maximum customer satisfaction.

All of our bearing components are continually subjected to design and material reviews to ensure leading edge products for our customers. Special attention to balls, raceway geometry and finish and retainer design has resulted in superb bearing performance. This helps us keep our customers at the leading edge of technology.

The research and development team, made up of chemical, metallurgical, mechanical and electronic instrumentation experts works in close association with the company's sales and product engineers, to retain their leadership role in bearing quality and design.

R&D engineers also assist in the development of inspection and testing equipment for maintaining manufacturing control and consistent quality. The results of this effort is that many of the manufacturing machine tools, control equipment and test equipment has been specially designed by our R&D department. We also develop special test equipment to simulate working conditions seen in the customer's application.

## Engineering

Engineering at RMB is one of our most important departments, in that we need to be able to understand and translate customers technical needs into a superior solution that is reasonable to manufacture.

RMB design and production engineers have a wide range of the latest machinery and test equipment at their disposal in our purpose built facilities. Our highly skilled engineers have been instrumental in assisting customers throughout the world in solving problems related to rotating motion.

Using either conventional catalog bearings with extended specifications, designing special bearings for a specific application or using sophisticated subassemblies, RMB is recognized as a world leader in getting results.

Our expertise allows our customers to focus on their core competence while we handle the critical issues surrounding the bearing interface.

Our engineers also specialize in specific strategic applications fields, allowing our customers to benefit from their years of dedication to those areas of expertise.

With these resources, RMB partners are assured contact with qualified application engineers who know both the bearing technology and the critical issues surrounding the specific application.

Our application engineering team has one goal: to let our customers feel free to concentrate on their own product development by taking care of any bearing issues that may arise.

In miniature ball bearings, the highest quality steel is essential for the best performance in the final application.

The RMB bearings can be identified by the marks seen below.

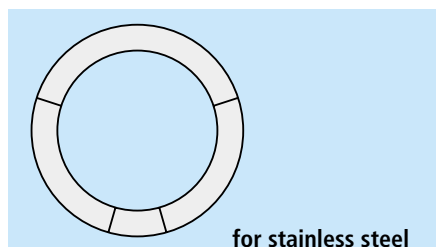
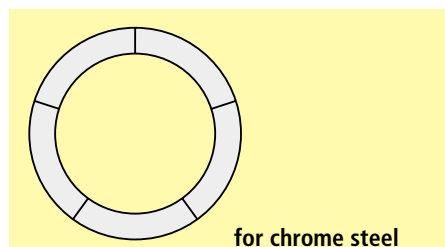

At RMB, all raw material batches used to manufacture every ball bearing component are inspected by the material laboratory manned by metallurgical and chemical engineers. This includes materials for rings, balls, cages, shields and seals. Each batch is analyzed and classified by its grain structure, homogeneity and microscopic cleanliness.

To assure the best raw material, RMB uses vacuum degassed steel and in many cases, double induction melted vacuum degassed steel. These steels are able to meet the highest degree of cleanliness and homogeneity.

RMB uses many different steels able to meet customer specific needs. Please contact our sales and technical engineers for assistance in selecting the correct material for your customized application.

### ■ X105CrMo17 - DIN 1.4125 - AISI 440C

This is the standard material used mainly where corrosion resistance is an issue. The heat treatment of this material ensures a good hardness of 61 HRC, together with a corrosion resistance property. The bearings manufactured with corrosion resistance steel are marked on the face side of the bearings as shown above.

### ■ X30CrMoN15 1 - DIN 1.4108

This stainless steel contains a significant amount of nitrogen, which generates, together with the available carbon, a grain structure, which contains homogeneously distributed microglobular carbonitrides. The chromium content ensures corrosion resistance. The special microstructure provides improved macro mechanical abilities, especially with respect to hot hardness, ductility, bending fatigue limit and breaking elongation. Bearings manufactured using this material will have improved operational behavior and are marked on the face side as shown above.

### ■ X65Cr13 - DIN 1.4037

RMB introduced this stainless steel material many years ago, due to the particular microstructure of the grains. Tests at our internal R&D laboratory have shown that this material can, in many cases, ensure an improvement in the final noise level of the bearings, without any disadvantage in the corrosion resistance properties compared to the AISI 440 C. Bearings manufactured with corrosion resistant steel are marked on the face side of the bearings as shown above.

### ■ 100Cr6 - DIN 1.3505 - AISI 52100

This chrome steel material, known also as bearing steel, is overall the most widely used material for manufacturing bearings of any size. Its composition corresponds to the AISI 52100 standard and assures a good uniform microstructure with a final hardness after heat treatment of 62 HRC. The bearings manufactured with this material are recognizable by the special marking on the bearing as shown above.

Please contact our application engineering department for suggestions on the most suitable steel for your application. For very demanding applications, our engineers will give you the right solution to your bearing application problems both by using standard RMB production steels or by employing exotic ones.

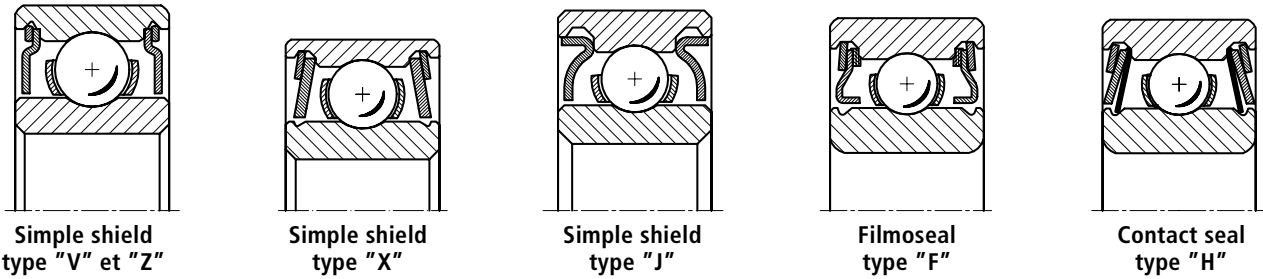

Closures in the form of shields or seals serve the basic purpose of:

- Excluding contamination during bearing handling or assembly.
- Protecting the internal features of the bearing during operation.
- Retaining and minimizing the loss of lubricant due to centrifugal effect.

**RMB standard simple shields**

RMB produces precision shields stamped from stainless steel material. These shields allow a basic protection against external contamination without contact with any bearing rotational part. This guarantees that there is no increased torque, noise level or operative temperature of the bearing. It should be noted that this type of closure does not guarantee complete protection against external dust contamination or penetration by fluids. Our simple shields are identified by one of the following suffixed: "V", "Z", "X" or "J". We can supply fixed or removable shields depending on the needs of your application.

**Filmoseal by RMB a non-contact seal**

A capillary seal, referred to as "Filmoseal" is an exclusive RMB design that is identified by the suffix "F" after the bearing type and before the size.

RMB developed this "Filmoseal" closure in order to have the advantage of a non-contact shield with the practical effect of a seal, by the capillary action of a film of oil. This is accomplished by the ingenious design of the shields and by the special groove in the inner ring.

This design considerably enhances circulation and retention of lubricant within the bearing, avoiding external contamination. The fitting of an oil tight Teflon gasket in the outer ring further assists and prevents lubrication loss. This non-contact seal is recommended when either high speeds or contamination protection are required or when the bearing is subject to high centrifugal forces.

"Filmoseal" by RMB is particularly effective when the outer ring is rotating because the hermetic seal between shield and outer ring avoid any loss of lubricant without any increase of friction, noise or temperature.

**Low torque contact seals, type "H"**

Contact seals are hermetic seals able to guarantee the highest protection against external contamination. RMB contact seals are identified by the suffix "H" after the bearing type and before the dimension size. (i.e. RH 4012X-G48). The "H" contact seal consists of a thin layer of Teflon protected by a stainless steel shield and is recommended when contamination is generated close to the bearings.

Contact seals, by their nature, will increase the operating torque of the bearing. By using Teflon and paying special attention to the contact point during our manufacture, RMB's contact seals can provide maximum protection with only a small increase in torque.

**RMB special closures**

RMB can develop special seals and shields to accommodate the highest customer demands. Please contact our sales engineers or technical staff for further assistance in this area.

**Mounting face to face (suffix .9f)**

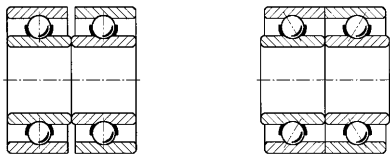

before mounting

after mounting

**Mounting back to back (suffix .9d)**

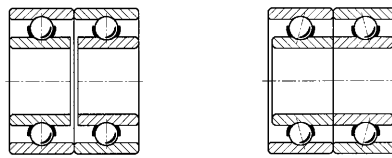

before mounting

after mounting

**Mounting in tandem (suffix .9t)**

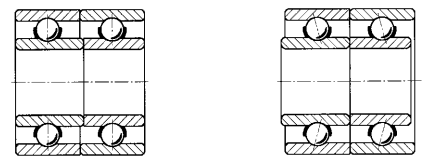

before mounting

after mounting

**Preload and duplex mounting**

Preloading radial or angular contact ball bearings is done to increase rigidity, improve running accuracy and avoid the skidding of balls at very high speed or during acceleration/deceleration. The preload of a ball bearing is generally achieved by an axial load acting on the bearing ring face generally applied by springs or by pre-defined fixed preloads built in during machining.

**Spring Preload**

A spring preload is achieved by using one or more spring washers acting with a predefined axial force against the outer ring or inner ring face of the sliding bearing. When the inner ring is rotating, the spring washer is applied on the outer ring (sliding fit) while when the outer ring is rotating, the spring washer is applied on the inner ring (sliding fit). RMB manufactures very high precision stainless steel spring washers for every standard bearing listed in our standard catalog. It is extremely important that the parallelism of the faces of the washers be held to very tight tolerances in order to ensure proper preload and prevent misalignment of the bearings.

**Fixed Preload (Duplexing)**

In order to preload two or more bearings with greater accuracy, it is necessary to manufacture the rings as shown in figures. The amount of the gap varies depending on the desired amount of preload. Once the ring faces are machined to allow for the gap, the bearings will be preloaded when clamped together in the final assembly.

**“Back to back” or “O” preloading (suffix .9d)**

In this adjustment, the lines of contact angle diverge so that the effective bearing distance of the center is increased. This configuration is mainly used when high speed is required and has the advantage of increasing the tilting moment when external radial forces are applied.

**“Face to face” or “X” preloading (suffix .9f)**

In this arrangement, the contact lines converge so that the effective distance between the bearing centers is decreased. This configuration has the advantage to allow a better accommodation of the bearing set in the event precise alignment cannot be achieved. It is a more forgiving process but still allows for some rigidity in the system.

**“Tandem mounting” (suffix .9t)**

Bearings can also be matched in a tandem mounting arrangement. In this approach, the contact lines are parallel and the radial and axial external forces are shared. The advantage of this configuration is the higher axial capacity in one direction. Normally, another bearing or set of tandem bearings is used on the other end of the shaft to provide for any axial force in the reverse direction.

Principal cages produced by RMB



RMB standard tightly crimped two piece ribbon cage

This is a two-piece stamped ribbon cage. It is satisfactory in the majority of applications where demands are not extreme. It may be used where there are no requirements for low starting or running torque, in medium to high speed applications or when adequate lubrication is assured. This cage type is supplied as standard in most RMB radial miniature bearings where contamination, misalignment and high acceleration/ deceleration are not factors. When the speed factor exceeds 400,000 n-dm it is recommended that you contact our engineering department for further advice.



RMB type "48" loosely crimped two piece ribbon cage for low torque

A very light two-piece stamped ribbon retainer, which rides on the inner ring, it is excellent for eliminating the problem of low torque hang up. This cage type replaces and gives better performance than a spring separator, single piece crown or comb separator. RMB designed the cage "48" specifically for low torque and relative low speed applications because it virtually eliminates the risk of cage "hang-up". For speed factors above 300,000 n-dm, it is recommended you contact our engineering department.



RMB crimped two piece coated ribbon cage

The standard two piece ribbon type as well as the "48" cage may be coated with a thin layer of Teflon, silver, gold or other materials providing self-lubrication when conventional lubricants cannot be used. Teflon coated cages are used in application requiring long term shelf life capabilities, in instruments operating in vacuum and in close proximity to optics. We strongly recommend you to consult our engineering department and/or make practical test on the final application before using any coated cages.

Cages

The retainer, often referred to as "cage" or "separator" is the component of a ball bearing that keeps the balls separated around the pitch circle of the bearing. In order to optimize the performance of any given bearing, RMB has designed and developed many different types of retainers of many different types of materials. A universal ball retainer that would be capable of satisfying all possible requirements simply does not exist. For selecting the best possible retainer, the many requirements to be considered include:

- Starting and running torque.
- Rotational speeds.
- Acceleration and deceleration.
- Operating temperature.
- Lubrication type and amount.
- Application environment (vacuum, chemical agents, etc.).
- Noise requirements.
- External vibrations.
- Self lubricating characteristics.





**RMB type "23" cage for high speed applications**

This is a crown or comb type moulded retainer that can be machined or molded from a range of synthetic materials. With the correct type of base material, this type of retainer can be supplied either oil impregnated in order to achieve longer life or completely dry when environmental conditions do not permit lubrication with conventional lubricants. The cage "23" is used in RMB's high speed applications requiring speeds up to 1.3 million n-dm.

When more extreme speeds are required we suggest you contact our technical office where you can get the best advice for the solution to your application.



**RMB type "25" cage for high speed angular contact bearings**

This is a solid, one-piece machined or molded cage. Cage type "25" has been expressly designed for the bearing series RA and RKA -Angular contact bearings. When possible this cage may be supplied oil impregnated in order to achieve longer life. The ball pockets are counter bored in order to retain the balls within the cage to allow the bearing to be separable. This design enables the removal of the inner ring from the bearing without any risk that the balls will fall out, allowing separate mounting of the two rings where appropriate. The cage "25" is used in RMB's bearings for applications requiring speeds up to 1.5 million n-dm.



**RMB type "27" cage for high speed angular contact bearings**

This retainer is very similar to the "25" cage with the exception that the ball pockets are through-bored. The balls are not retained in the cage if the inner ring is removed in this design. This cage type has the advantage of allowing a lower torque than the "25" cage type. The cage "27" is used in RMB's high-speed applications requiring speeds up to 1.6 million n-dm. When more extreme speeds are required we suggest you contact our technical office where you can get the best advice for the solution to your application and/or make practical test on the final application.

---

### Cage Materials

Each of the above materials has its advantages and benefits depending on the application, lubrication and operating environment. We strongly recommend you contact your nearest RMB sales office or our technical staff who will assist you in determining the best retainer material for your application

RMB can offer many metals and synthetic materials for cages, including but not limited to:

- Phenolics, cotton based.
- Phenolics, linen based.
- Torlon.
- PI.
- POM.
- PEEK.
- Nylasint.
- Teflon.
- Copper-beryllium.
- Brass.

### RMB dedicated special cage design

In the event that none of the above standard cage types satisfy the needs of the customer's application, RMB is also able to manufacture special and fully dedicated designs. Our R&D department is continually testing new innovative materials and cage design able to achieve peak performances. Please contact our sales engineers or our technical staff who will be glad to help select the proper solution to your application challenge.

## Limits of dimensional and functional accuracy of radial bearings

### Precision

All RMB miniature ball bearings are manufactured according to ISO and/or ABEC precision accuracy. The International Standard Organization (ISO) define norms that are used for the accuracy of metric dimension bearings, while the Annular Bearings Engineers Conference (ABEC) are used generally for inch dimension bearings. RMB manufactures to both accuracy standards.

### Limits of dimensional and functional accuracy of radial ball bearings in [ $\mu\text{m}$ ]

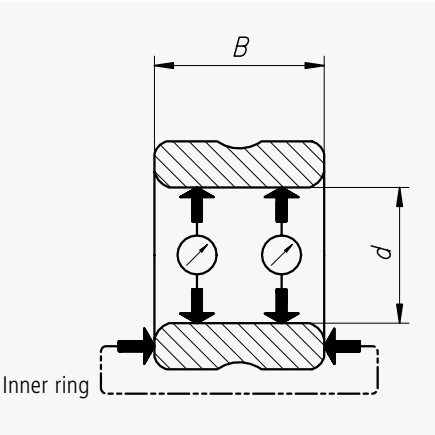
	Grade ISO 492	2		4P			
		ABEC		9P	7P		
RMB suffix		P2	A9P	P4P	A7P		
 Inner ring	$\frac{d_{\max} + d_{\min}}{2} = d_m$	max	0	0	0	0	
		min	-2.5	-2.5	-5	-5	
Absolute limits bore diameter <b>d</b>		max	0	0	0	0	
		min	-2.5	-2.5	-5	-5	
Deviation from roundness	bore max		0.5	-	-	-	
	track max		0.5	-	-	-	
Width <b>B</b>	max		0	0	0	0	
	min		-25	-25	-25	-25	
Deviation from parallel	max		1.5	1.25	2.5	2.5	
		max	0	0	0	0	
$\frac{D_{\max} + D_{\min}}{2} = D_m$		min	-2.5	2.5	-5	-5	
	Absolute limits outside diameter <b>D</b>	max		0	0	0	0
		min		-2.5	-2.5	-5	-5
Deviation from roundness	O.D max		0.5	-	-	-	
	track max		0.5	-	-	-	
Width <b>B</b>	max		0	0	0	0	
	min		-25	-25	-25	-25	
Deviation from parallel	max		1.5	1.25	2.5	2.5	
	Inner ring	max	1.5	1.25	2.5	2.5	
Eccentricity of tracks	Outer ring	max	2	1.25	5	3.75	
	Inner ring	max	2	1.25	2.5	2.5	
Tracks parallelism with sides	Outer ring	max	4	1.25	5	5	
	Inner ring	max	2	1.25	2.5	2.5	
Bore square with side	Inner ring	max	2	1.25	2.5	2.5	
	Outer ring	max	2	1.25	3.75	3.75	
O.D square with side	Outer ring	max	2	1.25	3.75	3.75	

## Limits of dimensional and functional accuracy of radial bearings

RMB's high precision manufacturing and assembly processes allow us to manufacture bearings from ISO 5P and/or ABEC 5P, through ISO2 and/or ABEC 9P.

For the most demanding applications, RMB manufactures bearings with stricter tolerances than required by the standards, even at their highest level. Our sales and technical engineers will guide you through the best solution for your application.

5P		6		0		
5P		3		1		
P5P	A5P	P6	A3	–	A1	
0	0	0	0	0	0	Limits for the arithmetical mean of all the measurements taken in two planes (dm = mean inner diameter).
-5	-5	-7	-5	-8	-7.5	
0	0	+1	+2.5	+1	+2.5	Limits for the absolute value of the smallest and the largest inner diameter measured in two planes
-5	-5	-8	-7.5	-9	-10	
–	–	2	–	–	–	Maximum difference tolerated by RMB between the two concentric circles traced respectively inside and outside of the line of a polar diagram.
–	–	2	–	–	–	
0	0	0	0	0	0	Absolute upper and lower limits of the width of the inner ring
-25	-25	-40	-125	-40	-125	
5	5	12	–	12	–	Maximum difference between the smallest and the largest measured width.
0	0	0	0	0	0	Limits for the arithmetical mean of all the measurements in two planes. (Dm = mean outer diameter)
-5	-5	-7	-7.5	-8	-10	
0	0	+1	+2.5	+1	+2.5	Absolute upper and lower limits of the outer diameter measured in two planes.
-5	-5	-8	-10	-9	-12.5	
–	–	2	–	–	–	Maximum difference tolerated by RMB between the outlines of two concentric circles traced respectively inside and outside of the line of a polar diagram.
–	–	3	–	–	–	
0	0	0	0	0	0	Absolute upper and lower limits of the width of the outer ring.
-25	-25	-40	-125	-40	-125	
5	5	–	–	–	–	Maximum difference between the smallest and the largest measured width.
5	3.75	5	5	10	7.5	Limits of total indicator deviation during one revolution of the inner ring, the outer ring remaining stationary.
5	5	8	10	15	15	Limits of total indicator deviation during one revolution of the outer ring, the inner ring remaining stationary.
7.5	7.5	–	–	–	–	Limits of the total indicator deviation during one revolution of inner ring, the outer ring remaining stationary. (Limits for the runout of the track in relation to the sides).
7.5	7.5	–	–	–	–	Limits of total indicator deviation during one revolution of the outer ring, the inner ring remaining stationary.
7.5	7.5	–	–	–	–	Limits of total indicator deviation during one revolution of the inner ring.
7.5	7.5	–	–	–	–	Limits of total indicator deviation during one revolution of the outer ring.

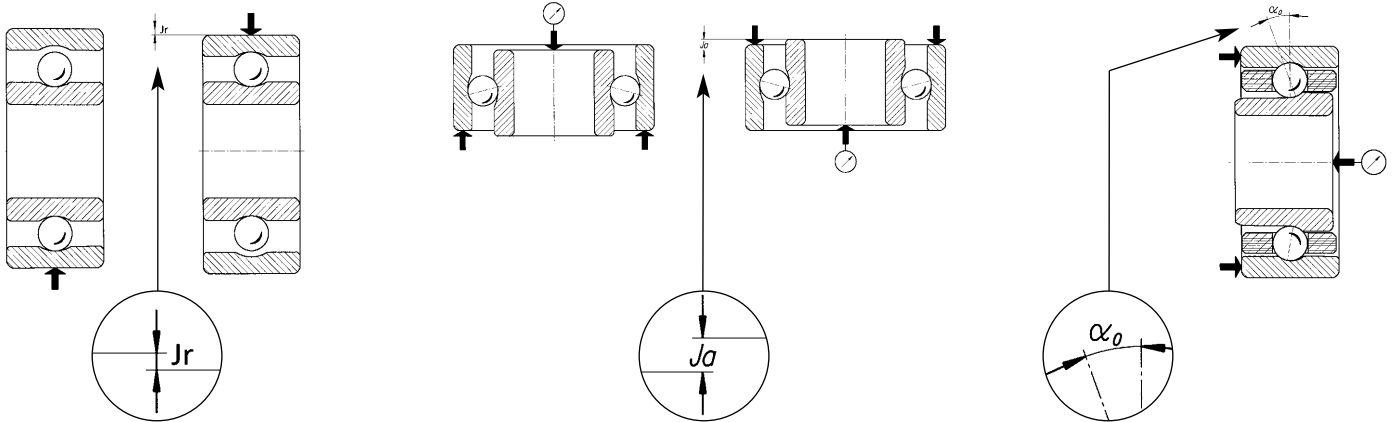

### Radial play

Radial play is not an indication of the quality of the bearing, but its selection is one of the most important parts of the bearing specifications. Without sufficient radial play, interference fits (press fits) and normal expansion of components cannot be accommodated, causing binding and potential early failure.

Radial play of the mounted bearing also influences the operative bearing contact angle, which will affect bearing radial and axial capacity, stiffness, life and other basic performance characteristics. Mounting considerations impacting radial play are noted in our section on shaft and housing tolerances.

Higher values of radial play are beneficial where high speeds create higher heat and where thrust loads predominate. Low values of radial play are better suited for predominately radial loads.

The standard radial play of RMB radial ball bearings is from 6 to 15 [ $\mu\text{m}$ ] (.0002" to .0006"). On request, bearings may be supplied with reduced or greater radial play.

Please contact our sales engineers or technical staff to help you with the proper selection of radial play for your application.

Radial play [ $\mu\text{m}$ ]	Groups			
	2 to 5	6 to 10	11 to 15	16 to 20
Suffix	2/5	6/10	11/15	16/20

### Axial play

The axial play of a bearing is equal to the total axial displacement of the inner ring relative to the outer ring under the effect of a small measuring force. Axial play is a function of the curvature of the races.

### Contact angle

The contact angle of a radial ball bearing or an angular contact ball bearing is the angle formed by the straight line perpendicular to the axis and that which passes through the contact points of the balls in the races after eliminating any radial play.

The contact angle is a function of the radial play, ball size and the radius of curvature of the ball races. It increases slightly when an axial external load is applied on the bearings.

The greater the contact angle, the higher is the axial capacity of the bearings, this means the capability to support axial load is increased.

Please contact our technical application engineers who will be pleased to recommend the appropriate contact angle for your application.

Contact angle $\alpha_0$	Groups				
	11° to 16°	14° to 19°	17° to 22°	20° to 25°	23° to 28°
Suffix	11/16°	14/19°	17/22°	20/25°	23/28°

### Sensitivity

The criteria for bearing sensitivity are very complex and still the subject of study. Research and experience have established some of the essential factors on which sensitivity depends:

- The geometric precision, design and quality of the surface of the race way tracks.
- The geometric precision of the balls.
- The material used for balls and rings.
- The design, material and guidance of ball retainers.
- The characteristic, quantity, quality and disposition of lubricant.
- The precision of housing and shaft where the bearings are mounted.
- The fit tolerances and final play is taken up when mounting the bearings.
- The value and direction of external loads.
- The position of the bearing shaft.

Different projects for the standardization of this measurement are still under investigation.

RMB have been guided by these in developing their own method which is based on practical experience on real application and test at its R&D department.

The sensitivity of the bearings is determined by the interpretation of the relative value of one or several of the following forces:

- Starting torque D.
- Running torque M.
- Hang-up resistance.

In the majority of torque measuring instruments, the bearing to be measured is subjected to a pure axial load (which is principally distributed equally on all the balls of the bearing).

#### **The axial load will be:**

75 cN for bearings up to 10 mm outer diameter inclusive or .375" (9.525 mm) outer diameter inclusive for inch size bearings.

400 cN for bearings exceeding 10 mm outer diameter or .375" (9.525 mm) outer diameter for inch size bearings.

### Starting torque value for instrument ball bearings

The maximum starting torque value listed below are those specified in AFBMA Standards for instrument bearings. They are valid for ABEC 7P quality bearings ( open or closed ) in both stainless steel AISI 440C or carbon chrome steel AISI 52100 fitted with a two piece ribbon cage and lubricated with instrument oil.

They are subjected to the specific definition and test condition defined in that standards. These values can be taken as the maximum which would apply to RMB bearings in this category.

Bore Ø d [inch]	Outside Ø D [inch]	Test load [N]	Maximum starting torque [µNm] Radial internal clearance		
			Tight-fit .0001"-.0003" 2-8 µm	Normal-fit .0002"-.0005" 5-12 µm	Loose-fit .0005"-.0008" 12-20 µm
.0400	.1250	.75	18	15	14
.0469	.1563	.75	18	15	14
.0550	.1875	.75	18	15	14
.0781	.2500	.75	18	15	14
.0938	.3125	.75	18	15	14
.1250	.2500	.75	18	15	14
.1250	.3125	.75	18	15	14
.1250	.3750	.75	20	16	15
.1250	.3750	4	50	45	42
.1250	.5000	4	50	45	42
.1563	.3125	.75	18	15	14
.1875	.3125	.75	18	15	14
.1875	.3750	.75	20	16	15
.1875	.5000	4	65	55	50
.2500	.3750	.75	18	15	14
.2500	.5000	4	60	52	48
.2500	.6250	4	70	60	55
.2500	.7500	4	80	70	65
.3750	.8750	4	110	95	90

## Code for grading by dimensional groups

To facilitate fitting the bearings in the housing and on the shaft, bearings can be supplied with bores and/or outside diameters graded in dimensional groups.

Ø d	Ø D	A	B	C	D	1	2
	Limits [µm]	0 -1.25	-1.25 -2.5	-2.5 -3.75	-3.75 -5	0 -2.5	-2.5 -5
A	0 -1.25	AA	AB	AC	AD	A1	A2
B	-1.25 -2.5	BA	BB	BC	BD	B1	B2
C	-2.5 -3.75	CA	CB	CC	CD	C1	C2
D	-3.75 -5	DA	DB	DC	DD	D1	D2
1	0 -2.5	1A	1B	1C	1D	11	12
2	-2.5 -5	2A	2B	2C	2D	21	22

### Suffix reference

To order bearings graded in dimensional groups their reference should be completed by one of the suffixes in the adjoining table.

Example of complete reference :  
**R 3100X-P4P-S2**

### Examples:

The code number of a group consists of two numerals or letters, or a letter and numeral. The first numeral or letter represents the bore "d". The second numeral or letter represents the outer diameter "D".

### Grading

### in groups of

Diameters	2.5 µm	1.25 µm
Inside «d»	suffixes	
Outside «D»		
d and D	S2	S1.25
d only	SN	SN1.25
D only	SB	SB1.25

### Suffixes

<b>S1.25</b>	d = $\begin{matrix} 0 \\ -1.25 \end{matrix}$	1 <sup>st</sup> letter = A	} group AC
	D = $\begin{matrix} -2.5 \\ -3.75 \end{matrix}$	2 <sup>nd</sup> letter = C	

<b>S2</b>	d = $\begin{matrix} 0 \\ -2.5 \end{matrix}$	1 <sup>st</sup> number = 1	} group 12
	D = $\begin{matrix} -2.5 \\ -5 \end{matrix}$	2 <sup>nd</sup> number = 2	

### Special cases

If one of the two diameters ("d" or "D") is not graded, this diameter is represented in the code by the numeral 0 for instance.

<b>SB</b>	d =	not graded = 0	} group 01
	D = $\begin{matrix} 0 \\ -2.5 \end{matrix}$	= 1	

<b>SN1.25</b>	d = $\begin{matrix} 0 \\ -1.25 \end{matrix}$	= A	} group A0
	D =	not graded = 0	

**Note:** The dimensional group code number is shown on each package of coded bearings, RMB cannot undertake to supply all the bearings of one delivery in a single group.

For miniature ball bearings, the lubricant and method of lubrication is one of the most important factors that will determine the ultimate success of the design. Because of their size, miniature ball bearings may demonstrate significant performance differences from the use of one lubricant to another. The choice of lubricant, the amount and its placement within the bearing are critical factors and the following characteristics should be taken into consideration:

- Rotational speed of inner and / or outer ring.
- Operational rotation condition (intermittent, continuous, tilting etc...).
- External loads (axial, radial tilting).
- Bearings operational temperature and ambient temperature.
- Admissible noise level.

- Expected life time.
- Storage before use.
- Ambient environment where the bearings work (vacuum, chemical agents etc...).
- Starting and running torque required.

Our R&D department develops tests in conjunction with our lubricant suppliers to ensure consistency in the product we receive.

Hundreds of types of oils and greases together with solid lubricants have been tested and are available to meet the most demanding of applications.

Please contact our sales and technical application engineers who will offer the proper lubrication based on their years of experience in this area.

### RMB Standard Lubricants

Stocks are normally available with the following standard lubricants

Radial ball bearings without closures in chrome steel	L23ar
Radial ball bearings without closures in stainless steel	L23
Radial ball bearings with closures, outside diameter <9 mm	L23
Radial ball bearings with closures, outside diameter >9 mm	G48
Angular contact bearings:	G48
Thrust bearings	G48
Linear bearings	L23ar
Ball screws	L23ar

ar = rust protection, i. e. dipped in oil (eg. Reference: L23ar)



## Characteristics of oils and greases most widely used by RMB

### Oils

Reference	Code	Operating temperature range in °C	Peak temp. for short period in °C	Viscosity in [cSt] at 20°C	Flash point °C	Solidifying point in °C	Military specification USA
Isoflex PDP 38	L 2	-65 to + 100	-	23	+205	-70	MIL-L-6085B
Moebius 8145	L 4	-18 to + 100	-	550	+280	-20	-
Isoflex PDP 65	L16	-30 to + 100	-	124	+195	-35	-
Anderol 401 D	L21	-55 to + 148	+160	22	+225	-65	MIL-L-6085B
Winsorlube L 245X	L23	-54 to + 177	+204	24	+216	-60	MIL-L-6085B
Krytox 143 AC	L26	-34 to + 288	-	800	-	-34	-
Dow Corning 200/20	L30	-40 to + 200	-	27	+230	-60	-
Nycolube 11 B	L58	-50 to + 180	-	12.5 at 38°C	+200	-60	MIL-L-6085B NATO 0-147
NUTO 150	L67	0 to + 120	-	557	+265	-24	-

### Greases

Reference	Code	Operating temperature range in °C	Peak temp for short period in °C	Penetration as per ASTM at 25°C	Drop point in °C	Base	Military specification USA
Beacon 325	G 5	-55 to +120	-	285	+175	Lithium	MIL-G-3278A
Andok C	G 9	-30 to +120	-	210	+260	Sodium	-
Olyt J20	G10	-50 to +90	+130	295	+195	Lithium	-
AeroShell Grease 7	G21	-73 to +150	-	290	+260	-	MIL-G-23827B
AeroShell Grease 16	G22	-55 to +204	-	280	+260	-	MIL-G-25760A
Dow Corning DC 33	G39	-73 to +180	+ 200	280	+205	Silicone	-
Shell Alvania RS	G48	-25 to +120	-	280	+180	Lithium	-
Isoflex LDS 18 Special A	G58	-55 to +120	+ 130	280	+185	Lithium	MIL-G-3278A MIL-G-23827B

Lubricant information is tabulated above.

Please note the operating Criteria listed are obtained from the respective manufacturers' Literature.

When working conditions cannot be exactly specified, practical Lubricant tests are essential.

The list of lubricants should not be taken as exclusive. RMB will be pleased to supply other lubricants providing they are readily obtainable.

Correct mounting is of prime importance for the good performance of small bearings.

Experience has shown that the majority of cases of poor performance and undue wear are due to incorrect mounting. It is therefore recommended to take careful note of the following points:

### The choice of fit

Good operation of bearings depends very largely on the quality of their fit. To obtain a satisfactory fit it is necessary to take into account:

- The quality of the surface finish and the geometric precision of the shaft and the housing. They influence the sensitivity and the noise level as well as the good running of a bearing intended for high speeds.
- Variations of temperature. In the case of a higher temperature, the radial expansion of a light metal housing loosens the outer ring while the radial expansion of a light metal shaft reduces radial play. On the other hand, the difference between the axial expansion of a steel shaft and a light metal casing may produce an additional axial load.
- The size, direction and the nature of loads. The load on a bearing at rest should not exceed its static load capacity.
- Axial, radial, combined and reversible loads, which cause elastic changes. These shock loads are very harmful to small bearings and should as far as possible be avoided.
- Relative movement of the inner and outer bearing rings
- The precision and the radial rigidity required for the complete assembly.

The two tables in the following pages indicate, in the central columns, one for shafts, the other for housings, the manufacturing tolerances best adopted to provide the most suitable mounting for:

- Left, the loads and speeds for the application in question
- Right, the degree of precision and radial rigidity which should be attained.

These tolerances are given in [ $\mu\text{m}$ ] and are valid only when the material of the shafts and housings have the same coefficient of expansion as the steel of the bearing\*

In all other cases, it is necessary to take account of the differences of expansion. In general, it is accepted that the mountings mentioned in the following tables are indicated as suitable for normal working temperatures while for exceptional temperatures, the press fit or play should not be excessive.

The best solution, due to the variables in bearings and mating parts, problems in the operating environments of bearings and the correct choice of the bearing, often can be proposed only after laboratory investigation has identified the source of the problem. The RMB laboratory is well equipped to conduct this type of investigation when conditions so warrant it.

To facilitate mounting, RMB bearings can be supplied with bore and/or outer diameter graded in dimensional groups.

\*Coefficient of expansion of bearing steel:  $11 \times 10^{-6} / ^\circ\text{C}^{-1}$

## Shaft and housing tolerances

### Shaft tolerances

Shaft and bearing of **identical** material; otherwise allowance must be made for different coefficients<sup>1</sup> of expansion  $d_{shaft}=d+tol.$

Shaft	Load-Speed	Fit	Tolerance of bore d				Mounting precision	Typical applications	Inner-ring laterally
			0/-8 [μm]	0/-5 [μm]	Grade				
					0/- 2.5	-2.5/-5			
Revolving or fixed	Small loads Low to medium speeds No vibrations	sliding fit	Shaft				Standard precision without special requirements	Guides (films, strips etc)	fixed
			-5 -13	-5 -11	-5 -8	-8 -11			
Fixed	Medium loads Medium speeds High frequency vibrations	light press fit	0 -8	0 -6	0 -3	-3 -6	Precise radial guiding Radial rigidity	Gyro rotors	fixed
Revolving	Small loads Medium speeds Low frequency vibrations		Standard precision	Small motors Potentiometers Servo motors	free				
Fixed	High loads High speeds High frequency vibrations	medium press fit	+4 -4	+4 -2	+4 +1	+1 -2	Press fit required particularly high speeds. Very rigid radially.	Gyro rotors Fan motors Electric motors Gear boxes	free
Revolving	Medium to high loads High speeds High frequency vibrations								

### Housing tolerances

Housing and bearing of **identical** material; otherwise allowance must be made for different coefficients<sup>1</sup> of expansion.  $d_{shaft}=d+tol.$

Outer ring	Load-Speed	Fit	Tolerance of outer D				Mounting precision	Typical applications
			0/-8 [μm]	0/-5 [μm]	Grade			
					0/- 2.5	-2.5/-5		
Revolving or fixed	Small loads Low to medium speeds No vibrations	sliding fit	Housing				Standard precision Without special requirements Outer ring should slide laterally (expansion)	Electric motors Servo motors Fan motors Potentiometers
			+5 -3	+5 -1	+5 +2	+2 -1		
Fixed	Medium loads Medium speeds High frequency vibrations	light press fit	0 -8	0 -6	0 -3	-3 -6	Precise radial guiding Outer ring must be fixed laterally	Synchro motors Gyroscope gimbals
Revolving	Small loads Medium speeds High frequency vibrations		Standard precision	Guides Rollers Couplings				
Fixed	High loads High speeds High frequency vibrations	medium press fit	-4 -12	-3 -9	-3 -6	-6 -9	Press fit required particularly at high speeds. The outer ring must not necessarily be fixed laterally. Very rigid radially.	Pulleys Idlers Planetary gears
Revolving	Medium to high loads High speeds High frequency vibrations							

<sup>1</sup> Coefficient of expansion of bearing steel:  $11 \times 10^{-6} / ^\circ\text{C}^{-1}$

The dimensions  $d, D, B$  (Bf),  $L_i, L_o, r_{max}$  and  $h_{min}$  given in the bearing tables enable designers to determine exactly the overall dimensions of small bearings

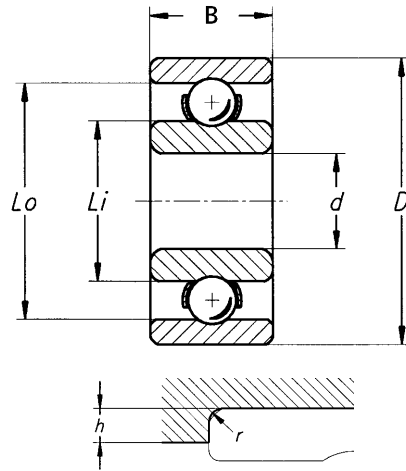

- $d$  = Inner diameter
- $D$  = Outer diameter
- $B$  = Width of rings
- $L_i$  = Minimum diameter of housing shoulder
- $L_o$  = Maximum diameter radii of shaft or housing
- $r_{max}$  = Maximum fillet radius of shaft or housing
- $h_{min}$  = Minimum height of shoulder on shaft or housing

## What to avoid

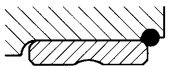

- Larger radii than  $r_{max}$  and shoulder heights of circlips lower than  $h_{min}$ .  
Consequences: axial position uncertain and risk of ring deformation.

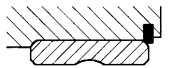

- Shoulder and circlips lower than  $h_{min}$ .  
Consequences: same as above.

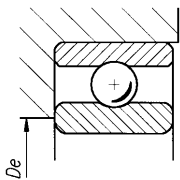

- Diameter  $D_e$  of housing shoulder smaller than  $L_i$ .  
Consequences: shoulder touches the inner ring.

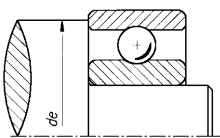

- Diameter  $d_e$  of shoulder on shaft larger than  $L_o$ .  
Consequences: shoulder touches the outer ring.

## What to ensure

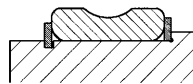

- Above all, the values  $L_i, L_o, r_{max}$  and  $h_{min}$  should be strictly observed.

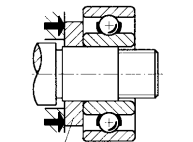

- The following diagrams on this page show how a bearing should normally be installed or removed.

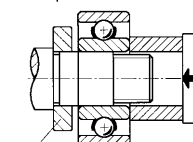

- If for reasons of design the shoulder is unavoidably too small, a ground thrust ring should be provided between shoulder and bearing.

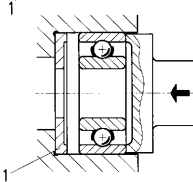

- Installing and removing of radial bearings requires special care in order to avoid any force being transmitted through the shaft to the opposite end bearing. Furthermore, the bearing opposite to the one which is being installed should be protected so as to avoid any load or shock on the balls.

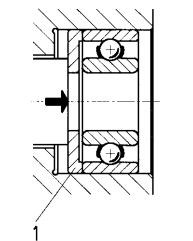

- The load must be applied directly on the ring which is being installed or removed. For this reason shims 1 should be provided in order to facilitate removal. If such shims cannot be used, recesses should be machined on shoulders in housings or on shafts to permit the introduction of special dismantling tools.

## Calculation of loads

Small bearings are, most frequently, only subject to relatively low loads which nevertheless influence the length of their service life. For this reason, it is advisable to determine, as far as possible, the direction and the magnitude of these forces.

### Loads to consider:

1. Weight of the moving part
2. Centrifugal force (unbalanced forces)
3. Dynamic load (acceleration, braking)
4. Force resulting from transmission of energy (pulley, gear etc)
5. Preload resulting from a duplex mounting<sup>1</sup>

### Direction and distribution of loads

#### Fr pure radial load

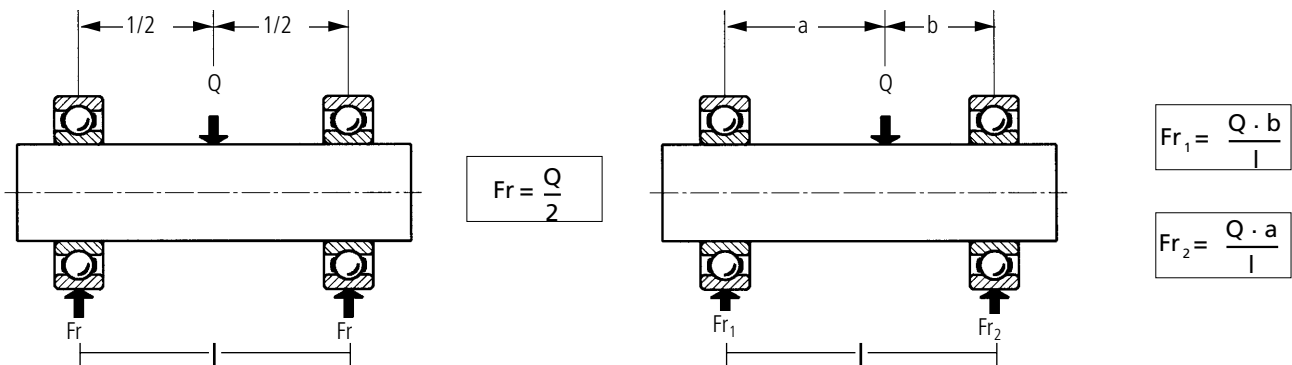

#### Fa pure axial load

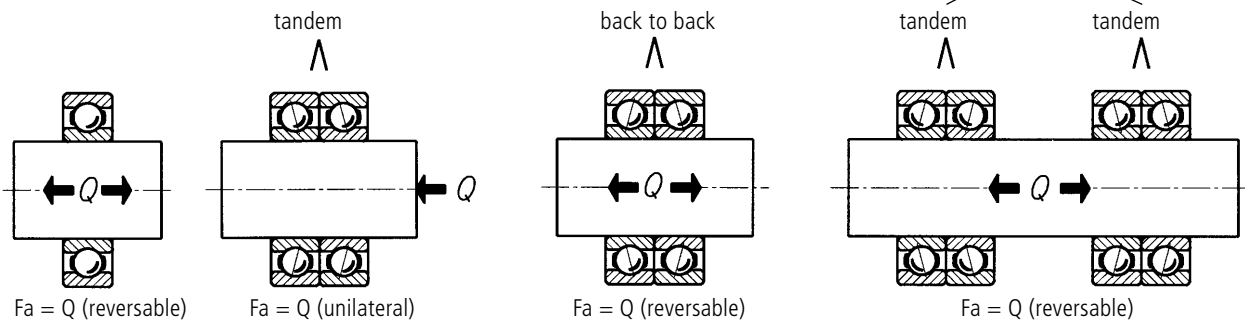

**Note:** For an axial load to be supported by several bearings, it is essential that these should be paired<sup>1</sup>, ring against ring or by means of very precise spacers.

#### Combined loads (radial and axial)

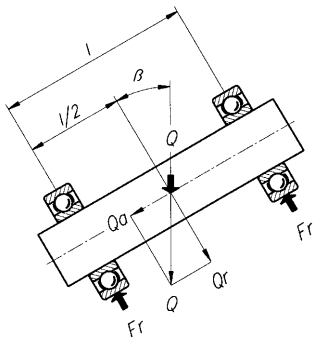

$$Q_r = \cos \beta \cdot Q$$

$$Q_a = \sin \beta \cdot Q$$

#### normal mounting

$$Fr = \frac{Q_r}{2}$$

$$Fa = Q_a \text{ (the axial load is supported by one bearing only)}$$

#### Duplex mounting in tandem (shim)

$$Fr = Q_r$$

$$Fa = Q_a$$

#### Preload Fap

Bearings mounted in duplex<sup>1</sup>, back to back or face to face are subjected to a **preload** ( $F_{ap}$ ) higher or lower than the axial load  $F_a$ . This **preload**  $F_{ap}$  should be determined in each case taking into account operational criteria and the life expectancy.

<sup>1</sup>) see section "Duplex-mounting" on page 9

## Calculation of the theoretical life expectancy of ball bearings

---

The theoretical life expectancy has no practical value unless the following conditions are scrupulously fulfilled:

- Strength and direction of constant loads carefully determined.
- Constant speed.
- Constant temperature not exceeding 100°C.
- Strict cleanliness in mounting and during running
- Careful choice and dosage of lubricant.
- Mounting strictly in accordance with the instructions given in page 20-22.

In all cases of complexity or doubt it is advisable to consult our technical staff.

For calculating the load capacity and the theoretical life of bearings we have used the formulae based on those of ISO and AFBMA standards.

### 1. Life expectancy of radial bearings and thrust bearings

$$L = \left(\frac{C}{P}\right)^3$$

#### Legend

L	=	Life expectancy in millions of revolutions
C	=	Dynamic load capacity in [N]
P	=	Equivalent dynamic load in [N]
C/P	=	Load ratio

### 2. Life expectancy in hours

$$Lh = \frac{L \cdot 10^6}{60 \cdot n}$$

#### Legend

Lh	=	Life expectancy in hours
n	=	Revolution in [rpm]

### 3. Definitions

L, Lh= Number of millions of revolutions or hours at constant speed that 90% of a group of apparently identical bearings will attain or exceed before the first evidence of fatigue develops. The life which 40% of the group of ball bearings will complete or exceed is approximately five times this life expectancy.

C = Dynamic load rating. This is the constant radial load, stationary with respect to the outer ring, that a bearing can endure for a rating life of one million revolutions of the inner ring or 500 hours at 33 1/3 [rpm].

The dynamic load takes into account:

- Repeated deformation of several elements (tracks and balls) as a function of the mechanical resistance of their materials and of their materials and of their geometric form
- frequency of loads
- an empirical probability factor

P = Equivalent dynamic load which takes into account the distribution of axial and radial forces affecting different elements as a function of their elasticity and of their geometric form (radial play, tracks, and ball diameters).

Co = This is the pure radial load which affects the bearing under the following conditions:

- zero [rpm]
- very slow oscillating movements
- very low revolutions

This load is permissible when, distributed between balls and tracks, a permanent deformation of 1/10,000 of the ball diameter is not exceeded.

Po = Equivalent static load.

<p><b>Newton / lb conversion</b> 1 Newton <math>\triangleq</math> 0.225 lb 1 lb <math>\triangleq</math> 4.45 Newton</p>
---

## 4. Calculation of Equivalent dynamic load

### 4.1 Radial ball bearings

$$P = X \cdot Fr + Y \cdot Fa$$

#### Legend

P = the Equivalent dynamic load in [N]  
 Fr = effective radial load in [N]  
 Fa = effective thrust load in [N]  
 X = the radial factor of the bearing according to the table on page 28  
 Y = the thrust factor of the bearing according to the table on page 28

### 4.2 Thrust bearings

$$P = Fa$$

## 5. static load capacity

$$Co = so \cdot Po$$

#### Legend

Co = static load capacity in [N]  
 Po = static Equivalent load in [N]  
 so = static load safety factor

The following value for the static load safety factor changes depending on applications of the ball bearing according the following variations:

so = 0.5 to 0.7 for quiet and vibration free use  
 so = 1.0 to 1.2 for normal use with minimum vibrations  
 so = 1.5 to 2.0 for high demands and use with heavy shock loads

## 6. Calculation of Equivalent static load

### 6.1 Radial ball bearings

$$Po = Xo \cdot Fr + Yo \cdot Fa$$

#### Legend

Po = static Equivalent load in [N]  
 Fr = maximum radial static load in [N]  
 Fa = maximum thrust load in [N]  
 Xo = the radial factor  
 Yo = thrust factor  
 If the result for Po, calculated according to this formula, is smaller than Fr, then use Po = Fr

Values for the coefficient Xo and Yo

Xo = 0.6    Yo = 0.5

### 6.2 Thrust bearings

$$Po = Fa$$

## 7. Duplex bearings

When two single row bearings are duplexed face to face, back to back, or in tandem arrangement, calculation of dynamic as well as Equivalent dynamic load should be considered.

### 7.1 Duplex installation face to face or back to back

#### Dynamic load capacity

$$Cd = (2 \cdot \cos \alpha_o)^{0.7} \cdot C$$

$$L = \left( \frac{Cd}{P} \right)^3$$

#### Legend

Cd = the dynamic load capacity for a pair of ball bearings in [N]  
 $\alpha_o$  = contact angle  
 C = dynamic load capacity for a single ball bearing in [N]  
 L = life expectancy in millions of revolutions  
 P = the Equivalent dynamic load in [N]

#### Equivalent dynamic load

$$P = X \cdot Fr + Y \cdot Fa$$

#### Legend

P = the Equivalent dynamic load in [N]  
 Fr = effective radial load in [N]  
 Fa = effective thrust load in [N]  
 X = the radial factor of the bearing according to the table on page 28  
 Y = the thrust factor of the bearing according to the table on page 28

#### Duplex mounting back to back or face to face with preload

$$Fa = 0.8 (Fap + Fa1)^*$$

#### Legend

Fa = effective axial load in [N]  
 Fap = preload in [N]  
 Fa1 = axial load on the duplex pair, in [N]

\* Determine the preload Fap in relation to the axial load Fa1, in such a way that no bearing should be without load.

Within the range of play and contact angles considered by RMB, this condition will be realized when

$$Fap \geq 0,35 Fa1$$

#### Back to back or face to face assembly without preload or with residual axial play

Sometimes duplex bearings are assembled back to back or face to face with a residual axial play of a few [µm]. In those cases calculations are made using formulae mentioned in 7.1. Use factor X and Y from tables on page 27 taking care to include in the formula:

$$\frac{Fa}{2 \cdot Z \cdot Dw^2} \text{ (total number of balls in two bearings)}$$

## 7.2 Tandem assembly

### Dynamic load capacity

$$C_t = C \cdot N^{0.7}$$

#### Legend

$C_t$  = Dynamic load capacity of the tandem assembly in [N]  
 $C$  = Dynamic load capacity of a single bearing in [N]  
 $N$  = Number of bearings

To calculate the Equivalent dynamic load and the life, proceed as for a bearing with a single row of balls applying factors X, Y and referring to bearings with single row of balls according to table on page 28.

## 8. Examples of calculations

### Example 1

To calculate the theoretical life  $L_h$  of a R 2570X bearing working under the following service conditions:

Radial charge  $F_r = 5.7$  N  
 Axial load  $F_a = 2.8$  N  
 Speed  $n = 8000$  rpm  
 Radial play  $2/5$   $\mu$ m

For bearing R 2570X:

$C = 142$  N  
 $Z \cdot Dw^2 = 8$   
 $P = X \cdot F_r + Y \cdot F_a$

$$\frac{F_a}{Z \cdot Dw^2} = \frac{2.8}{8} = 0.35 \longrightarrow e = 0.12$$

$$\frac{F_a}{F_r} = \frac{2.8}{5.7} = 0.5 \text{ therefore } > e \text{ from which}$$

$X = 0.56$   
 $Y = 2.77$   
 $P = 0.56 \cdot 5.7 + 2.77 \cdot 2.8$   
 $= 3.2 + 7.8 = 11$  N

$$\frac{C}{P} = \frac{142}{11} = 12.9$$

$$L = \left(\frac{C}{P}\right)^3 = 12.9^3 = 2147$$

$$L_h = \frac{L \cdot 10^6}{60 \cdot n} = \frac{2147 \cdot 10^6}{60 \cdot 8000}$$

$$L_h = 4473 \text{ h}$$

According to table on page 30, we also find  $L_h = 4500$  h by interpolation

### Example 2

To install a spin axis (of a gyroscope) with 2 preloaded RA bearings, as a duplex, back to back pair.

Radial load  $F_r = 4$  N  
 Axial load  $F_{a1} = 12$  N  
 Speed  $n = 24000$  rpm  
 Contact angle  $\alpha_c = 20^\circ$   
 Design life  $L_h = 5000$  h  
 Choice of bearing = ?

$$L_h = \frac{L \cdot 10^6}{60 \cdot n} = 5000 \text{ h}$$

$$L = \left(\frac{C_d}{P}\right)^3 = 7200$$

$$\frac{C_d}{P} = \sqrt[3]{7200} = 19.3$$

or, according to table on page 31, by interpolation

$$\frac{C_d}{P} = 19.3$$

According to page 25 preload  
 $F_{ap} \geq 0.35 \cdot F_{a1} = 0.35 \cdot 12 = 4.2$  N

Assuming a preload  $F_{ap} = 6$  N  
 $F_a = 0.8 (F_{ap} + F_{a1}) = 0.8 (6 + 12)$   
 $= 0.8 \cdot 18 = 14.4$  N

According to page 28

$\alpha_c = 20^\circ$   
 $e = 0.50$

$$\frac{F_a}{F_r} = \frac{14.4}{4} = 3.6 \text{ therefore } > e \text{ from which}$$

$X = 0.70$   
 $Y = 1.86$   
 $P = X \cdot F_r + Y \cdot F_a = 0.70 \cdot 4 + 1.86 \cdot 14.4$   
 $= 2.8 + 26.7 = 29.5$  N

$$\frac{C_d}{P} = 19.3$$

$$C_d = 19.3 \cdot P = 19.3 \cdot 29.5 = 569$$

$$C_d = (2 \cdot \cos \alpha_c)^{0.7} \cdot C$$

$$C = \frac{C_d}{(2 \cdot \cos \alpha_c)^{0.7}} = \frac{569}{(2 \cdot \cos 20^\circ)^{0.7}} = \frac{569}{1.55} = 367 \text{ N}$$

The bearing RA 3100X. 9d/600-... with its dynamic load capacity  $C = 332$  N (8 balls) is marginally too small. If space allows it a RA 4130X.9d/600-... will be selected



Determination of the service life expectancy ( $10^6$  rpm), as a function of the load factor C/P

L	C/P	L	C/P	L	C/P
0.5	0.793	260	6.38	2400	13.4
0.75	0.909	280	6.54	2600	13.8
1.0	1.0	300	6.69	2800	14.1
1.5	1.14	320	6.84	3000	14.4
2	1.26	340	6.98	3200	14.7
3	1.44	360	7.11	3400	15.0
4	1.59	380	7.24	3600	15.3
5	1.71	400	7.37	3800	15.6
6	1.82	420	7.49	4000	15.9
8	2.0	440	7.61	4500	16.5
10	2.15	460	7.72	5000	17.1
12	2.29	480	7.83	5500	17.7
14	2.41	500	7.94	6000	18.2
16	2.52	550	8.19	6500	18.7
18	2.62	600	8.43	7000	19.1
20	2.71	650	8.66	7500	19.6
25	2.92	700	8.88	8000	20.0
30	3.11	750	9.09	8500	20.4
35	3.27	800	9.28	9000	20.8
40	3.42	850	9.47	9500	21.2
45	3.56	900	9.65	10000	21.5
50	3.68	950	9.83	12000	22.9
60	3.91	1000	10.0	14000	24.1
70	4.12	1100	10.3	16000	25.2
80	4.31	1200	10.6	18000	26.2
90	4.48	1300	10.9	20000	27.1
100	4.64	1400	11.2	25000	29.2
120	4.93	1500	11.4	30000	31.1
140	5.19	1600	11.7	35000	32.7
160	5.43	1700	11.9	40000	34.2
180	5.65	1800	12.2	45000	35.5
200	5.85	1900	12.4	50000	36.8
220	6.04	2000	12.6	55000	38.1
240	6.21	2200	13.0	60000	39.2

## Calculation of the theoretical life expectancy of ball bearings

Radial factor X and axial factor Y to be used for calculating the equivalent dynamic load for radial single row ball bearings.

Contact Angle	$\frac{F_a}{Z \cdot D_w^2}$	$\frac{F_a}{F_r} \geq e$		
		X	Y	e
$\leq 5^\circ$	0.17	0.56	3.09	0.09
	0.35		2.77	0.12
	0.70		2.43	0.14
	1.05		2.23	0.15
	1.40		2.10	0.16
	2.10		1.92	0.18
	3.51		1.71	0.21
	5.27		1.56	0.23
7.03		1.44	0.24	
$10^\circ$	0.17	0.46	2.20	0.25
	0.35		2.09	0.26
	0.70		1.94	0.28
	1.05		1.84	0.29
	1.40		1.77	0.31
	2.10		1.66	0.33
	3.51		1.53	0.35
	5.27		1.44	0.38
7.03		1.36	0.40	
$15^\circ$	0.17	0.44	1.55	0.35
	0.35		1.51	0.36
	0.70		1.48	0.36
	1.05		1.42	0.38
	1.40		1.39	0.39
	2.10		1.34	0.41
	3.51		1.26	0.43
	5.27		1.20	0.45
7.03		1.16	0.47	
20°		0.43	1.14	0.50
25°		0.41	0.95	0.62
30°		0.39	0.81	0.75
35°		0.37	0.69	0.91
40°		0.35	0.60	1.08

When  $\frac{F_a}{F_r} \leq e$  has to be calculated with X = 1, Y = 0

Determine X and Y factors relating to intermediate values of load and contact angle by linear interpolation.

F<sub>a</sub> = Thrust load in [N]  
 Z = Number of balls  
 D<sub>w</sub> = diameter of balls in mm

Radial factor X and axial factor Y to be used for calculating the equivalent dynamic load for duplex pairs of radial ball bearings contact angle 0° to 40°

Contact Angle	$\frac{F_a}{Z \cdot D_w^2}$	$\frac{F_a}{F_r} \leq e$		$\frac{F_a}{F_r} \geq e$		
		X	Y	X	Y	e
0°	0.17	1	0	0.56	3.09	0.09
	0.35				2.77	0.12
	0.70				2.43	0.14
	1.05				2.23	0.15
	1.40				2.10	0.16
	2.10				1.92	0.18
	3.51				1.71	0.21
	5.27				1.56	0.23
7.03				1.44	0.24	
5°	0.17	1	3.69	0.78	5.02	0.17
	0.35		3.30		4.49	0.19
	0.70		2.89		3.94	0.22
	1.05		2.66		3.63	0.24
	1.40		2.50		3.41	0.25
	2.10		2.29		3.12	0.27
	3.51		2.04		2.78	0.31
	5.27		1.86		2.53	0.34
7.03		1.72		2.35	0.36	
10°	0.17	1	2.25	0.75	3.58	0.25
	0.35		2.41		3.39	0.26
	0.70		2.24		3.14	0.28
	1.05		2.13		2.99	0.29
	1.40		2.04		2.87	0.31
	2.10		1.92		2.69	0.33
	3.51		1.77		2.49	0.35
	5.27		1.66		2.33	0.38
7.03		1.57		2.21	0.40	
15°	0.17	1	1.74	0.72	2.52	0.35
	0.35		1.70		2.46	0.36
	0.70		1.66		2.41	0.36
	1.05		1.59		2.31	0.38
	1.40		1.56		2.25	0.39
	2.10		1.50		2.17	0.41
	3.51		1.42		2.05	0.43
	5.27		1.35		1.96	0.45
7.03		1.30		1.88	0.47	
20°		1	1.25	0.70	1.86	0.50
25°		1	1.00	0.67	1.55	0.62
30°		1	0.83	0.63	1.31	0.75
35°		1	0.69	0.60	1.12	0.91
40°		1	0.58	0.57	0.97	1.08

## Calculation of the theoretical life expectancy of ball bearings

Lh in hours as a function of the load factor C/P, speed in [rpm]

Lh	n [rpm]											
	10	40	100	160	200	250	320	400	500	630	800	1000
100	–	–	–	–	1.06	1.15	1.24	1.34	1.45	1.56	1.68	1.82
500	–	1.06	1.45	1.68	1.82	1.96	2.12	2.29	2.47	2.67	2.88	3.11
1000	–	1.34	1.82	2.12	2.29	2.47	2.67	2.88	3.11	3.36	3.63	3.91
1250	–	1.45	1.96	2.29	2.47	2.67	2.88	3.11	3.36	3.63	3.91	4.23
1600	–	1.56	2.12	2.47	2.67	2.88	3.11	3.36	3.63	3.91	4.23	4.56
2000	1.06	1.68	2.29	2.67	2.88	3.11	3.36	3.63	3.91	4.23	4.56	4.93
2500	1.15	1.82	2.47	2.88	3.11	3.36	3.63	3.91	4.23	4.56	4.93	5.32
3200	1.24	1.96	2.67	3.11	3.36	3.63	3.91	4.23	4.56	4.93	5.32	5.75
4000	1.34	2.12	2.88	3.36	3.63	3.91	4.23	4.56	4.93	5.32	5.75	6.20
5000	1.45	2.29	3.11	3.63	3.91	4.23	4.56	4.93	5.32	5.75	6.20	6.70
6300	1.56	2.47	3.36	3.91	4.23	4.56	4.93	5.32	5.75	6.20	6.70	7.23
8000	1.68	2.67	3.63	4.23	4.56	4.93	5.32	5.75	6.20	6.70	7.23	7.81
10000	1.82	2.88	3.91	4.56	4.93	5.32	5.75	6.20	6.70	7.23	7.81	8.43
12500	1.96	3.11	4.23	4.93	5.32	5.75	6.20	6.70	7.23	7.81	8.43	9.11
16000	2.12	3.36	4.56	5.32	5.75	6.20	6.70	7.23	7.81	8.43	9.11	9.83
20000	2.29	3.63	4.93	5.75	6.20	6.70	7.23	7.81	8.43	9.11	9.83	10.6
25000	2.47	3.91	5.32	6.20	6.70	7.23	7.81	8.43	9.11	9.83	10.6	11.5
32000	2.67	4.23	5.75	6.70	7.23	7.81	8.43	9.11	9.83	10.6	11.5	12.4
40000	2.88	4.56	6.20	7.23	7.81	8.43	9.11	9.83	10.6	11.5	12.4	13.4
50000	3.11	4.93	6.70	7.81	8.43	9.11	9.83	10.6	11.5	12.4	13.4	14.5
63000	3.36	5.32	7.23	8.43	9.11	9.83	10.6	11.5	12.4	13.4	14.5	15.6
80000	3.63	5.75	7.81	9.11	9.83	10.6	11.5	12.4	13.4	14.5	15.6	16.8
100000	3.91	6.20	8.43	9.83	10.6	11.5	12.4	13.4	14.5	15.6	16.8	18.2
200000	4.93	7.81	10.6	12.4	13.4	14.5	15.6	16.8	18.2	19.6	21.2	22.9

## Calculation of the theoretical life expectancy of ball bearings

Lh in hours as a function of the load factor C/P, speed in [rpm]

Lh	n [rpm]										
	1250	1600	2000	2500	3200	4000	5000	6300	8000	10000	12500
100	1.96	2.12	2.29	2.47	2.67	2.88	3.11	3.36	3.63	3.91	4.23
500	3.36	3.63	3.91	4.2	4.56	4.93	5.32	5.75	6.20	6.70	7.23
1000	4.23	4.56	4.93	5.32	5.75	6.20	6.70	7.23	7.81	8.43	9.11
1250	4.56	4.93	5.32	5.75	6.20	6.70	7.23	7.81	8.43	9.11	9.83
1600	4.93	5.32	5.75	6.20	6.70	7.23	7.81	8.43	9.11	9.83	10.6
2000	5.32	5.75	6.20	6.70	7.23	7.81	8.43	9.11	9.83	10.6	11.5
2500	5.75	6.20	6.70	7.23	7.81	8.43	9.11	9.83	10.6	11.5	12.4
3200	6.20	6.70	7.23	7.81	8.43	9.11	9.83	10.6	11.5	12.4	13.4
4000	6.70	7.23	7.81	8.43	9.11	9.83	10.6	11.5	12.4	13.4	14.5
5000	7.23	7.81	8.43	9.11	9.83	10.6	11.5	12.4	13.4	14.5	15.6
6300	7.81	8.43	9.11	9.83	10.6	11.5	12.4	13.4	14.5	15.6	16.8
8000	8.43	9.11	9.83	10.6	11.5	12.4	13.4	14.5	15.6	16.8	18.2
10000	9.11	9.83	10.6	11.5	12.4	13.4	14.5	15.6	16.8	18.2	19.6
12500	9.83	10.6	11.5	12.4	13.4	14.5	15.6	16.8	18.2	19.6	21.2
16000	10.6	11.5	12.4	13.4	14.5	15.6	16.8	18.2	19.6	21.2	22.9
20000	11.5	12.4	13.4	14.5	15.6	16.8	18.2	19.6	21.2	22.9	24.7
25000	12.4	13.4	14.5	15.6	16.8	18.2	19.6	21.2	22.9	24.7	26.7
32000	13.4	14.5	15.6	16.8	18.2	19.6	21.2	22.9	24.7	26.7	28.8
40000	14.5	15.6	16.8	18.2	19.6	21.2	22.9	24.7	26.7	28.8	31.1
50000	15.6	16.8	18.2	19.6	21.2	22.9	24.7	26.7	28.8	31.1	33.6
63000	16.8	18.2	19.6	21.2	22.9	24.7	26.7	28.8	31.1	33.6	36.3
80000	18.2	19.6	21.2	22.9	24.7	26.7	28.8	31.1	33.6	36.3	39.2
100000	19.6	21.2	22.9	24.7	26.7	28.8	31.1	33.6	36.3	39.2	–
200000	24.7	26.7	28.8	31.1	33.6	36.3	39.2	–	–	–	–

## Calculation of the theoretical life expectancy of ball bearings

Lh in hours as a function of the load factor C/P, speed in [rpm]

Lh	n [rpm]								
	16000	20000	25000	32000	40000	50000	63000	80000	100000
100	4.56	4.93	5.32	5.75	6.20	6.70	7.23	7.81	8.43
500	7.81	8.43	9.11	9.83	10.6	11.5	12.4	13.4	14.5
1000	9.83	10.6	11.5	12.4	13.4	14.5	15.6	16.8	18.2
1250	12.4	11.5	12.4	13.4	14.5	15.6	16.8	18.2	19.6
1600	11.5	12.4	13.4	14.5	15.6	16.8	18.2	19.6	21.2
2000	12.4	13.4	14.5	15.6	16.8	18.2	19.6	21.2	22.9
2500	13.4	14.5	15.6	16.8	18.2	19.6	21.2	22.9	24.7
3200	14.5	15.6	16.8	18.2	19.6	21.2	22.9	24.7	26.7
4000	15.6	16.8	18.2	19.6	21.2	22.9	24.7	26.7	28.8
5000	16.8	18.2	19.6	21.2	22.9	24.7	26.7	28.8	31.1
6300	18.2	19.6	21.2	22.9	24.7	26.7	28.8	31.1	33.6
8000	19.6	21.2	22.9	24.7	26.7	28.8	31.1	33.6	36.3
10000	21.2	22.9	24.7	26.7	28.8	31.1	33.6	36.3	39.2
12500	22.9	24.7	26.7	28.8	31.1	33.6	36.3	39.2	-
16000	24.7	26.7	28.8	31.1	33.6	36.3	39.2	-	-
20000	26.7	28.8	31.1	33.6	36.3	39.2	-	-	-
25000	28.8	31.1	33.6	36.3	39.2	-	-	-	-
32000	31.1	33.6	36.3	39.2	-	-	-	-	-
40000	33.6	36.3	39.2	-	-	-	-	-	-
50000	36.3	39.2	-	-	-	-	-	-	-
63000	39.2	-	-	-	-	-	-	-	-
80000	-	-	-	-	-	-	-	-	-
100000	-	-	-	-	-	-	-	-	-
200000	-	-	-	-	-	-	-	-	-

Packaging has the function of protecting the bearings during transportation and during storage periods before use in the final application.

RMB packaging is designed to ensure protection against:

- Contamination
- Humidity
- Transportation
- Deterioration of bearings lubricant

According to the bearings type and technical characteristics RMB packages bearings with the most suitable package type in order to ensure the above protection.

Unless otherwise specified by the customer, RMB bearings are packaged in small synthetic plastic pouches hermetically sealed by heat sealing in a quantity per pouch depending on the bearing type, characteristic and dimension.

The plastic pouches are enclosed in a pouch and delivered in resistant carton boxes to protect them against shock during transportation.

Apart from the above standard package, RMB can deliver bearings in the following packages:

- Plastic transparent strips with each pocket separated by heat sealing.
- Individually packaged by single strip pocket heat sealed.
- Individually packaged by metallic pouches.
- In vials with quantity per tube according to the bearings type and dimension.

Should any other packaging method be desired it is advisable to consult our technical department



# Radial single row ball bearings



R/UL  
open

RV/ULV  
with  
shields

ULZ  
with  
shields

RX  
with  
shields

RF  
with  
filmoseals

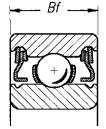
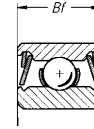
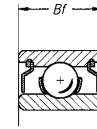
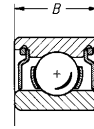
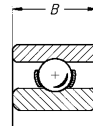

## Metric series

Actual sizes	d [mm]	D [mm]	B [mm]	Bf [mm]	Reference open bearings		Reference shielded bearings	
	1	3	1		UL 103	UL 103X		
	1.5	4	1.2	2	UL 154	UL 154X		ULZ 154X
	1.5	5	2	2	R 1550	R 1550X	RX/RF 155	RX/RF 155X
	2	4	1.2			UL 204X		
	2	5	1.5	2.3	UL 205	UL 205X		ULZ 205X
	2	6	2.3	2.3	R 2060	R 2060X	RX/RF 206	RX/RF 206X
	2.5	5	1.5			UL 255X		
	2.5	6	1.8	2.6	UL 256	UL 256X		ULZ 256X
	2.5	7	2.5			R 2570X		RV 257X
	2.5	8	2.8	2.8	R 2580	R 2580X	RF 258	RF 258X
	3	6	2	2.5		UL 306X		ULZ 306X
	3	6	2					ULV 306X
	3	7	2	3	UL 307	UL 307X		ULZ 307X
	3	8	3	4		R 3080X		RF 308X
	3	8	3				RV 308	RV 308X
	3	10	4	4	R 3100	R 3100X	RX/RF 310	RX/RF 310X
	4	7	2	2.5		UL 407X		ULZ 407X
	4	7	2					ULV407X
	4	9	2.5	4	UL 409	UL 409X		ULZ 409X
	4	10		4				RX/RF 410X
	4	11	4			R 4110X	RV 411	RV 411X
	4	13	5	5	R 4130	R 4130X	RX/RF 413	RX/RF 413X
	4	16	5			R 4160X		RV416X
	5	8	2	3		UL 508X		ULZ 508X
	5	8	2					ULV 508X

Chrome steel

Stainless steel



## Radial single row ball bearings

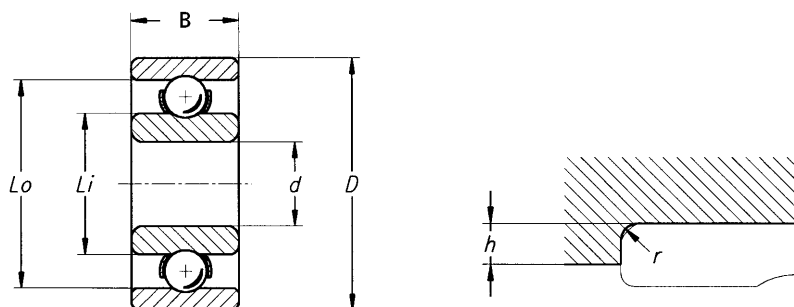

### Metric series

B DIN Reference	Bf DIN Reference	Li [mm]	Lo [mm]	r max. [mm]	h min. [mm]	Balls n x Ø [mm]	load ratings	
							dynamic C [N]	static Co [N]
618/1	-	1.60	2.40	0.08	0.3	7 x 0.500	29	9
618/1.5	638/1.5	2.12	3.38	0.1	0.3	6 x 0.794	67	21
619/1.5	619/1.5	2.68	3.97	0.15	0.4	7 x 0.794	77	26
617/2	-	2.48	3.55	0.05	0.25	7 x 0.700	65	21
618/2	638/2	2.86	4.14	0.1	0.4	7 x 0.794	78	26
619/2	619/2	3.16	4.75	0.15	0.5	7 x 1.000	127	45
617/2.5	-	3.15	4.40	0.08	0.3	8 x 0.794	85	30
618/2.5	638/2.5	3.54	5.02	0.15	0.5	7 x 1.000	128	46
619/2.5	-	3.95	5.53	0.15	0.6	8 x 1.000	142	53
60/2.5	60/2.5	4.22	6.23	0.15	0.6	7 x 1.250	199	75
617/3	-	3.75	5.26	0.08	0.35	8 x 1.000	141	53
617/3	-	3.75	5.26	0.08	0.35	8 x 1.000	141	53
618/3	638/3	4.14	5.85	0.15	0.5	8 x 1.150	190	74
619/3	639/3	4.40	6.61	0.15	0.6	7 x 1.450	258	100
619/3	-	4.40	6.61	0.15	0.6	7 x 1.450	258	100
623	623	5.33	7.87	0.15	0.7	7 x 1.588	314	124
617/4	-	4.75	6.25	0.08	0.35	9 x 1.000	154	61
617/4	-	4.75	6.25	0.08	0.35	9 x 1.000	154	61
618/4	638/4	5.33	7.87	0.15	0.5	7 x 1.588	314	124
-	-	5.33	7.87	0.15	0.7	7 x 1.588	314	124
619/4	-	5.90	9.10	0.15	0.7	6 x 2.100	514	211
624	624	6.65	10.35	0.2	0.8	6 x 2.381	709	311
634	-	8.00	13.08	0.3	1	6 x 3.175	918	400
617/5	637/5	5.75	7.25	0.08	0.4	11 x 1.000	174	76
617/5	-	5.75	7.25	0.08	0.4	11 x 1.000	174	76

# Radial single row ball bearings



R/UL  
open

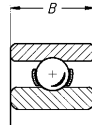

RV/ULV/ULZT  
with shields

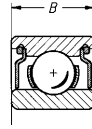

ULZ  
with shields

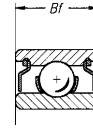

RX  
with shields

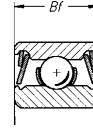

RF  
with filmoseals

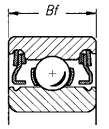

## Metric series

Actual sizes	d [mm]	D [mm]	B [mm]	Bf [mm]	Reference open bearings		Reference shielded bearings	
	5	11	3	5	UL 511	UL 511X	ULZ 511	ULZ 511X
	5	11	4				ULZT 511	
	5	13	4			R 5130X		RV 513X
	5	16	5			R 5160X		RV 516X
	5	16		6			RX/RF 516	
	5	19	6			R 5190X		RV 519X
	6	10	2.5	3		UL 610X		ULZ 610X
	6	13	3.5	5	UL 613	UL 613X		ULZ 613X
	6	15	5			R 6150X		RV 615X
	6	19	6		R 6190	R 6190X		RV 619X
	6	19		8			RX/RF 619	
	7	11	2.5	3		UL 711X	ULZ 711	ULZ 711X
	7	14	3.5	5	UL 714	UL 714X	ULZ 714	ULZ 714X
	7	19	6			R 7190X		RV 719X
	7	22	7			R 7220X		RV 722X
	8	12	2.5			UL 812X		
	8	16	4		UL 816	UL 816X		
	8	16	5					ULZT 816X
	8	16		6			ULZ 816	ULZ 816X
	8	22	7		R 8220	R 8220X	RV 822	RV 822X
	8	22		8			RX/RF 822	
	9	14	3			UL 914X		
	9	17	4	6	UL 917	UL 917X		ULZ 917X
	10	15	3			UL 1015X		
	10	19	5		UL 1019	UL 1019X	ULV 1019	ULV 1019X
	10	19		7				ULZ 1019X
	10	22	6		R 10220		RV 1022	

Chrome steel

Stainless steel



## Radial single row ball bearings

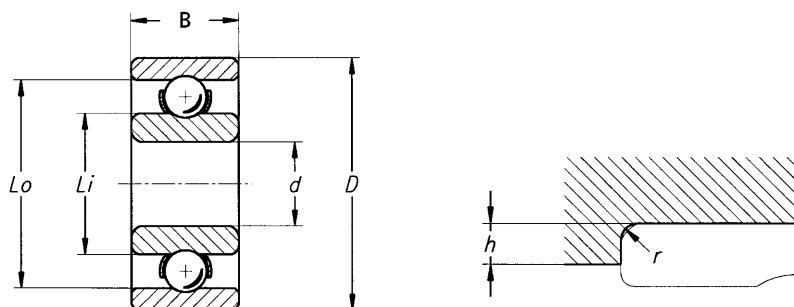

### Metric series

B DIN Reference	Bf DIN Reference	Li [mm]	Lo [mm]	r max. [mm]	h min. [mm]	Balls n x Ø [mm]	load ratings	
							dynamic C [N]	static Co [N]
618/5	638/5	6.69	9.32	0.15	0.7	8 x 1.750	403	170
628/5	-	6.69	9.32	0.15	0.7	8 x 1.750	403	170
619/5	-	7.40	11.00	0.15	0.7	7 x 2.381	628	268
625	-	8.00	13.08	0.3	1	6 x 3.175	918	400
-	-	8.00	13.08	0.3	1	6 x 3.175	918	400
635	-	9.75	14.84	0.3	1	7 x 3.175	1061	481
617/6	-	7.00	9.00	0.1	0.45	10 x 1.250	254	112
618/6	628/6	7.90	11.11	0.15	0.7	8 x 2.100	560	244
619/6	-	8.79	12.24	0.15	0.8	7 x 2.500	791	351
626	-	9.75	14.84	0.3	1	7 x 3.175	1061	481
-	-	9.75	14.84	0.3	1	7 x 3.175	1061	481
617/7	-	8.00	10.00	0.1	0.45	12 x 1.250	283	136
618/7	628/7	8.90	12.11	0.15	0.7	8 x 2.100	563	248
607	-	9.75	14.84	0.3	1	7 x 3.175	1061	481
627	-	11.75	18.05	0.3	1	7 x 3.969	1660	797
617/8	-	9.00	11.00	0.1	0.5	13 x 1.250	294	149
618/8	-	10.20	13.81	0.2	0.8	9 x 2.381	764	359
-	-	10.20	13.81	0.2	0.8	9 x 2.381	764	359
-	638/8	10.20	13.81	0.2	0.8	9 x 2.381	764	359
608	-	11.75	18.05	0.3	1	7 x 3.969	1660	797
-	-	11.75	18.05	0.3	1	7 x 3.969	1660	797
617/9	-	10.23	12.77	0.1	0.6	12 x 1.588	448	227
618/9	638/9	11.20	14.81	0.2	0.8	10 x 2.381	820	403
61700	-	11.23	13.77	0.1	0.6	13 x 1.588	467	248
61800	-	12.32	16.68	0.3	1	9 x 2.778	1013	493
-	63800	12.32	16.68	0.3	1	9 x 2.778	1013	493
61900	-	13.76	18.84	0.3	1	9 x 3.175	1291	644

# Radial single row ball bearings

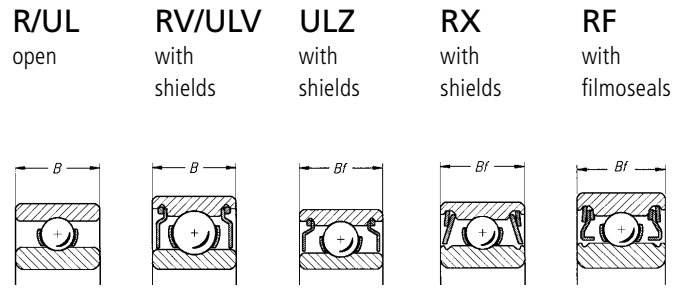

## Inch series

Actual sizes	d [mm] [inch]	D [mm] [inch]	B [mm] [inch]	Bf [mm] [inch]	Reference open bearings	Reference shielded bearings
	1.016 .0400	3.175 .1250	1.191 .0469			UL 1304X
	1.191 .0469	3.969 .1563	1.588 .0625	2.381 .0938		ULZ 1505X
	1.397 .0550	4.763 .1875	1.984 .0781	2.778 .1094		RX/RF 1706X
	1.984 .0781	6.350 .2500	2.381 .0938	3.572 .1406		RX/RF 2508X
	2.381 .0937	4.763 .1875	1.588 .0625	2.381 .0938		ULZ 3006X
	2.381 .0937	7.938 .3125	2.778 .1094	3.572 .1406		RX/RF 3010X
	3.175 .1250	6.350 .2500	2.381 .0938			ULV 4008X
	3.175 .1250	6.350 .2500		2.778 .1094		ULZ 4008X
	3.175 .1250	7.938 .3125	2.778 .1094	3.572 .1406		RX/RF 4010X
	3.175 .1250	9.525 .3750	3.969 .1563	3.969 .1563	R 4012	RX/RF 4012X

Chrome steel

Stainless steel

## Radial single row ball bearings

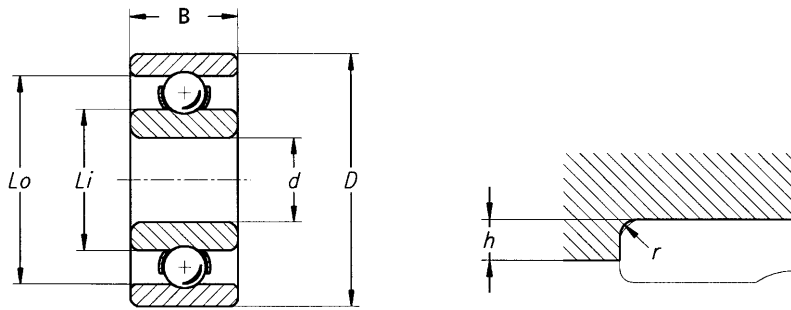

### Inch series

US reference	Li [mm] [inch]	Lo [mm] [inch]	r max. [mm] [inch]	h min. [mm] [inch]	Balls n x Ø [mm] [inch]	load ratings	
						dynamic C [N]	static Co [N]
R 09	1.60 .0630	2.40 .0945	0.08 .003	0.3 .012	7 x 0.500 .0197	29	9
R 0	1.93 .0760	3.18 .1252	0.13 .005	0.4 .016	6 x 0.794 .03125	65	21
R 1	2.35 .0925	3.83 .1508	0.13 .005	0.4 .016	6 x 1.000 .0394	107	37
R 1-4	3.16 .1244	4.75 .1870	0.13 .005	0.5 .020	7 x 1.000 .0394	127	45
R 133	2.86 .1126	4.14 .1630	0.13 .005	0.4 .016	7 x 0.794 .03125	78	26
R 1-5	4.13 .1626	6.67 .2626	0.13 .005	0.5 .020	6 x 1.588 .0625	271	103
R 144	3.95 .1555	5.53 .2177	0.13 .005	0.5 .020	8 x 1.000 .0394	142	53
R 144	3.95 .1555	5.53 .2177	0.13 .005	0.5 .020	8 x 1.000 .0394	142	53
R 2-5	4.13 .1626	6.67 .2626	0.13 .005	0.5 .020	6 x 1.588 .0625	271	103
R 2	5.33 .2098	7.87 .3098	0.13 .005	0.7 .028	7 x 1.588 .0625	314	124

# Radial single row ball bearings

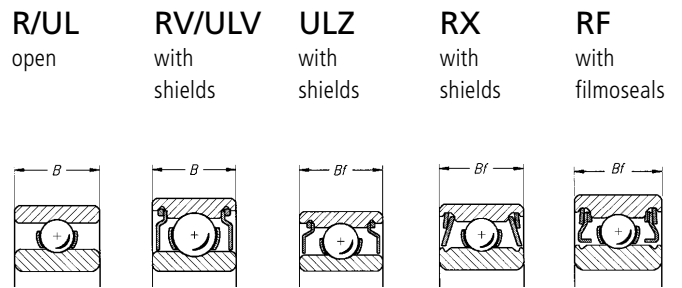

## Inch series

Actual sizes	d [mm] [inch]	D [mm] [inch]	B [mm] [inch]	Bf [mm] [inch]	Reference open bearings	Reference shielded bearings
	3.969 .1563	7.938 .3125	2.778 .1094	3.175 .1250		UL 5010X ULZ 5010X
	4.763 .1875	7.938 .3125	2.778 .1094	3.175 .1250		UL 6010X ULZ 6010X
	4.763 .1875	9.525 .3750	3.175 .1250	3.175 .1250		UL 6012X ULZ 6012X
	4.763 .1875	12.700 .5000	3.969 .1563		R 6016	R 6016X RV 6016X
	4.763 .1875	12.700 .5000		4.978 .1960		RX/RF 6016 RX/RF 6016X
	6.350 .2500	9.525 .3750	3.175 .1250	3.175 .1250		UL 8012X ULZ 8012X
	6.350 .2500	12.700 .5000	3.175 .1250	4.763 .1875		UL 8016X ULZ 8016X
	6.350 .2500	15.875 .6250	4.978 .1960	4.978 .1960	R 8020	R 8020X RX/RF 8020 RX/RF 8020X
	7.938 .3125	12.700 .5000	3.969 .1563	3.969 .1563		UL 10016X ULZ 10016X
	9.525 .3750	22.225 .8750	7.144 .2813	7.144 .2813		R 12028X RZ 12028X
	12.700 .5000	19.050 .7500		4.978 .1960		ULZ 16024X

Chrome steel

Stainless steel

## Radial single row ball bearings

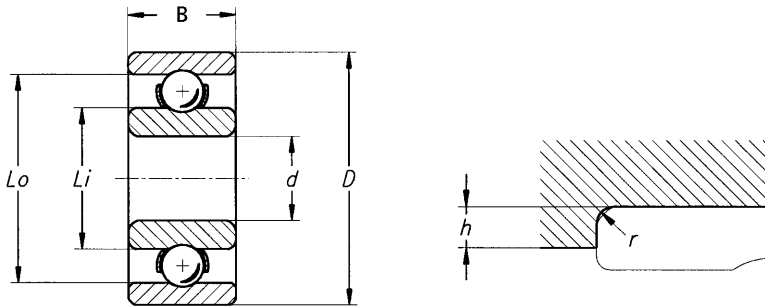

### Inch series

US reference	Li [mm] [inch]	Lo [mm] [inch]	r max. [mm] [inch]	h min. [mm] [inch]	Balls n x Ø [mm] [inch]	load ratings	
						dynamic C [N]	static Co [N]
R 155	4.98 .1961	6.82 .2685	0.13 .005	0.5 .020	8 x 1.150 .0453	192	75
R 156	5.57 .2193	7.10 .2795	0.13 .005	0.5 .020	9 x 1.000 .0394	153	62
R 166	5.95 .2343	8.35 .3287	0.13 .005	0.6 .024	8 x 1.588 .0625	347	144
R 3	7.00 .2756	10.70 .4213	0.30 .012	0.8 .031	7 x 2.381 .09375	792	351
R 3	7.00 .2756	10.70 .4213	0.30 .012	0.8 .031	7 x 2.381 .09375	792	351
R 168	7.22 .2843	8.77 .3453	0.13 .005	0.6 .024	11 x 1.000 .0394	170	77
R 188	7.90 .3110	11.11 .4374	0.13 .005	0.6 .024	8 x 2.100 .0827	560	244
R 4	9.26 .3646	12.96 .5102	0.30 .012	0.8 .031	8 x 2.381 .09375	882	393
R 1810	9.23 .3634	11.40 .4488	0.13 .005	0.6 .024	11 x 1.588 .0625	428	206
R 6	13.21 .5201	18.87 .7429	0.40 .016	0.8 .031	7 x 3.969 .1562	1681	805
-	14.90 .5866	17.10 .6732	0.20 .008	0.8 .031	14 x 1.588 .0625	469	271

# Radial single row ball bearings with modified outer ring dimension



**MV**  
with  
shields

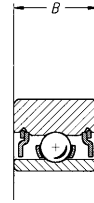

**MVT**  
with  
shields

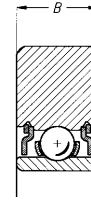

**MF**  
with  
filloseals

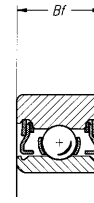

**MX/MZ**  
with  
shields

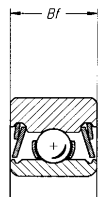

## Inch series

Actual sizes	d [mm] [inch]	D [mm] [inch]	B [mm] [inch]	Bf [mm] [inch]	Reference shielded bearings	Reference shielded bearings	
	3.175 .1250	7.938 .3125	2.778 .1094		MV 40100X		
	3.175 .1250	9.525 .3750		3.572 .1406		MF 40120X	MX 40120X
	3.175 .1250	10.414 .4100	2.381 .0938			MVT 40131X	
	3.175 .1250	10.414 .4100	2.778 .1094		MV 40131X		
	3.175 .1250	10.795 .4250	2.778 .1094		MV 40136X		
	3.175 .1250	12.70 .5000		4.366 .1719			MX 40160X
	4.763 .1875	9.525 .3750	2.778 .1094		MV 60120X		
	4.763 .1875	10.414 .4100	2.778 .1094		MV 60131X		
	4.763 .1875	12.70 .5000	2.778 .1094	3.969 .1563	MV 60160X		MZ 60160X

Stainless steel



## Radial single row ball bearings with modified outer ring dimension

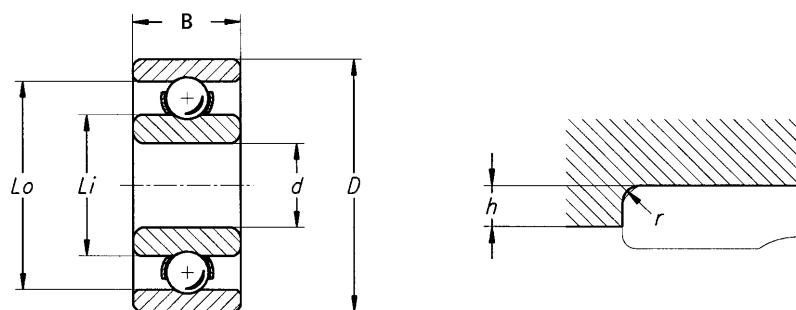

### Inch series

Li [mm] [inch]	Lo [mm] [inch]	r max. [mm] [inch]	h min. [mm] [inch]	Balls n x Ø [mm] [inch]	dynamic C [N]	load ratings static Co [N]
3.95 .1555	5.53 .2177	0.10 .004	0.40 .016	8 x 1.000 .0394	142	53
4.13 .1626	6.67 .2626	0.13 .005	0.50 .020	6 x 1.588 .0625	270	103
3.95 .1555	5.53 .2177	0.13 .005	0.50 .020	8 x 1.000 .0394	142	53
5.57 .2193	7.10 .2795	0.20 .008	0.70 .028	9 x 1.000 .0394	152	62
5.57 .2193	7.10 .2795	0.20 .008	0.70 .028	9 x 1.000 .0394	152	62
5.33 .2098	7.87 .3098	0.20 .008	0.70 .028	7 x 1.588 .0625	314	124
5.57 .2193	7.10 .2795	0.10 .004	0.60 .024	9 x 1.000 .0394	152	62
5.57 .2193	7.10 .2795	0.20 .008	0.70 .028	9 x 1.000 .0394	152	62
5.95 .2343	8.35 .3287	0.13 .005	0.60 .024	8 x 1.588 .0625	346	144

# Standard and flanged radial single row ball bearings with extended inner ring



**RU/ULU**  
open

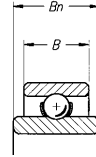

**RKU/ULKU**  
open

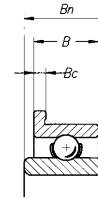

**ULUZ**  
with shields

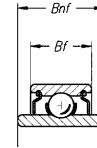

**ULKUZ**  
with shields

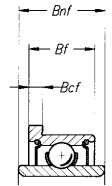

## Inch series

Actual sizes	d [mm] [inch]	D [mm] [inch]	B [mm] [inch]	Bf [mm] [inch]	Reference open bearings	Reference shielded bearings		
	1.191 .0469	3.969 .1563	1.588 .0625		ULU 1505X ULKU 1505X			
	1.397 .0550	4.763 .1875	1.984 .0781		RU 1706X RKU 1706X			
	2.381 .0938	4.763 .1875	1.588 .0625		ULU 3006X ULKU 3006X			
	2.381 .0938	7.938 .3125	2.778 .1094		RU 3010X RKU 3010X			
	3.175 .1250	6.350 .2500	2.381 .0938	2.778 .1094	ULU 4008X ULKU 4008X	ULUZ 4008X	ULKUZ 4008X	
	3.175 .1250	7.938 .3125	2.778 .1094		RU 4010X RKU 4010X			
	3.969 .1563	7.938 .3125		3.175 .1250		ULUZ 5010X	ULKUZ 5010X	
	4.763 .1875	7.938 .3125		3.175 .1250		ULUZ 6010X	ULKUZ 6010X	
	4.763 .1875	9.525 .3750	3.175 .1250	3.175 .1250	ULU 6012X ULKU 6012X	ULUZ 6012X	ULKUZ 6012X	
	6.350 .2500	9.525 .3750	3.175 .1250	3.175 .1250	ULU 8012X ULKU 8012X	ULUZ 8012X	ULKUZ 8012X	
	6.350 .2500	12.700 .5000		4.763 .1875		ULUZ 8016X	ULKUZ 8016X	

Stainless steel

## Standard and flanged radial single row ball bearings with extended inner ring

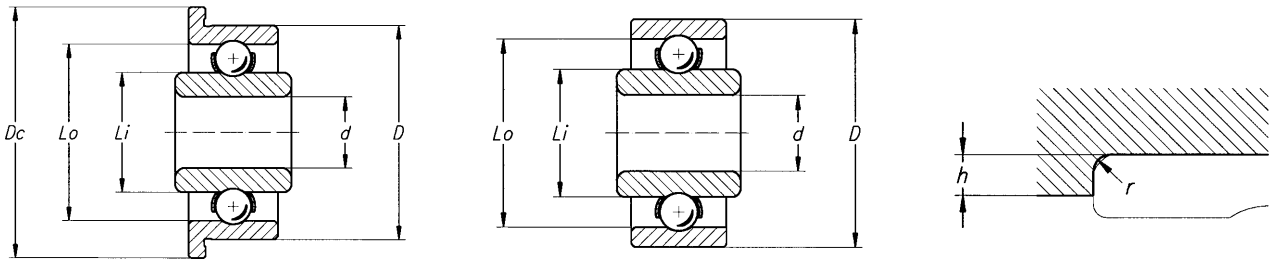

### Inch series

Bn [mm] [inch]	Dc <sup>1</sup> [mm] [inch]	Bc <sup>2</sup> [mm] [inch]	Bcf <sup>2</sup> [mm] [inch]	Bnf [mm] [inch]	Li [mm] [inch]	Lo [mm] [inch]	r max [mm] [inch]	h min [mm] [inch]	Balls n x Ø [mm] [inch]	load ratings dynamic C [N]	static Co [N]
2.381 .0938	5.156 .2030	0.330 .0130			1.93 .0760	3.18 .1252	0.13 .005	0.4 .016	6 x 0.794 .03125	65	21
2.778 .1094	5.944 .2340	0.584 0.230			2.35 .0925	3.83 .1508	0.13 .005	0.4 .016	6 x 1.000 .0394	107	37
2.381 .0938	5.944 .2340	0.457 .0180			2.86 .1126	4.14 .1630	0.13 .005	0.4 .016	7 x 0.794 .03125	78	26
3.572 .1406	9.119 .3590	0.584 .0230			4.13 .1626	6.67 .2626	0.13 .005	0.5 .020	6 x 1.588 .0625	271	103
3.175 .1250	7.518 .2960	0.584 .0230	0.787 .0310	3.572 .1406	3.95 .1555	5.53 .2177	0.13 .005	0.5 .020	8 x 1.000 .0394	142	53
3.572 .1406	9.119 .3590	0.584 .0230			4.13 .1626	6.67 .2626	0.13 .005	0.5 .020	6 x 1.588 .0625	271	103
	9.119 .3590		0.914 .0360	3.969 .1563	4.98 .1961	6.82 .2685	0.13 .005	0.5 .020	8 x 1.150 .0453	192	75
	9.119 .3590		0.914 .0360	3.969 .1563	5.57 .2193	7.10 .2795	0.13 .005	0.5 .020	9 x 1.000 .0394	153	62
3.969 .1563	10.719 .4220	0.584 .0230	0.787 .0310	3.969 .1563	5.95 .2343	8.35 .3287	0.13 .005	0.6 .024	8 x 1.588 .0625	347	144
3.969 .1563	10.719 .4220	0.584 .0230	0.914 .0360	3.969 .1563	7.22 .2843	8.77 .3453	0.13 .005	0.6 .024	11 x 1.000 .0394	170	77
	13.894 .5470		1.143 .0450	5.556 .2187	7.90 .3110	11.11 .4374	0.13 .005	0.6 .024	8 x 2.100 .0827	560	244

<sup>1</sup> Tolerance for Dc: 0 0  
-125 µm -0.005"

<sup>2</sup> Tolerance for Bc and Bcf: 0 0  
-50 µm -0.002"

# flanged radial single row ball bearings



**RK**  
open

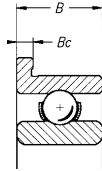

**ULK/ULKW**  
open

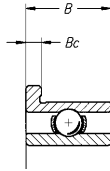

**RKV**  
with  
shields

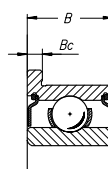

**ULKZ**  
with  
shields

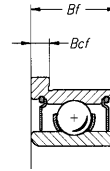

**RKX**  
with  
shields

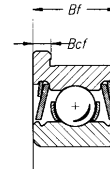

**RKF**  
with  
filmoseals

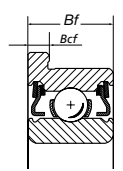

## Metric series

Actual sizes	d [mm]	D [mm]	B [mm]	Bf [mm]	Reference open bearings	Reference shielded bearings
	1.5	4	1.2	2	ULK 154X	ULKZ 154X
	2	5	1.5	2.3	ULK 205X	ULKZ 205X
	2	6	2.3	2.3	RK 2060X	RKX/RKF 206X
	2.5	6	1.8	2.6	ULK 256X	ULKZ 256X
	2.5	8	2.8	2.8	RK 2580X	RKF 258X
	3	7	2	3	ULK 307X	ULKZ 307X
	3	8	3	4	RK 3080X	RKF 308X
	3	10	4	4	RK 3100X	RKX/RKF 310X
	4	9	2.5	4	ULK 409X	ULKZ 409X
	4	10	-	4		RKX/RKF 410X
	5	11	3	5	ULK 511X	ULKZ 511X
	5	13	4	-	RK 5130X	RKV 513X
	6	13	3.5	5	ULKW 613X	ULKZ 613X
	6	13	3.5	-	ULK 613X	
	7	14	3.5	5	ULK 714X	ULKZ 714X
	8	16	4	6	ULK 816X	ULKZ 816X
	9	17	-	6		ULKZ 917X
	10	19	5	7	ULK 1019X	ULKZ 1019X

Stainless steel

## flanged radial single row ball bearings

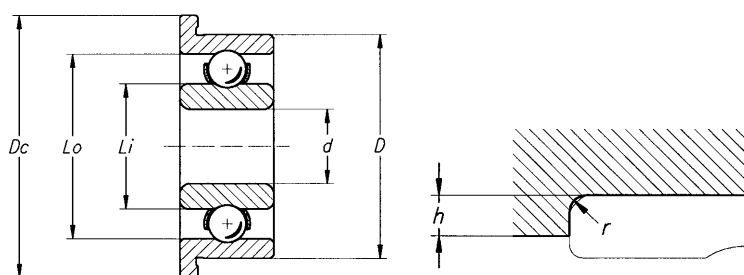

### Metric series

B DIN Reference	Bf DIN Reference	Dc <sup>1</sup> [mm]	Bc <sup>2</sup> [mm]	Bcf <sup>2</sup> [mm]	Li [mm]	Lo [mm]	r max. [mm]	h min [mm]	Balls n x Ø [mm] [inch]	load ratings dynamic C [N]	static Co [N]
618/1.5R	638/1.5R	5	0.4	0.6	2.12	3.38	0.1	0.4	6 x 0.794	67	21
618/2R	638/2R	6.1	0.5	0.6	2.86	4.14	0.1	0.4	7 x 0.794	78	26
619/2R	619/2R	7.5	0.6	0.6	3.16	4.75	0.2	0.5	7 x 1.000	127	45
618/2.5R	638/2.5R	7.1	0.5	0.8	3.54	5.02	0.1	0.5	7 x 1.000	128	46
60/2.5R	60/2.5R	9.5	0.7	0.7	4.22	6.23	0.2	0.6	7 x 1.250	199	75
618/3R	638/3R	8.1	0.5	0.8	4.14	5.85	0.1	0.5	8 x 1.150	190	74
619/3R	639/3R	9.5	0.7	0.9	4.40	6.61	0.2	0.6	7 x 1.450	258	100
623R	623R	11.5	1	1	5.33	7.87	0.2	0.7	7 x 1.588	314	124
618/4R	638/4R	10.3	0.6	1	5.33	7.87	0.1	0.5	7 x 1.588	314	124
-	-	11.5	-	1	5.33	7.87	0.2	0.7	7 x 1.588	314	124
618/5R	638/5R	12.5	0.8	1	6.69	9.32	0.2	0.7	8 x 1.750	403	170
619/5R	619/5R	15	1	-	7.40	11.00	0.2	0.7	7 x 2.381	628	268
618/6R	628/6R	15	1	1.1	7.90	11.11	0.2	0.7	8 x 2.100	560	244
-	-	14.5	0.7	-	7.90	11.11	0.2	0.7	8 x 2.100	560	244
618/7R	628/7R	16	1	1.1	8.90	12.11	0.2	0.7	8 x 2.100	563	248
618/8R	638/8R	18	1	1.3	10.20	13.81	0.2	0.8	9 x 2.381	764	359
-	638/9R	19	-	1.3	11.20	14.81	0.2	0.8	10 x 2.381	820	403
61800R	63800R	21	1	1.5	12.32	16.68	0.3	1	9 x 2.778	1013	493

<sup>1</sup> Tolerance for Dc: 0  
-125 µm

<sup>2</sup> Tolerance for Bc and Bcf: 0  
-50 µm

flanged radial single row ball bearings

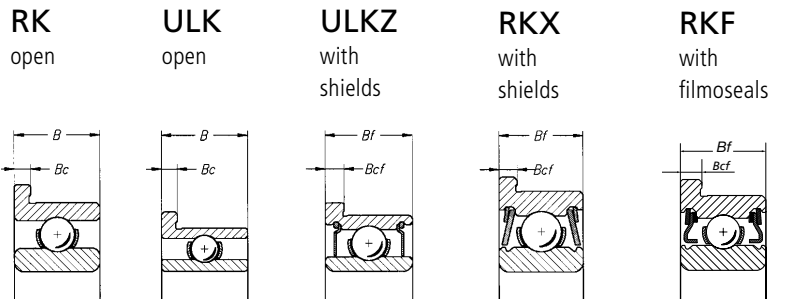

Inch series

Actual sizes	d [mm] [inch]	D [mm] [inch]	B [mm] [inch]	Bf [mm] [inch]	Reference open bearings	Reference shielded bearings
	1.016 .0400	3.175 .1250	1.191 .0469		ULK 1304X	
	1.191 .0469	3.969 .1563	1.588 .0625	2.381 .0938	ULK 1505X	ULKZ 1505X
	1.397 .0550	4.763 .1875	1.984 .0781	2.778 .1094	RK 1706X	RKX/RKF 1706X
	1.984 .0781	6.350 .2500	2.381 .0938	3.572 .1406	RK 2508X	RKX/RKF 2508X
	2.381 .0938	4.763 .1875	1.588 .0625	2.381 .0938	ULK 3006X	ULKZ 3006X
	2.381 .0938	7.938 .3125	2.778 .1094	3.572 .1406	RK 3010X	RKX/RKF 3010X
	3.175 .1250	6.350 .2500	2.381 .0938	2.778 .1094	ULK 4008X	ULKZ 4008X
	3.175 .1250	7.938 .3125	2.778 .1094	3.572 .1406	RK 4010X	RKX/RKF 4010X
	3.175 .1250	9.525 .3750	3.969 .1563	3.969 .1563	RK 4012X	RKX/RKF 4012X

Stainless steel

## flanged radial single row ball bearings

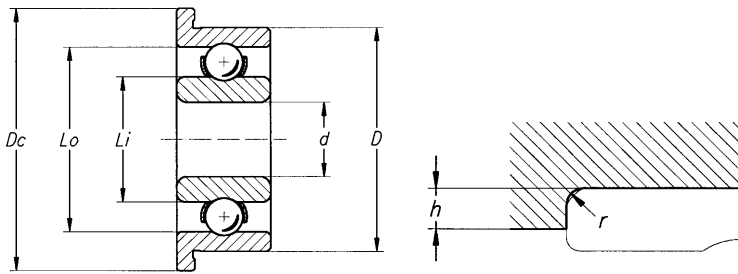

### Inch series

US reference	Dc <sup>1</sup> [mm] [inch]	Bc <sup>2</sup> [mm] [inch]	Bcf <sup>2</sup> [mm] [inch]	Li [mm] [inch]	Lo [mm] [inch]	r max. [mm] [inch]	h min [mm] [inch]	Balls n x Ø [mm] [inch]	Load ratings dynamic C [N]	static Co [N]
FR 09	4.343 .1710	0.330 .0130		1.60 .0630	2.40 .0945	0.10 .004	0.3 .012	7 x 0.500 .0197	29	9
FR 0	5.156 .2030	0.330 .0130	0.787 0.310	1.93 .0760	3.18 .1252	0.13 .005	0.4 .016	6 x 0.794 .03125	65	21
FR 1	5.944 .2340	0.584 .0230	0.787 .0310	2.35 .0925	3.83 .1508	0.13 .005	0.4 .016	6 x 1.000 .0394	107	37
FR 1-4	7.518 .2960	0.584 .0230	0.787 .0310	3.16 .1244	4.75 .1870	0.13 .005	0.5 .020	7 x 1.000 .0394	127	45
FR 133	5.944 .2340	0.457 .0180	0.787 .0310	2.86 .1126	4.14 .1630	0.13 .005	0.4 0.16	7 x 0.794 .03125	78	26
FR 1-5	9.119 .3590	0.584 .0230	0.787 .0310	4.13 .1626	6.67 .2626	0.13 .005	0.5 .020	6 x 1.588 .0625	271	103
FR 144	7.518 .2960	0.584 .0230	0.787 .0310	3.95 .1555	5.53 .2177	0.13 .005	0.5 .020	8 x 1.000 .0394	142	53
FR 2-5	9.119 .3590	0.584 .0230	0.787 .0310	4.13 .1626	6.67 .2626	0.13 .005	0.5 .020	6 x 1.588 .0625	271	103
FR 2	11.176 .4400	0.762 .0300	0.762 .0300	5.33 .2098	7.87 .3098	0.30 .012	0.7 .028	7 x 1.588 .0625	314	124

<sup>1</sup> Tolerance for Dc:            0            0  
   -125 µm   -0.005"

<sup>2</sup> Tolerance for Bc and Bcf:    0            0  
   -50 µm    -0.002"

flanged radial single row ball bearings

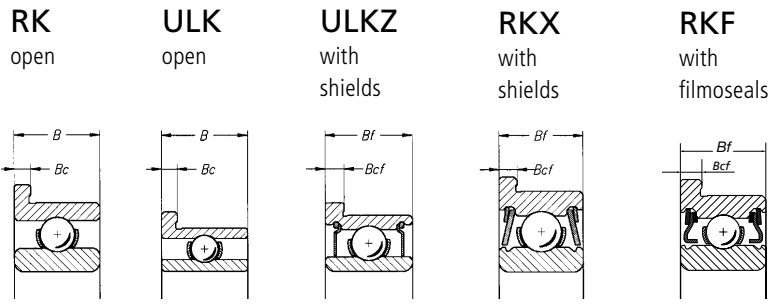

Inch series

Actual sizes	d [mm] [inch]	D [mm] [inch]	B [mm] [inch]	Bf [mm] [inch]	Reference open bearings	Reference shielded bearings
	3.969 .1563	7.938 .3125	2.778 .1094	3.175 .1250	ULK 5010X	ULKZ 5010X
	4.763 .1875	7.938 .3125	2.778 .1094	3.175 .1250	ULK 6010X	ULKZ 6010X
	4.763 .1875	9.525 .3750	3.175 .1250	3.175 .1250	ULK 6012X	ULKZ 6012X
	4.763 .1875	12.700 .5000	4.978 .1960	4.978 .1960	RK 6016X	RKX/RKF 6016X
	4.763 .1875	12.700 .5000	3.969 .1563		RKT 6016X	
	6.35 .2500	9.525 .3750	3.175 .1250	3.175 .1250	ULK 8012X	ULKZ 8012X
	6.35 .2500	12.700 .5000	3.175 .1250	4.763 .1875	ULK 8016X	ULKZ 8016X
	6.35 .2500	15.875 .6250	4.978 .1960	4.978 .1960	RK 8020X	RKX/RKF 8020X
	7.938 .3125	12.700 .5000	3.969 .1563	3.969 .1563	ULK 10016X	ULKZ 10016X
	9.525 .3750	22.225 .8750	7.144 .2813	7.144 .2813	RK 12028X	RKZ 12028X

Stainless steel



## flanged radial single row ball bearings

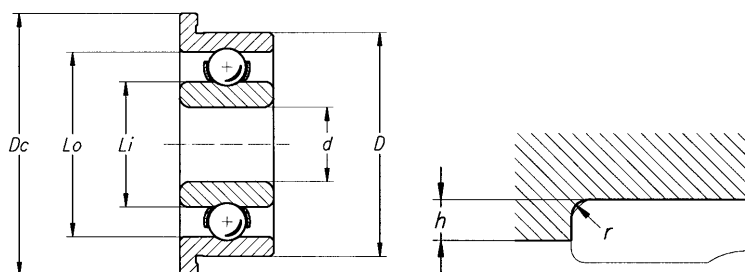

### Inch series

US reference	Dc <sup>1</sup> [mm] [inch]	Bc <sup>2</sup> [mm] [inch]	Bcf <sup>2</sup> [mm] [inch]	Li [mm] [inch]	Lo [mm] [inch]	r max. [mm] [inch]	h min [mm] [inch]	Balls n x Ø [mm] [inch]	Load ratings dynamic C [N]	static Co [N]
FR 155	9.119 .3590	0.584 .0230	0.914 .0360	4.98 .1961	6.82 .2685	0.13 .005	0.5 .020	8 x 1.150 .0453	192	75
FR 156	9.119 .3590	0.584 .0230	0.914 .0360	5.57 .2193	7.10 .2787	0.13 .005	0.5 .020	9 x 1.00 .0394	153	62
FR 166	10.719 .4220	0.584 .0230	0.787 .0310	5.95 .2343	8.35 .3287	0.13 .005	0.6 .024	8 x 1.588 .0625	347	144
FR 3	14.351 .5650	1.067 .0420	1.067 .0420	7.00 .2756	10.70 .4213	0.30 .012	0.8 .031	7 x 2.381 .09375	792	351
FR 3	14.351 .5650	1.067 .0420		7.00 .2756	10.70 .4213	0.30 .012	0.8 0.31	7 x 2.381 .09375	792	351
FR 168	10.719 .4220	0.584 .0230	0.914 .0360	7.22 .2843	8.77 .3453	0.13 .005	0.6 .024	11 x 1.000 .0394	170	77
FR 188	13.894 .5470	0.584 .0230	1.143 .0450	7.90 .3110	11.11 .4374	0.13 .005	0.6 .024	8 x 2.100 .0827	560	244
FR 4	17.526 .6900	1.067 .0420	1.067 .0420	9.26 .3646	12.96 .5102	0.30 .012	0.8 .031	8 x 2.381 .09375	882	393
FR 1810	13.894 .5470	0.787 .0310	0.787 .0310	9.23 .3634	11.40 .4488	0.13 .005	0.6 .024	11 x 1.588 .0625	428	206
FR 6	24.613 .9690	1.575 .0620	1.575 .0620	13.21 .5201	18.87 .7429	0.40 .016	0.8 .031	7 x 3.969 .1563	1681	805

<sup>1</sup> Tolerance for Dc: 0 0  
-125 µm -.005"

<sup>2</sup> Tolerance for Bc and Bcf: 0 0  
-50 µm -.002"





# Angular contact separable ball bearings

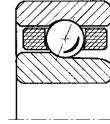

RA  
open

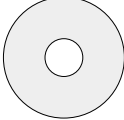
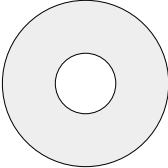

## Metric series

Actual sizes	d [mm]	D [mm]	B [mm]	Reference	Reference
	2	6	2.3	RA 2060	RA 2060X
	2.5	8	2.8	RA 2580	RA 2580X
	3	10	4	RA 3100	RA 3100X
	4	13	5	RA 4130	RA 4130X
	4	16	5	RA 4160	RA 4160X
	5	16	5	RA 5160	RA 5160X
	6	19	6	RA 6190	RA 6190X
	8	22	7	RA 8220	RA 8220X
	12	28	8	RA 12280	RA 12280X

These bearings are available:

- with solid retainer of synthetic material (page 11).
- with a contact angle of 17° to 28° (page 14).
- to the limits of quality PSP or higher (pages 12, 13).

The number of balls printed in **heavy type** indicates standard execution (page 53).

 Chrome steel

 Stainless steel

## Angular contact separable ball bearings

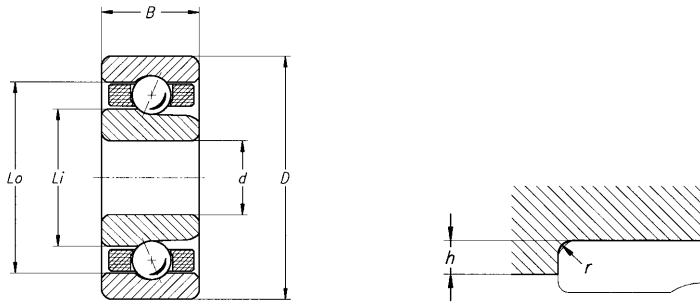

### Metric series

B DIN 616	Li [mm]	Lo [mm]	r max [mm]	h min [mm]	Balls n x Ø [mm]	Load ratings for $\alpha_o = 20^\circ$		
						dynamic C [N]	static Co [N]	axial Coa [N]
719/2	3.16	4.68	0.20	0.5	6 x 1.150	146	51	109
					7 x	162	59	128
70/2.5	3.95	6.23	0.20	0.6	6 x 1.588	260	97	153
					7 x	289	113	178
723	5.63	7.87	0.20	0.7	6 x	274	102	183
					7 x 1.588	304	119	214
					8 x	332	135	244
724	6.88	10.35	0.20	0.8	7 x 2.381	601	252	544
					8 x	657	288	622
734	7.62	12.38	0.30	1.0	6 x 3.175	882	377	812
					7 x	977	440	947
725	7.62	12.38	0.30	1.0	6 x 3.175	882	377	812
					7 x	977	440	947
726	9.92	14.68	0.30	1.0	7 x 3.175	1027	457	988
					8 x	1123	522	1129
708	11.81	17.60	0.30	1.0	7 x 3.969	1528	711	1542
					8 x	1670	813	1762
7001	16.50	21.96	0.40	1.2	8 x 3.969	1714	845	1840





# Angular contact separable ball bearings

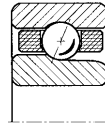

RA  
open

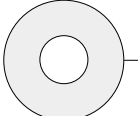

## Inch series

Actual sizes	d [mm] [inch]	D [mm] [inch]	B [mm] [inch]	Reference	Reference
	1.984 .0781	6.35 .2500	2.381 .0938	RA 2508	RA 2508X
	2.381 .0938	7.938 .3125	2.778 .1094	RA 3010	RA 3010X
	3.175 .1250	7.938 .3125	2.778 .1094	RA 4010	RA 4010X
	3.175 .1250	9.525 .3750	3.969 .1563	RA 4012	RA 4012X
	4.763 .1875	12.70 .5000	3.969 .1563	RA 6016	RA 6016X
	6.35 .2500	15.875 .6250	4.978 .1960	RA 8020	RA 8020X

These bearings are available:

- with solid retainer of synthetic material (page 11).
- with a contact angle of 17° to 28° (page 14).
- to the limits of quality PSP or higher (pages 12, 13).

The number of balls printed in **heavy type** indicates standard execution (page 55).

 Chrome steel

 Stainless steel

## Angular contact separable ball bearings

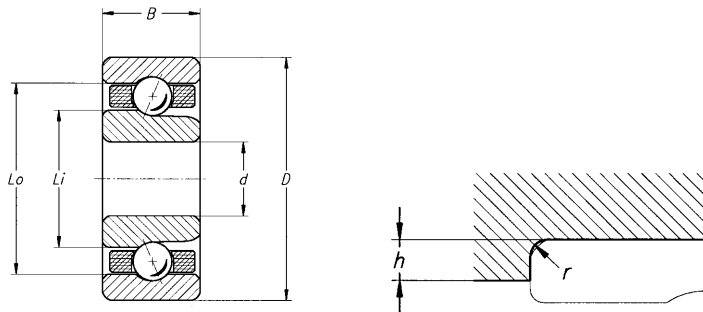

### Inch series

US reference	Li [mm] [inch]	Lo [mm] [inch]	r max [mm] [inch]	h min [mm] [inch]	Balls n x Ø [mm] [inch]	Load ratings for $\alpha_o = 20^\circ$		
						dynamic C [N]	static Co [N]	axial Coa [N]
R1-4B	3.16	4.68	0.13	0.5	6 x { 1.150	146	51	109
	.1244	.1843	.005	.020	7 x { .0453	162	59	128
R1-5B	3.95	6.23	0.13	0.5	6 x { 1.588	260	97	153
	.1555	.2453	.005	.020	7 x { .0625	289	113	178
R2-5B	4.36	6.60	0.13	0.5	6 x { 1.588	266	98	181
	.1716	.2598	.005	.020	7 x { .0625	294	115	211
R2B	5.08	7.32	0.30	0.7	6 x { 1.588	272	100	182
	.2000	.2882	.012	.028	7 x { .0625	301	117	213
R3B	6.88	10.35	0.30	0.8	7 x { 2.381	601	252	544
	.2709	.4075	.012	.031	8 x { .09375	657	288	622
-	9.48	12.96	0.30	0.8	8 x { 2.381	677	300	649
	.3732	.5102	.012	.031	9 x { .09375	732	337	730



## Flanged angular contact separable ball bearings



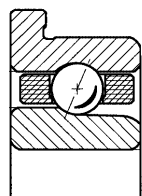

RKA  
open



### Metric series

Actual sizes	d [mm]	D [mm]	B [mm]	Reference	Dc [mm]	Bc [mm]	Li [mm]	Lo [mm]
	2	6	2.3	RKA 2060X	7.50	0.60	3.16	4.68
	2.5	8	2.8	RKA 2580X	9.50	0.70	3.95	6.23

### Inch series

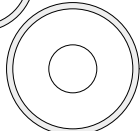
Actual sizes	d [mm] [inch]	D [mm] [inch]	B [mm] [inch]	Reference	Dc [mm] [inch]	Bc [mm] [inch]	Li [mm] [inch]	Lo [mm] [inch]
	2.381 .0938	7.938 .3125	2.778 .1094	RKA 3010X	9.12 .3590	0.58 .023	3.95 .1555	6.23 .2453
	3.175 .1250	9.525 .3750	3.969 .1563	RKA 4012X	11.18 .4401	0.75 .029	5.08 .2000	7.32 .2882
	4.763 .1875	12.70 .5000	3.969 .1563	RKA 6016X	14.35 .5649	1.06 .042	6.88 .2709	10.35 .4075
	6.35 .2500	15.875 .6250	4.978 .1960	RKA 8020X	17.53 .6830	1.05 .041	9.48 .3732	12.96 .5102

These bearings are available:

- with solid retainer of synthetic material (page 11).
- with a contact angle of 17° to 28° (page 14).
- to the limits of quality PSP or higher (pages 12, 13).

The number of balls printed in **heavy type** indicates standard execution (page 57).

 Stainless steel

## Flanged angular contact separable ball bearings

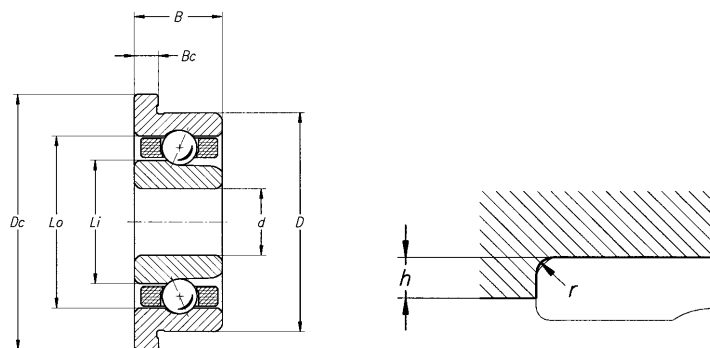

### Metric series

DIN 616	r max [mm]	h min [mm]	Balls n x Ø [mm]	dynamic C [N]	Load ratings for $\alpha_o = 20^\circ$ static Co [N]	axial Coa [N]
719/2R	0.20	0.5	6 x 1.150	146	51	109
			7 x	162	59	128
70/2.5R	0.20	0.6	6 x 1.588	260	97	153
			7 x	289	113	178

### Inch series

US reference	r max [mm] [inch]	h min [mm] [inch]	Balls n x Ø [mm] [inch]	dynamic C [N]	Load ratings for $\alpha_o = 20^\circ$ static Co [N]	axial Coa [N]
R1-5B	0.13 .005	0.5 .0200	6 x 1.588	260	97	153
			7 x .0625			
R2B	0.30 .012	0.7 .0280	6 x 1.588	272	100	182
			7 x .0625			
R3B	0.3 .012	0.8 .3100	7 x 2.381	601	252	544
			8 x .09375			
-	0.30 .012	0.8 .3100	8 x 2.381	677	300	649
			9 x .09375			

## Thrust ball bearings

B

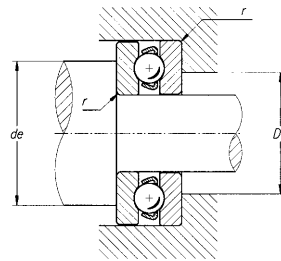
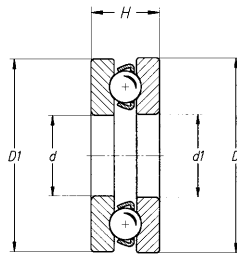

### Metric series

d [mm]	D [mm]	H [mm]	Reference	d1 [mm]	D1 [mm]	de min [mm]	De max [mm]	r max [mm]	Balls n x Ø [mm]
3	8	3.5	B 308	3.2	7.8	6	5	0.10	6 x 1.588
4	10	4	B 410	4.2	9.8	7.5	6.5	0.10	6 x 1.588
5	12	4	B 512	5.2	11.8	9	8	0.10	8 x 1.588
6	14	5	B 614	6.2	13.8	10.5	9.5	0.15	7 x 2.381
7	17	6	B 717	7.2	16.8	13	11	0.15	8 x 2.778
8	19	7	B 819	8.2	18.8	14.5	12.5	0.25	8 x 3.175
9	20	7	B 920	9.2	19.8	15.5	13.5	0.25	8 x 3.175

d [mm]	D [mm]	H [mm]	Reference	n max [rpm]	dynamic C [N]	Load ratings axial static Co [N]
3	8	3.5	B 308	15000	602	611
4	10	4	B 410	15000	602	611
5	12	4	B 512	13000	640	815
6	14	5	B 614	10000	1275	1559
7	17	6	B 717	10000	1830	2435
8	19	7	B 819	8000	2343	3191
9	20	7	B 920	8000	2393	3191

Ces roulements sont livrés dans les tolérances d'exactitude de la qualité P5P au moins

Precision	Ø d	Ø D		H	Track parallelism	
		≤17mm	≥19 mm			
P5P	0 / -8 µm	0 / -11 µm	0 / -13 µm	0 / -100 µm	3 µm	<b>Recommended tolerances:</b> shaft: +4 / -4 µm Housing: +8 / 0 µm
P4P	0 / -7 µm	0 / -11 µm	0 / -13 µm		2 µm	

Chrome steel



## Miniature precision balls Grade 3 (ISO 3290)



### Diameter

Chrome steel [mm]	[inch]	Stainless steel [mm]
0.500		0.500X
0.600		0.600X
0.650		0.650X
0.794	1/32	0.794X
1.000		1.000X
1.150		1.150X
1.191	3/64	
1.250		1.250X
		1.450X
		1.500X
1.588	1/16	1.588X
1.750		1.750X
		1.915X
		2.000X
2.100		2.100X
2.381	3/32	2.381X
		2.450X
		2.500X
	7/64	2.778X

Tolerances: ISO 3290 Grade 3

Sphericity: 0.08 µm

Diameter variation of one lot: 0.13 µm

\* On request, are available special material balls (Ceramic Si<sub>3</sub>N<sub>4</sub>, TiC coating, etc.)

Chrome steel

Stainless steel

L

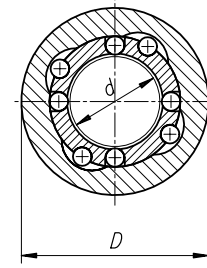
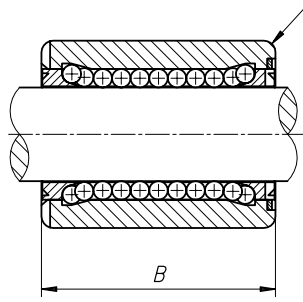

Metric series

Actual size	Reference	d [mm]	D [mm]	B [mm]	r min [mm]	Ø balls [mm]	Load ratings	
							dynamic C [N]	static Co [N]
	L 204X	2	4	5	0.02	0.500	8	10
	L 306X	3	6	7	0.13	0.600	31	30
	L 408X	4	8	10	0.24	0.794	66	61
	L 510X	5	10	14	0.24	1.250	131	132
	L 612X	6	12	18	0.39	1.588	250	245

- Standard execution with brass cage
- Special execution on request with stainless steel cage

Bearing tolerances:  
 Bore diameter: +8 / 0 µm  
 Outside diameter: 0 / -8 µm

Recommended tolerances for shaft: 0 / -6 µm  
 Max. interference fit of outer ring: 1 to 3 µm

## Miniature precision ball screws

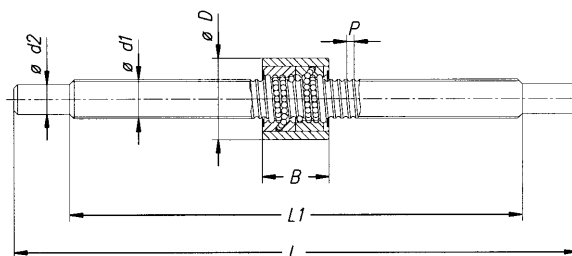
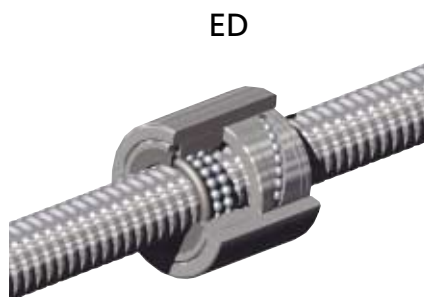

Reference	Nut		ØBalls [mm]	d1 [mm]	P [mm]	Screw			Axial load ratings	
	D [mm]	B [mm]				d2 [mm]	L [mm]	L1 [mm]	dynamic C [N]	static Co [N]
ED410X / V404X	10	10	0.794	4.25	1.0	3	70	50	439	178
ED513X / V501X	13	12	1.0	5.8	1.25	4	100	75	671	299
ED616X / V601X	16	14	1.191	7.4	1.5	6	140	110	968	471
ED822X / V801X	22	18	1.588	10.5	2.0	8	190	150	1659	879
ED1028X / V1001X	28	22	2.0	13.6	2.5	10	260	210	2544	1396

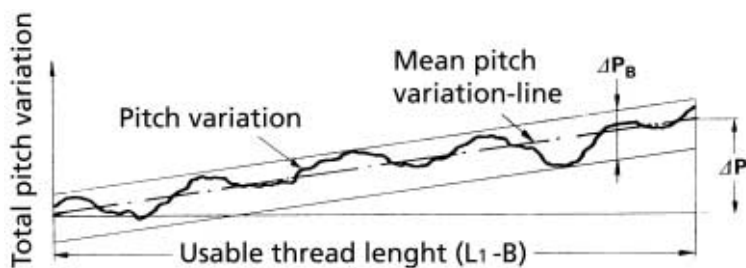

Technical data	ED 410X V404X	ED 513X V 501X	ED 616X V 601X	ED 822X V 801X	ED 1028X V1001X	Unit
Tolerance of outside diameter of nut D	0	0	0	0	0	µm
	-6	-6	-6	-9	-9	
Tolerance of the spigot diameter d2	0	0	0	0	0	µm
	-8	-8	-8	-8	-8	
Max pitch variation per 25 [mm] ΔP <sub>25</sub>	5	5	5	5	5	µm / 25 mm
Max band width ΔP <sub>B</sub>	5	5	5	5	5	µm
Max eccentricity of the nut on the screw	10	10	12	14	16	µm
Efficiency average value	80-85	80-87	80-89	81-91	83-92	%
Standard axial play	0-5	0-5	0-5	0-5	0-5	µm
Zero backlash	on request	on request	on request	on request	on request	

See reference sample on page 3

• Special executions are available on request

WSR

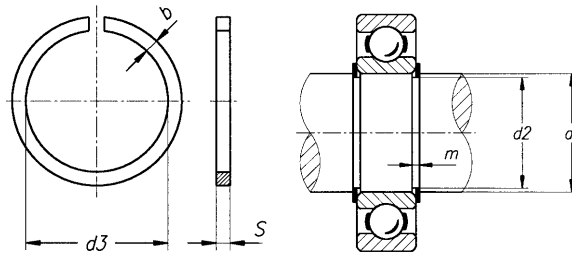

Reference	Shaft		Circlips		Grooves		Suitable for bearings with bore diameter	
	$\varnothing d1$ [mm]	$d3$ max [mm]	$b$ $\pm 0.10$ [mm]	$s$ $\pm 0.02$ [mm]	$d2$ $-0.05$ [mm]	$m$ $+0.03$ [mm]	[mm]	[inch]
WSR 3	3	2.60	0.50	0.30	2.70	0.33	3	.1250
WSR 4	4	3.60	0.50	0.30	3.70	0.33	4	.1563
WSR 5	5	4.50	0.70	0.40	4.60	0.44	5	
WSR 6	6	5.45	0.70	0.40	5.60	0.44	6	.2500
WSR 7	7	6.45	0.70	0.40	6.60	0.44	7	
WSR 8	8	7.35	0.90	0.50	7.50	0.55	8	.3125
WSR 9	9	8.30	0.90	0.50	8.50	0.55	9	
WSR 10	10	9.25	0.90	0.50	9.50	0.55	10	

BSR

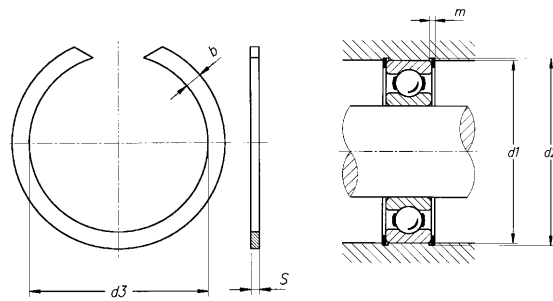

Reference	Housing Ø d1 [mm]	d3 min [mm]	Circlips		Grooves		Suitable for bearings with outside diameter	
			b ±0.10 [mm]	s ±0.02 [mm]	d2 +0.05 [mm]	m +0.03 [mm]	[mm]	[inch]
BSR 4	4	4.40	0.50	0.30	4.30	0.33	4	.1563
BSR 5	5	5.45	0.50	0.30	5.30	0.33	5	
BSR 6	6	6.45	0.50	0.30	6.30	0.33	6	
BSR 7	7	7.50	0.50	0.30	7.30	0.33	7	
BSR 8	8	8.60	0.70	0.40	8.40	0.44	8	.3125
BSR 9	9	9.60	0.70	0.40	9.40	0.44	9	
BSR 10	10	10.65	0.70	0.40	10.40	0.44	10	
BSR 11	11	11.65	0.70	0.40	11.40	0.44	11	
BSR 12	12	12.75	0.90	0.50	12.50	0.55	12	
BSR 13	13	13.75	0.90	0.50	13.50	0.55	13	
BSR 14	14	14.80	0.90	0.50	14.50	0.55	14	
BSR 15	15	15.80	0.90	0.50	15.50	0.55	15	
BSR 16	16	16.85	0.90	0.50	16.50	0.55	16	
BSR 17	17	17.85	0.90	0.50	17.50	0.55	17	
BSR 19	19	20.00	1.10	0.60	19.60	0.66	19	.7500

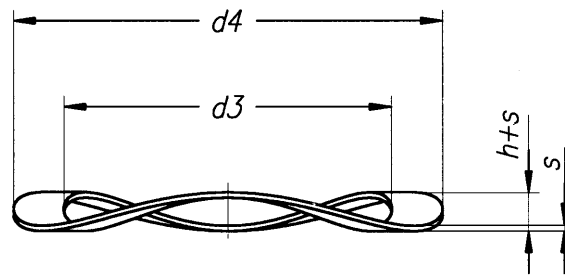

Reference	$h+s$ $\pm 0.005$ [mm]	$s^*$ $\pm 0.01$ [mm]	$d3$ [mm]	$d4$ [mm]	Suitable for bearings with			
					bore $\emptyset$ [mm]	[inch]	outer $\emptyset$ [mm]	[inch]
FS 1.5 X 3	0.40	0.08	1.60	2.90	-	-	3	-
FS 2 X 3.5	0.45	0.08	2.15	3.10	2	-	-	.1250
FS 2.5 X 4	0.50	0.08	2.70	3.80	2.5	-	4	.1563
FS 3 X 4.5	0.50	0.10	3.20	4.30	3	.1250	-	-
FS 3.5 X 5	0.55	0.10	3.70	4.80	-	-	5	-
FS 4 X 6	0.65	0.12	4.20	5.75	4	.1563	6	-
FS 4.5 X 6.35	0.60	0.12	4.80	6.10	-	.1875	-	.2500
FS 5 X 7	0.65	0.12	5.20	6.75	5	-	7	-
FS 6 X 8	0.70	0.15	6.20	7.75	6	-	8	.3125
FS 7 X 9	0.90	0.15	7.20	8.70	7	-	9	-
FS 8 X 10	0.85	0.18	8.20	9.70	8	.3125	10	-
FS 9 X 11	1.15	0.18	9.20	10.70	9	-	11	-
FS 10 X 12	1.05	0.20	10.20	11.70	10	-	12	-
FS 11 X 13	1.30	0.20	11.20	12.70	-	-	13	-
FS 12 X 14	1.30	0.22	12.20	13.70	-	-	14	-
FS 13 X 15	1.30	0.22	13.20	14.70	-	-	15	-
FS 14 X 16	1.55	0.25	14.20	15.65	-	-	16	-
FS 15 X 17	1.55	0.25	15.20	16.65	-	-	17	-
FS 16 X 19	2.15	0.30	16.20	18.55	-	-	19	.7500

\* For «s» > 0.25 mm, tolerance of «s» =  $\pm 15 \mu\text{m}$

# Precision spring washers stiffness

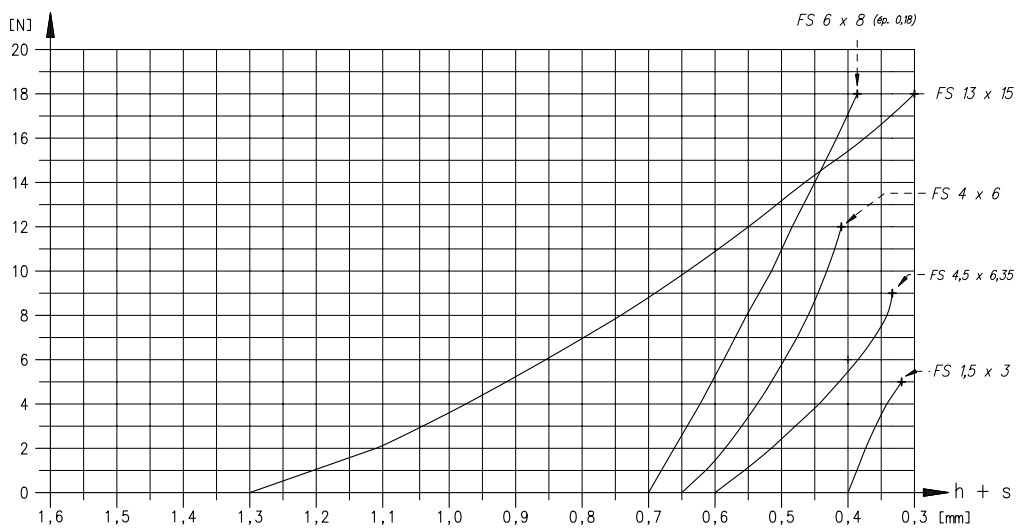
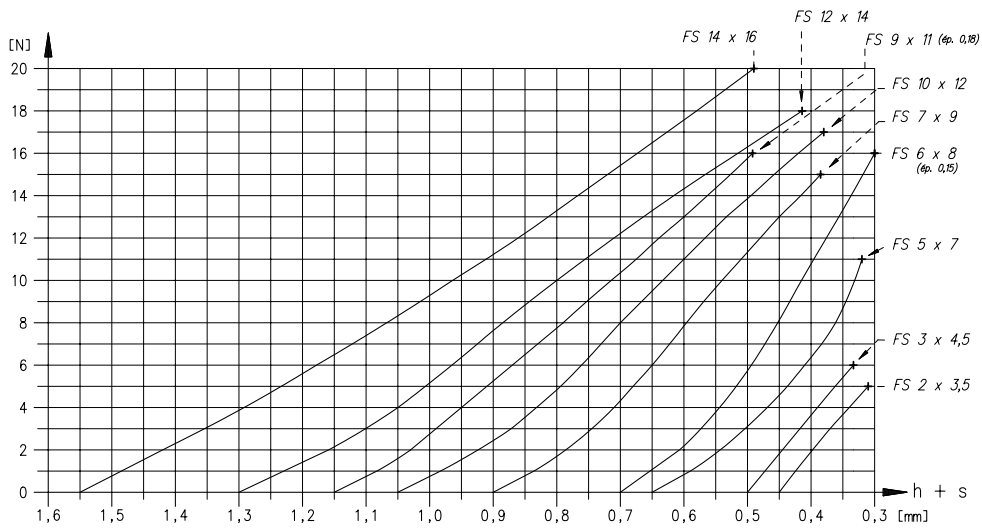
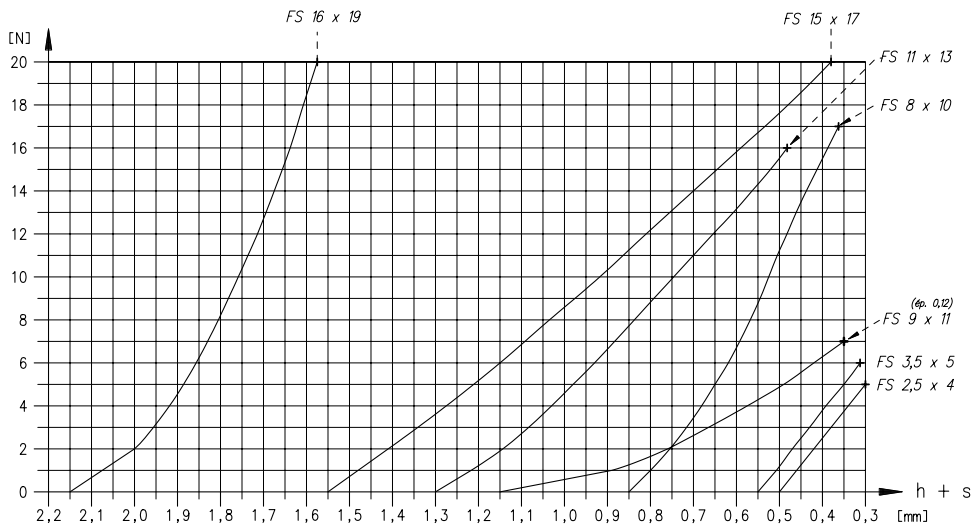

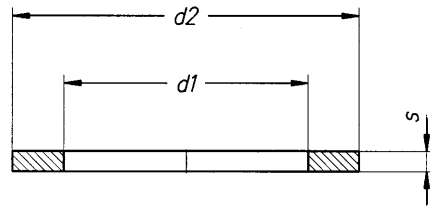

PS

Reference	s* ±0.01 [mm]	d1 [mm]	d2 [mm]	Suitable for bearings with			
				bore Ø [mm]	[inch]	outer Ø [mm]	[inch]
PS 1.5 X 3	0.08 0.10	1.68	2.97			3	
PS 2 X 3.5	0.08 0.10	2.25	3.20	2			.1250
PS 2.5 X 4	0.08 0.10	2.80	3.90	2.5		4	.1563
PS 3 X 4.5	0.08 0.10 0.12	3.30	4.40	3	.1250		
PS 3.5 X 5	0.08 0.10 0.12	3.80	4.90			5	
PS 4 X 6	0.10 0.12 0.15	4.30	5.85	4	.1563	6	
PS 4.5 X 6.35	0.10 0.12 0.15	4.90	6.20		.1875		.2500
PS 5 X 7	0.10 0.12 0.15	5.30	6.85	5		7	
PS 6 X 8	0.12 0.15 0.18	6.30	7.85	6		8	.3125
PS 7 X 9	0.12 0.15 0.18	7.30	8.80	7		9	

Order reference must include thickness "s"

Example: PS 8 X 10 X 0.18

Execution: Flat stainless steel  
Edges radiused  
Heat treated surface  
Fine finished surface



PS

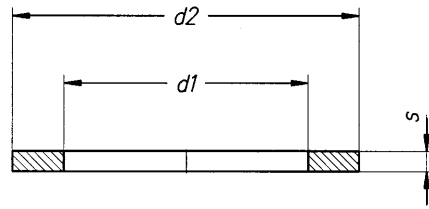

PS

Reference	s» ±0.01 [mm]	d1 [mm]	d2 [mm]	bore Ø [mm]	Suitable for bearings with	
					outer Ø [mm]	outer Ø [inch]
PS 8 X 10	0.15	8.30	9.80	8	.3125	10
	0.18					
	0.20					
PS 9 X 11	0.15	9.30	10.80	9		11
	0.18					
	0.20					
PS 10 X 12	0.18	10.30	11.80	10		12
	0.20					
	0.22					
PS 11 X 13	0.18	11.30	12.80			13
	0.20					
	0.22					
PS 12 X 14	0.20	12.30	13.80			14
	0.22					
	0.25					
PS 13 X 15	0.20	13.30	14.80			15
	0.22					
	0.25					
PS 14 X 16	0.22	14.35	15.80			16
	0.25					
	0.30					
PS 15 X 17	0.22	15.35	16.80			17
	0.25					
	0.30					
PS 16 X 19	0.25	16.40	18.80			19
	0.30					
	0.35					

Forthicknesses of PS and FS > 0.25 mm, the tolerance of "s" ± 0.015 mm.





## HEADQUARTERS

### Miniature Bearings Ltd

Eckweg 8, case postale 6121  
CH-2500 Biel-Bienne 6, Switzerland  
Tel. +41 32 344 43 00  
Fax +41 32 344 43 01  
info@rmb-group.com  
www.rmb-group.com

### Other Manufacturing Plants

**MKL Miniaturkugellager GmbH**  
Wangenerstrasse 87  
D-88299 Leutkirch im Allgäu  
Tel. +49 7561 978 0  
Fax +49 7561 978 280  
rmb.germany@rmb-group.com

**RMB Roulements Miniatures SA**  
La Grenière 199e  
CH-2944 Bonfol  
Tel. +41 32 474 47 41  
Fax +41 32 474 47 15  
info@rmb-group.com

**MPC s.r.o**  
1, maje 1000/PM8  
CZ-75661 Roznov p.R.  
Tel. +420 651 60 32 31  
Fax +420 651 60 32 19  
mpc@rmb-group.com

### RMB Sales Companies

*USA:*  
**RMB Miniature Bearings, Inc.**  
29, Executive Parkway  
Ringwood, NJ 07456, USA  
Tel. +1 973 962 1111  
Fax +1 973 962 1101  
rmb.usa@rmb-group.com

*France; Belgium; Luxembourg:*  
**RMB France SA**  
19, avenue de Norvège  
ZA de Courtaboeuf 1  
F-91953 Les Ulis Cedex  
Tel. +33 1 60 92 17 35  
Fax +33 1 69 86 12 84  
rmb.france@rmb-group.com

*Italy:*  
**RMB Italia s.r.l.**  
Via Bartolomeo D'Alviano, 18  
I-20146 Milano  
Tel. +39 02 477 11 138  
Fax +39 02 477 17 999  
rmb.italia@rmb-group.com

*Germany; Netherland:*  
**RMB Miniaturwälzlager  
Deutschland GmbH**  
Wangenerstrasse 87  
D-88299 Leutkirch im Allgäu  
Tel. +49 7561-7978 0  
Fax +49 7561-7978 280  
rmb.germany@rmb-group.com

*United Kingdom:*  
**RMB Miniature Precision Products  
(UK) Ltd**  
G/F 10 Warren Yard  
Wolverton Mill  
Milton Keynes  
MK12 5NW  
England  
Tel. +44 1908 227 123  
Fax +44 1908 310 427  
rmb.uk@rmb-group.com

### RMB Appointed Distributors

**RMB Miniature Bearings Ltd**  
Hyderabad – 500 001, India  
Tel. +91 40 320 34 53  
Fax +91 40 320 36 76  
paul@hd1.vsnl.net.in

**Bearing Man**  
Marine Parade 4056, South Africa  
Tel. +27 31 336 6200  
Fax +27 31 376 088  
lesterm@bearingman.co.za

**Miniature Bearings Australia Pty  
Ltd**  
Wishart, QLD 4122, Australia  
Tel. +61 7 3349 1400  
Fax +61 7 3349 3801  
sales@minibearings.com.au

**Kurt Koller GmbH**  
A-2700 Wr. Neustadt, Austria  
Tel. +43 2622 23 418 24 6 41  
Fax +43 2622 24 6 41 23  
kugellager@koller.co.at

**KTB Ltd**  
Hong Kong  
Tel. +852 2 78 00 231  
Fax +852 2 78 06 410  
ktbchina@hk.super.net

**Prevotex SA**  
CH-2740 Moutier  
Hungary, Poland, Russia  
Tel. +41 32 493 60 91  
Fax +41 32 493 60 92  
prevotex@bluewin.ch

**H.G. Technical Agencies Ltd**  
ISR-Ganey-Yehuda 56905  
Tel. +972 3 6356 726  
Fax +972 3 534 3082  
hgta@mail.netvision.net.il

**KG Fridman AB**  
S-651 11 Karlstad 1  
Tel. +46 54 18 52 15  
Fax +46 54 18 63 31  
info@fridman.com

**China Bearing Co. Ltd**  
Taiwan, Rep. of China  
Tél. +886 2 2189358  
Fax +886 2 2183000  
twncbc@ms17.hinet.net

**Teximp SA**  
CH-8702 Zollikon  
Croatia, Slovenia, Czech Republic,  
Slovakia, Rumania, Bulgaria  
Tél. +41 1 395 44 44  
Fax +41 1 395 44 45  
ivana.volic@teximp.com

**Kraftmek Oy**  
P.O. Box 36  
FIN-00811 Helsinki  
Tél. +358 9 755 7355  
Fax +358 9 755 5285  
laakerit@kraftmek.com

**Hycomm Technologies Inc.**  
Seoul 135-120, Korea  
Tél. +82 2 548 6942  
Fax +82 2 548 6948  
jk6942@ktnet.co.kr

**Hakuto Co.,Ltd. Electronic  
Component Div.**  
1-13, Shinjyuku 1-Chome, Tokyo  
Tél. +81 3 3225 9082  
Fax +81 3 3225 9017  
umemori-h@hakuto.co.jp

**Ed. Schüpbach AG**  
CH-2500 Biel-Bienne 3  
Tél. +41 32 342 44 02  
Fax +41 32 342 44 04  
lauper@ed-schupbach.ch

