

PEER Corrosion-Resistant ● Bearing Units

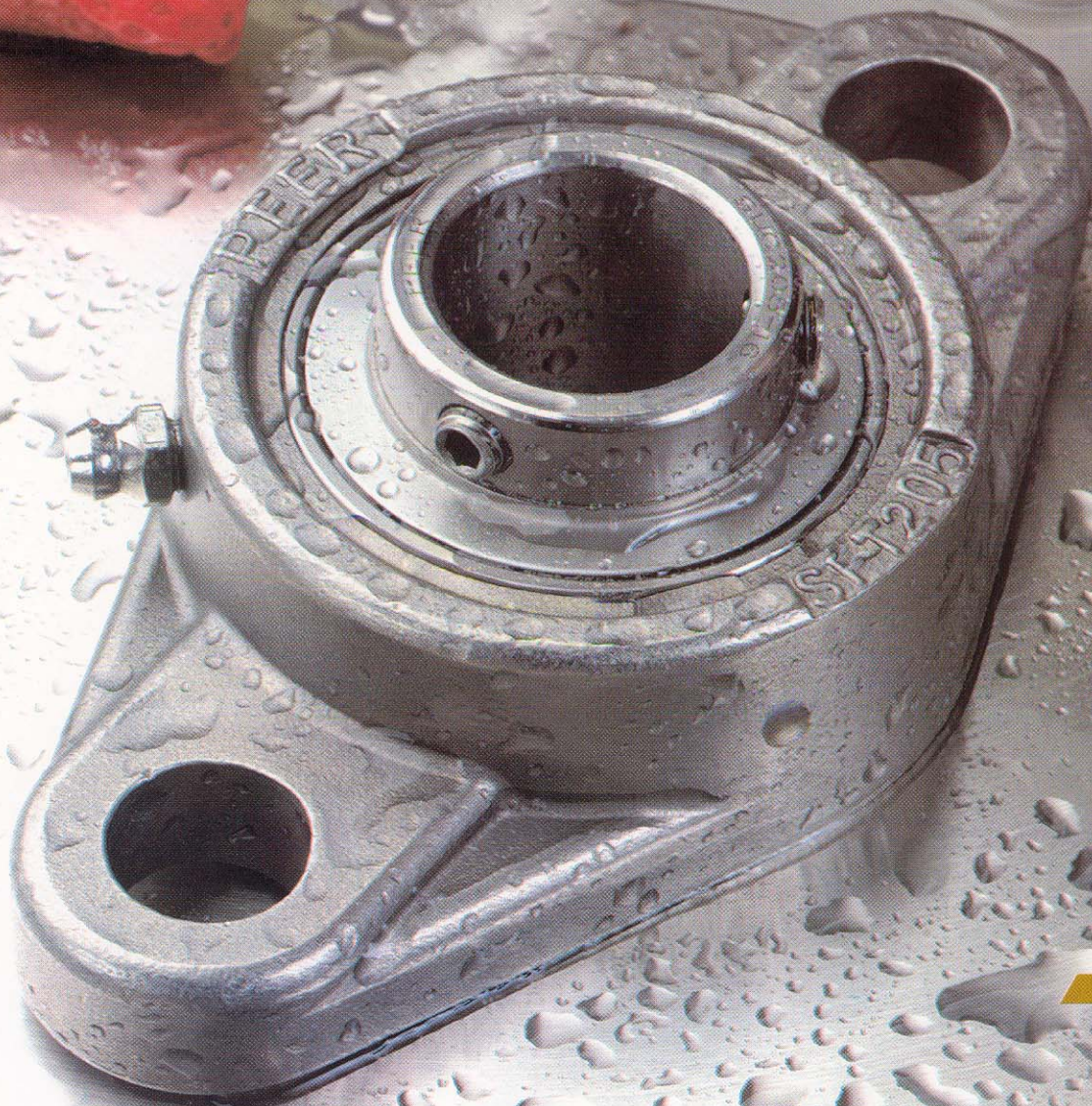



Corrosion Resistant

Stainless Steel units...

The clear choice for **extreme** conditions with heavier loads.

Even under the harshest conditions - sulfuric, nitric or acetic acids and in contaminated or uncontaminated water conditions - Peer's all stainless steel units provide excellent corrosion resistance.

- Stainless steel housings are designed with solid bases/back and smooth surfaces to allow for complete and easy wash down.
- Stainless steel bearings are designed with extended inner rings for shaft stability and set screw locking for bi-directional applications.*
- Standard closures include a stainless steel slinger over a full contact silicon seal to form a double barrier of protection during operation and wash down.
- Stainless steel bearings are filled with FDA/USDA (approved for incidental food contact) water/wash resistant, odorless, tasteless Mobilgrease FM102
- Stainless steel units are available from stock:*
 - Pillow blocks (P)
 - Tapped base pillow blocks (PAS)
 - Two-bolt flange (FT)
 - Three bolt-flange (FB)
 - Four-bolt flange (F).
- Stainless steel bearings are available in common inch and metric shaft sizes ranging from 1/2" to 1 1/2" and 20mm to 40mm.*



Mounted Units... To operate in vir

PBT Thermoplastic Housings with Stainless Steel Bearings...or...PBT Thermoplastic Housings with Stainless/Zinc Chromate Bearings...

Two great options for **severe** conditions

PEER Thermoplastic housings will cope with severe wash down conditions and temperatures to 285° F and have a tensile strength of 17,300 PSI (ASTM D638). They are resistant to moisture absorption and have high mechanical properties. These units maintain excellent chemical resistant ratings even in contact with hydrochloric, sulfuric, nitric and acetic acids. In addition, they can resist most hydroxides and alcohols.

- Housings are made from G.E. Valox® virgin PBT thermoplastic material and are designed with solid bases/back and smooth surfaces to allow for complete and easy wash down.
- Stainless steel and stainless/zinc chromate bearings are designed with extended inner rings for shaft stability and set screw locking for bi-directional applications.*
- Standard closures include a stainless steel slinger over a full contact silicon seal to form a double barrier of protection during operation and wash down.
- Stainless steel and stainless/zinc chromate bearings are filled with FDA/USDA (approved for incidental food contact) water/wash resistant, odorless, tasteless Mobilgrease FM102
- Thermoplastic units are available from stock:*
 - Pillow blocks (P)
 - Tapped base pillow blocks (PAS)
 - Two-bolt flange (FT)
 - Three bolt-flange (FB)
 - Four-bolt flange (F)
 - Hanger (HA)
 - Take-up (T)
- Stainless steel and stainless/zinc chromate bearings are available in common inch and metric shaft sizes from 1/2" to 1 1/2" and 20mm to 40mm.*

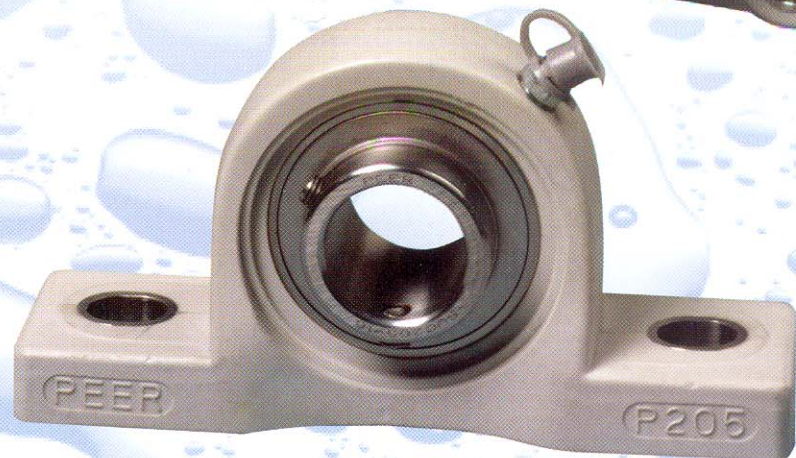

* For alternative locking devices, additional housings styles and bore sizes, please contact your Peer Bearing Co. sales representative.

rtually any Corrosive Environment

Electroless Nickel plated... for moderate contamination conditions

With an eye toward economy in addition to contamination resistance, these PEER units are designed with black oxide inserts and electroless nickel plated housings. The results are mounted ball bearing units ideal for applications requiring corrosion resistance superior to the protection afforded by conventional painted cast or ductile iron housings.

- Housings plated with .001" thick electroless, high phosphorous (+10%) nickel.
- Electroless Nickel plated over premium (Grade 30) cast iron or high strength 65-45-12 ductile iron.

- Bearing available in all standard locking devices; set screw, eccentric locking collars or premium *GRIP-IT* locking collars.



- Black oxide bearings designed with slingers and full contact metal shroud seals for maximum protection.
- Castings available in any style listed in the PEER catalog.
- Black oxide bearings are available in all common inch and metric shaft sizes.



Material Specifications

SSUCP200 Series**

All Stainless Steel Bearing/ Housing Unit

1. Stainless steel AISI 440C
2. Stainless steel AISI 440C
3. Stainless steel AISI 302
4. Stainless steel AISI 420
5. FDA approved silicone rubber (-10°F to 220°F)
6. Stainless steel AISI 302
7. Solid base stainless steel AISI 304
8. Stainless steel AISI 304

SSUCP200-PBT Series**

Stainless Steel Bearing w/PBT (Thermoplastic) Housing

1. Stainless steel AISI 440C
2. Stainless steel AISI 440C
3. Stainless steel AISI 302
4. Stainless steel AISI 420
5. FDA approved silicone rubber (-10°F to 220°F)
6. Stainless steel AISI 302
7. G.E. Valox® 420 glass filled PBT (thermoplastic) solid base
8. Stainless steel zerk and stainless steel lined zerk hole for added strength
9. Stainless steel bolt bushing for added strength

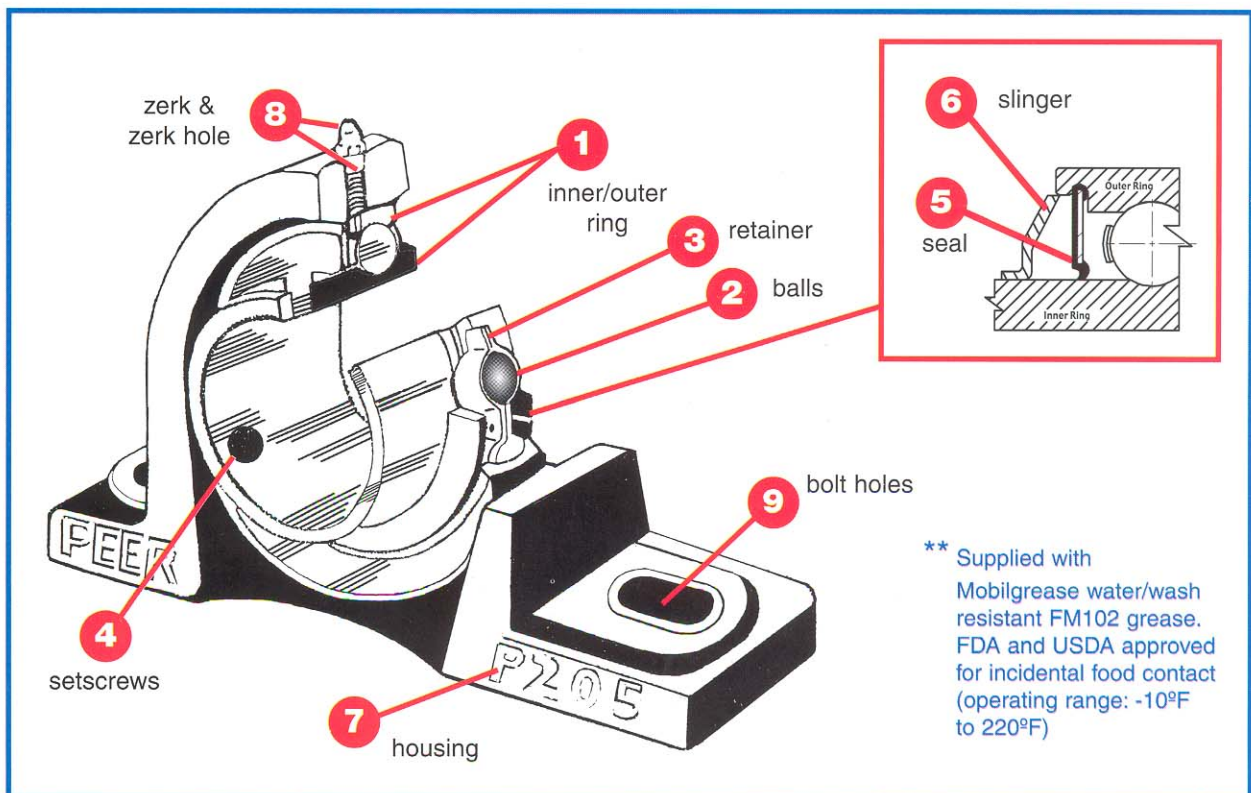

ZUCP200-PBT Series**

Zinc/Stainless Bearing w/PBT (Thermoplastic) Housing

1. Zinc chromate plated (4-6um thick) 52100 steel
2. Stainless steel AISI 440C
3. Stainless steel AISI 302
4. Stainless steel AISI 420
5. FDA approved silicone rubber (-10°F to 220°F)
6. Stainless steel AISI 302
7. G.E. Valox® 420 glass filled PBT (thermoplastic) solid base
8. Stainless steel zerk and stainless steel lined zerk hole for added strength
9. Stainless steel bolt bushing for added strength







UCP200-BENP Series

Black Oxide Plated Bearing w/Electroless Nickel Plated Housing

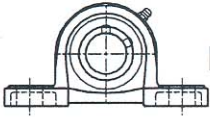
1. Black oxide plated 52100 steel
 2. 52100 steel-grade 10
 3. Stamped steel C1010
 4. Black oxide plated steel
 5. Buna-N rubber bonded to steel shroud
 6. Black oxide plated steel
 7. Electroless nickel (.001" thick) plated over cast or ductile iron
 8. Clear zinc plated steel zerk
- Grease: Shell Alvania RL2

Note: Illustration shown above is for standard pillow block (SSUCP). Also available in other housing styles. Example SSUCF200 Series=4 bolt flange

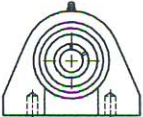
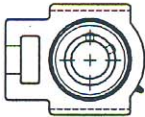
Interchange for PEER's Corrosion-Resistant Mounted Units Available in a full range of popular sizes

| BEARING STYLE | DESCRIPTION | PEER | MRC | AMI |
|--------------------------------------------------------------------------------------------------------|---------------------------------------|----------------------|-------------------|--------------------|
|  PILLOW BLOCK | STAINLESS STEEL BEARING & HOUSING | SSUCP200 SERIES | | MUCP200 SERIES |
| | STAINLESS BRG & THERMOPLASTIC HOUSING | SUCP200-PBT SERIES | CPB100-SSG SERIES | MUCPPL200 SERIES |
| | ZINC BRG & THERMOPLASTIC HOUSING | ZUCP200-PBT SERIES | CPB100-ZM SERIES | UCPPL200 MZ SERIES |
|  4 BOLT FLANGE | STAINLESS STEEL BEARING & HOUSING | SSUCF200 SERIES | | |
| | STAINLESS BRG & THERMOPLASTIC HOUSING | SUCF200-PBT SERIES | C4F100-SSG SERIES | MUCFPL200 SERIES |
| | ZINC BRG & THERMOPLASTIC HOUSING | ZUCF200-PBT SERIES | C4F100-ZM SERIES | UCFPL200 MZ SERIES |
|  2 BOLT FLANGE | STAINLESS STEEL BEARING & HOUSING | SSUCFT200 SERIES | | MUCFL200 SERIES |
| | STAINLESS BRG & THERMOPLASTIC HOUSING | SUCFT200-PBT SERIES | C2F100-SSG SERIES | MUCNFL200 SERIES |
| | ZINC BRG & THERMOPLASTIC HOUSING | ZUCFT200-PBT SERIES | C2F100-ZM SERIES | UCNFL200 MZ SERIES |
|  3 BOLT FLANGE | STAINLESS STEEL BEARING & HOUSING | SSUCFB200 SERIES | | |
| | STAINLESS BRG & THERMOPLASTIC HOUSING | SUCFB200-PBT SERIES | | MUCFBL200 SERIES |
| | ZINC BRG & THERMOPLASTIC HOUSING | ZUCFB200-PBT SERIES | | UCFBL200 MZ SERIES |
|  TAP BASE | STAINLESS STEEL BEARING & HOUSING | SSUCPAS200 SERIES | | |
| | STAINLESS BRG & THERMOPLASTIC HOUSING | SUCPAS200-PBT SERIES | CTB100-SS SERIES | MUCTBL200 SERIES |
| | ZINC BRG & THERMOPLASTIC HOUSING | ZUCPAS200-PBT SERIES | CTB100-ZM SERIES | UCTBL200 MZ SERIES |
|  TAKE UP | STAINLESS STEEL BEARING & HOUSING | SSUCT200 SERIES | | |
| | STAINLESS BRG & THERMOPLASTIC HOUSING | SUCT200-PBT SERIES | | MUCTPL200 SERIES |
| | ZINC BRG & THERMOPLASTIC HOUSING | ZUCT200-PBT SERIES | | UCTPL200 MZ SERIES |
|  HANGER | STAINLESS STEEL BEARING & HOUSING | SSUCHA200 SERIES | | |
| | STAINLESS BRG & THERMOPLASTIC HOUSING | SUCHA200-PBT SERIES | | MUCHPL200 SERIES |
| | ZINC BRG & THERMOPLASTIC HOUSING | ZUCHA200-PBT SERIES | | UCHPL200 MZ SERIES |

Interchange for reference only. Available in full range of popular shaft sizes.

Distributed by:



2200 Norman Drive South
Waukegan, Illinois 60085
Phone: 847-578-1000
e-mail: sales@peerbearing.com
www.peerbearing.com