

For New Technology Network

NTN[®]

HAND NEEDLE ROLLER BEARINGS HANDBOOK



HAND BOOK

CAT. No. 9013/E

NTN

**Needle Roller Bearing
Handbook**



Index

1	Needle Roller Bearings	4
1. 1	Classification of needle roller bearings	4
1. 2	Comparison with general bearings	4
1. 3	Comparison of needle roller and cage assembly bearings and full-complement needle roller bearings	7
1. 4	Production methods for needle roller bearings	10
2	Characteristics of Various Series of Needle Roller Bearings	12
2. 1	Series numbers and bearing names	12
3	Bearing Selection	26
4	Load Rating and Life	28
4. 1	Bearing life	28
4. 2	Basic rated life and basic dynamic load rating	28
4. 3	Factors affecting bearing life	28
4. 4	Installation error and crowning	29
4. 5	Radial internal clearance, surface roughness, surface hardness and bearing life	30
4. 6	Tips for longer bearing life	30
4. 7	Basic static load rating	30
5	Fitting Needle Roller Bearings	32
5. 1	Fitting machined-ring radial needle roller bearings	32
5. 2	Fitting of drawn-cup needle roller bearings	33
6	Shaft and Housing Design	35
6. 1	Shaft and housing accuracy	35
6. 2	Raceway accuracy	35
6. 3	Raceway materials and their hardness	35
7	Tips on Bearing Use	36
8	Engineering Data	38
8. 1	Track loading capacity of cam followers and roller followers	38
8. 2	Outer ring strength	39
8. 3	Stud strength of cam followers	39
8. 4	Calculating tightening torque of cam follower	42
9	Product Introduction & Index	43
10	Bearing Numbers	68
11	Comparison of Bearing Series by Manufacturer	70

1

2

3

4

5

6

7

8

9

10

11

1. Needle Roller Bearings

1.1 Classification of needle roller bearings

Needle roller bearings are categorized into the following two groups:

- Needle roller and cage assembly bearings
- Full-complement needle roller bearings

1.2 Comparison with general bearings

(1) Greater load-bearing capacity in a more compact design

Needle roller bearings are smaller than general bearings but have a greater load-carrying capacity. This advantage allows for more compact designs for bearings as well as for bearing housings. Use of these bearings lowers costs by allowing for lighter-weight machinery and more compact structures.

Fig. 1.1 compares bearings with (30) mm bore diameters. Needle roller bearings have 2 to 8 times the load-carrying capacity per given mass than other bearing types.

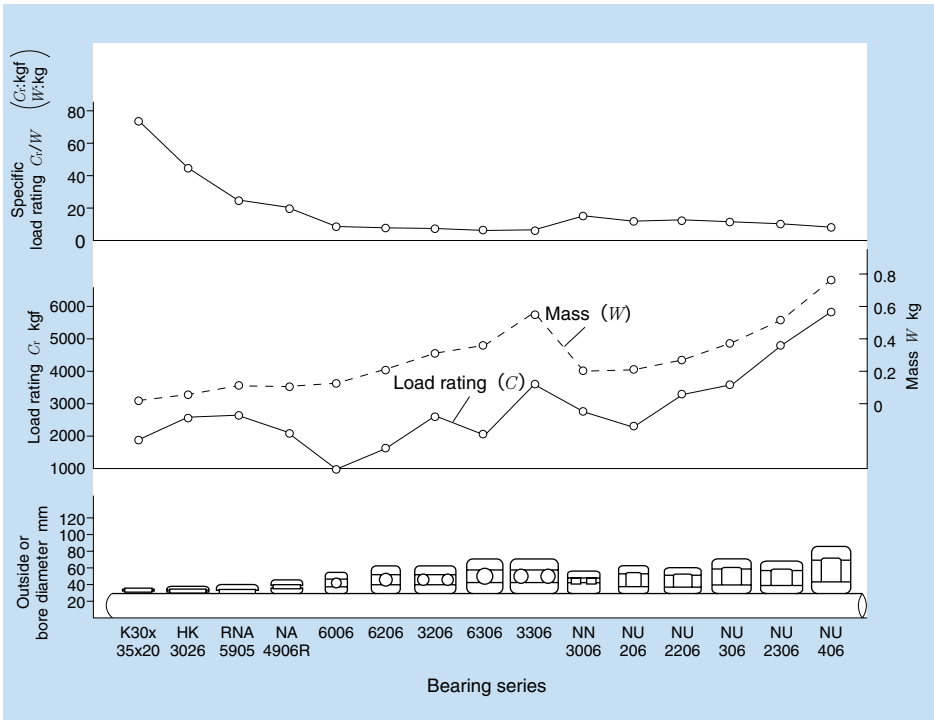

Fig. 1.1

Fig. 1.2 shows a comparison of bearing sizes of standard dimensions and similar load-carrying capacity. Needle roller bearings have one-half the outside diameter and one-fifth the mass of deep-groove ball bearings.

Needle roller and cage assembly bearings differ from general bearings in that, if the shaft and bearing housing can be made to a specific hardness, accuracy, and surface roughness, the needle roller and cage assemblies can function as independent bearings without inner and outer rings. Bearings used in this way are smaller and can be used in the same space as a metal bearing.

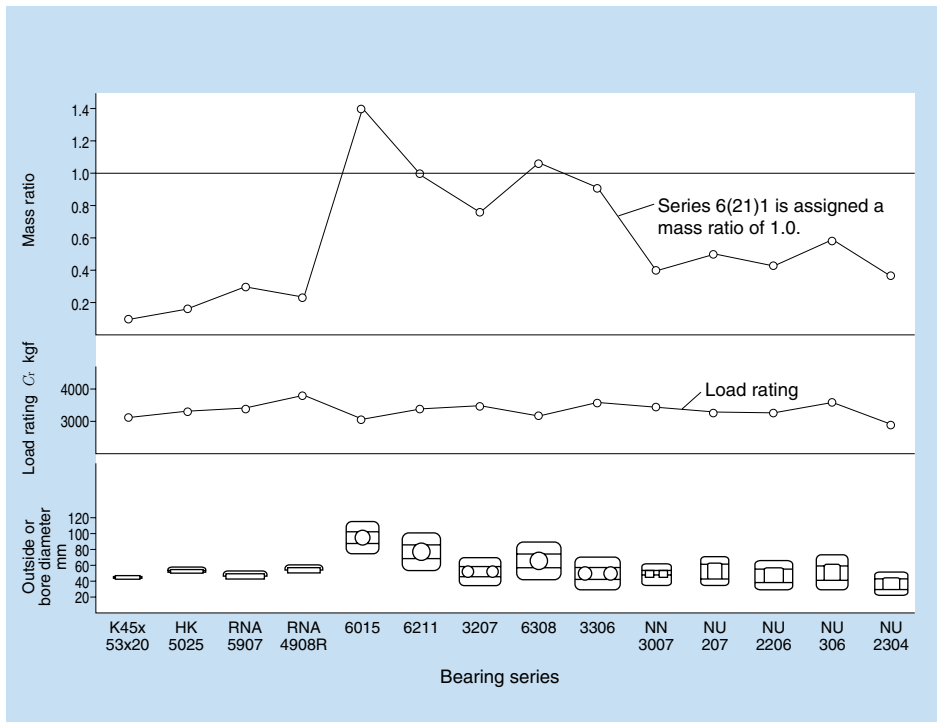

Fig. 1.2

(2) Low inertial force

Because needle roller and cage assemblies have a smaller mass, these bearings are particularly useful for applications in which a smaller inertial force is required, such as in an engine crankshaft. (Fig. 1.3)

(3) High rigidity

Fig. 1.4 shows the elastic displacement when the radial load is applied to various bearings with similar basic load ratings.

1. Needle roller bearings have the following characteristics in comparison to cylindrical roller bearings.
 - More rollers are included.
 - ℓ/d is greater.

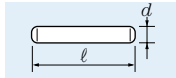

2. Needle roller bearings have greater rigidity because the load carried per unit area is smaller than ball bearings.

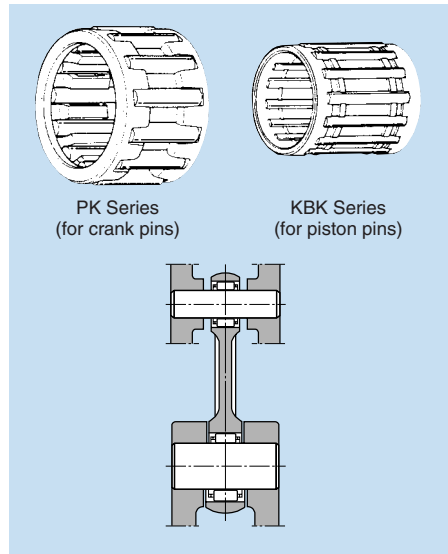

Fig. 1.3

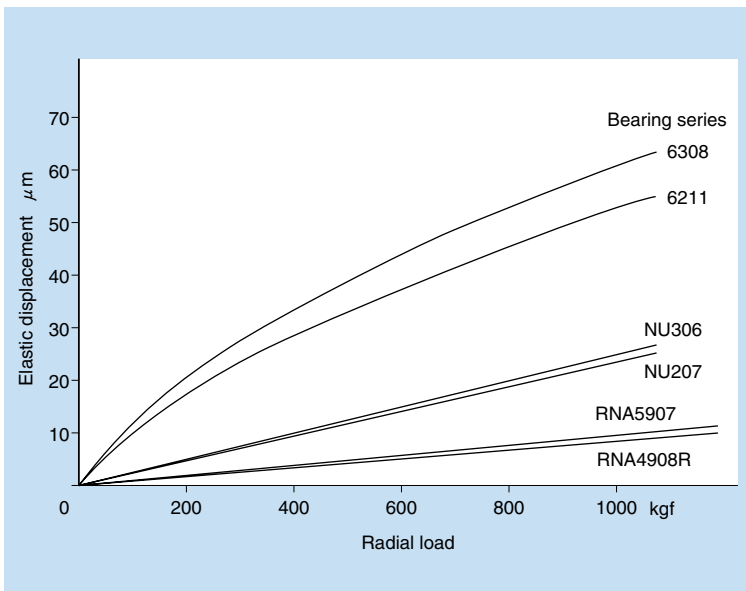

Fig. 1.4

(4) Needle roller bearings are suitable for applications with oscillatory movement.

If the oscillatory movement does not overlap the adjacent rollers, the lubricant between the rollers and bearing ring is pushed out and becomes inadequate. Accordingly, this condition shortens the life of the bearing. To prevent this condition, the bearing must be designed with an oscillatory angle that, at minimum, overlaps the position of the adjacent roller.

This design ensures good lubrication of the adjacent rollers, because the lubricant is forced out of the rollers and prevents them from wearing. Fig. 1.5 shows the minimum oscillatory angle of the inner and outer rings. This is the most effective means of increasing the number of rollers in one row and ensuring the minimum oscillatory angle. The needle roller bearing is therefore the most suitable for the purpose.

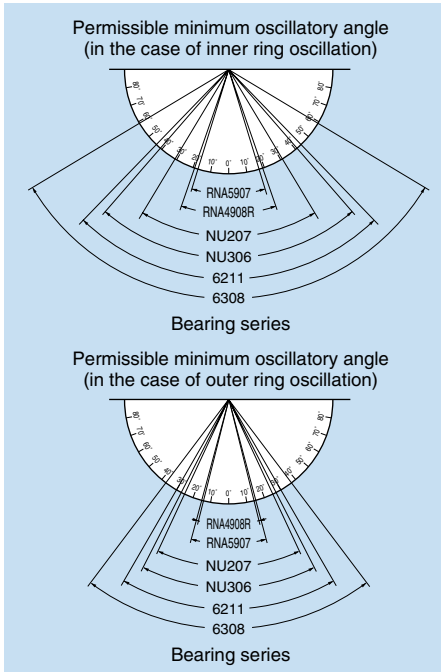

Fig. 1.5

1. 3 Comparison of needle roller and cage assembly bearings and full-complement needle roller bearings

Table 1.1

Item	Type	Needle roller and cage assembly bearing	Full-complement needle roller bearing
Roller skew		Low incidence	High incidence
Friction coefficient		Small	Large
Temperature rise		Low	High
Permissible speed		High	Low
Load-carrying capacity		Less than that of full-complement needle roller bearings	Can be increased.

Needle roller and cage assembly bearings are used in a wide range of diverse applications, but full-complement needle roller bearings are more suitable for high-load, low-speed, and oscillating applications, as they have a greater load-carrying capacity.

(1) Roller skew

Needle roller and cage assembly bearings feature rotational accuracy due to the ample strength and rigidity of the shaft and bearing housing, which guide the case assembly. This feature ensures the correct rotation of the needle rollers. In contrast, the full-complement needle roller bearing has no structure for precisely guiding the needle rollers, and its instability may cause the needle rollers to skew. (Fig. 1.6)

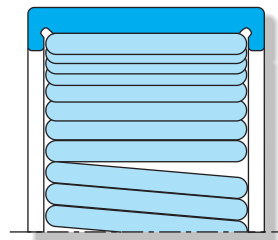
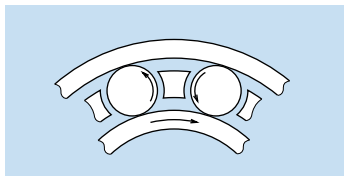

Fig. 1.6

(2) Friction coefficient

Needle roller and cage assembly bearing



The slipping speed between the cage assembly and needle rollers is only the circumference speed of the needle rollers.

Full-complement needle roller bearing

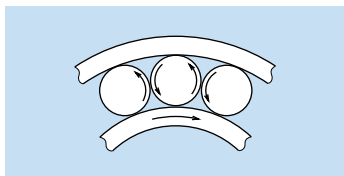

The relative slippage speed of adjacent needle rollers is twice the circumference speed of one needle roller; in addition, skew makes the needle roller rotate while slipping.

Accordingly, the friction coefficient of the full-complement needle roller bearing is about twice that of the needle roller and cage assembly bearing.

Table 1.2 shows the friction coefficient of various types of bearings.

Table 1.2 Friction coefficients of various bearings

Bearing classification	Friction coefficient μ
Deep-groove ball bearings	0.0010~0.0015
Angular contact ball bearings	0.0012~0.0018
Self-aligning ball bearings	0.0008~0.0012
Cylindrical roller bearings	0.0010~0.0015
Tapered roller bearings	0.0017~0.0025
Self-aligning roller bearings	0.0020~0.0025
Thrust ball bearings	0.0010~0.0015
Needle roller and cage assembly bearings	0.0020~0.0030
Full-complement needle roller bearings	0.0040~0.0050
Thrust needle roller bearings	0.0030~0.0040

(3) Temperature rise

The approximate temperature rise of a running bearing is usually calculated with the following formula:

where,

$$T_m - T_0 = 0.00514 \frac{\mu \cdot F_r \cdot d \cdot n}{W_s}$$

T_m : Temperature when the bearing reaches equilibrium °C

T_0 : Ambient air temperature °C

μ : Friction coefficient

F_r : Radial load kgf

d : Single bore diameter of bearing mm

n : Revolutions per minute rpm

W_s : Heat dissipated to the surroundings per 1°C temperature difference. Watt / °C

(The temperature rise is less with needle roller and cage assembly bearings, as it is proportional to μ .)

Fig. 1.7 shows the effect of changing speed and load on needle roller and cage assembly bearings and full-complement needle roller bearings having the same boundary dimensions for bore diameter (32 mm), outside diameter (47 mm), and width (20 mm).

At 750 kgf and 7500 rpm, as shown in the figure, the full-complement needle roller bearing exceeds 170 °C and ceases to rotate, while the needle roller and cage assembly bearing remains below 100 °C, thus permitting higher speeds.

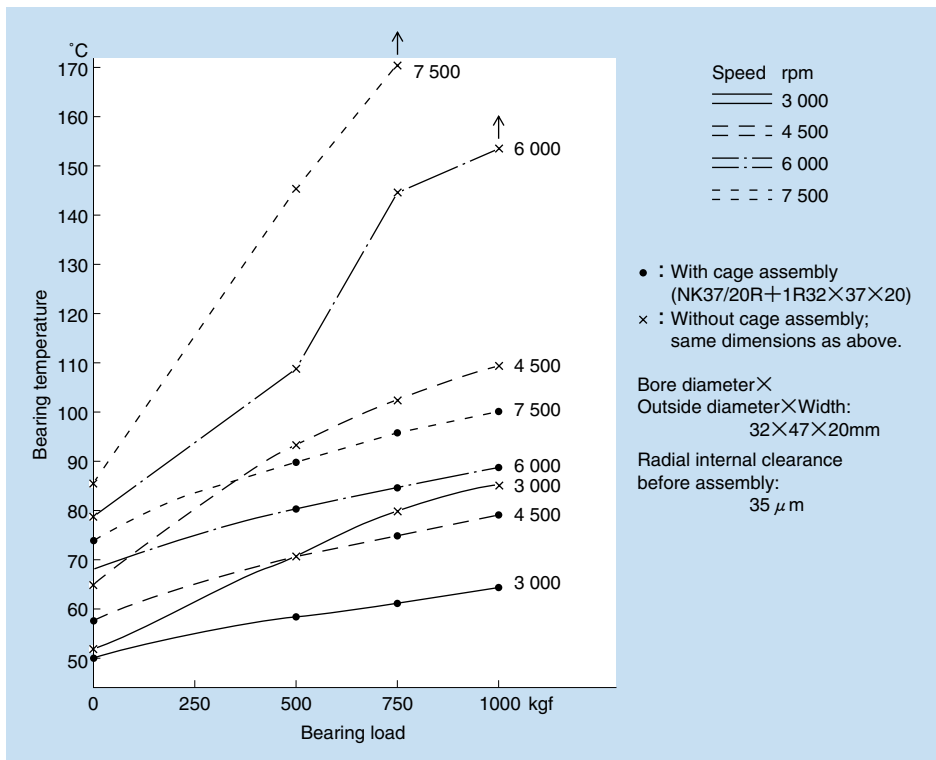

Fig. 1.7

(4) High permissible speeds

According to the characteristics indicated above, needle roller and cage assembly bearings are suitable for high-speed operation. "Permissible speed" is the speed limit that a bearing can safely withstand over a long period. This speed varies with the type and dimensions of the bearing, type of cage assembly, shaft carrying load, lubrication method, peripheral structure around the bearing, and cooling conditions.

The permissible speeds listed in NTN catalogs represent the values that can be applied when the bearing is correctly mounted and maintained with the most appropriate lubricant.

(5) Load capacity

The number of rollers in a full-complement needle roller bearing can be increased because there is no cage assembly; therefore, the bearing can be designed with a greater load-carrying capacity.

1.4 Production methods for needle roller bearings

Needle roller bearings (drawn-cup type) are manufactured with the following processes.

The cage shown is a welded type.

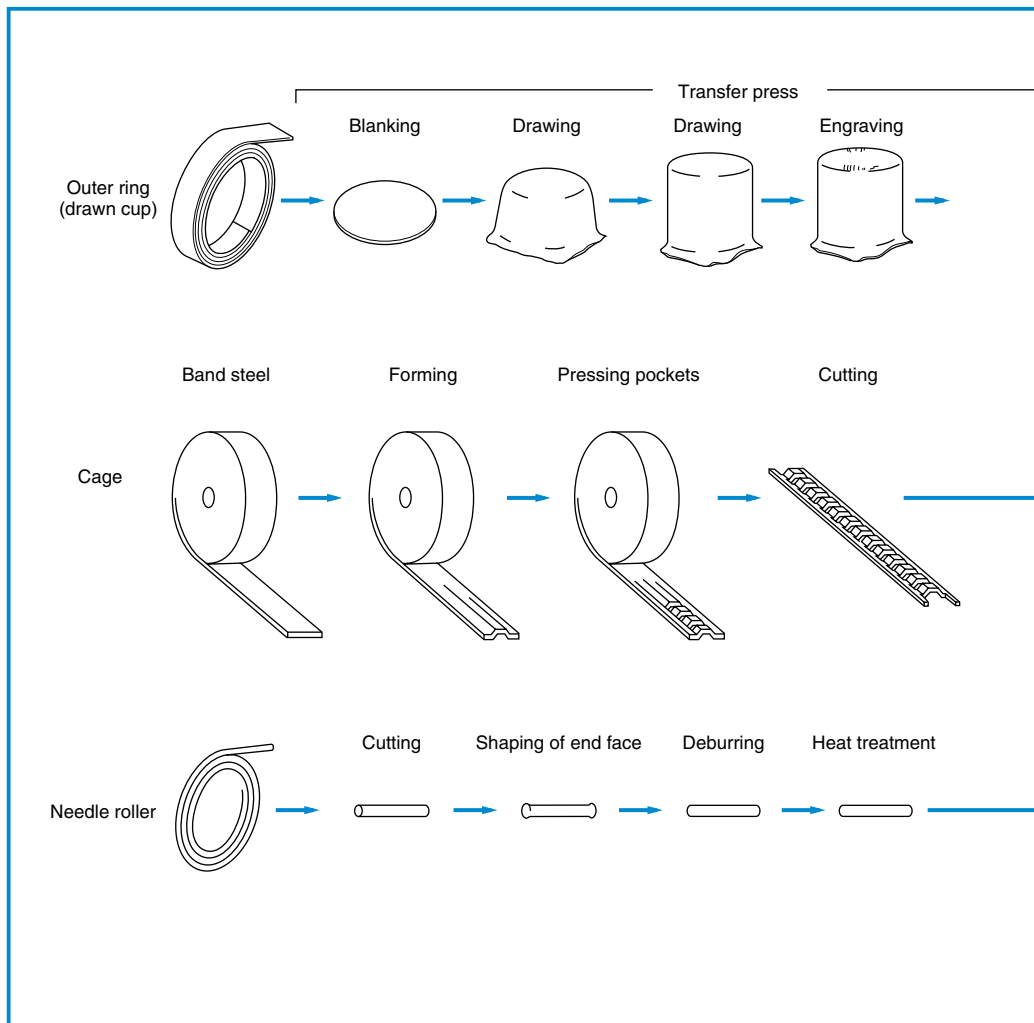
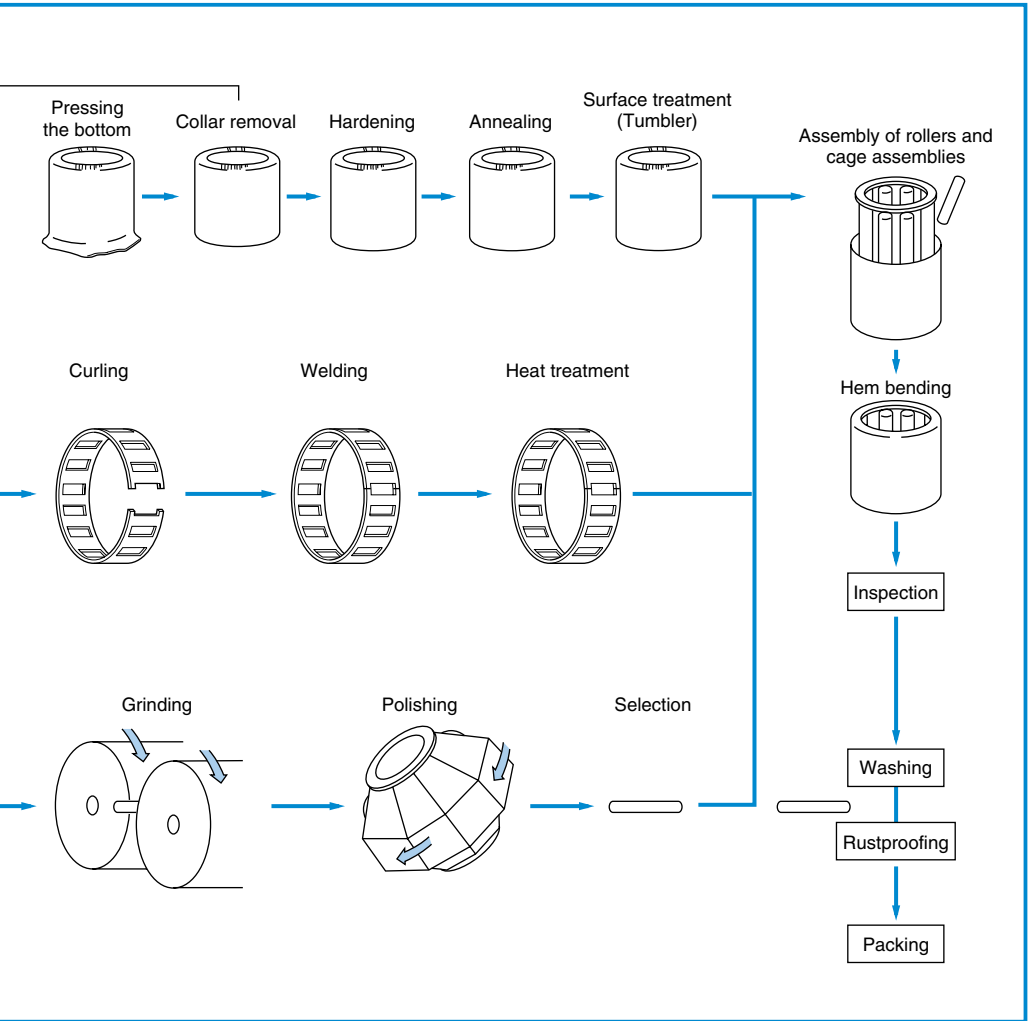

Fig. 1.8 Processing method for drawn-cup needle roller bearings



2. Characteristics of Various Series of Needle Roller Bearings

2.1 Series numbers and bearing names

Table 2.1 Needle roller and cage assemblies



















Category	Series code	Bearing name	Appearance	Characteristics	
Needle roller and cage assemblies	Machined-ring type	GH	Cage assembly without roller locating (for crank pins)	 H Series, split type	
		GK	Needle roller and split cage assembly	 K Series, split type	
		GPK	Needle roller and split cage assembly (for crank pins)	 RK Series, split type Cage assembly with M shaped structure	
		H	Cage assembly without roller locating (for crank pins)	 High-rigidity cage assembly Capable of higher speeds than the PK Series	
		K	Needle roller and cage assembly	 Basic type (with high-rigidity cage assembly)	
		KBK	Needle roller and cage assembly for piston pins	 Bore diameter guide for cage assembly (high-rigidity cage assembly)	
		PK	Needle roller and cage assembly for crank pins	 Outside diameter guide for cage assembly (high-rigidity cage assembly) Cage assembly with M shaped structure	
		Pressed type	KMJ	Needle roller and cage assembly	 Steel-plate cage assembly Cage assembly with M shaped structure
			PCJ	Needle roller and cage assembly	↑ Steel-plate cage assembly Cage assembly with M shaped structure Inch series
		Welded type	GK·S	Needle roller and split cage assembly	 Thick steel-plate cage assembly High-rigidity cage assembly
	GKV·S		Needle roller and split cage assembly	 Thick steel-plate cage assembly	
	K·S		Needle roller and cage assembly	 Thick steel-plate cage assembly High-rigidity cage assembly	
	KJ·S		Needle roller and cage assembly	 Steel-plate cage assembly	
	KMJ·S		Needle roller and cage assembly	 Steel-plate cage assembly Cage assembly with M shaped structure	
	KV·S		Needle roller and cage assembly	 Thick steel-plate cage assembly High-rigidity cage assembly Cage and assembly with V-shaped structure	
	SK·S		Needle roller and single-split cage assembly	 K-S Series, single-split type	
	SKJ·S		Needle roller and single-split cage assembly	 KJ-S Series, single-split type	
	SKV·S		Needle roller and single-split cage assembly	 KV-S Series, single-split type	
	Plastic type	K·T2	Needle roller and cage assembly	 Molded cage assembly of polyamide plastic Max. permissible temperature: 120°C Max. continuous operating temperature: 100°C	

Table 2.2 Machined-ring needle roller bearings









Category	Series code	Bearing name	Appearance	Characteristics	
Machined-ring needle roller bearings	With inner ring	MR+MI	Machined-ring needle roller bearings		Inch series Assembly of MR Series and M Series inner rings
		NA 48	Machined-ring needle roller bearing (Dimension series 48)	↑	Assembly of RNA48 Series and IR Series inner rings
		NA 49	Machined-ring needle roller bearing (Dimension series 49)	↑	Assembly of RNA49 Series and IR Series inner rings. Sealed series (L, LL) also available
		NA49·S	Adjustable-clearance needle roller bearing (Dimension series 49)		Assembly of RNA49-S Series and IR Series inner rings
		NA 59	Machined-ring needle roller bearing (Dimension series 59)		Assembly of RNA59 Series and IR Series inner rings
		NA 69	Machined-ring needle roller bearing (Dimension series 69)	↑	Assembly of RNA69 Series and IR Series inner rings
		NAO	Machined-ring needle roller bearings Separable type		Assembly of RNAO Series and IR Series inner rings
		NK+IR	Machined-ring needle roller bearings		Assembly of NK Series and IR Series inner rings
		NKI	Machined-ring needle roller bearings		With inner ring, special
	Without inner ring	MR	Machined-ring needle roller bearings		Inch series High-rigidity outer ring High accuracy, Single-row structure
		NK	Machined-ring needle roller bearings	↑	High-rigidity outer ring High accuracy, Single-row structure
		NKS	Machined-ring needle roller bearings	↑	For heavy loads
		RNA 48	Machined-ring needle roller bearing (Dimension series 48)	↑	High-rigidity outer ring High accuracy, Single-row structure
		RNA 49	Machined-ring needle roller bearing (Dimension series 49)	↑	High-rigidity outer ring High accuracy, Single-row structure Sealed series (L, LL) also available
		RNA49·S	Adjustable-clearance needle roller bearing (Dimension series 49)		Radial clearance is adjustable Single-row structure
		RNA 59	Machined-ring needle roller bearing (Dimension series 59)		High-rigidity outer ring High accuracy, Single-row structure
		RNA 69	Machined-ring needle roller bearing (Dimension series 69)	↑	High-rigidity outer ring, High accuracy Single row ($F_w \leq 35$). Double row ($F_w \geq 40$)
		RNAO	Machined-ring needle roller bearings Separable type		High-rigidity outer ring, High accuracy Single-row and double-row series (with ZW) are available
Other items	NKZ	Machined-ring needle roller bearings (with different shape)		Special specifications	

Table 2.3 Drawn-cup needle roller bearings-1

















Category	Series code	Bearing name	Appearance	Characteristics
Drawn-cup needle rollers	Open-end type	DCH		Inch series With cage assembly, For heavy loading
		DCL	↑	Inch series, With cage assembly
		HK		Double-row type (with ZW) bearings with cage assembly are available Small-diameter plastic bearings (with T2) are available
		HK · ^L _{LL}		With cage assembly Prelubricated with standard grease (3A)
		HKS		With cage assembly, Special
		HMK	↑	With cage assembly, For heavy loading
		HMK · ^L _{LL}		With cage assembly Prelubricated with standard grease (3A)
		HMV		Full-complement needle roller type
		HR		With cage assembly, For heavy loading
		HV		Full-complement needle roller (with C end face rollers)
		HVS	↑ as well 	Full-complement needle roller type Special Prelubricated with standard grease (3A)
		VS		Full-complement needle roller (with C end face rollers)
		VSH	↑	Full-complement needle roller (with C end face rollers) For heavy loading
		Closed-end type	BK	
BK · · L			With cage assembly Prelubricated with standard grease (3A)	
BKS			With cage assembly	
BMK	↑		With cage assembly	
BV			Full-complement needle roller type	
BVS	↑ as well 		Full-complement needle roller type Prelubricated with standard grease (3A)	

Table 2.3 Drawn-cup needle roller bearings-2

Category	Series code	Bearing name	Appearance	Characteristics	
Drawn-cup needle rollers	Closed-end type	DBH	Drawn-cup needle roller bearing		Inch series With cage assembly, For heavy loading
		DBL	Drawn-cup needle roller bearing	↑	Inch series, With cage assembly
		VB	Drawn-cup needle roller bearing		Inch series Full-complement needle roller (with C end face rollers)
		VBH	Drawn-cup needle roller bearing	↑	Inch series, For heavy loading Full-complement needle roller (with C end face rollers)

2

Table 2.4 Compound bearings

(Needle roller bearing with thrust ball bearing/Needle roller bearing with thrust cylindrical roller bearing)
(Needle roller bearing with angular contact ball bearing / Needle roller bearing with three-point contact ball bearing)



Category	Series code	Bearing name	Appearance	Characteristics
Compound bearings	ARN	Needle roller bearing with double-direction thrust cylindrical roller bearing		Loading with radial load and double-direction axial load For high axial loading
	AXN	Needle roller bearing with double-direction thrust needle roller bearing		Loading with radial load and double-direction axial load For high axial loading
	NKIA 59	Needle roller bearing with angular contact ball bearing (Dimension series 59)		Loading with single-direction axial load
	NKIB 59	Needle roller bearing with three-point contact ball bearing (Dimension series 59)		Loading with double-direction axial load
	NKIT	Compound bearings		With inner ring, Special
	NKT	Compound bearings		Without inner ring, Special
	NKX	Needle roller bearing with thrust ball bearing		Open type Loading with single-direction axial load
	NKX··Z	Needle roller bearing with thrust ball bearing		With cover
	NKXR	Needle roller bearing with thrust cylindrical roller bearing		Open type Loading with single-direction axial load
	NKXR··Z	Needle roller bearing with thrust cylindrical roller bearing		With cover
	NX	Needle roller bearing with full-complement thrust roller bearing		Special product

Table 2.5 Thrust roller bearings-1





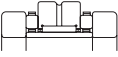
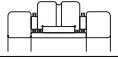

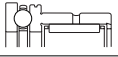
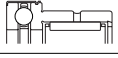
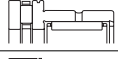
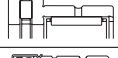
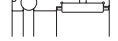



















Category	Series code	Bearing name	Appearance	Characteristics	
Thrust roller bearings	Thrust needle roller bearings	AK	Needle roller and thrust cage assembly		Flat cage, Special
		AKJ	Needle roller and thrust cage assembly		Stainless steel pressed cage Series W/Box type, special type
		ARXJ	Integrated thrust needle roller bearing		Assembly (Bearing + thrust washer) Available as separable and non-separable types
		AXK 11	Needle roller and thrust cage assembly		Stainless steel pressed cage
		NTC	Needle roller and thrust cage assembly	↑	Inch series Stainless steel pressed cage
	Thrust washers	AS 11	Thrust washers (Dimension series 11)		Made from steel plate
		NWA	Thrust washers	↑	Inch series, Made from steel plate
		NWB	Thrust washers	↑	↑
	Thrust cylindrical roller bearings	811	Thrust cylindrical roller bearings (Dimension series 11)		Assembly of K811 Series and WS / GS Series bearing washers
		812	Thrust cylindrical roller bearings (Dimension series 12)	↑	Assembly of K812 Series and WS / GS Series bearing washers
		874	Thrust cylindrical roller bearings (Dimension series 74)		Assembly of K874 Series and WS / GS Series bearing washers
		893	Thrust cylindrical roller bearings (Dimension series 93)		Assembly of K893 Series and WS / GS Series bearing washers
		CTC	Cylindrical roller and thrust cage assembly		Inch series
		CTCA	Thrust cylindrical roller bearings		Inch series CTC Series and CWS Series in inch series / Assembly of CGS Series bearing washers
		K811	Cylindrical roller and thrust cage assembly (Dimension series 11)		Cage assemblies of aluminum alloy, steel plate (J, JW--), brass (L1), and plastics (T2) are also available
		K812	Cylindrical roller and thrust cage assembly (Dimension series 12)	↑	↑
		K874	Cylindrical roller and thrust cage assembly (Dimension series 74)		Cage assemblies of aluminum alloy for heavy loading
	K893	Cylindrical roller and thrust cage assembly (Dimension series 93)		↑	

Table 2.5 Thrust roller bearings-2

Category	Series code	Bearing name	Appearance	Characteristics	
Thrust roller bearings	Thrust cylindrical roller bearings	CGS	Thrust bearing washer (outer ring)		Inch series
		CWS	Thrust bearing washer (inner ring)	↑	Inch series
		GS 811	Thrust bearing washer (outer ring) (Dimension series 11)		Machined-ring type
		GS 812	Thrust bearing washer (outer ring) (Dimension series 12)	↑	Machined-ring type
		GS 874	Thrust bearing washer (outer ring) (Dimension series 74)	↑	Machined-ring type
		GS 893	Thrust bearing washer (outer ring) (Dimension series 93)	↑	Machined-ring type
		NWC	Thrust bearing washer		Machined-ring type
		NWD	Thrust bearing washer	↑	Machined-ring type
		NWE	Thrust bearing washer	↑	Machined-ring type
		NWF	Thrust bearing washer	↑	Machined-ring type
		WS 811	Thrust bearing washer (inner ring) (Dimension series 11)	↑	Machined-ring type
		WS 812	Thrust bearing washer (inner ring) (Dimension series 12)	↑	Machined-ring type
		WS 874	Thrust bearing washer (inner ring) (Dimension series 74)	↑	Machined-ring type
		WS 893	Thrust bearing washer (inner ring) (Dimension series 93)	↑	Machined-ring type
	XS	Thrust bearing washer	↑	Machined-ring type, Special	
	Other items	ARA821	Double-direction thrust cylindrical roller bearing (Dimension series 21)		Assembly of K811 Series + Central ring (single-bore diameter side is stationary) of WS and GS Series bearing washers
		ARB821	Double-direction thrust cylindrical roller bearing (Dimension series 21)		Assembly of K811 Series + Central ring (single outside diameter side is stationary) of WS and GS Series bearing washers
		ARX	Thrust roller bearings		Special product (needle roller or cylindrical roller) Assembly of bearing, inner ring, outer ring and spacer
		AXA 21	Double-direction thrust needle roller bearing (Dimension series 21)		Assembly of AXK811, WS, and GS Series bearing washers and ZS Series central ring (Single-bore diameter side is stationary.)
		AXB 21	Double-direction thrust needle roller bearing (Dimension series 21)		Assembly of AXK811, WS, and GS Series bearing washers and ZS Series central ring (Single outside diameter side is stationary.)
ZS		Thrust bearing washer (central ring)		Machined-ring type	

Table 2.6 Roller followers

Category	Series code	Bearing name	Appearance	Characteristics
Roller followers	NA22··LL	Roller followers (Sealed type) (Dimension series 22)		With inner ring/cage assembly Prelubricated with standard grease (3A)
	NAB2	Roller followers (Sealed type) (Dimension series 2)		With inner ring/cage assembly (Open type)
	NABR	Roller followers		With inner ring/cage assembly (Equivalent to IKO, NAST)
	NACV··X	Roller followers		Inch series full-complement rollers/non-separable (Equivalent to McGill, CYR) Outside surface of outer ring is cylindrical Prelubricated with standard grease (3A)
	NACV··XLL	Roller followers (Sealed type)		Inch series full-complement rollers/non-separable Outside surface of outer ring is cylindrical Prelubricated with standard grease (3A)
	NATR	Roller followers		With cage and assemblies/non-separable
	NATR··LL	Roller followers (Sealed type)		With cage and assemblies/non-separable Prelubricated with standard grease (3A)
	NATV	Roller followers		Full-complement rollers/non-separable Prelubricated with standard grease (3A)
	NATV··LL	Roller followers (Sealed type)		Full-complement rollers/non-separable Prelubricated with standard grease (3A)
	NUTR2	Roller followers (Dimension series 2)		With double-row cylindrical rollers (Full-complement rollers) / non-separable shield plate Prelubricated with standard grease (3A)
	NUTR3	Roller followers (Dimension series 3)	↑	With double-row cylindrical rollers (Full-complement rollers) / non-separable shield plate Prelubricated with standard grease (3A)
	NUTW2	Roller follower with outer ring and center rib (Dimension series 2)		With double-row cylindrical rollers (Full-complement rollers) / non-separable shield plate Prelubricated with standard grease (3A)
	RNA22··LL	Roller followers (Sealed type) (Dimension series 22)		Without inner ring, with cage and assembly Prelubricated with standard grease (3A)
	RNAB2	Roller followers (Dimension series 2)		Without inner ring (open type), with cage and assembly

Remarks: 1. The external surface of the outer ring is spherical as standard. If a cylindrical outside surface is required, add "X" to the bearing series code.

(Allowance of outside diameter D ; Manufactured to JIS Class 0.)











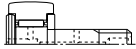

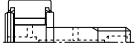
Example: NA2203XLL·····

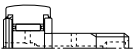
2. The outer surface of the outer ring of the NACV--X(LL) type is cylindrical as standard.

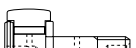
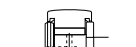
If a spherical outside surface is required, delete the "X" from the bearing series code.

Example: NACV12·····

Table 2.7 Cam follower

Category	Series code	Bearing name	Appearance	Characteristics
Cam follower	CR	Cam follower		Inch series, With cage assembly
	CRV··X	Cam follower		Inch series full-complement rollers Outside surface of outer ring is cylindrical Prelubricated with standard grease (3A)
	CRV··XLL	Cam follower (Sealed type)		↑
	KR	Cam follower		With cage assembly Small-diameter plastic type (with T2) is available
	KR··H	Cam follower (with hexagonal hole)		↑ Shaft end (at head side) with hexagonal hole
	KR··LL	Cam follower (Sealed type)		With cage assembly Prelubricated with standard grease (3A)
	KRT	Cam follower (with tap hole)		With cage assembly
	KRU	Cam follower (Eccentric-shaft type)		With cage assembly Eccentricity: 0.25 to 1.0 mm
	KRV	Cam follower		Full-complement needle roller type Prelubricated with standard grease (3A)
	KRV··LL	Cam follower (Sealed type)		↑
	KRVT	Cam follower (with tap hole)		↑
	KRVU	Cam follower (Eccentric-shaft type)		↑ Eccentricity: 0.25 to 1.0 mm
	KRX	Cam follower		Special
	NUKR	Cam follower		Double-row cylindrical rollers (Full-complement rollers) Prelubricated with standard grease (3A)
	NUKRT	Cam follower (with tap hole)		↑
NUKRU	Cam follower (Eccentric-shaft type)		↑ Eccentricity: 0.4 to 2.5 mm	

Remarks: 1. The external surface of the outer ring is spherical as standard. If a cylindrical outside surface is required, add "X" to the bearing series code.
(Allowance of outside diameter D ; Manufactured to JIS Class 0.)

Example: KR22XLL·····









2. If a spherical outside surface is required for the CRV-X (LL) type, which has a cylindrical outside surface of the outer ring as standard, delete the "X" from the bearing series code.

Example: CRV96·····

3. If a hexagonal hole is required at the shaft end, add "H" to the bearing series code.

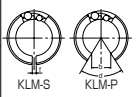
Example: KRV12H·····

Table 2.8 Bearings for linear motion

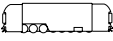
Category	Series code	Bearing name	Appearance	Characteristics	
Bearings for linear motion	Linear ball bearings	KD	Linear ball bearings Stroke type (open type)		High-rigidity, high-accuracy outer ring Limited reciprocating motion
		KD·LL	Linear ball bearings Stroke type (sealed type)		↑ Prelubricated with standard grease (3A)
		KDX	Linear ball bearings		Special
		KH	Linear ball bearings Drawn-cup type		Outer ring of steel plate; lightweight and compact design Ball rows rotate, with unlimited linear motion
		KLM	Linear ball bearings Machined-ring type		High-rigidity, high-accuracy outer ring Ball rows rotate, with unlimited linear motion
		KLM·LL	Linear ball bearings Machined-ring type (Sealed type)		↑ Prelubricated with standard grease (3A)
		KLM·S	Linear ball bearings Machined-ring type (Adjustable-clearance type)		Radial clearance is adjustable
	KLM·P	Linear ball bearings Machined-ring type (open type)		A fan-shaped part of the bearing is removed (in the axial direction) Obstacles such as the shaft support can pass through the bearing	
	Linear flat rollers	BF	Linear flat rollers		Cage and assembly of pressed steel Unit length: 1000 mm
		FF	Linear flat rollers		Molded cage assemblies of polyamide plastic
		FF·ZW	Linear flat rollers (Double-row type)		↑ Cage assemblies can be mounted on the bent-V-shaped surface
		RF	Linear flat rollers		↑ Unit length: 705 mm
	Linear roller bearings	RLM	Linear roller bearings		The row of cylindrical rollers rotates in unlimited linear motion. To mount the bearing, secure the bearing by using the threaded holes provided on the reference surface.

Remarks: The standard lengths of BF and RF Series linear flat rollers are specified.

If a special length is required, add the length after the bearing series code.

Example: If the total length L_1 of BF3020 must be 500 mm, indicate it as BF3020/500.

Table 2.9 Other items, Components-1













Category	Series code	Bearing name	Appearance	Characteristics	
Other items, Components	Bearing rings	IR	Inner ring		Machined-ring type provides high rigidity and high accuracy (Outside surface is used as raceway surface)
		IRJ	Inner ring (Drawn-cup type)		Pressed steel plate
		IRZ	Inner ring		Special specifications (Flange, etc)
		MI	Inner ring		Inch series
		OR	Outer ring		Machined-ring type provides high rigidity and high accuracy (Bore surface is used as raceway surface)
		ORJ	Outer ring (Drawn-cup type)		Pressed steel plate
		ORZ	Outer ring		Special specifications (Key groove, etc)
	Needle rollers	A	Needle roller (A-end face roller)		End face is round
		C	Needle roller (C-end face roller)		End face is pointed
		F	Needle roller (F-end face roller)		End face is flat (the most common roller)
		M	Needle roller (M-end face roller)		End face is stepped
		R	Needle roller (R-end face roller)		End face is spherical
		T	Needle roller (T-end face roller)		End section is conical, End face is flat
		TR	Needle roller (TR-end face roller)		End section is conical, End face is round
	Shafts	KP	Shaft for bearings for linear motion		For linear ball bearings
		NP	Pin		Shafts and various pins with diameters not exceeding 12 mm
		VP	Precision shaft		For use with audio components
		ZP	Pin		Shafts and various pins with diameters exceeding 12 mm

Table 2.9 Other items, Components-2











Category	Series code	Bearing name	Appearance	Characteristics	
Other items, Components	Snap rings	BR	Snap rings (for housing)		Mounted on locating snap ring groove in housing
		BRX	Snap rings (for housing)	↑	Special
		WR	Snap rings (for shaft)		Mounted on locating snap ring groove in shaft
		WRX	Snap rings (for shaft)	↑	Special
	Seals	G	Seals		1-sheet lip Standard rubber material is nitrile rubber (NBR)
		GD	Seals		2-sheet lip
		GSC	Seals		Inch series
		GX	Seals		Special
	One-way clutches	HF	One-way clutches (Drawn-cup type)		Pressed steel plate, torque transmission in one direction Prelubricated with standard grease (L313)
		HFU	One-way clutch unit		Unit with built-in HF Series
		HFL	One-way clutches (Drawn-cup type, with radial bearing)		Bearings are mounted in both sides of clutch This bearing can withstand a constant radial load
		HFLU	One-way clutch unit		Unit with built-in HFL Series
		HFZ	One-way clutches		Inch series
		HFZU	One-way clutch unit		Unit with built-in HFZ Series
		NCU	One-way clutch unit		Unit with plastic gears and pulleys mounted on the circumference of the clutch
		NHF	One-way clutches (Machined-ring type)		BEARFITE oil-retaining bearings are mounted on both sides. This bearing can withstand a constant radial load
		NHFU	One-way clutch unit		Unit with built-in NHF Series
		NHS	Sprag one-way clutch (Machined-ring type)		Assembly of multiple sprags (Torque is transmitted by the inclination of sprags)

Table 2.9 Other items, Components-3











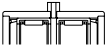



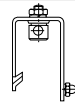





Category	Series code	Bearing name	Appearance	Characteristics	
Other items, Components	Bottom roller bearings for textile machinery	FR	Bottom roller bearing		For draw frames Prelubricated with standard grease (3A) Assembled drawn-cup needle roller bearing
		FRIS	Bottom roller bearing (A-series)		For spinning frames and roving frames Applicable to international standards Prelubricated with standard grease (L113)
		FRIS··SA	Bottom roller bearing (A-series)		Bearing with saddle for securing bearings, separable type
		FRIS··SB	Bottom roller bearing (A-series)	↑	Bearing with saddle for securing bearings, non-separable type
		FRIS··SB	Bottom roller bearing (B-series)		For spinning frames and roving frames, JIS-compatible
		FRIS··NP	Bottom roller bearing (B-series)		Bearing with grease nipple and knock pin
	Tension pulleys for textile machinery	JF··S	Holder		Special holder for JPU··S Series
		JPB	Shaft bearing		Ball bearing unit for JPU··S Series Prelubricated with standard grease (3A)
		JPU··S	Tension Pulley		For spinning, roving and false twisting frames Prelubricated with standard grease (3A)
		JPU··S +JF··S	Tension Pulley (with holder)		Mounts on machine roller carrier with holder bolts
		JPP	Pulley (unit)		Pressed steel plate Press-fit mounting to the outside surface of outer ring for JPU··S Series
	For textile machinery	HKW	Bearing for spindles (Drawn-cup)		For spinning machines
		TEXZ	Bearing for textile machinery		Bearing for textile machinery meets the series standard
	Cross joints	CJ	Machined-ring bearing assembly		Assembly of bearing (CK) and shaft (CL)
		CK	Machined-ring bearing		Machined outer ring With cage assemblies or full-complement rollers
		CL	Cross shaft (spider or cross pin)		Used as a set with CK or HCK Series bearings
		GU	Seal for drawn cup		Used as a set with HCK Series bearings
		HCK	Drawn cup (Closed-end drawn-cup needle roller bearing)		Full-complement rollers, outer ring of steel plate Prelubricated with standard grease (2S)
		HCK..+CL +GU	Drawn-cup assembly		For motor vehicles (Steering and propeller shaft mechanisms)

Table 2.9 Other items, Components-4

Category	Series code	Bearing name	Appearance	Characteristics	
Other items, Components	Rocker arm bearings	RAB	Rocker arm bearings		Full-complement roller-type for motor vehicle engine valve mechanisms
		RJ	Shafts for rocker arm bearings		Shaft for assembly
		RO	Outer ring for rocker arm bearing		Outer ring for assembly
		RS	Side washer for rocker arm bearing		Side washer for assembly
	Cross roller bearings	CRG	Guide roller		Bearing for CRZ Series assembly (outside) Prelubricated with standard grease (8A)
		CRP	Stud		Shaft for Series CRZ assembly
		CRS	Side roller unit		Bearing for Series CRZ assembly (inside) Prelubricated with standard grease (8A)
		CRZ	Cross roller		For truck lifts Assembly, prelubricated with standard grease (8A)
	Other items	BU	Bushing		Special specifications (mainly for spacers)
		HKZ	Drawn-cup needle roller bearing of different shape		Special product using drawn-cup needle roller bearings
		HSF	Bearing for steering		With inner and outer bearing rings of steel plate and steel balls Prelubricated with standard grease (2S)
		HSL	Drawn-cup double-row cylindrical roller bearing		Full-complement roller, for heavy loading, outer ring of steel plate, machined inner ring, prelubricated with standard grease (3A)
		NIP	Grease nipple		For cam followers (Press fitting, mounted with screws)
		SEN	Plug		Grease nipples provided on unlubricated side
		TKBN	Components		Components not meeting standards of needle bearing series
PNA		Self-aligning needle roller and cage assembly bearing		With inner ring. Self-aligning model available	
RPNA		Self-aligning needle roller and cage assembly bearing		Without inner ring. Self-aligning model available	

Tips & Hints

● Thrust roller bearings

Two categories of thrust roller bearings exist: assembled needle roller bearings and assembled cylindrical roller bearings.

They are assembled with bearing washers before use. The cylindrical roller bearing group comprises of a cylindrical roller and thrust cage assembly (K811, K812 and K893 Series), inner ring (WS Series), and outer ring (GS Series); bearings that combine these components are available (811, 812 and 893 Series).

Customers can either purchase an assembled bearing or purchase the components separately and assemble them as required.

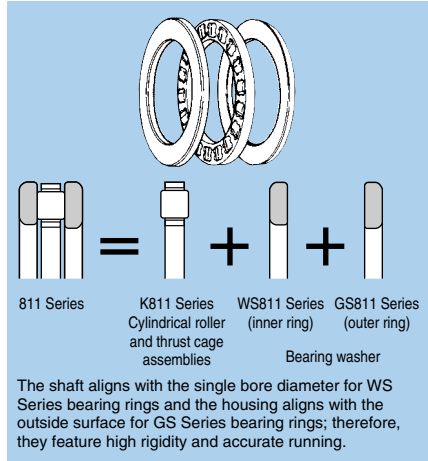

Fig. 1 Assembly example

Bearing assembly	Assembly drawing	Assembly of thrust cage assemblies	Bearing ring (inner ring)	Bearing ring (outer ring)
—		AXK11	AS811	AS811
—		AXK11	WS811	GS811
811		K811	WS811	GS811
812		K812	WS812	GS812
874		K874	WS874	GS874
893		K893	WS893	GS893

● Machined-ring needle roller bearings

Machined-ring needle roller bearings are available in two categories: RNA Series without an inner ring and NA Series with an inner ring. All components are common except the inner ring, as follows.

Example:

RNA4905R+IR25×30×17···/NA4905R

Accordingly, it is possible to purchase the RNA and IR separately and assemble them as needed. Note that the separable RNAO Series without an inner ring and NAO Series with an inner ring have common model numbers, except for the inner ring.

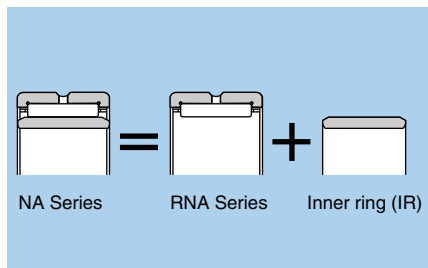

Fig. 2 Assembly example









3. Bearing Selection

Table 3.1 shows the types and characteristics of needle roller bearings.

Needle roller bearings are available in a wide range of varying dimensions. Selecting a particular bearing requires a thorough knowledge of the structure and characteristics

of different bearings and their correct applications. No bearing, no matter how well made, will achieve its full potential if not carefully selected and correctly used. When selecting bearings, consider the following points.

Table 3.1 Classifications and characteristics of bearings

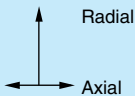
Category		Needle roller and cage assemblies	Needle roller and cage assembly bearing	Separable needle roller and cage assembly bearing	Adjustable-clearance needle roller bearing	Drawn-cup needle roller bearing	Needle roller bearing with thrust ball bearing	Needle roller bearing with thrust cylindrical roller bearing	Needle roller bearing with angular contact ball bearing
Illustration									
Series		K K· ·ZW KMJ PK KBK	NK· ·+IR NK· ·R NA48 NA49R NA59 MR· ·+MI	NAO NAO· ·ZW RNAO RNAO· ·ZW	RNA49· ·S NA49· ·S	HK· ·(+IR) BK· ·(+IR) HMK· ·(+IR) DCL· ·(+MI)	NKX NKX· ·+IR NKX· ·Z NKX· ·Z+IR	NKXR NKXR· ·+IR NKXR· ·Z NKXR· ·Z+IR	NKIA59
Items									
Load	 <p>Radial Axial</p>	↑	↑	↑	↑	↑	↑	↑	↑
Speed	<p>(High speed)</p> <p>Suitable for high-speed use ○ Adequate for high-speed use △ Unsuitable for high-speed use ×</p>	○	○	○	○	△	△	△	○
Accuracy	<p>(High accuracy)</p> <p>Suitable for high-speed use ○ Adequate for high-speed use △ Unsuitable for high-speed use ×</p>	○	○	○	○	×	△	△	△
Mounting practice	<p>Simple ○ Fairly simple △ Difficult ×</p>	△	○	○	△	△	△	△	△
Main application		Transmission engine	All machinery	Construction machinery, Printing machinery, etc.	Construction machinery, etc.	General production machinery	Construction machinery, Gear change machinery, General machinery, etc.	Construction machinery, etc.	Construction machinery, etc.

- (1) The magnitude size, direction, and type of the load that will be applied to the bearing
- (2) The speed and type (rotating inner ring, rotating outer ring) of rotation, and application to vertical or horizontal shafts
- (3) Required bearing life and maximum permissible load
- (4) Ambient temperature conditions around the bearing
- (5) Required accuracy
- (6) Friction and noise levels
- (7) Lubrication and sealing devices
- (8) Bearing mounting and removal
- (9) Materials and finish accuracy of the shaft and housing
- (10) Space available for bearing installation

Needle roller bearing with three-point contact ball bearing	Needle roller bearing with double-direction thrust roller bearing	Thrust roller bearing	Roller follower (Separable)	Roller follower (Non-separable)	Cam follower	Linear flat roller	Machined-ring linear ball bearing (KD Series)	Drawn-cup linear ball bearing	Machined-ring linear ball bearing (KLM Series)	Linear roller bearing
NKIB59	AXN ARN	811 812 893 AXK11 AS WS GS	NA22·LL RNA22·LL	NATR NATV NUTR	KR·(LL) KRV·(LL) NUKR CR	FF FF·ZW BF RF	KD KD·LL	KH	KLM KLM·S KLM·P KLM·(LL)	RLM
Construction machinery, etc.	Pump, Construction machinery, General machinery	General machinery	General machinery	General machinery	General machinery	General production machinery, Construction machinery, etc.	Printing machinery, etc.	General production machinery, Construction machinery, Robots, etc.		

4. Load Rating and Life

4.1 Bearing life

Even in bearings operating under normal conditions, the surfaces of the raceway and rolling elements are constantly subjected to repeated compressive stresses that cause flaking of these surfaces. This flaking is due to material fatigue and eventually causes bearing failure. The effective life of a bearing is normally defined as the total number of revolutions a bearing can undergo before flaking occurs on either the raceway surface or the rolling element surfaces.

4.2 Basic rated life and basic dynamic load rating

If a group of seemingly identical bearings is subjected to identical load and operating conditions, they will exhibit a wide diversity in their durability. This can be attributed to the difference in the fatigue of the bearing material itself. This disparity is statistically monitored, and the basic rated life is expressed as "the total number of revolutions that 90% ('90% reliability') of the bearings in an identical group of bearings subjected to identical operating conditions will attain or surpass before flaking due to material fatigue occurs." For bearings operating at constant fixed speeds, it is expressed as the total number of hours of operation.

The basic dynamic load rating is an expression of the load capacity of a rolling bearing and can be described as the constant load under which a bearing can sustain a basic rated life of one million revolutions. For radial bearings it refers to pure radial loads; for thrust bearings it refers to pure axial loads.

The relationship between the basic rated life, basic dynamic load rating and bearing load is given in formula (4.1).

$$L_{10} = \left(\frac{C}{P}\right)^p \dots\dots\dots (4.1)$$

where,

$p=10/3$ For roller bearings

$p=3$ For ball bearings

L_{10} : Basic rated life of 10^6 revolutions

C : Basic dynamic rated load N {kgf}

Radial bearings: C_r

Thrust bearings: C_a

P : Bearing load N {kgf}

Radial bearings: P_r

Thrust bearings: P_a

The basic rated life can also be expressed in terms of hours of revolution, and is calculated as shown in formula (4.2).

$$L_{10h} = \frac{10^6}{60n} \left(\frac{C}{P}\right)^p \dots\dots\dots (4.2)$$

where,

L_{10h} : Basic rated life h

n : Rotational speed, rpm

4.3 Factors affecting bearing life

Apart from bearing load and revolution speed, the factors affecting bearing life include lubricating conditions, internal clearance, roughness of raceway surface, hardness, heat treatment (structure), and installation errors (misalignment). Consider all these factors when using bearings. For details, refer to the relevant catalog.

Table 4.1 Outline of bearing operating conditions

Permissible revolutions (N)	Refer to catalog values Note: When lubricating, $F_w \cdot n \leq 40 \times 10^4$ rpm F_w : Roller set bore diameter
Roughness of raceway surface	Within 0.4a (Rmax 1.6 μ m)
Hardness of raceway surface	HRC58-64 Note: Refer to Section 6.3 for materials and heat treatment hardness.
Installation error	Less than 1/2 000
Radial internal clearance	Normal (C2, C3, C4)

4. 4 Installation error and crowning

It is well known that bearing life can be dramatically reduced due to stress concentration at the roller ends (edge load) caused by installation error. "Roller crowning" is employed as a countermeasure to this problem. However, this may reduce the effective contact length of the rollers and reduce the bearing life unless a proper design is made. Installation error and loading conditions may require calculation of the proper crowning value. **Figs. 4.1 to 4.3** show

examples of analyses of the contact face pressure according to the computer calculation for reference.

Figs. 4.1 to 4.3 (examples of analyses of contact face pressure) show that the rollers without crowning provide higher edge face pressure, but the rollers with crowning are limited to lower edge face pressure in the range of constant installation error. **Fig. 4.4** shows the relationship (example of computer analysis) between installation error and bearing life. The figure shows the influence of installation errors on the bearing life.

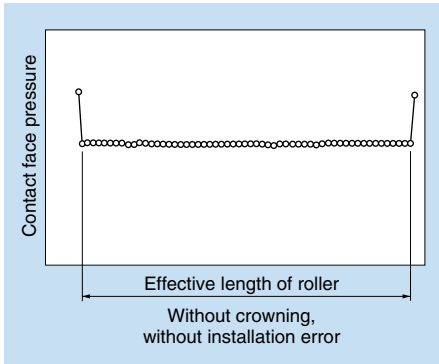

Fig. 4.1

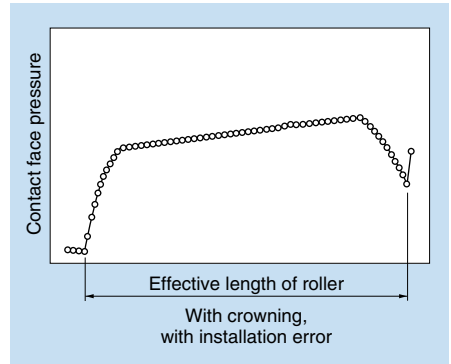

Fig. 4.2

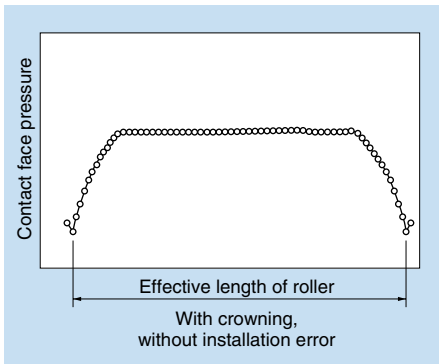

Fig. 4.3

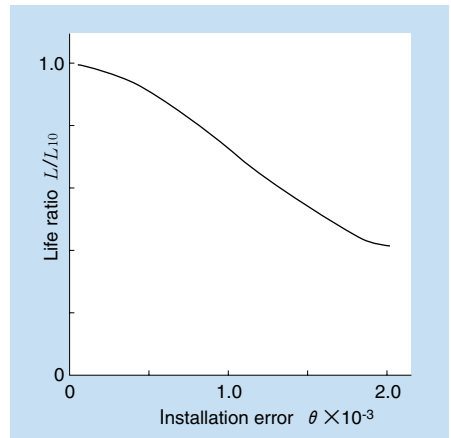

Fig. 4.4 Relationship between installation error and bearing life

4.5 Radial internal clearance, surface roughness, surface hardness and bearing life

Fig. 4.5 shows the relationship between radial internal clearance and bearing life.

Fig. 4.6 shows the relationship between surface roughness and bearing life.

Fig. 4.7 shows the relationship between surface hardness and bearing life.

The following figures show factors affecting bearing life.

4.6 Tips for longer bearing life

To increase the life of needle roller bearings, special heat treatment (AS treatment) has been applied to double or even triple the life compared to the standard product, as determined by bench tests. Moreover, a high oil-film formation capability has been achieved through a recently developed surface-processing technology known as the HL process. As a result, a longer life effect is observed in the areas where surface damage at starting points easily occurs. This development has been well received in the market. For details, refer to catalogs and references.

4.7 Basic static load rating

When bearings are subjected to loads, they suffer from partial permanent deformation of the contact surface between the rolling elements and the bearing ring. The deformity increases as the load increases, and if this increase in load exceeds certain limits, smooth operation of the bearings is subsequently impaired. Experience has revealed that a total permanent deformity of 0.0001 times the diameter of the rolling element -- occurring at the center of the most

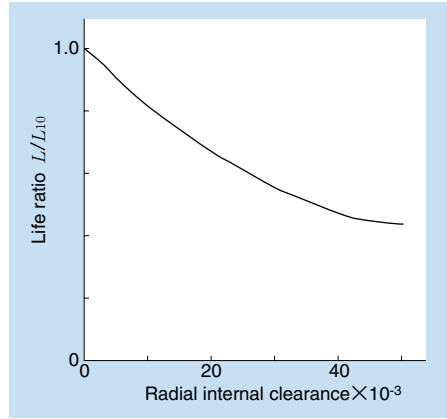

Fig. 4.5 Relationship between radial internal clearance and bearing life

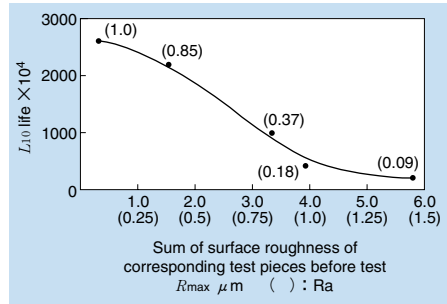

Fig. 4.6 Relationship between surface roughness and life

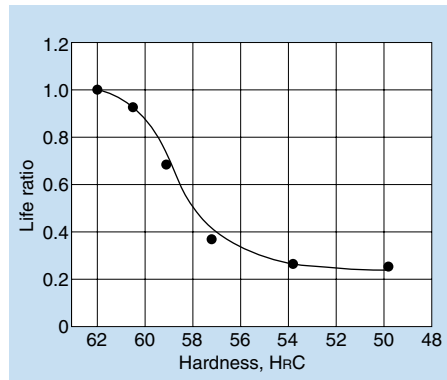

Fig. 4.7 Influence of hardness on rolling fatigue life

heavily stressed contact point between the raceway and the rolling elements -- can be tolerated without any impairment in running efficiency. The basic static load rating refers to the fixed static load limit at which a specified amount of permanent deformation occurs. It represents pure radial loads for radial bearings and pure axial loads for thrust bearings. These values are listed in the bearing dimensions table. They are listed in the C_{or} column for radial bearings and in the C_{oa} column for thrust bearings. The contact stresses occurring at the center of the rolling element and raceway contact points under the maximum load are given below.

- Roller bearings ...4000 MPa (408 kgf/mm²)
- Ball bearings4200 MPa (428 kgf/mm²)

Generally, the permissible static equivalent load is limited by the basic static load rating. However, depending on the requirements for smooth operation and friction of revolution, these limits may be greater or lesser than the basic static rated load.

In the following formula (4.3) and **Table 4.2**, the maximum static equivalent load can be determined with consideration for the safety factor S_o .

$$S_o = \frac{C_o}{P_o \max} \dots\dots\dots (4.3)$$

- where,
- S_o : Safety factor
 - C_o : Basic static rated load N {kgf}
 - Radial bearings: C_{or}
 - Thrust bearings: C_{oa}

- $P_o \max$:
 - Maximum static equivalent load N {kgf}
 - Radial bearings: $P_{or \max}$
 - Thrust bearings: $P_{oa \max}$

Table 4.2 Minimum safety factor S_o

Operating conditions	Roller bearing	Ball bearing
Demand for high rotational accuracy	3	2
Demand for normal rotating accuracy (Universal application)	1.5	1

- Remarks 1. For thrust roller bearings using the drawn-cup needle roller bearing and pressed thrust washer, the minimum S_o value should be 3.
2. When vibration and/or shock loads are present, a load factor based on the shock load must be included in the $P_o \max$ value.

5. Fitting Needle Roller Bearings

5.1 Fitting machined-ring radial needle roller bearings

The inner and outer rings of needle roller bearings are separable. Both inner and outer rings can be mounted with a given interference, but in the case of a tight fit, the bearing ring subjected to static loads can be provided with a loose fit, considering the ease

of mounting and removal of the bearing.

Table 5.1 shows the bearing fit according to a given load.

Table 5.2 shows the recommended fits for radial needle roller bearings (machined ring, with inner rings). However, the interference may be reduced due to temperature increase or surface roughness of fitting surfaces. In this case, refer to the relevant catalogs for details.

Table 5.1 Characteristics and fittings of radial loads

Illustration	Rotation type	Load type	Fitting
<p>Static load</p>	<p>Rotating inner ring Stationary outer ring</p>	<p>Rotating inner ring load Stationary outer ring load</p>	<p>Inner ring : Tight fit Outer ring: Loose fit</p>
<p>Unbalanced load</p>	<p>Stationary inner ring Rotating outer ring</p>		
<p>Static load</p>	<p>Stationary inner ring Rotating outer ring</p>	<p>Stationary inner ring load Rotating outer ring load</p>	<p>Inner ring : Loose fit Outer ring: Tight fit</p>
<p>Unbalanced load</p>	<p>Rotating inner ring Stationary outer ring</p>		

Table 5.2 Fitting of needle roller bearings
Table (a) Axial allowance

Conditions			Tolerance range class
Load type	Load size	Shaft diameter d mm	
Rotating inner ring load or indeterminate direction load	Light loads	~ 50	j5
		~ 50	k5
	Normal loads	50~150	m5
		150~	m6
	Heavy loads and shock loads	~150	m6
		150~	n6
Stationary inner ring load	Medium/low revolutions, light loads	All shaft diameters	g6
	General applications		h6
	When high accuracy is required		h5

Table (b) Housing allowance

Conditions		Tolerance range class
Stationary outer ring load	Normal and heavy loads	J7
	Normal load with double split housing	H7
Rotating outer ring load	Light loads	M7
	Normal loads	N7
	Heavy loads and shock loads	P7
Indeterminate loads	Light loads	J7
	Normal loads	K7
	Heavy loads and shock loads	M7
When high rotational accuracy is required with light loads		K6

Remarks: For classifications of light loads, normal loads, and heavy loads, refer to the following values:
 Light load $P_r \leq 0.06C_r$
 Normal load $0.06C_r < P_r \leq 0.12C_r$
 Heavy load $P_r > 0.12C_r$

5.2 Fitting of drawn-cup needle roller bearings

The dimensional accuracy of drawn-cup needle bearings is guaranteed when the standard ring is used because they are designed to correct the deformation by press fitting in the housing hole and their specified dimensional accuracy is assured. Refer to the relevant catalog for the dimensional allowances of roller set bore diameter when press-fitting the standard ring.

Table 5.3 shows the recommended fits of bearings.

Table 5.3 Fitting of housing and shaft

Bearing series	Housing		Shaft	
	Ferric group	Light alloy	Without inner ring	With inner ring
HK, BK	N6 (N7)	R6 (R7)	h5 (h6)	k5 (j6)
HMK, DCL	J6 (J7)	M6 (M7)		
HCK	F7	—	k6	—

The method for examining internal clearance during fitting of drawn-cup needle roller bearings is described on the next page for reference. If the housing material is a light alloy, care should be taken in consideration of reduced interference due to temperature increase.

5.3 Examination of contraction ratio and clearance after mounting

Recommended fits of standard products are listed in catalogs. The calculation method is also provided in detailed examination to be carried out.

1) Calculation of bearing contraction ratio

If a drawn-cup bearing is used, the contraction ratio is calculated as shown in the formula.

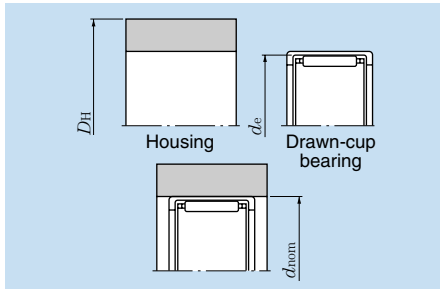

$$\lambda = \frac{2t}{E_2} \cdot \frac{1-S^2}{\frac{0.7S^2+1.3}{E_1}(1-t^2) + \frac{0.7+1.3t^2}{E_2}(1-S^2)} \quad \dots\dots\dots (1)$$

- λ : Outer ring contraction ratio
- D_H : Housing single outside diameter mm
- d_{nom} : Nominal diameter of fitting section mm
- d_e : Diameter of rolling contact surface of the outer ring mm
- E_1 : Young's modulus of housing kgf/mm²
- E_2 : Young's modulus of outer ring (21 200 kgf/mm²)

$$S = \frac{d_{nom}}{D_H} \quad t = \frac{d_e}{d_{nom}}$$

2) Setting bore diameter after fitting the actual housing

① Press fitting of standard ring

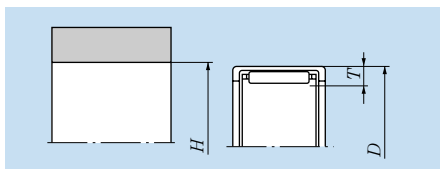

- H : Housing bore diameter mm
- T : Roller diameter + plate thickness mm
- D : Drawn-cup bearing single outside diameter mm
- L_i : Roller set bore diameter after press fitting mm

When the standard ring is press-fit, the dimensions of the roller diameter plus the plate thickness do not change. Accordingly, the roller set bore diameter, L_i , is as follows:

$$L_i = D - 2T - \lambda(D - H) = (1 - \lambda)D - 2T + \lambda H \dots\dots(2)$$

The mean value and standard deviation of the "roller diameter + plate thickness" ($=T$) can be calculated by the formula (2). The mean value given by formula (2) is:

$$mL_i = (1 - \lambda) m_D - m_{2T} + \lambda m_H \dots\dots\dots (3)$$

Standard deviation of formula (2) is:
 $\sigma_{L_i}^2 = (1 - \lambda)^2 \cdot \sigma_D^2 + \sigma_{2T}^2 + \lambda^2 \sigma_H^2 \dots\dots (4)$

In the case of the standard ring, because $\sigma_H^2 = 0$, formula (4) is:

$$\sigma_{L_i}^2 = (1 - \lambda)^2 \cdot \sigma_D^2 + \sigma_{2T}^2 \dots\dots\dots (5)$$

Unknown values in formula (3) and (5) are only m_{2T} and σ_{2T}^2 . Accordingly, substitute known numerical values for (3) and (5) to obtain m_{2T} and σ_{2T}^2 .

② For press fitting of the actual housing, consider the same method as the standard ring press fitting.

Here, terms for press fitting of the actual housing are identified with an apostrophe (') for classification/clarification.

$$mL_i' = (1 - \lambda') m_D - m_{2T} + \lambda' m_H \dots\dots\dots (6)$$

$$\sigma_{L_i'}^2 = (1 - \lambda')^2 \cdot \sigma_D^2 + \sigma_{2T}^2 + \lambda'^2 \sigma_H^2 \dots\dots (7)$$

③ Previously calculated values are substituted for m_{2T} and σ_{2T}^2 in formulas (6) and (7).

④ The roller set bore diameter, L_i' , for press fitting the actual housing can be calculated by the following formula.

$$L_i' = mL_i' \pm 3 \sigma_{L_i'} \dots\dots\dots (8)$$

⑤ To calculate the radial internal clearance, consider the mean value and standard deviation of the shaft in formulas (6) and (7).

⑥ The target value of radial internal clearance is usually set so that the normal clearance can be obtained. However when used for motor vehicles, recommended values are indicated for the respective components. For details, consult NTN.

6. Shaft and Housing Design

6.1 Shaft and housing accuracy

Because the bearing rings of needle roller bearings are so thin, the accuracy of the surfaces of the shaft and housing in which the bearing is mounted has a considerable effect on the accuracy of the raceways.

Under normal conditions of use, a turned finish is adequate for mating surfaces. However, if a heavy load rating, noise reduction, or high precision are required, a ground finish is necessary.

Table 6.1 shows the dimensional accuracy of the fitting face between the shaft and housing, the shape accuracy, the surface roughness, and the shoulder perpendicularity against the fitting face under normal operating conditions.

With split-type housings, if a grinding undercut is made on the inside diameter of the mating surface, distortion of the outer ring is prevented when the housing is assembled.

Table 6.1 Shaft and housing accuracy

Characteristic	Shaft	Housing
Dimensional accuracy	IT6 {IT5}	IT7 {IT6}
Circular deviation (Maximum)	IT3 {IT2}	IT4 {IT3}
Cylindrical deviation		
Shoulder perpendicularity (Maximum)	IT5 {IT4}	IT5 {IT4}
Roughness of fitting surface	0.8a	1.6a

Note: Bearings with an accuracy exceeding Class 5 appear within brackets.

6.2 Raceway accuracy

A shaft and housing are often used directly in place of needle roller bearings with raceways. To regulate the radial internal clearance to the specified allowance and ensure high revolution accuracy, the dimensional accuracy, shape accuracy, and surface roughness of the raceway must be equivalent to that of the raceway surface of the bearing. **Table 6.2** shows the accuracy and surface roughness of the raceway surface.

Table 6.2 Accuracy of raceway surface

Characteristic	Shaft	Housing
Dimensional accuracy	IT5 {IT4}	IT6 {IT5}
Circular deviation (Maximum)	IT3 {IT2}	IT4 {IT3}
Cylindrical deviation		
Shoulder perpendicularity (Maximum)	IT3 {IT2}	IT3 {IT2}
Axial runout (Maximum)		IT5 {IT4}
Thrust bearing		
Surface roughness	Within 0.4a ($R_{\max}1.6 \mu\text{m}$)	

Remarks: Components with high rotational accuracy appear in brackets.

6.3 Raceway materials and their hardness

When the single outside diameter or single bore diameter of a shaft or housing is used in place of a raceway, the surface hardness should be HRC58 to HRC64 in order to maintain sufficient load-bearing capacity. In this case, the types of materials shown in **Table 6.3** should be used following suitable heat treatment.

When raceways have been hardened by carburization or induction, the hardness penetration is defined as the adequate depth of a hardened surface layer with a hardness of HV550 when measured from the surface. The minimum depth of hardness can be calculated according to Formula 6.1.

$$E_{ht} \min \geq 0.8D_w (0.1 + 0.002D_w) \dots\dots (6.1)$$

where,

$E_{ht} \min$: Minimum hardness adequate depth mm

D_w : Roller diameter mm

Table 6.3 Raceway materials and their hardness

Steel type	Code	Standard
High carbon chromium bearing steel	SUJ2	JIS G 4805
Carbon tool steel	SK3	JIS G 4401
Nickel chromium molybdenum steel	SNM420	JIS G 4103
Chromium steel	SCr420	JIS G 4104
Chromium molybdenum steel	SCM420	JIS G 4105
Nickel chromium steel	SNC420	JIS G 4102

7. Tips on Bearing Use

Needle roller and cage assembly bearings have various advantages, yet they also have limitations. Before using these bearings, follow the precautions listed in this section in order to ensure the optimal service life.

(1) Minimal space for lubricant

Although a small cross-sectional bearing height is an advantage, this space includes the cage assembly, which leaves very little room available for the lubricant.

In addition, as the cage assembly is guided by either the inner ring or outer ring, the lubrication of these guiding surfaces must be considered.

Accordingly, except in the case of extremely low speed operation, a lubrication hole must be provided for oil lubrication, or, in the case of grease lubrication, adequate maintenance

must be ensured through rigid scheduling of lubrication intervals.

(2) Axial loads

Except for a partial grouping, needle roller bearings cannot carry axial loads. Axial loads caused by pure radial loads are generally about 3% to 5% of radial loads, and paying attention to the lubricating surface is normally sufficient. However, if the axial loads act expressly on a bearing, consider the use of thrust bearings.

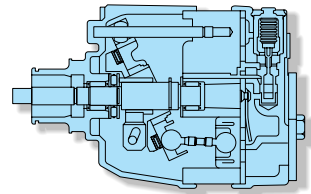

Tips & Hints

● Guide surface in the axial direction

When a needle roller and cage assembly is used alone and is guided in an axial direction at the shaft shoulder (Fig. 7.1), the shaft shoulder surface should have a burr-free, improved finish where it contacts the side face of the cage assembly. In high-speed applications, the contact faces should be hardened and finish-ground. Thrust rings stamped from spring plate with a press are also suitable as axial guides for the cage assembly.

When the cage assembly is guided in an axial direction through the use of a locating snap ring (Fig. 7.1), it is recommended that a thrust ring be used between the cage assembly and locating snap ring so that the cut ends of the locating snap ring do not directly contact the cage assembly.

Generally, when a shaft with a radial needle roller bearing is to be positioned in the axial direction, ball bearings or thrust bearings are used to determine the axial direction. However, when the axial direction load is small and the revolution speed is not high (for example, an

idler gear in a gear box), mount the thrust ring on the shaft and position the thrust ring by striking it against the outer ring or housing shoulder, as shown in Fig. 7.2. In this design, lubrication on the guide surface requires care.

Fig. 7.3 shows an example of a thrust ring with an oil groove processed on the guide surface. This oil groove and the flat part of the shaft must be chamfered and smoothed.

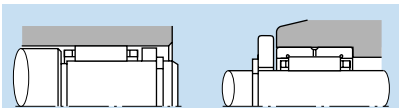

Fig. 7.1

Fig. 7.2

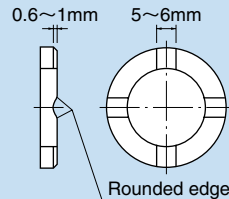

Fig. 7.3 Thrust ring

(3) Shape errors

Needle roller and cage assembly bearings have good accuracy and can be rotated at high speed with small internal clearance. The accuracy of the bearing box of the single outside diameter of the shaft or single bore diameter requires special care, because the shaft or housing shapes directly appear on the raceway surface due to the thin materials used for the inner ring or outer ring.

Regarding general housing accuracy, inferior accuracy is found where differences exist in ribs and material thicknesses.

Care should be taken because needle roller bearings used under such conditions contribute to negative clearances and generate large axial loads or result in heating and seizure.

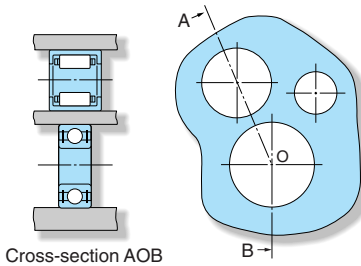

Cross-section AOB

4) Misalignment

Always be careful to keep the axial deflection to less than $1/2\ 000$, as twisting can have a serious effect due to the high rigidity. When the internal clearance is small, or a wide needle roller bearing is used, a particular effort is required to ensure minimal misalignment.

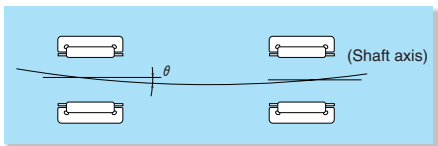

(5) Materials, hardness, and accuracy of the raceway surface

For general bearings, an appropriate bearing steel is used for inner rings, outer rings, and rollers, and a precision finishing process is applied following careful heat treatment. On the other hand, needle roller bearings are also used without inner rings only, or without either inner or outer rings (in other words, the shaft or housing is used in place of raceway surface), to achieve certain advantages.

The basic rated static load listed in catalogs refers to the bearings mentioned above. If the shaft or housing is used in place of a bearing ring, it should comply with the inner and outer rings of the bearing. Consequently, it is necessary to select a flawless steel containing no nonmetals and to produce a surface hardness of HRC 58-64 through careful heat treatment. If only the surface is hardened by carburization, it is recommended that careful attention be paid to ensure that the hardened surface layer has adequate depth and surface hardness.

The roughness of the raceway surface should be in the range of $0.4a$ ($R_{max} \times 16 \mu m$), and there should be no winding along the circumference. The roundness and cylindricity should be less than 50% of the dimensional allowance.

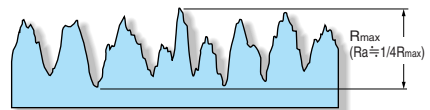

8. Engineering Data

8.1 Track loading capacity of cam followers and roller followers

The track loading capacity is calculated by the relationship between the stress and Hertzian stress by establishing a standard hardness (standard tension stress) with the relationship between the hardness and pure tension stress of the materials. The methods for setting the standard hardness (tension stress) vary slightly by manufacturer, but the accompanying table from the JIS Iron and Steel Handbook (showing approximate values based on the revised conversion table of JIS Z8413) is used to determine the relationship between hardness and tension stress. HRC40 = $\sigma = 127 \text{ kgf/mm}^2$ is adopted as the standard hardness (tension stress).

(1) Track capacity factor

The tension stress of a material increases as the hardness increases; at the same time, the track loading capacity also increases. In this case, the actual track loading capacity can be calculated by multiplying the track loading capacity with the track capacity factors listed in **Table 8.1**.

Note: The calculated track loading capacity shown above is based on the pure tension stress, but not the permissible Hertzian stress. In general, the stress (corresponding force) causing material creep is greater than the tension stress. With static loads in particular, this track loading capacity is considered a safe value.

Example: If the track capacity with a specific hardness is calculated with the track capacity factor:

When the track loading capacity is C_t , the track capacity factor is A at the subject hardness, and the track loading capacity can be found as follows:

$$C_t' = A \cdot C_t$$

For NATR15X, if the hardness is HRC 50:

$$C_t = 1\ 220 \text{ kgf}, A = 1\ 987$$

$$\therefore C_t' = 1\ 987 \times 1\ 220 = 2\ 424 \text{ kgf}$$

(2) References (Calculation of track capacity)

- If the outer ring is cylindrical:

$$\sigma_{\max} = 60.9 \sqrt{\frac{F_r \Sigma \rho}{B_{\text{eff}}}}$$

- If the outer ring is spherical with R:

$$\sigma_{\max} = \frac{187}{\mu \nu} \sqrt[3]{(\Sigma \rho)^2 F_r}$$

where,

$$\sigma_{\max} = 127 \text{ kgf/mm}^2$$

F_r : Track loading capacity (kgf)

$\Sigma \rho$: Sum of curvatures

B_{eff} : Effective contact length (mm)

where (outer ring width - $2 \times$ chamfer)

Table 8.1 Track capacity factor

Hardness HRC	Tension stress kgf/mm ²	Cylindrical outside surface	Spherical outside surface
20	77	0.368	0.223
21	79	0.387	0.241
22	80	0.397	0.250
23	82	0.417	0.269
24	84	0.437	0.289
25	86	0.459	0.311
26	88	0.480	0.333
27	90	0.502	0.356
28	93	0.536	0.393
29	95	0.560	0.419
30	97	0.583	0.446
31	100	0.620	0.488
32	102	0.645	0.518
33	105	0.684	0.565
34	108	0.723	0.615
35	110	0.750	0.650
36	114	0.806	0.723
37	118	0.863	0.802
38	120	0.893	0.844
39	124	0.953	0.931
40	127	1.0	1.0
41	132	1.080	1.123
42	136	1.147	1.228
43	141	1.233	1.369
44	146	1.322	1.519
45	151	1.414	1.681
46	156	1.509	1.853
47	161	1.607	2.037
48	167	1.729	2.274
49	172	1.834	2.484
50	179	1.987	2.800
51	186	2.145	3.141
52	192	2.286	3.455
53	199	2.455	3.847
54	205	2.606	4.206
55	212	2.787	4.652

8. 2 Outer ring strength

Generally, outer rings do not break under normal operating loads, but the following is calculated as a checkpoint for operations under shock loads and heavy loads.

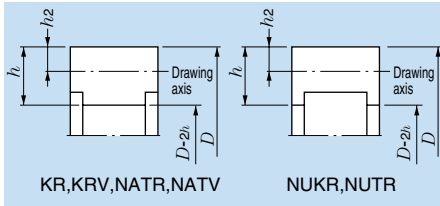

Fig. 8.1

Fig. 8.1 shows outer ring shapes. They are calculated with the following formula. Outer ring breaking strength means the fracture strength of rollers when in a bridge formation.

To determine the fracture strength, generally 180 kgf/mm² can be applied to bearing steel, but we use 120 kgf/mm² as max here in keeping with our own experiences and in consideration of applied concentration. For normal use, the stress is recommended to be less than 20 kgf/mm² and the strength in this case is calculated as follows.

$$P = \frac{4\pi}{1+f(\alpha)} \times \frac{D-2h}{h(D-2h)^2} \times I \times \alpha \quad (\text{kgf})$$

$$f(\alpha) = \frac{(\pi - \alpha) \sin \alpha - (1 + \cos \alpha)}{2 \cos \alpha} \quad (\text{rad.})$$

$$\alpha = \frac{180}{Z} \quad (\text{rad.})$$

where,

I : Outer ring cross-section secondary moment (mm⁴)

Z : Number of rollers

σ : Breaking stress (kgf/mm²)

P : Breaking load (kgf)

※Use special care if a spring washer is used to lock the screws, as this may reduce the stud strength.

8. 3 Stud strength of cam followers

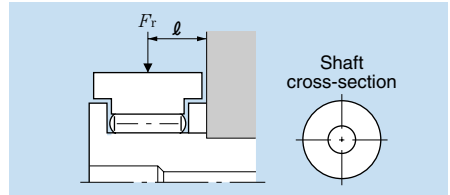

Fig. 8.2

In Fig. 8.2, if the load *F_r* acts at the center of the width of the outer ring, the stud receives the bending moment equivalent to *F_r* × *l*. Tension stress created on the stud surface by this moment is established as σ_1 . Further, the stud itself is tightened with a nut or machine unit, generating tension stress σ_2 .

The sum of the tension stresses $\sigma_1 + \sigma_2$ must not exceed the material allowance. The recommended tightening torque listed in the catalogs is $\sigma_2 \approx 10 \text{ kg/mm}^2$ for most types.

The stud strength is calculated for all types in this section. However, the spring washer is not used in this case*.

- As shown in the figure, loads should act at the center of the outer ring.
- The shaft cross-section should follow the drawing.
- The permissible stress in each case refers to the following items. The tension stress due to tightening is set as $\sigma_2 \approx 10 \text{ kg/mm}^2$.

Static bending stress $\sigma = 140 \text{ kgf/mm}^2$

Repeating bending stress (pulsating)

$\sigma = 100 \text{ kgf/mm}^2$

Repeating bending stress (alternating)

$= 40 \text{ kgf/mm}^2$

$$\sigma_1 = \frac{M}{Z} = \frac{F_r \cdot l}{Z}$$

where,

$$\sigma_1 + \sigma_2 = \sigma$$

Z : Shaft section modulus (mm³)

F_r: Load (Stud strength in kgf)

Calculation/Roller follower NATR, NATV, NUTR

Outside diameter mm	Series	Rated load {kgf}		Track loading capacity {kgf}		Outer ring strength {kgf}	
		C_r	C_{or}	Cylinder	Spherical surface R	Static $\sigma = 120$	$\sigma = 20$
16	NATR5	395	400	350	110	1 210	202
	NATV5	640	910			1 940	325
19	NATR6	460	520	415	141	1 840	305
	NATV6	735	1 140			2 850	470
24	NATR8	675	745	680	193	2 600	430
	NATV8	1 050	1 580			4 200	700
30	NATR10	765	930	785	267	4 900	820
	NATV10	1 190	1 980			7 600	1 270
32	NATR12	865	1 130	835	291	5 200	860
	NATV12	1 280	2 250			8 000	1 330
35	NATR15	1 320	2 050	1 220	325	7 600	1 270
	NATV15	1 830	3 750			11 800	1 970
40	NATR17	1 390	2 250	1 480	390	11 800	1 970
	NATV17	1 930	4 150			18 300	3 050
47	NATR20	2 070	3 350	2 150	480	17 200	2 850
	NATV20	2 900	6 100			26 000	4 350
52	NATR25	2 280	4 000	2 370	565	17 800	2 950
	NATV25	3 150	7 350			28 500	4 750
62	NATR30	3 600	6 550	3 350	710	21 000	3 500
	NATV30	4 750	11 400			31 500	5 200
72	NATR35	3 850	7 600	3 750	820	30 000	5 000
	NATV35	5 200	13 300			45 000	7 500
80	NATR40	4 950	9 150	4 500	1 000	27 500	4 600
	NATV40	6 850	17 100			44 500	7 400
85	NATR45	5 150	9 950	4 800	1 060	28 000	4 650
90	NATR50	5 300	10 700	5 100	1 160	28 500	4 700
	NATV50	7 600	20 400			46 500	7 700
35	NUTR202	2 280	2 620	1 220	325	4 350	730
40	NUTR203	2 450	2 970	1 480	390	8 000	1 340
42	NUTR302	2 280	2 620	1 460	415	10 900	1 820
47	NUTR303	2 450	2 970	1 740	480	16 700	2 800
	NUTR204	3 950	4 900	2 150		9 100	1 520
52	NUTR304	3 950	4 900	2 370	565	15 700	2 600
	NUTR205	4 350	5 850	2 370		10 100	1 680
62	NUTR305	4 350	5 850	2 830	710	25 500	4 250
	NUTR206	5 750	7 400	3 350		12 700	2 120
72	NUTR306	5 750	7 400	3 900	820	29 000	4 800
	NUTR207	6 350	8 700	3 750		19 400	3 250
80	NUTR307	6 350	8 700	4 150	1 000	34 500	5 700
	NUTR208	8 850	12 700	4 500		16 900	2 800
85	NUTR209	9 350	14 000	4 800	1 060	17 800	2 950
90	NUTR308	8 850	12 700	5 100	1 160	35 500	5 900
	NUTR210	9 800	15 300	5 100		18 600	3 100
100	NUTR309	9 350	14 000	5 650	1 330	49 000	8 100
110	NUTR310	9 800	15 300	6 200	1 500	64 000	10 700

Calculation/Cam follower KR, KRV, NUKR

Outside diameter mm	Series	Rated load [kgf]		Track loading capacity [kgf]		Stud strength [kgf]			Outer ring strength [kgf]	
		C_r	C_{or}	Cylinder	Spherical surface R	Static $\sigma = 140$	Pulsating $\sigma = 100$	Alternating $\sigma = 40$	Static $\sigma = 120$	$\sigma = 20$
16	KR16	395	400	350	110	450	315	104	1 210	202
	KRV16	640	910						1 940	325
19	KR19	460	520	415	141	1 070	740	247	1 840	305
	KRV19	735	1 140						2 850	470
22	KR22	515	635	525	172	1 920	1 330	445	2 600	435
	KRV22	810	1 360						3 950	660
26	KR26	515	635	620	216	1 920	1 330	445	5 400	910
	KRV26	810	1 360						8 200	1 370
30	KR30	765	930	785	267	2 850	1 990	660	4 900	820
	KRV30	1 190	1 980						7 600	1 270
32	KR32	765	930	835	291	2 850	1 990	660	6 400	1 070
	KRV32	1 190	1 980						9 900	1 650
35	KR35	1 210	1 760	1 220	325	5 300	3 650	1 220	9 300	1 560
	KRV35	1 750	3 400						14 100	2 360
	NUKR35	2 280	2 620						4 350	730
40	KR40	1 390	2 250	1 480	390	6 900	4 750	1 580	11 800	1 970
	KRV40	1 930	4 150						18 300	3 050
	NUKR40	2 450	2 970						8 000	1 340
47	KR47	2 070	3 350	2 150	480	7 900	5 500	1 830	17 200	2 850
	KRV47	2 890	6 100						26 000	4 350
	NUKR47	3 950	4 900						9 100	1 520
52	KR52	2 070	3 350	2 370	565	7 900	5 500	1 830	25 500	4 250
	KRV52	2 890	6 100						38 500	6 500
	NUKR52	4 350	5 850						10 100	1 680
62	KR62	2 960	5 650	3 500	710	11 500	7 900	2 650	48 000	8 000
	KRV62	3 950	9 850						74 000	12 400
	NUKR62	5 750	7 400						13 400	2 240
72	KR72	2 960	5 650	3 900	820	11 500	7 900	2 650	75 000	12 500
	KRV72	3 950	9 850						116 000	19 400
	NUKR72	6 350	8 700						20 500	3 400
80	KR80	4 500	8 800	5 400	1 000	18 600	12 900	4 300	8 100	13 500
	KRV80	5 800	14 700						121 000	20 200
	NUKR80	10 300	15 400						19 600	3 250
85	KR85	4 500	8 800	5 750	1 060	18 600	12 900	4 300	97 000	16 200
90	KR90	4 500	8 800	6 100	1 160	18 600	12 900	4 300	11 500	19 200
	KRV90	5 800	14 700						17 100	28 500
	NUKR90	10 300	15 400						41 500	6 880
100	NUKR100	12 100	17 000	8 050	1 300	26 000	17 900	6 000	62 000	10 300
120	NUKR120	17 600	27 100	11 500	1 670	35 000	24 700	8 200	90 000	15 000
140	NUKR140	20 500	30 000	15 500	2 040	47 000	32 500	10 900	140 000	22 700
150	NUKR150	26 300	39 000	17 600	2 250	57 000	39 500	13 100	112 000	18 700
160	NUKR160	27 900	41 000	19 800	2 450	68 000	47 000	15 700	127 000	21 100
170	NUKR170	32 500	48 500	22 200	2 650	79 000	55 000	18 200	136 000	22 600
180	NUKR180	37 500	56 500	25 800	2 840	88 000	61 000	20 000	155 000	26 000

8.4 Calculating tightening torque of cam follower

The following relationship exists between the screw tightening torque and tightening force.

$$T = \frac{F}{2} \left\{ (1.15 \mu + \tan \beta) d_2 + \mu_w d_w \right\}$$

where,

- T : Tightening torque
- F : Tightening force
- μ : Friction coefficient
- μ_w : Nut bearing surface coefficient
- β : Lead angle of thread
- d_2 : Effective diameter of thread
- d_w : Effective diameter between the nut bearing surface and mounting hole (with hexagon nut)

Here, $\mu = \mu_w = 0.15$ is assumed.

$$d_2 = 0.92d$$

$$\tan \beta = P / (\pi \cdot d_2)$$

$$d_w = \frac{0.608B^3 - 0.524D_i^3}{0.866B^2 - 0.785D_i^2}$$

where,

- d : Nominal diameter of thread
- P : Thread pitch
- B : Width across flat of nut
- D_i : Mounting hole bore
- $D_i \approx d$ is established.

On the other hand, the relationship between the tightening force and tension stress is expressed as follows:

$$\sigma_2 = \frac{F}{S}$$

- σ_2 : Tension stress
- S : Shaft cross-section area

where, σ_2 refers to the setting according to the cam follower stud strength calculation in Section 8.3.

$$\sigma_2 = 10 \text{ kgf/mm}^2$$

$$F = S \cdot \sigma_2 = S \cdot 10 \text{ \{kgf\}}$$

The tightening torque is as follows:

$$F = \frac{F}{2} \left\{ (0.1725 + \tan \beta) \times 0.92d + 0.15d_w \right\} \times 10^3$$

$$F = \frac{S \cdot 10}{2} \left\{ (0.1725 + \frac{P}{0.92d \cdot \pi}) \times 0.92d + 0.15 \times \frac{0.608B^3 - 0.524d^3}{0.866B^2 - 0.785d^2} \right\} \times 10^3 \text{ \{kgf-m\}}$$

Table 8.2 Calculation of standard cam follower

Series	Calculation		Tightening torque T {kgf-m}		Tightening force F {kgf}	
	KR	KRV	Shaft lubrication hole is taken into account	Shaft lubrication hole is not taken into account	Shaft lubrication hole is taken into account	Shaft lubrication hole is not taken into account
# 16	—	—	0.36	—	—	283
# 19	—	—	0.84	—	—	503
# 22	1.36	1.36	1.62	660	660	785
# 26	1.36	1.36	1.62	660	660	785
# 30	2.05	2.05	2.73	848	848	1 131
# 32	2.05	2.05	2.73	848	848	1 131
# 35	5.33	5.33	6.20	1 728	1 728	2 011
# 40	7.78	7.78	8.75	2 262	2 262	2 545
# 47	10.0	10.0	11.9	2 639	2 639	3 142
# 52	10.0	10.0	11.9	2 639	2 639	3 142
# 62	18.1	18.1	20.4	4 021	4 021	4 524
# 72	18.1	18.1	20.4	4 021	4 021	4 524
# 80	36.9	36.9	39.7	6 566	6 566	7 069
# 85	36.9	36.9	39.7	6 566	6 566	7 069
# 90	36.9	36.9	39.7	6 566	6 566	7 069
# 100	64.7	64.7	68.1	9 676	9 676	10 179
# 120	104	104	108	13 352	13 352	13 854
# 140	157	157	161	17 593	17 593	18 096
# 150	199	199	203	20 735	20 735	21 237
# 160	253	253	258	24 127	24 127	24 630
# 170	310	310	315	27 772	27 772	28 274
# 180	374	374	380	31 667	31 667	32 170

9. Product Introduction & Index

Needle roller and welded cage assemblies with large diameters	44
Full-complement needle roller bearings for sliding seats	46
Bearings for rocker arms	47
Needle roller bearings with solid grease	48
Cam followers/Roller followers with outer ring grooves	49
Roller follower with outer ring with center rib, NUTW	50
Cam followers (with eccentric shaft/tapping hole).....	52
Rubber mold cam followers	53
Cam followers for indexing	54
Drawn-cup needle roller bearings with small diameters	55
Steel leveler backup roll bearing units	56
Thrust bearing integrated with non-separable bearing ring	58
Thrust cylindrical roller and cage assemblies of pressed steel plate (JW)	60
HL roller bearings	62
Triple raceway bearings	64
PK Series needle roller and cage assemblies for general production machinery	65
Cradle bearings	66
Bearings for linear motion (KLM, KD, KH)	67

Needle roller and welded cage assemblies with large diameters



We developed needle bearings for idlers in the transmissions of large vehicles. Conventional welded cage assemblies have been difficult to use in this application.

■ Features

- 1) The use of a plate thicker than the former welded cage assembly improves the strength of the cage assembly.
- 2) Ensures a stable roller guide surface and roller retention.
- 3) For excellent value, bearings are available with a roller set bore diameter of up to 120 mm dia.

■ Structure

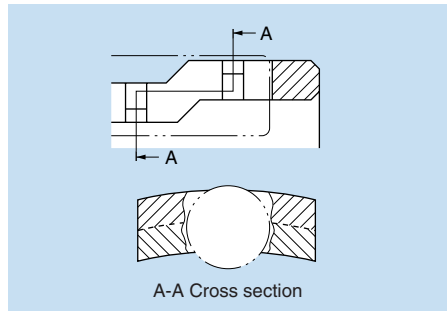

■ Welded cage manufacturing process

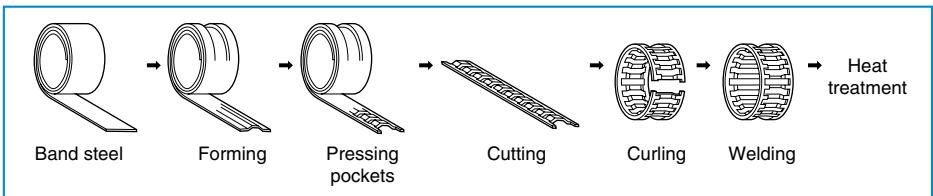

■ Bearing series and characteristics

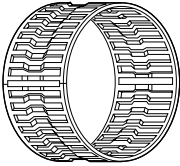
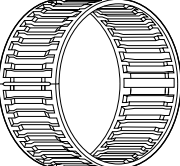
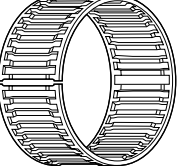
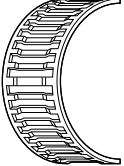
<p>KJ.....S</p>		<ul style="list-style-type: none"> ● Outside diameter guide cage assembly ● Made from thin band steel. ● Accommodates medium-size shaft diameters ranging from 20 to 40 mm dia. ● Used mainly for car-class transmissions.
<p>KV.....S</p>		<ul style="list-style-type: none"> ● Outside diameter guide cage assembly. ● Made from relatively thick steel plate. ● Cage assembly has high-rigidity ring. ● Accommodates large diameters. ● Used mainly for truck-class transmissions. ● Conventional type does not have rollers installed in the welded pocket.
<p>SKV.....S</p>		<ul style="list-style-type: none"> ● KV.....S is temporarily welded, then the weld is separated to create a single-split cage assembly. ● Has anti-fretting feature. (See following chart.)
<p>GKV.....S</p>		<ul style="list-style-type: none"> ● KV.....S is cut apart at almost half its length, and is then bent to form a double-split (half-split) type cage assembly. ● Has anti-fretting feature. (See following chart.)

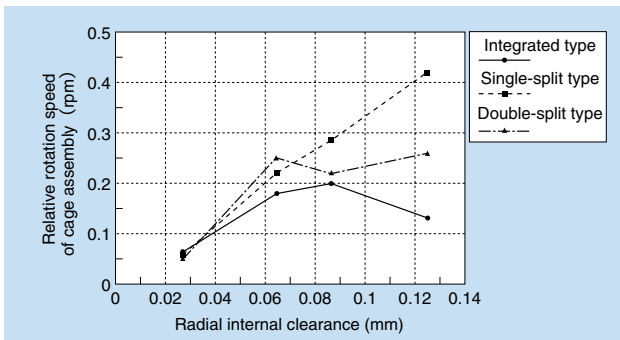

Measured data on the relative rotation speeds according to the difference in cage assembly

Full-complement needle roller bearings for sliding seats



A rolling mechanism is employed to improve the sliding motion of rear seats in minivans.

■ Features

Economical full-complement roller bearings with thick pressed outer ring

- 1) Thick steel plate is applied directly to the outside surface of the pressed outer ring as the rolling surface for the roller follower.
- 2) A new pressing process has been introduced for mating components, so less chamfering of the outside surface of the pressed outer ring is required.
- 3) All press processes are designed for economy.

■ Structure

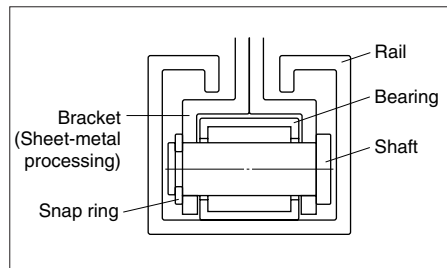

Rail cross section

Bearings for Rocker Arms



Automotive manufacturers, both domestic and international, place the highest priority on the technical issue of improving fuel consumption. One aspect of this commitment has been the aggressive pursuit of low-friction engine design. It has been determined that the friction loss of the valve system is high in the low-speed and middle-speed ranges, which are the most frequently used.

Usually, a sliding mechanism known as the "slipper system" is employed, but the needle roller type has been adopted to improve fuel consumption and performance.

■ Features

A rocker arm bearing rotates in contact with the engine camshaft. The surface roughness of shaft L is usually $R_{max} 2$ to $4 \mu m$ ($Ra 0.5$ to $1 \mu m$), and may cause peeling of the surface of the rocker arm bearing. To prevent this, the HL treatment is standard for NTN rocker arm bearings.

■ Structure

Both ends of the shaft are caulked and fixed with a yoke.

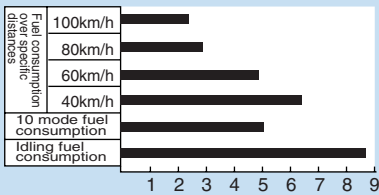

Fuel consumption improvement due to use of needle roller rocker arm

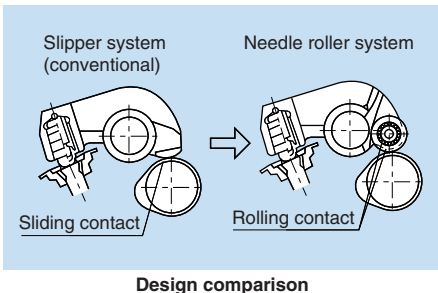
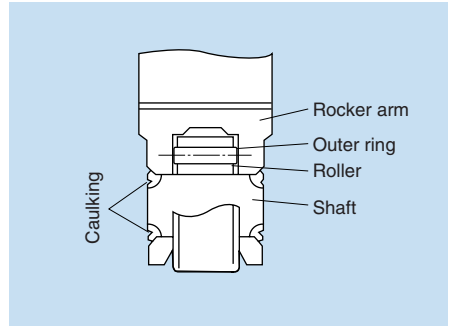

Design comparison

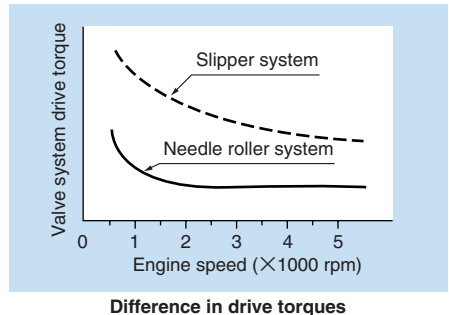

Difference in drive torques

Needle roller bearings with solid grease

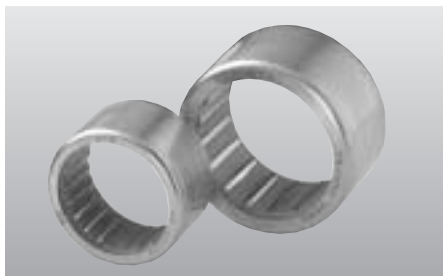

The bearing is prelubricated with thermosetting grease to ensure maximum advantage.

Application

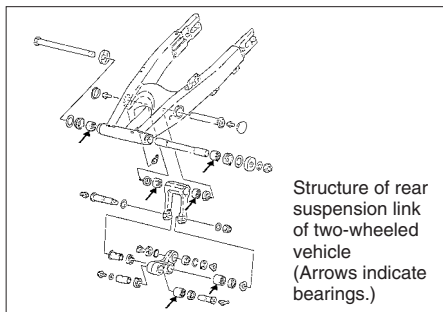

Features

1) Less lubricant leakage

When thermosetting grease is used, oil is gradually supplied to the rolling contact surface through the generation of heat and centrifugal force during operation of the bearing. As a result, there is less oil leakage.

2) Proper lubrication characteristics

The lubricant is unlikely to leak, even if strong vibrations or a large centrifugal force acts on the bearing. The lubricant will not become emulsified or flow out even if water enters.

Lubrication characteristics are superior to the general grease. However, it may get rust if moisture remains in the shaft, or if the bearings are used under the condition to be forced to get water splash on. Accordingly, we recommend you to take sealing measures such as using the additional seal.

Notices for use

Operate the bearing only in an ambient temperature range of -20 to 80°C . For continuous operation, the ambient temperature should not exceed 60°C .

Care should be taken since these bearings cannot be used under the condition that the organic solvents (such as acetone, petroleum-benzene and white kerosene) may splash on.

Table of operation results of solid grease bearings (Extracts)

Reason for selection	Application	Actual bearing (Type)	
No greasing	Sheet printers Sheet printers Sheet printers Sheet printers Sheet printers Packaging machines Mechanical presses Bottling machines Bottling machines Two-wheeled vehicles	Flip-over trunk Claw shaft oscillating parts Register device Transport section Link mechanism Guide roller Rotary Suspension	Machined-ring bearings Cam followers Machined-ring bearings Machined-ring bearings Drawn-cup bearings Machined-ring bearings, cam followers Machined-ring bearings Integrated thrust bearings Full-complement drawn-cup bearings
Protection against grease leakage	Automatic weaving machines Sheet printers Medicine packaging machines Slurry pump Painting machines	Roller with ink Conveyor Crankshaft	Machined-ring bearings Drawn-cup bearings Machined-ring bearings Machined-ring bearings Drawn-cup bearings
Water sealing	Food machines Confectionery machines Food machinery Packaging machines Water jet room Canning machinery Rollers of window-washer	Conveyors Conveyors Cutting roller for kamaboko boiled fish paste Traveling section Guide rollers gondola winch	Machined-ring bearings Roller followers Machined-ring bearings Drawn-cup bearings Drawn-cup bearings Cam followers Drawn-cup bearings
Dust protection	Transferring unit Filling machines Bag-forming machines Presses Steel facilities Ceramic machinery	Conveyors Guide rollers Steering floor guide rollers Conveyors (for special equipment)	Drawn-cup bearings Cam followers Machined-ring bearings Roller followers Cam followers Cam followers

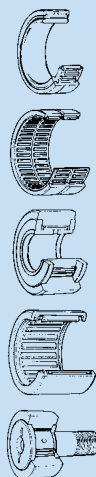

Cam followers/Roller followers with outer ring grooves



Cam followers with outer ring grooves (above) and various roller followers with outer ring grooves (right)



Bearings are provided with grooves on the outside diameter of the outer ring to match the shape of the mating material. These bearings are used as guide rollers. The groove shape can be processed as an R or V shape. Mounting instructions are identical to those of standard bearings.

■ Features

- 1) The R-groove shape can be mirror-finished according to the requirements of the application. (Generally, turning followed by lapping.)
- 2) The basic design accommodates the cam follower standard.
- 3) Easy mounting.
- 4) Can also be used as an economical guide roller for direct drive machines.

■ Applications

- Guide rollers for steel wires and steel pipes
- Leveling rollers
- Rope-gripping devices for winches of window-washing gondolas

■ Example applications of poly-lubricated bearings

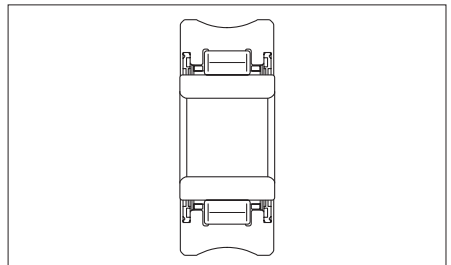
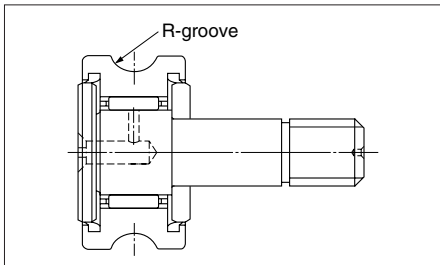
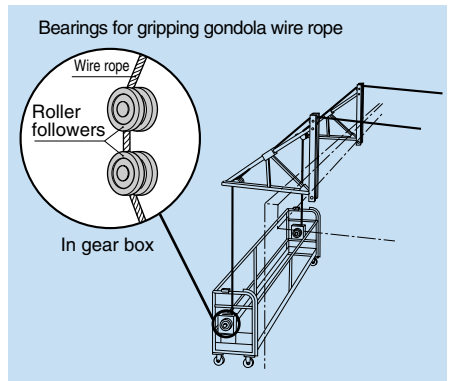

Roller follower with outer ring with center rib



A roller follower with an outer ring with a center rib (**Fig. 1** NUTW Series) comprises

cylindrical rollers, an outer ring, an inner ring, side plates, and shield plates. The outer ring follows a rolling motion on the raceway (track). The outer ring is designed to be thick in order to withstand shock loads, as it operates in direct contact with the track.

In addition to the NUTR Series (**Fig. 2**), which was introduced in a succession of models, the width of the outer ring has been widened, the center rib has been equipped with an outer ring, and the roller follower has been designed to carry larger axial loads. The outside surface of the outer ring is spherical or cylindrical. An outer ring with a spherical surface is effective at easing edge loads due to mounting error.

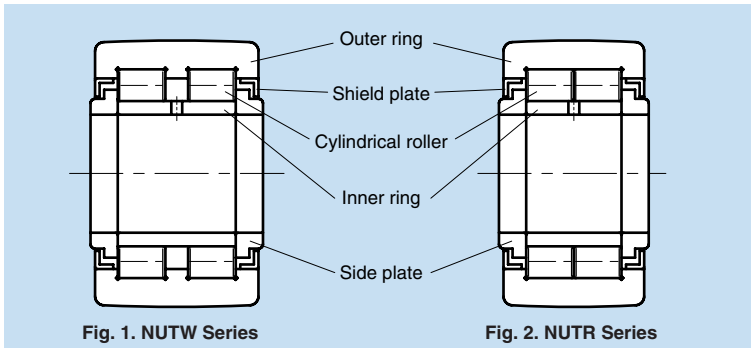

Fig. 1. NUTW Series

Fig. 2. NUTR Series

■ Features

- 1) The outer ring is designed to be thick in order to withstand shock loads.
- 2) The outside surface can have a spherical or cylindrical surface.
- 3) The outer ring is equipped with a center rib, making it effective against axial loads and the moment loading effect.
- 4) Increasing the prelubricated grease capacity increases the lubrication effect and contributes to longer service life.

■ Applications

- 1) Under heavy loads or shock loads
- 2) As a cam mechanism or guide roller for straight and curved lines
- 3) Where moment loads act due to installation errors

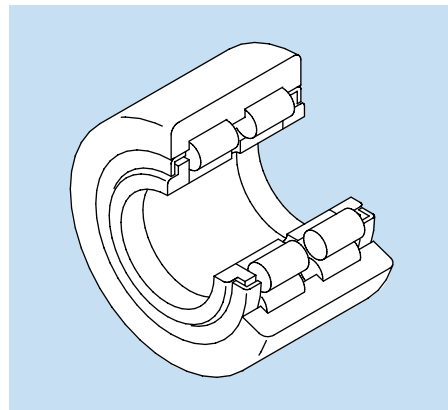

NUTW Series

■ Dimensions

Outside diameter mm D ^① 0 -0.05	Bearing series		Dimensions (mm)						Basic load rating		Mass kg (reference)
	Spherical outer ring	Cylindrical outer ring	d	B	C	e	F_w	r_s min ^②	dynamic C_r (kgf)	static C_{or} (kgf)	
35	NUTW202	NUTW202X	15	22 ⁰ -0.210	21	20	19	0.3	24 100 {2 460}	28 300 {2 880}	0.115
40	NUTW203	NUTW203X	17	24 ⁰ -0.210	23	22	21.5	0.3	26 000 {2 650}	32 000 {3 250}	0.167
47	NUTW204	NUTW204X	20	29 ⁰ -0.210	28	27	25.5	0.3	40 500 {4 150}	51 500 {5 250}	0.280
52	NUTW205	NUTW205X	25	29 ⁰ -0.210	28	31	30	0.3	45 000 {4 600}	61 500 {6 250}	0.322
62	NUTW206	NUTW206X	30	35 ⁰ -0.210	34	38	35	0.3	59 500 {6 050}	77 000 {7 900}	0.549
72	NUTW207	NUTW207X	35	35 ⁰ -0.210	34	44	41.5	0.6	65 000 {6 650}	91 000 {9 250}	0.747
80	NUTW208	NUTW208X	40	38 ⁰ -0.250	36	51	47.5	0.6	90 500 {9 250}	131 000 {13 400}	0.953
85	NUTW209	NUTW209X	45	38 ⁰ -0.250	36	55	52.5	0.6	95 500 {9 750}	144 000 {14 700}	1.03
90	NUTW210	NUTW210X	50	38 ⁰ -0.250	36	60	57	0.6	100 000 {10 200}	158 000 {16 100}	1.11

① For bearings with a cylindrical outside surface, add "X" to the bearing series code. In this case, the allowance of the outside diameter "D" of the outer ring is manufactured according to JIS Class O.

Example: NUTW203X

② This is the permissible minimum of chamfering dimension r .

Standard series of roller followers

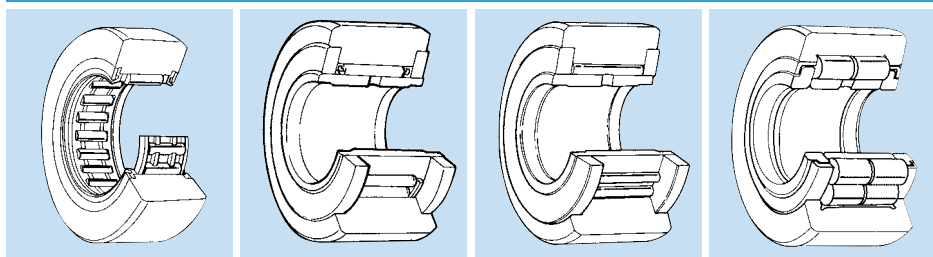

RNA 22 Series
NA 22 Series

NATR Series

NATV Series
NACV Series

NUTR Series

Cam followers (with eccentric shaft/tapping hole)



Adoption of an eccentric shaft provides easy adjustment of the mounting position. As a result, highly accurate mounting hole positioning has become unnecessary. Furthermore, the included threaded grease nipple can be installed at the tapping hole on the stud for easy greasing. It can also be used as a mounting thread for centralized pipelines.

■ Features

- 1) This bearing for outer ring rolling has a thick outer ring and high rigidity.
- 2) Available in three types: needle roller and cage assembly (KRU Series); needle roller without cage assembly (KRVU Series); and double-row cylindrical rollers (NUKRU Series) according to the type of rolling element.
- 3) The outside surface of the outer ring is spherical or cylindrical. The KRU Series and KRVU Series are available with seals. The NUKRU Series is sealed with sealing plates.
- 4) Axial eccentricity is 0.25 to 1.0 mm. This is especially advantageous for level adjustments when many bearings are mounted.
- 5) The driver groove on the flange side and tapping holes at both ends are provided for the stud. Either a screwdriver or hexagon wrench can be used.
- 6) Conventional press-greasing work is

unnecessary because the threaded grease nipple is provided for greasing.

■ Applications

- Construction machinery, packaging machinery, industrial robots, medical appliances
- Transportation equipment at parking garages and automatic warehouses

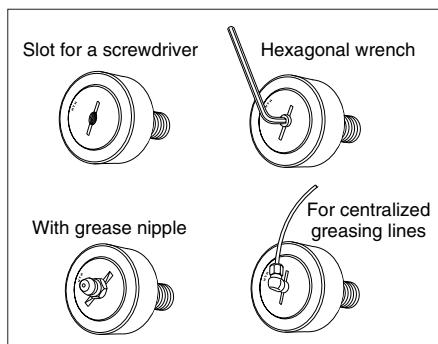

Rubber mold cam followers



These are cam followers with an outer ring whose outside surface is vulcanized and coated with urethane rubber. This provides an effective means of preventing noise and absorbing vibration.

■ Features

- 1) Prevents noise.
- 2) Prevents bearing wear and damage.
- 3) Maintenance-free design
- 4) Easy installation

■ Applications

- Bridle roller guide

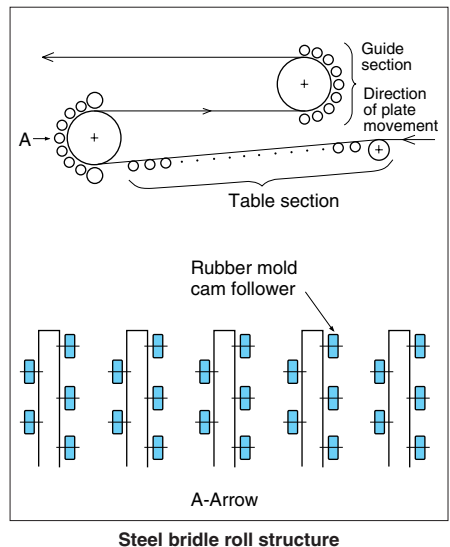
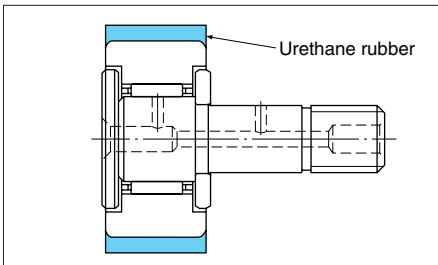

Cam followers for indexing



Automatic machinery performs a variety of movements including intermittent, oscillating and continuous rotation with high accuracy and at high speed. Cam followers are used as the roller cam mechanisms of driving devices.

■ Features

- 1) Provides ample outer ring and stud rigidity in a compact space.
- 2) Full-complement roller design ensures a long service life and larger load-carrying capacity than a roller and cage assembly.
- 3) This cam follower offers precision-class dimensions and rotational accuracy.
- 4) Secured with set screws for easy installation.

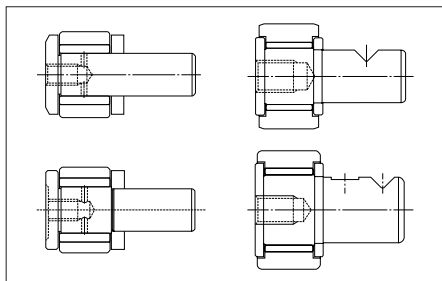

Examples of index cam follower shapes

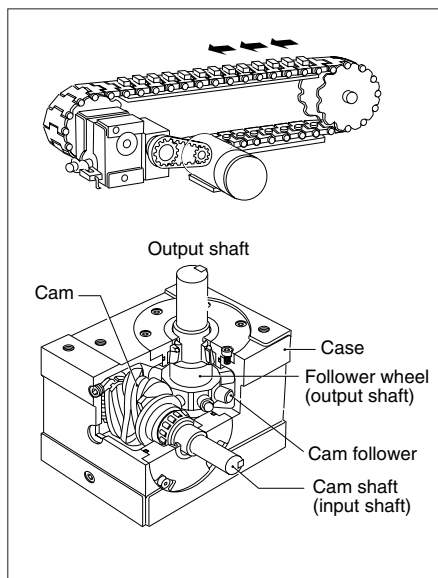

Structure of indexing drive

Small-diameter drawn-cup needle roller bearings



■ Features

The small diameter drawn-cup needle roller bearing has a low section height, is assembled with a cage assembly and rollers, and has a set bore diameter dimension (F_w) less than 10 mm. The outer ring surface is hardened by carburizing following precision deep drawing of the thin band steel.

■ Application

These bearings have a wide range of application thanks to their low section height and compact design.

Printer (timing pulley assembly).

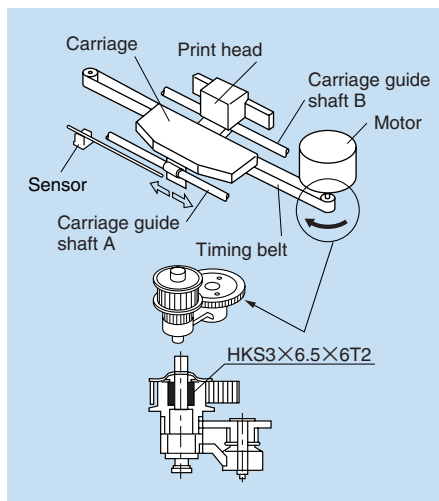

Application: Printer (timing pulley assembly)

Bearing units for steel leveler backup roller



These bearings are used as backup rollers for leveling band steel. They are available in long and narrow models.

■ Structure and advantages of long bearings

This unit is an assembly comprising a roller, shaft, and bearing. The bearing differs with the intended roll operating conditions, but the design has both a needle roller and cage assembly bearing (when carrying radial loads) and a deep-groove ball bearing (for carrying axial loads).

With the sealed type, the deep groove ball bearing seal, rubber seal, and clearances between cover and roller provide a satisfactory seal.

The starting torque and grease prelubrication, as well as the shape, hardness, roughness and rotational accuracy of the roller, meet all the requirements of a backup roller.

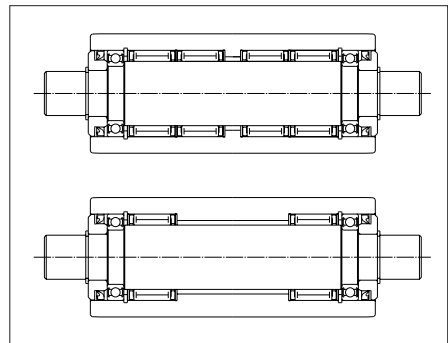

NTN can accommodate specifications other than the above for work rollers or leveler units used as middle rollers. For details, refer to "CAT. No. 2250/J, Large Rolling Bearings."

Structure and advantages of narrow bearings

The outer ring has a thick design in order to provide greater rigidity, as the outside surface of the outer ring is used directly as the raceway surface. These bearings carry larger loads because double-row cylindrical rollers are used as the rolling elements.

The internal rubber seal and external steel seal plates of the sealed type form a labyrinth seal that provides a sufficient sealing effect.

The starting torque and grease prelubrication, as well as the shape, hardness, roughness and rotational accuracy of the roller, meet all the requirements of a backup roller.

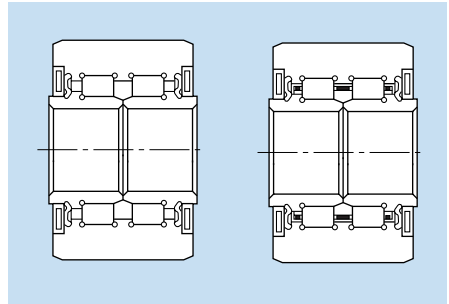

Application

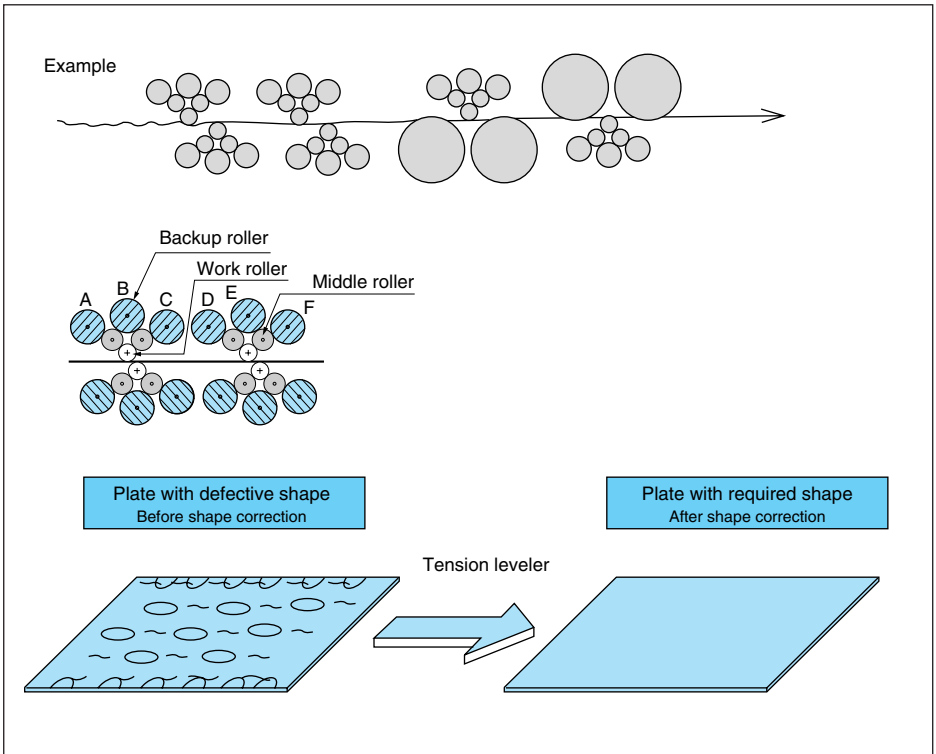

Thrust bearing with integrated non-separable raceway

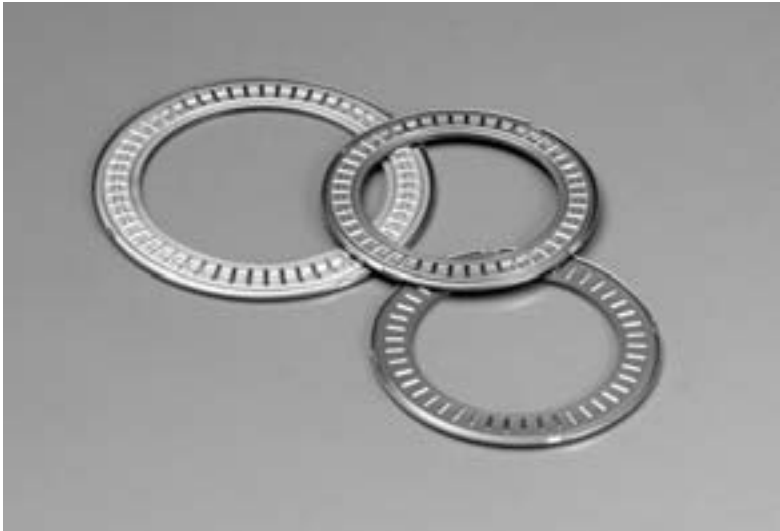

This non-separable thrust bearing is a remodeled separable bearing comprising of a thrust needle roller bearing and bearing ring made of steel plate, with a new structure designed to hold the cage assembly or other bearing ring with the rib of the bearing ring.

■ **Features**

The non-separable type of cage assembly and bearing rings ensures easier handling and fewer assembly steps than the standard thrust needle roller bearing.

■ **Applications**

These bearings are used in automotive transmissions and air conditioner compressors.

9

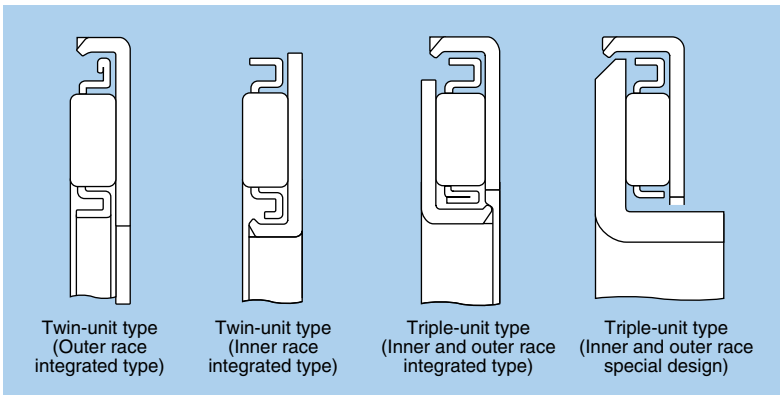

Structure

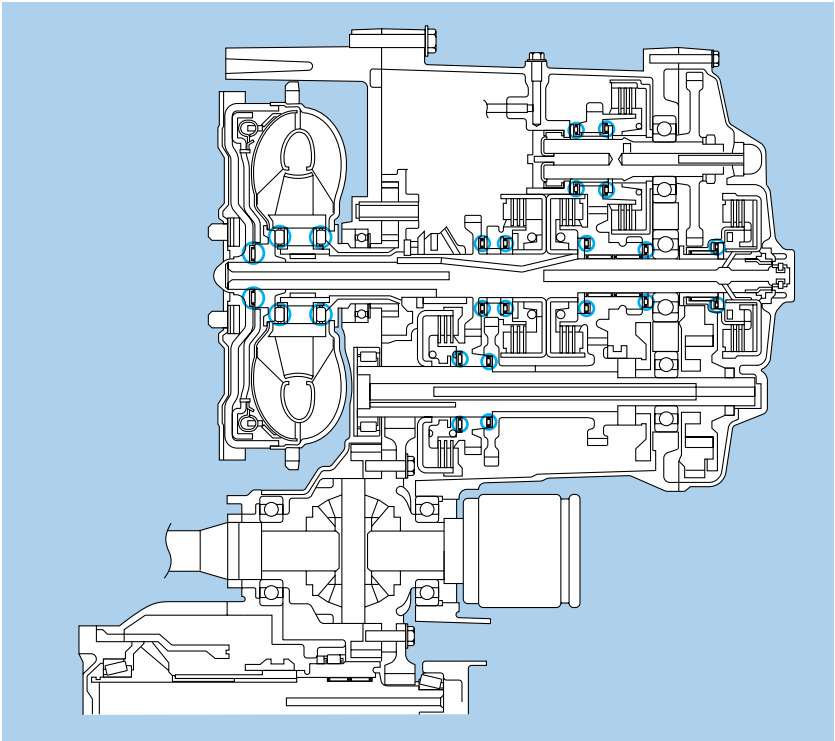

Application example 1: Automatic transmission (Front-mounted engine, front-wheel drive models)

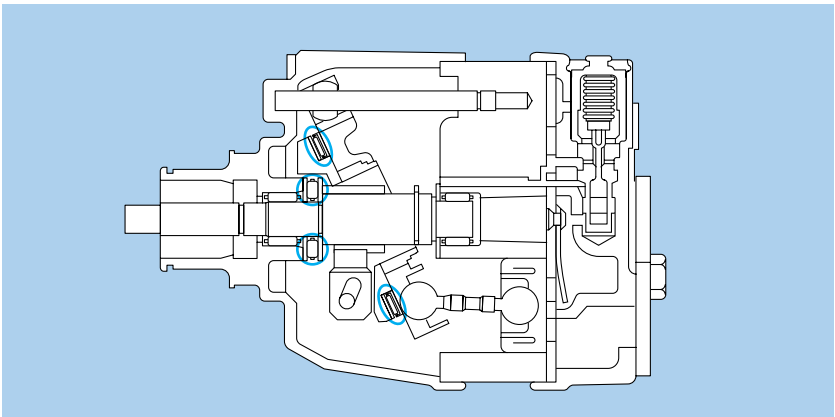

Application example 2: Car air conditioner compressor

Thrust cylindrical roller and cage assemblies (JW) of pressed steel plate



The cage assembly made of pressed steel plate makes for an economical thrust cylindrical roller and cage assembly.

Conventionally, the cage assembly of thrust cylindrical rollers is made of machined aluminum. However, the mass productivity of machined cage assemblies is inferior and their cost is high.

As a result, integrated cage assemblies made of pressed steel plate have been found to provide satisfactory results for the thrust needle rollers of cylindrical roller thrust bearings.

Previously, it was considered difficult to create the pocket shape for W Series cylindrical rollers because of the low ratio of roller length to roller diameter. Now, however, we have succeeded in producing the appropriate shape so that these rollers can be employed in cylindrical roller bearings.

■ Features

- 1) Because steel plate is used for the cage assembly and the rollers are manufactured by press forming, mass productivity is excellent.
- 2) The use of steel plate for these rollers allows for a variety of heat treatments and surface treatments.

- 3) Because it is possible to narrow the width of the pillar as well as the distance between the bore diameter/outside diameter and pocket end, the rated capacity of a given size can be increased by increasing the roller length and the number of rollers.

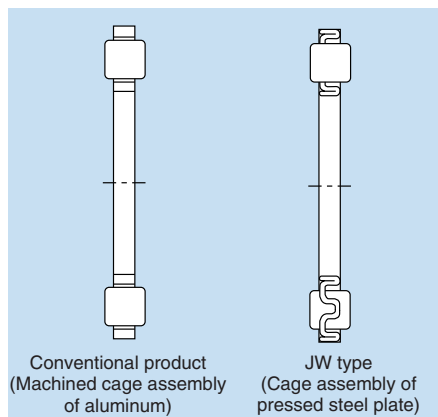

■ Name

K811 · · JW

K812 · · JW

Cage assembly of steel plate (Series JW)

■ Dimensions

Bearing series	Bore diameter <i>D</i> _{et} E11	Outside diameter <i>D</i> _e c12	Roller diameter <i>D</i> _w -0.010	Basic rating load			
				<i>C</i> _a N {kgf}		<i>C</i> _{0a} N {kgf}	
K81100JW	10	24	3.5	11 000	{1 120}	21 500	{2 190}
K81101JW	12	26	3.5	11 600	{1 180}	23 900	{2 430}
K81102JW	15	28	3.5	12 900	{1 320}	28 600	{2 920}
K81103JW	17	30	3.5	13 500	{1 370}	31 000	{3 150}
K81104JW	20	35	4.5	20 300	{2 070}	46 500	{4 700}
K81105JW	25	42	5	27 500	{2 800}	68 000	{6 900}
K81106JW	30	47	5	28 000	{2 860}	72 500	{7 400}
K81107JW	35	52	5	31 000	{3 200}	87 000	{8 900}
K81108JW	40	60	6	43 000	{4 400}	121 000	{12 400}
K81109JW	45	65	6	45 500	{4 650}	135 000	{13 800}
K81110JW	50	70	6	48 500	{4 900}	150 000	{15 300}
K81111JW	55	78	6	64 500	{6 600}	225 000	{22 900}
K81112JW	60	85	7.5	71 500	{7 300}	225 000	{23 000}
K81113JW	65	90	7.5	75 500	{7 700}	247 000	{25 200}
K81114JW	70	95	7.5	79 000	{8 050}	268 000	{27 300}
K81115JW	75	100	7.5	80 500	{8 200}	279 000	{27 400}
K81116JW	80	105	7.5	81 500	{8 350}	290 000	{29 500}
K81117JW	85	110	7.5	85 000	{8 700}	310 000	{31 500}
K81118JW	90	120	9	118 000	{12 000}	430 000	{43 500}
K81206JW	30	52	7.5	53 500	{5 450}	129 000	{13 100}
K81207JW	35	62	7.5	57 500	{5 850}	150 000	{15 300}
K81208JW	40	68	9	74 500	{7 600}	190 000	{19 400}
K81209JW	45	73	9	82 000	{8 400}	222 000	{22 600}
K81210JW	50	78	9	85 000	{8 650}	238 000	{24 200}
K81211JW	55	90	11	121 000	{12 400}	340 000	{34 500}
K81212JW	60	95	11	126 000	{12 800}	365 000	{37 000}
K81213JW	65	100	11	130 000	{13 300}	385 000	{39 500}
K81214JW	70	105	11	134 000	{13 700}	410 000	{42 000}
K81215JW	75	110	11	139 000	{14 100}	435 000	{44 500}
K81216JW	80	115	11	143 000	{14 500}	460 000	{47 000}



Application: Riding mower

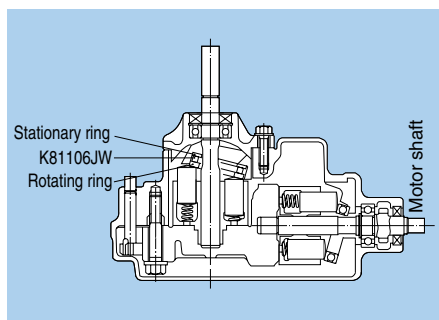

Bearing assembly structure

HL roller bearings



■ Features

If the shaft or housing is used as the raceway surface of a needle roller bearing, in place of an inner ring or outer ring, the bearing will tend to have a short operating life because of a lack of lubricant film caused by the difference in surface roughness between the rollers and mating components (mainly the shaft).

NTN has developed a surface processing method through which a sufficiently thick oil film is maintained under these operating

conditions. This method changes the orientation of the surface roughness according to the Micro EHL Theory.

These bearings are called HL (High Lubrication) roller bearings.

A HL surface has no orientation because, as shown in **Fig. 1**, the surface has a large number of minute dimples of more than $10\ \mu\text{m}$ to provide a roughness wave form in the axial and circumference directions. The depth of the dimples is approximately $1\ \mu\text{m}$.

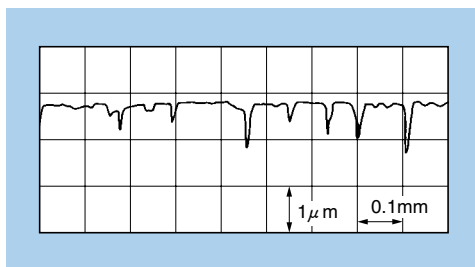

Fig. 1 Roughness of HL surface

To confirm the capacity of a HL surface to form an oil film, we compared the oil-film formation capacity of the HL surface with that of a super-finish surface with the 2-cylinder test unit. **Fig. 2** shows the results, which confirm that the HL surface has a greater oil-film formation capacity.

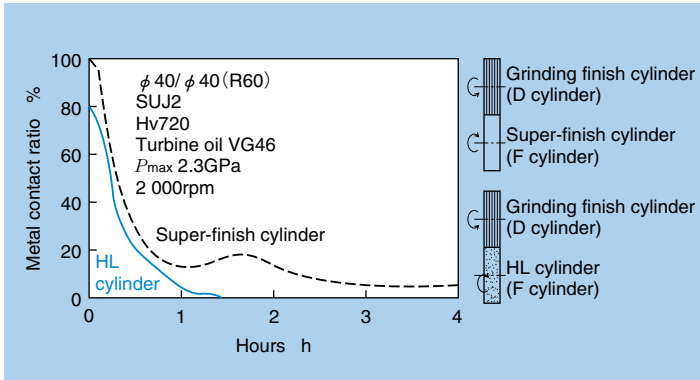

Fig. 2 Metal contact ratio of HL surface

■ Application

The superior oil-film formation capacity enables these roller bearings to achieve optimal performance under severe lubricating conditions, as shown below. Moreover, protection against peeling and an extended service life can be expected. The HL surface can also be applied effectively to bearing rings other than roller bearings.

- Travel speed reducers for construction machinery
- Various types of transmissions
- Engine roller rocker arm
- Hydraulic pumps

Triple raceway bearings



These needle roller bearings contribute to high-quality printing and easier maintenance.

■ Features

These needle roller bearings boast high-accuracy rotation and dimensions. The adoption of the needle roller bearing design ensures a bearing section with a simple structure and compact design. Assembly and adjustment are simplified and stable, long-term rotation is assured.

■ Applications

- Offset sheet printing machine
Blanket cylinder (with rubber trunk)
- Maximum speed: 15,000 sheets/hour

■ Structure

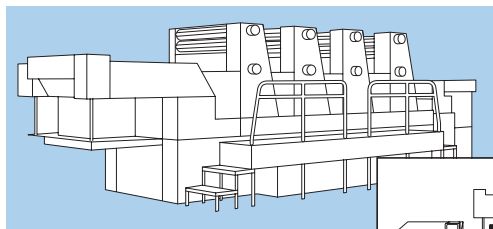
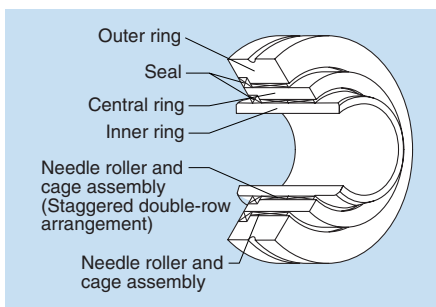

▲4-color machine

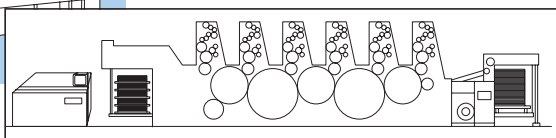

▼6-color machine

PK Series needle roller and cage assemblies for general production machinery



■ Features

The cage assembly features an outside diameter guide structure, which has the same structure and rigidity as the cage assembly for the connecting rod. It is designed for a high loading capacity within the limits of the available space. The cage assembly is of carburized steel, and appropriate heat treatment ensures sufficient strength.

■ Applications

These bearings are widely used in construction machinery, agricultural machinery, hydraulic equipment and the steel industry.

Often, numerous needle roller bearings are used in the planetary gear speed-reduction mechanism for construction machinery. In particular, PK Series roller and cage assemblies are in wide use.

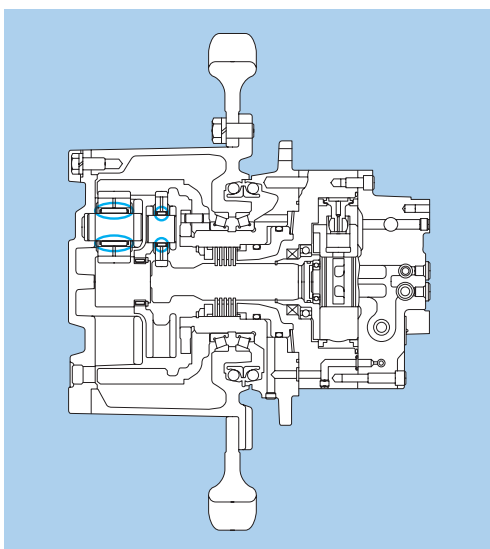

Application: Planetary gear speed reduction mechanism for construction machinery

Cradle bearings



In recent years, the use of an arc-shaped rolling bearing behind the swash plate, instead of the conventional trunnion system and sliding contact system, has been considered for the variable mechanism of the variable capacity plunger pump motor. Application of this system allows the bearing to carry larger loads in a smaller space. It also solves the problem of friction on the sliding

surfaces of the sliding system. In addition, the reduction of oscillating resistance improves response.

Types

The needle roller and cage assembly of these bearings is split (usually into 3 parts) along its circumference. Many bearings have a split outer ring. The single-rib type and double-rib type are shown in the figure.

Application

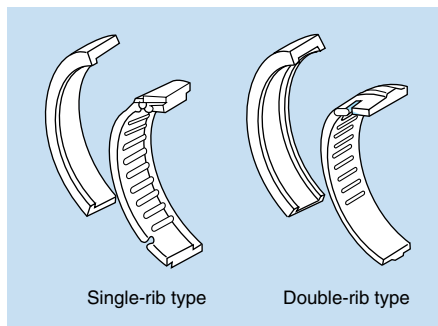
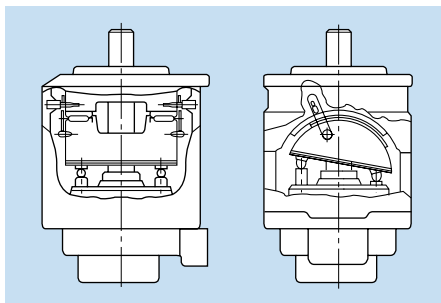

Bearings for linear motion (KLM, KD, KH)



■ Features

These rolling bearings use steel balls and exhibit excellent friction and motion characteristics compared to sliding bearings. With their easy handling and compact size, they are widely used in applications where stroke movement is required.

With the standard KLM and KH Series, the row of balls rotates to provide unlimited linear motion along the shaft. The outer ring of the KH Series is the drawn-cup type and offers a smaller cross-section. This series is more economical than the KLM Series.

With the KD Series, the equally distributed ball rows in the axial direction reciprocate in limited linear motion along the shaft without rotating.

■ Application

These bearings are used for sliding parts of office appliances or construction machinery. Bearings can be selected according to their specifications (shaft diameter and stroke length).

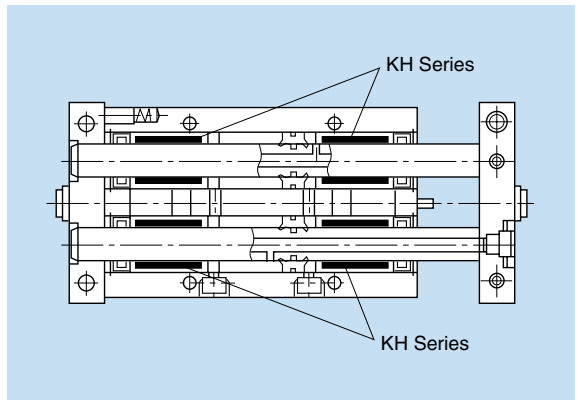

Application: Work transferring slide unit

10. Nominal number

A nominal number of a bearing expresses the type, dimensions, accuracy and internal structure of the bearing and is composed of the basic number and supplemental code.

Table 10.1 shows the nominal number composition. **Table 10.2** also shows the arrangement order of nominal numbers.

Table 10.1-1 Nominal number composition (Prefix supplemental code, basic number)

Prefix supplemental code Special application, material, heat treatment	Basic number			
	Bearing name	Series code	Dimension code or dimension group code+inner diameter number	
E-Bearings using carbonized steel	Needle roller and cage assemblies bearing	K, KJ, KMJ, PCJ, PK, KBK	$F_w \times E_w \times B_c$ (Bore diameter \times Outside diameter \times Width)	
F-Bearings using stainless steel	Drawn-cup needle roller bearing	HK, HMK, BK	$F_w \cdot C$ (Bore diameter / Width)	
		DCL	$F_w^* \cdot C^*$ (Inch series: Bore diameter / Width)	
C-Bearings using carbon steel	Machined-ring needle roller bearing	RNA, NA	5~9 (Inner diameter: ϕ 5~9) 00~03 (Inner diameter: ϕ 10, 12, 15, 17) / 22, 28, 32 (Inner diameter: ϕ 22, 28, 32) 04~88 (Inner diameter: ϕ 20~440)	
M-Bearings with plating process		NK (+IR), RNAO, NAO	F_w / C (Bore diameter / Width) F_w (or d) \times D \times C (Bore diameter or Inner diameter \times Outer diameter \times Width)	
HL-Bearings using HL rollers refer to pg. 62		MR (+MI)	$F_w^* \cdot D^* \cdot C^*$ (Inch series: Bore diameter / Outer diameter / Width)	
8Q-Bearings with cage assemblies treated by soft-nitriding	Thrust roller bearing	AXK, AS, W58, GS8, K8, 8	11 11, 12, 93 11, 12, 93	00~03 (Inner diameter: ϕ 10, 12, 15, 17) 04~32 (Inner diameter: ϕ 20~160)
TS2-Bearings for high temperature up to 160°C treated by the dimension stabilization.	Compound bearing	NKX (+IR) NKXR (+IR)	F_w (Bore diameter)	
		NKIA NKIB	59	02, 03, /22 (Inner diameter: ϕ 15, 17, 22) 04~14 (Inner diameter: ϕ 20~70)
		AXN, ARN	$d \cdot D$ (Inner diameter / Outer diameter)	
TS3-Bearings for high temperature up to 200°C treated by the dimension stabilization.	Roller follower	RNA, NA	22	/ 6, 8 (Inner diameter: ϕ 6, 8) 00~03 (Inner diameter: ϕ 10, 12, 15, 17) 04~10 (Inner diameter: ϕ 20~50)
		NATR, NATV	$d \cdot D$ (Inner diameter / Outer diameter)	
		NACV	$d^* \cdot D^*$ (Inch series: Inner diameter / Outer diameter)	
TS4-Bearings for high temperature up to 250°C treated by the dimension stabilization.	Cam follower	KR, KRV, KRU, KRVU, NUKR	D (Outer diameter)	
		CRV	D^* Inch series: (Inner diameter / Outer diameter)	
		IR MI A, F WR, BR G, GD	$d \times F \times B$ (Inner diameter \times Raceway diameter \times Width) $d^* \cdot F^* \cdot B^*$ (Inch series: Inner diameter \times Raceway diameter \times Width) $D_w \times L_w$ (Diameter \times Length) d_1 (Shaft diameter or Hole diameter) $d \times D \times b$ (Inner diameter \times Outer diameter \times Width)	
Bearing for linear motion	KLM KH KD RLM FF RF, BF	F_w (Bore diameter)		
		$F_w \cdot C$ (Bore diameter / Width)		
		$F_w \cdot D \cdot C$ (Bore diameter / Outer diameter / Width)		
		$H \times L$ (Height \times Length)		
		$D_w \cdot b$ (or B) (Diameter \times 10 / Width) $D_w \cdot b / L_1$ (Diameter \times 10 / Width/Length)		
One-way clutches	HF NHf, NCU	$F_w \cdot C$ (Bore diameter / Width)		
		F_w (Bore diameter)		

Table 10.1-2 Nominal number composition (Suffix supplemental code)

Suffix supplemental code								
Internal change code	Cage assemblies code	Seal, shield code	Raceway shape code	Combination code	Internal clearance code	Accuracy code	Lubricant code	Special code
ZW: Double-row cage assemblies	L1: High strength brass machined cage	L: With the synthetic rubber seal on one side (contact type)	N: Locating snap ring with groove	D2, Dn: Combination of same bearings more than two pieces	C2: Narrower than the usual clearance	P6: JIS Class 6	/2A: Albania 2	V1 to Vn: Special specifications, requirements
A, B, C: Internal structure change	F1: Carbon steel machined cage	LL: With the synthetic rubber seals on both sides (contact type)	NR: With the locating snap ring	+ α : With the spacer (α is expressed by the width dimension of spacer.)	(CN) Usual clearance	P5: JIS Class 5	/3A: Albania 3	
R: Outer ring with double ribs	J, JW: Steel plate pressed cage		D: With lubrication holes		C3: Wider than the usual clearance	P4: JIS Class 4	/8A: Albania EP2	
X: Outer ring outside surface of the cam follower and roller follower is cylindrical.	T2: Plastic mold cage		DO: Without lubrication holes and oil groove		C4: Wider than the C3 clearance	PX1 to PXn: Special dimension tolerance	/5K: Martemp SRL	
	L3: Aluminum alloy cage		H: Cam follower with the hexagonal hole				/LP03: Heat hardening type grease (solid grease)	
	S: Welded cage		S: Clearance adjusting type					

Table 10.2 Arrangement of nominal numbers

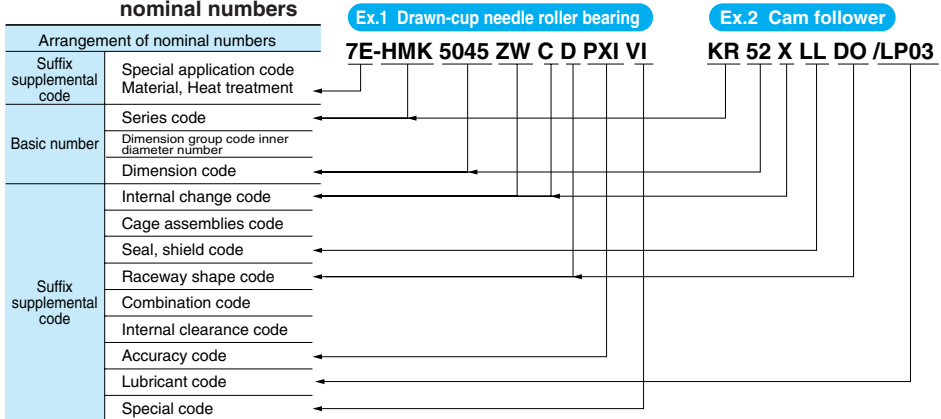

Remarks:

- Contact NTN about the basic number, prefix or suffix supplemental codes other than the list.
- Soft nitriding treatment is the standard specification for the welded cage assemblies and the prefix supplemental code (8Q-) should be omitted.
- If the prelubricated grease is standardized per the bearing type and product type, the grease code should be omitted.
- If the special code (Vn) is used, Vn includes the material, heat treatment and lubrication code, but the internal change code such as prefix supplemental code HL- and ABC, S (welded cage assemblies), seals, locating snap rings, H (with hexagonal hole) combination codes and precision codes are not included in Vn but described.

Comparison of Bearing Series by Manufacturer ● Needle roller and cage assemblies/Machined-ring needle roller bearings

		NTN	INA	TORRINGTON	NSK	IKO	KOYO	THK	NADELLA	SKF	Mc,GILL
Needle roller and cage assemblies	mm	K K·ZW KMJ RK KBK	K K·ZW KZK KBK	FWJ FWJ	FWJ FDJ FWJ FWF FBN	KT FTW KT KT·EG KTV·EG	R,RS WR,WRS R,RS,V,VS VS,VS·P R·P,UR·P		B BB B	K K·ZW KZK KBK	
	inch	PCJ	C	WJ	WJ						
Machined-ring needle roller bearings	mm	NK NK+IR NK·R NK·R+IR RNA49 NA49 RNA·R NA49·R RNA49·L,LL NA49·L,LL RNA59 NA59 RNA69 NA69 RNA48 NA48 RNAO NAO RNAO·ZW NAO·ZW NKS NKS+IR RNA49·S NA49·S RPNA·R PNA·R IR	NK NKI NK NKI RNA49 NA49 RNA49·RS,2RS NA49·RS,2RS RNA69 NA69 RNA48 NA48 RNAO NAO RNAO NAO NKIS NKIS RNA49·S NA49·S RPNA PNA IR		(RLM)	RNA49 NA49 RNA59 NA59 RNA69 NA69 RNA69·U,UU NA69·U,UU RNA48 NA48 RNAF NAF RNAFW NAFW	RNA49 NA49 RNA49·U,UU NA49·U,UU RNA59 NA59 RNA69 NA69 RNA48 NA48 RNAF NAF RNAFW NAFW IRT	RNA49 NA49 RNA49·UU NA49·UU RNA59 NA59 RNA69 NA69 NQS NQIS IRM	RNA49 NA49 RNA49·UU NA49·UU	RNA49 NA49 RNA49·RS,2RS NA49·RS,2RS RNA69 NA69 RNA48 NA48 RNAO NAO RNAO NAO NKIS NKIS RPNA PPNA LNA	
		inch	MR MR+MI MI	NCS NCS+PI PI	HJ HJ+IR IR	HJ HJ+IR IR	BR BRI IRB				MR MR+MI MI

Comparison of Bearing Series by Manufacturer ● Drawn-cup needle roller bearings

	NTN	INA	TORRINGTON	NSK	IKO	KOYO	THK	NADELLA	SKF	Mc,GILL
Drawn-cup needle roller bearings	mm	HK	HK	FJ	FJ	TLA·Z	BTM		DB	HK
		HK..ZWD	HK			TLA·Z				
		HK..L,LL	HK..RS,2RS	FJT,FJTT	FJT,FJTT	TLA·UU			DB·E	HK·RS,2RS
		HMK			FJL	TA·Z	BHTM			
		HMK..ZWD				TA·Z				
		HMK..L,LL			FJLT,FJLTT	TA·U,UU				
		BK	BK	MFJ	MFJ	TLAM	MKM		DBF	BK
		BK..ZWD	BK			TLAM				
		BK..L	BK..RS	MFJT	MFJT	TLAM·U				BK·RS
		BMK			MFJL	TAM	MHKM			
		BMK..ZWD				TAM				
		BMK..L			MFJLT					
		HV		F	F			BM	(DL)	
		HMV						BHM		
BV			FY	MF		MM	(DLF)			
					YTL	YM				
					YT	YM				
Drawn-cup needle roller bearings	inch	DCL	SCE	J	J	BA·Z	BT			
		DCL..L,LL	SCE..P,PP	JT,JTT	JT,JTT					
		DCH	SCH	JH	JH	BHA·Z	BHT			
		DCH..L,LL	SCE..P,PP	JHT,JHTT	JHT,JHTT					
		DBL	BCE	MJ	MJ	BAM	MK			
		DBL..L	BCE..P	MJT						
		DBH	BCH	MJH	MJH	BHAM	MHK			
		DBH..L	BCH..P	MJHT						
		VS	S	B	B		B		JL	
		VSH	SH	BH	BH		BH			
		VB	CS	M	M		M		JLF	
		VBH	CSH	MH	MH		MH			
			SN	Y	Y	YB	Y			
			SNH	YH	YH	YBH				
	CSN									
	CSNH									

Comparison of Bearing Series by Manufacturer ● Thrust roller bearings and thrust bearing rings

	NTN	INA	TORRINGTON	NSK	IKO	KOYO	THK	NADELLA	SKF	Mc,GILL	
Thrust roller bearings and thrust bearing rings	mm	AXK11	AXK	FNTA	FNTA	NTB	TP,TPK		AXK		
		K811	K811			AZK		(ARZ)			
		K812	K812		FNTH	AZK					
		K893	K893		FNTH			(ARZ)			
		K874	K874								
		811	811			AZ					
		812	812		FNTHA	AZ					
		893	893		FNTHA						
		874	874								
		AS11	AS	(FTA)	FTRA	AS	W		(CP)	AS	
		GS	GS		(FTRD-F)	GS			(CP,CPR)	GS	
		WS	WS		(FTRD-F)	WS	WS		(CP,CPR)	WS	
		AXA21	AXK+GS+ZS						PM		
		AXB21	AXK+WS+ZS						PM		
		ARA821	K811+GS+ZS								
		ARB821	K811+WS+ZS						PMH		
		ZS	ZS								
Thrust roller bearings and thrust bearing rings	inch	NTC	TC	NTA	NTA			BT			
		CTC		NTH	NTH						
		CTCA		NTHA	NTHA						
		NWA	TWA	TRA	TRA			TW			
		NWB	TWB	TRB	TRB			TW			
		NWC	TWC	TRC	TRC			TW			
		NWD	TWD	TRD	TRD			TW			
		NWE		TRE	TRE						
		NWF		TRF							
		CWS		TRI,TRJ							
		CGS		TRID,TRJD							

Comparison of Bearing Series by Manufacturer ●Compound bearings

	NTN	INA	TORRINGTON	NSK	IKO	KOYO	THK	NADELLA	SKF	Mc,GILL
Compound bearings	NKX	NKX			NAX				NKX	
	NKX·Z	NKX·Z			NAX·Z				NKX·Z	
	NKX+IR	NKX+IR			NAXI				NKX+IR	
	NKX·Z+IR	NKX·Z+IR			NAXI·Z				NKX·Z+IR	
	NKXR	NKXR			NBX				NKXR	
	NKXR·Z	NKXR·Z			NBX·Z			RAXZ	NKXR·Z	
	NKXR+IR	NKXR+IR			NBXI				NKXR+IR	
	NKXR·Z+IR	NKXR·Z+IR			NBXI·Z				NKXR·Z+IR	
	NKIA59	NKIA59			NATA59				NKIA59	
	NKIB59	NKIB59			NATB59				NKIB59	
	NX·ZNR	NX·Z+IR							NX·Z+WR	
	NX·ZNRD	NX+WR							NX+WR	
	NX·ZNR+IR	NX·Z+WR+IR							NX·Z+WR+IR	
	NX·ZNRD+IR	NX+WR+IR							NX+WR+IR	
	AXN	ZAXN						AXNB		
	ARN	ZARN						ARNB		

Comparison of Bearing Series by Manufacturer ●Cam followers

	NTN	INA	TORRINGTON	NSK	IKO	KOYO	THK	NADELLA	SKF	Mc,GILL	
Cam followers	mm	KR	KR	FRJC	FCJ-R	CF-R	KM-RM	CF-R	KR	MCFR	
		KR-LL	KR-PP	FRJSC	FCJS-R	CF-UUR	KM-UURM	CF-UUR		MCFR-S	
		KR-X	KR-X		FCJ	CF	KM-M	CF	KR-X	MCFR-X	
		KR-XLL	KR-PPX		FCJS	CF-UU	KM-UMU	CF-UU		MCFR-SX	
		KR-H				CF-BR					
		KR-LLH				CF-BUUR					
		KR-XH				CF-B					
		KRT									
		KRU									
		KRV	KRV			FCR-R	CF-VR	CM-RM	GC	KRV	MCF
		KRV-LL	KRV-PP			FCRS-R	CF-VUUR	CM-UURM	GC-EE		MCF-S
		KRV-X	KRV-X			FCR	CF-V	CM-M		KRV-X	MCF-X
		KRV-XLL	KRV-PPX			FCRS	CF-VUU	CM-UUM			MCF-SX
		KRV-H					CF-VBR				
		KRV-LLH					CF-VBUUR				
		KRV-XH					CF-VB				
		KRVT									
		KRVU									
		KRE					CFE-R				
		KRE-LL					CFE-UUR				
		KRVE				(FCRE)	CFE-VR				
		KRVE-LL					CFE-VUUR				
		NUKR	NUKR				NUCF-R	DKM-R		NUKR	
NUKR-X	NUKR-X							NUKR-X			
NUKR-H											
NUKR-XH											
NUKRT											
NUKRU											
Cam followers	inch	CR	CFC-Y			CR-R					
		CR-LL	CFC-PPY			CR-UUR					
		CR-X	CFC			CR					
		CR-XLL	CFC-PP			CR-UU					
		CRV	CF-Y	CRC	CRC					CCF	
		CRV-LL	CF-PPY	CRCS	CRCS					CCF-S	
		CRV-X	CF	CR	CR		CR			CF	
		CRV-XLL	CF-PP	CRS	CRS		CR-UU			CF-S	
		CRV-H									
		CRV-LLH									
		CRV-XH									

Comparison of Bearing Series by Manufacturer ●Roller followers

	NTN	INA	TORRINGTON	NSK	IKO	KOYO	THK	NADELLA	SKF	Mc,GILL	
Roller followers	mm	RNAB2	RSTO		RNAST-R		RNAST-R		RSTO		
		NAB2	STO		NAST-R		NAST-R		STO		
		RNAB2-X	RSTO-X		RNAST				RSTO-X		
		NAB2-X	STO-X		NAST		NAST		RST-X		
		RNA22-LL	RNA22-2RS						RNA22-2RS		
		NA22-LL	NA22-2RS						NA22-2RS		
		RNA22-XLL	RNA22-2RSX						RNA22-2RSX		
		NA22-XLL	NA22-2RSX						NA22-2RSX		
		NATR	NATR	FYRJ	FYCJ-R	NART-R	CXM-RM	NART-R	NATR	MCYRR	
		NATR-LL	NATR-PP	FYRJSC	FYCJS-R	NART-UUR	CXM-UURM	NART-UUR	NATR-PP	MCYRR.S	
		NATR-X	NATR-X		FYCJ		CXM-M		NATR-X	MCYRR.X	
		NATR-XLL	NATR-PPX		FYCJS	NART-VR	CXM-UUM		NATR-PPX	MCYRR.SX	
		NATV	NATV		FYCR-R	NART-VUUR	CYM-RM	NART-VR	FG	NATV	MCYR
		NATV-LL	NATV-PP		FYCRS-R		CYM-UURM	NART-VUUR	FG-EE	NATV-PP	MCYR.S
		NATV-X	NATV-X		FYCR		CYM-M			NATV-X	MCYR.X
		NATV-XLL	NATV-PPX		FYCRS		CYM-UUM			NATV-PPX	MCYR.SX
		NUTR	NUTR			NURT-R	DCZM-R			NUTR	
		NUTR-X	NUTR-X							NUTR-X	
	NUTW										
	NUTW-X										
	NABR				NAST-ZZR	CZM-R	NAST-ZZR		NAST-ZZ		
					NAST-ZZUR		NAST-ZZUR				
	NABR-X				NAST-ZZ	CZM	NAST-ZZ		NAST-P-ZZ		
					NAST-ZZUU		NAST-ZZUU				
inch	NACV	RF-Y	YCRC	YCRC						CYR	
	NACV-LL	RF-PPY	YCRSC	YCRSC						CYR.S	
	NACV-X	RF	YCR	YCR						CCYR	
	NACV-XLL	RF-PP	YCRS	YCRS						CCYR.S	

Comparison of Bearing Series by Manufacturer ●Linear motion bearings/Other items

		NTN	INA	TORRINGTON	NSK	IKO	KOYO	THK	SKF	NADELLA	Mc,GILL
Linear motion bearings	mm	FF	FF			FT·N					
		FF·ZW	FF·ZW								
		BF	BF			FT		FT			
		RF									
		KD	RLF			ST		ST			
		KD·LL				ST·UU	STUU				
		KH	KH								
		KLM	KB		LB	LM·N		LM			
		KLM·LL				LM·NUU		LM·UU			
		KLM·S				LM·NAJ		LM·AJ			
		KLM·SLL				LM·NUUAJ					
		KLM·P				LM·NOP		LM·OP			
		KLM·PLL				LM·NUUOP					
RLM	RUS			(SR,GSN)		LRU	PNC·EE				
Other items	mm	HF	HF	FC	FC						
		HFL	HFL	FCB	FCB						
		WR	WR			WR			JA		
		BR	BR			AR			JB		
		G	G		VC	OS	HM,HMS,MH,MHS		ET	G	
		GD	SD		KC	DS	HMSA,MHSA			UL	
		FRIS	UWL,UW21		NFB	M·ZZ,MB·ZZ					
		FR	RUW21								
		JPU..S	BSR								
		JPU·S+JF·S	BSRF								
			inch	HFZ	HFZ	RC	RC				
GSC											

NAME

ADDRESS

PHONE

OFFICE

PHONE

A series of horizontal dotted lines for writing, spanning most of the page width.

