

This section covers both the basic technical information governing bearing selection and the part numbering system used in this catalog. When the part numbering is different from the basic system, that particular numbering is described in the pertinent section. The various ball bearing parts and components referred to in this catalog are illustrated with brief descriptions, the basic dimensional symbols shown are defined.

Basic Information

Basic Technical Information	1-2
Ball Bearing Components	1-4
Basic Dimension Data	1-5
Part Numbering System	1-6
Index	1-10

BASIC TECHNICAL INFORMATION

BASIC TECHNICAL INFORMATION

BEARING SELECTION

There are several important considerations which must be evaluated simultaneously when choosing the proper bearing for a particular device. A detailed analysis of these considerations may be found in the Engineering Section; we will, however, briefly discuss some of the more important ones here.

Miniature and instrument ball bearings are normally made of either Stainless Steel or Chrome Alloy Steel. The load ratings listed in this catalog are for chrome steel unless otherwise noted. Load ratings are affected by bearing material. Life calculations are affected by bearing material as well as lubrication selection. These issues are discussed further beginning on page 4-12.

ABEC GRADE

Factors to be considered in selecting the ABEC Grade required for a bearing are Bore and O.D. fits, radial and axial runout requirements, and cost. The table below shows Bore and O.D. radial runout limits and size tolerances vs. ABEC Grade.

ABEC GRADE	MAXIMUM RADIAL RUNOUT		MEAN DIAMETER TOLERANCE		
	INNER RING	OUTER RING	BORE	O.D.	O.D. SIZE
1	.0003	.0006	+.0000 -.0003	+.0000	0-18mm
				-.0003	
3	.0002	.0004	+.0000 -.0002	+.0000	0-30mm
				-.0003	
5	.00015	.0002	+.0000 -.0002	+.0000	0-30mm
				-.0002	
7	.0001	.00015	+.0000 -.0002	+.0000	0-30mm
				-.0002	

The chart on page 4-20 gives a more complete description of the tolerances controlled by the ABEC. Note: A1 miniature and instrument bearings of both the metric and inch configurations meet the tolerances of AMBA Standard 20 for ABEC 1 metric series bearings.

TYPE OF CAGE

The two types of pressed steel ball cages are available for most bearings. "H" or metallic crown type, and "R" or two piece metallic ribbon type.



These two cage types are interchangeable in most common applications.

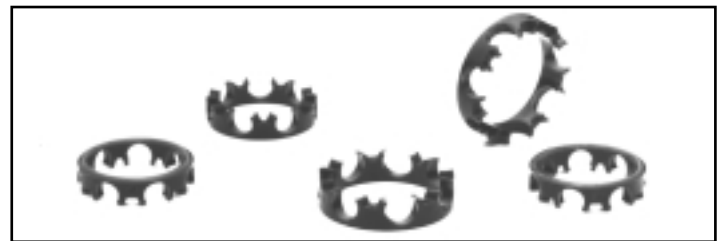

Also available for some sizes are cages made of molded and machined plastics. Our engineers can provide recommendations for any special requirements.

SHIELDS AND SEALS

Shields are available for most sizes, as shown on the listing pages. These closures will help to reduce the entrance of particulate contaminants into the bearing and will reduce the amount of lubricant leakage. Radial clearance between the shield bore and the inner ring O.D. is approximately .002 to .005 inch. The effect of shields on bearing torque or noise is insignificant.

Contacting seals made of synthetic rubber (DD) are available for most sizes. These seals provide the best protection from the entrance of contaminants, or exit of lubricant, but as a result, significantly increase operating torque. (DD) seals will withstand a slight amount of positive pressure differential.

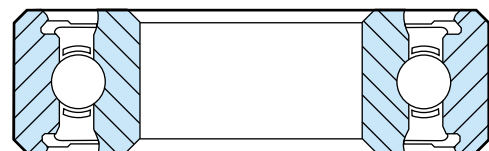

(DD)

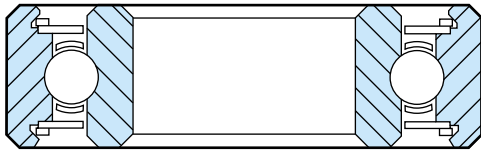

(LL)

Non contacting seals made of synthetic rubber (SS), or re-reinforced PTFE (LL), are also available for most chassis sizes. This type of seal offers better sealing than a metal shield, while keeping operating torque at the lowest possible levels. (LL) seals will contact the inner ring in some cases, but the nature of the seal material serves to keep torque at a minimum.

RADIAL PLAY

Radial play is the free internal radial looseness between the balls and races. Radial play within a ball bearing is necessary to accommodate thermal expansions, the effects of interference fit, and to control axial play. In cases of extreme temperature, speed, load, or where axial play amount is important, our Engineering Department should be consulted for recommendations.

STARTING AND RUNNING TORQUE

The operating torque of a bearing can be described as starting and running torque. Starting torque is the force required to begin rotation from a bearing at rest. Running torque is the force required to rotate one ring at a known speed while keeping the other ring stationary. The main contributors to bearing torque are seal and lubrication type. For applications in which low starting and/or running torque is required, an Applications Engineer should be contacted for bearing specification recommendations.

STATIC (Cor) AND DYNAMIC (Cr) LOADS

In evaluating the static load conditions, any forces exerted during assembly and test must be considered along with vibration and impact loads sustained during handling, test, shipment and assembly. Dynamic loading includes built-in preload, weight of supported members, and the effect of any accelerations due to vibration or motion changes. The static and dynamic radial load ratings are shown for each chassis size on the product listing pages. Descriptions of these calculated load ratings can be found in the Engineering Information Section.

SPEED OF OPERATION

Although a very large bearing might be the best choice for long life due to its load carrying capacity, it might very well fail early because of damage due to high centrifugal forces or rubbing speeds generated by the rotational velocity. To determine whether a particular bearing will operate satisfactorily at the speed required in a particular device, multiply the value $\frac{N_{max}}{f_n}$ for that bearing by the proper factor taken from the table shown at right. This table takes into account lubricant, retainer type, and ring rotation.

f_n vs. Cage, Lubricant Types and Ring Rotation

Lubricant	Ring Rotation	Metal Cage		Acetal			
		2-Piece or Crown Type		Crown Type		Full Section Type	
		Inner	Outer	Inner	Outer	Inner	Outer
Petroleum Oil		1.0	0.8	2.0	1.2	4.0	2.4
Synthetic Oil		1.0	0.8	2.0	1.2	4.0	2.4
Silicone Oil		0.8	0.7	0.8	0.7	0.8	0.7
Non-Channeling Grease		1.0	0.6	1.6	1.0	1.6	1.0
Channeling Grease		1.0	0.8	2.0	1.2	2.4	1.6
Silicone Grease		0.8	0.7	0.8	0.7	0.8	0.7

Note that the N_{max} value should be used for reference only. Higher speeds than specified can be achieved through the accuracy of the device's components. If bearing speed capacity is an important issue, please consult a member of our Engineering Department for assistance.

OPTIMUM LUBRICANT

Selection of the lubricant is extremely important. Many lubricants are available for varying conditions and requirements. An NMB Sales or Applications Engineer can help you select the lubricant best suited to your application.

Unless torque is a problem, the selection of a grease is much preferred in prelubricating bearings since it is less susceptible to migration and leakage. Grease can multiply the inherent bearing torque by a factor of 1.2 to 5.0, depending on the type and quantity of grease in the bearing. A discussion of lubrication and a partial listing of our most common greases can be found in the Engineering Information Section.

BALL BEARING COMPONENTS

BALL BEARING COMPONENTS

Vision

To assist in selecting the bearing with the proper components for a particular design or use, an exploded view of a standard ball bearing with component callouts is shown, below right. To further illustrate the relative positioning of these components in the ball bearing assembly, a cross section, right, is also shown. A detailed discussion of the various components, materials and dimensional tolerances can be found in Section 4, Engineering Information.

Cross section view of ball bearing

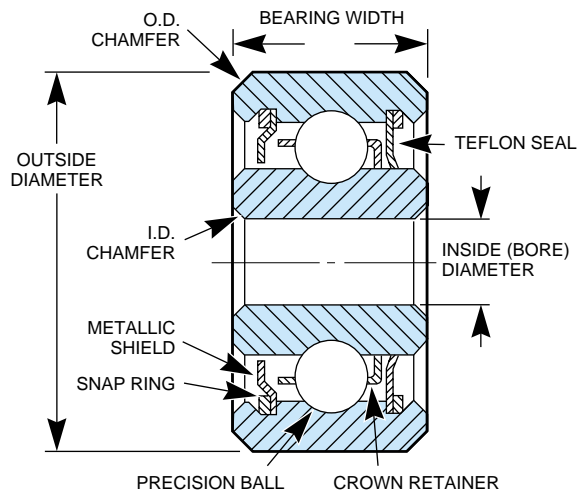

Exploded view of ball bearing

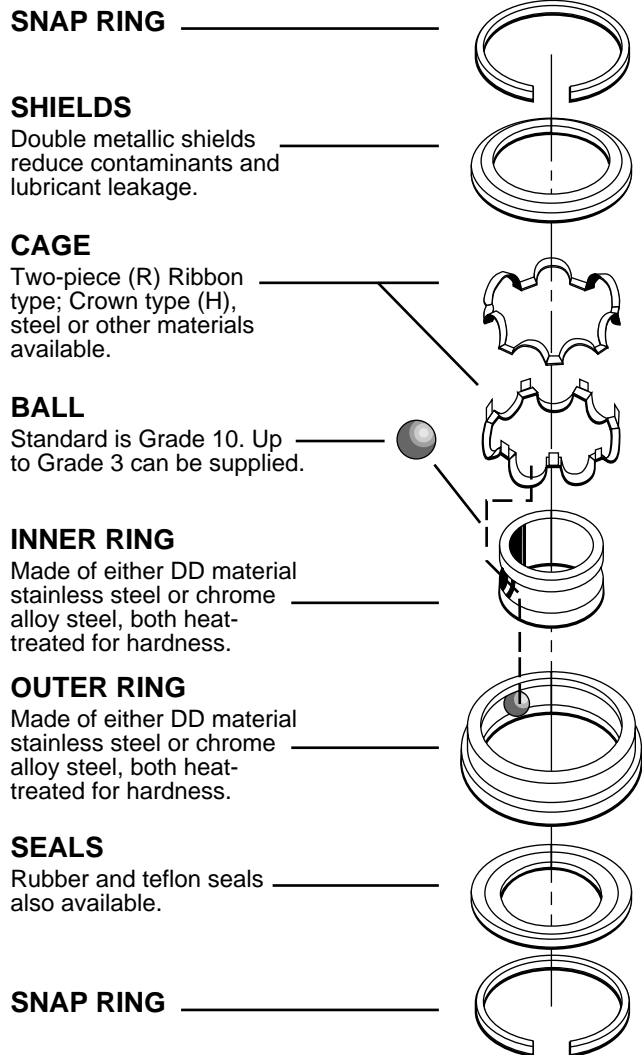

BASIC DIMENSION DATA

BASIC DIMENSION DATA

The dimensions and their associated symbols used throughout the catalog are described and defined to the right. The listing of these dimensions establish bearing size and other bearing parameters so designers may choose the ball bearing most suited to their requirement.

The Reference Codes shown in the figures below and used throughout this catalog are defined as follows:

- d Inside Diameter or Bore
- D Outside Diameter – O.D.
- B Inner Ring Width
- C Outer Ring Width
- D_f Flange Outside Diameter
- B_f Flange Width or Thickness
- L_i Inner Ring Reference Diameter
- L_o Outer Ring Reference Diameter
- r Maximum Shaft or Housing Fillet Radius that bearing corners will clear
- Z Number of Balls
- D_w Nominal Diameter of Balls
- N_{max} Maximum Speed (rpm)
- f_n Cage and Lubricant Factor. See page 1-3.

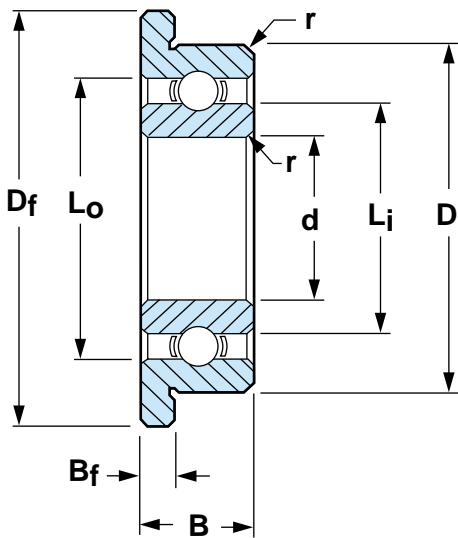
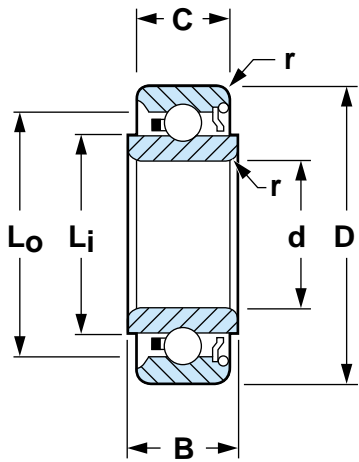

PART NUMBERING SYSTEM

PART NUMBERING SYSTEM

Vision

EXAMPLE:

DD RIF-418 ZZEE H A7 P25 LY75
KJ R-1350 ZZ R A5 P25 L01
RI-5532 R A7 P25 L01

GROUP 1	GROUP 2	GROUP 3	GROUP 4	GROUP 5	GROUP 6
MATERIAL	TYPE	BASIC SIZE	FEATURES	ANDERON METER TEST AND SPECIAL DESIGNS	CAGE
DD	RIF-	418	ZZEE		H
KJ	R-	1350	ZZ		R
	RI-	5532			R
<p>DD™ = NMB developed stainless steel material which falls within the 400 series Martensitic Stainless Steel grouping.</p> <p>KJ-MKJ3* chrome steel for inner and outer rings. Inner and outer ring material is NMB developed high carbon chromium bearing steel developed for HDDs and other specialty applications. Balls are made of 52100 or equivalent.</p> <p>NO CODE = Chrome alloy steel (52100 or equivalent)</p> <p>*US and foreign patents pending</p>	<p>RI, R, L = Radial ball bearings</p> <p>RIF, RF, LF = Flanged radial ball bearings</p> <p>RI, RIF = Inch Series</p> <p>R, L, RF, LF = Metric Series (exceptions: R-2, R-3, R-4 = inch series)</p>	<p>INCH SERIES First one or two digits indicates O.D. in 16ths of an inch. The following two or three digits indicate the bore size in a fraction of an inch, the first digit being the numerator and the second or the second and third digits being the denominator.</p> <p>METRIC SERIES First two digits indicate O.D. in mm. Second two digits indicate I.D. in mm.</p> <p>SPECIAL SIZE SERIES ZB = Integral shaft AS- _ _ _ _ = Pulley type assemblies; shaft assemblies; mechanical parts; tape guides; special pivot type; special bearings X- _ _ _ = Following basic size indicates special ball complement assigned in numerical sequence i.e., X1, X2, etc.</p>	<p>ENCLOSURES Z = Single metallic shield-removable ZZ = Double metallic shield-removable D = Single rubber seal-contact DD = Double rubber seal-contact H = Single metallic shield non-removable HH = Double metallic shield non-removable L = Single glass reinforced PTFE seal-contact LL = Double glass reinforced PTFE seal-contact S = Single rubber seal non-contact SS = Double rubber seal non-contact LZ = Glass reinforced PTFE seal and shield with seal on flange side ZL = Shield and glass reinforced PTFE seal with shield on flange side DZ = Rubber seal and shield</p> <p>EXTENDED INNER RING EE = Both sides</p>	<p>ANDERON METER TEST MT = Motor quality GT = Extremely quiet-H.D.D. spindle motor only No Code = Non-critical application</p> <p>SPECIAL DESIGN SD = Special design bearing</p>	<p>H = Metallic Crown R = Metallic Ribbon J = Acetal crown type MN = Glass fiber reinforced molded nylon M7 = Molded nylon</p>

PART NUMBERING SYSTEM

PART NUMBERING SYSTEM

PRODUCT

GROUP 7	GROUP 8	GROUP 9	GROUP 10
ABEC TOLERANCE	RADIAL PLAY	LUBRICANT	LUBE QUANTITY
A7	P25	LY75	L
A5	P25	L01	
A7	P25	L01	

A1 = ABEC 1
A3 = ABEC 3
A5 = ABEC 5
A7 = ABEC 7

Note

A1 miniature and instrument bearings of both the metric and inch configurations meet the tolerances of ABMA Standard 20 for ABEC 1 metric series bearings.

P = Followed by two or three numbers indicate the radial play limits in ten thousandths of an inch. Example: P25 indicates radial play of .0002" to .0005"

Lubricant letter codes are followed by a number to indicate specific type.
LO = Oil
LG = Greases
LY = Other Oils and Greases
LD = Dry-No Lubrication (DD Material Only)

X = 5-10%
L = 10-15%
T = 15 -20%
No Code = 25-35%
H = 40-50%
J = 50-60%
F = 100%
Percentage of void volume

IMPORTANT NOTE:

The NMB numbering system identifies ball bearing size and design. This system is not a guide to create a customized ball bearing. Please use the numbering system to decipher the basic bearing numbers listed in this catalog, or to define a number given to you by a representative of NMB. Bearing numbering systems which are different are explained in the pertinent sections of this catalog. Please consult a member of our Sales or Engineering staff to help you design a new bearing or to interchange another manufacturer's part number.

NMB METRIC 600/6000 PART NUMBERING SYSTEM

EXAMPLE:

608 DD NR M3 SM A3 LY121 H

GROUP 1	GROUP 2	GROUP 3	GROUP 4	GROUP 5	GROUP 6
BASIC CHASSIS NUMBER	CAGE	ENCLOSURE	EXTERNAL RETAINING RING	RADIAL PLAY	NOISE RATING
608	J	DD	NR	M3	SM
See pages 3-10 and 3-11 for listings of Metric 600/6000 Series	J = Molded plastic retainer MN = Glass fiber reinforced molded plastic retainer No Code = Ribbon retainer	Z = Single press type metal shield, non-removable D = Single contact rubber seal S = Single non-contact rubber seal Labyrinth design seal available on some sizes SSD21 = Labyrinth non-contact rubber seal DSD21 = Labyrinth contact rubber seal DSD64 = Double lip contact rubber seal No Code = Open bearing (Limited Availability) NOTE: Any combination of two enclosure types is available, i.e., ZZ, DD, SS, ZD, DS, ZS.	N = Groove only NR = Groove with retaining ring installed No Code = No groove or retaining ring NOTE: An external retaining ring is used where a flange effect is needed, but where the extra cost and stability of an integral flange are not required. Consult NMB for dimensions.	M2 = 0.003 - 0.008 mm M3 = 0.005 - 0.010 mm M4 = 0.008 - 0.013 mm M5 = 0.013 - 0.020 mm NOTE: Radial play is the internal radial looseness between the balls and the races. Radial play is necessary to accommodate differential thermal expansions, the effects of interference fits and to control axial play.	SM = Vibration critical applications MT = Extremely noise sensitive applications NOTE: Noise codes are the dynamic evaluation of the bearing's performance. By listening to the internal sounds of a bearing in motion (Anderson based testing), NMB can scientifically categorize its bearings into noise levels. By evaluating application needs, the product designer can now coordinate these noise codes and ABEC classes to achieve the most cost effective combination of noise and performance.

NMB METRIC 600/6000 PART NUMBERING SYSTEM

00/6000

PART NUMBERING SYSTEM

GROUP 7	GROUP 8	GROUP 9			
ABEC CLASSES	LUBRICANT	LUBE QUANTITY			
A3	LY121	H			
<p>A1 = ABEC 1 A3 = ABEC 3 A5 = ABEC 5 A7 = ABEC 7 NOTE: ABEC classes do not specify noise limits. In certain applications, if runouts and fits are non-critical, it may be possible to achieve the dynamic effects of higher ABEC class bearings by specifying an ABEC 1 bearing with a SM or MT noise code. This could lead to a significant cost savings.</p>	<p>LG20 = Exxon Beacon 325, Synthetic Grease LY48 = Mobil 28 Synthetic Grease LY121 = Kyodo Yushi SRL Synthetic Grease</p>	<p>X = 5-10% L = 10-15% T = 15-20% No Code = 25-35% H = 40-50% J = 50-60% F =100% Percentage of void volume</p>			

Vision

(Actual Size)

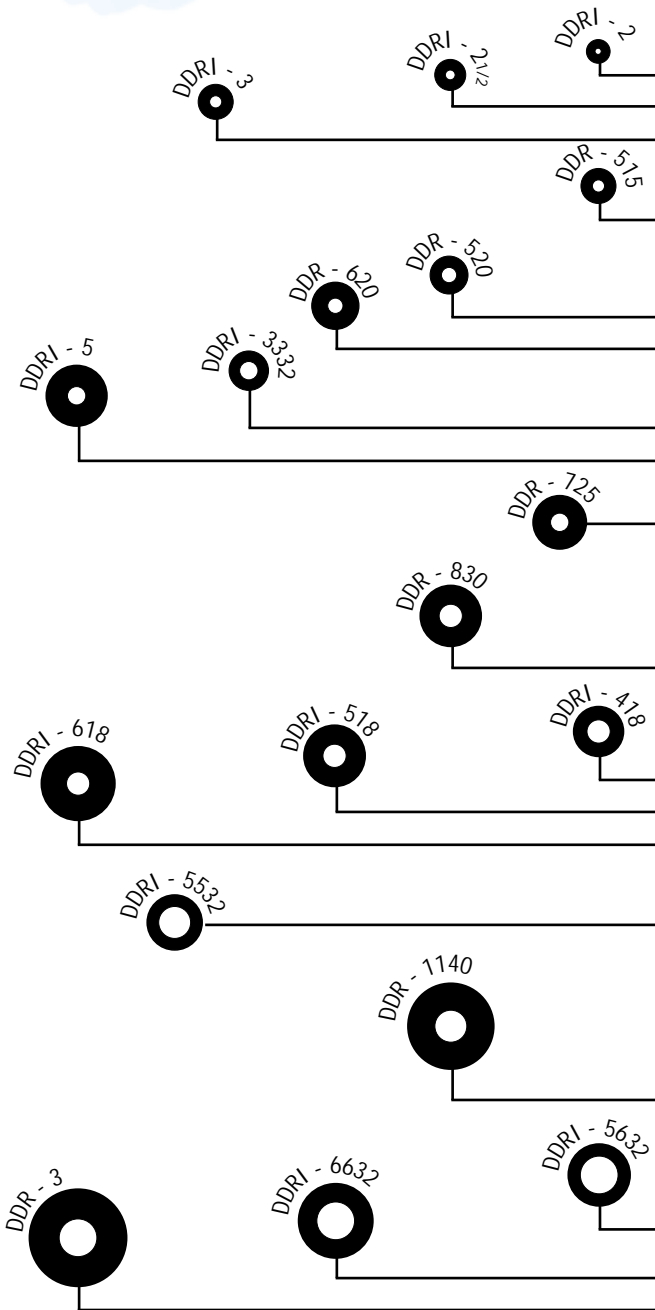

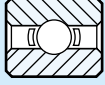
BORE d	O.D. D	*BASIC NUMBER	BEARING WIDTH	
			B OPEN 	REF. TO PAGE
.0394	.1181	DDL-310	.0394	3-2
.0400	.1250	DDRI-2	.0469	2-2
.0469	.1562	DDRI-2 1/2	.0625	2-2
.0550	.1875	DDRI-3	.0781	2-2
.0591	.1575	DDL-415	.0472	3-2
.0591	.1969	DDR-515	.0787	3-6
.0591	.2362	DDR-615	.0984	3-6
.0781	.2500	DDRI-4	.0937	2-2
.0787	.1969	DDL-520	.0591	3-2
.0787	.2362	DDR-620	.0906	3-6
.0787	.2756	DDR-720	.1102	3-6
.0937	.1875	DDRI-3332	.0625	2-2
.0937	.3125	DDRI-5	.1094	2-2
.0984	.2362	DDL-625	.0709	3-2
.0984	.2756	DDR-725	.0984	3-6
.0984	.3150	DDR-825	.1102	3-6
.1181	.2362	DDL-630	.0787	3-2
.1181	.2756	DDL-730	.0787	3-2
.1181	.3150	DDR-830	.1181	3-6
.1181	.3543	DDR-930	.1181	3-6
.1181	.3937	DDR-1030	.1575	3-6
.1250	.2500	DDRI-418	.0937	2-2
.1250	.3125	DDRI-518	.1094	2-2
.1250	.3750	DDRI-618	.1094	2-2
.1250	.3750	DDR-2	.1562	2-2
.1562	.3125	DDRI-5532	.1094	2-2
.1575	.2756	DDL-740	.0787	3-2
.1575	.3150	DDL-840	.0787	3-2
.1575	.3543	DDL-940	.0984	3-2
.1575	.3937	DDL-1040	.1181	3-2
.1575	.4331	DDR-1140	.1575	3-6
.1575	.4724	DDR-1240	.1575	3-6
.1575	.5118	DDR-1340	.1969	3-6
.1575	.6299	DDR-1640	.1969	3-6
.1875	.3125	DDRI-5632	.1094	2-2
.1875	.3750	DDRI-6632	.1250	2-2
.1875	.5000	DDR-3	.1562	3-2
.1969	.3150	DDL-850	.0787	3-2
.1969	.3543	DDL-950	.0984	3-2
.1969	.3937	DDL-1050	.1181	3-2

**DD" is a trademark of NMB

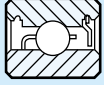
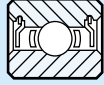
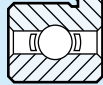
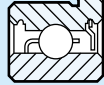
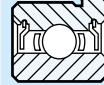
BEARING WIDTH		BEARING WIDTH		FLANGED WIDTH	FLANGED WIDTH		FLANGED WIDTH		FLANGED WIDTH		STD. REF.
B 1 SHIELD 	REF. TO PAGE	B 2 SHIELDS 	REF. TO PAGE		B OPEN 	REF. TO PAGE	B 1 SHIELD 	REF. TO PAGE	B 2 SHIELDS 	REF. TO PAGE	
—	—	—	—	DDLDF-310	.0394	3-3	—	—	—	—	—
—	—	—	—	DDRIF-2	.0469	2-6	—	—	—	—	RO-9
.0937	2-4	.0937	2-4	DDRIF-2 1/2	.0625	2-6	.0937	2-8	.0937	2-8	RO
.0937	2-4	.1094	2-4	DDRIF-3	.0781	2-6	.1094	2-8	.1094	2-8	R1
—	—	—	—	DDLDF-415	.0472	3-3	—	—	—	—	—
.1024	3-8	.1024	3-8	DDRF-515	.0787	3-7	.1024	3-9	.1024	3-9	—
.1181	3-8	.1181	3-8	DDRF-615	.0984	3-7	.1181	3-9	.1181	3-9	—
.1094	2-4	.1406	2-4	DDRIF-4	.0937	2-6	.1406	2-8	.1406	2-8	R1-4
—	—	.0906	3-4	DDLDF-520	.0591	3-3	—	—	.0906	3-5	—
.1181	3-8	.1181	3-8	DDRF-620	.0906	3-7	.1181	3-9	.1181	3-9	—
.1378	3-8	.1378	3-8	DDRF-720	.1102	3-7	.1378	3-9	.1378	3-9	—
.0937	2-4	.0937	2-4	DDRIF-3332	.0625	2-6	.0937	2-8	.0937	2-8	R133
.1094	2-4	.1406	2-4	DDRIF-5	.1094	2-6	.1406	2-8	.1406	2-8	R1-5
—	—	.1024	3-4	DDLDF-625	.0709	3-3	—	—	.1024	3-5	—
.1378	3-8	.1378	3-8	DDRF-725	.0984	3-7	.1378	3-9	.1378	3-9	—
.1575	3-8	.1575	3-8	DDRF-825	.1102	3-7	.1575	3-9	.1575	3-9	—
—	—	.0984	3-4	DDLDF-630	.0787	3-3	—	—	.0984	3-5	—
—	—	.1181	3-4	DDLDF-730	.0787	3-3	—	—	.1181	3-5	—
.1575	3-8	.1575	3-8	DDRF-830	.1181	3-7	.1575	3-9	.1575	3-9	—
.1969	3-8	.1969	3-8	DDRF-930	.1181	3-7	.1969	3-9	.1969	3-9	—
.1575	3-8	.1575	3-8	DDRF-1030	.1575	3-7	.1575	3-9	.1575	3-9	—
.0937	2-4	.1094	2-4	DDRIF-418	.0937	2-6	.1094	2-8	.1094	2-8	R144
.1094	2-4	.1406	2-4	DDRIF-518	.1094	2-6	.1406	2-8	.1406	2-8	R2-5
.1094	2-4	.1406	2-4	DDRIF-618	.1094	2-6	.1406	2-8	.1406	2-8	R2-6
.1562	2-4	.1562	2-4	DDRF-2	.1562	2-6	.1562	2-8	.1562	2-8	R-2
.1094	2-4	.1250	2-4	DDRIF-5532	.1094	2-6	.1250	2-8	.1250	2-8	R155
—	—	.0984	3-4	DDLDF-740	.0787	3-3	—	—	.0984	3-5	—
—	—	.1181	3-4	DDLDF-840	.0787	3-3	—	—	.1181	3-5	—
—	—	.1575	3-4	DDLDF-940	.0984	3-3	—	—	.1575	3-5	—
—	—	.1575	3-4	DDLDF-1040	.1181	3-3	—	—	.1575	3-5	—
.1575	3-8	.1575	3-8	DDRF-1140	.1575	3-7	.1575	3-9	.1575	3-9	—
.1575	3-8	.1575	3-8	DDRF-1240	.1575	3-7	.1575	3-9	.1575	3-9	—
.1969	3-8	.1969	3-8	DDRF-1340	.1969	3-7	.1969	3-9	.1969	3-9	—
—	3-8	.1969	3-8	DDRF-1640	.1969	3-7	.1969	3-9	.1969	3-9	—
.1094	2-4	.1250	2-4	DDRIF-5632	.1094	2-6	.1250	2-8	.1250	2-8	R156
.1250	2-4	.1250	2-4	DDRIF-6632	.1250	2-6	.1250	2-8	.1250	2-8	R166
.1960	2-4	.1960	2-4	DDRF-3	.1562	2-6	.1960	2-8	.1960	2-8	R-3
—	—	.0984	3-4	DDLDF-850	.0787	3-3	—	—	.0984	3-5	—
—	—	.1181	3-4	DDLDF-950	.0984	3-3	—	—	.1181	3-5	—
—	—	.1575	3-4	DDLDF-1050	.1181	3-3	—	—	.1575	3-5	—

**DD* is a trademark of NMB

(Actual Size)

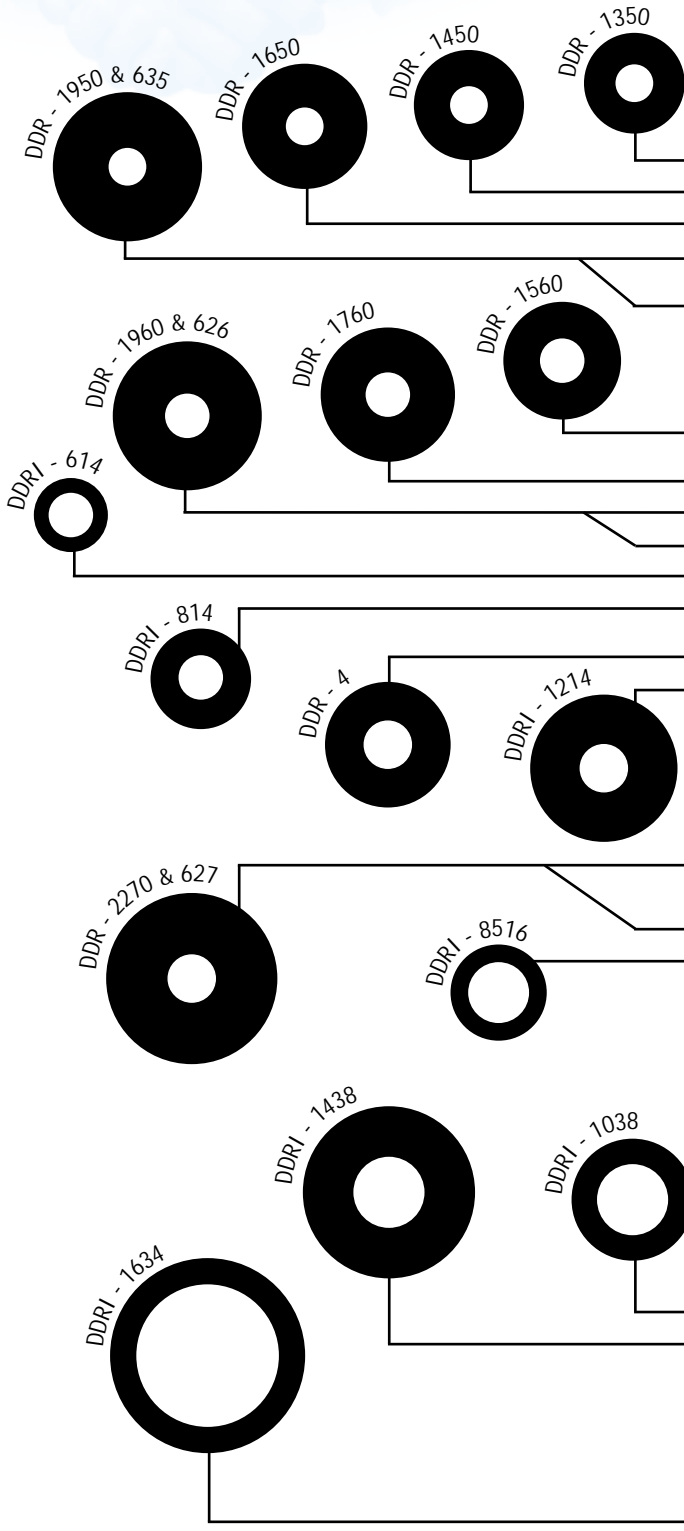

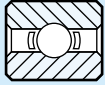
BORE d	O.D. D	*BASIC NUMBER	BEARING WIDTH	
			B OPEN 	REF. TO PAGE
.1969	.4331	DDL-1150	.1181	3-2
.1969	.5118	DDR-1350	.1575	3-6
.1969	.5512	DDR-1450	.1969	3-6
.1969	.6299	DDR-1650	.1969	3-6
.1969	.7480	635	.2362	3-10
.1969	.7480	DDR-1950	.2362	3-6
.2362	.3937	DDL-1060	.0984	3-2
.2362	.4724	DDL-1260	.1181	3-2
.2362	.5118	DDL-1360	.1378	3-2
.2362	.5906	DDR-1560	.1969	3-6
.2362	.6693	DDR-1760	.2362	3-6
.2362	.7480	626	.2362	3-10
.2362	.7480	DDR-1960	.2362	3-6
.2500	.3750	DDRI-614	.1250	2-2
.2500	.5000	DDRI-814	.1250	2-2
.2500	.6250	DDR-4	.1960	2-2
.2500	.7500	DDRI-1214	.2188	2-2
.2756	.4331	DDL-1170	.0984	3-2
.2756	.5118	DDL-1370	.1181	3-2
.2756	.5512	DDL-1470	.1378	3-2
.2756	.7480	607	.2362	3-10
.2756	.8661	627	.2756	3-10
.2756	.7480	DDR-1970	.2362	3-6
.2756	.8661	DDR-2270	.2756	3-6
.3125	.5000	DDRI-8516	.1562	2-2
.3150	.4724	DDL-1280	.0984	3-2
.3150	.5512	DDL-1480	.1378	3-2
.3150	.6299	DDL-1680	.1575	3-2
.3150	.7480	DDR-1980	.2362	3-6
.3150	.8861	608	.2756	3-10
.3150	.8661	DDR-2280	.2756	3-6
.3543	.6693	DDL-1790	.1575	3-2
.3543	.7874	DDL-2090	.2362	3-2
.3543	1.0236	629	.3150	3-10
.3750	.6250	DDRI-1038	.1562	2-2
.3750	.8750	DDRI-1438	.2188	2-2
.3937	.7480	DDL-1910	.1969	3-2
.3937	1.0236	6000	.3150	3-10
.5000	.7500	DDRI-1212	.1562	2-2
.6250	.8750	DDRI-1458	.1562	2-2
.7500	1.0000	DDRI-1634	.1562	2-2

**"DD" is a trademark of NMB

INDEX

continued

INDEX

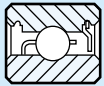
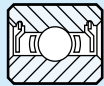
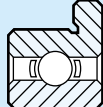
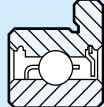
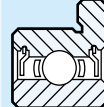
BEARING WIDTH		BEARING WIDTH		FLANGED *BASIC NUMBER	FLANGED WIDTH		FLANGED WIDTH		FLANGED WIDTH		STD. REF.
B 1 SHIELD 	REF. TO PAGE	B 2 SHIELDS 	REF. TO PAGE		B OPEN 	REF. TO PAGE	B 1 SHIELD 	REF. TO PAGE	B 2 SHIELDS 	REF. TO PAGE	
—	3-8	.1969	3-4	DDLDF-1150	.1181	3-3	—	—	.1969	3-5	—
.1575	3-8	.1575	3-8	DDRF-1350	.1575	3-7	.1575	3-9	.1575	3-9	—
.1969	3-8	.1969	3-8	DDRF-1450	.1969	3-7	.1969	3-9	.1969	3-9	—
.1969	3-8	.1969	3-8	DDRF-1650	.1969	3-7	.1969	3-9	.1969	3-9	—
.2362	3-10	.2362	3-10	—	—	—	—	—	—	—	—
.2362	3-8	.2362	3-8	DDRF-1950	.2362	3-7	.2362	3-9	.2362	3-9	35
—	—	.1181	3-4	DDLDF-1060	.0984	3-3	—	—	.1181	3-5	—
—	—	.1575	3-4	DDLDF-1260	.1181	3-3	—	—	.1575	3-5	—
—	—	.1969	3-4	DDLDF-1360	.1378	3-3	—	—	.1969	3-5	—
.1969	3-8	.1969	3-8	DDRF-1560	.1969	3-7	.1969	3-9	.1969	3-9	—
.2362	3-8	.2362	3-8	DDRF-1760	.2362	3-7	.2362	3-9	.2362	3-9	—
.2362	3-10	.2362	3-10	—	—	—	—	—	—	—	—
.2362	3-8	.2362	3-8	DDRF-1960	.2362	3-7	.2362	3-9	.2362	3-9	36
.1250	2-4	.1250	2-4	DDRIF-614	.1250	2-6	.1250	2-8	.1250	2-8	R168
.1250	2-4	.1875	2-4	DDRIF-814	.1250	2-6	.1875	2-8	.1875	2-8	R188
.1960	2-4	.1960	2-4	DDRF-4	.1960	2-6	.1960	2-8	.1960	2-8	R-4
.2812	2-4	—	—	—	—	—	—	—	—	—	—
—	—	.1181	3-4	DDLDF-1170	.0984	3-3	—	—	.1181	3-5	—
—	—	.1575	3-4	DDLDF-1370	.1181	3-3	—	—	.1575	3-5	—
—	—	.1969	3-4	DDLDF-1470	.1378	3-3	—	—	.1969	3-5	—
.2362	3-10	.2362	3-10	—	—	—	—	—	—	—	—
.2756	3-10	.2756	3-10	—	—	—	—	—	—	—	—
.2362	3-8	—	—	—	—	—	—	—	—	—	—
.2756	3-8	.2756	3-8	DDRF-2270	.2756	3-7	.2756	3-9	.2756	3-9	37
.1562	2-4	.1562	2-4	DDRIF-8516	.1562	2-6	.1562	2-8	.1562	2-8	R1810
—	—	.1378	3-4	DDLDF-1280	.0984	3-3	—	—	.1378	3-5	—
—	—	.1575	3-4	DDLDF-1480	.1378	3-3	—	—	.1575	3-5	—
—	—	.1969	3-4	DDLDF-1680	.1575	3-3	—	—	.1969	3-5	—
.2362	3-6	.2362	3-8	DDRF-1980	—	—	—	—	—	—	—
.2756	3-10	.2756	3-10	—	—	—	—	—	—	—	—
.2756	3-6	.2756	3-8	DDRF-2280	.2756	3-7	.2756	3-9	.2756	3-9	38
—	—	.1969	3-4	DDLDF-1790	.1575	3-3	—	—	.1969	3-5	—
—	—	.2362	3-4	—	—	—	—	—	—	—	—
.3150	3-10	.3150	3-10	—	—	—	—	—	—	—	—
.1562	2-4	.1562	2-4	—	—	—	—	—	—	—	R620
.2812	2-4	.2812	2-4	DDRIF-1438	.2812	2-6	.2812	2-8	.2812	2-8	R-6
—	—	.2756	3-4	—	—	—	—	—	—	—	—
.3150	3-10	.3150	3-10	—	—	—	—	—	—	—	—
.1562	2-4	.1562	2-4	—	—	—	—	—	—	—	R824
.1562	2-4	.1562	2-4	—	—	—	—	—	—	—	R1028
.1562	2-4	.1562	2-4	—	—	—	—	—	—	—	R1232

**"DD" is a trademark of NMB



Vision