



New Hampshire Ball Bearings, Inc.

————— *A Minebea Company* —————

PRECISION DIVISION

Products and Engineering

Miniature and Instrument

Torque Tube and Thinex

Custom Specialty

Bearing Assemblies

Middle Size Bearings

Keeping Technology on the Move®



NHBB

PRECISION DIVISION
Products and Engineering



New Hampshire Ball Bearings, Inc.

— *A Minebea Company* —

NHBB has a long history of providing a vast array of precision ball bearing solutions to various industries. With the advent of this revised, comprehensive catalog, you'll see that we've worked to define those solutions in an easy, accessible manner. Within these pages you will find detailed product listings, accurate measurements and helpful schematics, as well as conversion charts and explanations of relevant terminology.

You'll notice a few additions to this catalog: new product tables (including torque tube and thinex bearings, and middle size bearings up to 2.5 inches O.D.), a helpful size chart, additional examples of special assemblies for your review, and updated information within the engineering section.



























Our goal at NHBB has always been to meet the ever-changing needs of our customers through innovation. Our reference catalog is intended to streamline your review of our offerings and assist in your decision-making experience.



Thank you for your continued interest in our products and services.

see reverse for size chart

Size Chart

Represented below are the actual sizes of various inch and metric series bearings.

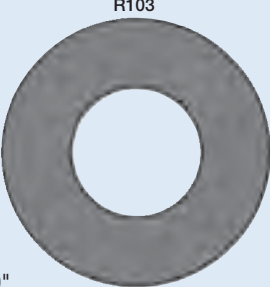
O.D.	
.1250"	RI-2 
.1562"	RI-2 1/2 
.1875"	RI-3  RI-3332 
.2500"	RI-4  RI-418 
.3125"	RI-5  RI-518  RI-5532  RI-5632 
.3750"	RI-618  R-2  RI-6632 
.5000"	R-2A  R-3  RI-814  RI-8516 
.6250"	R-4  RI-1038 
.7500"	RI-1214  RI-1212 
.8750"	RI-1438  RI-1412  RI-1458 
1.0000"	RI-1634 
1.1250"	RI-1812  RI-1878 

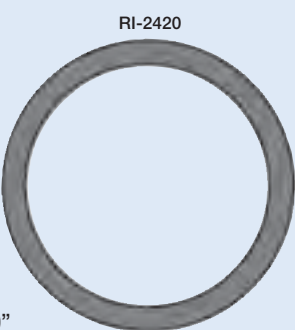
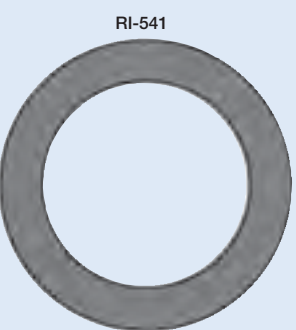
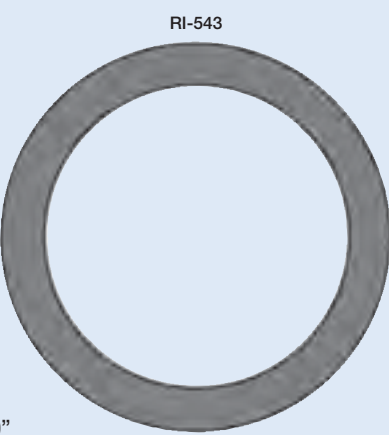
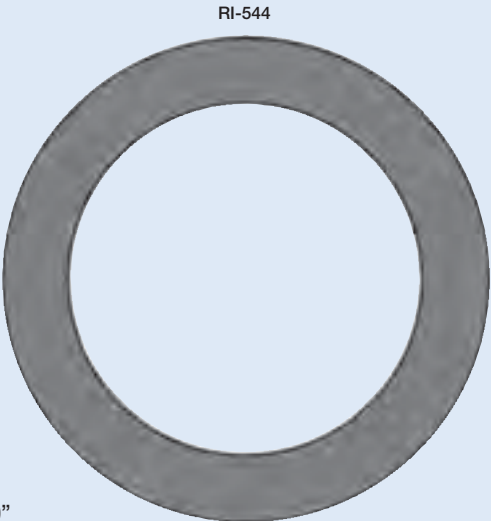
O.D.	
1.3780"	R103  R202 
1.5000"	RI-2420  RI-541 
2.0000"	RI-543 
2.5000"	RI-544 

MEDICAL AND DENTAL

- Handpieces and Drills
- Centrifuges
- Diagnostic Equipment
- Artificial Heart Pumps
- Blood Analyzers
- Cryogenic Pumps
- Lasers



COMMERCIAL AND MILITARY AEROSPACE

- Airframe Control Systems
- Auxiliary Drive Systems
- Fuel/Air Valves
- Aircraft Instruments
- Navigation Systems
- Turn Coordinators



DEFENSE

- Missiles
- Tanks
- UAVs

HIGH TECH/HIGH PERFORMANCE

- Scanners
- Semiconductor Processing
- Optical Encoders
- Robotics
- Galvos
- Microturbines
- Turbomolecular Pumps
- Flow Meters

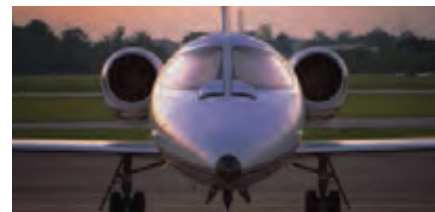

Introduction

- 03 Precision Division
- 04 Precision Capabilities
- 06 Basic Technical Information
- 09 Ultra-High-Speed Bearing Designs
- 10 Special Designs and Assemblies
- 12 Part Numbering System

Miniature Inch Series

- 16 Radial, Open, Unflanged
- 17 Radial, Open, Flanged
- 18 Radial, Shielded, Unflanged
- 19 Radial, Shielded, Flanged
- 20 Full Ball Complement, Radial, Open, Unflanged and Flanged
- 21 Full Ball Complement, Radial, Shielded, Unflanged and Flanged
- 22 Extended Inner Ring, Radial, Open, Unflanged and Flanged
- 23 Extended Inner Ring, Radial, Shielded, Unflanged and Flanged
- 24 Modified Dimension, Radial, Open, Unflanged and Flanged
- 25 Modified Dimension, Radial, Shielded, Unflanged and Flanged

Custom Specialty

- 30 Angular Contact, Full Ball Complement
- 31 Angular Contact
- 32 Radial

Torque Tube and Thinex

- 36 Torque Tube, Standard Width
- 37 Torque Tube, Extended Inner Ring
- 38 Thinex

(continued other side)

Metric Series

- 40 Middle Size Metric Series – Radial, Unflanged
- 41 Miniature Metric L Series – Radial, Open, Unflanged and Flanged
- 42 Miniature Metric L Series – Radial, Shielded, Unflanged and Flanged
- 43 Miniature Metric R Series – Radial, Open, Unflanged and Flanged
- 44 Miniature Metric R Series – Radial, Shielded, Unflanged and Flanged

Engineering

- 46 Engineering Services
- 47 Materials
- 49 Cages
- 52 Seals and Shields
- 53 Internal Bearing Geometry
- 55 Lubrication
- 57 Preload and Duplex Ball Bearings
- 58 Load Ratings and Bearing Life
- 61 Mounting and Coding
- 62 Recommended Fits
- 63 Tolerances
- 65 Torque
- 65 Post Service Analysis
- 66 Interchange Chart
- 68 Metric Conversion Table
- 69 Temperature Conversion Table

New Hampshire Ball Bearings, Inc.

- 72 NHBB Overview
- 73 Astro Division, Laconia, NH
- 74 HiTech Division, Peterborough, NH
- 75 myonic USA, Chatsworth, CA
- 76 Minebea Co., Ltd.

NHBB reserves the right to change specifications and other information included in this catalog without notice. All information, data, and dimension tables in this catalog have been carefully compiled and thoroughly checked. However, no responsibility for possible errors or omissions can be assumed.



03	Precision Division
04	Precision Capabilities
06	Basic Technical Information
09	Ultra-High-Speed Bearing Designs
10	Special Designs and Assemblies
12	Part Numbering System





NHBB's Precision Division has a longstanding commitment to cost-competitive volume production methods for nonstandard, ultraprecision miniature and instrument bearings as well as medium-size bearings up to 2.5 inches in outer diameter. We provide significant technical expertise by working collaboratively with our customers throughout the product development process. Our applications engineers incorporate design innovations in a broad range of bearing construction types, and always leverage the latest technologies to achieve optimal performance and customer satisfaction.

Our commitment to research and development, as demonstrated by our modern product development and testing lab, has strengthened our ability to offer unique solutions, especially in high speed and low torque applications. With our expanded testing capabilities, we are able to simulate customer application parameters, which results in bearings that last longer, perform more consistently, and run quieter. We are also proud of several industry firsts, including our patented silver-polymer retainer, which extends bearing life by up to 60%.

The Precision Division factory in Chatsworth, California features advanced CNC equipment for machining and grinding, and a Class 1000 clean room where all bearing assembly takes place. This is also the state-of-the-art location for unique lubricant processing, functional testing, precise dimensional coding of ring components, and laser marking.

Our commitment to excellence and our strong customer partnerships reveal a deeper goal...Keeping Technology on the Move®.

ENGINEERING SUPPORT

Experienced sales and applications engineers work closely with you throughout the product development process to create customized bearings for unique applications. We offer:

- Design flexibility
- Stringent attention to quality
- Unsurpassed product reliability



DESIGN FLEXIBILITY

Working from preliminary design concepts, we're able to customize bearings to meet your specific application challenges. Our focus is to maximize value to our customers by providing cost-effective solutions. What makes design flexibility possible?

- In-house manufacturing processing
- A broad range of construction types
- Proprietary retainer designs
- Extensive offering of lubricants and coatings for extreme environments

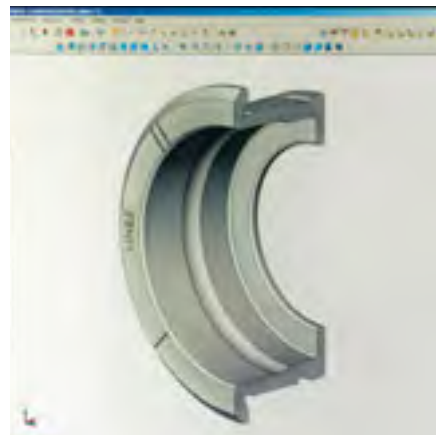

QUALITY CERTIFICATIONS

We offer exceptional quality with an emphasis on dimensional accuracy, process control, and cleanliness. We are certified to the latest ISO and aerospace standards, including:

- ISO 9001
- AS9100
- Nadcap - Heat treat (AC7102)



RESEARCH & DEVELOPMENT

NHBB's product development and testing department works closely with our technology partners to develop innovative solutions to demanding applications. Our ongoing commitment includes researching and validating processes and materials that will reduce torque, minimize heat generation, and extend the operational life of each bearing we manufacture.



CLASS 1000 CLEAN ROOM

Our ISO 14644-1 Class 6 Clean Room includes dynamic noise and vibration analysis equipment and extensive assembly resources to meet specific application challenges, such as:

- Unique lubricant processing
- Torque testing
- Dimensional coding of ring components
- Laser marking



ENVIRONMENTAL COMMITMENT

NHBB's formal environmental policy emphasizes pollution prevention, regulatory compliance, continuous improvement in reducing environmental impacts, and the promotion of environmental awareness among our employees and the larger community. Additionally, our environmental management systems are certified to ISO 14001.



Basic Technical Information

Ball Bearing Components

Viewing a cross-section of a standard ball bearing can help you select a bearing with the appropriate components for your design or application, as it illustrates the relative position of these components in the ball bearing assembly.

Cross-section View of a Ball Bearing

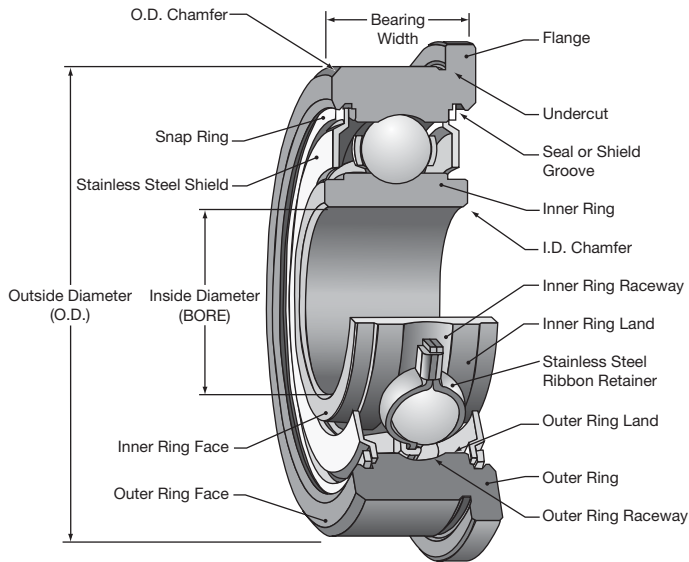

Bearing Selection

To ensure optimal speed and load carrying capacity, several factors must be considered when choosing the proper bearing for your application. These factors include ring material, design, shields and seals, cage, ABEC grade, radial play, and lubricant.

Materials

Miniature and instrument bearings are normally made of either stainless steel or chrome alloy steel. NHBB offers 440C stainless steel for applications that require corrosion resistance and 52100 chrome steel for maximum fatigue life. These materials are heat-treated to achieve optimum hardness and dimensional stability and they are suitable for most applications. When more difficult operating conditions necessitate an alternative to standard materials, NHBB offers a specialized stainless steel (DD400) as well as exotic materials like BG42[®] and nitrogen-enriched steel. Turn to page 47 for more information about these options.

MATERIAL	SPECIFICATION	MELT METHOD	ATTRIBUTES	ROOM TEMP. HARDNESS (HRC)	
				BALLS	RINGS
440C*	AMS 5618	CEVM**	Premium quality Very low impurity level	58-65	58-62
52100	AMS 6444	CEVM**	Premium quality Low impurity level	60-67	60-64

*440C stainless steel is the preferred material with the best availability.

**Consumable Electrode Vacuum Melted

Design

The design of a bearing is critical in determining its load carrying capacity and maximum operating speed—factors which directly impact the bearing's operating life. Various types of bearings have been designed to meet the operating parameters of your application.

The **radial** or **conrad bearing** (also referred to as deep groove) is the most popular type due to its ability to handle both radial loads and thrust loads in either direction. This type is offered with various seal or shield options.

The **angular contact bearing** is designed with a relieved shoulder to allow for a greater number of balls, thereby increasing its load carrying capacity. The angular contact design also allows for the use of a full section cage, which is desirable for high speed applications. This type of bearing can handle thrust loads in one direction only.



Radial



Angular Contact

Basic Technical Information

Seals and Shields

Seals and shields are used in ball bearings to retain lubricants and prevent particulate contamination from reaching critical surfaces. Shields are popular for most applications; seals are used where minimal clearance to light contact is required. Seals offer greater deterrence to particulate contamination but increase torque and limit operating speed. NHBB offers a variety of enclosure options. The chart on page 52 in the Engineering Section describes these options in greater detail.

Cages

The cage, also referred to as the retainer or separator, is the component that separates and positions the balls at approximately equal intervals around the bearing raceway. Proper selection of a bearing cage is critical for meeting the load, speed, and temperature requirements of your application.

The standard cages for radial or conrad miniature and instrument ball bearings are stamped metal ribbon or crown. The application flexibility and low-cost design of these types make them appropriate for most general purpose applications. For high speed applications, machined cages made of phenolic, polyamide-imide, and other materials are available. Refer to page 49 in the Engineering Section for more details on cage options.

ABEC Grade

When choosing the ABEC grade, the factors to consider include radial and axial runout requirements, bore and O.D. fits, and audible noise level. The table below shows the bore and O.D. size tolerances and the radial runout limits for ABEC grades 5 through 9. Grades 5 and 7 are preferred for most standard applications.

ABEC GRADE	O.D. SIZE	RADIAL RUNOUT		MEAN DIAMETER TOLERANCE	
		INNER RING	OUTER RING	BORE	O.D.
5P	0-1.1811 in. (0-30 mm)	.00015	.00020	+.0000 -.0002	+.0000 -.0002
7P	0-1.1811 in. (0-30 mm)	.00010	.00015	+.0000 -.0002	+.0000 -.0002
9P	0-.7086 in. (0-18 mm) over .7086- 1.1811 in. (over 18-30 mm)	.00005	.00005	+.0000 -.0001	+.0000 -.0001
		.00010	.00010	+.0000 -.0001	+.0000 -.00015

The chart on page 63 provides a complete description of the tolerances controlled by the ABEC level. Normally, race finish and race geometry are superior in ABEC 5P and higher. NHBB recommends these grades for precision assemblies where low noise (mechanical or audible), minimal runout, and long life are important considerations for noise sensitive applications.



*One-piece Crown,
Metallic, Stamped*



*Two-piece Ribbon, Metallic,
Stamped and Crimped*



*One-piece Crown,
Phenolic, Machined*



*One-piece Full Type,
Polymer, Machined*

Basic Technical Information

Radial Play

Radial play is the free internal radial looseness between the balls and the races with no load applied to the bearing in any direction. Radial play is necessary to accommodate differential thermal expansions, the effects of interference fits, and to control axial play and deflection. The chart on page 53 shows the suggested radial play for some typical applications.

Lubricant

There are hundreds of lubricants available for ball bearings and each has a particular characteristic that makes it suitable for a specific application. Selecting the optimal one is critical. Unless torque is a problem, grease is preferred for prelubrication since it is less susceptible to migration and leakage. Grease can increase bearing torque by a factor of 1.2 to 5.0 depending on the grease type and quantity used. See pages 55 and 56 for further information.

Marking

The following figures illustrate the standard marking system used for NHBB Precision Division ball bearings per MIL-STD-1647. Shown below are the markings for 440C stainless steel and 52100 chrome alloy steel.

ABEC 5, 7 and Higher Tolerances



ABEC 1 and 3 Tolerances

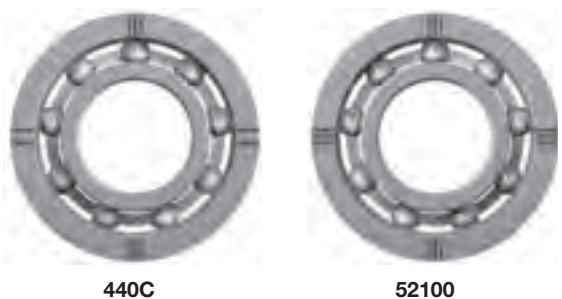

Packaging

NHBB packaging is specifically designed to keep bearings clean and undamaged through the delivery process. We perform packaging operations in our Class 1000 clean room to prevent contamination. In order to maintain the utmost cleanliness and integrity, bearings should be kept in their original packaging until ready for installation.

NHBB's bearings are normally packaged in plastic vials, eight or more per vial. If prelubrication or a protective coating is not specified, oil per MIL-PRF-6085 (NHBB code LO1) will be used to prevent corrosion.

Vial Pack (No Code) – Eight or more per vial. A transparent resealable tube of an appropriate size.

Pill Pack (Code P) – One bearing per sealed, plastic compartment. Connected in strips of four. Pill packs are formed from strips of transparent, heat-sealed plastic.

Unit Pack (Code U) – Individual bearing placed in a sealed plastic bag. Ten or more packed in a paperboard box. Unit pack is used for many of the larger size bearings that cannot fit in a strip pack.

Box (Code B) – Individual box, upon request at additional cost. All methods of packaging have an intermediate box. Quantities vary.

All intimate and external packaging includes a clear and detailed label that provides:

- Customer part number
- NHBB part number broken into two sections:
 - “Brg. No.” which describes the basic bearing entailed in groups 1 through 8
 - “Spec” section which details groups 9 through 14
- Quantity
- NHBB Precision Division cage code (50294)
- Manufacturing lot number
- Date of manufacture/lubrication

Other packaging options are available to suit your specific needs. See part numbering system (group 15) on page 13 for more information.

Ultra-High-Speed Bearing Designs

NHBB is recognized as the leader in the design and manufacture of ultra-high-speed bearings, which can operate at speeds up to 500,000 rpm. This capability is based on an unwavering commitment to superior product design, backed by a cutting-edge product development and test laboratory. Our lab is dedicated to validating new retainer materials, in addition to conducting exhaustive testing of new lubricants and surface treatments—all with the goal of extending bearing operational life.

In order to operate at ultra-high speeds in excess of 8,000 revolutions per second, bearing components must be made from the best materials available and manufactured to extremely tight tolerances. Ultra-high-speed bearings should also include a machined retainer made from a specialty material that provides lubricity, lower thermal expansion, resistance to high temperatures, and the option of autoclavability.

Our applications engineers work collaboratively with you to ensure the best bearing design for your ultra-high-speed application. In doing so, we offer several design features:

Ultra-precise Tolerances*

Exacting dimensional accuracy of bearing raceways and all piloting surfaces—better than ABEC 9.

NHBB offers:

- Super finished raceways and honed lands
- Raceway roundness better than 0.000010 in. on average
- Ultra-precise bore tolerances—available within 0.0001 in.
- Steel balls—Grade 5 or better
- Ceramic balls—Grade 3 standard (0.000003 in. sphericity)



**To specify the features referenced above, notate "MC" in the NHBB part number.*

High Quality Bearing Steel

- 440C stainless steel—offers excellent properties with optimal hardness and dimensional stability, low noise, as well as economical price points

For more information about bearing steel, see page 47.



Machined Retainers

- Radial bearings—machined crown
- Angular contact bearings—machined full type
- Special materials:
 - Meldin®
 - Phenolic (woven linen or paper)
 - Polyamide-imide
 - Patented silver coated machined Torlon® retainer—crown or full. Extends operational life in marginally lubricated applications and provides added benefit with the antimicrobial properties of the silver coating

For more information on machined retainers, see pages 49 through 51.

Optimal Lubricant Type and Fill

- Petroleum-based and synthetic oils—diesters, silicone polymers and fluorinated compounds
- Superior operating characteristics—lubricity and load carrying properties, wear resistance, life, and corrosion resistance
- Customized fill: consult the factory for nonstandard fill ratios

For more information about lubricants, see pages 55 and 56.

Meldin® is a registered trademark of Saint-Gobain Performance Plastics Corporation.

Torlon® is a registered trademark of Solvay Advanced Polymers, L.L.C.

Special Designs and Assemblies

Today's high technology products demand increasingly sophisticated bearing designs. NHBB stands ready to support your needs with:

- Custom designed bearings
- Concurrent engineering support
- State-of-the-art engineering software
- Ultraprecision components
- Leading edge automated production techniques
- Complete in-house manufacturing
- 60 years of experience in precision manufacturing and assembly
- Next-up bearing assemblies and subassemblies

Our experienced staff will help you design quality, cost-effective next-up bearing assemblies for your specific applications—and manufacture them in small or volume production quantities.

Below are a few examples of the unique designs and special features we offer. They include ceramic balls, machined retainers, anti-rotation slots, integral shields, extended rings, and custom double row configurations. Contact us to learn more about how we can assist you with your customization needs.

Special Assemblies



Bearing Pin Assembly



Pulley Assembly Bonded to Discrete Sealed Bearings



Double Row Miniature Cam Follower Assembly with Threaded Shaft



Pulley Assembly with Discrete Shielded and Flanged Bearings

Integral Duplex Designs



Flanged Integral Duplex Bearing with Extended Inner Ring



Integral Duplex Angular Contact Bearing

Custom Designs



Integral Shield, Custom Machined Retainer, Ceramic Balls



Double Row, Full Ball Complement



High Speed Dental Bearing with Integral Shield



Custom Machined Retainer, Ceramic Balls



Double Row, Spherical O.D.



Metric Radial Bearing with Anti-rotation Slots



Extended Outer Ring with Flange



High Speed Angular Contact Bearing with Custom Machined Retainer



End Cap for Gyro Application



Custom Flange with Mounting Holes



Shielded Miniature Double Row Bearing



Duplex Set with Matched Spacers

Part Numbering System

EXAMPLE: SSRI-418ZZEEA62HA5CXXP25LO1P
RIF-1438FA7P13LG49U

GROUP 1	GROUP 2	GROUP 3	GROUP 4	GROUP 5	GROUP 6	GROUP 7	GROUP 8
RING MATERIAL	BALL MATERIAL	TYPE	BASIC SIZE	SEALS & SHIELDS	MODIFICATIONS	DUPLEX PAIRS	PREMIUM FEATURES
pp. 47-48	pp. 47-48			p. 52		p. 57	
S	S	RI – RIF –	418 1438	ZZ	EEA62		

No Code=Chrome alloy steel (52100)

C=Chrome alloy steel (52100), used only in combination with ceramic balls (E)

D=400 series martensitic stainless steel

S=AISI stainless steel (440C)

SB=BG42®

X=Chrome alloy steel (52100), used only in combination with TiC-coated balls (T)

Y=Specialty alloy

No Code=Chrome alloy steel (52100)

E=Ceramic

S=AISI stainless steel (440C)

T=TiC-coated

F=Flanged, tapered O.D.

FR=Duplex pair with one flanged and one unflanged bearing

MBF=Inner ring relieved and separable, outer ring flanged and O.D. tapered

MBRI, MBR, MBL=Inner ring relieved and separable

MBRIF, MBRF, MBLF=Inner ring relieved and separable, flanged outer ring

MDF=Inner ring relieved and nonseparable, outer ring flanged and O.D. tapered

MDRI, MDR, MDL=Inner ring relieved and nonseparable

MDRIF, MDRF, MDLF=Inner ring relieved and nonseparable, flanged outer ring

MERI, MER, MEL=Outer ring relieved and nonseparable

MERIF, MERF, MELF=Outer ring relieved, flanged and nonseparable

RI, R, L=Radial

RIF, RF, LF=Flanged radial

RIFW, RFW, LFW=Flanged with nonstandard flange width

URI, UR=Double row radial

URIF=Double row radial, flanged

Special Series:

RA _ _ _=Pulley type assemblies; shaft assemblies; mechanical parts; tape guides; special bearings

Z=(followed by letter and numbers) Indicates end cap

Inch Series
First one or two digits indicate O.D. in 16ths of an inch. The following two or three digits indicate the bore size in a fraction of an inch, the first digit being the numerator and the second or the second and third digits being the denominator.

Metric Series
First two digits indicate O.D. in mm. Second two digits indicate I.D. in mm.

X=(following basic size) Indicates special internal design, assigned in numerical sequence, i.e., X1, X2, etc.

Enclosures

D=Single rubber seal

DD=Double rubber seal

D1=Single Viton® seal

DD1=Double Viton® seal

DO=Single seal on side opposite flange

DZ=Rubber seal and shield

H=Single metallic shield, nonremovable

HH=Double metallic shield, nonremovable

L=Single glass reinforced PTFE seal

LL=Double glass reinforced PTFE seal

L(L) BP=Glass reinforced PTFE seal(s) with metal backing plate(s)

LO=Single seal on side opposite flange

LZ=Glass reinforced PTFE seal and shield with seal on flange side

Q(Q)=Glass reinforced PTFE seal(s), lip riding

Q(Q)4=Glass reinforced PTFE seal(s) with protective shield(s), lip riding

S=Single rubber seal, noncontact

SS=Double rubber seal, noncontact

Z=Single metallic shield, removable

ZL=Shield and glass reinforced PTFE seal with shield on flange side

ZO=Single shield on side opposite flange

ZZ=Double metallic shield, removable

Extended Inner Ring

EE=Both sides

E=One side

Special External Dimension

A _ _=Larger than standard O.D.

A _ _ _=Larger O.D. than standard and special width

A=Semistandard, larger width and O.D. bearing

B=Special bore tolerance

G=Special external groove in bearing

N=Larger or smaller bore than standard

W=Wider than standard width

Y=Narrower than standard width

Special Design

CV=Special race curvature

SD=Special design bearing

Duplex

DB=Back-to-back configuration

DF=Face-to-face configuration

DT=Tandem configuration

DU=Universal duplex

Numbers following letter code indicate mean preload in pounds.

If not followed by a number, standard preload is applied.

MC=Premium ball & race finish for torque sensitive and ultra-high-speed applications

GROUP 9	GROUP 10	GROUP 11	GROUP 12	GROUP 13	GROUP 14	GROUP 15
CAGE	ABEC TOLERANCE	DIMENSIONAL CODING	RADIAL PLAY	TORQUE	LUBRICANT	PACKAGING
pp. 49-51	pp. 63-64	p. 61	pp. 53-54	p. 65	pp. 55-56	p. 8
H F	A5 A7	CXX	P25 P13		LO1 LG49	P U
<p>CR=Ribbon, PTFE coated</p> <p>F=Full ball complement</p> <p>H=Crown, land piloted</p> <p>J=Crown, acetal</p> <p>JM=Full type, acetal</p> <p>JN=Full type, molded acetal</p> <p>KB=Crown, phenolic, paper base</p> <p>KC=Crown, phenolic, linen base</p> <p>KF=Crown, phenolic, linen, nonkeyhole type, outer land piloted</p> <p>KG=Crown, phenolic, paper base, outer land piloted</p> <p>KM=Full type, phenolic, linen base</p> <p>KN=Full type, phenolic, paper base</p> <p>M4=Full type, polymer</p> <p>M5=Crown, polymer</p> <p>PH=PGM Hi-temp</p> <p>R=Ribbon, land piloted</p> <p>RD=Ribbon, ball piloted</p> <p>SC=Crown, silver plated polymer</p> <p>SF=Crown, silver plated polymer</p> <p>SL=Slug, PTFE</p> <p>T1=Specialty material</p> <p>TT=Toroids, PTFE</p>	<p>A1=ABEC 1*</p> <p>A3=ABEC 3, 3P</p> <p>A5=ABEC 5, 5P, 5T</p> <p>A7=ABEC 7, 7P, 7T</p> <p>A9=ABEC 9, 9P</p> <p>Note: Selected ABEC 9 tolerances are available on all sizes. Please consult factory.</p> <p>*A1 miniature and instrument bearings of both the metric and inch configurations meet the tolerances of ABMA Standard 20 for ABEC 1 metric series bearings.</p>	<p>C0X=O.D. coding only, .0001 increments</p> <p>CX0=I.D. coding only, .0001 increments</p> <p>CXX=I.D. and O.D. calibration in .0001 increments</p> <p>C04=O.D. coding only, .000050 increments</p> <p>C40=I.D. coding only, .000050 increments</p> <p>C44=I.D. and O.D. calibration in .000050 increments</p>	<p>P=Followed by two, three, or four numbers indicates the radial play limits in ten thousandths of an inch.</p> <p>Example: P25 indicates radial play of .0002" to .0005".</p> <p>PA ___ =Nominal axial play</p> <p>Example: PA015 indicates axial play of .0015</p> <p>PC __ =Nominal contact angle in degrees</p>	<p>RT=Followed by a number indicates maximum running torque in hundreds of mg-mm.</p> <p>Example: RT15 indicates a maximum running torque of 1,500 mg-mm.</p> <p>T=Followed by a number indicates maximum starting torque in hundreds of mg-mm.</p> <p>Example: T15 indicates a maximum starting torque of 1,500 mg-mm.</p>	<p>Lubricant letter codes are followed by a number to indicate specific type.</p> <p>BC=Following lubricant code indicates barrier coating.</p> <p>LB=Mixture of oil and solvent</p> <p>LD=Dry-no lubrication</p> <p>LF=Dry film</p> <p>LG=Greases</p> <p>LM=Mixture of oil and grease</p> <p>LO=Oils</p> <p>LRD=Temporary lube code</p> <p>LY=Expanded list of oils and greases</p> <p>Grease Plate Code (follows lubricant code)</p> <p>GPL=Light</p> <p>GPM=Medium</p> <p>GPH=Heavy</p>	<p>No Code=Plastic sealed vial</p> <p>B=Individual boxes</p> <p>E=Individual pack per MIL-B-22191</p> <p>K=Kraft foil package</p> <p>KB=Kraft bag and box</p> <p>P=Pill pack</p> <p>PB=Pill pack and box</p> <p>U=Unit pack</p> <p>UB=Unit pack and box</p>

IMPORTANT NOTE:

The NHBB numbering system identifies ball bearing size and design. This system is not a guide to create a customized ball bearing. Please use the numbering system to decipher the basic bearing numbers listed in this catalog, or to define a number given to you by a representative of NHBB. Please consult a member of the NHBB sales or engineering staff to help you design a new bearing or to interchange another manufacturer's part number.



16	Radial, Open, Unflanged
17	Radial, Open, Flanged
18	Radial, Shielded, Unflanged
19	Radial, Shielded, Flanged
20	Full Ball Complement, Radial, Open, Unflanged and Flanged
21	Full Ball Complement, Radial, Shielded, Unflanged and Flanged
22	Extended Inner Ring, Radial, Open, Unflanged and Flanged
23	Extended Inner Ring, Radial, Shielded, Unflanged and Flanged
24	Modified Dimension, Radial, Open, Unflanged and Flanged
25	Modified Dimension, Radial, Shielded, Unflanged and Flanged



Radial, Open, Unflanged



Ribbon Cage

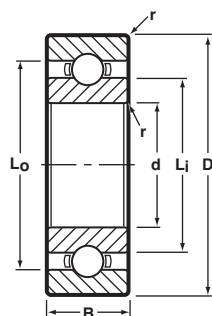

Crown Cage

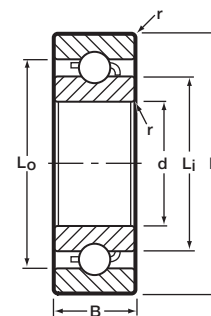

BASIC P/N	CAGE TYPE *		BORE d		O.D. D		WIDTH B		LAND DIAMETER (REFERENCE)		FILLET RADIUS r	BALL COMPLEMENT		LOAD RATINGS** LB.		BRG. WT. GMS. ▼
	RIBBON	CROWN	INCH	(mm) ◇	INCH	(mm) ◇	INCH	(mm) ◇	Li	Lo		NO. Z	SIZE Db	DYN. C	STATIC Co	
SSRI-2		H	.0400	1.016	.1250	3.175	.0469	1.191	.064	.100	.003	5	.025	9	3	.05
SSRI-2 1/2		H	.0469	1.191	.1562	3.967	.0625	1.588	.081	.124	.003	6	1/32	16	5	.15
SSRI-3		H	.0550	1.397	.1875	4.763	.0781	1.984	.093	.159	.003	5	3/64	28	10	.20
SSRI-4		H	.0781	1.984	.2500	6.350	.0937	2.380	.122	.193	.003	6	3/64	35	12	.50
SSRI-3332		H	.0937	2.380	.1875	4.763	.0625	1.588	.118	.161	.003	7	1/32	19	6	.10
SSRI-3332	R		.0937	2.380	.1875	4.763	.0625	1.588	.118	.161	.003	8	1/32	21	8	.10
SSRI-5	R	H	.0937	2.380	.3125	7.938	.1094	2.779	.173	.270	.003	6	1/16	60	22	.85
SSRI-418		H	.1250	3.175	.2500	6.350	.0937	2.380	.161	.216	.003	7	.0394	30	11	.35
SSRI-418	R		.1250	3.175	.2500	6.350	.0937	2.380	.161	.216	.003	8	.0394	33	12	.35
SSRI-518	R	H	.1250	3.175	.3125	7.938	.1094	2.779	.173	.270	.003	6	1/16	60	22	.70
SSRI-618	R	H	.1250	3.175	.3750	9.525	.1094	2.779	.173	.270	.005	6	1/16	60	22	1.30
SSR-2	R	H	.1250	3.175	.3750	9.525	.1562	3.967	.200	.300	.012	7	1/16	66	26	1.30
SSR-2A	R	H	.1250	3.175	.5000	12.700	.1719	4.366	.200	.300	.012	7	1/16	66	26	3.10
SSRI-5532		H	.1562	3.967	.3125	7.938	.1094	2.779	.221	.279	.003	7	3/64	41	15	.65
SSRI-5532	R		.1562	3.967	.3125	7.938	.1094	2.779	.221	.279	.003	8	3/64	45	17	.65
SSRI-5632		H	.1875	4.763	.3125	7.938	.1094	2.779	.221	.279	.003	7	3/64	41	15	.50
SSRI-5632	R		.1875	4.763	.3125	7.938	.1094	2.779	.221	.279	.003	8	3/64	45	17	.50
SSRI-6632	R	H	.1875	4.763	.3750	9.525	.1250	3.175	.235	.325	.003	8	1/16	76	31	.90
SSR-3	R	H	.1875	4.763	.5000	12.700	.1562	3.967	.276	.413	.012	7	3/32	140	59	2.60
SSRI-614		H	.2500	6.350	.3750	9.525	.1250	3.175	.285	.341	.003	13	.0394	43	21	.65
SSRI-814	R	H	.2500	6.350	.5000	12.700	.1250	3.175	.330	.431	.005	10	1/16	88	40	1.90
SSR-4	R	H	.2500	6.350	.6250	15.875	.1960	4.978	.364	.510	.012	8	3/32	159	70	4.40
SSRI-1214	R		.2500	6.350	.7500	19.050	.2188	5.558	.386	.597	.016	6	9/64	412	193	8.70
SSRI-8516	R		.3125	7.938	.5000	12.700	.1562	3.967	.362	.460	.005	11	1/16	93	43	1.60
SSRI-1038	R	H	.3750	9.525	.6250	15.875	.1562	3.967	.457	.542	.010	12	1/16	96	53	2.60
SSRI-1438	R		.3750	9.525	.8750	22.225	.2188	5.558	.521	.741	.016	7	5/32	569	273	8.80
SSRI-1412	R		.5000	12.700	.8750	22.225	.2188	5.558	.622	.752	.016	12	3/32	198	110	9.18
SSRI-1812	R		.5000	12.700	1.1250	28.575	.2500	6.350	.701	.913	.016	9	5/32	684	344	22.00
SSRI-2258	R		.6250	15.875	1.3750	34.925	.2812	7.142	.852	1.132	.031	8	7/32	1500	740	32.00
SSRI-2634 ♦			.7500	19.050	1.6250	41.275	.3125	7.938	1.019	1.345	.031	8	1/4	1900	980	43.00
SSRI-3078 ♦			.8750	22.225	1.8750	47.625	.3750	9.525	1.266	1.567	.031	10	1/4	2200	1300	95.00

Notes:

1. Inch to metric conversion—see page 68.
2. Basic part numbers shown above include code "SS" for AISI 440C stainless steel. If SAE 52100 chrome alloy steel is desired, delete "SS."
3. See page 63 for ABEC tolerances.
4. r=Maximum shaft or housing fillet radius that bearing corners will clear.
5. Open bearings may or may not have shield grooves (detail not shown in the above drawings). Consult the factory for reference information regarding the shield recess diameter.

- * "R" Ribbon or "H" Crown cages are available as indicated. Please consult with factory for machined cage availability.
- ◇ Metric dimensions are for reference only.
- ** Load ratings are based on ABMA Standard #12.
- ♦ Limited retainer options available. Please consult with factory.
- ▼ Bearing weights are for reference only.

Radial, Open, Flanged



Ribbon Cage

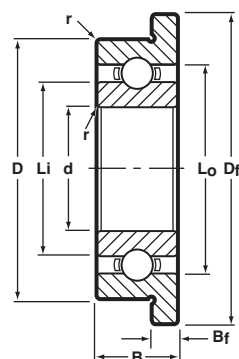

Crown Cage

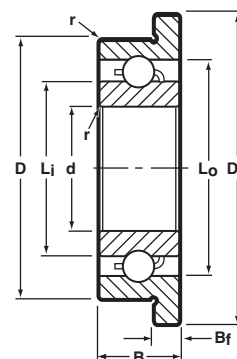

BASIC P/N	CAGE TYPE *		BORE d		O.D. D		WIDTH B		FLANGE DIA. D _f	FLANGE WIDTH B _f	LAND DIAMETER (REFERENCE)		FILLET RADIUS r	BALL COMPLEMENT		LOAD RATINGS** LB.		BRG. WT. GMS. ▼
	REBBIION	CROWN	INCH	(mm) ◊	INCH	(mm) ◊	INCH	(mm) ◊			L _i	L _o		NO. Z	SIZE D _b	DYN. C	STATIC C ₀	
SSRIF-2		H	.0400	1.016	.1250	3.175	.0469	1.191	.171	.013	.064	.100	.003	5	.025	9	3	.06
SSRIF-2 1/2		H	.0469	1.191	.1562	3.967	.0625	1.588	.203	.013	.081	.124	.003	6	1/32	16	5	.19
SSRIF-3		H	.0550	1.397	.1875	4.763	.0781	1.984	.234	.023	.093	.159	.003	5	3/64	28	10	.25
SSRIF-4		H	.0781	1.984	.2500	6.350	.0937	2.380	.296	.023	.122	.193	.003	6	3/64	35	12	.60
SSRIF-3332		H	.0937	2.380	.1875	4.763	.0625	1.588	.234	.018	.118	.161	.003	7	1/32	19	6	.14
SSRIF-3332	R		.0937	2.380	.1875	4.763	.0625	1.588	.234	.018	.118	.161	.003	8	1/32	21	8	.14
SSRIF-5	R	H	.0937	2.380	.3125	7.938	.1094	2.779	.359	.023	.173	.270	.003	6	1/16	60	22	.90
SSRIF-418		H	.1250	3.175	.2500	6.350	.0937	2.380	.296	.023	.161	.216	.003	7	.0394	30	11	.40
SSRIF-418	R		.1250	3.175	.2500	6.350	.0937	2.380	.296	.023	.161	.216	.003	8	.0394	33	12	.40
SSRIF-518	R	H	.1250	3.175	.3125	7.938	.1094	2.779	.359	.023	.173	.270	.003	6	1/16	60	22	.75
SSRIF-618	R	H	.1250	3.175	.3750	9.525	.1094	2.779	.422	.023	.173	.270	.005	6	1/16	60	22	1.40
SSRF-2	R	H	.1250	3.175	.3750	9.525	.1562	3.967	.440	.030	.200	.300	.012	7	1/16	66	26	1.40
SSRIF-5532		H	.1562	3.967	.3125	7.938	.1094	2.779	.359	.023	.221	.279	.003	7	3/64	41	15	.75
SSRIF-5532	R		.1562	3.967	.3125	7.938	.1094	2.779	.359	.023	.221	.279	.003	8	3/64	45	17	.75
SSRIF-5632		H	.1875	4.763	.3125	7.938	.1094	2.779	.359	.023	.221	.279	.003	7	3/64	41	15	.60
SSRIF-5632	R		.1875	4.763	.3125	7.938	.1094	2.779	.359	.023	.221	.279	.003	8	3/64	45	17	.60
SSRIF-6632	R	H	.1875	4.763	.3750	9.525	.1250	3.175	.422	.023	.235	.325	.003	8	1/16	76	31	.95
SSRF-3	R	H	.1875	4.763	.5000	12.700	.1562	3.967	.565	.042	.276	.413	.012	7	3/32	140	59	2.90
SSRIF-614		H	.2500	6.350	.3750	9.525	.1250	3.175	.422	.023	.285	.341	.003	13	.0394	43	21	.75
SSRIF-814	R	H	.2500	6.350	.5000	12.700	.1250	3.175	.547	.023	.330	.431	.005	10	1/16	88	40	2.20
SSRF-4	R	H	.2500	6.350	.6250	15.875	.1960	4.978	.690	.042	.364	.510	.012	8	3/32	159	70	4.60
SSRIF-8516	R		.3125	7.938	.5000	12.700	.1562	3.967	.547	.031	.362	.450	.005	11	1/16	93	43	1.80
SSRIF-1438	R		.3750	9.525	.8750	22.225	.2812	7.142	.969	.062	.521	.741	.016	7	5/32	569	273	12.00
SSRIF-1812	R		.5000	12.700	1.1250	28.575	.2500	6.350	1.225	.062	.701	.913	.016	9	5/32	684	344	22.00

Notes:

1. Inch to metric conversion—see page 68.
2. Basic part numbers shown above include code "SS" for AISI 440C stainless steel. If SAE 52100 chrome alloy steel is desired, delete "SS."
3. See page 63 for ABEC tolerances.
4. r=Maximum shaft or housing fillet radius that bearing corners will clear.
5. Open bearings may or may not have shield grooves (detail not shown in the above drawings). Consult the factory for reference information regarding the shield recess diameter.

- * "R" Ribbon or "H" Crown cages are available as indicated. Please consult with factory for machined cage availability.
- ◊ Metric dimensions are for reference only.
- ** Load ratings are based on ABMA Standard #12.
- ▼ Bearing weights are for reference only.



Radial, Shielded, Unflanged



Shielded Ribbon Cage

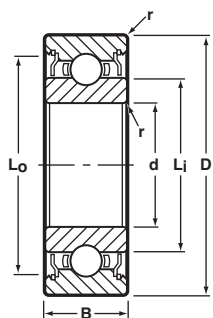

Shielded Crown Cage

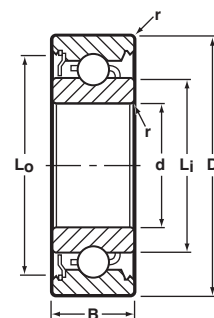

BASIC P/N	CAGE TYPE *		BORE d		O.D. D		WIDTH B				LAND DIAMETER (REFERENCE)		FILLET RADIUS r	BALL COMPLEMENT		LOAD RATINGS** LB.		BRG. WT. GMS. ▼
	RIBBON	CROWN	INCH	(mm) ◊	INCH	(mm) ◊	1 SHIELD		2 SHIELDS		Li	Lo		NO. Z	SIZE Db	DYN. C	STATIC Co	
							INCH	(mm) ◊	INCH	(mm) ◊								
SSRI-2 1/2ZZ		H	.0469	1.191	.1562	3.967	.0937	2.380	.0937	2.380	.081	.134	.003	6	1/32	16	5	.15
SSRI-3ZZ		H	.0550	1.397	.1875	4.763	.0937	2.380	.1094	2.779	.093	.167	.003	5	3/64	28	10	.20
SSRI-4ZZ		H	.0781	1.984	.2500	6.350	.1094	2.779	.1406	3.571	.122	.205	.003	6	3/64	35	12	.50
SSRI-3332ZZ		H	.0937	2.380	.1875	4.763	.0937	2.380	.0937	2.380	.118	.167	.003	7	1/32	19	6	.10
SSRI-3332ZZ	R		.0937	2.380	.1875	4.763	.0937	2.380	.0937	2.380	.118	.167	.003	8	1/32	21	8	.10
SSRI-5ZZ	R	H	.0937	2.380	.3125	7.938	.1094	2.779	.1406	3.571	.173	.282	.003	6	1/16	60	22	.85
SSRI-418ZZ		H	.1250	3.175	.2500	6.350	.0937	2.380	.1094	2.779	.161	.228	.003	7	.0394	30	11	.35
SSRI-418ZZ	R		.1250	3.175	.2500	6.350	.0937	2.380	.1094	2.779	.161	.228	.003	8	.0394	33	12	.35
SSRI-518ZZ	R	H	.1250	3.175	.3125	7.938	.1094	2.779	.1406	3.571	.173	.282	.003	6	1/16	60	22	.70
SSRI-618ZZ	R	H	.1250	3.175	.3750	9.525	.1094	2.779	.1406	3.571	.173	.282	.005	6	1/16	60	22	1.30
SSR-2ZZ	R	H	.1250	3.175	.3750	9.525	.1562	3.967	.1562	3.967	.200	.321	.012	7	1/16	66	26	1.30
SSR-2ZZA	R	H	.1250	3.175	.5000	12.700	.1719	4.366	.1719	4.366	.200	.321	.012	7	1/16	66	26	3.10
SSRI-1218ZZ	R		.1250	3.175	.7500	19.050	.1250	3.175	.1250	3.175	.225	.341	.010	8	1/16	76	30	3.10
SSRI-5532ZZ		H	.1562	3.967	.3125	7.938	.1094	2.779	.1250	3.175	.221	.287	.003	7	3/64	41	15	.65
SSRI-5532ZZ	R		.1562	3.967	.3125	7.938	.1094	2.779	.1250	3.175	.221	.287	.003	8	3/64	45	17	.65
SSRI-5632ZZ		H	.1875	4.763	.3125	7.938	.1094	2.779	.1250	3.175	.221	.287	.003	7	3/64	41	15	.50
SSRI-5632ZZ	R		.1875	4.763	.3125	7.938	.1094	2.779	.1250	3.175	.221	.287	.003	8	3/64	45	17	.50
SSRI-6632ZZ	R	H	.1875	4.763	.3750	9.525	.1250	3.175	.1250	3.175	.235	.341	.003	8	1/16	76	31	.90
SSR-3ZZ	R	H	.1875	4.763	.5000	12.700	.1960	4.978	.1960	4.978	.276	.435	.012	7	3/32	140	59	2.60
SSRI-614ZZ		H	.2500	6.350	.3750	9.525	.1250	3.175	.1250	3.175	.285	.348	.003	13	.0394	43	21	.65
SSRI-814ZZ	R	H	.2500	6.350	.5000	12.700	.1250	3.175	.1875	4.763	.330	.455	.005	10	1/16	88	40	1.90
SSR-4ZZ	R	H	.2500	6.350	.6250	15.875	.1960	4.978	.1960	4.978	.364	.544	.012	8	3/32	159	70	4.40
SSRI-1214ZZ	R		.2500	6.350	.7500	19.050	.2812	7.142	.2812	7.142	.341	.639	.016	6	9/64	412	192	8.70
SSRI-8516ZZ	R		.3125	7.938	.5000	12.700	.1562	3.967	.1562	3.967	.362	.460	.005	11	1/16	93	43	1.60
SSRI-1038ZZ	R		.3750	9.525	.6250	15.875	.1562	3.967	.1562	3.967	.458	.557	.010	12	1/16	96	53	2.60
SSRI-1438ZZ	R		.3750	9.525	.8750	22.225	.2812	7.142	.2812	7.142	.474	.783	.016	7	5/32	569	273	8.80
SSRI-1412ZZ	R		.5000	12.700	.8750	22.225	.2812	7.142	.2812	7.142	.622	.783	.016	12	3/32	198	110	9.78
SSRI-1812ZZ	R		.5000	12.700	1.1250	28.575	.3125	7.938	.3125	7.938	.628	.965	.016	9	5/32	684	344	22.00
SSRI-2258ZZ	R		.6250	15.875	1.3750	34.925	.3438	8.732	.3438	8.732	.852	1.235	.031	8	7/32	1500	740	34.00
SSRI-2634ZZ ♦			.7500	19.050	1.6250	41.275	.4375	11.112	.4375	11.112	1.019	1.345	.031	8	1/4	1900	980	46.00
SSRI-3078ZZ ♦			.8750	22.225	1.8750	47.625	.5000	12.700	.5000	12.700	1.266	1.567	.031	10	1/4	2200	1300	99.00

Notes:

1. Inch to metric conversion—see page 68.
2. Basic part numbers shown above include code "SS" for AISI 440C stainless steel. If SAE 52100 chrome alloy steel is desired, delete "SS."
3. See page 63 for ABEC tolerances.
4. r=Maximum shaft or housing fillet radius that bearing corners will clear.
5. For single shield eliminate one "Z" from the basic part number.

- * "R" Ribbon or "H" Crown cages are available as indicated. Please consult with factory for machined cage availability.
- ◊ Metric dimensions are for reference only.
- ** Load ratings are based on ABMA Standard #12.
- ♦ Limited retainer options available. Please consult with factory.
- ▼ Bearing weights are for reference only.

Radial, Shielded, Flanged

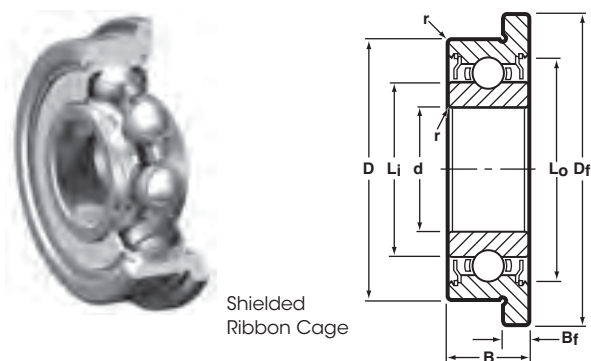

Shielded Ribbon Cage

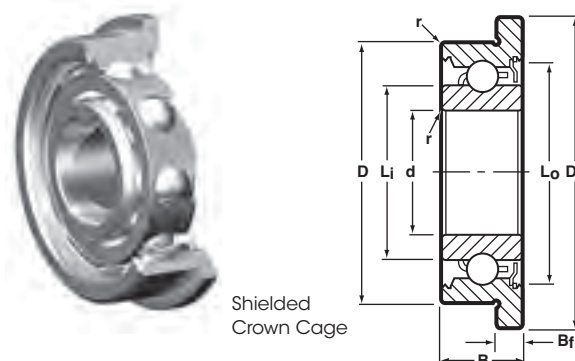

Shielded Crown Cage

BASIC P/N	CAGE TYPE *		BORE d		O.D. D		WIDTH B 1 or 2 SHIELDS		FLANGE DIA. D _f	FLANGE WIDTH B _f	LAND DIAMETER (REFERENCE)		FILLET RADIUS r	BALL COMPLEMENT		LOAD RATINGS** LB.		BRG. WT. GMS. ▼
	RIBBON	CROWN	INCH	(mm) ◊	INCH	(mm) ◊	INCH	(mm) ◊			L _i	L _o		NO. Z	SIZE D _b	DYN. C	STATIC C ₀	
SSRIF-2 1/2ZZ		H	.0469	1.191	.1562	3.967	.0937	2.380	.203	.031	.081	.134	.003	6	1/32	16	5	.19
SSRIF-3ZZ		H	.0550	1.397	.1875	4.763	.1094	2.779	.234	.031	.093	.167	.003	5	3/64	28	10	.25
SSRIF-4ZZ		H	.0781	1.984	.2500	6.350	.1406	3.571	.296	.031	.122	.205	.003	6	3/64	35	12	.60
SSRIF-3332ZZ		H	.0937	2.380	.1875	4.763	.0937	2.380	.234	.031	.118	.167	.003	7	1/32	19	6	.14
SSRIF-3332ZZ	R		.0937	2.380	.1875	4.763	.0937	2.380	.234	.031	.118	.167	.003	8	1/32	21	8	.14
SSRIF-5ZZ	R	H	.0937	2.380	.3125	7.938	.1406	3.571	.359	.031	.173	.282	.003	6	1/16	60	22	.90
SSRIF-418ZZ		H	.1250	3.175	.2500	6.350	.1094	2.779	.296	.031	.161	.228	.003	7	.0394	30	11	.40
SSRIF-418ZZ	R		.1250	3.175	.2500	6.350	.1094	2.779	.296	.031	.161	.228	.003	8	.0394	33	12	.40
SSRIF-518ZZ	R	H	.1250	3.175	.3125	7.938	.1406	3.571	.359	.031	.173	.282	.003	6	1/16	60	22	.75
SSRIF-618ZZ	R	H	.1250	3.175	.3750	9.525	.1406	3.571	.422	.031	.173	.282	.005	6	1/16	60	22	1.40
SSRF-2ZZ	R	H	.1250	3.175	.3750	9.525	.1562	3.967	.440	.030	.200	.321	.012	7	1/16	66	26	1.40
SSRIF-5532ZZ		H	.1562	3.967	.3125	7.938	.1250	3.175	.359	.036	.221	.285	.003	7	3/64	41	15	.75
SSRIF-5532ZZ	R		.1562	3.967	.3125	7.938	.1250	3.175	.359	.036	.221	.285	.003	8	3/64	45	17	.75
SSRIF-5632ZZ		H	.1875	4.763	.3125	7.938	.1250	3.175	.359	.036	.221	.287	.003	7	3/64	41	15	.60
SSRIF-5632ZZ	R		.1875	4.763	.3125	7.938	.1250	3.175	.359	.036	.221	.287	.003	8	3/64	45	17	.60
SSRIF-6632ZZ	R	H	.1875	4.763	.3750	9.525	.1250	3.175	.422	.031	.235	.341	.003	8	1/16	76	31	.95
SSRF-3ZZ	R	H	.1875	4.763	.5000	12.700	.1960	4.978	.565	.042	.276	.435	.012	7	3/32	140	59	2.90
SSRIF-614ZZ		H	.2500	6.350	.3750	9.525	.1250	3.175	.422	.036	.285	.348	.003	13	.0394	43	21	.75
SSRIF-814ZZ	R	H	.2500	6.350	.5000	12.700	.1875	4.763	.547	.045	.330	.455	.005	10	1/16	88	40	2.20
SSRF-4ZZ	R	H	.2500	6.350	.6250	15.875	.1960	4.978	.690	.042	.364	.544	.012	8	3/32	159	70	4.60
SSRIF-8516ZZ	R		.3125	7.938	.5000	12.700	.1562	3.967	.547	.031	.362	.460	.005	11	1/16	93	43	1.80
SSRIF-1438ZZ	R		.3750	9.525	.8750	22.225	.2812	7.142	.969	.062	.474	.783	.016	7	5/32	569	273	12.00
SSRIF-1812ZZ	R		.5000	12.700	1.1250	28.575	.3125	7.938	1.225	.062	.628	.965	.016	9	5/32	684	344	22.00

Notes:

1. Inch to metric conversion—see page 68.
2. Basic part numbers shown above include code "SS" for AISI 440C stainless steel. If SAE 52100 chrome alloy steel is desired, delete "SS."
3. See page 63 for ABEC tolerances.
4. r=Maximum shaft or housing fillet radius that bearing corners will clear.
5. For single shield eliminate one "Z" from the basic part number.

- * "R" Ribbon or "H" Crown cages are available as indicated. Please consult with factory for machined cage availability.
- ◊ Metric dimensions are for reference only.
- ** Load ratings are based on ABMA Standard #12.
- ▼ Bearing weights are for reference only.



Full Ball Complement, Radial, Open, Unflanged and Flanged



Unflanged

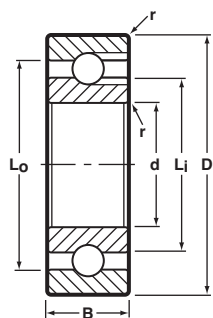

Flanged

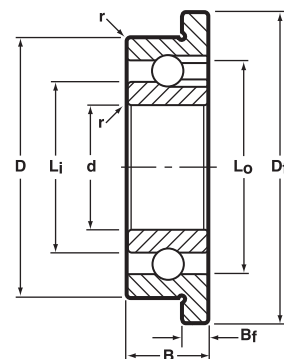

BASIC P/N †	BORE d		O.D. D		WIDTH B		FLANGE DIA. D _f	FLANGE WIDTH B _f	LAND DIAMETER (REFERENCE)		FILLET RADIUS r	BALL COMPLEMENT		LOAD RATINGS** LB.	
	INCH	(mm) ◊	INCH	(mm) ◊	INCH	(mm) ◊			L _i	L _o		NO. Z	SIZE D _b	DYN. C	STATIC C ₀
SSRI-2 1/2F	.0469	1.191	.1562	3.967	.0625	1.588	.203	.013	.081	.124	.003	10	1/32	22	9
SSRI-3F	.0550	1.397	.1875	4.763	.0781	1.984	.234	.023	.093	.159	.003	8	3/64	38	15
SSRI-4SD508F	.0781	1.984	.2362	6.000	.0937	2.380	—	—	.122	.193	.003	10	3/64	49	20
SSRI-4F	.0781	1.984	.2500	6.350	.0937	2.380	.296	.023	.122	.193	.003	10	3/64	49	20
SSRI-3332F	.0937	2.380	.1875	4.763	.0625	1.588	—	—	.118	.161	.003	13	1/32	33	14
SSRI-5SD507F	.0937	2.380	.3125	7.938	.1094	2.779	.359	.023	.182	.270	.003	11	1/16	102	47
SSRI-418F	.1250	3.175	.2500	6.350	.0937	2.380	.296	.023	.161	.216	.003	15	.0394	50	23
SSRI-518F	.1250	3.175	.3125	7.938	.1094	2.779	.359	.023	.182	.270	.003	11	1/16	102	47
SSRI-618F	.1250	3.175	.3750	9.525	.1094	2.779	.422	.023	.182	.270	.005	11	1/16	102	47
SSR-2F	.1250	3.175	.3750	9.525	.1562	3.967	.440	.030	.200	.300	.012	12	1/16	109	53
SSRI-5532F	.1562	3.967	.3125	7.938	.1094	2.779	.359	.023	.221	.279	.003	16	3/64	72	34
SSRI-5632F	.1875	4.763	.3125	7.938	.1094	2.779	.359	.023	.221	.279	.003	16	3/64	72	34
SSRI-6632F	.1875	4.763	.3750	9.525	.1250	3.175	.422	.023	.235	.342	.003	13	1/16	105	50
SSR-3F	.1875	4.763	.5000	12.700	.1562	3.967	.565	.042	.276	.413	.012	11	3/32	190	93
SSRI-614F	.2500	6.350	.3750	9.525	.1250	3.175	.422	.023	.285	.351	.003	24	.0394	65	39
SSRI-814F	.2500	6.350	.5000	12.700	.1250	3.175	.547	.023	.330	.431	.005	18	1/16	126	71
SSR-4F	.2500	6.350	.6250	15.875	.1960	4.978	.690	.042	.364	.510	.012	14	3/32	231	123
SSRI-1214F	.2500	6.350	.7500	19.050	.2188	5.558	—	—	.386	.597	.016	10	9/64	576	322
SSRI-8516F	.3125	7.938	.5000	12.700	.1562	3.967	.547	.031	.362	.460	.005	20	1/16	139	78
SSRI-1438F	.3750	9.525	.8750	22.225	.2188	5.558	—	—	.521	.741	.016	12	5/32	778	470
SSRI-1412F	.5000	12.700	.8750	22.225	.2188	5.558	—	—	.622	.750	.016	22	3/32	297	201

Notes:

1. Inch to metric conversion—see page 68.
 2. Basic part numbers shown above include code "SS" for AISI 440C stainless steel. If SAE 52100 chrome alloy steel is desired, delete "SS."
 3. See page 63 for ABEC tolerances.
 4. r=Maximum shaft or housing fillet radius that bearing corners will clear.
 5. Open bearings may or may not have shield grooves (detail not shown in the above drawings). Consult the factory for reference information regarding the shield recess diameter.
- † For flanged bearings substitute prefix "SSRIF-" or "SSRF-"
 ◊ Metric dimensions are for reference only.
 ** Load ratings are based on ABMA Standard #12.

Full Ball Complement, Radial, Shielded, Unflanged and Flanged



Unflanged
Shielded

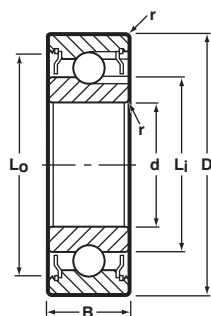

Flanged
Shielded

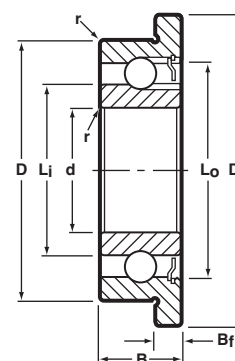

BASIC P/N †	BORE d		O.D. D		WIDTH B		FLANGE DIA. D _f	FLANGE WIDTH B _f	LAND DIAMETER (REFERENCE)		FILLET RADIUS r	BALL COMPLEMENT		LOAD RATINGS** LB.	
	INCH	(mm) ◊	INCH	(mm) ◊	INCH	(mm) ◊			L _i	L _o		NO. Z	SIZE D _b	DYN. C	STATIC C ₀
SSRI-2 1/2ZZF	.0469	1.191	.1562	3.967	.0937	2.380	.203	.031	.081	.134	.003	10	1/32	22	9
SSRI-3ZZF	.0550	1.397	.1875	4.763	.1094	2.779	.234	.031	.093	.167	.003	8	3/64	38	15
SSRI-4ZZF	.0781	1.984	.2500	6.350	.1406	3.571	.296	.031	.122	.205	.003	10	3/64	49	20
SSRI-3332ZZF	.0937	2.380	.1875	4.763	.0937	2.380	.234	.031	.118	.167	.003	13	1/32	33	14
SSRI-5ZZF	.0937	2.380	.3125	7.938	.1406	3.571	.359	.031	.182	.282	.003	11	1/16	102	47
SSRI-418ZZF	.1250	3.175	.2500	6.350	.1094	2.779	.296	.031	.161	.228	.003	15	.0394	50	23
SSRI-518ZZF	.1250	3.175	.3125	7.938	.1406	3.571	.359	.031	.182	.282	.003	11	1/16	102	47
SSRI-618ZZF	.1250	3.175	.3750	9.525	.1406	3.571	.422	.031	.182	.282	.005	11	1/16	102	47
SSR-2ZZF	.1250	3.175	.3750	9.525	.1562	3.967	.440	.030	.200	.321	.012	12	1/16	95	45
SSRI-5532ZZF	.1562	3.967	.3125	7.938	.1250	3.175	.359	.036	.221	.287	.003	16	3/64	72	34
SSRI-5632ZZF	.1875	4.763	.3125	7.938	.1250	3.175	.359	.036	.221	.287	.003	16	3/64	72	34
SSRI-6632ZZF	.1875	4.763	.3750	9.525	.1250	3.175	.422	.031	.235	.341	.003	13	1/16	105	50
SSRI-3ZZF	.1875	4.763	.5000	12.700	.1960	4.978	.565	.042	.276	.435	.012	11	3/32	190	93
SSRI-614ZZF	.2500	6.350	.3750	9.525	.1250	3.175	.422	.036	.285	.348	.003	24	.0394	65	39
SSRI-814ZZF	.2500	6.350	.5000	12.700	.1875	4.763	.547	.045	.330	.455	.005	18	1/16	126	71
SSR-4ZZF	.2500	6.350	.6250	15.875	.1960	4.978	.690	.042	.364	.544	.012	14	3/32	231	123
SSRI-1214ZZF	.2500	6.350	.7500	19.050	.2812	7.142	—	—	.341	.639	.016	10	9/64	576	322
SSRI-8516ZZF	.3125	7.938	.5000	12.700	.1562	3.967	.547	.031	.362	.460	.005	20	1/16	139	78
SSRI-1438ZZF	.3750	9.525	.8750	22.225	.2812	7.142	.969	.062	.474	.783	.016	12	5/32	778	470
SSRI-1412ZZF	.5000	12.700	.8750	22.225	.2812	7.142	—	—	.622	.783	.016	22	3/32	297	201

Notes:

- Inch to metric conversion—see page 68.
 - Basic part numbers shown above include code "SS" for AISI 440C stainless steel. If SAE 52100 chrome alloy steel is desired, delete "SS."
 - See page 63 for ABEC tolerances.
 - r=Maximum shaft or housing fillet radius that bearing corners will clear.
 - For single shield eliminate one "Z" from the basic part number.
- † For flanged bearings substitute prefix "SSRIF-" or "SSRF-."
 ◊ Metric dimensions are for reference only.
 ** Load ratings are based on ABMA Standard #12.



Extended Inner Ring, Radial, Open, Unflanged and Flanged



Unflanged Ribbon Cage

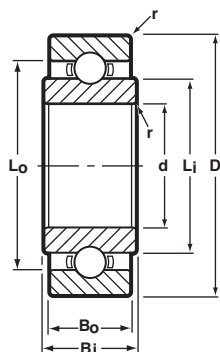

Flanged Ribbon Cage

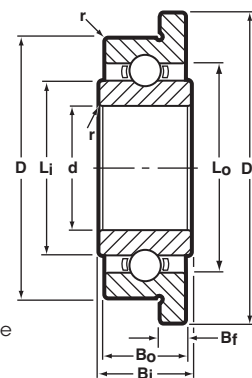

BASIC P/N †	CAGE TYPE *	BORE d		O.D. D		INNER WIDTH Bi		OUTER WIDTH Bo		FLANGE DIA. Df	FLANGE WIDTH Bf	LAND DIAMETER (REFERENCE)		FILLET RADIUS r	BALL COMPLEMENT		LOAD RATINGS** LB.	
		INCH	(mm) ◊	INCH	(mm) ◊	INCH	(mm) ◊	INCH	(mm) ◊			Li	Lo		NO. Z	SIZE Db	DYN. C	STATIC Co
SSRI-2EE	H	.0400	1.016	.1250	3.175	.0781	1.984	.0469	1.191	.171	.013	.059	.101	.003	5	.025	9	3
SSRI-2 1/2EE	H	.0469	1.191	.1562	3.967	.0937	2.380	.0625	1.588	.203	.013	.081	.124	.003	6	1/32	16	5
SSRI-3EE	H	.0550	1.397	.1875	4.763	.1094	2.779	.0781	1.984	.234	.023	.093	.159	.003	5	3/64	28	10
SSRI-4EE	H	.0781	1.984	.2500	6.350	.1250	3.175	.0937	2.380	.296	.023	.122	.193	.003	6	3/64	35	12
SSRI-3332EE	H	.0937	2.380	.1875	4.763	.0937	2.380	.0625	1.588	.234	.018	.118	.161	.003	7	1/32	19	6
SSRI-3332EE	R	.0937	2.380	.1875	4.763	.0937	2.380	.0625	1.588	.234	.018	.118	.161	.003	8	1/32	21	8
SSRI-5EE	R/H	.0937	2.380	.3125	7.938	.1406	3.571	.1094	2.779	.359	.023	.173	.270	.003	6	1/16	60	22
SSRI-418EE	H	.1250	3.175	.2500	6.350	.1250	3.175	.0937	2.380	.296	.023	.161	.230	.003	7	.0394	30	11
SSRI-418EE	R	.1250	3.175	.2500	6.350	.1250	3.175	.0937	2.380	.296	.023	.161	.230	.003	8	.0394	33	12
SSRI-518EE	R/H	.1250	3.175	.3125	7.938	.1406	3.571	.1094	2.779	.359	.023	.173	.287	.003	6	1/16	60	22
SSRI-618EE	R/H	.1250	3.175	.3750	9.525	.1406	3.571	.1094	2.779	.422	.023	.173	.287	.005	6	1/16	60	22
SSR-2EE	R/H	.1250	3.175	.3750	9.525	.1875	4.763	.1562	3.967	.440	.030	.200	.323	.012	7	1/16	66	26
SSRI-5532EE	H	.1562	3.967	.3125	7.938	.1406	3.571	.1094	2.779	.359	.023	.221	.279	.003	7	3/64	41	15
SSRI-5532EE	R	.1562	3.967	.3125	7.938	.1406	3.571	.1094	2.779	.359	.023	.221	.279	.003	8	3/64	45	17
SSRI-5632EE	H	.1875	4.763	.3125	7.938	.1406	3.571	.1094	2.779	.359	.023	.221	.279	.003	7	3/64	41	15
SSRI-5632EE	R	.1875	4.763	.3125	7.938	.1406	3.571	.1094	2.779	.359	.023	.221	.279	.003	8	3/64	45	17
SSRI-6632EE	R/H	.1875	4.763	.3750	9.525	.1562	3.967	.1250	3.175	.422	.023	.235	.343	.003	8	1/16	76	31
SSRI-614EE	H	.2500	6.350	.3750	9.525	.1562	3.967	.1250	3.175	.422	.023	.285	.350	.003	13	.0394	43	21
SSRI-814EE	R/H	.2500	6.350	.5000	12.700	.1562	3.967	.1250	3.175	.547	.023	.330	.431	.005	10	1/16	88	40
SSRI-8516EE	R	.3125	7.938	.5000	12.700	.1875	4.763	.1562	3.967	.547	.031	.362	.460	.005	11	1/16	93	43

Notes:

1. Inch to metric conversion—see page 68.
2. Basic part numbers shown above include code "SS" for AISI 440C stainless steel. If SAE 52100 chrome alloy steel is desired, delete "SS."
3. See page 63 for ABEC tolerances.
4. r=Maximum shaft or housing fillet radius that bearing corners will clear.
5. Open bearings may or may not have shield grooves (detail not shown in the above drawings). Consult the factory for reference information regarding the shield recess diameter.

† For flanged bearings substitute prefix "SSRIF-" or "SSRF-."

* "R" Ribbon or "H" Crown cages are available as indicated. Please consult with factory for machined cage availability.

◊ Metric dimensions are for reference only.

** Load ratings are based on ABMA Standard #12.

Extended Inner Ring, Radial, Shielded, Unflanged and Flanged



Unflanged
Shielded
Ribbon Cage

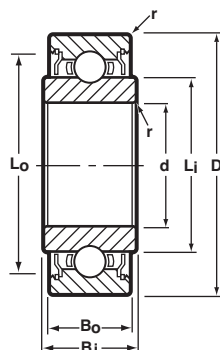

Flanged
Shielded
Ribbon Cage

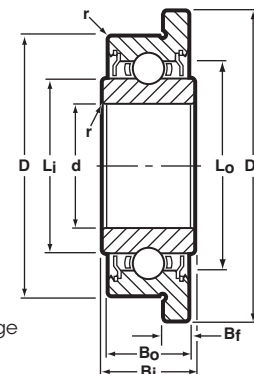

BASIC P/N †	CAGE TYPE *	BORE d		O.D. D		INNER WIDTH Bi		OUTER WIDTH Bo		FLANGE DIA. Df	FLANGE WIDTH Bf	LAND DIAMETER (REFERENCE)		FILLET RADIUS r	BALL COMPLEMENT		LOAD RATINGS** LB.	
		INCH	(mm) ◊	INCH	(mm) ◊	INCH	(mm) ◊	INCH	(mm) ◊			Li	Lo		NO. Z	SIZE Db	DYN. C	STATIC Co
SSRI-2 1/2ZZEE	H	.0469	1.191	.1562	3.967	.1250	3.175	.0937	2.380	.203	.031	.081	.134	.003	6	1/32	16	5
SSRI-3ZZEE	H	.0550	1.397	.1875	4.763	.1406	3.571	.1094	2.779	.234	.031	.093	.167	.003	5	3/64	28	10
SSRI-4ZZEE	H	.0781	1.984	.2500	6.350	.1719	4.366	.1406	3.571	.296	.031	.122	.205	.003	6	3/64	35	12
SSRI-3332ZZEE	H	.0937	2.380	.1875	4.763	.1250	3.175	.0937	2.380	.234	.031	.118	.167	.003	7	1/32	19	6
SSRI-3332ZZEE	R	.0937	2.380	.1875	4.763	.1250	3.175	.0937	2.380	.234	.031	.118	.167	.003	8	1/32	21	8
SSRI-5ZZEE	R/H	.0937	2.380	.3125	7.938	.1719	4.366	.1406	3.571	.359	.031	.173	.282	.003	6	1/16	60	22
SSRI-418ZZEE	H	.1250	3.175	.2500	6.350	.1406	3.571	.1094	2.779	.296	.031	.161	.228	.003	7	.0394	30	11
SSRI-418ZZEE	R	.1250	3.175	.2500	6.350	.1406	3.571	.1094	2.779	.296	.031	.161	.228	.003	8	.0394	33	12
SSRI-518ZZEE	R/H	.1250	3.175	.3125	7.938	.1719	4.366	.1406	3.571	.359	.031	.173	.282	.003	6	1/16	60	22
SSRI-618ZZEE	R/H	.1250	3.175	.3750	9.525	.1719	4.366	.1406	3.571	.422	.031	.173	.282	.005	6	1/16	60	22
SSR-2ZZEE	R/H	.1250	3.175	.3750	9.525	.1875	4.763	.1562	3.967	.440	.030	.200	.321	.012	7	1/16	66	26
SSRI-5532ZZEE	H	.1562	3.967	.3125	7.938	.1562	3.967	.1250	3.175	.359	.036	.221	.287	.003	7	3/64	41	15
SSRI-5532ZZEE	R	.1562	3.967	.3125	7.938	.1562	3.967	.1250	3.175	.359	.036	.221	.287	.003	8	3/64	45	17
SSRI-5632ZZEE	H	.1875	4.763	.3125	7.938	.1562	3.967	.1250	3.175	.359	.036	.221	.287	.003	7	3/64	41	15
SSRI-5632ZZEE	R	.1875	4.763	.3125	7.938	.1562	3.967	.1250	3.175	.359	.036	.221	.287	.003	8	3/64	45	17
SSRI-6632ZZEE	R/H	.1875	4.763	.3750	9.525	.1562	3.967	.1250	3.175	.422	.031	.235	.341	.003	8	1/16	76	31
SSR-3ZZEE	R/H	.1875	4.763	.5000	12.700	.2272	5.771	.1960	4.978	.565	.042	.276	.435	.012	7	3/32	140	59
SSRI-614ZZEE	H	.2500	6.350	.3750	9.525	.1562	3.967	.1250	3.175	.422	.036	.285	.348	.003	13	.0394	43	21
SSRI-814ZZEE	R/H	.2500	6.350	.5000	12.700	.2188	5.558	.1875	4.763	.547	.045	.330	.455	.005	10	1/16	88	40
SSR-4ZZEE	R/H	.2500	6.350	.6250	15.875	.2260	5.740	.1960	4.978	.690	.042	.364	.544	.012	8	3/32	159	70
SSRI-8516ZZEE	R	.3125	7.938	.5000	12.700	.1875	4.763	.1562	3.967	.547	.031	.362	.460	.005	11	1/16	93	43

Notes:

- Inch to metric conversion—see page 68.
- Basic part numbers shown above include code "SS" for AISI 440C stainless steel. If SAE 52100 chrome alloy steel is desired, delete "SS."
- See page 63 for ABEC tolerances.
- r=Maximum shaft or housing fillet radius that bearing corners will clear.
- For single shield eliminate one "Z" from the basic part number.

† For flanged bearings substitute prefix "SSRIF-" or "SSRF-."

* "R" Ribbon or "H" Crown cages are available as indicated. Please consult with factory for machined cage availability.

◊ Metric dimensions are for reference only.

** Load ratings are based on ABMA Standard #12.



Modified Dimension, Radial, Open, Unflanged and Flanged



Unflanged Ribbon Cage

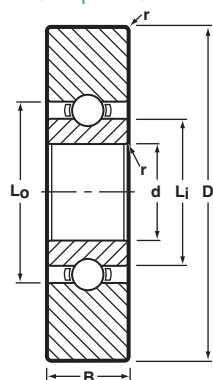

Flanged Crown Cage

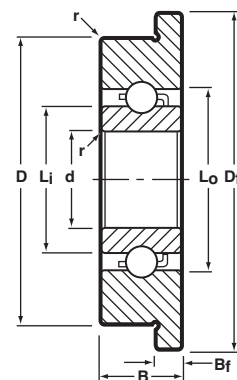

BASIC P/N	CAGE TYPE *	BORE d		O.D. D		WIDTH B		FLANGE DIA. D _f	FLANGE WIDTH B _f	LAND DIAMETER (REFERENCE)		FILLET RADIUS r	BALL COMPLEMENT		LOAD RATINGS** LB.	
		INCH	(mm) ∅	INCH	(mm) ∅	INCH	(mm) ∅			L _i	L _o		NO. Z	SIZE D _b	DYN. C	STATIC C ₀
SSRIF-2 ▲	H	.0400	1.016	.1250	3.175	.0469	1.191	.171	.013	.064	.101	.003	5	.025	5	3
SSRIF-3332SD503 ▲	R	.0781	1.984	.1875	4.763	.0625	1.588	.226	.018	.118	.161	.003	8	1/32	35	14
SSRIF-418SD513 ▲	R	.0781	1.984	.2500	6.350	.0625	1.588	.296	.018	.161	.216	.003	8	.0394	53	22
SSRI-3332N1MC*	KC/M5	.0925	2.350	.1875	4.763	.0625	1.588	—	—	.118	.161	.003	7	1/32	19	6
SSRI-3332A02	H	.0937	2.380	.3125	7.938	.0625	1.588	—	—	.118	.161	.003	7	1/32	19	6
SSRI-3332A02	R	.0937	2.380	.3125	7.938	.0625	1.588	—	—	.118	.161	.003	8	1/32	21	8
SSRI-418A62N	H	.0937	2.380	.4250	10.795	.0937	2.380	—	—	.161	.216	.003	7	.0394	30	11
SSRI-418A62N	R	.0937	2.380	.4250	10.795	.0937	2.380	—	—	.161	.216	.003	8	.0394	33	12
SSRI-5A62	H	.0937	2.380	.4500	11.430	.1094	2.779	—	—	.173	.270	.003	6	1/16	60	22
SSRI-418N1	H	.0947	2.405	.2500	6.350	.0937	2.380	—	—	.161	.216	.003	7	.0394	30	11
SSRI-418N1	R	.0947	2.405	.2500	6.350	.0937	2.380	—	—	.161	.216	.003	8	.0394	33	12
SSRI-3 1/2 18	R/H	.1250	3.175	.2188	5.558	.0937	2.380	—	—	.150	.193	.005	7	1/32	21	7
SSRI-418Y02	H	.1250	3.175	.2500	6.350	.0625	1.588	—	—	.171	.214	.003	9	1/32	23	9
SSRIFW-518 ▲	R/H	.1250	3.175	.3125	7.938	.1094	2.779	.359	.029	.173	.270	.003	6	1/16	60	22
SSRIF-518Y04CV52	R	.1250	3.175	.3125	7.938	.0937	2.380	.359	.023	.173	.271	.003	6	1/16	60	22
SSRI-418A0223	H	.1250	3.175	.3750	9.525	.0650	1.651	—	—	.171	.214	.003	9	1/32	23	9
SSRIF-618SD504 ▲	H	.1250	3.175	.3750	9.525	.1094	2.779	.412	.023	.173	.270	.005	6	1/16	60	22
SSRIF-518A91	R/H	.1250	3.175	.4100	10.414	.1094	2.779	.438	.023	.173	.270	.003	6	1/16	60	22
SSRI-518A62	H	.1250	3.175	.4500	11.430	.1094	2.779	—	—	.173	.270	.003	6	1/16	60	22
SSRI-518A03	R/H	.1250	3.175	.5000	12.700	.1094	2.779	—	—	.173	.270	.003	6	1/16	60	22
SSRIF-5532A91 ▲	H	.1562	3.967	.4100	10.414	.1094	2.779	.438	.023	.221	.279	.003	7	3/64	41	15
SSRIF-5532A91 ▲	R	.1562	3.967	.4100	10.414	.1094	2.779	.438	.023	.221	.279	.003	8	3/64	45	17
SSR-3X8LLW20	R	.1875	4.763	.5000	12.700	.3125	7.938	—	—	.243	.434	.012	7	3/32	140	59
SSRI-614Y05	H	.2500	6.350	.3750	9.525	.1094	2.779	—	—	.285	.341	.003	13	.0394	43	21
SSRIF-814X3 ▲	R	.2500	6.350	.5000	12.700	.1250	3.175	.547	.023	.315	.433	.005	8	5/64	114	48
SSRI-1038Y06	R	.3750	9.525	.6250	15.875	.1250	3.175	—	—	.458	.541	.010	12	1/16	95	49
SSRIF-1438SD503 ▲	R	.3750	9.525	.8750	22.225	.2188	5.558	.969	.062	.521	.741	.016	7	5/32	569	273

Notes:

- Inch to metric conversion—see page 68.
 - Basic part numbers shown above include code "SS" for AISI 440C stainless steel. If SAE 52100 chrome alloy steel is desired, delete "SS."
 - See page 63 for ABEC tolerances.
 - r=Maximum shaft or housing fillet radius that bearing corners will clear.
 - Open bearings may or may not have shield grooves (detail not shown in the above drawings). Consult the factory for reference information regarding the shield recess diameter.
- * "R" Ribbon or "H" Crown cages are available as indicated. Please consult with factory for machined cage availability unless already noted.
 - ∅ Metric dimensions are for reference only.
 - ▲ Available only as flanged type.
 - ** Load ratings are based on ABMA Standard #12.

Modified Dimension, Radial, Shielded, Unflanged and Flanged



Unflanged
Shielded
Ribbon Cage

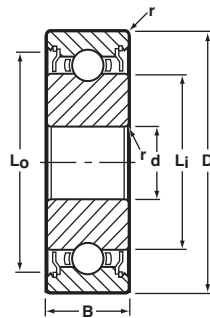

Flanged
Shielded
Crown Cage

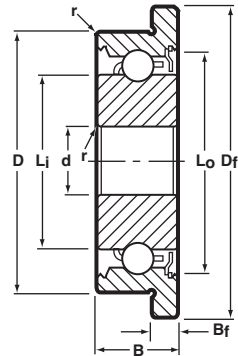

BASIC P/N	CAGE TYPE *	BORE d		O.D. D		WIDTH B				FLANGE DIA. D _f	FLANGE WIDTH B _f	LAND DIAMETER (REFERENCE)		FILLET RADIUS r	BALL COMPLEMENT		LOAD RATINGS**	
		INCH	(mm) \diamond	INCH	(mm) \diamond	1 SHIELD		2 SHIELDS				L _i	L _o		NO. Z	SIZE D _b	DYN. C	STATIC C ₀
						INCH	(mm) \diamond	INCH	(mm) \diamond									
SSRI-2 1/2ZZA11	H	.0469	1.191	.1875	4.763	—	—	.0937	2.380	—	—	.081	.134	.003	6	1/32	16	5
SSRIF-418ZSD516 ▲	R	.0781	1.984	.2500	6.350	—	—	.0937	2.380	.296	.018	.161	.228	.003	8	.0394	53	22
SSRI-4ZZY05	H	.0781	1.984	.2500	6.350	—	—	.1094	2.779	—	—	.122	.205	.003	7	.0394	29	10
SSRI-4ZYN6	H	.0800	2.032	.2500	6.350	.1094	2.779	—	—	—	—	.122	.205	.003	6	3/64	35	12
SSRI-5ZN	R	.0902	2.291	.3125	7.938	.1094	2.779	—	—	—	—	.188	.270	.003	8	3/64	44	17
SSRI-3332ZZN4MC*	KC/M5	.0932	2.367	.1875	4.763	—	—	.0937	2.380	—	—	.118	.167	.003	7	1/32	19	6
SSRI-418ZN	H	.0937	2.380	.2500	6.350	.0937	2.380	—	—	—	—	.161	.228	.003	7	.0394	30	11
SSRI-418ZZN	H	.0937	2.380	.2500	6.350	—	—	.1094	2.779	—	—	.161	.228	.003	7	.0394	30	11
SSRI-418ZN	R	.0937	2.380	.2500	6.350	.0937	2.380	—	—	—	—	.161	.228	.003	8	.0394	33	12
SSRI-418ZZN	R	.0937	2.380	.2500	6.350	—	—	.1094	2.779	—	—	.161	.228	.003	8	.0394	33	12
SSRI-418ZZY04N	R	.0937	2.380	.2500	6.350	—	—	.0937	2.380	—	—	.161	.228	.003	8	.0394	33	12
SSRI-3332ZSD501	R	.0937	2.380	.2750	6.985	.0625	1.588	—	—	—	—	.118	.187	.003	8	1/32	21	7
SSRI-3332ZA1202	R	.0937	2.380	.2883	7.323	.0625	1.588	—	—	—	—	.118	.187	.003	8	1/32	21	8
SSRI-5ZA91	R	.0937	2.380	.4100	10.414	.1094	2.779	—	—	—	—	.173	.282	.003	6	1/16	60	22
SSRI-518ZA91N	R/H	.0937	2.380	.4100	10.414	.1094	2.779	—	—	—	—	.173	.282	.003	6	1/16	60	22
SSRI-418ZZY04	R	.1250	3.175	.2500	6.350	—	—	.0937	2.380	—	—	.161	.228	.003	8	.0394	33	12
SSRI-418ZW05	H	.1250	3.175	.2500	6.350	.1094	2.779	—	—	—	—	.161	.228	.003	7	.0394	30	11
SSRI-418ZW05	R	.1250	3.175	.2500	6.350	.1094	2.779	—	—	—	—	.161	.228	.003	8	.0394	33	12
SSRI-518ZZY05	R	.1250	3.175	.3125	7.938	—	—	.1094	2.779	—	—	.188	.270	.003	8	3/64	44	17
SSRI-418ZA02	R	.1250	3.175	.3750	9.525	.0937	2.380	—	—	—	—	.161	.228	.003	8	.0394	33	12
SSRI-418ZZA0204	R	.1250	3.175	.3750	9.525	—	—	.0937	2.380	—	—	.161	.228	.003	8	.0394	33	12
SSRI-618ZZY05	R/H	.1250	3.175	.3750	9.525	—	—	.1094	2.779	—	—	.188	.270	.005	8	3/64	44	17
SSRIF-618ZSD509 ▲	R	.1250	3.175	.3750	9.525	.1406	3.571	—	—	.500	.040	.173	.282	.005	6	1/16	60	22
SSRI-418ZA72	H	.1250	3.175	.4100	10.414	.0937	2.380	—	—	—	—	.161	.228	.003	7	.0394	30	11
SSRI-418ZA72	R	.1250	3.175	.4100	10.414	.0937	2.380	—	—	—	—	.161	.228	.003	8	.0394	33	12
SSRI-518ZA91	R	.1250	3.175	.4100	10.414	.1094	2.779	—	—	—	—	.173	.282	.003	6	1/16	60	22
SSRI-418ZA62	H	.1250	3.175	.4250	10.795	.0937	2.380	—	—	—	—	.161	.228	.003	7	.0394	30	11
SSRI-418ZZA62	H	.1250	3.175	.4250	10.795	—	—	.1094	2.779	—	—	.161	.228	.003	7	.0394	30	11
SSRI-418ZA62	R	.1250	3.175	.4250	10.795	.0937	2.380	—	—	—	—	.161	.228	.003	8	.0394	33	12
SSRI-418ZZA62	R	.1250	3.175	.4250	10.795	—	—	.1094	2.779	—	—	.161	.228	.003	8	.0394	33	12
SSRI-518ZA71	R/H	.1250	3.175	.4250	10.795	.1094	2.779	—	—	—	—	.173	.282	.003	6	1/16	60	22
SSRI-418ZA03	R	.1250	3.175	.4375	11.113	.0937	2.380	—	—	—	—	.161	.228	.003	8	.0394	33	12
SSRI-418ZZA0304	R	.1250	3.175	.4375	11.113	—	—	.0937	2.380	—	—	.161	.228	.003	8	.0394	33	12
SSRI-518ZZA0305	R	.1250	3.175	.5000	12.700	—	—	.1094	2.779	—	—	.188	.270	.003	8	3/64	44	17
SSR-2ZZA01	R/H	.1250	3.175	.5000	12.700	—	—	.1562	3.967	—	—	.200	.321	.012	7	1/16	66	26

Notes:

- Inch to metric conversion—see page 68.
 - Basic part numbers shown above include code "SS" for AISI 440C stainless steel. If SAE 52100 chrome alloy steel is desired, delete "SS."
 - See page 63 for ABEC tolerances.
 - r=Maximum shaft or housing fillet radius that bearing corners will clear.
- * "R" Ribbon or "H" Crown cages are available as indicated. Please consult with factory for machined cage availability unless already noted.
- \diamond Metric dimensions are for reference only.
- ▲ Available only as flanged type.
- ** Load ratings are based on ABMA Standard #12.

Modified Dimension, Radial, Shielded, Unflanged and Flanged (continued)



Unflanged Shielded Ribbon Cage

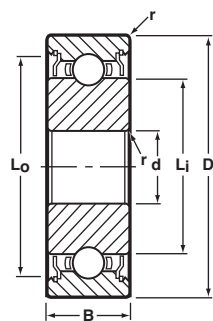

Flanged Shielded Crown Cage

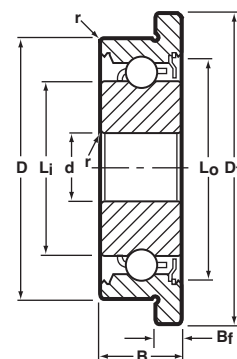

BASIC P/N	CAGE TYPE *	BORE d		O.D. D		WIDTH B				FLANGE DIA. Df	FLANGE WIDTH Bf	LAND DIAMETER (REFERENCE)		FILLET RADIUS r	BALL COMPLEMENT		LOAD RATINGS** LB.	
		INCH	(mm) ◊	INCH	(mm) ◊	1 SHIELD		2 SHIELDS				Li	Lo		NO. Z	SIZE Db	DYN. C	STATIC Co
						INCH	(mm) ◊	INCH	(mm) ◊									
SSRI-814ZSD524	R/H	.1250	3.175	.5000	12.700	.1250	3.175	—	—	—	—	.330	.452	.005	10	1/16	88	40
SSRIF-814ZSD504 ▲	H	.1250	3.175	.5000	12.700	.1250	3.175	—	—	.547	.023	.330	.452	.005	10	1/16	88	40
SSRI-6632ZZSD510	R	.1250	3.175	.5769	14.653	—	—	.1250	3.175	—	—	.235	.341	.003	8	1/16	76	31
SSRI-6632ZZSD509	H	.1250	3.175	.7500	19.050	—	—	.1250	3.175	—	—	.235	.341	.003	8	1/16	76	31
SSR-2ZZSD513	H	.1562	3.967	.3750	9.525	—	—	.1562	3.967	—	—	.200	.300	.012	7	1/16	66	26
SSRI-6632ZZSD508	R	.1567	3.980	.3750	9.525	—	—	.1250	3.175	—	—	.235	.341	.003	8	1/16	76	31
SSR-2ZZSD502	R/H	.1567	3.980	.3750	9.525	—	—	.1562	3.967	—	—	.200	.323	.012	7	1/16	66	26
SSRI-5632XZ	R	.1875	4.763	.3125	7.938	.1094	2.779	—	—	—	—	.224	.285	.003	11	.0394	40	17
SSRI-5632XZZY05	R	.1875	4.763	.3125	7.938	—	—	.1094	2.779	—	—	.224	.285	.003	11	.0394	40	17
SSRIF-5632XZZ ▲	R	.1875	4.763	.3125	7.938	—	—	.1250	3.175	.359	.036	.224	.285	.003	11	.0394	40	17
SSRI-5632XZZA0105	R	.1875	4.763	.3750	9.525	—	—	.1094	2.779	—	—	.224	.286	.003	11	.0394	39	17
SSRI-6632XZY05	H	.1875	4.763	.3750	9.525	.1094	2.779	—	—	—	—	.221	.285	.003	7	3/64	41	15
SSRI-6632XZY05	R	.1875	4.763	.3750	9.525	.1094	2.779	—	—	—	—	.221	.285	.003	8	3/64	45	17
SSRI-5632ZA91	H	.1875	4.763	.4100	10.414	.1094	2.779	—	—	—	—	.221	.285	.003	7	3/64	41	15
SSRI-5632ZA91	R	.1875	4.763	.4100	10.414	.1094	2.779	—	—	—	—	.221	.285	.003	8	3/64	45	17
SSRI-5632ZZA71	H	.1875	4.763	.4250	10.795	—	—	.1250	3.175	—	—	.221	.285	.003	7	3/64	41	15
SSRI-5632ZA71	R	.1875	4.763	.4250	10.795	.1094	2.779	—	—	—	—	.221	.285	.003	8	3/64	45	17
SSRI-5632ZZA71	R	.1875	4.763	.4250	10.795	—	—	.1250	3.175	—	—	.221	.285	.003	8	3/64	45	17
SSRI-5632XZZA0205	R	.1875	4.763	.4375	11.113	—	—	.1094	2.779	—	—	.224	.285	.003	11	.0394	40	17
SSRI-6632ZA6105	R	.1875	4.763	.4600	11.684	.1094	2.779	—	—	—	—	.235	.341	.003	8	1/16	76	31
SSRI-6632ZA0205	R	.1875	4.763	.5000	12.700	.1094	2.779	—	—	—	—	.235	.341	.003	8	1/16	76	31
SSRI-5632ZZA03	H	.1875	4.763	.5000	12.700	—	—	.1250	3.175	—	—	.221	.285	.003	7	3/64	41	15
SSRI-5632ZZA03	R	.1875	4.763	.5000	12.700	—	—	.1250	3.175	—	—	.221	.285	.003	8	3/64	45	17
SSRI-6632ZZA0208	R/H	.1875	4.763	.5000	12.700	—	—	.1562	3.967	—	—	.235	.341	.008	8	1/16	76	31
SSRIF-6632ZZA0208	R/H	.1875	4.763	.5000	12.700	—	—	.1562	3.967	.565	.042	.235	.341	.008	8	1/16	76	31
SSR-3ZZY08	R	.1875	4.763	.5000	12.700	—	—	.1562	3.967	—	—	.295	.441	.012	8	.0787	112	49
SSRIF-814ZSD503 ▲	H	.1875	4.763	.5000	12.700	.1250	3.175	—	—	.547	.023	.330	.452	.005	10	1/16	88	40
SSR-3ZZA	R/H	.1875	4.763	.6250	15.875	—	—	.1960	4.978	—	—	.276	.433	.012	7	3/32	140	59
SSR-3ZZA42	R/H	.1875	4.763	.7435	18.885	—	—	.1960	4.978	—	—	.276	.433	.012	7	3/32	140	59
SSR-3ZZA02	R/H	.1875	4.763	.7500	19.050	—	—	.1960	4.978	—	—	.276	.433	.012	7	3/32	140	59
SSR-3ZZA62	R/H	.1875	4.763	.7717	19.601	—	—	.1960	4.978	—	—	.276	.433	.012	7	3/32	140	59
SSR-3ZZA03	R	.1875	4.763	.8750	22.225	—	—	.1960	4.978	—	—	.279	.433	.012	7	3/32	140	59
SSR-3ZZW20	R/H	.1875	4.763	.5000	12.700	—	—	.3125	7.938	—	—	.276	.433	.012	7	3/32	140	59
SSRI-614ZZA01	H	.2500	6.350	.4375	11.113	—	—	.1250	3.175	—	—	.285	.348	.003	13	.0394	43	21
SSRI-614ZA0205	H	.2500	6.350	.5000	12.700	.1094	2.779	—	—	—	—	.285	.348	.003	13	.0394	43	21

Notes:

1. Inch to metric conversion—see page 68.
 2. Basic part numbers shown above include code "SS" for AISI 440C stainless steel. If SAE 52100 chrome alloy steel is desired, delete "SS."
 3. See page 63 for ABEC tolerances.
 4. r=Maximum shaft or housing fillet radius that bearing corners will clear.
- * "R" Ribbon or "H" Crown cages are available as indicated. Please consult with factory for machined cage availability.
 - ◊ Metric dimensions are for reference only.
 - ▲ Available only as flanged type.
 - ** Load ratings are based on ABMA Standard #12.

Modified Dimension, Radial, Shielded, Unflanged and Flanged (continued)



Unflanged
Shielded
Ribbon Cage

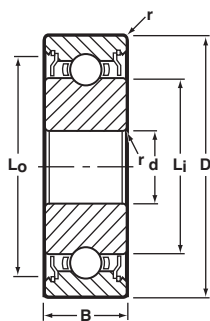

Flanged
Shielded
Crown Cage

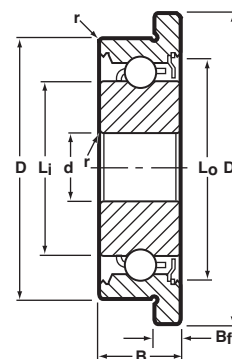

BASIC P/N	CAGE TYPE *	BORE d		O.D. D		WIDTH B				FLANGE DIA. D _f	FLANGE WIDTH B _f	LAND DIAMETER (REFERENCE)		FILLET RADIUS r	BALL COMPLEMENT		LOAD RATINGS**	
		INCH	(mm) ∅	INCH	(mm) ∅	1 SHIELD		2 SHIELDS				L _i	L _o		NO. Z	SIZE D _b	DYN. C	STATIC C ₀
						INCH	(mm) ∅	INCH	(mm) ∅									
SSRI-8516ZZSD502	R	.2500	6.350	.5000	12.700	—	—	.1562	3.967	—	—	.362	.460	.005	11	1/16	93	43
SSRIF-8516ZZSD502	R	.2500	6.350	.5000	12.700	—	—	.1562	3.967	.547	.042	.362	.460	.005	11	1/16	93	43
SSR-4ZZA01	R/H	.2500	6.350	.7500	19.050	—	—	.1960	4.978	—	—	.364	.544	.012	8	3/32	159	70
SSR-4ZZA12	R	.2500	6.350	.8685	22.060	—	—	.1960	4.978	—	—	.364	.544	.012	8	3/32	159	70
SSR-4ZZA63	R	.2500	6.350	1.0415	26.454	—	—	.1960	4.978	—	—	.364	.544	.012	8	3/32	159	70
SSR-4ZZSD548	R	.2500	6.350	.6250	15.875	—	—	.3120	7.925	—	—	.364	.544	.012	8	3/32	159	70
SSR-4ZZSD561	R	.2500	6.350	.7050	17.907	—	—	.1960	4.978	—	—	.364	.544	.012	8	3/32	159	70
SSR-2270ZZW301	R	.2756	7.000	.8661	22.000	—	—	.4060	10.312	—	—	.424	.745	.016	7	5/32	569	273
SSRI-8516ZZA02	R	.3125	7.938	.6250	15.875	—	—	.1562	3.967	—	—	.362	.460	.005	11	1/16	93	43
SSR-2280ZZW301	R	.3150	8.000	.8661	22.000	—	—	.4060	10.312	—	—	.424	.745	.016	7	5/32	569	273
SSR-2280ZZW021	R	.3150	8.000	.8661	22.000	—	—	.4724	12.000	—	—	.424	.745	.016	7	5/32	425	208
SSRI-1438ZZA02	R	.3750	9.525	1.0000	25.400	—	—	.2812	7.142	—	—	.474	.783	.016	7	5/32	569	273

Notes:

1. Inch to metric conversion—see page 68.
2. Basic part numbers shown above include code "SS" for AISI 440C stainless steel. If SAE 52100 chrome alloy steel is desired, delete "SS."
3. See page 63 for ABEC tolerances.
4. r=Maximum shaft or housing fillet radius that bearing corners will clear.

- * "R" Ribbon or "H" Crown cages are available as indicated. Please consult with factory for machined cage availability.
- ∅ Metric dimensions are for reference only.
- ** Load ratings are based on ABMA Standard #12.



30 Angular Contact, Full Ball Complement

31 Angular Contact

32 Radial

Angular Contact, Full Ball Complement (limited speed capability)



Inner Ring Relieved

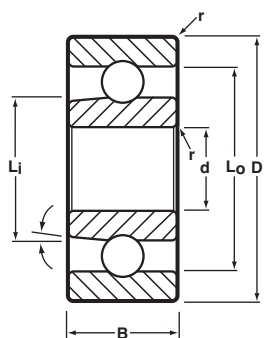

Outer Ring Relieved

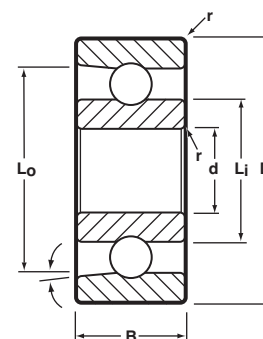

BASIC P/N	BORE d		O.D. D		WIDTH B		LAND DIAMETER (REFERENCE)		FILLET RADIUS r	BALL COMPLEMENT		LOAD RATINGS** LB.	
	INCH	(mm)	INCH	(mm)	INCH	(mm)	L _i	L _o		NO. Z	SIZE D _b	DYN. C	STATIC C ₀
SSMDR-2ZZF	.1250	3.175	.3750	9.525	.1562	3.967	.200	.323	.012	12	1/16	141	57
SSMER-2F	.1250	3.175	.3750	9.525	.1562	3.967	.200	.292	.012	12	1/16	141	57
SSMDR-3ZZF	.1875	4.763	.5000	12.700	.1960	4.978	.276	.435	.012	11	3/32	240	94
SSMER-3SD509F	.1875	4.763	.5000	12.700	.1562	3.967	.276	.413	.012	11	3/32	240	94
SSMDR-1960ZZF	.2362	6.000	.7480	19.000	.2362	6.000	.374	.640	.012	9	5/32	782	338
SSMDRI-814XZZF	.2500	6.350	.5000	12.700	.1875	4.763	.303	.460	.005	12	3/32	258	107
SSMDR-4ZZSD501F	.2500	6.350	.6250	15.875	.1960	4.978	.375	.522	.012	10	1/8	577	257
SSMDR-2270ZZSD501F	.2756	7.000	.8661	22.000	.2756	7.000	.509	.732	.012	11	5/32	900	430
SSMDR-2280ZZSD506F	.3150	8.000	.8661	22.000	.2756	7.000	.509	.732	.012	11	5/32	900	430
SSMDRI-1438ZZF	.3750	9.525	.8750	22.225	.2812	6.000	.520	.783	.016	12	5/32	986	515
SSMDR-100ZZF	.3937	10.000	1.0236	26.000	.3150	8.000	.583	.892	.012	11	3/16	1430	743
SSMDRI-1212ZZF	.5000	12.700	.7500	19.050	.1562	3.967	.587	.688	.010	31	1/16	241	188
SSMERI-1878SD501F	.8750	22.225	1.1250	28.575	.1562	3.967	1.041	.970	.010	50	1/16	437	398

Notes:

1. Inch to metric conversion—see page 68.
2. See page 63 for ABEC tolerances.
3. r=Maximum shaft or housing fillet radius that bearing corners will clear.
4. Metric/inch conversions are given for reference only.

* * Load ratings are based on ABMA Standard #12.

Angular Contact

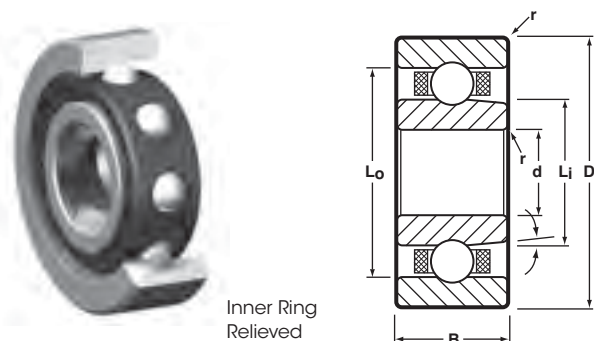

Inner Ring Relieved

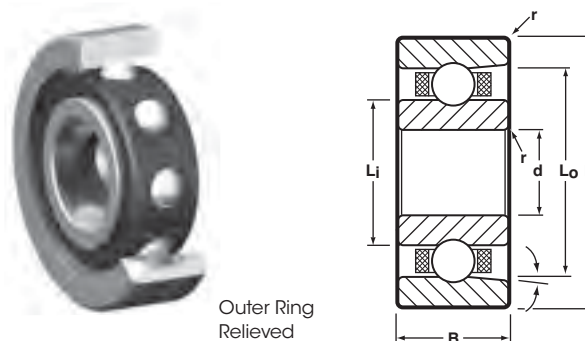

Outer Ring Relieved

BASIC P/N	CAGE TYPE *	BORE d		O.D. D		WIDTH B		LAND DIAMETER (REFERENCE)		FILLET RADIUS r	BALL COMPLEMENT		LOAD RATINGS** LB.	
		INCH	(mm)	INCH	(mm)	INCH	(mm)	Li	Lo		NO. Z	SIZE Db	DYN. C	STATIC Co
SSMDR-620MC	KN/M4	.0787	2.000	.2362	6.000	.0906	2.301	.124	.186	.003	7	.0394	37	11
DSMDRI-418X	M4	.1250	3.175	.2500	6.350	.0937	2.380	.166	.220	.003	8	.0394	42	13
DSMDRI-418ZWO5MC ■	M4	.1250	3.175	.2500	6.350	.1094	2.779	.166	.220	.003	7	.0394	42	13
SSMBR-2	KN	.1250	3.175	.3750	9.525	.1562	3.967	.205	.292	.012	7	1/16	84	28
MER-3SD509	KN	.1875	4.763	.5000	12.700	.1562	3.967	.276	.412	.012	8	3/32	193	69
SSMER-3SD509	KN	.1875	4.763	.5000	12.700	.1562	3.967	.276	.412	.012	8	3/32	193	69
MER-1960	KM	.2362	6.000	.7480	19.000	.2362	6.000	.383	.596	.016	6	5/32	440	154
SSMER-4SD504	KM	.2500	6.350	.6250	15.875	.1960	4.978	.375	.502	.012	9	3/32	217	85
SSMDR-4ZSD501	KM	.2500	6.350	.6250	15.875	.1960	4.978	.375	.522	.012	8	1/8	491	204
SSMER-2280SD502	KM	.3150	8.000	.8661	22.000	.2756	7.000	.478	.690	.016	9	5/32	768	345
SSMERI-1038	KM	.3750	9.525	.6250	15.875	.1562	3.967	.458	.542	.010	16	1/16	169	93
SSMERI-1438	KM	.3750	9.525	.8750	22.225	.2188	5.558	.520	.731	.016	9	5/32	798	380
MER-1900	KV	.3937	10.000	.8661	22.000	.2362	6.000	.570	.734	.012	11	1/8	747	383
MER-100	KM	.3937	10.000	1.0236	26.000	.3150	8.000	.583	.836	.012	9	3/16	1251	608
SSMDR-1901	KV	.4724	12.000	.9449	24.000	.2362	6.000	.630	.799	.012	11	9/64	908	489
SSMERI-1458SD501	KM	.6250	15.875	.8750	22.225	.1562	3.967	.713	.797	.010	24	1/16	216	160
SSMERI-1634SD501	KM	.7500	19.050	1.0000	25.400	.1562	3.967	.837	.922	.010	30	1/16	265	229
SSMERI-1878SD502	KV	.8750	22.225	1.1250	28.575	.1562	3.967	1.041	.970	.010	32	1/16	246	227

Notes:

- Inch to metric conversion—see page 68.
 - See page 63 for ABEC tolerances.
 - r=Maximum shaft or housing fillet radius that bearing corners will clear.
 - Metric/inch conversions are given for reference only.
- * Please consult with factory for machined cage options.
 - Also available in flanged version. Please consult with factory.
 - ** Load ratings are based on ABMA Standard #12.

CUSTOM SPECIALTY BEARINGS have been developed for applications that require precise running accuracy and high speed capability, with the option of autoclavability. The machined Torlon® cage, designated as retainer option (M4, M5), is proven to withstand repeated autoclaving. This machined Torlon® retainer also has the option of a patented silver coating, which extends operational life in marginally lubricated applications and provides an added benefit with the antimicrobial properties of the silver coating.

These bearings are widely used in critical dental/medical applications, although they are ideally suited for any high speed application (up to

500,000 rpm). The design of these bearings incorporates the advantage of ultra-precision tolerances, a geometrically balanced design, super finished raceways, improved ball grade and a variety of retainer options.

The standard cage options are noted by chassis size, although there are numerous other materials available that can be used to optimize performance specific to your unique application. All of the sizes listed represent current production sizes, although almost any part can be designed to take advantage of the operating characteristics of our Custom Specialty Bearings.



Radial



Open
Machined
Crown Cage

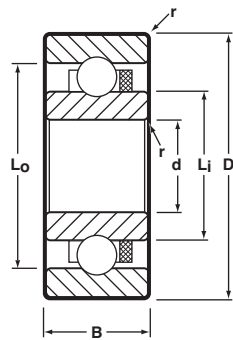

Shielded
Machined
Crown Cage

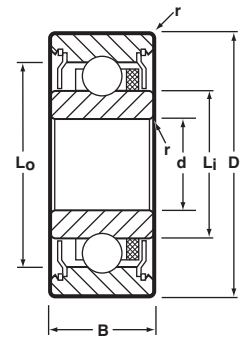

BASIC P/N	CAGE TYPE *	BORE d		O.D. D		WIDTH B		LAND DIAMETER (REFERENCE)		FILLET RADIUS r	BALL COMPLEMENT		LOAD RATINGS** LB.	
		INCH	(mm)	INCH	(mm)	INCH	(mm)	Li	Lo		NO. Z	SIZE Db	DYN. C	STATIC Co
SSRI-3332N1MC	M5	.0925	2.350	.1875	4.763	.0625	1.588	.118	.161	.003	7	1/32	19	6.5
SSL-525SD502B1	M5	.0927	2.355	.1969	5.000	.0591	1.500	.126	.170	.003	7	1/32	19	6.5
SSRI-5ZZSD516MC	M5	.0937	2.380	.1250	3.175	.1406	7.938	.173	—	.003	6	1/16	60	22
SSRI-3332MC ■	KC/M5	.0937	2.380	.1875	4.763	.0625	1.588	.118	.161	.003	7	1/32	19	6.5
SSRI-3332X3ZZMC ■	KC/M5/SC	.0937	2.380	.1875	4.763	.0937	2.380	.118	.167	.003	7	1/32	19	6.5
SSL-730MC	M5	.1181	3.000	.2756	7.000	.0787	2.000	.161	.227	.003	7	3/64	40	15
SSL-730X5ZZMC	M5	.1181	3.000	.2756	7.000	.1181	3.000	.161	.230	.003	8	.0394	33	12
DSRI-418X5MC ■ D	KC/M5	.1250	3.175	.2500	6.350	.0937	2.380	.159	.213	.003	8	.0394	33	12
SSRI-418X7WO5MC	M5	.1250	3.175	.2500	6.350	.1094	2.779	.159	.220	.003	8	.0394	33	12
DSRI-418X7ZMC D	KC/M5	.1250	3.175	.2500	6.350	.0937	2.380	.159	.221	.003	8	.0394	33	12
SSRI-418X7ZWO5 ■	KC/M5	.1250	3.175	.2500	6.350	.1094	2.779	.159	.270	.003	8	.0394	33	12
SSRI-418X7ZZMC ■	KC/M5	.1250	3.175	.2500	6.350	.1094	2.779	.159	.220	.003	8	.0394	33	12
SSRI-518MC ■	KC	.1250	3.175	.3125	7.938	.1094	2.779	.173	.270	.003	6	1/16	60	22
SSRI-518X3ZW07MC	KC/M5	.1250	3.175	.3125	7.938	.1406	3.571	.173	.283	.003	6	1/16	60	22
SSRI-518X3ZZMC ■	KC/M5/SC	.1250	3.175	.3125	7.938	.1406	3.571	.173	.283	.003	6	1/16	60	22
SSRI-618X3ZZMC	M5	.1250	3.175	.3750	9.525	.1406	3.571	.173	.283	.005	6	1/16	60	22
SSR-2XZZMC ■	KB/M5	.1250	3.175	.3750	9.525	.1562	3.967	.200	.321	.012	7	1/16	66	26
SSR-2ZZAMC	M5	.1250	3.175	.5000	12.700	.1719	4.366	.200	.301	.012	7	1/16	66	26
SSRI-5532ZZMC	KC/M5	.1562	3.967	.3125	7.938	.1250	3.175	.221	.285	.003	7	3/64	41	15
SSL-740MC	KC/M5	.1575	4.000	.2756	7.000	.0787	2.000	.189	.232	.003	7	1/32	20	7
SSL-940MC	M5	.1575	4.000	.3543	9.000	.0984	2.500	.200	.300	.012	7	1/16	66	26
SSL-940ZZMC	M5	.1575	4.000	.3543	9.000	.1575	4.000	.200	.323	.012	7	1/16	66	26
SSRI-5632WO6MC ■	M5	.1875	4.763	.3125	7.938	.1250	2.779	.221	.279	.003	7	3/64	41	15
SSRI-5632ZZMC ■	KC/M5	.1875	4.763	.3125	7.938	.1250	3.175	.221	.285	.003	7	3/64	41	15
SSRI-6632X5MC ■	M5	.1875	4.763	.3750	9.525	.1250	3.175	.235	.325	.003	8	1/16	76	31
SSRI-6632X5ZZMC ■	KB/KC/M5	.1875	4.763	.3750	9.525	.1250	3.175	.235	.341	.003	8	1/16	76	31
SSR-3X6ZZMC ■	KC/M5	.1875	4.763	.5000	12.700	.1960	4.978	.276	.433	.012	7	3/32	140	59
SSL-1150ZZMC	M5	.1969	5.000	.4331	11.000	.1969	5.000	.252	.374	.006	7	1/16	66	26
SSRI-614ZZMC	KC/M5/SC	.2500	6.350	.3750	9.525	.1250	3.175	.285	.348	.003	10	.0394	40	18
SSRI-814ZZMC ■	KC/M5	.2500	6.350	.5000	12.700	.1875	4.763	.330	.452	.005	10	1/16	88	40
SSR-4ZZMC ■	KC/M5	.2500	6.350	.6250	15.875	.1960	4.978	.364	.544	.012	8	3/32	159	70
SSR-4X3ZZMC ■	KC/M5	.2500	6.350	.6250	15.875	.1960	4.978	.323	.513	.012	8	3/32	159	70
SSL-1370X6ZZMC	M5	.2756	7.000	.5118	13.000	.1575	4.000	.330	.455	.006	10	1/16	88	40
SSL-1680	KC	.3150	8.000	.6299	16.000	.1575	4.000	.409	.534	.008	9	3/32	170	79
SSL-1680ZZMC	M5	.3150	8.000	.6299	16.000	.1969	5.000	.409	.553	.008	9	3/32	170	79
SSL-1680ZZW06MC	KC	.3150	8.000	.6299	16.000	.2362	6.000	.409	.553	.008	9	3/32	170	79

Notes:

- Inch to metric conversion—see page 68.
 - Basic part numbers shown above include code "SS" for AISI 440C stainless steel. If SAE 52100 chrome alloy steel is desired, delete "SS."
 - See page 63 for ABEC tolerances.
 - r=Maximum shaft or housing fillet radius that bearing corners will clear.
 - Metric/inch conversions are given for reference only.
- * Please consult with factory for machined cage options.
 - Also available in flanged version. Please consult with factory.
 - * * Load ratings are based on ABMA Standard #12.
 - D=Ring material made of 400 series martensitic stainless steel.

Radial



Open Machined Crown Cage

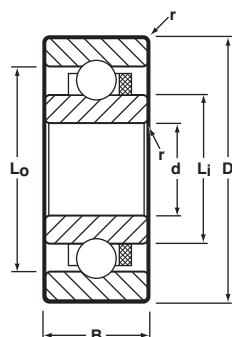

Shielded Machined Crown Cage

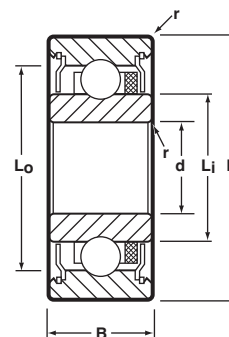

BASIC P/N	CAGE TYPE *	BORE d		O.D. D		WIDTH B		LAND DIAMETER (REFERENCE)		FILLET RADIUS r	BALL COMPLEMENT		LOAD RATINGS** LB.	
		INCH	(mm)	INCH	(mm)	INCH	(mm)	Li	Lo		NO. Z	SIZE Db	DYN. C	STATIC Co
SSRI-8516MC ■	M5	.3125	7.938	.5000	12.700	.1562	3.967	.362	.450	.005	11	1/16	93	43
SSRI-8516ZZSD505MC	KC/M5	.3125	7.938	.5000	12.700	.1562	3.967	.362	.460	.005	11	1/16	93	43
SSL-1680ZZW06MC	KC/M5	.3150	8.000	.8629	16.000	.2362	6.000	.409	.554	.012	9	3/32	170	79
SSR-2280MC	KC/M5	.3150	8.000	.8661	22.000	.2756	7.000	.463	.704	.016	7	5/32	569	273
SSR-2280ZZW301MC	KC/M5	.3150	8.000	.8661	22.000	.4060	10.312	.463	.744	.016	7	5/32	569	273
SSRI-1038XZZ	KC/M5	.3750	9.525	.6250	15.875	.1562	3.937	.458	.557	.010	12	1/16	140	70
SSRI-1038XZZSD518	KC/M5	.3750	9.525	.6250	15.875	.1550	3.937	.458	.557	.010	12	1/16	140	70
SSRI-1038ZZW11MC	KC	.3750	9.525	.6250	15.875	.1960	4.978	.458	.557	.010	12	1/16	140	70
SSRI-1438MC ■	KC/M5	.3750	9.525	.8750	22.225	.2188	5.558	.521	.741	.016	7	5/32	569	273
SSRI-1438ZZMC ■	KC/M5	.3750	9.525	.8750	22.225	.2812	7.142	.476	.783	.016	7	5/32	569	273
SSRI-1212XZZMC	KC/M5	.5000	12.700	.7500	19.050	.1562	3.967	.587	.688	.010	16	1/16	155	97
SSRI-1212ZZW11MC	KC	.5000	12.700	.7500	19.050	.1960	4.978	.587	.688	.010	16	1/16	155	97
SSRI-1458XZZ	KC	.6250	15.875	.8750	22.225	.1562	3.967	.713	.797	.010	18	1/16	159	108
SSRI-1458ZZW11MC	KC	.6250	15.875	.8750	22.225	.1960	4.978	.713	.797	.010	18	1/16	159	108
SSRI-1634XZZ	KC	.7500	19.050	1.0000	25.400	.1562	3.967	.837	.922	.010	22	1/16	175	132
SSRI-1634ZZW11	KC	.7500	19.050	1.0000	25.400	.1960	4.978	.837	.922	.010	22	1/16	175	132

Notes:

1. Inch to metric conversion—see page 68.
2. Basic part numbers shown above include code "SS" for AISI 440C stainless steel. If SAE 52100 chrome alloy steel is desired, delete "SS."
3. See page 63 for ABEC tolerances.
4. r=Maximum shaft or housing fillet radius that bearing corners will clear.
5. Metric/inch conversions are given for reference only.

* Please consult with factory for machined cage options.

■ Also available in flanged version. Please consult with factory.

* * Load ratings are based on ABMA Standard #12.

CUSTOM SPECIALTY BEARINGS have been developed for applications that require precise running accuracy and high speed capability, with the option of autoclavability. The machined Torlon® cage, designated as retainer option (M4, M5), is proven to withstand repeated autoclaving. This machined Torlon® retainer also has the option of a patented silver coating, which extends operational life in marginally lubricated applications and provides an added benefit with the antimicrobial properties of the silver coating.

These bearings are widely used in critical dental/medical applications, although they are ideally suited for any high speed application (up to

500,000 rpm). The design of these bearings incorporates the advantage of ultra-precision tolerances, a geometrically balanced design, super finished raceways, improved ball grade and a variety of retainer options.

The standard cage options are noted by chassis size, although there are numerous other materials available that can be used to optimize performance specific to your unique application. All of the sizes listed represent current production sizes, although almost any part can be designed to take advantage of the operating characteristics of our Custom Specialty Bearings.

Torlon® is a registered trademark of Solvay Advanced Polymers, L.L.C.



36	Torque Tube, Standard Width
37	Torque Tube, Extended Inner Ring
38	Thinex



Torque Tube, Standard Width

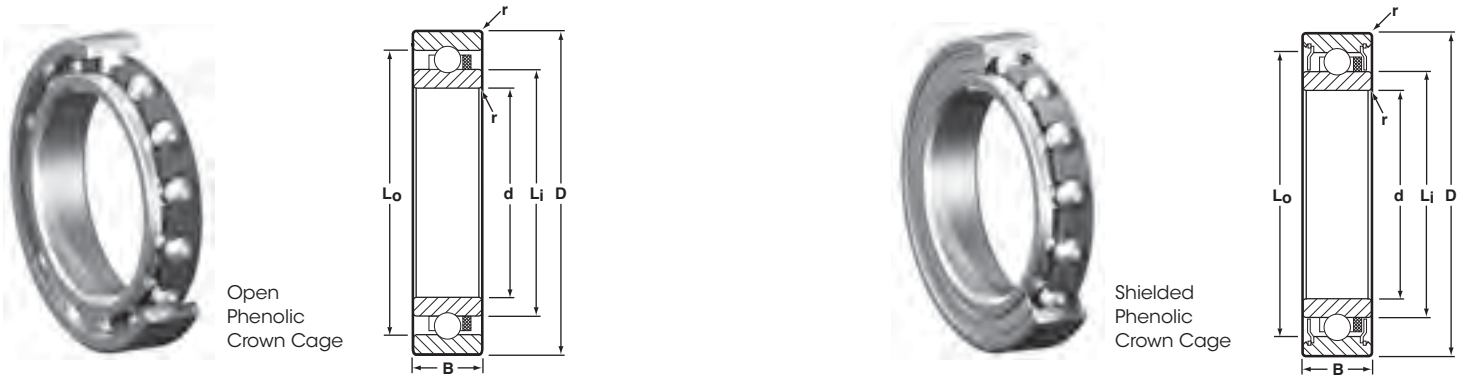

BASIC P/N	CAGE TYPE	BORE d		O.D. D		WIDTH B		LAND DIAMETER (REFERENCE)		FILLET RADIUS r	BALL COMPLEMENT		LOAD RATINGS** LB.		BRG. WT. GMS. ▼
		INCH	(mm) \diamond	INCH	(mm) \diamond	INCH	(mm) \diamond	L_i	L_o		NO. Z	SIZE D_b	DYN. C	STATIC C_o	
SSRI-538	R	.6250	15.875	1.0625	26.988	.2500	6.350	.773	.933	.015	10	1/8	580	316	13.4
SSRI-538	KC	.6250	15.875	1.0625	26.988	.2500	6.350	.773	.933	.015	12	1/8	655	379	13.6
SSRI-539	R/KC	.7500	19.050	1.1875	30.162	.2500	6.350	.894	1.054	.015	12	1/8	645	391	14.2
SSRI-540	R/KC	.8750	22.225	1.3125	33.338	.2500	6.350	1.019	1.179	.015	14	1/8	705	467	15.1
SSRI-541	R/KC	1.0625	26.988	1.5000	38.100	.2500	6.350	1.210	1.370	.015	16	1/8	754	548	19.0
SSRI-541SD502	KC	1.0625	26.988	1.5000	38.100	.2500	6.350	1.210	1.370	.015	18	1/8	815	616	19.2
SSRI-542	R/KC	1.3125	33.338	1.7500	44.450	.2500	6.350	1.460	1.620	.015	18	1/8	780	632	21.3
SSRI-542SD513	KC	1.3125	33.338	1.7500	44.450	.2500	6.350	1.460	1.620	.015	20	1/8	837	702	21.5
SSRI-543	R	1.5625	39.688	2.0000	50.800	.2500	6.350	1.706	1.866	.015	22	1/8	859	785	25.3
SSRI-543	KC	1.5625	39.688	2.0000	50.800	.2500	6.350	1.706	1.866	.015	25	1/8	935	893	25.7
SSRI-544	KC	1.8125	46.038	2.2500	57.150	.2500	6.350	1.963	2.123	.015	29	1/8	998	1050	28.4
SSRI-545	KC	2.0625	52.388	2.6250	66.675	.2500	6.350	2.263	2.423	.015	32	1/8	1028	1172	47.7

Notes:

1. Inch to metric conversion—see page 68.
 2. Basic part numbers shown above include code "SS" for AISI 440C stainless steel. If SAE 52100 chrome alloy steel is desired, delete "SS."
 3. See page 64 for ABEC 5T and 7T tolerances.
 4. r = Maximum shaft or housing fillet radius that bearing corners will clear.
 5. Angular contact configurations available (SSMDRI-, SSMERI-). Please consult with factory.
 6. Extended inner rings (EE) also available as a production standard. See next page.
- \diamond Metric dimensions are for reference only.
 * * Load ratings are based on ABMA Standard #12.
 ▼ Bearing weights are for reference only.

Torque Tube, Extended Inner Ring

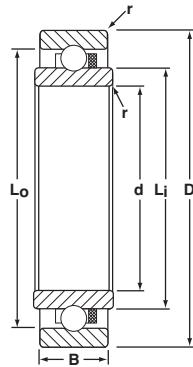

Open Phenolic Crown Cage

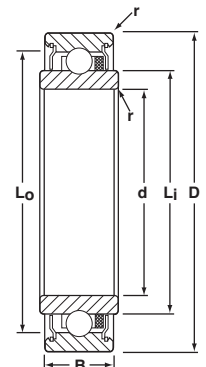

Shielded Phenolic Crown Cage

BASIC P/N	CAGE TYPE	BORE d		O.D. D		INNER WIDTH B _i		OUTER WIDTH B _o		LAND DIAMETER (REFERENCE)		FILLET RADIUS r	BALL COMPLEMENT		LOAD RATINGS** LB.		BRG. WT. GMS. ▼
		INCH	(mm) ∅	INCH	(mm) ∅	INCH	(mm) ∅	INCH	(mm) ∅	L _i	L _o		NO. Z	SIZE D _b	DYN. C	STATIC C ₀	
SSRI-538EE	R	.6250	15.875	1.0625	26.988	.2812	7.142	.2500	6.350	.773	.933	.015	10	1/8	580	316	14.2
SSRI-538EE	KC	.6250	15.875	1.0625	26.988	.2812	7.142	.2500	6.350	.773	.933	.015	12	1/8	655	379	14.4
SSRI-539EE	R/KC	.7500	19.050	1.1875	30.162	.2812	7.142	.2500	6.350	.894	1.054	.015	12	1/8	645	391	15.0
SSRI-540EE	R/KC	.8750	22.225	1.3125	33.338	.2812	7.142	.2500	6.350	1.019	1.179	.015	14	1/8	705	467	16.0
SSRI-541EE	R/KC	1.0625	26.988	1.5000	38.100	.2812	7.142	.2500	6.350	1.210	1.370	.015	16	1/8	754	548	20.1
SSRI-541SD502EE	KC	1.0625	26.988	1.5000	38.100	.2812	7.142	.2500	6.350	1.210	1.370	.015	18	1/8	815	616	20.3
SSRI-542EE	R/KC	1.3125	33.338	1.7500	44.450	.2812	7.142	.2500	6.350	1.460	1.620	.015	18	1/8	780	632	22.6
SSRI-542SD513EE	KC	1.3125	33.338	1.7500	44.450	.2812	7.142	.2500	6.350	1.460	1.620	.015	20	1/8	837	702	22.8
SSRI-543EE	R	1.5625	39.688	2.0000	50.800	.2812	7.142	.2500	6.350	1.706	1.866	.015	22	1/8	859	785	26.8
SSRI-543EE	KC	1.5625	39.688	2.0000	50.800	.2812	7.142	.2500	6.350	1.706	1.866	.015	25	1/8	935	893	27.2
SSRI-544EE	KC	1.8125	46.038	2.2500	57.150	.2812	7.142	.2500	6.350	1.963	2.123	.015	29	1/8	998	1050	30.6
SSRI-545EE	KC	2.0625	52.388	2.6250	66.675	.2812	7.142	.2500	6.350	2.263	2.423	.015	32	1/8	1028	1172	50.0

Notes:

1. Inch to metric conversion—see page 68.
2. Basic part numbers shown above include code "SS" for AISI 440C stainless steel. If SAE 52100 chrome alloy steel is desired, delete "SS."
3. See page 64 for ABEC 5T and 7T tolerances.
4. r=Maximum shaft or housing fillet radius that bearing corners will clear.
5. Angular contact configurations available (SSMDRI-, SSMERI-), please consult with factory.

- ∅ Metric dimensions are for reference only.
- * * Load ratings are based on ABMA Standard #12.
- ▼ Bearing weights are for reference only.



Thinex



Open Phenolic Crown Cage

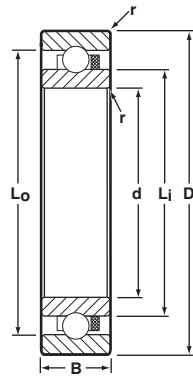

Shielded Phenolic Crown Cage

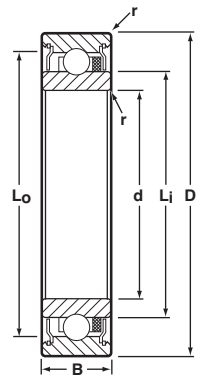

BASIC P/N	CAGE TYPE *	BORE d		O.D. D		WIDTH B				LAND DIAMETER (REFERENCE)		FILLET RADIUS r	BALL COMPLEMENT		LOAD RATINGS** LB.		BRG. WT. GMS. ▼
		INCH	(mm) ◊	INCH	(mm) ◊	OPEN		SHIELDED		Li	Lo		NO. Z	SIZE Db	DYN. C	STATIC Co	
						INCH	(mm) ◊	INCH	(mm) ◊								
SSRI-1038	R	.3750	9.525	.6250	15.875	.1562	3.967	.1562	3.967	.458	.557	.010	12	1/16	140	70	2.5
SSRI-1212	R	.5000	12.700	.7500	19.050	.1562	3.967	.1562	3.967	.587	.672	.010	16	1/16	155	97	3.2
SSRI-1458	R	.6250	15.875	.8750	22.225	.1562	3.967	.1562	3.967	.712	.797	.010	18	1/16	159	108	3.9
SSRI-1458SD508	KC	.6250	15.875	.8750	22.225	.1562	3.967	—	—	.712	.797	.010	20	1/16	171	120	4.1
SSRI-1634	R	.7500	19.050	1.0000	25.400	.1562	3.967	.1562	3.967	.837	.922	.010	22	1/16	175	132	4.5
SSRI-1634SD508	KC	.7500	19.050	1.0000	25.400	.1562	3.967	—	—	.837	.922	.010	24	1/16	185	143	4.7
SSRI-1878SD502	H	.8750	22.225	1.1250	28.575	.1562	3.967	.1562	3.967	.961	1.072	.010	24	1/16	244	210	5.4
SSRI-1878SD506	KC	.8750	22.225	1.1250	28.575	.1562	3.967	—	—	.961	1.072	.010	26	1/16	257	227	5.6
SSRI-2117 †		1.0625	26.988	1.3125	33.338	.1562	3.967	.1960	4.978	1.144	1.231	.010	28	1/16	182	159	6.1
SSRI-2420 †		1.2500	31.750	1.5000	38.100	.1562	3.967	.1960	4.978	1.320	1.402	.010	32	1/16	192	184	7.1

Notes:

1. Inch to metric conversion—see page 68.
 2. Basic part numbers shown above include code "SS" for AISI 440C stainless steel. If SAE 52100 chrome alloy steel is desired, delete "SS."
 3. See page 64 for ABEC 5T and 7T tolerances.
 4. r=Maximum shaft or housing fillet radius that bearing corners will clear.
 5. Angular contact configurations available (SSMDRI-, SSMERI-). Please consult with factory.
 6. Extended inner rings (EE) also available as a production standard.
- * The "R" Ribbon cage is available as indicated. Please consult with factory for machined cage availability.
 - ◊ Metric dimensions are for reference only.
 - * * Load ratings are based on ABMA Standard #12.
 - ♦ Limited retainer options available. Please consult with factory.
 - ▼ Bearing weights are for reference only.
 - † Single or double shielded or sealed configuration with specific internal design may be available in the open width.



40	Middle Size Metric Series – Radial, Unflanged
41	Miniature Metric L Series – Radial, Open, Unflanged and Flanged
42	Miniature Metric L Series – Radial, Shielded, Unflanged and Flanged
43	Miniature Metric R Series – Radial, Open, Unflanged and Flanged
44	Miniature Metric R Series – Radial, Shielded, Unflanged and Flanged



Radial, Unflanged



Open Ribbon Cage

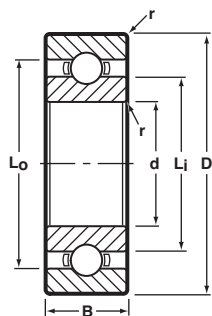

Shielded Ribbon Cage

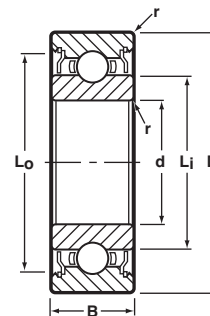

BASIC P/N	CAGE TYPE *	BORE d		O.D. D		WIDTH B		LAND DIAMETER (REFERENCE)		FILLET RADIUS r		BALL COMPLEMENT		LOAD RATINGS ** LB.	
		mm	(INCH) \diamond	mm	(INCH) \diamond	mm	(INCH) \diamond	L _j mm	L _o mm	mm	(INCH)	NO. Z	SIZE D _b	DYN. C	STATIC C ₀
☆ SSR-1900	RD/KC	10.0	.3937	22.0	.8661	6.0	.2362	14.48	19.90	.30	.012	9	1/8	580	280
☆ SSR-100	RD	10.0	.3937	26.0	1.0236	8.0	.3150	14.81	22.64	.30	.012	7	3/16	1000	440
SSR-100X	KE	10.0	.3937	26.0	1.0236	8.0	.3150	13.54	22.64	.30	.012	8	5/32	890	390
☆ SSR-200	RD	10.0	.3937	30.0	1.1811	9.0	.3543	16.66	24.98	.61	.024	7	7/32	1300	580
☆ SSR-200X	KC	10.0	.3937	30.0	1.1811	9.0	.3543	15.55	24.98	.61	.024	8	3/16	1060	510
☆ SSR-1901	R	12.0	.4724	24.0	.9449	6.0	.2362	15.98	21.29	.30	.012	9	9/64	730	350
SSR-1901X	KC/KE	12.0	.4724	24.0	.9449	6.0	.2362	15.98	21.29	.30	.012	9	1/8	635	275
☆ SSR-101	RD	12.0	.4724	28.0	1.1024	8.0	.3150	17.02	25.08	.30	.012	7	3/16	1000	460
SSR-201	RD	12.0	.4724	32.0	1.2598	10.0	.3937	18.42	25.58	.61	.024	7	15/64	1500	670
☆ SSR-1802	KC	15.0	.5906	24.0	.9449	5.0	.1969	18.08	20.89	.30	.012	14	3/32	420	260
☆ SSR-1902	RD	15.0	.5906	28.0	1.1024	7.0	.2756	18.69	25.70	.30	.012	10	5/32	940	490
☆ SSR-102	RD	15.0	.5906	32.0	1.2598	9.0	.3543	20.42	28.49	.30	.012	9	3/16	1250	630
☆ SSR-202	RD	15.0	.5906	35.0	1.3780	11.0	.4331	20.70	31.60	.61	.024	7	1/4	1700	790
SSR-1903	RD	17.0	.6693	30.0	1.1811	7.0	.2756	21.13	25.78	.30	.012	11	5/32	1000	550
☆ SSR-103	RD/KC/KE	17.0	.6693	35.0	1.3780	10.0	.3937	22.73	31.34	.30	.012	10	3/16	1300	710
SSR-203	RD	17.0	.6693	40.0	1.5748	12.0	.4724	24.18	32.82	.61	.024	8	17/64	2100	1050
SSR-1904	RD	20.0	.7874	37.0	1.4567	9.0	.3543	25.27	32.05	.30	.012	9	7/32	1600	860
SSR-104	RD	20.0	.7874	42.0	1.6535	12.0	.4724	27.31	35.43	.61	.024	8	1/4	1900	990
SSR-204	RD	20.0	.7874	47.0	1.8504	14.0	.5512	28.73	38.28	1.02	.040	8	5/16	2850	1450
☆ SSR-1805	KC	25.0	.9843	37.0	1.4567	7.0	.2756	29.10	32.85	.30	.012	17	1/8	820	600
SSR-1905	RD	25.0	.9843	42.0	1.6535	9.0	.3543	30.35	37.08	.30	.012	11	7/32	1850	1100
SSR-105	RD	25.0	.9843	47.0	1.8504	12.0	.4724	32.18	39.80	.61	.024	10	1/4	2200	1300

☆ Production standard.

Notes:

- Metric to inch conversion—see page 68.
- Basic part numbers shown above include code "SS" for AISI 440C stainless steel. If SAE 52100 chrome alloy steel is desired, delete "SS."
- Tolerances per ABMA standard #20.
- r=Maximum shaft or housing fillet radius that bearing corners will clear.

- While we have the capability to produce the sizes listed, they are not all currently in production. Please consult with factory for minimum order quantity and quote.
- Add "Z" for single shield, "ZZ" for two shields, as a suffix to basic part number.

- * Please consult with factory for machined cage options.
- \diamond Inch conversions are given for reference only.
- ** Load ratings are based on ABMA Standard #9.

Radial, Open, Unflanged and Flanged



Unflanged Ribbon Cage

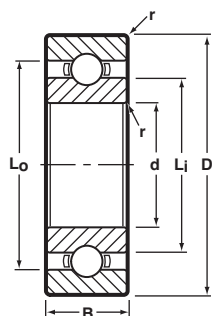

Flanged Ribbon Cage

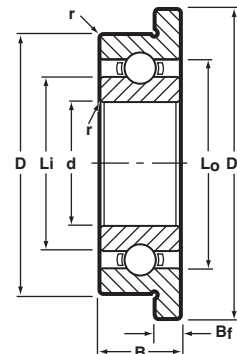

BASIC P/N †	CAGE TYPE *	BORE d		O.D. D		WIDTH B		FLANGE DIA. D _f	FLANGE WIDTH B _f	LAND DIAMETER (REFERENCE)		FILLET RADIUS r		BALL COMPLEMENT		LOAD RATINGS** LB.	
		mm	(INCH) ∅	mm	(INCH) ∅	mm	(INCH) ∅			L _i mm	L _o mm	mm	(INCH) ∅	NO. Z	SIZE D _b	Dyn. C	STATIC C ₀
SSL-310		1.0	.0394	3.0	.1181	1.0	.0394	3.8	0.30	1.60	2.42	.05	.002	7	0.5 mm	9	2
SSL-310W51		1.0	.0394	3.0	.1181	1.5	.0591	3.8	0.40	1.50	2.50	.05	.002	5	1/40	9	2
☆ SSL-415	H	1.5	.0591	4.0	.1575	1.2	.0472	5.0	0.40	2.26	3.26	.05	.002	7	1/40	13	4
☆ SSLFW-415 ▲	H	1.5	.0591	4.0	.1575	1.2	.0472	4.8	0.33	2.26	3.26	.05	.002	7	1/40	13	4
☆ SSL-520	H/M5	2.0	.0787	5.0	.1969	1.5	.0591	6.1	0.50	2.90	4.02	.08	.003	7	0.8 mm	20	7
SSL-625		2.5	.0984	6.0	.2362	1.8	.0709	7.1	0.50	3.80	4.90	.08	.003	7	0.8 mm	20	7
☆ SSL-630	M5	3.0	.1181	6.0	.2362	2.0	.0787	7.2	0.60	3.79	4.90	.08	.003	8	0.8 mm	20	7
☆ SSL-730	M5	3.0	.1181	7.0	.2756	2.0	.0787	8.1	0.50	4.10	5.76	.10	.004	7	3/64	40	15
☆ SSL-740	KC/M5	4.0	.1575	7.0	.2756	2.0	.0787	8.2	0.60	4.80	5.90	.08	.003	7	1/32	20	7
SSL-840		4.0	.1575	8.0	.3150	2.0	.0787	9.2	0.60	5.20	6.93	.10	.004	7	3/64	40	15
☆ SSL-940	R/M5	4.0	.1575	9.0	.3543	2.5	.0984	10.3	0.60	5.08	7.62	.10	.004	7	1/16	66	26
SSL-1040		4.0	.1575	10.0	.3937	3.0	.1181	11.2	0.60	6.00	8.30	.15	.006	7	1/16	68	26
SSL-850		5.0	.1969	8.0	.3150	2.0	.0787	9.2	0.60	5.80	6.97	.08	.003	13	0.8 mm	29	13
SSL-950		5.0	.1969	9.0	.3543	2.5	.0984	10.2	0.60	6.00	7.70	.10	.004	7	3/64	40	15
SSL-1050		5.0	.1969	10.0	.3937	3.0	.1181	11.2	0.60	6.40	8.60	.15	.006	7	1/16	68	26
☆ SSL-1150	M5	5.0	.1969	11.0	.4331	3.0	.1181	12.5	0.80	6.40	8.60	.15	.006	7	1/16	75	31
☆ SSL-1060	H/M5	6.0	.2362	10.0	.3937	2.5	.0984	11.2	0.60	6.95	8.63	.10	.004	10	1.0 mm	49	18
SSL-1260		6.0	.2362	12.0	.4724	3.0	.1181	13.2	0.60	7.80	10.20	.15	.006	7	1/16	68	29
☆ SSL-1360	KC	6.0	.2362	13.0	.5118	3.5	.1378	15.0	1.00	8.00	11.00	.15	.006	8	2.0 mm	115	49
SSL-1170		7.0	.2756	11.0	.4331	2.5	.0984	12.2	0.60	8.10	9.80	.10	.004	9	3/64	46	20
SSL-1370	R/M5	7.0	.2756	13.0	.5118	3.0	.1181	14.2	0.60	8.38	10.93	.15	.006	10	1/16	82	37
☆ SSL-1470X	R/M5	7.0	.2756	14.0	.5512	3.5	.1378	16.0	1.00	9.19	11.37	.15	.006	11	1/16	126	55
SSL-1280	H	8.0	.3150	12.0	.4724	2.5	.0984	13.2	0.60	9.10	10.90	.10	.004	11	3/64	53	24
SSL-1480		8.0	.3150	14.0	.5512	3.5	.1378	15.6	0.80	9.90	12.10	.15	.006	10	1/16	86	42
☆ SSL-1680	KC/R	8.0	.3150	16.0	.6299	4.0	.1575	18.0	1.00	10.40	13.60	.20	.008	9	3/32	170	79
SSL-1790		9.0	.3543	17.0	.6693	4.0	.1575	19.0	1.00	11.20	14.81	.20	.008	10	3/32	183	88
SSL-2090		9.0	.3543	20.0	.7874	5.0	.1969	—	—	12.32	16.68	.30	.012	9	7/64	225	108
☆ SSL-1910	R	10.0	.3937	19.0	.7480	5.0	.1969	—	—	12.32	16.68	.30	.012	9	7/64	225	108
☆ SSL-1910X	KC	10.0	.3937	19.0	.7480	5.0	.1969	—	—	12.22	16.50	.30	.012	10	3/32	244	132

☆ Production standard.

Notes:

1. Metric to inch conversion—see page 68.
2. Basic part numbers shown above include code "SS" for AISI 440C stainless steel. If SAE 52100 chrome alloy steel is desired, delete "SS."
3. See page 63 for ABEC tolerances.
4. r=Maximum shaft or housing fillet radius that bearing corners will clear.

5. While we have the capability to produce the sizes listed, they are not all currently in production. Please consult with factory for minimum order quantity and quote.

† For flanged bearing, substitute prefix "SSLF-" when applicable.

* Please consult with factory for cage availability.

▲ Available only as flanged type.

∅ Inch conversions are given for reference only.

** Load ratings are based on ABMA Standard #12.

Radial, Shielded, Unflanged and Flanged



Unflanged
Shielded
Ribbon Cage

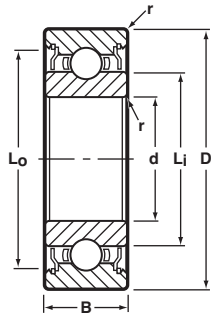

Flanged
Shielded
Ribbon Cage

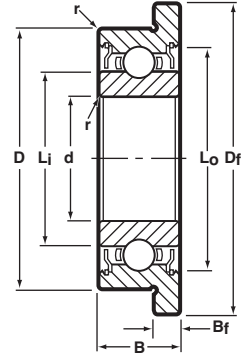

BASIC P/N †	CAGE TYPE *	BORE d		O.D. D		WIDTH B		FLANGE DIA. Df	FLANGE WIDTH Bf	LAND DIAMETER (REFERENCE)		FILLET RADIUS r		BALL COMPLEMENT		LOAD RATINGS** LB.	
		mm	(INCH) ∅	mm	(INCH) ∅	mm	(INCH) ∅			Li mm	Lo mm	mm	(INCH) ∅	NO. Z	SIZE Db	Dyn. C	STATIC Co
SSL-520		2.0	.0787	5.0	.1969	2.3	.0906	6.1	0.6	2.90	4.25	.08	.003	7	0.8 mm	20	7
SSL-625		2.5	.0984	6.0	.2362	2.6	.1024	7.1	0.8	3.80	5.20	.08	.003	7	0.8 mm	20	7
SSL-630		3.0	.1181	6.0	.2362	2.5	.0984	7.2	0.6	3.80	5.20	.08	.003	7	0.8 mm	20	7
☆ SSL-730X5	H	3.0	.1181	7.0	.2756	3.0	.1181	—	—	4.10	5.86	.10	.004	7	1.0 mm	26	9
☆ SSL-730X5	R/M5	3.0	.1181	7.0	.2756	3.0	.1181	—	—	4.10	5.86	.10	.004	8	1.0 mm	30	11
SSL-740		4.0	.1575	7.0	.2756	2.5	.0984	8.2	0.6	4.80	6.30	.08	.003	7	1/32	20	7
SSL-840		4.0	.1575	8.0	.3150	3.0	.1181	9.2	0.6	5.20	7.20	.10	.004	7	3/64	40	15
SSL-940	M5/R	4.0	.1575	9.0	.3543	4.0	.1575	10.3	1.0	5.08	7.93	.10	.004	7	1/16	66	26
☆ SSLFW-940 ▲	M5/R	4.0	.1575	9.0	.3543	4.0	.1575	10.6	0.8	5.08	7.93	.10	.004	7	1/16	66	26
SSL-1040X	H	4.0	.1575	10.0	.3937	4.0	.1575	11.6	0.8	5.96	8.75	.15	.006	8	1/16	84	35
SSL-850		5.0	.1969	8.0	.3150	2.5	.0984	9.2	0.6	5.80	7.26	.08	.003	13	0.8 mm	29	13
SSL-950		5.0	.1969	9.0	.3543	3.0	.1181	10.2	0.6	6.00	8.00	.10	.004	7	3/64	40	15
SSL-1050		5.0	.1969	10.0	.3937	4.0	.1575	11.6	0.8	6.40	8.90	.15	.006	7	1/16	68	26
☆ SSL-1150X	M5	5.0	.1969	11.0	.4331	5.0	.1969	—	—	6.40	9.53	.15	.006	7	1/16	75	31
☆ SSL-1060		6.0	.2362	10.0	.3937	3.0	.1181	11.2	0.6	7.24	8.93	.10	.004	9	3/64	49	18
☆ SSL-1060X	H/M5	6.0	.2362	10.0	.3937	3.0	.1181	—	—	7.24	8.93	.10	.004	13	1.0 mm	47	22
SSL-1260		6.0	.2362	12.0	.4724	4.0	.1575	13.6	0.8	7.80	10.20	.15	.006	7	1/16	68	29
SSL-1360	KC	6.0	.2362	13.0	.5118	5.0	.1969	15.0	1.1	8.00	11.50	.15	.006	8	2.0 mm	115	49
SSL-1170		7.0	.2756	11.0	.4331	3.0	.1181	12.2	0.6	8.10	10.10	.10	.004	9	3/64	46	20
☆ SSL-1370X	R/M5	7.0	.2756	13.0	.5118	4.0	.1575	—	—	8.38	11.54	.15	.006	10	1/16	88	40
☆ SSL-1470X	KC/M5/R	7.0	.2756	14.0	.5512	5.0	.1969	—	—	9.19	11.73	.15	.006	11	1/16	93	43
SSL-1280	H	8.0	.3150	12.0	.4724	3.5	.1378	13.6	0.8	9.10	11.20	.10	.004	11	3/64	53	24
SSL-1480		8.0	.3150	14.0	.5512	4.0	.1575	15.6	0.8	9.90	12.50	.15	.006	10	1/16	86	42
☆ SSL-1680	R	8.0	.3150	16.0	.6299	5.0	.1969	18.0	1.1	10.40	14.00	.20	.008	9	3/32	170	79
☆ SSL-1680W06	KC/R	8.0	.3150	16.0	.6299	6.0	.2362	—	—	10.40	14.04	.20	.008	9	3/32	170	79
SSL-1790		9.0	.3543	17.0	.6693	5.0	.1969	19.0	1.1	11.20	15.30	.20	.008	10	3/32	184	90
SSL-2090		9.0	.3543	20.0	.7874	6.0	.2362	—	—	12.32	17.40	.30	.012	9	7/64	225	108
☆ SSL-1910	R	10.0	.3937	19.0	.7480	7.0	.2756	—	—	12.31	17.44	.30	.012	9	7/64	225	108
☆ SSL-1910X	R/KC	10.0	.3937	19.0	.7480	5.0	.1969	—	—	12.22	17.44	.30	.012	10	3/32	225	108

☆ Production standard.

Notes:

- Metric to inch conversion—see page 68.
- Basic part numbers shown above include code "SS" for AISI 440C stainless steel. If SAE 52100 chrome alloy steel is desired, delete "SS."
- See page 63 for ABEC tolerances.
- r=Maximum shaft or housing fillet radius that bearing corners will clear.

- While we have the capability to produce the sizes listed, they are not all currently in production. Please consult with factory for minimum order quantity and quote.
- Add "Z" for single shield, "ZZ" for two shields, as a suffix to basic part number before "Y" or "W" width variations.

† For flanged bearing, substitute prefix "SSLF-" when applicable.

* Please consult with factory for cage availability.

▲ Available only as flanged type.

∅ Inch conversions are given for reference only.

** Load ratings are based on ABMA Standard #12.

Radial, Open, Unflanged and Flanged



Unflanged
Ribbon Cage

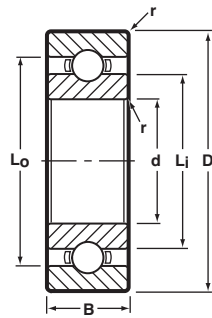

Flanged
Ribbon Cage

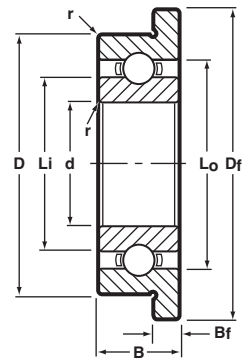

BASIC P/N †	CAGE TYPE *	BORE d		O.D. D		WIDTH B		FLANGE DIA. Df	FLANGE WIDTH Bf	LAND DIAMETER (REFERENCE)		FILLET RADIUS r		BALL COMPLEMENT		LOAD RATINGS** LB.	
		mm	(INCH) ∅	mm	(INCH) ∅	mm	(INCH) ∅			Lj mm	Lo mm	mm	(INCH) ∅	NO. Z	SIZE Db	Dyn. C	STATIC Co
SSR-412		1.2	.0472	4.0	.1575	1.8	.0709	4.8	0.4	2.05	3.15	.10	.0040	6	0.8 mm	18	4
SSR-515		1.5	.0591	5.0	.1969	2.0	.0787	6.5	0.6	2.60	3.70	.15	.0060	7	0.8 mm	20	7
SSR-615		1.5	.0591	6.0	.2362	2.5	.0984	7.5	0.6	2.90	4.70	.15	.0060	6	3/64	35	13
SSR-620		2.0	.0787	6.0	.2362	2.3	.0906	7.5	0.6	3.15	4.90	.15	.0060	6	3/64	35	13
SSR-720		2.0	.0787	7.0	.2756	2.8	.1102	8.5	0.7	3.80	5.50	.15	.0060	7	3/64	40	15
SSR-725		2.5	.0984	7.0	.2756	2.5	.0984	8.5	0.7	3.80	5.50	.15	.0060	7	3/64	40	15
SSR-825		2.5	.0984	8.0	.3150	2.8	.1102	9.5	0.7	4.10	6.50	.15	.0060	6	1/16	60	22
SSR-830		3.0	.1181	8.0	.3150	3.0	.1181	9.5	0.7	4.10	6.50	.15	.0060	6	1/16	60	22
SSR-930		3.0	.1181	9.0	.3543	3.0	.1181	10.5	0.7	4.80	7.20	.15	.0060	7	1/16	66	26
☆ SSR-1030X	KC/M5/R	3.0	.1181	10.0	.3937	4.0	.1575	11.5	1.0	5.08	8.18	.15	.0060	7	1/16	66	26
☆ SSR-1140X	R	4.0	.1575	11.0	.4331	4.0	.1575	12.5	1.0	5.96	8.60	.15	.0060	8	1/16	75	31
SSR-1240		4.0	.1575	12.0	.4724	4.0	.1575	13.5	1.0	6.50	9.50	.20	.0080	7	2.0 mm	104	42
SSR-1340		4.0	.1575	13.0	.5118	5.0	.1969	15.0	1.0	7.00	10.46	.20	.0080	7	3/32	139	60
☆ SSR-1640X	R	4.0	.1575	16.0	.6299	5.0	.1969	18.0	1.0	8.03	13.24	.30	.0120	8	3/32	157	68
☆ SSR-1350	R	5.0	.1969	13.0	.5118	4.0	.1575	15.0	1.0	7.50	11.17	.20	.0080	8	2.0 mm	139	60
SSR-1450		5.0	.1969	14.0	.5512	5.0	.1969	16.0	1.0	7.60	11.50	.20	.0080	7	3/32	139	60
☆ SSR-1650X	R	5.0	.1969	16.0	.6299	5.0	.1969	18.0	1.0	8.03	13.24	.30	.0120	8	3/32	157	68
☆ SSR-1950	R	5.0	.1969	19.0	.7480	6.0	.2362	22.0	1.5	8.66	16.25	.30	.0120	6	5/32	481	240
SSR-1560		6.0	.2362	15.0	.5906	5.0	.1969	17.0	1.2	8.60	12.40	.15	.0060	7	7/64	212	101
SSR-1760		6.0	.2362	17.0	.6693	6.0	.2362	19.0	1.2	8.90	14.10	.20	.0100	6	3.5 mm	384	187
☆ SSR-1960	KC/M5/R	6.0	.2362	19.0	.7480	6.0	.2362	22.0	1.5	8.66	16.25	.30	.0120	6	5/32	481	226
☆ SSR-1970	R	7.0	.2756	19.0	.7480	6.0	.2362	—	—	10.60	15.94	.30	.0120	7	1/8	379	174
☆ SSR-2270	KC/R	7.0	.2756	22.0	.8661	7.0	.2756	25.0	1.5	10.76	18.88	.30	.0120	7	5/32	569	273
☆ SSR-2280	KC/M5/R	8.0	.3150	22.0	.8661	7.0	.2756	25.0	1.5	10.75	18.88	.30	.0120	7	5/32	569	273
☆ SSR-2690	R	9.0	.3543	26.0	1.0236	8.0	.3150	—	—	14.80	22.64	.30	.0120	7	3/16	703	399

☆ Production standard.

Notes:

- Metric to inch conversion—see page 68.
- Basic part numbers shown above include code "SS" for AISI 440C stainless steel. If SAE 52100 chrome alloy steel is desired, delete "SS."
- See page 63 for ABEC tolerances.
- r=Maximum shaft or housing fillet radius that bearing corners will clear.

5. While we have the capability to produce the sizes listed, they are not all currently in production. Please consult with factory for minimum order quantity and quote.

† For flanged bearing, substitute prefix "SSRF-" when applicable.

* Please consult with factory for cage availability.

∅ Inch conversions are given for reference only.

** Load ratings are based on ABMA Standard #12.



Radial, Shielded, Unflanged and Flanged



Unflanged
Shielded
Ribbon Cage

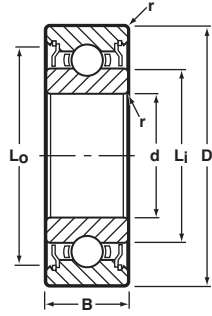

Flanged
Shielded
Ribbon Cage

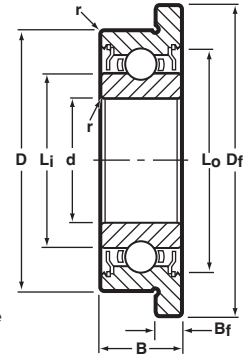

BASIC P/N †	CAGE TYPE *	BORE d		O.D. D		WIDTH B		FLANGE DIA. Df	FLANGE WIDTH Bf	LAND DIAMETER (REFERENCE)		FILLET RADIUS r		BALL COMPLEMENT		LOAD RATINGS** LB.		
		mm	(INCH) ◇	mm	(INCH) ◇	mm	(INCH) ◇			Li	Lo	mm	(INCH) ◇	NO. Z	SIZE Db	Dyn. C	STATIC Co	
SSR-515	H	1.5	.0591	5.0	.1969	2.6	.1024	6.5	0.8	2.60	4.00	.15	.0060	7	0.8mm	20	7	
SSR-615		1.5	.0591	6.0	.2362	3.0	.1181	7.5	0.8	2.90	5.00	.15	.0060	6	3/64	35	11	
SSR-620		2.0	.0787	6.0	.2362	3.0	.1181	7.5	0.8	3.10	5.20	.15	.0060	6	3/64	35	13	
☆ SSR-620Y32		2.0	.0787	6.0	.2362	2.3	.0906	—	—	3.16	5.23	.15	.0060	7	1.0mm	29	11	
SSR-720		2.0	.0787	7.0	.2756	3.5	.1378	8.5	0.9	3.80	5.90	.15	.0060	7	3/64	40	15	
SSR-725	H/M5	2.5	.0984	7.0	.2756	3.5	.1378	8.5	0.9	3.80	5.90	.15	.0060	7	3/64	40	15	
SSR-825		2.5	.0984	8.0	.3150	4.0	.1575	9.5	0.9	4.10	7.16	.15	.0060	6	1/16	60	22	
☆ SSR-830X		3.0	.1181	8.0	.3150	4.0	.1575	9.5	0.9	4.39	7.21	.15	.0060	6	1/16	60	22	
SSR-930Y04		3.0	.1181	9.0	.3543	4.0	.1575	10.6	0.8	4.80	7.60	.15	.0060	7	1/16	66	26	
SSR-930		3.0	.1181	9.0	.3543	5.0	.1969	10.5	1.0	4.80	7.60	.15	.0060	7	1/16	66	26	
☆ SSR-1030	KC/M5/R	3.0	.1181	10.0	.3937	4.0	.1575	11.5	1.0	5.08	8.20	.15	.0060	7	1/16	66	26	
SSR-1140	R	4.0	.1575	11.0	.4331	4.0	.1575	12.5	1.0	6.40	8.75	.20	.0080	8	1/16	75	31	
☆ SSR-1140X		4.0	.1575	11.0	.4331	4.0	.1575	—	—	5.97	8.75	.30	.0120	8	1/16	75	31	
SSR-1240		4.0	.1575	12.0	.4724	4.0	.1575	13.5	1.0	6.50	9.95	.20	.0080	7	2.0mm	104	42	
SSR-1340		4.0	.1575	13.0	.5118	5.0	.1969	15.0	1.0	7.00	11.00	.20	.0080	7	3/32	139	60	
☆ SSR-1640X		R	4.0	.1575	16.0	.6299	5.0	.1969	18.0	1.0	8.03	13.24	.30	.0120	8	3/32	157	68
☆ SSR-1350	R	5.0	.1969	13.0	.5118	4.0	.1575	15.0	1.0	7.50	11.17	.20	.0080	8	2.0mm	112	49	
SSR-1450	R	5.0	.1969	14.0	.5512	5.0	.1969	16.0	1.0	6.95	12.10	.20	.0080	7	3/32	139	60	
☆ SSR-1650X		5.0	.1969	16.0	.6299	5.0	.1969	18.0	1.0	8.03	13.24	.30	.0120	8	3/32	157	68	
☆ SSR-1950		5.0	.1969	19.0	.7480	6.0	.2362	22.0	1.5	8.66	16.25	.30	.0120	6	5/32	481	240	
SSR-1560		KC/M5/R	6.0	.2362	15.0	.5906	5.0	.1969	17.0	1.2	7.76	13.20	.15	.0060	7	7/64	212	101
SSR-1760			6.0	.2362	17.0	.6693	6.0	.2362	19.0	1.2	8.22	14.77	.20	.0080	6	3.5mm	384	187
☆ SSR-1960	6.0		.2362	19.0	.7480	6.0	.2362	22.0	1.5	8.66	16.25	.30	.0120	6	5/32	481	226	
☆ SSR-1970	R		7.0	.2756	19.0	.7480	6.0	.2362	22.0	1.5	10.60	15.93	.30	.0120	7	1/8	379	174
☆ SSR-2270	KC/R		7.0	.2756	22.0	.8661	7.0	.2756	25.0	1.5	10.76	18.90	.30	.0120	7	5/32	569	273
☆ SSR-1980X	R	8.0	.3150	19.0	.7480	6.0	.2362	22.0	1.5	10.60	15.93	.30	.0120	7	1/8	379	174	
☆ SSR-2280	KC/M5/R	8.0	.3150	22.0	.8661	7.0	.2756	25.0	1.5	10.76	18.88	.30	.0120	7	5/32	569	273	
☆ SSR-2690	R	9.0	.3543	26.0	1.0236	8.0	.3150	—	—	14.80	22.64	.30	.0120	7	3/16	703	399	

☆ Production standard.

Notes:

- Metric to inch conversion—see page 68.
- Basic part numbers shown above include code "SS" for AISI 440C stainless steel. If SAE 52100 chrome alloy steel is desired, delete "SS."
- See page 63 for ABEC tolerances.
- r=Maximum shaft or housing fillet radius that bearing corners will clear.

- While we have the capability to produce the sizes listed, they are not all currently in production. Please consult with factory for minimum order quantity and quote.
- Add "Z" for single shield, "ZZ" for two shields, as a suffix to basic part number before "Y" or "W" width variations.

† For flanged bearing substitute prefix "SSRF-" when applicable.

* Please consult with factory for cage availability.

◇ Inch conversions are given for reference only.

** Load ratings are based on ABMA Standard #12.

The information contained in this section is provided to assist you with selecting the proper ball bearing product for your application. Early involvement of NHBB applications engineering is recommended to assure that the product chosen meets your critical requirements for performance, life, and cost.



46	Engineering Services
47	Materials
49	Cages
52	Seals and Shields
53	Internal Bearing Geometry
55	Lubrication
57	Preload and Duplex Ball Bearings
58	Load Ratings and Bearing Life
61	Mounting and Coding
62	Recommended Fits
63	Tolerances
65	Torque
65	Post Service Analysis
66	Interchange Chart
68	Metric Conversion Table
69	Temperature Conversion Table

Computer Design and Analysis

NHBB utilizes computerized design capabilities to examine and analyze complex ball bearing applications. These capabilities ensure that the ultraprecision ball bearing you select will meet your specific requirements for performance, life, and cost.

Engineering Test Laboratory

We maintain a fully equipped engineering test laboratory that enables us to validate the performance characteristics of our ball bearing designs. The lab contains a full complement of commercially available equipment, as well as specialized equipment developed by NHBB and precisely tailored for specific test requirements, such as our patented high speed bearing vibrational analysis system.

Materials Laboratory

Our materials laboratory is specifically designed and equipped to perform complex chemical, metallurgical, and visual analysis of the many component parts in ball bearings. The lab is also used to perform wear and failure studies on customer bearings. Metallurgical studies are conducted with a metallograph and micro-hardness testers. The metallograph performs micro-structure photography at magnifications from 25 to 2,000 times. Micro-hardness testers use diamond indentors under loads from 1 to 10,000 grams to test material hardness. More in depth studies of surface topography and material composition are possible with the use of our own scanning electron microscope (SEM).

During laboratory wear studies, ball bearings are disassembled and examined under a laminar flow hood. All findings may be permanently recorded with a 200X photo-microscope for analysis and future reference.

Functional Tests for Ball Bearings

NHBB has devised a series of rigidly monitored tests that measure starting and running torque, as well as vibration or “noise” levels. During testing, a ball bearing is normally mounted with a thrust load applied.



Anderometer, Dynamic Noise and Vibration Tester

Starting torque is a measure of the effort required to initiate bearing rotation under a thrust load. It can be a critical factor in applications requiring multiple low-speed start/stop movements.

Running torque is a measure of the effort required to maintain rotation under a certain load after rotation has been initiated. NHBB measures running torque values at standard speeds of 1/2 to 2 rpm with applied thrust loads of 75 or 400 grams. The test is fully monitored with results permanently recorded onto a strip chart. This chart may be analyzed for various ball bearing characteristics, such as surface finish, contamination, brinelling, and overall geometry. The test for running torque is time consuming and primarily used on a sample basis or for performing diagnostic analysis. Both starting and running torque tests meet MIL-STD-206 requirements.

NHBB has developed Anderometer “noise ratings” to assure the consistent performance of every bearing we manufacture. After assembly, Anderometers are used to test for bearing noise and vibration under a controlled load and speed.

Please consult NHBB Engineering for recommendations on the many specialized tests we can perform.

Bearing Alloys

The performance of any ball bearing depends on the characteristics of the selected alloys and their heat treatment. Choosing a material with the correct hardness, corrosion resistance, and fatigue life ensures that a bearing will function reliably within the application's operational and environmental parameters.

440C stainless steel and 52100 chrome steel are the most common materials used in precision miniature and instrument ball bearings. AISI 440C is a hardened stainless steel suitable for any application that requires corrosion resistance at room- to mid-hot temperature range. Chrome steel (SAE 52100) is used for specific ball bearing applications where corrosion resistance is not a major concern. 440C is the standard choice for a wide variety of military and commercial applications, as it is the preferred material with the best availability. The properties of 440C balls can also be enhanced with a titanium carbide coating (availability is limited).

As an alternative to 440C, NHBB offers DD400, a specialized stainless steel material suitable for applications that require corrosion resistance and smooth operation. However, the applicability of this material is limited because it is imported.

Extreme operating conditions may require the use of more exotic materials, like BG42® or nitrogen-enriched steel, which perform superbly at high speeds and while enduring extreme temperatures, heavy loads, and corrosive conditions. Although cost considerations occasionally override longevity, the expense involved in more frequent bearing replacement often justifies the higher initial costs of specifying longer lasting specialty metals.

Another option for challenging operating conditions are NHBB's hybrid ceramic ball bearings, which consist of steel rings paired with ceramic (silicon nitride) balls. Hybrid bearings are typically used in applications involving ultra-high speeds or requiring high stiffness (see the next page for more information).

Included in the chart below are some of the materials available through NHBB's Precision Division. The chart serves as a good starting point for material selection, although a more detailed analysis of the factors involved in a specific application is required before making a final determination. All materials listed here are heat treated to achieve optimum hardness and dimensional stability. Please contact NHBB to receive help with selecting the right material.

Material Types

MATERIAL	SPECIFICATION	CONTENTS	MELT METHOD	ATTRIBUTES	ROOM TEMP. HARDNESS (HRC)	
					BALLS	RINGS
AISI 440C	AMS 5618	1% C 17% Cr 0.5% Mo	CEVM*	Premium quality Low impurity level Corrosion resistance	58-65	58-62
SAE 52100	AMS 6444	1% C 1.45% Cr	CEVM*	Premium quality Very low impurity level Corrosion resistance	60-67	60-64
DD400	N/A	0.7% C 13% Cr	CEVM*	Import material Premium quality Very low impurity level	N/A**	58-62
BG42®	AMS 5749	1.1% C 14.75% Cr 4% Mo 1.2% V	VIM/VAR [‡]	Premium quality Low impurity level Corrosion resistance High temperature capabilities	61-65	61-65
Nitrogen-enriched steel	AMS 5898	0.3% C 15% Cr 1% Mo 0.4% N	P-ESR [†]	Premium quality Extreme corrosion resistance Long life	N/A**	60-64

* Consumable electrode vacuum melted

† Pressure electroslag remelting

‡ Vacuum induction melted/vacuum arc remelted

** Material is available in rings only.

BG42® is a registered trademark of Latrobe Specialty Steel Company.

Alternative Ball Material

CERBEC® silicon nitride balls

Engineered specifically for bearings, CERBEC® silicon nitride balls deliver highly controlled, consistent geometry (often better than 0.000001 tolerance) and extremely smooth and consistent surface finish (<0.15 micro-inch Ra). The stiffness, light weight, and inertness of silicon nitride offer significant bearing performance advantages, including higher operating speeds, extended bearing life, and expanded design possibilities for unique and demanding bearing applications.

Typical Applications

- Semiconductor processing (high vacuum)
- Medical and dental handpieces
- Turbomolecular pumps
- Flow meters
- Scanners
- Micro turbines (power generation)
- Aircraft instrumentation
- Machine tool spindles

Specifications

MATERIAL	SPECIFICATION	ATTRIBUTES	ROOM TEMP. HARDNESS (HRC)
Silicon Nitride	CERBEC® silicon nitride	Extended life, lower torque, lighter weight, higher stiffness	>78



Radial Hybrid Ceramic Bearing with Phenolic Crown Retainer

Performance Benefits

PROPERTIES	IMPROVEMENT IN BEARING PERFORMANCE
Lower internal friction	Lower internal temperature Reduced cage and raceway wear
Lighter weight: 58% lighter than steel	Lighter overall bearing weight Decreased centrifugal force Decreased gyroscopic movement
Higher stiffness & higher hardness: 68% stiffer than steel	Reduced skidding Less friction Lower operating temperatures Less wear
Smoother surface: 75% smoother than steel	Decreased lube degradation No cold welding/adhesive wear Less friction Lower operating temperature Less wear
Corrosion resistance	Durability in harsh environments Less wear Resists galling
Higher maximum temperature: 1000°C vs. 320°C for steel	Wider operating range
Lower thermal expansion	Lower operating temperature



Hybrid Ceramic Bearings

Cages

The cage is the ball bearing component that separates and positions the balls at equal intervals around the bearing's raceway. It is also referred to as the retainer or separator. The two standard cage designs include:

- Ribbon, two-piece stamped and crimped (AISI 300 series CRES)
- Crown, one-piece stamped (AISI 400 series CRES)

In addition to these standard cages, NHBB offers many other retainer designs to meet specific requirements. When selecting the most appropriate retainer for your application, some factors to consider include:

- Bearing rotational speed (rpm)
- Starting and running torque limitations
- Operating temperature range
- Noise limitations



Machined Retainers

Standard Cages



Ribbon, Two-Piece, Stamped and Crimped

One of two standard designs for miniature and instrument ball bearings, the two-piece ribbon retainer includes a closed pocket design for good durability and loosely clinched tabs, which are favorable for starting torque. This retainer design is economical and readily available but is limited to lower speed applications.* Two-piece ribbon retainers are used in radial bearings.



Crown, One-Piece, Stamped

The one-piece stamped crown retainer is manufactured from hardened stainless steel and has coined ball pockets, which provide a hard, smooth, low-friction contact surface to the balls. This design is very lightweight, smooth running, cost effective, and readily available. The one-piece stamped crown retainer is also used in radial bearings, but it has a slightly higher speed capability than the stamped ribbon design. For speeds exceeding the capabilities of this retainer, a machined retainer should be considered.*

*For maximum operating speeds, refer to the chart on page 51.

Machined Cages



Machined Phenolic Crown Cage



Machined Polyamide-imide Full Type Cage

Crown, One-Piece

For high speed applications, a machined crown retainer design is a more appropriate choice than the two standard designs (stamped ribbon and stamped crown). This retainer is suitable for radial bearings. It is manufactured from a variety of materials to meet specific application requirements, including paper and linen-based phenolics and polyamide-imide. Both phenolic materials can be vacuum impregnated with oil, allowing for better lubricity within the ball pockets. The polyamide-imide material is fully autoclavable, making it well suited for many medical and dental applications. Additionally, polyamide-imide contains a small amount of graphite and PTFE, which aids in lubricity properties. Its lubricity may be further enhanced by a patented silver coating.

Full Type, One-Piece

This retainer design is best suited for ultra-high speed applications. Its balanced, symmetrical design makes it stable at very high speeds. This retainer, which can only be utilized with angular contact bearings, is manufactured from a variety of materials to meet specific application requirements, including paper and linen-based phenolics and polyamide-imide. Both phenolic materials may be vacuum impregnated with oil, allowing for better lubricity within the ball pockets. The polyamide-imide material is fully autoclavable, making it well suited for many medical and dental applications. Additionally, polyamide-imide contains a small amount of graphite and PTFE, which aids in lubricity properties. Its lubricity may be further enhanced by a patented silver coating.

Alternative Machined Cage Materials

NHBB manufactures machined cages from the following materials (consult with factory for availability):

- Meldin® 8100/9000
- Delrin®
- PGM
- PEEK
- Patented composite metal-polymer
(Silver coated polyamide-imide)

Molded Cages

In addition to the machined retainers listed, the NHBB Precision Division offers a limited variety of molded retainers. These may have a lower speed capability as compared to machined retainers, which is mainly due to the fact that machined retainers may be held to tighter tolerances for critical dimensions.

Cages

The most common bearing cages are shown below. In some cases, such as in high-load applications, a full complement design may be the best choice.

NHBB can also supply specially designed cages to meet your specific requirements. Please contact NHBB for assistance with optimum cage selection.

Cage Types

DESCRIPTION	+	DESIGN	MATERIAL	MAX. SPEED (ref.) dN**	OPERATING TEMP MAX.*	COMMENTS	TYPICAL APPLICATIONS
Ribbon Two-piece stamped and crimped	R		A.I.S.I. 305 steel	150,000	900°F	Superior starting torque Low cost	General purpose
Crown One-piece stamped	H		A.I.S.I. 410 steel	150,000	900°F	Higher speed capability than ribbon retainer Low cost	General purpose
Crown One-piece machined	KB		Phenolic-paper base	1,200,000	250°F	High speed capability Porous material Vacuum impregnated with oil	Medical Machine tools High speed motors
	KC		Phenolic-linen base				
Crown One-piece machined	M5		Polyamide-imide	1,200,000	500°F	High speed capability Requires lubrication Fully autoclavable	Medical/dental High temperature
Crown One-piece machined Silver coated	SC		Patented composite metal-polymer	1,200,000	500°F	High speed capability Self-lubricating Fully autoclavable	Medical/dental High temperature
Full type One-piece machined	KN		Phenolic-paper base	2,000,000	250°F	Ultra-high speed capability Angular contact bearing only Porous material Vacuum impregnated with oil	Machine tool spindles High speed motors
	KM		Phenolic-linen base				
Full type One-piece machined	M4		Polyamide-imide	2,000,000	500°F	Ultra-high speed capability Angular contact bearing only Requires lubrication Fully autoclavable	Medical/dental High temperature
Full type One-piece machined Silver coated	SF		Patented composite metal-polymer	2,200,000	500°F	Ultra-high speed capability Angular contact bearing only Requires lubrication Fully autoclavable	Medical/dental High temperature
Crown/full type One-piece machined	T1		Meldin®	Consult factory	500°F	Porous polyamide-imide material Vacuum impregnated with oil	Low to medium speed
			PGM		500°F 575°F	Self lubricating	Low speed Light load

Additional Ball Separator Designs

DESCRIPTION	+	DESIGN	MATERIAL	MAX. SPEED (ref.) dN**	OPERATING TEMP MAX.*	COMMENTS	TYPICAL APPLICATIONS
Toroid	TT		PTFE	5,000	450°F	Low torque Low speed Angular contact bearing only	Slow rotation Oscillating motion Cryogenic
Slug	SL		PTFE	1,000	450°F	Low torque Low speed	Gimbal assembly Slow rotation Low torque

+ Typical Part Number Designation.

* Rings and balls are heat stabilized to 300°F.

** dN is bore (in millimeters) x rpm.

Additional cage designs and materials available. Please consult with factory.

Meldin® is a registered trademark of Saint-Gobain Performance Plastics Corporation.

Seals and Shields

Seals and shields are protective closures that retain lubricants and assist in preventing contaminants from reaching internal surfaces. When specifying a seal or shield, consideration should be given to the compatibility of the cage and enclosure type to allow for appropriate clearance. In torque-sensitive applications, it may be advantageous to use shields rather than seals because there are no contacting surfaces to create drag.

The following chart includes the common types of shields and seals offered by NHBB. Please consult the factory for help in determining the appropriate seal or shield for your particular application.

Seal and Shield Types

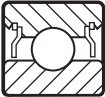
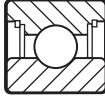
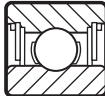
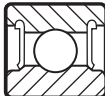
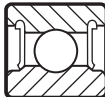
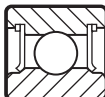
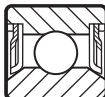
DESCRIPTION	TYPE	DESIGN	MATERIAL	MAX. OPERATING TEMP.*
Shield Removable with snap wire Minimal clearance Most popular	Z		Stainless steel 300 series	600°F
Seal with snap wire Provides minimal clearance to light contact resulting in low torque	L		Glass-reinforced PTFE	400°F
L seal with backing plate Excellent sealing characteristics	LBP		Glass-reinforced PTFE seal Metallic backing plate	400°F
Seal Excellent sealing characteristics	D		Buna-N bonded to steel insert	250°F
Seal Excellent sealing characteristics High cost	D1		Viton® bonded to steel insert	400°F
Seal, lip riding Excellent sealing characteristics	Q		Glass-reinforced PTFE	400°F
Seal with protective shield, lip riding Excellent sealing characteristics	Q4		Glass-reinforced PTFE	400°F

* Rings and balls are heat stabilized to 300°F.

Internal Bearing Geometry

When a ball bearing is running under a load, force is transmitted from one bearing ring to the other through the balls. Since the contact area between each ball and the rings is relatively small, moderate loads can produce stresses of tens, even hundreds of thousands, of pounds per square inch. These internal stresses have a significant impact on the bearing's life and performance. The internal geometry of a bearing—its radial play, raceway curvature and contact angle—must be carefully chosen so loads will be distributed for optimal performance.

Radial and Axial Play

Most ball bearings are assembled so that a slight amount of looseness exists between the balls and the raceways. This looseness is referred to as radial play and axial play. Radial play is the maximum distance that one bearing ring may be displaced with respect to the other in a direction perpendicular to the bearing axis when the bearing is in an unmounted state. Axial play, or end play, is the maximum relative displacement between the two rings of an unmounted ball bearing in a direction parallel to the bearing axis.

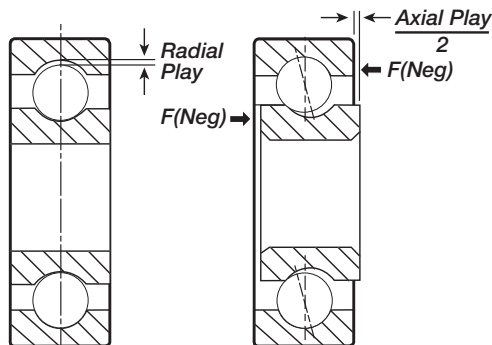

Radial and Axial Play

Since radial play and axial play are both consequences of the same degree of looseness between the components, they bear a mutual dependence, yet their values are usually quite different in magnitude. Radial play often varies between .0002 in. and .0020 in., while axial play may range from .001 in. to .010 in. The suggested radial play ranges for typical applications should always be consulted when a device is in the initial design phase.

Standard Radial Play Ranges

DESCRIPTION	RADIAL PLAY RANGE*	NHBB CODE
Tight	.0001 to .0003	P13
Normal	.0002 to .0005	P25
Loose	.0005 to .0008	P58
Extra loose	.0008 to .0011	P811

*Measurement in inches.
Nonstandard ranges may be specified.

Suggested Radial Play

TYPICAL APPLICATION	SUGGESTED RADIAL PLAY*
Small precision high speed electric motors	.0005 to .0008
Tape guides, belt guides, low speed aps.	.0002 to .0005
Tape guides, belt guides, high speed aps.	.0005 to .0008
Gyro gimbals, horizontal axis	.0002 to .0005
Gyro gimbals, vertical axis	.0005 to .0008
Precision gear trains, low speed electric motors, synchros and servos	.0002 to .0005
Gyro spin bearings, ultra-high-speed turbines and spindles	Consult factory

*Measurement in inches.

In most ball bearing applications, radial play is functionally more critical than axial play. While radial play has become the standard purchasing specification, you may also specify axial play requirements. Keep in mind, however, the values of radial play and axial play for any given bearing design are mathematically interdependent. Radial play is affected by any interference fit between the shaft and bearing I.D. or between the housing and bearing O.D., as shown on page 62. Since the important condition is the actual radial play remaining after assembly of the complete device, the radial play specification for the bearing must be modified in accordance with the discussion in the mounting and coding section on page 61.

Free Angle of Misalignment

As a result of the previously described looseness or play that is permitted to exist between the components of most ball bearings, the inner ring may be cocked or tilted a small amount with respect to the outer ring. This displacement is called free angle of misalignment. The amount of misalignment allowable in a ball bearing is determined by its radial play and track curvature values. Misalignment has positive practical significance because it enables a ball bearing to accommodate small dimensional variations that may exist in associated shafts and housings. The performance of a misaligned bearing will be degraded to a certain extent, but for slight misalignments under reasonably light loads, the effects are not significant in most cases. In general, the amount of misalignment a bearing is subject to by the shaft and housing's physical arrangement should never exceed the bearing's free angle of misalignment. Free angle of misalignment is typically less than one degree.

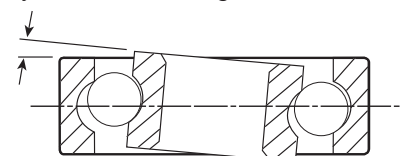

Free Angle of Misalignment

Raceway Curvature

Raceway curvature is the ratio of the raceway radius to ball diameter. Typically, raceway curvature values are either 52 to 54 percent or 57 percent. The lower 52 to 54 percent curvature implies close ball-to-raceway conformity and is useful in applications where heavy loads are encountered. The higher 57 percent curvature is more suitable for torque sensitive applications.

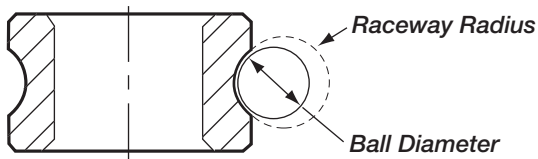

Relationship of Track Radius to Ball Diameter

Formulas for Radial Play, Axial Play and Contact Angle

Radial Play

$$P_D = 2Bd (1 - \cos \beta_0)$$

$$P_D = 2Bd - \sqrt{(2Bd)^2 - P_E^2}$$

Axial Play

$$P_E = 2Bd \sin \beta_0$$

$$P_E = \sqrt{4Bd P_D - P_D^2}$$

Contact Angle

$$\beta_0 = \cos^{-1} \frac{2Bd - P_D}{2Bd}$$

$$\beta_0 = \sin^{-1} \frac{P_E}{2Bd}$$

P_D = radial play

P_E = axial play

β_0 = contact angle

B = total curvature = $(f_i + f_o - 1)$

f_i = inner ring curvature*

f_o = outer ring curvature*

d = ball diameter

*Expressed as the ratio of raceway radius to ball diameter.

Contact Angle

Contact angle is the angle between a plane perpendicular to the ball bearing axis and a line joining the two points where the balls make contact with the inner and outer raceways. The initial contact angle of the bearing is directly related to radial play—the higher the radial play, the higher the contact angle—as well as its inner and outer track curvatures. A low contact angle is desirable for pure radial loads; a higher contact angle is recommended when thrust loading is predominant.

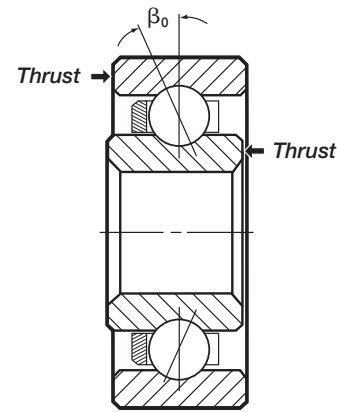

Contact Angle

The contact angle of thrust loaded bearings provides an indication of ball position inside the raceways. When a thrust load is applied to a ball bearing, the balls move away from the median planes of the raceways and assume positions somewhere between the deepest portions of the raceways and their edges.

The table of contact angles shown here gives nominal values under no load.

Table of Contact Angles β_0^*

BALL SIZE D_b	RADIAL PLAY CODE		
	P25	P58	P811
.025	18°	24 1/2°	30°
1/32 & 0.8 mm	16 1/2°	22°	27°
1 mm	14 1/2°	20°	24°
3/64	14°	18°	21°
1/16	12°	16°	19°
3/32	9 1/2°	13°	15 1/2°
1/8	12 1/2°	17°	20°
9/64	12°	16°	19 1/2°
5/32	11°	15°	18 1/2°
3/16	10°	14°	16 1/2°

*The contact angle is given for the mean radial play of the range shown, i.e., for P25 (.0002 to .0005), contact angle is given for .00035.

Types of Lubricants

Oil is the basic lubricant for ball bearings. NHBB offers both petroleum-based and synthetic oils, such as diesters, silicone polymers, and fluorinated compounds. In general, diesters have better low temperature properties, lower volatility, and better temperature/viscosity characteristics than petroleum-based oils. Silicones and fluorinated compounds possess even lower volatility and wider temperature/viscosity properties.

Grease is an oil to which a thickener has been added to prevent migration from the lubrication site, resulting in longer life. It is used in situations where frequent replenishment of the lubricant is undesirable or impossible. The operative properties of grease depend almost wholly on the choice of the base oil. Other factors being equal, the use of grease instead of oil results in higher starting and running torque and may limit the bearing to lower speeds.

Solid film lubricants include any nonfluids used to prevent wear and reduce friction. They range from simple sacrificial cages to graphite powder and ion sputtering. Each type must be engineered for the specific application. Solid film lubricants are very useful in areas of temperature extremes, vacuum, radiation, pressure, or harsh environments where conventional lubricants would fail. Furthermore, they do not deteriorate in storage.

Lubrication Methods

Centrifuging an oil-lubricated bearing removes excess oil and leaves only a very thin film on all surfaces. This method is used on very low torque bearings and can be specified for critical applications.

For ball bearings with porous cages, **vacuum impregnation** forces lubricant into the pores, using the cage as an oil reservoir.

When used with a greased bearing, this method prevents the cage material from leaching oil from the lubricant. Normally, the base oil of the grease is used in the cage to prevent incompatibility.

Grease packing approximately 1/4 to 1/3 of a ball bearing's internal free volume is one of the most common methods of lubrication. Grease quantity can be controlled by the use of special lubrication equipment.

Grease plating consists of mixing a quantity of grease and solvent to the desired consistency, lubricating the bearing with this mixture, then evaporating the solvent at a moderate temperature, leaving a thin film of grease on raceways and balls.

Limiting Speed

No exact formula exists for calculating the maximum operating speed of a ball bearing. Sustained high speed performance is dependent on the specific properties of the bearing, shaft, housing, and other components, as well as the application's specific operating conditions. The retainer is the feature of a ball bearing that most affects rotational speed, followed by tolerance grade and lubricant type and fill. The dimensional accuracy of mating components limits speeds, as does the application's maximum operating temperature. If properly installed and lubricated, high-precision ball bearings will operate for long periods of time at high speeds.

After determining the lube-type and fill appropriate for the speed of the application, consult the chart on page 51 to select a suitable retainer. The chart shows the maximum operating temperatures and speeds for each retainer type. To verify limiting speeds for unique operating conditions not covered here, and for full ball complement-type ball bearings, please consult the factory.

Oils and Base Fluids

PETROLEUM	SYNTHETIC	SILICONE	PERFLUORINATED POLYETHER
Excellent load carrying abilities Moderate temperature range (-25 to 250°F) Greases with petroleum oil bases have high dN capability (recommended for light to heavy loads and moderate to high speeds)	Wide temperature range (-65 to 350°F) Resist oxidation Less film strength than petroleum oils	Wide temperature range (-100 to 400°F) Less film strength than diesters Tend to migrate	Wide temperature range (-112 to 400°F) Stable at high temperatures Chemically inert Low vapor pressure (10 ⁻⁹ Torr)

Speed Factor

The maximum usable operating speed of a grease lubricant is dependent on the type of base oil. The speed factor is a function of the bore of the bearing (d) in millimeters (mm) and the speed of the bearing (N) in revolutions per minute (rpm) where:

$$dN = d \text{ (bearing bore, mm)} \times N \text{ (rpm)}$$

Recommended Speed Limits (dN) for Grease with Select Base Oils

TYPE	dN	TEMPERATURE RANGE °F (°C)
Petroleum	600,000	-25 to +250 (-32 to +121)
Diester	400,000	-65 to +350 (-54 to +177)
Silicone	200,000	-100 to +400 (-73 to +204)
Perfluorinated polyether	200,000	-112 to +400 (-80 to +204)

Lubricant Specifications

NHBB has included a table of commercial and military lubricants and their recommended uses. When ball bearings are ordered without a specified lubricant, it is the policy of NHBB to lubricate with MIL-PRF-6085 oil. Company standard lubricants are LO1 (Windsor Lube L-245X oil) per MIL-PRF-6085 and LG68 (Royco 27 grease) per MIL-PRF-23827. For nonstandard lubricants, please consult the factory to select an appropriate type.

The standard quantity of oil varies with bearing size: it is approximately one drop (3-6 mg) per bearing up to R-2 size and two drops (6-12 mg) for larger sizes. The standard quantity of grease is 25-35% of the bearing's internal free volume. For non-standard applications, please consult the factory for specific lube fill recommendations.

Lubrication Types

CODE	BRAND NAME	BASIC TYPE	OPERATING TEMP.	USES
LO1	Windsor L-245X (MIL-PRF-6085) Fuchs Mineral Oil	Synthetic oil	-65 to +300°F	Light general purpose instrument oil
LO2	Royco® 885 (MIL-PRF-6085) Royal Lubricants	Synthetic oil	-65 to +300°F	Light general purpose instrument oil
LY115	Krytox® 143AC Dupont	Fluorinated oil	-30 to +550°F	High temperature stability Good lubricity properties
LY60	Carnation	Mineral oil	Consult factory	High speed, FDA approved
LG20	Beacon 325 EXXON Mobil	Synthetic grease	-65 to +250°F	General purpose grease
LG68	Royco® 27 (MIL-PRF-23827) Royal Lubricants	Synthetic grease	-100 to +275°F	Corrosion resistance, heavy loads High speed
LY17	Rheotemp® 500 NYE	Synthetic (nonsilicone) grease	-65 to +350°F	Specialty lube, high speed/high temp. Inhibits oxidation, anti-wear protection
LY48	Mobil 28 (MIL-PRF-81322) EXXON Mobil	Synthetic hydrocarbon grease	-65 to +350°F	Wide temperature range Good low temperature torque
LY75	SRI-2 Chevron	Mineral grease	-20 to +350°F	Longer life under high speed/high temp. Water/salt water resistance
LY101	Krytox® 240AC (MIL-PRF-27617) Dupont	Fluorinated grease	-30 to +550°F	High temperature stability with good lubricity properties
LY121	SRL Kyodo	Synthetic grease	-40 to +300°F	Low noise and low torque applications
LY328	Braycote® Micronic® 601EF Castrol®	Perfluorinated polyether grease	-112 to +400°F	Hostile chemical environment Space applications
LY342	Asonic GLY 32 Kluber	Synthetic hydrocarbon	-58 to +284°F	Low noise, high speed
LY732	Minebea 1473 (proprietary) Minebea Co., Ltd.	Synthetic hydrocarbon grease	-20 to +350°F	Longer life under high speed/high temp.

Royco® is a registered trademark of Anderol Company.
Krytox® is a registered trademark of DuPont.

Braycote®, Micronic®, and Castrol® are registered trademarks of Castrol Limited.

Rheotemp® is a registered trademark of Nye Lubricants.

Preload and Duplex Ball Bearings

Preload is defined as the initial axial load placed on a bearing or set of bearings during installation. Preloading facilitates precise control over the operating geometry of the bearing's mating parts, a useful function in applications where axial and radial movement must be held within critical limits.

Ball bearings are preloaded in order to:

- Eliminate radial and axial looseness
- Reduce operating noise
- Improve positioning accuracy
- Reduce repetitive runout
- Reduce the possibility of damage from vibratory loading
- Increase life and axial capacity
- Increase stiffness

Preloading is accomplished either by using a spring preload or, as in duplex ball bearings, through a solid stack of parts.

Spring Preloading

Spring preloading consists of a coil spring or a wavy washer that applies a force against the inner or outer ring of one of the bearings in the assembly. The spring force is normally applied against the non-rotating ring. Since a spring's load is fairly consistent over a wide range of compressed length, the use of a spring for preloading eliminates the need for holding tight location tolerances on machined parts. For example, retaining rings can be used in the spindle assembly, thus saving the cost of a locating shoulder, shims or threaded members. Normally, a spring would not be used where the assembly must withstand reversing thrust loads.

Duplex Ball Bearings

Duplex ball bearings are stacked pairs with built-in preloads. Duplex bearings are manufactured with the raceways of the inner and outer rings offset slightly. When the set of bearings is assembled, the thrust load required to press the adjacent faces of the rings together becomes the desired preload. Duplex ball bearings are used when precise location control is required. They also help satisfy the requirements of increased axial and radial stiffness and deflection control.

The three methods of mounting preloaded duplex bearings are back-to-back (DB), face-to-face (DF) and tandem (DT):

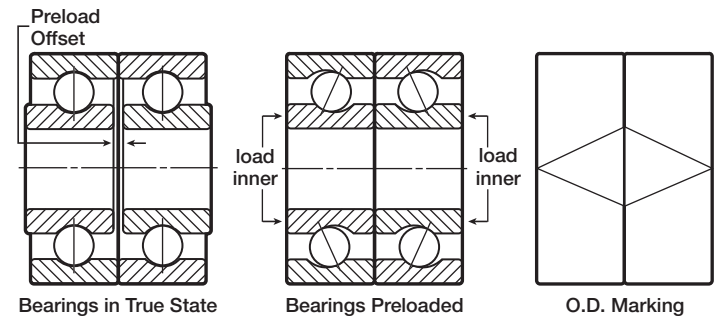

When a back-to-back (DB) duplex pair is mounted, the outer rings abut and the inner rings are drawn together, providing maximum moment stiffness.

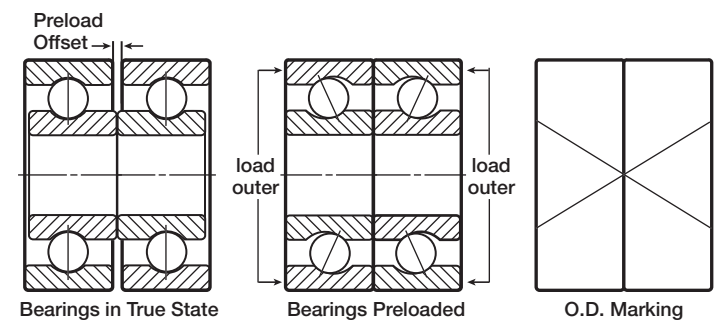

When face-to-face (DF) duplex pairs are mounted, the inner rings abut and the outer rings are drawn together, providing a higher radial and axial stiffness and accommodation of misalignment.

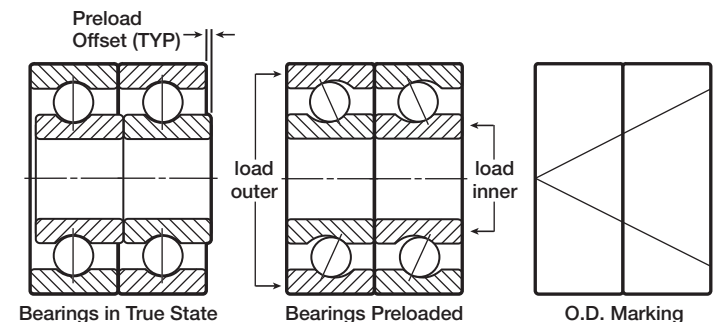

With tandem (DT) pairs, both inner and outer rings abut and are capable of sharing a thrust load, providing increased thrust capacity.

NHBB can provide assistance in selecting the appropriate preload specifications for your application.

Static Load Ratings

The static load rating (C_0) given in the product listings (pages 16-44) is the radial load that a nonrotating bearing will support without damage. In evaluating static load conditions, any forces exerted during assembly and test must be considered along with vibration and impact loads sustained during handling, test, shipment, and assembly.

Dynamic Load Ratings

Dynamic loading (C) includes built-in preload, weight supported members, and the effect of any acceleration due to vibration or motion changes. The dynamic load rating (C) for a radial or angular contact ball bearing is a calculated, constant radial load that a group of apparently identical bearings will theoretically endure for a rating life of one million revolutions. The dynamic load rating is a reference value only. A base value rating life of one million revolutions has been chosen for ease of calculation. The dynamic load rating values (C) given in the product listings include the effects of race-to-ball conformity and are in accordance with ABMA Standards #9 and #12.

Rating Life

The rating life L_{10} of a group of apparently identical ball bearings is the life in millions of revolutions that 90% of the group will complete or exceed. For a single bearing, L_{10} also refers to the life associated with 90% reliability. The rated life (L_{10}) can be computed from the formula:

$$L_{10} = (C/P_r)^3 \times 10^6 \text{ revolutions}$$

where: C = dynamic radial load rating (lb.)

The dynamic radial load (C) can be found in the product tables.

P_r = dynamic equivalent radial load (lb.)

See calculating dynamic equivalent radial load below.

For a more conservative estimate of life than L_{10} , multiply the above formula by a reliability modifier (a_2). Values for a_2 are located in the Reliability Material Life Modifier table found on page 59. The table provides selected modifiers for calculating failure rates down to 1% (L_1) for both 440C and 52100 alloys.

Rating Life in Hours

To convert the rating to number of hours, multiply the results of the above equation by the following:

$$L_{10}/(\text{rpm} \times 60)$$

Calculating Equivalent Radial Load

More often than not, bearings whose loads are primarily radial are also subjected to some axial forces. When the magnitude of this axial component of the load is greater than a negligible value, it is convenient to interpret this combined radial and thrust load in terms of a simple radial load so that the basic life equation may be used. This simple radial load, known as the equivalent load, is defined as that constant stationary radial load which, if applied to a rotating inner ring, would give the same life as that which the bearing will attain under the actual conditions of load and rotation.

For conventional bearing types other than those with filling notches, the equivalent radial load is given by the maximum of the two values where:

$$\text{a) } P_r = VF_r$$

$$\text{b) } P_r = XVF_r + YF_a$$

V = rotation factor

X = radial factor

Y = thrust factor

F_r = radial load

F_a = thrust load

In calculations for miniature and instrument bearings whose outside diameter is .625 inches and below, the following values are sufficiently accurate: $X=0.56$, $Y=2.10$ and $e=0.16$. In the case of the larger bearing series, consult the table on page 60 for determining values X , Y and e . In all series, the rotational factor V is 1.0 for inner ring rotation and 1.2 for outer ring rotation with respect to load.

In the chart on page 60, the factor e represents the ratio of F_a/VF_r for which the two equations are equal. If the ratio of loads is such that $F_a/VF_r < e$, then formula (a) is used; if $F_a/VF_r > e$, then formula (b) is used.

Bearing Life Under Varying Loads

In many applications, bearings operate at different loads and speeds for extended periods of time. If the data for loads, speeds and their time periods are available, the following formula may be used to calculate life:

$$L_n = \frac{1}{\frac{p_1}{L_{n1}} + \frac{p_2}{L_{n2}} + \frac{p_3}{L_{n3}} + \dots + \frac{p_n}{L_{nn}}}$$

Note: $p_1 + p_2 + p_3 + \dots + p_n = 1.0$

Load Ratings and Bearing Life

Life Modifiers

For most cases, the L_{10} life obtained from the basic rating life formula described earlier will provide a satisfactory criteria for bearing performance. For particular applications, however, it may be desirable to consider life calculations for different reliabilities and special bearing properties and operating conditions.

Bearing Material

NHBB recommends reducing the load rating published for 52100 by 20% for 440C. This is a conservative approach to ensure that the bearing capacity is not exceeded under the most adverse conditions. This is incorporated in the reliability modifier (a_2) as shown:

Table of Reliability Material Life Modifier (a_2)

REQUIRED RELIABILITY (%)	L_N	52100 $a_2 =$	440C $a_2 =$
90	L_{10}	1.00	0.50
95	L_5	0.62	0.31
96	L_4	0.53	0.27
97	L_3	0.44	0.22
98	L_2	0.33	0.17
99	L_1	0.21	0.11

Elastohydrodynamics (EHD Effect)

The presence of a thin film of oil at the mutually contacting ball-to-raceway interface enhances the load capacity of a ball bearing.

Lubricant Life

A bearing’s effective life is often governed by the lubricant’s life. This is usually the case for applications involving very light loads and/or very slow speeds. In such instances, the conventional fatigue life calculated will be unrealistically high. The lubricant’s ability to provide sufficient film strength is affected by:

- Quantity and condition of the lubricant in the bearing
- Environmental conditions (e.g. ambient temperature, area cleanliness)
- The load-speed cycle

Specialized oils and greases, which exhibit favorable performance characteristics over an extended period, are available.

Other Life Adjustments

Loads are seldom applied ideally. Often, the conventional rating life has to be modified due to application abnormalities, intentional or unknown. The following conditions have the practical effect of modifying the ideal, theoretical rating life (L_{10}):

- Vibration and/or shock-impact loads
- Angular misalignment
- Oscillatory duty
- High-speed effects
- Operation at elevated temperatures
- Fits
- Internal design

While it is difficult to provide the exact effect upon life under any of these conditions, NHBB is able to provide bearing life estimates based on empirical data to help you forecast bearing life for your application.

Load Ratings and Bearing Life

Table A: Factors X, V and Y

BEARING TYPE	$\frac{F_a}{ZD^2}$ UNITS LB., IN.	IN RELATION TO THE LOAD THE INNER RING IS:		SINGLE ROW BEARINGS $\frac{F_a}{V F_r} > e$		e
		ROTATING V	STATIONARY V	X	Y	
Radial deep groove ball bearings	25				2.30	0.19
	50				1.99	0.22
	100				1.71	0.26
	150				1.55	0.28
	200	1	1.2	0.56	1.45	0.30
	300				1.31	0.34
	500				1.15	0.38
	750				1.04	0.42
1,000				1.00	0.44	
Angular contact ball bearings with contact angle: 5°	25				2.30	0.23
	50				1.99	0.26
	100				1.71	0.30
	150				1.55	0.34
	200	1	1.2	0.56	1.45	0.36
	300				1.31	0.40
	500				1.15	0.45
	750				1.04	0.50
1,000				1.00	0.52	
10°	25				1.88	0.29
	50				1.71	0.32
	100				1.52	0.36
	150				1.41	0.38
	200	1	1.2	0.46	1.34	0.40
	300				1.23	0.44
	500				1.10	0.49
	750				1.01	0.54
1,000				1.00	0.54	
15°	25				1.47	0.38
	50				1.40	0.40
	100				1.30	0.43
	150				1.23	0.46
	200	1	1.2	0.44	1.19	0.47
	300				1.12	0.50
	500				1.02	0.55
	750				1.00	0.56
1,000				1.00	0.56	
20°		1	1.2	0.43	1.00	0.57
25°		1	1.2	0.41	0.87	0.68
30°		1	1.2	0.39	0.76	0.80
35°		1	1.2	0.37	0.66	0.95
40°		1	1.2	0.35	0.57	1.14

Nomenclature is as follows:

- V = rotation factor
- X = radial factor
- Y = thrust factor
- F_r = radial load
- F_a = thrust load
- Z = number of balls
- D = ball diameter in inches

Values of X, Y, and e for load or contact angle other than shown are obtained by linear interpolation.

Turn to page 58 for instructions on how to calculate equivalent radial load.

Bearing Fits and the Design of Mating Equipment

Accurate shaft and housing fits are important for proper bearing installation and operation. In ordinary applications, miniature ball bearings are used with a light load, so a light interference fit to a narrow clearance fit is usually sufficient. Light cross section bearings, such as Torque Tube and Thinex bearings, are more sensitive to shaft and housing imperfections and require looser fits than heavier cross section bearings.

A bearing that is fitted too tightly or too loosely, or is damaged during assembly by excessive force or shock loading, may degrade the performance of your assembly. This possibility can be reduced by following some general guidelines during the design of mating parts (see Table of Recommended Fits on page 62), and by observing the following four cautions during the assembly process.

Caution 1. When establishing shaft or housing sizes, the effect of differential thermal expansion must be taken into account. If thermal gradients are present or dissimilar materials are used, room temperature fits must be adjusted accordingly. Approximate thermal coefficients for common materials are available from NHBB.

Caution 2. When miniature and instrument bearings are interference fitted, either intentionally or as a result of thermal gradients, the bearing radial play is reduced by an amount equal to approximately 80% of the actual diametral interference fit. Thus:

$$\text{Radial play} = .0002''$$

$$\text{Tolerance interference fit} = .0003T$$

$$80\% \text{ of interference fit} = (.0003 \times .8) = .00024''$$

$$\text{Resultant operational radial play} = (-.00004) \text{ tight}$$

The bearing will be subject to early failure in most applications because it may already be overloaded. This problem is solved either by a higher radial play or looser fit.

Caution 3. If the outer ring or inner ring face is to be clamped or abutted against a shoulder, make sure the shoulder configuration provides a good mounting surface:

- The shoulder face must be perpendicular to the bearing mounting diameter within .0002 inches per inch.
- The corner between the mounting diameter and the face must have either an undercut or a fillet radius no larger than that shown in the product tables under column "r".
- The shoulder diameter must conform to the table on page 62.

Caution 4. It is relatively easy to damage a miniature and instrument bearing during assembly simply by exceeding its load capacity. Adequate fixturing must be provided for handling and assembling precision bearings to ensure that:

- When assembling the bearing to the shaft, force is applied only to the inner ring.
- When assembling into the housing, force is applied only to the outer ring.
- Any movement or shock loads which would be transmitted through the bearing are eliminated.

Coding Classification of Bore and Outside Diameter

When required for selective assembly or for other reasons, bores and/or outside diameters may be classified into coded size groupings within the tolerance ranges specified in this chart. Methods of measuring and determining classification size are specified in the ABMA Standard under Section 12.1 and 12.2.

Complete code designation consists of the bore code as the first digit or letter and the outside diameter code as the second digit or letter. When only one dimension is classified, the other is denoted by "0".

Coding Classification Tolerance Ranges

SIZE TOLERANCE* (FROM MAXIMUM)	.0005** CALIB.	.0001*** CALIB.
maximum to -.00005	A	1
-.00005 to -.00010	B	
-.00010 to -.00015	C	2
-.00015 to -.00020	D	

*Measurement in inches.

NHBB part number nomenclature:

-**C44 (.000050 in. increment)

-***CXX (.00010 in. increment)

Examples

"C12"	Bore falls between	0.00000 & -0.00010
	O.D. falls between	-0.00010 & -0.00020
"CAB"	Bore falls between	0.00000 & -0.00005
	O.D. falls between	-0.00005 & -0.00010
"C10"	Bore falls between	0.00000 & -0.00010
	O.D. is not coded	

Recommended Fits

Table of Recommended Fits*

TYPICAL APPLICATIONS	SHAFT FIT \diamond	SHAFT DIAMETER \diamond	HOUSING FIT \diamond	HOUSING DIAMETER \diamond
Tape guide roller, pulley, cam follower, outer ring rotation	.0000 – .0004L	d – .0002 d – .0004	.0001L – .0003T	D – .0001 D – .0003
Drive motor (spring preload)	.0001T – .0003L	d – .0001 d – .0003	.0000 – .0004L	D +.0002 D – .0000
Precision synchro or servo	.0000 – .0002L*	d – .0001 d – .0003	.0000 – .0002L*	D +.0001 D – .0001
Potentiometer	.0001T – .0003L	d – .0001 d – .0003	.0000 – .0004L	D +.0002 D – .0000
Encoder spindle	.0000 – .0002L*	d – .0001 d – .0003	.0000 – .0002T*	D – .0001 D – .0003

* For Radial Play .0002 to .0005

 \diamond Measurement in inches.

L = loose fit.

D = bearing O.D. as listed.

T = tight fit.

+ Bearings must be purchased with bore and O.D. coding.

d = bearing bore as listed.

EXAMPLE: To use SSR-2 bearing in a potentiometer, the shaft diameter should be .1250 – .0001 to .1250 – .0003 or .1249 to .1247. The housing should be .3750 +.0002 to .3750 – .0000 or .3752 to .3750.

Table of Recommended Shoulder Diameter*

BASIC SIZE	MINIMUM SHAFT SHOULDER DIAMETER	MAXIMUM HOUSING SHOULDER DIAMETER
SSRI-2	.060	.105
SSRI-2 1/2	.071	.132
SSRI-3	.079	.164
SSRI-4	.102	.226
SSRI-3332	.114	.168
SSRI-5	.122	.284
SSRI-418	.148	.226
SSRI-518	.153	.284
SSRI-618	.153	.347
SSR-2	.179	.325
SSR-2A	.179	.446
SSRI-5532	.180	.288
SSR-1640X	.210	.580
SSRI-5632	.210	.288
SSRI-6632	.216	.347
SSR-3	.244	.446
SSR-1650X	.250	.580
SSR-1950	.250	.700
SSR-1960	.290	.700
SSRI-614	.272	.352

*Measurement in inches.

BASIC SIZE	MINIMUM SHAFT SHOULDER DIAMETER	MAXIMUM HOUSING SHOULDER DIAMETER
SSRI-814	.284	.466
SSR-4	.310	.565
SSRI-1214	.322	.678
SSR-2270	.325	.810
SSR-2280	.370	.810
SSR-2690	.420	.950
SSRI-8516	.347	.466
SSRI-1038	.435	.565
SSRI-1438	.451	.799
SSR-100	.450	.949
SSRI-1212	.560	.690
SSRI-1812	.625	1.025
SSRI-1458	.665	.835
SSRI-1634	.790	.960

Tolerances

For more than thirty years, NHBB has been an active member in the American Bearing Manufacturers Association (ABMA) and its associated ball bearing technical committee, the Annular Bearing Engineers' Committee (ABEC).

The ABEC tolerances listed below are current as of this catalog's printing. These tolerances are reviewed regularly and updated as required. The ABMA Standards may be obtained by contacting: ABMA, 2025 M Street, NW, Suite 800, Washington, DC 20036.

Inner Ring*

CHARACTERISTIC	ABEC 1	ABEC 3P	ABEC 5P	ABEC 7P	ABEC 9P
Bore tolerance limits	+0.000 -0.0003	+0.000 -0.0002	+0.000 -0.0002	+0.000 -0.0002	+0.000 -0.0001
Bore 2 pt. out of roundness	—	—	.0001	.0001	.00005
Bore taper	—	—	.0001	.0001	.00005
Radial runout	.0004	.0002 ⁽¹⁾	.00015	.0001	.00005
Width variation	—	—	.0002	.0001	.00005
Bore runout with face	—	—	.0003	.0001	.00005
Race runout with face	—	—	.0003	.0001	.00005

*Measurement in inches. ⁽¹⁾ Add .0001 to the tolerance if bore size is over 10 mm (.3937 in.).

Outer Ring*

CHARACTERISTIC	CONFIGURATION	SIZE RANGE	ABEC 1	ABEC 3P	ABEC 5P	ABEC 7P	ABEC 9P
Mean O.D. tolerance limits	All	0-.7086 in. (0-18 mm)	+0.000 -0.0003	+0.000 -0.0003	+0.000 -0.0002	+0.000 -0.0002	+0.000 -0.0001
		.7086-1.1811 in. (over 18-30 mm)	+0.000 -0.0004	+0.000 -0.0003	+0.000 -0.0002	+0.000 -0.0002	+0.000 -0.00015
Maximum O.D. tolerance limits	Open	0-.7086 in. (0-18 mm)	+0.0001 -0.0004	+0.0001 -0.0004	+0.0000 -0.0002	+0.0000 -0.0002	+0.0000 -0.0001
		.7086-1.1811 in. (over 18-30 mm)	+0.0001 -0.0005	+0.0001 -0.0004	+0.0000 -0.0002	+0.0000 -0.0002	+0.0000 -0.00015
	Shielded	0-.7086 in. (0-18 mm)	+0.0002 -0.0005	+0.0002 -0.0005	+0.00004 -0.00024	+0.00004 -0.00024	— —
		.7086-1.1811 in. (over 18-30 mm)	+0.0002 -0.0006	+0.0002 -0.0005	+0.00004 -0.00024	+0.00004 -0.00024	— —
O.D. 2 pt. out of roundness	Open	0-.7086 in.	—	—	.0001	.0001	.00005
	Open	.7086-1.1811 in.	—	—	.0001	.0001	.00008
	Shielded	0-1.1811 in.	—	—	.0002	.0002	—
O.D. taper	All	0-.7086 in.	—	—	.0001	.0001	.00005
	All	.7086-1.1811 in.	—	—	.0001	.0001	.00008
	Shielded	0-1.1811 in.	—	—	.0002	.0002	—
Radial runout	All	0-.7086 in.	.0006	.0004	.0002	.00015	.00005
	All	.7086-1.1811 in.	.0006	.0004	.0002	.00015	.0001
Width variation	All	0-1.1811 in.	—	—	.0002	.0001	.00005
O.D. runout with face	All	0-1.1811 in.	—	—	.0003	.00015	.00005
Race runout with face	Plain	0-.7086 in.	—	—	.0003	.0002	.00005
	Plain	.7086-1.1811 in.	—	—	.0003	.0002	.0001
	Flanged	0-1.1811 in.	—	—	.0003	.0003	—
Flange width tolerance limits		—	—	+0.000 -0.0020	+0.000 -0.0020	+0.000 -0.0020	— —
		—	—	+0.005 -0.0020	+0.000 -0.0010	+0.000 -0.0010	— —
Flange diameter tolerance limits		—	—	+0.005 -0.0020	+0.000 -0.0010	+0.000 -0.0010	— —

*Measurement in inches, unless otherwise indicated.

Ring Width*

CHARACTERISTIC	CONFIGURATION	ABEC 1	ABEC 3P	ABEC 5P	ABEC 7P	ABEC 9P
Width	Single bearing components	+0.000 -0.005	+0.000 -0.005	+0.000 -0.001	+0.000 -0.001	+0.000 -0.001
	Duplex pair	— —	— —	+0.000 -0.015	+0.000 -0.015	+0.000 -0.015

*Measurement in inches.

Tolerances

ABEC 5T Tolerances

	BORE DIAMETER		RADIAL RUNOUT	MEAN DIAMETER TOLERANCE
	OVER	INCL.		
Inner Ring	0.35433	1.18110	0.0002	+0.0000 -0.0002
	1.18110	1.77165	0.0003	+0.0000 -0.0003
	1.77165	2.55906	0.0004	+0.0000 -0.0004
OUTSIDE DIAMETER				
Outer Ring	0.55118	1.10236	0.0002	+0.0000 -0.0002
	1.10236	3.14961	0.0003	+0.0000 -0.0004

BORE INNER RING		SINGLE WIDTH	DUPLEX WIDTH
OVER	INCL.		
0.00000	1.18110	+0.000 -0.001	+0.000 -0.015
0.18110	3.14961	+0.000 -0.005	+0.000 -0.020

Please refer to ABMA Standard #12 for more information.

ABEC 7T Tolerances

	BORE DIAMETER		RADIAL RUNOUT	MEAN DIAMETER TOLERANCE
	OVER	INCL.		
Inner Ring	0.35433	0.70866	0.0001	+0.0000 -0.0002
	0.70866	1.77165	0.00015	+0.0000 -0.0002
	1.77165	2.55906	0.0002	+0.0000 -0.0003
OUTSIDE DIAMETER				
Outer Ring	0.55118	1.10236	0.00015	+0.0000 -0.0002
	1.10236	1.96850	0.0002	+0.0000 -0.0004
	1.96850	2.55906	0.0002	+0.0000 -0.0003

BORE INNER RING		SINGLE WIDTH	DUPLEX WIDTH
OVER	INCL.		
0.00000	1.18110	+0.000 -0.001	+0.000 -0.015
0.18110	3.14961	+0.000 -0.001	+0.000 -0.020

Please refer to ABMA Standard #12 for more information.

Torque

Starting torque and running torque are extremely important in applications such as gyro gimbals, low power consumption motors, and precision positioning devices. In such applications, the total system should be evaluated in the design phase for torque input versus torque reflected by the various driven components. In many cases, bearing design and manufacture may be modified to reduce torque.

Maximum Starting Torque Values For ABEC 7P Bearings

NHBB BASIC SIZE	TEST LOAD (THRUST) GRAMS	MAXIMUM STARTING TORQUE MILLIGRAM – MILLIMETERS		
		RADIAL PLAY		
		TIGHT FIT .0001" – .0003"	NORMAL FIT .0002" – .0005"	LOOSE FIT .0005" – .0008"
SSRI-2	75	1,800	1,500	1,400
SSRI-2 1/2	75	1,800	1,500	1,400
SSRI-3	75	1,800	1,500	1,400
SSRI-4	75	1,800	1,500	1,400
SSRI-5	75	1,800	1,500	1,400
SSRI-418	75	1,800	1,500	1,400
SSRI-518	75	1,800	1,500	1,400
SSRI-618	75	2,000	1,600	1,500
SSR-2	400	5,000	4,500	4,200
SSR-2A	400	5,000	4,500	4,200
SSRI-5532	75	1,800	1,500	1,400
SSRI-5632	75	1,800	1,500	1,400
SSRI-6632	75	2,000	1,600	1,500
SSR-3	400	6,500	5,500	5,000
SSRI-614	75	1,800	1,500	1,400
SSRI-814	400	6,000	5,200	4,800
SSR-4	400	7,000	6,000	5,500
SSRI-1214	400	8,000	7,000	6,500
SSRI-1438	400	11,000	9,500	9,000

Post Service Analysis

Our precision miniature and instrument bearings have proven to be highly reliable when used within the defined limits of their capabilities. However, bearings, like any mechanical device, are subject to failure. Failure may occur due to improper mounting, lubrication, environment, loading, maintenance, or contamination after installation, as well as poor workmanship or material deficiencies.

NHBB maintains a technical staff experienced in the analysis of bearing failure. Using their specialized knowledge, analytical tools, and ultra-precision measuring and testing equipment, the cause of bearing failure can often be determined. This capability is available to customers experiencing bearing-related problems. In the event that post-service bearing analysis is desired, please contact a NHBB sales representative who will make the necessary arrangements.

The hardware and information required to successfully perform a post-service analysis include:

- All bearing components and the assembly in which the bearing was used
- Bearing manufacturing lot numbers, if available
- Historical information that describes the conditions under which the device operated, such as speed, loads, temperature, and atmospheric conditions, as well as any unusual shock, vibration, electrical arcing, or handling situations to which the device was subjected

Upon completion of the bearing analysis, a detailed report noting our findings will be provided.

Interchange Chart

NHBB	NMB	TIMKEN (MPB)	BARDEN	MYONIC (RMB)	ORIGINAL NHBB P/N
SSRI-2	DDRI-2	S2C	SR0-9	UL1304X	SR09
SSRI-2 1/2	DDRI-2 1/2	S2 1/2C	SR0	UL1505X	SR0
SSRI-2 1/2ZZ	DDRI-2 1/2ZZ	S2 1/2CHH	SR0SS	ULZ1505X	SR0PP
SSRI-3	DDRI-3	S3C	SR1	R1706X	SR1
SSRI-3ZZ	DDRI-3ZZ	S3CHH	SR1SS	RF1706X	SR1PP
SSRI-4	DDRI-4	S4C	SR1-4	R2508X	SR1-4
SSRI-4ZZ	DDRI-4ZZ	S4CHH	SR1-4SS	RF2508X	SR1-4PP
SSRI-3332	DDRI-3332	S3332C	SR133	UL3006X	SR133
SSRI-3332ZZ	DDRI-3332ZZ	S3332CHH	SR133SS	ULZ3006X	SR133PP
SSRI-5	DDRI-5	S5C	SR1-5	R3010X	SR1-5
SSRI-5ZZ	DDRI-5ZZ	S5CHH	SR1-5SS	RF3010X	SSRI-5PP
SSRI-418	DDRI-418	S418C	SR144	UL4008X	SR144
SSRI-418ZZ	DDRI-418ZZ	S418CHH	SR144SS	ULZ4008X	SR144PP
SSRI-518	DDRI-518	S518C	SR2-5	R4010X	SR2-5
SSRI-518ZZ	DDRI-518ZZ	S518CHH	SR2-5SS	RF4010X	SR2-5PP
SSRI-618	DDRI-618	S618C	SR2-6		SR2-6
SSRI-618ZZ	DDRI-618ZZ	S618CHH	SR2-6SS		SR2-6PP
SSR-2	DDR-2	SR2C	SR2	R4012X	SR2
SSR-2ZZ	DDR-2ZZ	SR2CHH	SR2SS	RF4012X	SR2PP
SSR-2A	DDR-2A	SR2AC	SR2A		SR2A
SSR-2ZZA	DDR-2ZZA	SR2ACHH			SR2APP
SSRI-5532	DDRI-5532	S5532C	SR155	UL5010X	SR155
SSRI-5532ZZ	DDRI-5532ZZ	S5532CHH	SR155SS	UL5010Z	SR155PP
SSRI-5632	DDRI-5632	S5632C	SR156	UL6010X	SR156
SSRI-5632ZZ	DDRI-5632ZZ	S5632CHH	SR156SS	ULZ6010X	SR156PP
SSRI-6632	DDRI-6632	S6316C	SR166	UL6012X	SR166
SSRI-6632ZZ	DDRI-6632ZZ	S6316CHH	SR166SS	ULZ6012X	SR166PP
SSR-3	DDR-3	SR3R	SR3	R6016X	SR3
SSR-3ZZ	DDR-3ZZ	SR3RHH	SR3SS	RF6016X	SR3PP
SSRI-614	DDRI-614	S614C	SR168	UL8012X	SR168
SSRI-614ZZ	DDRI-614ZZ	S614CHH	SR168SS	ULZ8012X	SR168PP
SSRI-814	DDRI-814	S814C	SR188	UL8016X	SR188
SSRI-814ZZ	DDRI-814ZZ	S814CHH	SR188SS	ULZ8016X	SR188PP
SSR-4	DDR-4	SR4C	SR4	R8020X	SR4
SSR-4ZZ	DDR-4ZZ	SR4CHH	SR4SS	RF8020X	SR4PP
SSRI-1214	DDRI-1214	SR4AR		SR4A	SR4AD
SSRI-1214ZZ	DDRI-1214ZZ	SR4ARHH	SR4ASS		SR4APPD
SSRI-8516	DDRI-8516	S8516R	SR1810		SR1810
SSRI-8516ZZ	DDRI-8516ZZ	S8516RHH	SR1810SS		SR1810PP
SSRI-1438	DDRI-1438	SR6R	SR6		SR6D

This chart is intended as a reference only. Users should consult with the listed manufacturers' catalogs to establish dimensional interchangeability. Ball complements and load ratings may differ although dimensionally equivalent. NHBB cannot be held responsible for any errors contained herein.

Interchange Chart

NHBB	NMB	TIMKEN (MPB)	BARDEN	MYONIC (RMB)	ORIGINAL NHBB P/N
SSRI-1438ZZ	DDRI-1438ZZ	SR6RHH	SR6SS		SR6PPD
SSRI-1812	DDRI-1812	SR8R	SR8		SR8D
SSRI-1812ZZ	DDRI-1812ZZ	SR8RHH	SR8SS		SR8PPD
SSRIF-2	DDRIF-2	S2FC	SFR09	ULK1304X	SFR09
SSRIF-2 1/2	DDRIF-2 1/2	S2 1/2FC	SFR0	ULK1505X	SFR0
SSRIF-2 1/2ZZ	DDRIF-2 1/2ZZ	S2 1/2FCHH	SFR0SS	ULKZ1505X	SFR0PP
SSRIF-3	DDRIF-3	S3FC	SFR1	RK1706X	SFR1
SSRIF-3ZZ	DDRIF-3ZZ	S3FCHH	SFR1SS	RKF1706X	SFR1PP
SSRIF-4	DDRIF-4	S4FC	SFR1-4	RK2508X	SFR1-4
SSRIF-4ZZ	DDRIF-4ZZ	S4FCHH	SFR1-4SS	RKF2508X	SFR1-4PP
SSRIF-3332	DDRIF-3332	S3332FC	SFR133	ULK3006X	SFR133
SSRIF-3332ZZ	DDRIF-3332ZZ	S3332FCHH	SFR133SS	ULKZ3006X	SFR133PP
SSRIF-5	DDRIF-5	S5FC	SFR1-5	RK3010X	SFR1-5
SSRIF-5ZZ	DDRIF-5ZZ	S5FCHH	SFR1-5SS	RKF3010X	SFR1-5PP
SSRIF-418	DDRIF-418	S418FC	SFR144	ULK4008X	SFR144
SSRIF-418ZZ	DDRIF-418ZZ	S418FCHH	SFR144SS	ULKZ4008X	SFR144PP
SSRIF-518	DDRIF-518	S518FC	SFR2-5	RK4010X	SFR2-5
SSRIF-518ZZ	DDRIF-518ZZ	S518FCHH	SFR2-5SS	RKF4010X	SFR2-5PP
SSRIF-618	DDRIF-618	S618FC	SFR2-6		SFR2-6
SSRIF-618ZZ	DDRIF-618ZZ	S618FCHH	SFR2-6SS		SFR2-6PP
SSRF-2	DDRF-2	SR2FC	SFR2	RK4012X	SFR2
SSRF-2ZZ	DDRF-2ZZ	SR2FCHH	SFR2SS	RKF4012X	SFR2PP
SSRIF-5532	DDRIF-5532	S5532FC	SFR155	ULK5010X	SFR155
SSRIF-5532ZZ	DDRIF-5532ZZ	S5532FCHH	SFR155SS	ULKZ5010X	SFR155PP
SSRIF-5632	DDRIF-5632	S5632FC	SFR156	ULK6010X	SFR156
SSRIF-5632ZZ	DDRIF-5632ZZ	S5632FCHH	SFR156SS	ULKZ6010X	SFR156PP
SSRIF-6632	DDRIF-6632	S6316FC	SFR166	ULK6012X	SFR166
SSRIF-6632ZZ	DDRIF-6632ZZ	S6316FCHH	SFR166SS	ULKZ6012X	SFR166PP
SSRF-3	DDRF-3	SR3FC	SFR3X3		SFR3C
SSRF-3ZZ	DDRF-3ZZ	SR3FCHH	SFR3SS	RKF6016X	SFR3PP
SSRIF-614	DDRIF-614	S614FC	SFR168	ULK8012X	SFR168
SSRIF-614ZZ	DDRIF-614ZZ	S614FCHH	SFR168SS	ULKZ8012X	SFR168PP
SSRIF-814	DDRIF-814	S814FC	SFR188	ULK8016X	SFR188
SSRIF-814ZZ	DDRIF-814ZZ	S814FCHH	SFR188SS	ULKZ8016X	SFR188PP
SSRF-4	DDRF-4	SR4FC	SFR4	RK8020X	SFR4
SSRF-4ZZ	DDRF-4ZZ	SR4FCHH	SFR4SS	RKF8020X	SFR4PP
SSRIF-8516	DDRIF-8516	S8516FC	SFR1810		SFR1810
SSRIF-8516ZZ	DDRIF-8516ZZ	S8516FCHH	SFR1810SS		SFR1810PP
SSRIF-1438	DDRIF-1438		SFR6X5		SFR6DC
SSRIF-1438ZZ	DDRIF-1438ZZ	SR6FRHH	SFR6SS		SFR6PPD

This chart is intended as a reference only. Users should consult with the listed manufacturers' catalogs to establish dimensional interchangeability. Ball complements and load ratings may differ although dimensionally equivalent. NHBB cannot be held responsible for any errors contained herein.

Metric Conversion Table

FRACTION	INCH	mm	FRACTION	INCH	mm	FRACTION	INCH	mm
1/64	0.0156	0.3969	5/16	0.3125	7.9375	47/64	0.7344	18.6532
	0.0250	0.6350		0.3150	8.0000		0.7435	18.8849
1/32	0.0312	0.7937	21/64	0.3281	8.3344		0.7480	19.0000
	0.0394	1.0000	11/32	0.3437	8.7312	3/4	0.7500	19.0500
	0.0400	1.0160		0.3543	9.0000	49/64	0.7656	19.4469
3/64	0.0469	1.1906	23/64	0.3594	9.1281		0.7717	19.6012
	0.0472	1.2000	3/8	0.3750	9.5250	25/32	0.7812	19.8433
	0.0550	1.3970	25/64	0.3906	9.9213		0.7874	20.0000
	0.0591	1.5000		0.3937	10.0000	51/64	0.7969	20.2402
1/16	0.0625	1.5875	13/32	0.4062	10.3187	13/16	0.8125	20.6375
	0.0709	1.8000		0.4100	10.4140		0.8268	21.0000
5/64	0.0781	1.9844	27/64	0.4219	10.7156	53/64	0.8281	21.0344
	0.0787	2.0000		0.4250	10.7950	27/32	0.8437	21.4312
	0.0906	2.3012		0.4331	11.0000	55/64	0.8594	21.8281
3/32	0.0937	2.3812	7/16	0.4375	11.1125		0.8661	22.0000
	0.0984	2.5000	29/64	0.4531	11.5094	7/8	0.8750	22.2250
	0.1000	2.5400		0.4600	11.6840	57/64	0.8906	22.6219
	0.0124	2.6000	15/32	0.4687	11.9062		0.9055	23.0000
7/64	0.1094	2.7781		0.4724	12.0000	29/32	0.9062	23.0187
	0.1100	2.7940	31/64	0.4844	12.3031	59/64	0.9219	23.4156
	0.1102	2.8000	1/2	0.5000	12.7000	15/16	0.9375	23.8125
	0.1181	3.0000		0.5118	13.0000		0.9449	24.0000
1/8	0.1250	3.1750	33/64	0.5156	13.0968	61/64	0.9531	24.2094
	0.1256	3.1902	17/32	0.5312	13.4937	31/32	0.9687	24.6062
	0.1378	3.5000	35/64	0.5469	13.8906		0.9843	25.0000
9/64	0.1406	3.5719		0.5512	14.0000	63/64	0.9844	25.0031
5/32	0.1562	3.9687	9/16	0.5625	14.2875		1.0000	25.4000
	0.1575	4.0000	37/64	0.5781	14.6844		1.0236	26.0000
11/64	0.1719	4.3656		0.5906	15.0000		1.0415	26.4541
3/16	0.1875	4.7625	19/32	0.5937	15.0812		1.0480	26.6192
	0.1892	4.8057	39/64	0.6094	15.4781	1 1/16	1.0625	26.9875
	0.1969	5.0000	5/8	0.6250	15.8750		1.0630	27.0000
13/64	0.2031	5.1594		0.6299	16.0000		1.1025	28.0000
	0.2165	5.4991	41/64	0.6406	16.2719	1 1/8	1.1250	28.5750
7/32	0.2187	5.5562		0.6500	16.5100		1.1417	29.0000
15/64	0.2344	5.9531	21/32	0.6562	16.6687		1.1812	30.0000
	0.2362	6.0000		0.6620	16.8148	1 3/16	1.1875	30.1625
1/4	0.2500	6.3500		0.6693	17.0000	1 1/4	1.2500	31.7500
17/64	0.2656	6.7469	43/64	0.6719	17.0656	1 1/2	1.5000	38.1000
	0.2756	7.0000	11/16	0.6875	17.4625		1.5625	39.6880
9/32	0.2812	7.1437	45/64	0.7031	17.8594		1.5748	40.0000
	0.2883	7.3228		0.7087	18.0000		1.8504	47.0000
19/64	0.2969	7.5406	23/32	0.7187	18.2562		2.0000	50.8000

Temperature Conversion Table

The numbers in the center column refer to the temperatures either in Celsius or Fahrenheit which need conversion to the other scale. When converting from Fahrenheit to Celsius, the equivalent

temperature will be found to the left of the center column. If converting from Celsius to Fahrenheit, the answer will be found to the right.

Celsius to Fahrenheit Conversion Table

°C	°F/°C	°F	°C	°F/°C	°F	°C	°F/°C	°F	°C	°F/°C	°F
-79	-110	-166	37.8	100	212	204	400	752	371	700	1292
-73	-100	-148	43	110	230	210	410	770	377	710	1310
-68	-90	-130	49	120	248	216	420	788	382	720	1328
-62	-80	-112	54	130	266	221	430	806	388	730	1346
-57	-70	-94	60	140	284	227	440	824	393	740	1364
-51	-60	-76	66	150	302	232	450	842	399	750	1382
-46	-50	-58	71	160	320	238	460	860	404	760	1400
-40	-40	-40	77	170	338	243	470	878	410	770	1418
-34	-30	-22	82	180	356	249	480	896	416	780	1436
-29	-20	-4	88	190	374	254	490	914	421	790	1454
-23	-10	14	93	200	392	260	500	932	427	800	1472
-17.8	0	32	99	210	410	266	510	950	432	810	1490
-17.2	1	33.8	104	220	428	271	520	968	438	820	1508
-16.7	2	35.6	110	230	446	277	530	986	443	830	1526
-16.1	3	37.4	116	240	464	282	540	1004	449	840	1544
-15.6	4	39.2	121	250	482	288	550	1022	454	850	1562
-15.0	5	41.0	127	260	500	293	560	1040	460	860	1580
-14.4	6	42.8	132	270	518	299	570	1058	466	870	1598
-13.9	7	44.6	138	280	536	304	580	1076	471	880	1616
-13.3	8	46.4	143	290	554	310	590	1094	477	890	1634
-12.8	9	48.2	149	300	572	316	600	1112	482	900	1652
-12.2	10	50.5	154	310	590	321	610	1130	488	910	1670
-6.7	20	68	160	320	608	327	620	1148	493	920	1688
-1.1	30	86	166	330	626	332	630	1166	499	930	1706
4.4	40	104	171	340	644	338	640	1184	504	940	1724
10	50	122	177	350	662	343	650	1202	510	950	1742
15.6	60	140	182	360	680	349	660	1220	516	960	1760
21.1	70	158	188	370	698	354	670	1238	521	970	1778
26.7	80	176	193	380	716	360	680	1256	527	980	1796
32.2	90	194	199	390	734	366	690	1274	532	990	1814



72	NHBB Overview
73	Astro Division, Laconia, NH
74	HiTech Division, Peterborough, NH
75	myonic USA , Chatsworth, CA
76	Minebea Co., Ltd.

Committed to Excellence

We continue to build strong alliances within the aerospace, defense, dental, medical, and high technology markets, working across the enterprise to provide business solutions that keep pace with our customers' technological advances.

The precision tolerances required by the customers we support necessitate a complete commitment to quality. At NHBB, that commitment is apparent in everything we do, from an investment in advanced capabilities, to real-time quality control, to continuous improvement in both processes and people. Our commitment to manufacturing excellence is seen time and again in our high level of service and product quality.

Applications Engineering

Knowing how to leverage knowledge, industry experience, emerging technology, and industry trends is the true differentiator when it comes to customized bearing assemblies. At NHBB, we offer complete bearing engineering support for every phase of a product's life cycle, and we do this with a passion for serving as a valued technical resource to our customers.

Manufacturing

Investing in the most advanced technologies available gives NHBB a significant advantage in precision manufacturing. We're able to guarantee the close tolerances necessary in life-critical and high speed applications, as well as address manufacturing challenges in-house through new tools, precision gages, and state-of-the-art production processes.

Care for the Environment

At NHBB, our stringent environmental policy emphasizes pollution prevention, regulatory compliance, and continuous improvement aimed at reducing the impact of every phase of the manufacturing process. Our objectives also include the promotion of environmental awareness among employees and within our communities.

Astro designs and manufactures highly specialized custom bearings, next-up assemblies, and machined parts requiring significant engineering expertise and specialty materials. Our stringent process controls and advanced planning system enable us to satisfy unique production requirements and provide improved delivery scheduling as part of our continuous improvement culture and commitment to customer satisfaction.

PRODUCTS

- Rod ends
- Sphericals
- Link assemblies
- Bushings
- Loader slot bearings
- Custom-lined parts
- Bearings up to 22" O.D.
- Next-up assemblies & machined parts

NMB, KARUIZAWA, JAPAN*

- Rod ends
- Sphericals
- Spherical roller bearings
- Self-aligning roller bearings
- Next-up assemblies & machined parts

QUALITY CERTIFICATIONS

- ISO 9001:2008
- AS9100, Rev C
- Boeing D6-82479
- FAA FAR 21.303

NADCAP

- AC7102 – Heat-treating
- AC7108 – Chemical processing
- AC7114 – Nondestructive testing
- AC7118 – Composites/bonding

ENVIRONMENTAL MANAGEMENT CERTIFICATION

- ISO 14001:2004



*Astro is the North American sales representative for products manufactured by NMB's facility in Karuizawa, Japan, giving customers access to a global supply of high quality commercial aerospace parts.

HiTech specializes in customized and sophisticated bearing assemblies, cylindrical roller bearings, and large-diameter precision ball bearings. We have the ability to provide unique, custom bearing solutions to complex and demanding challenges, including high loads, extreme speeds, limited space, simplified assembly, and highly-efficient lubrication distribution, to name a few.

PRODUCTS

- Complex ball and roller bearings
- Bearing sizes through 300 mm O.D.
- Cylindrical roller bearings
- Ball bearings:
 - Angular contact
 - Gothic arch
 - Duplex/super duplex
 - Torque tube
 - Thin section

QUALITY CERTIFICATIONS

- ISO 9001:2008
- AS9100, Rev C
- Boeing D6-82479

NADCAP

- AC7102 – Heat-treating – including carburizing
- AC7108 – Chemical processing – including passivation
- AC7114 – Nondestructive testing

ENVIRONMENTAL MANAGEMENT CERTIFICATION

- ISO 14001:2004



myonic is a German manufacturer of precision miniature ball bearings acquired in 2009 by, Minebea Co., Ltd. and represented in the US solely by myonic USA. myonic's manufacturing facility specializes in the design and manufacture of highly-engineered mechanical subassemblies and miniature ball bearings for the dental, medical, aerospace and industrial markets.

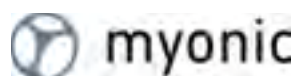

PRODUCTS

- Ultra precision miniature ball bearings
 - Deep groove radial
 - Angular contact
 - Full line of metric
- Thrust bearings
- X-ray tube bearings
- Aircraft instrument bearings
- Dental bearings
 - Integral shaft
 - Complete turbine assemblies
 - Laser welded shields
 - Hybrid ceramic
 - Spindles/auto chucks
- Shims and washers
- Customized bearing systems
- Contract manufactured products

QUALITY CERTIFICATION

- ISO 9001:2008

ENVIRONMENTAL MANAGEMENT CERTIFICATION

- ISO 14001:2004





The Minebea Group of Companies

New Hampshire Ball Bearings and myonic are an integral part of an international business, the Minebea Group of Companies. Minebea Co., Ltd. is the world's leading specialized manufacturer of miniature ball bearings and high precision components for the telecommunications, aerospace, automotive, and electrical appliance industries.

The Minebea Group is comprised of 43 subsidiaries in 17 countries, and employs over 50,000 people. In addition to its worldwide manufacturing capabilities, Minebea's vision is to lead the competition through manufacturing and technological excellence.





New Hampshire Ball Bearings, Inc.

— *A Minebea Company* —

**Precision Division and
Corporate Headquarters**

9700 Independence Avenue
Chatsworth, CA 91311

tel: 818.993.4100 fax: 818.407.5020

Astro Division

155 Lexington Drive
Laconia, NH 03246

tel: 603.524.0004 fax: 603.524.9025

HiTech Division

175 Jaffrey Road
Peterborough, NH 03458

tel: 603.924.4100 fax: 603.924.4419

myonic USA

9700 Independence Avenue
Chatsworth, CA 91311

tel: 818.701.4833 fax: 818.407.5020

NHBB Europe

Siemensstrasse 30
63225 Langen
Germany

tel: (49) 6103.913.341 fax: (49) 6103.913.342

www.nhbb.com