

KD®

Disc Couplings Size 023 through 905



Size 023 for Low HP Drive



**Non-Lubricated for
Simplified Maintenance**

**Higher Torque Ratings,
Similar to
Gear Couplings**

**Excellent Balance
Characteristics**

Index:

	Page
Technical Advantages	20
Selection Procedure	21
Disc Pack Descriptions	21
Service Factors	22
Dynamic Balancing Guide	23
Product Overview and Index	24 - 25
KD Slide Disc Coupling Comments	26 - 27
KD1 Close Coupled	28 - 29
KD10 Close Coupled	30 - 31
KD11 Close Coupled	32 - 33
KD2® Spacer Coupling	34 - 35
KD20 Spacer Coupling	36 - 37
KD21 Spacer Coupling	38 - 39
KD22 Spacer Coupling	40 - 41
KD33 Cooling Tower Coupling	42
KD4 Single Flex	43
KD41 & KD41T Floating Shafts	44 - 45
KD42 & KD42T Floating Shafts	46 - 47
KD42S Slide Floating Shafts	48 - 49
KD5 Single Flex	50 - 51
KD50 Spacer Coupling	52 - 53
KD51 & KD51T	54 - 55



Visit www.kopflex.com

KD® DISC Couplings

KD Series of flexible shaft couplings provides reliable transmission of mechanical power from driving to driven machine where a low-maintenance, non-lubricated coupling is required.

KD® Disc Couplings are specifically designed to accommodate general purpose drive system applications such as centrifugal pumps, compressors, generators, cooling towers, machine tools, printing and pulp and paper machines.

KD® Couplings transmit torque and provide for both angular and axial misalignment between shafts with a coupling comprised of shaft mounted hubs connected through flexible disc packs with spacer or sleeve assemblies.

All KD® Couplings use stainless steel discs as flexible members, providing high strength and good corrosion resistance. The streamline disk pack design results in the reaction load on equipment bearings being minimized. These disc pack couplings are inherently self-centering; additional provision for limited end float is not required.

Most disc packs are unitized and, along with self-locking nuts, they greatly reduce the number of loose parts, thus simplifying installation and replacement.

KD® Disc Couplings are now available in an expanded range of sizes and styles suitable for common installations. Or if you need something special, we can design a coupling to meet your specific requirements.



Visit www.kopflex.com

Selection Procedure

1. Coupling Style:

Select the appropriate KD® coupling style for your application from the Product Overview & Index.

2. Coupling Size:

Step 1: Determine the proper service factor from page 22.

Step 2: Calculate the required HP/100 RPM, using the HP rating of the drive and the coupling speed (RPM) as shown below:

$$\frac{\text{HP} \times \text{SERVICE FACTOR} \times 100}{\text{RPM}} = \text{HP/100 RPM}$$

Step 3: Select the coupling size having a rating sufficient to handle the required HP/100 RPM at the appropriate service factor.

Step 4: Verify that the maximum bore of the coupling selected is equal to or larger than either of the equipment shafts.

Step 5: Check the overall dimensions to ensure the coupling will not interfere with the coupling guard, piping, or the equipment housings and that it will fit the required shaft separation.

3. Check Balance Requirements

Consult the Dynamic Balancing Guide on page 23 to help determine if balancing is required. Verify that the maximum operating speed does not exceed the maximum speed rating of the coupling.

The maximum speed rating does not consider lateral critical speed considerations for floating shaft applications.

4. Specify Shaft Separation

Specify the required shaft separation using standard length, if possible. Verify the actual shaft separation for a replacement application.

Note: Care must be exercised in proper selection of any shaft coupling. The Users must assure themselves that the design of the shaft to coupling hub connection is adequate for the duty intended.



Disc Pack Data

- MT disc pack** [Medium Torque]
unitized, 3 bolt disc with “prestretch” bushings that get pressed into the flanges, uses standard fasteners.
KD1, 2
- HT disc pack** [High Torque]
unitized, 3, 4 or 5 bolt discs, thicker for high torque, body fit bolts.
KD11, 20, 21, 22, 4, 41, 42
- HS disc pack** [High Torque - Semi-unitized]
same as HT but semi-unitized so that the disc packs may be installed out between close-coupled hubs.
KD10
- CT disc pack** [Cooling Tower]
unitized, 3 bolt disc for cooling tower couplings, stainless steel components with body-fit bolts.
KD33
- HM disc pack** [High Torque - Marine]
same as HT but with coated discs, for marine applications - DNV approved.
- LT disc pack** [Low Torque - Light Duty]
non-unitized, most economical, body fit bolts.
KD5, 50, 51



Values listed are intended only as a general guide, and are typical of usual service requirements. For systems which frequently utilize the peak torque capability of the power source, verify that the magnitude of this peak torque does not exceed the 1.0 Service Factor Rating of the coupling selected. Applications which involve extreme repetitive shock or high-energy load absorption characteristics should be referred — with full particulars — to KOP-FLEX.

Values contained in the table are to be applied to smooth power sources such as electric motors and steam turbines. For drives involving internal combustion engines of four or five cylinders, add 1.0 to the values listed; for six or more cylinders, add 0.5 to the values listed. For systems utilizing AC or DC Mill Motors as the prime mover, refer to Note (1).

CAUTION All people moving applications must be referred to engineering.

Application	Typical Service Factor
AGITATORS	
Pure Liquids	1.0
Liquids & Solids	1.25
Liquids — Variable Density	1.25
BLOWERS	
Centrifugal	1.0
Lobe	1.5
Vane	1.25
BRIQUETTE MACHINES	2.0
CAR PULLERS — Intermittent Duty	1.5
COMPRESSORS	
Centrifugal	1.0
Centriaxial	1.25
Lobe	1.5
Reciprocating — Multi-Cylinder	2.0
CONVEYORS — LIGHT DUTY UNIFORMLY FED	
Apron, Bucket, Chain, Flight, Screw	1.25
Assembly, Belt	1.0
Oven	1.5
CONVEYORS — HEAVY DUTY NOT UNIFORMLY FED	
Apron, Bucket, Chain, Flight, Oven	1.5
Assembly, Belt	1.25
Reciprocating, Shaker	2.5
CRANES AND HOISTS (NOTE 1 and 2)	
Main hoists, Reversing	2.5
Skip Hoists, Trolley & Bridge Drives	2.0
Slope	2.0
CRUSHERS	
Ore, Stone	3.0
DREDGES	
Cable Reels	1.75
Conveyors	1.5
Cutter Head Jig Drives	2.5
Maneuvering Winches	1.75
Pumps	1.75
Screen Drives	1.75
Stackers	1.75
Utility Winches	1.5
ELEVATORS (NOTE 2)	
Bucket	1.75
Centrifugal & Gravity Discharge	1.5
Escalators	1.5
Freight	2.5
FANS	
Centrifugal	1.0
Cooling Towers	1.5
Forced Draft	1.5
Induced Draft without Damper Control	2.0
FEEDERS	
Apron, Belt, Disc, Screw	1.25
Reciprocating	2.5

Application	Typical Service Factor
GENERATORS — (Not Welding)	1.0
HAMMER MILLS	2.0
LAUNDRY WASHERS — Reversing	2.0
LAUNDRY TUMBLERS	2.0
LINE SHAFT	1.5
LUMBER INDUSTRY	
Barkers — Drum Type	2.0
Edger Feed	2.0
Live Rolls	2.0
Log Haul — Incline	2.0
Log Haul — Well type	2.0
Off Bearing Rolls	2.0
Planer Feed Chains	1.75
Planer Floor Chains	1.75
Planer Tilting Hoist	1.75
Slab Conveyor	1.5
Sorting Table	1.5
Trimmer Feed	1.75
MARINE PROPULSION	
Main Drives	2.0
MACHINE TOOLS	
Bending Roll	2.0
Plate Planer	1.5
Punch Press — Gear Driven	2.0
Tapping Machines	2.5
Other Machine Tools	
Main Drives	1.5
Auxiliary Drives	1.25
METAL MILLS	
Draw Bench — Carriage	2.0
Draw Bench — Main Drive	2.0
Forming Machines	2.0
Slitters	1.5
Table Conveyors	
Non-Reversing	2.25
Reversing	2.5
Wire Drawing & Flattening Machine	2.0
Wire Winding Machine	1.75
METAL ROLLING MILLS (NOTE 1)	
Blooming Mills	*
Coilers, hot mill	2.0
Coilers, cold mill	1.25
Cold Mills	2.0
Cooling Beds	1.75
Door Openers	2.0
Draw Benches	2.0
Edger Drives	1.75
Feed Rolls, Reversing Mills	3.5
Furnace Pushers	2.5
Hot Mills	3.0
Ingot Cars	2.5
Kick-outs	2.5
Manipulators	3.0
Merchant Mills	3.0
Piercers	3.0
Pusher Rams	2.5
Reel Drives	1.75
Reel Drums	2.0
Reelers	3.0
Rod and Bar Mills	1.5
Roughing Mill Delivery Table	3.0
Runout Tables	
Reversing	3.0
Non-Reversing	2.0
Saws, hot & cold	2.5
Screwdown Drives	3.0
Skelp Mills	3.0
Slitters	3.0
Slabbing Mills	3.0
Soaking Pit Cover Drives	3.0
Straighteners	2.5
Tables, transfer & runout	2.0
Thrust Block	3.0
Traction Drive	3.0
Tube Conveyor Rolls	2.5
Unscramblers	2.5
Wire Drawing	1.5
MILLS, ROTARY TYPE	
Ball	2.25
Dryers & Coolers	2.0
Hammer	1.75
Kilns	2.0

Application	Typical Service Factor
Pebble & Rod	2.0
Pug	1.75
Tumbling Barrels	2.0
MIXERS	
Concrete Mixers	1.75
Drum Type	1.5
OIL INDUSTRY	
Chillers	1.25
Paraffin Filter Press	1.75
PAPER MILLS	
Barker Auxiliaries, Hydraulic	2.0
Barker, Mechanical	2.0
Barking Drum Spur Gear Only	2.25
Beater & Pulper	1.75
Bleacher	1.0
Calenders	2.0
Chippers	2.5
Coaters	1.0
Converting Machines, except Cutters, Platers	1.5
Couch Roll	1.75
Cutters, Platers	2.0
Cylinders	1.75
Disc Refiners	1.75
Dryers	1.75
Felt Stretcher	1.25
Felt Whipper	2.0
Jordans	1.75
Line Shaft	1.5
Log Haul	2.0
Pulp Grinder	1.75
Press Roll	2.0
Reel	1.5
Stock Chests	1.5
Suction Roll	1.75
Washers & Thickeners	1.5
Winders	1.5
PRINTING PRESSES	1.5
PULLERS — Barge Haul	2.0
PUMPS	
Centrifugal	1.0
Boiler Feed	1.5
Reciprocating	
Single Acting	
1 or 2 Cylinders	2.25
3 or more Cylinders	1.75
Double Acting	2.0
Rotary, Gear, Lobe, Vane	1.5
RUBBER INDUSTRY	
Mixer — Banbury	2.5
Rubber Calendar	2.0
Rubber Mill (2 or more)	2.25
Sheeter	2.0
Tire Building Machines	2.5
Tire & Tube Press Openers	1.0
Tubers & Strainers	2.0
SCREENS	
Air Washing	1.0
Grizzly	2.0
Rotary — Stone or Gravel	1.5
Traveling Water Intake	1.25
Vibrating	2.5
SEWAGE DISPOSAL EQUIPMENT	
Bar Screens	1.25
Chemical Feeders	1.25
Collectors, Circuline or Straightline	1.25
Dewatering Screens	1.25
Grit Collectors	1.25
Scum Breakers	1.25
Slow or Rapid Mixers	1.25
Sludge Collectors	1.25
Thickeners	1.25
Vacuum Filters	1.25
STEERING GEAR	1.0
STOKERS	1.0
WINCH	1.5
WINDLASS	1.75

* Refer to KOP-FLEX

NOTES

- (1) Maximum Torque at the coupling must not exceed Rated Torque of the coupling.
- (2) Check local and industrial safety codes.

Balancing requirements for a coupling are dependent on factors determined by the characteristics of the connected equipment. For this reason, the Balancing Charts should be used as a GUIDE ONLY to assist in determining whether or not balancing is required.

The Balancing Charts shown are based on AGMA 9000-C90 suggested balance classes for systems with "Average" sensitivity to unbalance. For systems with higher sensitivity to unbalance, balancing of the coupling may be required at lower speeds. For systems which are less sensitive to unbalance, couplings may be able to operate at higher speeds than those shown at lower balance levels. Therefore, in the absence of either a thorough system analysis or past user experience with a similar installation, these charts should be used as a GUIDE ONLY.

KD® Couplings are available in several styles to meet the balance requirements of API 610, including the 8th Edition. Consult KOP-FLEX for details.

KD1 and KD10 couplings meet AGMA Class 8 balance levels as-manufactured (off-the-shelf) and may be component balanced to run at higher speeds. Refer to the ratings table for the maximum operating speeds for non-balanced and balanced couplings.

KD11 couplings are designed for higher speeds and meet AGMA Class 9 balance as-manufactured. KD11 couplings may be component balanced to meet Class 10 balance, and may be assembly balanced to Class 11.

KD2®, KD20, and KD21 couplings meet AGMA Class 9 balance levels as-manufactured and may be component balanced to meet Class 10 balance. KD2® and KD20 couplings may be assembly balanced to meet AGMA Class 11 balance. KD21 couplings are not assembly balanced. Refer to the charts on this page for balancing recommendations.

Balancing of sizes larger than 604 must be considered on a case-by-case basis. Consult KOP-FLEX for assistance.

For KD4, KD41 and KD42, and KD22 couplings, balance considerations should be reviewed on a case-by-case basis. Consult Engineering for assistance. KD5, 50 and 51 couplings are not balanced.

KD21 Balancing Chart for up to 18" Shaft Separation

Based on AGMA 9000-C90 for Average System Sensitivity

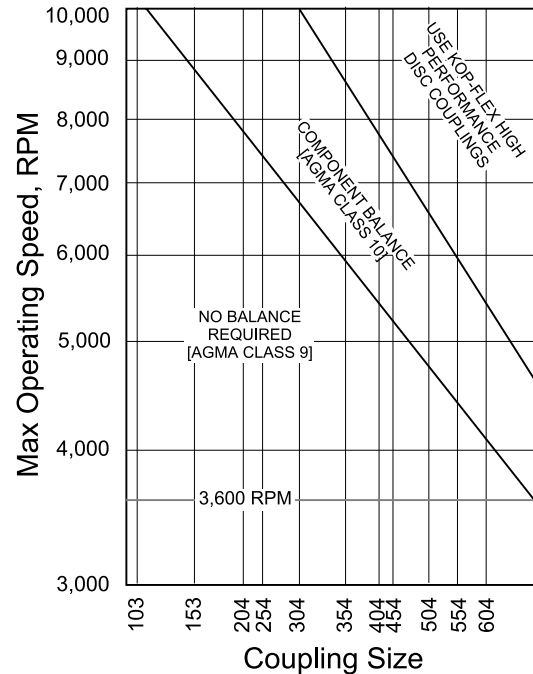

KD2 & KD20 Balancing Chart for up to 18" Shaft Separation

Based on AGMA 9000-C90 for Average System Sensitivity

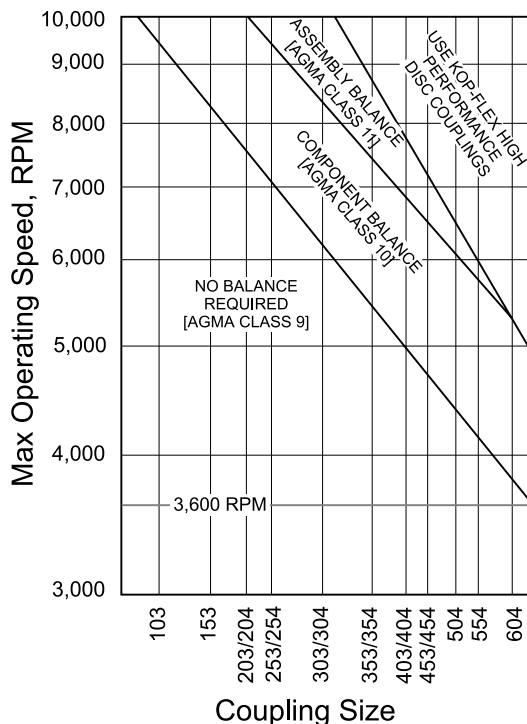

KD11 Balancing Chart

Based on AGMA 9000-C90 for Average System Sensitivity

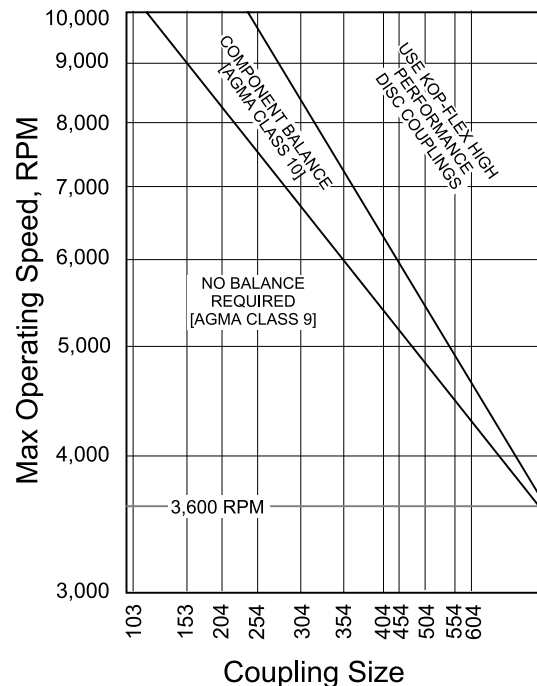

CLOSE COUPLED

KD1 with MT Disc Packs

Size Range 103 to 453
Bore Range .50 - 5.50"
Overview Unitized Disc Pack replaced without moving connected machines
 Medium Duty Applications

Page
28, 29

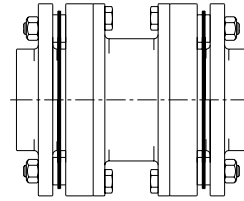

KD1 & KD10

KD10 with HS Disc Packs

Size Range 103 to 905
Bore Range .50 - 11.50"
Overview Unitized Disc Pack replaced without moving connected machines
 Heavy Duty Applications
 Ratings Similar to Gear Couplings

Page
30, 31

KD11 with HT Disc Packs

Size Range 103 to 905
Bore Range .50 - 11.50"
Overview Unitized Disc Pack
 Heavy Duty Applications
 Ratings Similar to Gear Couplings

Page
32, 33

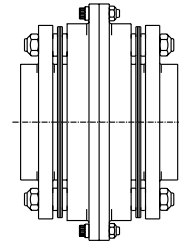

KD11

SPACER STYLES

KD2® with MT Disc Packs

Size Range 023 to 453
Bore Range .50 - 7.25"
Overview "Drop-Out" Spacer Design
 Factory Assembled Center Flex Section
 Medium Duty Applications

Page
34, 35

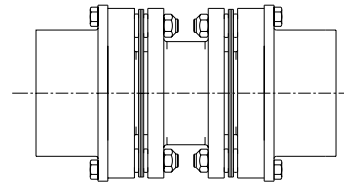

KD2® & KD20

KD20 with HT Disc Packs

Size Range 204 to 905
Bore Range 1.00 - 13.50"
Overview "Drop-Out" Spacer Design
 Factory Assembled Center Flex Section
 High Torque Applications

Page
36, 37

KD21 with HT Disc Packs

Size Range 053 to 905
Bore Range .50 - 13.50"
Overview Simple 3 Piece Spacer Design
 Unitized "Drop-Out" Disc Pack
 High Torque Applications

Page
38, 39

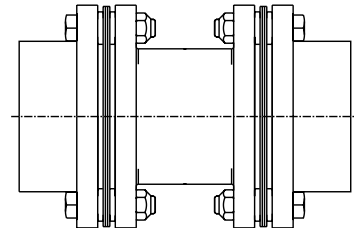

KD21

KD22 with HT Disc Packs

Size Range 103 to 905
Bore Range .50 - 11.50"
Overview Unitized Disc Pack on Shaft Hub
 Heavy Duty Applications
 Ratings Similar to Gear Couplings

Page
40, 41

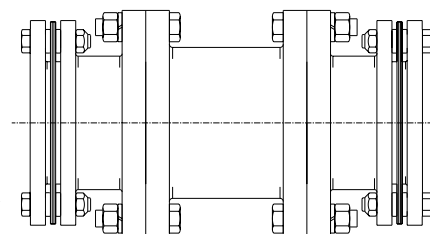

KD22



Visit www.kopflex.com

COOLING TOWER

Page
42

KD33 with CT Disc Packs

- Size Range** 153 to 303
- Bore Range** .50 - 4.50"
- Overview** Cooling Towers with Very Long Shaft Separation
Stainless Steel/Composite Tubes
Replaces most competitive Cooling Tower
Couplings
Non-lubricated

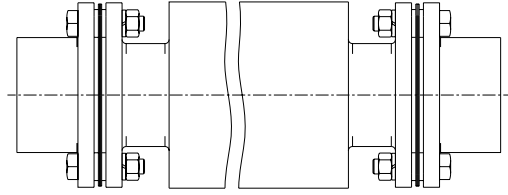

KD33

SINGLE FLEX & FLOATING SHAFTS

KD4 with HT Disc Packs

- Size Range** 103 to 905
- Bore Range** .50 - 13.50"
- Overview** Single Flex
Unitized "Drop-Out" Disc Pack
Heavy Duty Applications

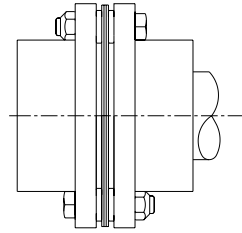

KD4

43

KD41 with HT Disc Packs

- Size Range** 103 to 905
- Bore Range** .50 - 13.50"
- Overview** Floating Shaft Design
Unitized "Drop-Out" Disc Pack
Heavy Duty Applications

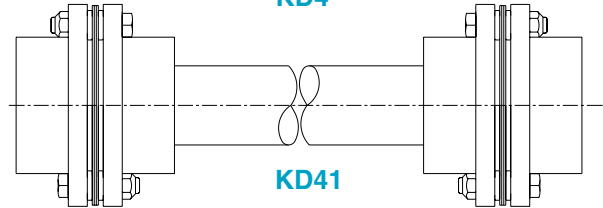

KD41

44 - 45

KD42 with HT Disc Packs

- Size Range** 103 to 905
- Bore Range** .50 - 11.50" Flex Half
- Overview** Floating Shaft Design
Bolts Directly to Gear Coupling Rigid
Unitized Disc Pack
Heavy Duty Applications
Ratings Similar to Gear Couplings

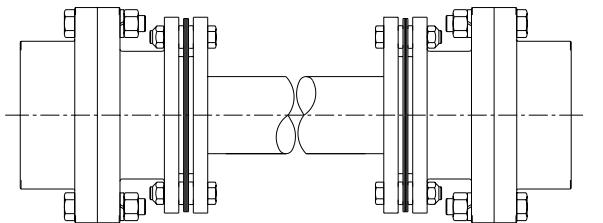

KD42

46 - 49

LIGHT DUTY

KD5, KD50, KD51 with LT Disc Packs

- Size Range** 022 to 362
- Bore Range** .25 - 4.75"
- Overview** Lighter Duty Applications

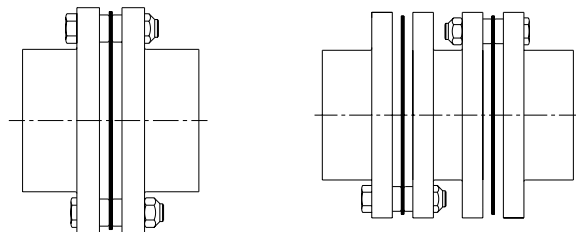

KD5 Single Flex

KD50 Spacer Style

50 - 55

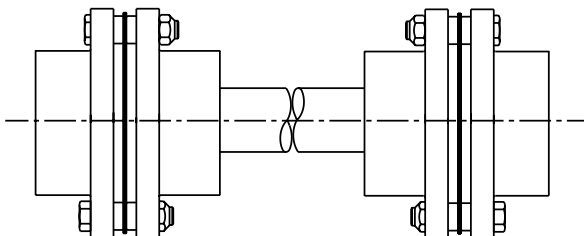

KD51 Floating Shaft

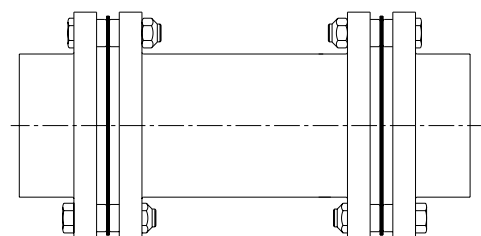

KD51T Tubular Floating Shaft

Our Slide Disc Couplings combine the best of two different worlds – the maintenance-free reliability of a disc coupling and the versatile slide feature of a low-maintenance sliding spline.

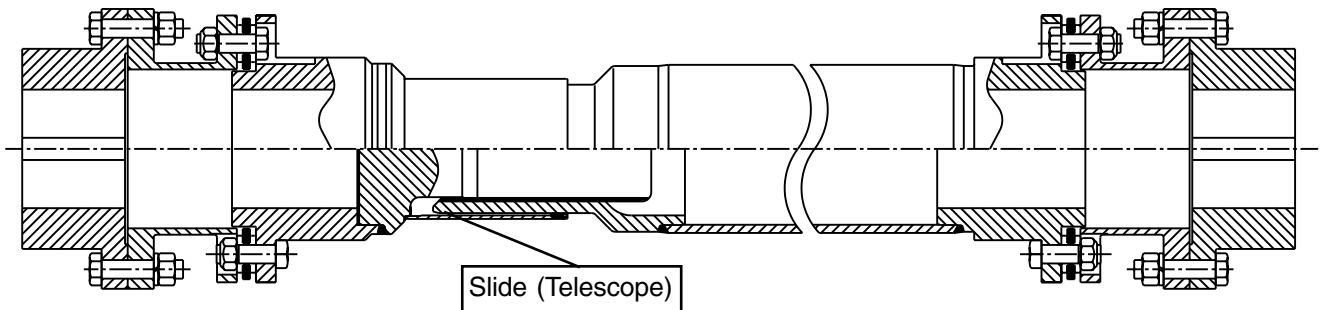

For many years, people have been replacing their gear couplings with maintenance-free disc couplings in order to eliminate costly lubrication, maintenance and eventual replacement of their worn out gear couplings. But disc couplings have an inherent limitation that has kept them out of many applications where once only gear couplings would do the job – the disc packs themselves are not tolerant of significant axial movement. In these applications, the conventional thinking was that a slide gear coupling was the only solution.

We offer a solution that combines the best features of disc couplings and slide couplings:

- KD® disc packs are supplied as unitized assemblies with stainless steel discs, which makes them easier to assemble and nearly maintenance-free. Disc packs available, from stock, as an option, with KOPLON* coating for corrosive environments.
- Standard spline sections are sealed and lubricated at the factory. The splines are provided with minimal backlash and coated with a special polymer for long life, minimal maintenance and low coefficient of friction (reduced sliding force).
- Special slide sections can be supplied to accommodate special long slide applications.

Keep in mind that the advantages that KD® Slide Disc couplings offer over gear couplings:

- Disc Couplings require no maintenance, and the spline sections are lubricated at the factory and do not need to be greased on a regular basis. **Operating costs are greatly reduced compared to gear couplings!**
- Disc Couplings have near zero backlash and standard spline sections are coated for minimal backlash, while gear couplings rely on clearances in the gearing for misalignment, therefore coupling balance and smooth transmission of power is greatly improved over gear couplings. This is important where backlash and vibration can affect the quality of the product being produced.



Visit www.kopflex.com

*KOPLON is a trademark of E. I. du Pont de Nemours and Company.

This trade name, trademark and/or registered trademark is used herein for product comparison purposes only, is the property of its respective owner and is not owned or controlled by Emerson Power Transmission Corporation (EPT). EPT does not represent or warrant the accuracy of this document.

Typical Applications:

- Paper Mill Roll Drives – the variable length feature compensates for different shaft separations. Typically, paper mills will have several couplings of the same size, but slightly different shaft separations. **One KD® Slide coupling covers several different shaft separations – eliminating the need for multiple spares.**

- Pulp Refiners – replaces slide gear couplings used to compensate for changing shaft separation as the refiner wears.

- Polymer Pelletizer – the design shown replaced a slide gear coupling used to compensate for changing shaft separation as the pelletizer blades wear.

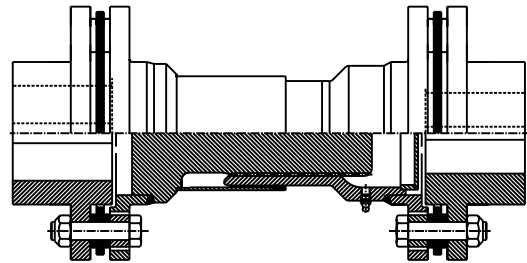

- Fan Application (in tunnels) – shown here, a combination MAX-C® resilient coupling and KD® Disc Coupling with a spline section is used to compensate for changes in shaft separation due to thermal growth.

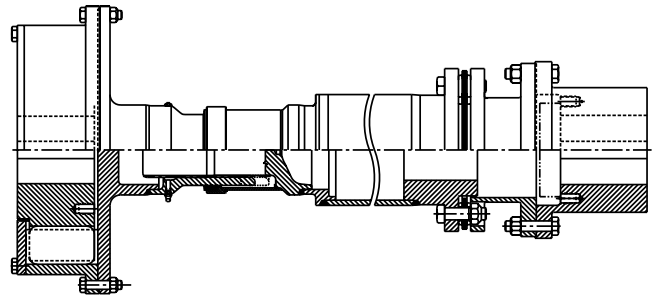

- Test Stand Application – shown is a special KD® coupling designed for a high speed test stand to accommodate tests of different equipment, requiring different shaft separations.

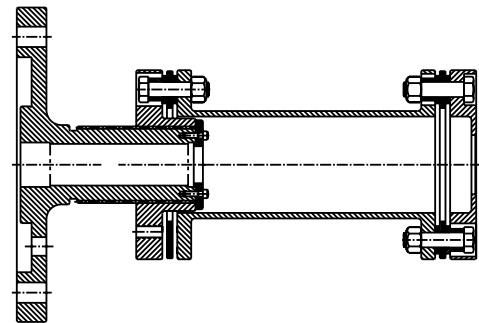

This is merely a sampling of the different types of applications where disc couplings are being adapted to meet the slide requirements once thought to be addressed solely by gear couplings.

The KD1 coupling is designed for close coupled applications with minimal to short distance between shaft ends and light to medium loading. It can directly replace most REX/THOMAS* DBZ couplings and the unitized disc pack design makes the installation simpler and easier.

The KD1 is comprised of two hubs, two rings, two disc packs, and a piloted split spacer. The standard coupling hubs may be installed in any of three mounting positions for design and installation flexibility. The split spacer pilot gives the KD1 coupling improved dynamic balance characteristics and contains a design feature to hold the split spacer in place while the coupling is rotating.

KD1 disc packs are unitized to greatly reduce the number of loose parts. The split spacer simply drops away from the hubs for faster installation and replacement without moving connected machinery. The standard coupling balance meets AGMA Class 8 as manufactured, dynamic balance to AGMA Class 9 and conformance to API 610 are available options.

For higher power requirements, consider a KD10 disc coupling. For higher speeds, consider a KD11 disc coupling.



- Medium Duty
- Minimal to Short Shaft Separations
- Split Spacer with Safety Pilot
- Replacement for REX/THOMAS* DBZ
- Drop-Out, Unitized Disc Packs

KD1 Couplings use MT Disc Packs.

Complete Couplings

Coupling Size	Complete Coupling with 2 Std. Hubs		Complete Coupling with 1 Std. Hub and 1 Long Hub		Complete Coupling with 2 Long Hubs	
	Rough Bore	Finish Bore ^①	Rough Bore	Finish Bore ^①	Rough Bore	Finish Bore ^①
103	103 KD 1 SS	103 KD 1 SS FB	103 KD 1 SL	103 KD 1 SL FB	103 KD 1 LL	103 KD 1 LL FB
153	153 KD 1 SS	153 KD 1 SS FB	153 KD 1 SL	153 KD 1 SL FB	153 KD 1 LL	153 KD 1 LL FB
203	203 KD 1 SS	203 KD 1 SS FB	203 KD 1 SL	203 KD 1 SL FB	203 KD 1 LL	203 KD 1 LL FB
253	253 KD 1 SS	253 KD 1 SS FB	253 KD 1 SL	253 KD 1 SL FB	253 KD 1 LL	253 KD 1 LL FB
303	303 KD 1 SS	303 KD 1 SS FB	303 KD 1 SL	303 KD 1 SL FB	303 KD 1 LL	303 KD 1 LL FB
353	353 KD 1 SS	353 KD 1 SS FB	353 KD 1 SL	353 KD 1 SL FB	353 KD 1 LL	353 KD 1 LL FB
403	403 KD 1 SS	403 KD 1 SS FB	403 KD 1 SL	403 KD 1 SL FB	403 KD 1 LL	403 KD 1 LL FB
453	453 KD 1 SS	453 KD 1 SS FB	453 KD 1 SL	453 KD 1 SL FB	453 KD 1 LL	453 KD 1 LL FB

① All finish bores and keyways per AGMA 9002-A86 commercial standard tolerances.

Component Parts

Description	Part Number
Standard Hub	SHUB
Long Hub	LHUB
*Center Assembly	CA
**MT Disc Pack Assembly	MTDP
**MT Disc Pack Fastener Set	MTFS
**Flange Fastener Set	FFSMT

* Center Assembly includes (2) disc packs, (2) disc pack fastener sets.

** For Disc Packs and Fastener Sets, do not include "Series" number in the part number.

*REX/THOMAS is a trademark of Rexnord Industries Inc.

This trade name, trademark and/or registered trademark is used herein for product comparison purposes only, is the property of its respective owner and is not owned or controlled by Emerson Power Transmission Corporation (EPT). EPT does not represent or warrant the accuracy of this document.

How to Order Components

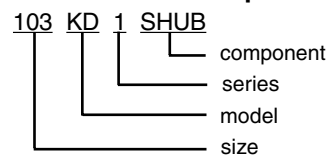

How to Order Disc Packs and Fastener Sets

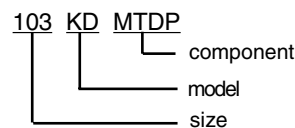

Selection Data

Size	Max. Bore (in)	Coupling Rating (HP/100 RPM)	Torque Rating		Maximum Speed Not Balanced (RPM)	Maximum Speed Balanced (RPM)	Total ^① Weight (lbs)	Total ^① WR ² (lb-in ²)	Axial Capacity (in)
			Continuous (in-lb)	Peak (in-lb)					
103	1.62	4.3	2710	5420	5400	9700	8.1	18.6	±.060
153	2.25	12.5	7880	15760	4500	7500	19.8	83.9	±.075
203	2.75	22.9	14400	28800	4100	6700	31.9	184	±.090
253	3.25	37.5	23600	47200	3600	5600	51.6	417	±.105
303	3.88	60.0	37800	75600	3200	5100	77.3	856	±.125
353	4.38	100	63000	126000	2900	4400	129	1940	±.150
403	5.00	155	97700	195000	2600	4000	189	3720	±.175
453	5.50	205	129000	258000	2400	3800	223	5170	±.200

① Data based on maximum bores.

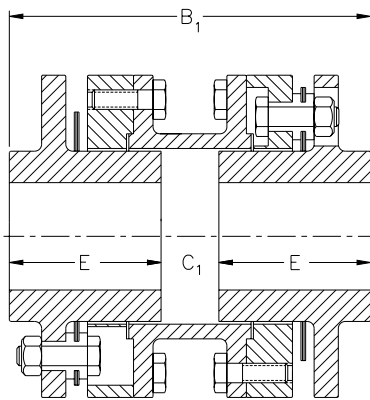

STANDARD HUBS

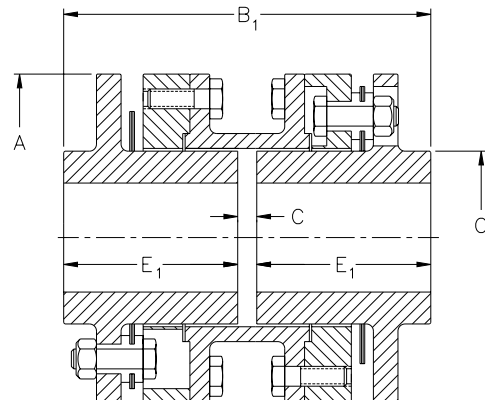

LONG HUBS

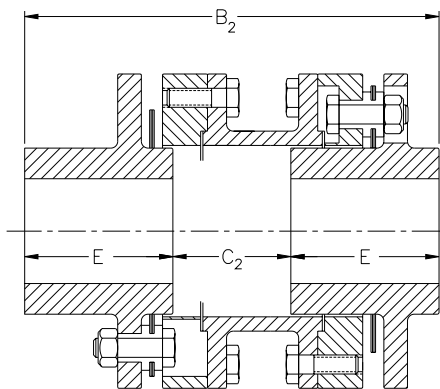

ONE HUB REVERSED

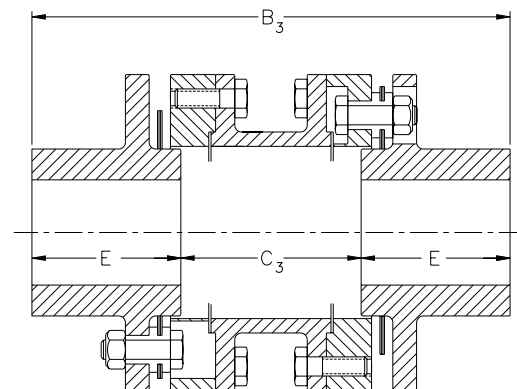

TWO HUBS REVERSED

Dimensional Data

Size	Rough Bore	A (in)	B ₁ (in)	B ₂ (in)	B ₃ (in)	C (in)	C ₁ (in)	C ₂ (in)	C ₃ (in)	E (in)	E ₁ (in)	O (in)
103	.50	4.12	4.94	5.69	6.44	.12	.94	1.69	2.44	2.00	2.41	2.19
153	.50	5.50	6.44	7.75	9.06	.12	1.19	2.50	3.81	2.62	3.16	3.00
203	.75	6.50	7.31	8.81	10.31	.19	1.31	2.81	4.31	3.00	3.56	3.75
253	1.00	7.75	8.38	10.06	11.75	.19	1.50	3.19	4.88	3.44	4.09	4.50
303	1.00	9.00	9.88	11.94	14.00	.25	1.75	3.81	5.88	4.06	4.81	5.25
353	1.00	10.50	11.19	13.56	15.94	.25	1.94	4.31	6.69	4.62	5.47	6.00
403	1.00	12.00	12.62	15.19	17.75	.31	2.12	4.69	7.25	5.25	6.16	6.75
453	1.50	13.00	13.12	15.69	18.25	.31	2.12	4.69	7.25	5.50	6.41	7.50

The KD10 coupling is designed to work in place of standard close coupled gear coupling applications with minimal distance between shaft ends. The power capacity of the KD10 coupling is the highest in the industry, allowing the easiest conversion from a lubricated coupling to a low maintenance disc coupling.

The KD10 is comprised of two hubs, two rings, two disc packs, and a piloted split spacer. The standard coupling hubs may be installed in two mounting positions for design and installation flexibility. The split spacer pilot gives the KD10 coupling improved dynamic balance characteristics and contains a design feature to hold the split spacer in place while the coupling is rotating.

KD10 disc packs are semi-unitized to greatly reduce the number of loose parts. The split spacer simply drops away from the hubs for faster installation and replacement of the disc packs without moving connected machinery. The standard coupling balance meets AGMA Class 8 as manufactured, dynamic balance to AGMA Class 9 and conformance to API 610 are available options.

For higher speed requirements, consider a KD11 disc coupling.

KD10 couplings use HS Semi-Unitized Disc Packs, for easy replacement without moving connected equipment.



- Heavy Duty, Highest Power Capacity
- Minimal Shaft Separations
- Split Spacer with Safety Pilot
- Replacement for Standard Gear Couplings
- Drop-Out, Semi-Unitized Disc Packs

Complete Couplings

Coupling Size	Complete Coupling with 2 Std. Hubs	
	Rough Bore	Finish Bore ^①
103	103 KD 10 SS	103 KD 10 SS FB
153	153 KD 10 SS	153 KD 10 SS FB
204	204 KD 10 SS	204 KD 10 SS FB
254	254 KD 10 SS	254 KD 10 SS FB
304	304 KD 10 SS	304 KD 10 SS FB
354	354 KD 10 SS	354 KD 10 SS FB
404	404 KD 10 SS	404 KD 10 SS FB
454	454 KD 10 SS	454 KD 10 SS FB
504	504 KD 10 SS	504 KD 10 SS FB
554	554 KD 10 SS	554 KD 10 SS FB
604	604 KD 10 SS	604 KD 10 SS FB
705	705 KD 10 SS	705 KD 10 SS FB
805	805 KD 10 SS	805 KD 10 SS FB
905	905 KD 10 SS	905 KD 10 SS FB

^① All finish bores and keyways per AGMA 9002-A86 commercial standard tolerances.

Component Parts

Description	Part Number
Standard Hub	SHUB
*Center Assembly	CA
**HS Disc Pack Assembly	HSDP
**HS Disc Pack Fastener Set	HSFS
**Flange Fastener Set	FFSHT

* Center Assembly includes (2) disc packs, (2) disc pack fastener sets.
 ** For Disc Packs and Fastener Sets, do not include "Series" number in the part number.

Note: Complete couplings are supplied with HT Disc Packs (HTDP) for ease of initial installation. HS Disc Packs (HSDP) should be used for replacement without moving connected equipment.

How to Order Components

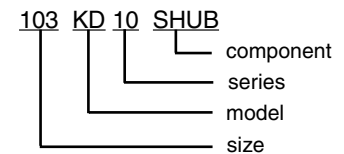

How to Order Disc Packs & Fastener Sets

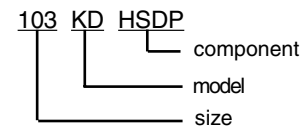

Visit www.kopflex.com

Selection Data

Size	Max. Bore (in)	Coupling Rating (HP/100 RPM)	Torque Rating		Max. Speed Not Balanced (RPM)	Maximum Speed Balanced (RPM)	Total ^① Weight (lbs)	Total ^① WR ² (lb-in ²)	Axial Capacity (in)
			Continuous (in-lb)	Peak (in-lb)					
103	1.50	6.3	4000	8000	5400	9700	6.9	16	±.080
153	2.12	21.6	13600	27200	4500	7500	17.5	73	±.140
204	2.62	57.1	36000	72000	4100	6700	27.2	148	±.110
254	3.25	82.5	52000	104000	3600	5600	47.2	400	±.140
304	3.75	141	89000	178000	3200	5100	78.0	916	±.170
354	4.25	238	145000	290000	2900	4400	134	2140	±.200
404	4.75	340	215000	430000	2600	4000	193	3850	±.225
454	5.50	405	255000	510000	2400	3800	229	5540	±.250
504	5.75	570	360000	720000	2200	3500	316	8640	±.275
554	6.25	800	505000	1010000	1900	3000	404	13100	±.300
604	6.75	1050	660000	1320000	1850	2900	559	22200	±.320
705	8.50	2400	1510000	3020000	1800	2800	925	56400	±.270
805	9.50	3670	2100000	4200000	1600	2500	1340	102000	±.310
905	11.50	4130	2300000	4600000	1500	2300	1700	163000	±.400

① Data based on maximum bores.

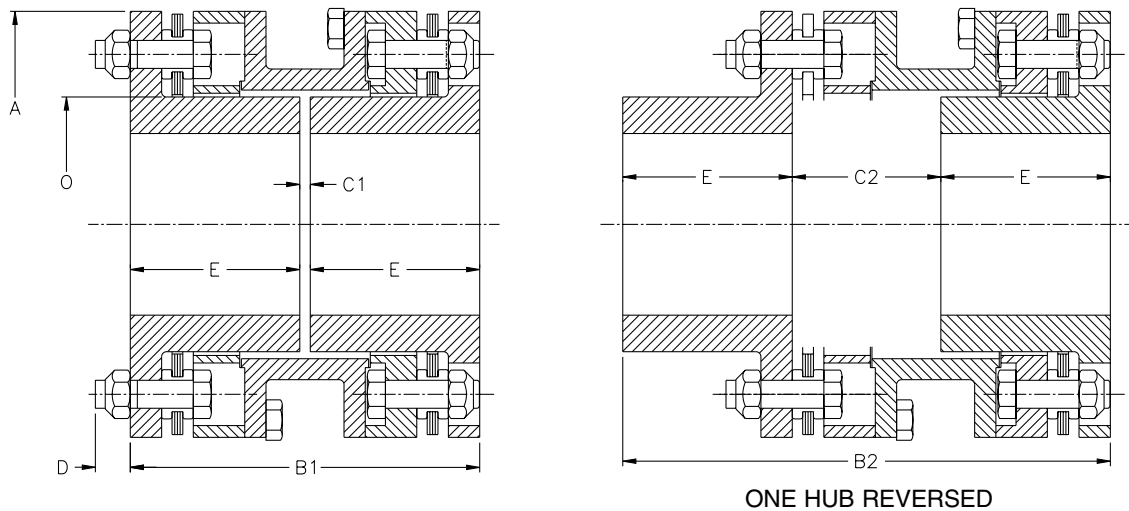

Dimensional Data

Size	A (in)	B1 (in)	B2 (in)	C1 (in)	C2 (in)	D (in)	E (in)	O (in)
103	3.94	3.50	4.94	.125	1.56	.38	1.69	2.10
153	5.38	4.38	6.15	.125	1.90	.52	2.12	2.96
204	6.38	5.62	7.90	.125	2.40	.60	2.75	3.64
254	7.62	6.25	8.72	.175	2.66	.60	3.03	4.56
304	9.00	7.38	10.30	.175	3.11	.74	3.59	5.25
354	10.50	9.00	12.57	.250	3.82	.87	4.38	5.91
404	11.75	10.62	14.81	.250	4.44	1.00	5.19	6.75
454	12.75	10.94	15.32	.3125	4.70	1.00	5.31	7.62
504	13.88	12.38	17.35	.3125	5.28	1.14	6.03	8.19
554	15.12	14.12	19.83	.3125	6.02	1.29	6.91	8.75
604	16.50	15.12	21.21	.3125	6.40	1.38	7.41	9.31
705	20.50	17.75	24.87	.375	7.50	1.65	8.69	11.34
805	23.00	20.00	28.00	.375	8.37	1.94	9.81	12.75
905	25.50	22.25	31.24	.500	9.50	1.94	10.88	15.25

The KD11 coupling is designed to work in place of standard close coupled gear coupling applications with higher speed service. The power capacity of the KD11 coupling is the highest in the industry, allowing the easiest conversion from a lubricated coupling to a low maintenance disc coupling.

The KD11 is comprised of two hubs, two adapters, and two disc packs. The standard coupling hubs may be installed in any of three mounting positions for design and installation flexibility. The bolted adapters give the KD11 coupling the best dynamic balance characteristics and allow the connected equipment to be installed or removed while keeping each assembled half coupling undisturbed.

KD11 disc packs are unitized to greatly reduce the number of loose parts. The standard coupling balance meets AGMA Class 9 as manufactured, dynamic balance to AGMA Class 10 and 11, and conformance to API 610 are available options. The close tolerance bolts and safety overload washers provide superior performance.

For lower speed requirements, consider a KD10 disc coupling. For medium-duty, consider a KD1 disc coupling.

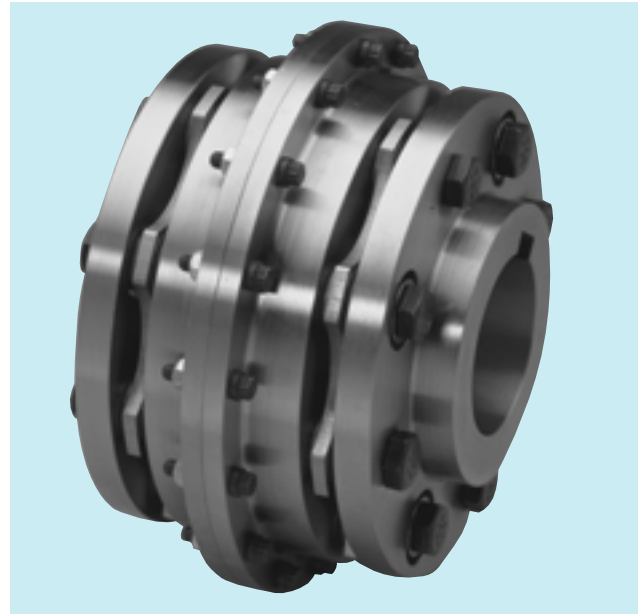

- Heavy Duty, Highest Power Capacity
- Minimal Shaft Separations
- Bolted Adapters for Higher Speeds
- Replacement for Standard Gear Couplings
- Unitized Disc Packs

KD11 couplings use HT Disc Packs.

Complete Couplings

Coupling Size	Complete Coupling with 2 Std. Hubs	
	Rough Bore	Finish Bore ^①
103	103 KD 11 SS	103 KD 11 SS FB
153	153 KD 11 SS	153 KD 11 SS FB
204	204 KD 11 SS	204 KD 11 SS FB
254	254 KD 11 SS	254 KD 11 SS FB
304	304 KD 11 SS	304 KD 11 SS FB
354	354 KD 11 SS	354 KD 11 SS FB
404	404 KD 11 SS	404 KD 11 SS FB
454	454 KD 11 SS	454 KD 11 SS FB
504	504 KD 11 SS	504 KD 11 SS FB
554	554 KD 11 SS	554 KD 11 SS FB
604	604 KD 11 SS	604 KD 11 SS FB
705	705 KD 11 SS	705 KD 11 SS FB
805	805 KD 11 SS	805 KD 11 SS FB
905	905 KD 11 SS	905 KD 11 SS FB

^① All finish bores and keyways per AGMA 9002-A86 commercial standard tolerances.

Component Parts

Description	Part Number
Standard Hub	SHUB
*HT Disc Pack Assembly	HTDP
*HT Disc Pack Fastener Set	HTFS
*Center Flange Fastener Set	CFFS

* For Disc Packs and Fastener Sets, do not include "Series" number in the part number.

How to Order Components

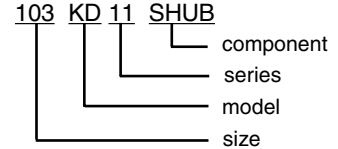

How to Order Disc Packs & Fastener Sets

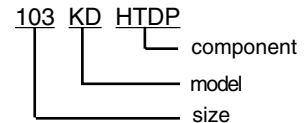

Visit www.kopflex.com

Selection Data

Size	Max. Bore (in)	Coupling Rating (HP/100 RPM)	Torque Rating		Maximum ^② Speed (RPM)	Total ^① Weight (lbs)	Total ^① WR ² (lb-in ²)	Axial Capacity (in)
			Continuous (in-lb)	Peak (in-lb)				
103	1.50	6.3	4000	8000	14200	9.0	27	±.080
153	2.12	21.6	13600	27200	12500	18.6	90	±.140
204	2.62	57.1	36000	72000	11100	29.2	189	±.110
254	3.25	82.5	52000	104000	9900	43.8	400	±.140
304	3.75	141	89000	178000	8700	69.6	839	±.170
354	4.25	238	150000	300000	7500	111	1790	±.200
404	4.75	340	215000	430000	6600	168	3450	±.225
454	5.50	405	255000	510000	6000	204	5220	±.250
504	5.75	570	360000	720000	5600	272	7920	±.275
554	6.25	800	505000	1010000	4800	364	13200	±.300
604	6.75	1050	660000	1320000	4600	458	21100	±.320
705	8.50	2400	1510000	3020000	3860	824	52400	±.270
805	9.50	3670	2310000	4620000	3450	1220	98000	±.310
905	11.50	4130	2600000	5200000	1520	1520	151000	±.400

① Data based on maximum bores.

② See Balance Specifications page 23. Consult engineering for applications where speed exceed 75% of max. speed rating.

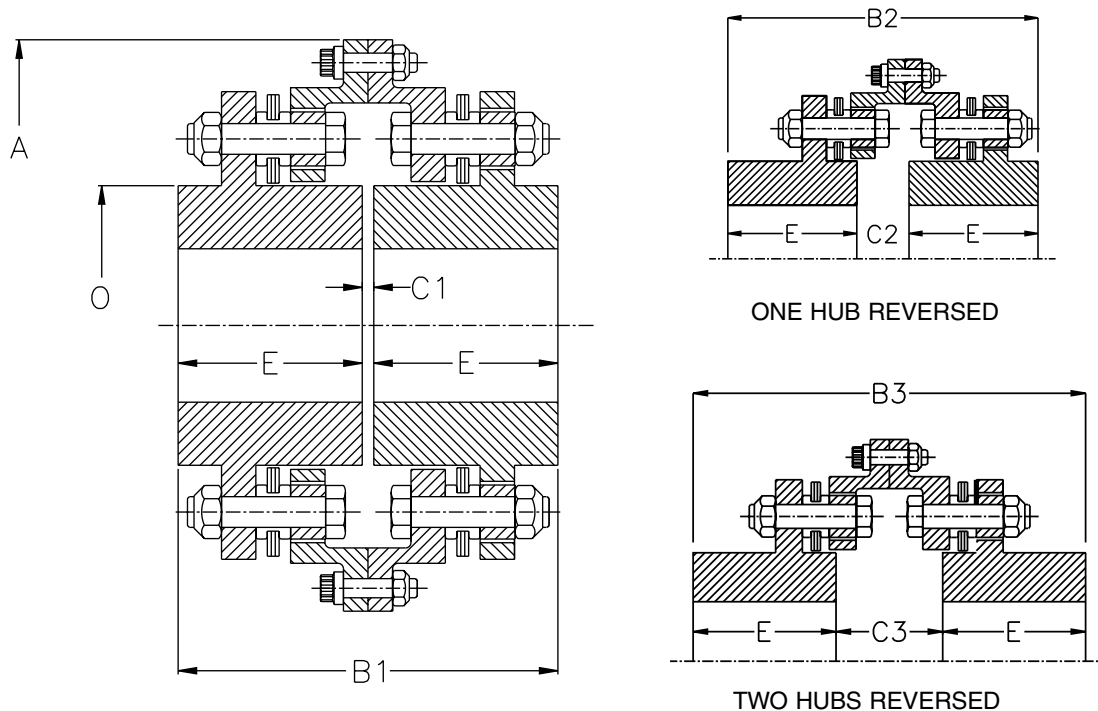

Dimensional Data

Size	A (in)	B1 (in)	B2 (in)	B3 (in)	C1 (in)	C2 (in)	C3 (in)	E (in)	O (in)
103	5.44	3.38	4.56	5.75	.12	1.31	2.50	1.64	2.10
153	6.81	4.12	5.58	7.03	.12	1.58	3.03	2.00	2.96
204	7.81	5.00	6.50	8.00	.12	1.62	3.12	2.44	3.64
254	9.31	6.19	7.22	8.25	.19	1.22	2.25	3.00	4.56
304	10.62	7.19	8.41	9.62	.19	1.41	2.62	3.50	5.25
354	12.28	8.50	10.00	11.50	.25	1.75	3.25	4.12	5.91
404	13.94	9.50	11.50	13.50	.25	2.25	4.25	4.62	6.75
454	15.56	10.56	12.44	14.31	.31	2.19	4.06	5.12	7.62
504	16.69	11.56	13.45	15.34	.31	2.20	4.09	5.62	8.19
554	18.69	12.31	14.48	16.64	.31	2.48	4.64	6.00	8.75
604	20.00	13.31	15.70	18.09	.31	2.70	5.09	6.50	9.31
705	24.00	16.38	19.00	21.62	.38	3.00	5.62	8.00	11.34
805	26.88	18.38	21.53	24.68	.38	3.53	6.68	9.00	12.75
905	30.00	20.50	23.59	26.68	.50	3.59	6.68	10.00	15.25

The KD2® coupling is designed for medium duty applications requiring moderate shaft separations, and was specifically engineered to meet API 610 specifications for industrial pump couplings. Consisting of three main parts, two hubs and a factory assembled flexible center section which installs or drops out as one unit, the KD2 greatly simplifies installation or maintenance.

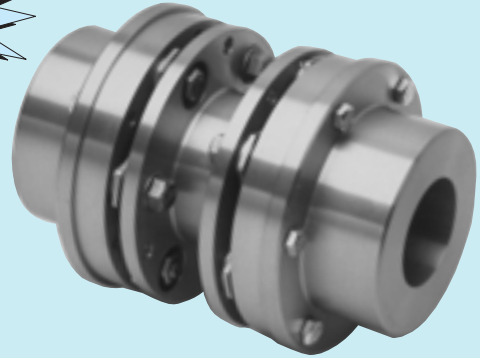

The flexible center section is piloted to insure excellent dynamic balance. AGMA Class 9 is standard, as-manufactured. Dynamic balance to AGMA Class 10 or Class 11 are available options. An anti-flail safety feature is also included in the flexible center section assembly.

For higher power requirements, consider a KD20 disc coupling. For economy duty, consider a KD21 disc coupling. If a flexible hub design is needed, consider a KD22 disc coupling.

- Medium Duty
- Standard Shaft Separations for Industrial Pumps
- Factory Assembled Flexible Center Sections
- Designed Specifically for API 610
- High Flexible, Unitized Disc Packs

KD2® couplings use MT Disc Packs.

KD2® Rough Bore Part Numbers

Coupling Size	Between Shaft Ends	Complete Coupling w/2 Std. Hubs Rough Bore	Complete Coupling w/1 Std. & 1 Long Hub Rough Bore	Complete Coupling w/2 Long Hubs Rough Bore	Complete Coupling w/1 Jumbo Hub & 1 Std. Hub	Complete Coupling w/2 Jumbo hubs	Complete Coupling w/1 Long & 1 Jumbo Hub	Center Assembly
023	3 1/2	023 KD 2 SS350	023 KD 2 LS350	023 KD 2 LL350	023 KD 2 JS350	023 KD 2 JJ350	023 KD 2 JL350	023 KD 2 CA350
	5	023 KD 2 SS500	023 KD 2 LS500	023 KD 2 LL500	023 KD 2 JS500	023 KD 2 JJ500	023 KD 2 JL500	023 KD 2 CA500
	7	023 KD 2 SS700	023 KD 2 LS700	023 KD 2 LL700	023 KD 2 JS700	023 KD 2 JJ700	023 KD 2 JL700	023 KD 2 CA700
103	3 1/2	103 KD 2 SS350	103 KD 2 LS350	103 KD 2 LL350	103 KD 2 JS350	103 KD 2 JJ350	103 KD 2 JL350	103 KD 2 CA350
	4 3/8	103 KD 2 SS438	103 KD 2 LS438	103 KD 2 LL438	103 KD 2 JS438	103 KD 2 JJ438	103 KD 2 JL438	103 KD 2 CA438
	5	103 KD 2 SS500	103 KD 2 LS500	103 KD 2 LL500	103 KD 2 JS500	103 KD 2 JJ500	103 KD 2 JL500	103 KD 2 CA500
	7	103 KD 2 SS700	103 KD 2 LS700	103 KD 2 LL700	103 KD 2 JS700	103 KD 2 JJ700	103 KD 2 JL700	103 KD 2 CA700
153	4 3/8	153 KD 2 SS438	153 KD 2 LS438	153 KD 2 LL438	153 KD 2 JS438	153 KD 2 JJ438	153 KD 2 JL438	153 KD 2 CA438
	5	153 KD 2 SS500	153 KD 2 LS500	153 KD 2 LL500	153 KD 2 JS500	153 KD 2 JJ500	153 KD 2 JL500	153 KD 2 CA500
	7	153 KD 2 SS700	153 KD 2 LS700	153 KD 2 LL700	153 KD 2 JS700	153 KD 2 JJ700	153 KD 2 JL700	153 KD 2 CA700
203	5	203 KD 2 SS500	203 KD 2 LS500	203 KD 2 LL500	203 KD 2 JS500	203 KD 2 JJ500	203 KD 2 JL500	203 KD 2 CA500
	7	203 KD 2 SS700	203 KD 2 LS700	203 KD 2 LL700	203 KD 2 JS700	203 KD 2 JJ700	203 KD 2 JL700	203 KD 2 CA700
253	7	253 KD 2 SS700	253 KD 2 LS700	253 KD 2 LL700	253 KD 2 JS700	253 KD 2 JJ700	253 KD 2 JL700	253 KD 2 CA700
	8	253 KD 2 SS800	253 KD 2 LS800	253 KD 2 LL800	253 KD 2 JS800	253 KD 2 JJ800	253 KD 2 JL800	253 KD 2 CA800
303	7	303 KD 2 SS700	303 KD 2 LS700	303 KD 2 LL700	303 KD 2 JS700	303 KD 2 JJ700	303 KD 2 JL700	303 KD 2 CA700
	8	303 KD 2 SS800	303 KD 2 LS800	303 KD 2 LL800	303 KD 2 JS800	303 KD 2 JJ800	303 KD 2 JL800	303 KD 2 CA800
353	8	353 KD 2 SS800	353 KD 2 LS800	353 KD 2 LL800	353 KD 2 JS800	353 KD 2 JJ800	353 KD 2 JL800	353 KD 2 CA800
	9	353 KD 2 SS900	353 KD 2 LS900	353 KD 2 LL900	353 KD 2 JS900	353 KD 2 JJ900	353 KD 2 JL900	353 KD 2 CA900
403	9	403 KD 2 SS900	403 KD 2 LS900	403 KD 2 LL900	403 KD 2 JS900	403 KD 2 JJ900	403 KD 2 JL900	403 KD 2 CA900
453	9	453 KD 2 SS900	453 KD 2 LS900	453 KD 2 LL900	453 KD 2 JS900	453 KD 2 JJ900	453 KD 2 JL900	453 KD 2 CA900

Ⓢ **Note: For Finish Bore add FB to Part Number and specify bore.**

Ⓢ All finish bores and keyways per AGMA 9002-A86 commercial standard tolerances.

Component Parts

Description	Part Number
Standard Hub	SHUB
Long Hub	LHUB
Jumbo Hub	JHUB
*Center Assembly for x.xx Shaft Separation	CAXXX
**MT Disc Pack	MTDP
**MT Disc Pack Fastener Set	MTFS
**Flange Fastener Set	FFSMT
**Jumbo Hub Fastener Set	JFSHT

* Center Assembly includes (2) disc packs, (2) disc pack fastener sets.

** For Disc Packs and Fastener Sets, do not include "Series" number in the part number.

How to Order Components

103 KD 2 SHUB

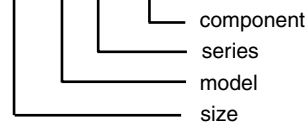

How to Order Disc Packs and Fastener Sets

103 KD MTDP

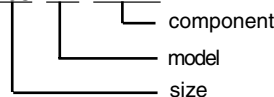

Selection Data

Size	Maximum Bores (in)		Coupling Rating (HP/100 RPM)	Torque Rating		Maximum Speed (RPM)	Total Weight (lbs)	Total WR ² (lb-in ²)	Spacer Tube Weight per inch		Axial Capacity (in)
	Std. & Long Hub	Jumbo Hub		Continuous (in-lb)	Peak (in-lb)				Weight (lbs)	WR ² (lb-in ²)	
023	1.50	2.00	2.3	1450	2900	25500	5.5	10.5	0.17	0.10	±.040
103	1.88	2.75	4.3	2710	5420	17000	9.9	22.0	0.44	0.45	±.060
153	2.88	4.00	12.5	7880	15760	14200	23.2	93.1	0.54	1.06	±.075
203	3.25	4.62	22.9	14400	28800	12800	35.5	205	0.56	1.67	±.090
253	4.00	5.62	37.5	23600	47200	11500	58.8	475	0.73	3.59	±.105
303	4.75	6.50	60.0	37800	75600	10000	89.6	989	1.14	7.52	±.125
353	5.50	7.62	100	63000	126000	8500	145	2160	1.57	12.70	±.150
403	6.25	8.75	155	97700	195000	7500	220	4290	1.84	19.80	±.175
453	7.25	9.38	205	129000	258000	7000	261	6180	2.01	27.00	±.200

① Data based on Min. "C" dimensions, maximum bores and standard hubs.

② See Balance Specifications page 23. Consult engineering for applications where speed exceed 75% of max. speed rating.

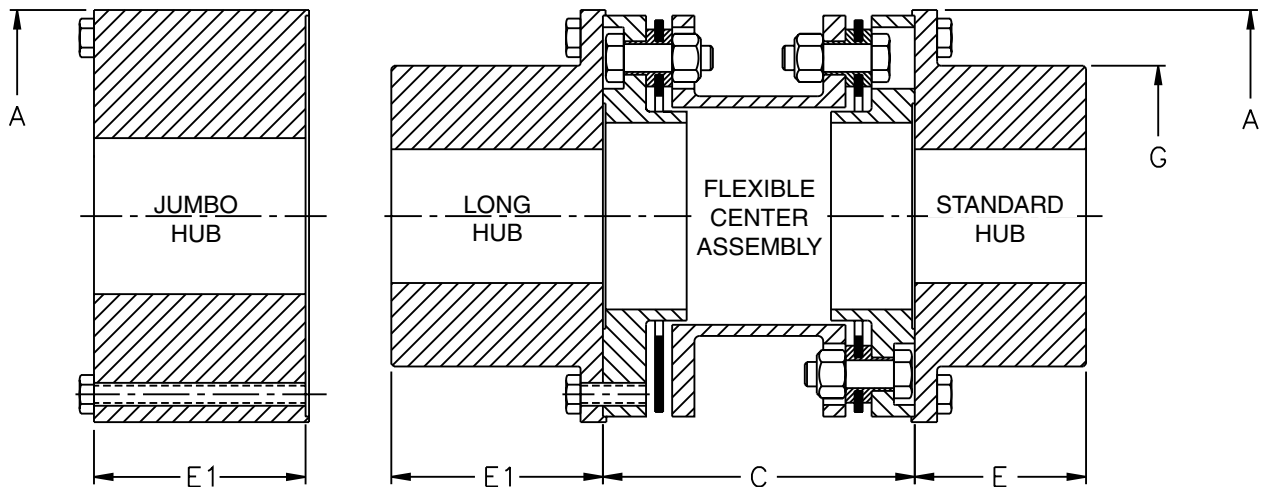

Note: "C" dimension = center assembly length.

Dimensional Data

Size	Rough Bore	A (in)	Max C' Bore (in)	C Min. (in)	E (in)	E1 (in)	G (in)	Stock "C" Dimension (in)						
								3 1/2	4 3/8	5	7	8	9	
023	0.31	3.54	1.88	2.50	1.57	1.57	2.16	X		X	X			
103	0.50	4.31	2.38	3.50	1.50	2.50	2.62	X	X	X	X			
153	0.75	5.69	3.88	4.38	2.00	3.12	4.12		X	X	X			
203	1.00	6.75	4.50	4.81	2.25	3.62	4.75			X	X			
253	1.00	8.00	5.50	5.75	2.88	4.25	5.75				X	X		
303	1.50	9.25	6.44	6.50	3.38	4.75	6.75				X	X		
353	2.00	10.75	7.31	7.62	4.00	5.38	7.75					X	X	
403	2.50	12.25	8.50	9.00	4.44	6.12	9.00						X	X
453	3.00	13.25	9.62	9.00	4.81	6.75	10.12							X

Note: Shaft separations longer than stock may be accommodated by using stock center assemblies and counterboring and overhanging long hubs to make up the difference. Shaft fit length should be equal to "E" or greater. Consult KOP-FLEX for more details.



Visit www.kopflex.com

KD20 Spacer Coupling

The KD20 coupling is designed for heavy duty applications requiring moderate shaft separations, and was specifically engineered to meet API 610 specifications for industrial pump couplings. Consisting of three main parts, two hubs and a factory assembled flexible center section which installs or drops out as one unit, the KD20 greatly simplifies installation or maintenance.

The larger size couplings available in the KD20 Series allow application to larger, high power machines. The flexible center section is piloted to provide excellent dynamic balance. AGMA Class 9 is standard, as manufactured. Dynamic balance to AGMA Class 10 or Class 11 are available options. The close tolerance bolts and safety overload washers provide superior performance and trouble-free operation. An anti-flail safety feature is also included in the flexible center section assembly.

For smaller sizes or lower power requirements, consider a KD2 disc coupling. For economy duty, consider a KD21 disc coupling. If a flexible hub design is needed, consider a KD22 disc coupling.

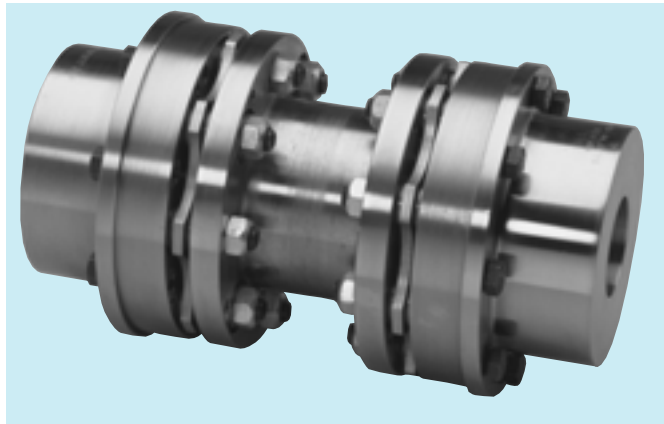

- Heavy Duty, Larger Sizes
- Standard Shaft Separations for Industrial Pumps
- Factory Assembled Flexible Center Sections
- Designed Specifically for API 610
- High Power, Unitized Disc Packs

KD20 Couplings use HT Disc Packs.

KD20 Rough Bore Part Numbers

Coupling Size	Between Shaft Ends	Complete Coupling w/2 Std. Hubs Rough Bore	Complete Coupling w/1 Std. & 1 Long Hub Rough Bore	Complete Coupling w/2 Long Hubs Rough Bore	Complete Coupling w/1 Jumbo Hub & 1 Std. Hub	Complete Coupling w/2 Jumbo hubs	Complete Coupling w/1 Long & 1 Jumbo Hub	Center Assembly
204	7	204 KD 20 SS700	204 KD 20 LS700	204 KD 20 LL700	204 KD 20 JS700	204 KD 20 JJ700	204 KD 20 JL700	204 KD 20 CA700
	8	204 KD 20 SS800	204 KD 20 LS800	204 KD 20 LL800	204 KD 20 JS800	204 KD 20 JJ800	204 KD 20 JL800	204 KD 20 CA800
	9	204 KD 20 SS900	204 KD 20 LS900	204 KD 20 LL900	204 KD 20 JS900	204 KD 20 JJ900	204 KD 20 JL900	204 KD 20 CA900
	10	204 KD 20 SS1000	204 KD 20 LS1000	204 KD 20 LL1000	204 KD 20 JS1000	204 KD 20 JJ1000	204 KD 20 JL1000	204 KD 20 CA1000
	12	204 KD 20 SS1200	204 KD 20 LS1200	204 KD 20 LL1200	204 KD 20 JS1200	204 KD 20 JJ1200	204 KD 20 JL1200	204 KD 20 CA1200
254	7	254 KD 20 SS700	254 KD 20 LS700	254 KD 20 LL700	254 KD 20 JS700	254 KD 20 JJ700	254 KD 20 JL700	254 KD 20 CA700
	8	254 KD 20 SS800	254 KD 20 LS800	254 KD 20 LL800	254 KD 20 JS800	254 KD 20 JJ800	254 KD 20 JL800	254 KD 20 CA800
	9	254 KD 20 SS900	254 KD 20 LS900	254 KD 20 LL900	254 KD 20 JS900	254 KD 20 JJ900	254 KD 20 JL900	254 KD 20 CA900
	10	254 KD 20 SS1000	254 KD 20 LS1000	254 KD 20 LL1000	254 KD 20 JS1000	254 KD 20 JJ1000	254 KD 20 JL1000	254 KD 20 CA1000
	12	254 KD 20 SS1200	254 KD 20 LS1200	254 KD 20 LL1200	254 KD 20 JS1200	254 KD 20 JJ1200	254 KD 20 JL1200	254 KD 20 CA1200
304	7	304 KD 20 SS700	304 KD 20 LS700	304 KD 20 LL700	304 KD 20 JS700	304 KD 20 JJ700	304 KD 20 JL700	304 KD 20 CA700
	8	304 KD 20 SS800	304 KD 20 LS800	304 KD 20 LL800	304 KD 20 JS800	304 KD 20 JJ800	304 KD 20 JL800	304 KD 20 CA800
	9	304 KD 20 SS900	304 KD 20 LS900	304 KD 20 LL900	304 KD 20 JS900	304 KD 20 JJ900	304 KD 20 JL900	304 KD 20 CA900
	10	304 KD 20 SS1000	304 KD 20 LS1000	304 KD 20 LL1000	304 KD 20 JS1000	304 KD 20 JJ1000	304 KD 20 JL1000	304 KD 20 CA1000
	12	304 KD 20 SS1200	304 KD 20 LS1200	304 KD 20 LL1200	304 KD 20 JS1200	304 KD 20 JJ1200	304 KD 20 JL1200	304 KD 20 CA1200
354	9	354 KD 20 SS900	354 KD 20 LS900	354 KD 20 LL900	354 KD 20 JS900	354 KD 20 JJ900	354 KD 20 JL900	354 KD 20 CA900
	10	354 KD 20 SS1000	354 KD 20 LS1000	354 KD 20 LL1000	354 KD 20 JS1000	354 KD 20 JJ1000	354 KD 20 JL1000	354 KD 20 CA1000
	12	354 KD 20 SS1200	354 KD 20 LS1200	354 KD 20 LL1200	354 KD 20 JS1200	354 KD 20 JJ1200	354 KD 20 JL1200	354 KD 20 CA1200
	14	354 KD 20 SS1400	354 KD 20 LS1400	354 KD 20 LL1400	354 KD 20 JS1400	354 KD 20 JJ1400	354 KD 20 JL1400	354 KD 20 CA1400
404	10	404 KD 20 SS1000	404 KD 20 LS1000	404 KD 20 LL1000	404 KD 20 JS1000	404 KD 20 JJ1000	404 KD 20 JL1000	404 KD 20 CA1000
	12	404 KD 20 SS1200	404 KD 20 LS1200	404 KD 20 LL1200	404 KD 20 JS1200	404 KD 20 JJ1200	404 KD 20 JL1200	404 KD 20 CA1200
	14	404 KD 20 SS1400	404 KD 20 LS1400	404 KD 20 LL1400	404 KD 20 JS1400	404 KD 20 JJ1400	404 KD 20 JL1400	404 KD 20 CA1400
454	10	454 KD 20 SS1000	454 KD 20 LS1000	454 KD 20 LL1000	454 KD 20 JS1000	454 KD 20 JJ1000	454 KD 20 JL1000	454 KD 20 CA1000
	12	454 KD 20 SS1200	454 KD 20 LS1200	454 KD 20 LL1200	454 KD 20 JS1200	454 KD 20 JJ1200	454 KD 20 JL1200	454 KD 20 CA1200
	14	454 KD 20 SS1400	454 KD 20 LS1400	454 KD 20 LL1400	454 KD 20 JS1400	454 KD 20 JJ1400	454 KD 20 JL1400	454 KD 20 CA1400

① All finish bores and keyways per AGMA 9002-A86 commercial standard tolerances.

® **Note: For Finish Bore add FB to Part Number and specify bore.**



Visit www.kopflex.com

Selection Data

Size	Max. Bore (in)		Coupling Rating (HP/100 RPM)	Torque Rating		Maximum Speed (RPM)	Total ^① Weight (lbs)	Total ^① WR ² (lb-in ²)	Spacer Tube per inch		Axial Capacity (in)
	Std. & Long Hub	Jumbo Hub		Continuous (in-lb)	Peak (in-lb)				Weight (lbs)	WR ² (lb-in ²)	
204	3.25	4.62	57.1	36000	72000	13000	39.2	230	0.81	2.67	±.110
254	4.00	5.62	82.5	52000	104000	11200	61.2	510	0.79	4.36	±.140
304	4.75	6.5	141	89000	178000	9900	104	1190	1.17	8.06	±.170
354	5.50	7.62	238	150000	300000	8800	172	2630	1.96	17.0	±.200
404	6.25	8.75	340	215000	430000	7800	251	4920	2.21	24.3	±.225
454	7.25	9.38	405	255000	510000	7200	302	7200	2.54	37.0	±.250
504	7.50	-	570	360000	720000	6600	427	11600	3.67	62.6	±.275
554	8.25	-	800	505000	1010000	6100	569	18200	3.89	74.7	±.300
604	9.00	-	1050	660000	1320000	5600	777	29500	5.21	115	±.320
705	10.88	-	2400	1510000	3020000	4500	1360	77500	9.40	303	±.270
805	12.25	-	3670	2310000	4620000	4000	2060	150000	12.6	507	±.310
905	13.50	-	4130	2600000	5200000	3600	2490	227000	11.7	662	±.400

① Data based on Min. "C" dimensions, maximum bores and standard hubs.

② See Balance Specifications page 23. Consult engineering for applications where speed exceed 75% of max. speed rating.

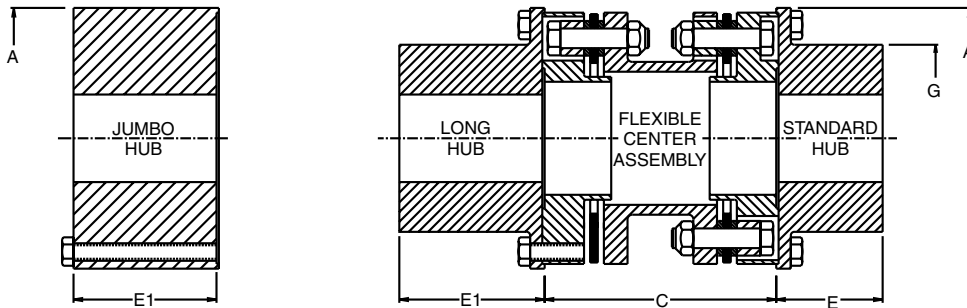

Dimensional Data

Note: "C" dimension = center assembly length.

Size	A (in)	Max. C' Bore (in)	Min. C (in)	E (in)	E1 (in)	G (in)	No (in)	Ni (in)	Stock "C" Dimension (in.)					
									7	8	9	10	12	14
204	6.62	4.50	6.00	2.25	3.62	4.75	3.88	3.38	X	X	X	X	X	X
254	7.88	5.50	6.00	2.88	4.25	5.75	4.88	4.50	X	X	X	X	X	X
304	9.25	6.44	7.00	3.38	4.75	6.75	5.50	5.00	X	X	X	X	X	X
354	10.75	7.31	8.50	4.00	5.38	7.75	6.25	5.50			X	X	X	X
404	12.00	8.50	10.00	4.44	6.12	9.00	7.00	6.25				X	X	X
454	13.00	9.62	10.00	4.81	6.75	10.12	8.00	7.25				X	X	X
504	14.12	9.88	11.00	6.88	-	10.50	8.75	7.75						
554	15.38	10.75	12.50	7.50	-	11.50	9.25	8.25						
604	16.88	12.00	13.25	8.75	-	12.75	10.00	8.75						
705	20.88	14.50	16.00	9.75	-	15.25	12.25	10.38						
805	23.38	16.38	19.00	10.75	-	17.25	13.75	11.50						
905	25.88	18.00	19.00	11.75	-	19.00	15.88	14.12						

* Long hubs are available for sizes 204 to 454 only.

Component Parts

Description	Part Number
Standard Hub	SHUB
Long Hub	LHUB
Jumbo Hub	JHUB
*Center Assembly for x.xx Shaft Separation	CAXXX
**HT Disc Pack Assembly	HTDP
**HT Disc Pack Fastener Set	HTFS
**Flange Fastener Set	FFSHT
**Jumbo Hub Fastener Set	JFSHT

* Center Assembly includes (2) disc packs, (2) disc pack fastener sets.

** For Disc Packs and Fastener Sets, do not include "Series" number in the part number.

How to Order Components

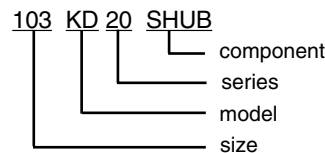

How to Order Disc Packs and Fastener Sets

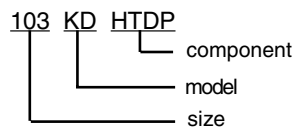

Note: Shaft separations longer than stock may be accommodated by using stock center assemblies and counterboring and overhanging long hubs to make up the difference. Shaft fit length should be equal to "E" or greater. Consult KOP-FLEX for more details.

The KD21 coupling is designed for medium and heavy duty applications requiring moderate shaft separations. The minimal number of components yields an economical disc coupling solution to spacer applications. The larger sizes available in the KD21 Series allow application to larger, high power machines.

Consisting of three main parts; two hubs and a center spacer which installs or drops out using unitized disc packs, the KD21 simplifies installation or maintenance. The unitized disc packs and close tolerance bolts provide good dynamic balance. AGMA Class 9 is standard, as-manufactured. Dynamic balance to AGMA Class 10 and conformance to API 610 are available options. The close tolerance bolts and safety overload washers provide superior performance and trouble-free operation.

If a coupling with a factory-assembled flexible center section is desired, consider a KD20 or KD2 disc coupling. For lower power requirements, consider a KD50 disc coupling. If a flexible hub design is needed, consider a KD22 disc coupling.

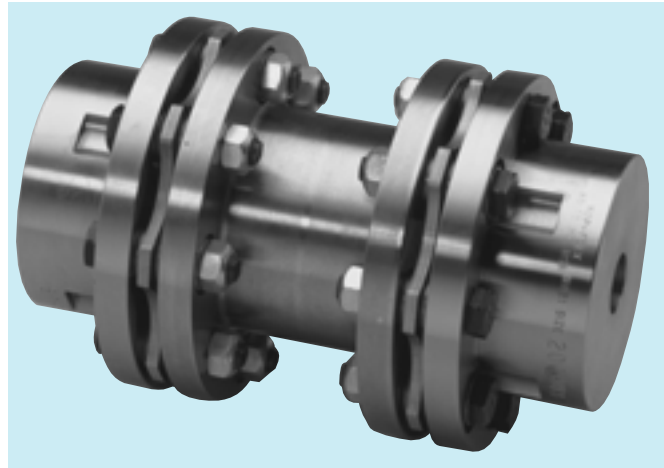

- Heavy Duty, Larger Sizes
- Economical Spacer Series
- Standard Shaft Separations for Industrial Pumps
- Drop-Out, Unitized Disc Packs

KD21 couplings use HT Disc Packs.



Coupling Size	Between Shaft Ends*	Complete Coupling with 2 Std. Hubs		Complete Coupling with 1 Std. Hub and 1 Long Hub	
		Rough Bore	Finish Bore	Rough Bore	Finish Bore
053*	5	053 KD2 SS500	NA	NA	NA
103	3 1/2	103 KD 21 SS350	103 KD 21 SS350 FB	103 KD 21 LS350	103 KD 21 LS350 FB
	5	103 KD 21 SS500	103 KD 21 SS500 FB	103 KD 21 LS500	103 KD 21 LS500 FB
153	5	153 KD 21 SS500	153 KD 21 SS500 FB	153 KD 21 LS500	153 KD 21 LS500 FB
204	5	204 KD 21 SS500	204 KD 21 SS500 FB	204 KD 21 LS500	204 KD 21 LS500 FB
	7	204 KD 21 SS700	204 KD 21 SS700 FB	204 KD 21 LS700	204 KD 21 LS700 FB
	9	204 KD 21 SS900	204 KD 21 SS900 FB	204 KD 21 LS900	204 KD 21 LS900 FB
	10	204 KD 21 SS1000	204 KD 21 SS1000 FB	204 KD 21 LS1000	204 KD 21 LS1000 FB
254	12	204 KD 21 SS1200	204 KD 21 SS1200 FB	204 KD 21 LS1200	204 KD 21 LS1200 FB
	5	254 KD 21 SS500	254 KD 21 SS500 FB	254 KD 21 LS500	254 KD 21 LS500 FB
	7	254 KD 21 SS700	254 KD 21 SS700 FB	254 KD 21 LS700	254 KD 21 LS700 FB
	9	254 KD 21 SS900	254 KD 21 SS900 FB	254 KD 21 LS900	254 KD 21 LS900 FB
304	14	254 KD21 SS1400	254 KD21 SS1400 FB	254 KD 21 LS1400	254 KD 21 LS1400 FB
	7	304 KD 21 SS700	304 KD 21 SS700 FB	304 KD 21 LS700	304 KD 21 LS700 FB
354	9	304 KD 21 SS900	304 KD 21 SS900 FB	304 KD 21 LS900	304 KD 21 LS900 FB
	14	304 KD 21 SS1400	304 KD 21 SS1400 FB	304 KD 21 LS1400	304 KD 21 LS1400 FB
	7	354 KD 21 SS700	354 KD 21 SS700 FB	354 KD 21 LS700	354 KD 21 LS700 FB
404	9	354 KD 21 SS900	354 KD 21 SS900 FB	354 KD 21 LS900	354 KD 21 LS900 FB
	14	354 KD 21 SS1400	354 KD 21 SS1400 FB	354 KD 21 LS1400	354 KD 21 LS1400 FB
454	8	404 KD 21 SS800	404 KD 21 SS800 FB	404 KD 21 LS800	404 KD 21 LS800 FB
	14	404 KD 21 SS1400	404 KD 21 SS1400 FB	404 KD 21 LS1400	404 KD 21 LS1400 FB

* For non-standard shaft separations, spacers can be manufactured to order.

Component Parts

Description	Part Number
Standard Hub	SHUB
Long Hub	LHUB
*HT Disc Pack Assembly	HTDP
*HT Disc Pack Fastener Set	HTFS

* For Disc Packs and Fastener Sets, do not include "Series" number in the part number.

How to Order Components

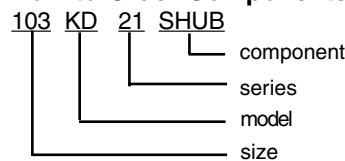

How to Order Disc Packs and Fastener Sets

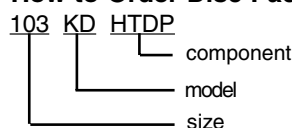

Visit www.kopflex.com

Selection Data

Size	Max. Bore (in)	Coupling Rating (HP/100 RPM)	Torque Rating		Maximum Speed RPM	TotalØ Weight (lbs)	TotalØ WR ² (lb-in ²)	Spacer Tube per inch		Axial Capacity (in)
			Continuous (in-lb)	Peak (in-lb)				Weight (lbs)	WR ² (lb-in ²)	
053	1.75	3.2	2000	4000	8200	7.7	16	0.50	0.42	±.055
103	1.75	6.3	4000	8000	18200	7.8	16	0.24	0.27	±.080
153	2.50	21.6	13600	27200	14800	17.7	67	0.39	0.80	±.140
204	3.00	57.1	36000	72000	13000	29.8	160	0.81	2.67	±.110
254	3.75	82.5	52000	104000	11200	44.3	336	0.79	4.36	±.140
304	4.50	141	89000	178000	9900	70.4	745	1.17	8.06	±.170
354	5.00	238	150000	300000	8800	117	1640	1.96	17.0	±.200
404	5.50	340	215000	430000	7800	177	3150	2.21	24.3	±.225
454	6.38	405	255000	510000	7200	205	4360	2.54	37.0	±.250
504	7.00	570	360000	720000	6600	305	7460	3.67	62.6	±.275
554	7.75	800	505000	1010000	6100	402	11800	3.89	74.7	±.300
604	8.50	1050	660000	1320000	5600	512	17800	5.21	115	±.320
705	10.75	2400	1510000	3020000	4500	922	50000	9.40	303	±.270
805	12.00	3670	2310000	4620000	4000	1350	93800	12.6	507	±.310
905	13.50	4130	2600000	5200000	3600	1700	146000	11.8	675	±.400

① Data based on min. "C" dimensions and maximum bores.

② See Balance Specifications page 23. Consult engineering for applications where speed exceed 75% of max. speed rating.

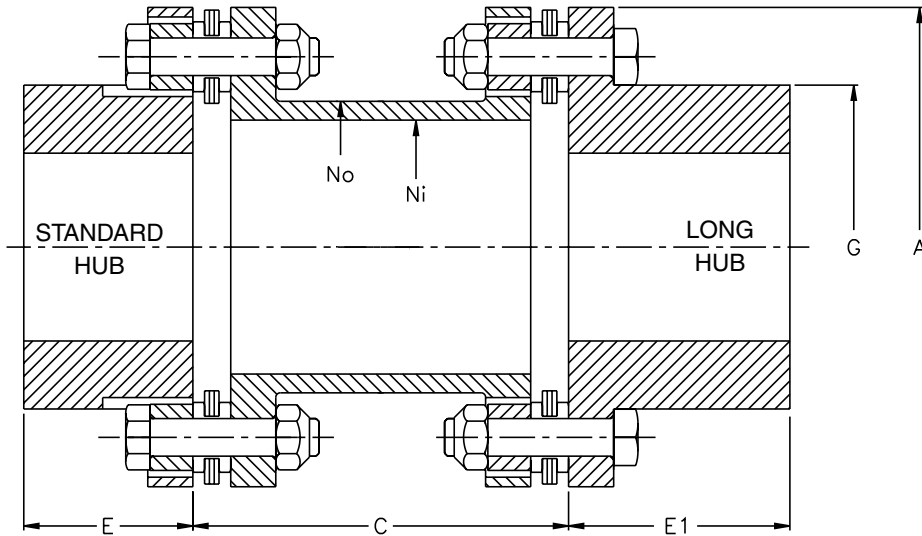

Note: "C" dimension = length of spacer plus (2) disc packs (including flat washers).

Dimensional Data

Size	A (in)	Min. C (in)	E (in)	E1* (in)	G (in)	No (in)	Ni (in)	Stock "C" Dimension (in.)							
								3.5	5	7	8	9	10	12	14
053	3.94	3.00	1.62	-	2.56	2.12	1.50	-	X	-	-	-	-	-	-
103	3.94	2.75	1.66	1.94	2.57	2.25	2.00	X	X	-	-	-	-	-	-
153	5.38	3.38	1.94	2.44	3.54	3.00	2.69	-	X	-	-	-	-	-	-
204	6.38	3.88	2.38	3.03	4.32	3.88	3.38	-	X	X	-	X	X	X	-
254	7.62	3.88	3.00	3.59	5.34	4.88	4.50	-	X	X	-	X	-	-	X
304	9.00	4.75	3.56	4.19	6.16	5.50	4.94	-	-	X	-	X	-	-	X
354	10.50	5.75	4.12	4.75	6.99	6.25	5.50	-	-	X	-	X	-	-	X
404	11.75	6.62	4.62	5.31	7.91	7.00	6.25	-	-	-	X	-	-	-	X
454	12.75	6.62	5.25	6.03	8.83	8.00	7.25	-	-	-	X	-	-	-	-
504	13.88	7.50	5.88	-	9.62	8.75	7.75	-	-	-	-	-	-	-	-
554	15.12	8.62	7.16	-	10.48	9.25	8.25	-	-	-	-	-	-	-	-
604	16.50	9.12	7.66	-	11.33	10.00	8.75	-	-	-	-	-	-	-	-
705	20.50	10.88	9.00	-	14.07	12.25	10.00	-	-	-	-	-	-	-	-
805	23.00	13.00	10.12	-	15.73	13.75	11.50	-	-	-	-	-	-	-	-
905	25.50	13.00	11.81	-	17.88	15.88	14.12	-	-	-	-	-	-	-	-

* Long hubs are available for sizes 103 to 454 only.

Note: Shaft separations longer than stock may be accommodated by using stock spacers and counterboring and overhanging long hubs to make up the difference. Shaft fit length should be equal to "E" or greater. Consult KOP-FLEX for more details.

The KD22 coupling is designed to be the most direct replacement for standard spacer style gear couplings and is meant for heavy duty applications where the flexible section must be located on the equipment shafts. The power capacity of the KD22 coupling is the highest in the industry, allowing the easiest conversion from a lubricated coupling to a low maintenance disc coupling.

Consisting of three main parts, two flexible half couplings and a center spacer which installs or drops out, the KD22 simplifies installation or maintenance and allows the connected equipment to be installed or removed keeping each half coupling completely assembled. The unitized disc packs and close tolerance bolts provide good dynamic balance. AGMA Class 8 is standard, as manufactured. Dynamic balance to AGMA Class 9 and conformance to API 610 are available options.

The KD22 coupling employs standard gear coupling spacer flanges which can be used to provide standard electrical insulation or shear cartridge features.

For other spacer designs, consider KD20 or KD21 disc couplings. For lower power requirements, consider a KD2 disc coupling.

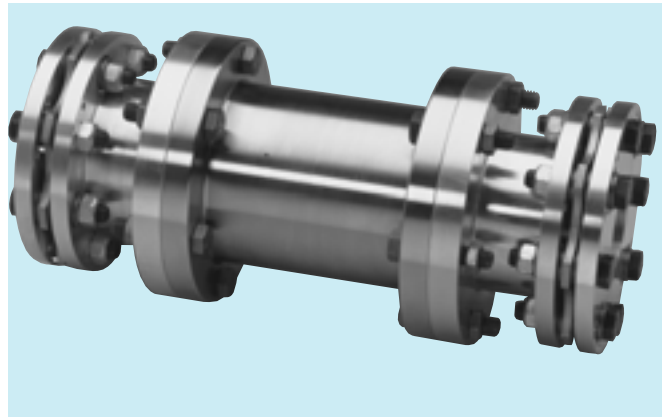

- Heavy Duty, Larger Sizes
- Flexible Shaft Hubs
- Reduced Overhung Weight
- High Power, Unitized Disc Packs

KD22 couplings use HT Disc Packs.

Complete KD22 Couplings are made to order. Contact your local EPT representative to order.

Component Parts

Description	Part Number
Standard Hub	SHUB
*Flex Half	FH
**HT Disc Pack Assembly	HTDP
**HS Disc Pack Fastener Set	HSFS

* Flex Halves are designated by disc/spacer size, and include (1) disc pack and (1) disc pack fastener set.

** For Disc Packs Components, do not include "Series" number in the part number.

Spacer Flange Data

Coupling Size	Spacer Fastener		Spacer Flange Size
	Part No.	Wt.	
103	1 EB FS	1	1.0
153	1 1/2 EB FS	1	1.5
204	2 EB FS	1	2.0
254	2 1/2 EB FS	2	2.5
304	3 EB FS	3	3.0
354	3 1/2 EB FS	5	3.5
404	4 EB FS	5	4.0
454	4 1/2 EB FS	5	4.5
504	5 EB FS	7	5.0
554	5 1/2 EB FS	9	5.5
604	6 EB FS	14	6.0
705	7 EB FS	14	7.0
805	8 EB FS	28	8.0
905	9 EB FS	34	9.0

How to Order Hubs

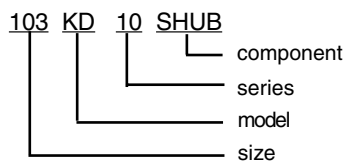

Note: KD10 Hubs are used on KD22 Couplings.

How to Order Flex Halves

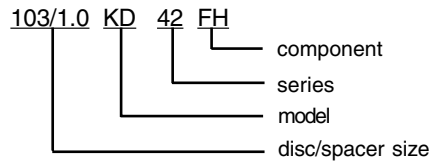

Note: KD42 Flex Halves are used on KD22 Couplings. See Spacer Flange Data for sizes.

How to Order Disc Pack Components

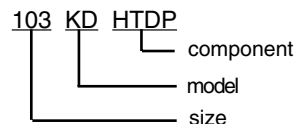

Visit www.kopflex.com

Selection Data

Size	Max. Bore (in.)	Max. Continuous Rating HP/100 RPM	Torque Rating		Maximum Speed RPM	Axial Capacity (in)
			Continuous (in-lb)	Peak (in-lb)		
103	1.50	6.3	4000	8000	17000	±.080
153	2.12	21.6	13600	27200	13500	±.140
204	2.62	57.1	36000	72000	12000	±.110
254	3.25	82.5	52000	104000	10600	±.140
304	3.75	141	89000	178000	9800	±.170
354	4.25	238	150000	300000	8400	±.200
404	4.75	340	215000	430000	7400	±.225
454	5.50	405	255000	510000	6750	±.250
504	5.75	570	360000	720000	6000	±.275
554	6.25	800	505000	1010000	5500	±.300
604	6.75	1050	660000	1320000	5100	±.320
705	8.50	2400	1510000	3020000	4500	±.270
805	9.50	3670	1278000	2556000	3950	±.310
905	11.50	4130	1784000	3568000	3300	±.400

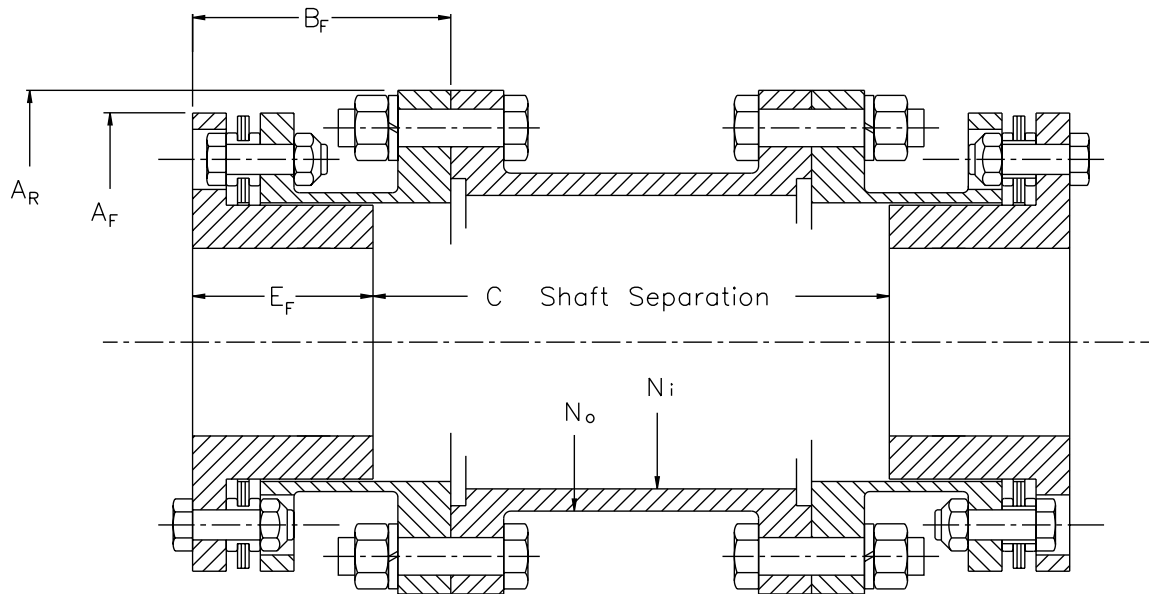

Dimensional Data

Size	A _F (in)	A _R (in)	B _F (in)	E _F (in)	Min. C (in)	N _O (in)	N _I (in)
103	3.94	4.56	2.35	1.69	3.50	2.88	2.50
153	5.38	6.00	3.16	2.12	5.00	3.75	3.25
204	6.38	7.00	4.04	2.75	6.00	4.75	4.12
254	7.62	8.38	4.44	3.03	7.00	5.62	4.88
304	9.00	9.44	5.00	3.59	7.00	6.62	5.81
354	10.50	11.00	5.79	4.38	7.50	7.75	6.81
404	11.75	12.50	6.62	5.19	8.00	8.75	7.81
454	12.75	13.62	6.74	5.31	8.00	9.75	8.75
504	13.88	15.31	7.46	6.03	9.00	11.00	9.81
554	15.12	16.75	8.47	6.91	8.00	12.00	10.69
604	16.50	18.00	8.22	7.41	7.00	18.50	12.19
705	20.50	20.75	9.50	8.69	7.00	15.00	13.69
805	23.00	23.25	11.00	9.81	9.00	17.75	16.98
905	25.50	26.00	11.82	10.88	9.00	19.88	19.00

Designed specifically for cooling tower drives and long span applications, the KD33 coupling is easy to handle, install and maintain. The drive shaft is a corrosion resistant lightweight composite tube of either special fiberglass or carbon graphite fibers engineered to provide the optimum combination of strength and bending stiffness required of cooling tower couplings.

The coupling hubs, adapters, disc packs and hardware are all stainless steel for high strength and corrosion resistance. The unitized disc packs are capable of up to 1/2° continuous misalignment, which provide trouble-free operation using close tolerance bolts and standard drive shaft dynamic balance.

The couplings shown below are stocked and available for quick supply. Two weeks standard delivery or 24 hour premium delivery is available.

For longer shaft spans or special designs, consult KOP-FLEX.

KD33 Couplings use CT Disc Packs.



- Composite Tubes for Low Weight and Corrosion Resistance
- Stainless Steel Metal Components
- Quick Delivery
- High Flexible, Unitized Disc Packs

Part Numbers

Complete KD33 Coupling, Class 1 (Stainless Steel & Composite Shaft)
Shaft Separation Must Be Specified at Time of Order.

Size	Driveshaft	Maximum DBSE		Complete Coupling Part No.	Disc Pack Part No.	Disc Pack Fastener Set Part No.
		@ 1800 RPM	@ 1500 RPM			
153	4" E-Glass	96	105	153 KD 33 EG	153 KD CTD	153 KD CTFS
153	4" Carbon	130	141	153 KD 33 C		
203	6" E-Glass	118	128	203 KD 33 EG	203 KD CTD	203 KD CTFS
203	6" Carbon	160	172	203 KD 33 C		
253	6" E-Glass	116	128	253 KD 33 EG	253 KD CTD	253 KD CTFS
253	6" Carbon	160	172	253 KD 33 C		

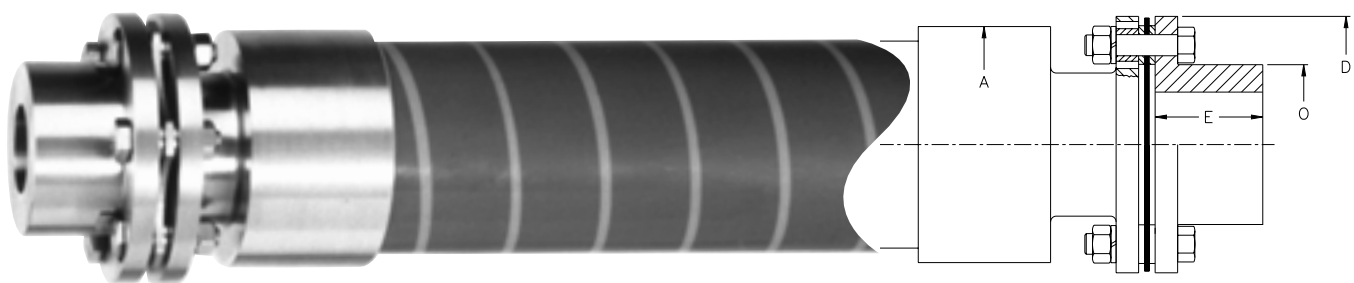
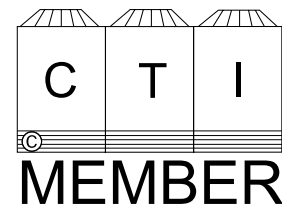

Selection and Dimensional Data

Size	Max Bore (inches)	Coupling Rating HP/100 RPM	Torque Rating (in-lb)		Nominal Tube Dia. (in)	Composite Tube Material	Maximum DBSE @ 1800 RPM (in)	Maximum DBSE @ 1500 RPM (in)	Dimensions			
			Continuous	Peak					A (in)	E (in)	O (in)	D (in)
153	2.38	12.5	7880	15760	4	E-GLASS	96	105	4.8	2.25	3.35	5.38
					4	CARBON	130	141				
203	3.00	22.9	14400	28800	6	E-GLASS	118	128	6.9	2.50	4.26	6.38
					6	CARBON	160	172				
253	3.75	37.5	23600	47200	6	E-GLASS	118	128	6.9	3.00	5.26	7.69
					6	CARBON	160	172				

The KD4 coupling is designed for medium and heavy duty applications **requiring only angular misalignment capacity** as in three bearing installations or floating shaft arrangements.

The larger size couplings available in the KD4 Series allow application to larger, high power machines.

Consisting of three main parts, two hubs and a unitized disc pack which installs or drops out, the KD4 simplifies installation or maintenance. The close tolerance bolts and safety overload washers insure superior performance and trouble free operation.

For complete floating shaft assemblies, consider a KD41 or KD42 disc coupling. For lower power requirements, consider a KD5 disc coupling.

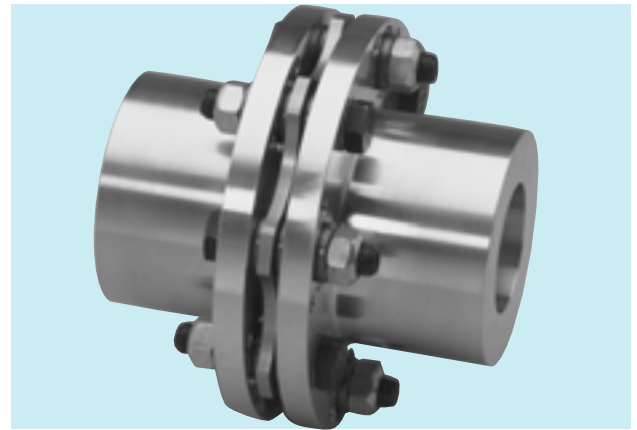

- Angular Misalignment Capacity
- Heavy Duty, Small to Large Sizes
- Drop-Out, Unitized Disc Packs

KD4 Couplings use HT Disc Packs.

Selection Data

Size	Max. Bore (in)	Coupling Rating (HP/100 RPM)	Torque Rating		Maximum Speed RPM	Total ^① Weight (lbs)	Total ^① WR ² (lb-in ²)	Axial Capacity ^② (in)
			Continuous (in-lb)	Peak (in-lb)				
103	1.75	6.3	4000	8000	18200	5.2	9.5	±.040
153	2.50	21.6	13600	27200	14800	11.4	38.5	±.070
204	3.00	57.1	36000	72000	13000	24.1	124	±.055
254	3.75	82.5	52000	104000	11200	32.2	212	±.070
304	4.50	141	89000	178000	9900	50.5	462	±.085
354	5.00	238	150000	300000	8800	78.5	980	±.100
404	5.50	340	215000	430000	7800	118	1880	±.113
454	6.38	405	255000	510000	7200	150	2780	±.125
504	7.00	570	360000	720000	6600	197	4380	±.138
554	7.75	800	505000	1100000	6100	277	7250	±.150
604	8.50	1050	660000	1320000	5600	348	10900	±.160
705	10.75	2400	1510000	3020000	4500	625	30500	±.135
805	12.00	3670	2310000	4620000	4000	915	57000	±.155
905	13.50	4130	2600000	5200000	3600	1250	95000	±.200

① Data Based on Maximum Bores.

② Axial Capacity for Single Flex Unit.

Dimensional Data

Size	A (in)	C (in)	E (in)	G (in)
103	3.94	.31	1.66	2.57
153	5.38	.39	1.94	3.54
204	6.38	.50	2.38	4.32
254	7.62	.57	3.00	5.34
304	9.00	.65	3.56	6.16
354	10.50	.81	4.12	6.99
404	11.75	.88	4.62	7.91
454	12.75	.94	5.25	8.83
504	13.88	1.09	5.88	9.62
554	15.12	1.22	7.16	10.48
604	16.50	1.32	7.66	11.33
705	20.50	1.56	9.00	14.07
805	23.00	1.84	10.12	15.73
905	25.50	1.76	11.81	17.88

Note: KD4 couplings use standard KD21 hubs and disc pack components. See page 38 for part numbers.

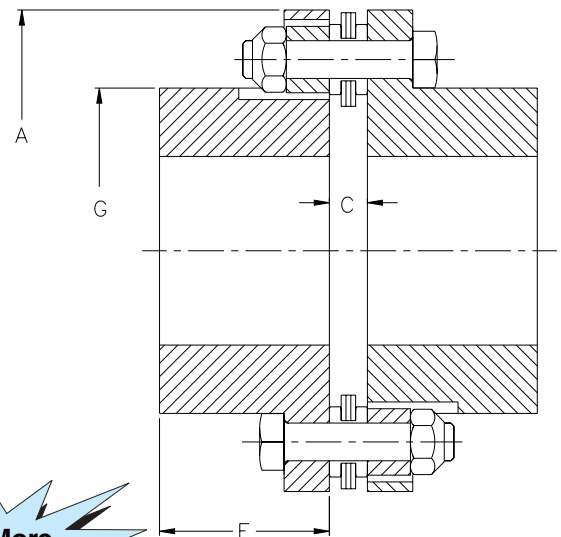

Visit www.kopflex.com

KD41 & KD41T Floating Shafts

The KD41 coupling is designed for medium and heavy duty applications requiring longer shaft separations. The minimal number of components yields an economical disc coupling solution to floating shaft applications. The larger size couplings available in the KD41 Series allow application to larger, high power machines.

The KD41 floating shaft coupling uses two single flex halves in conjunction with a solid center shaft, which installs or drops out simplifying installation or maintenance. The unitized disc packs, close tolerance bolts and safety overload washers provide superior performance and trouble-free zero backlash operation.

For lighter weight or higher stiffness, a tubular floating shaft design is available. The KD41T has all of the features of the KD41, but with a tubular shaft. For a direct replacement of a gear coupling floating shaft, consider a KD42 disc coupling. For a lower power application, consider the KD51 disc coupling.

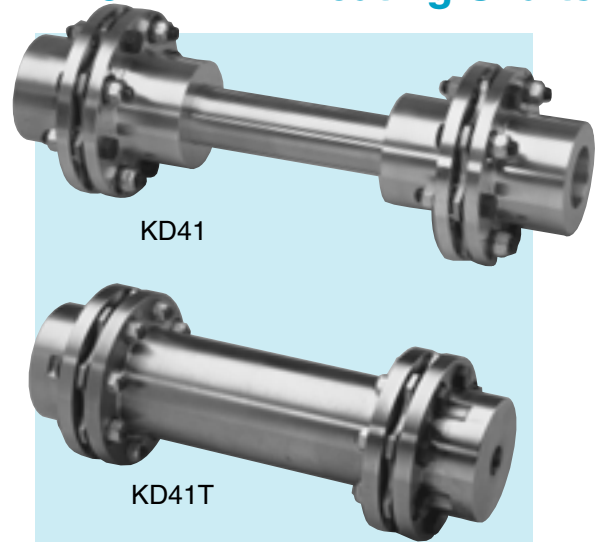

- Heavy Duty, Larger Sizes
- Economical Solid or Tubular Floating Shafts
- Drop-Out, Unitized Disc Packs

KD41 Couplings use HT Disc Packs.

Complete Couplings

Complete KD41 and KD41T Couplings are made to order. Contact your local EPT representative to order.

Component Parts

Description	Part Number
Standard Hub	SHUB
Long Hub	LHUB
*HT Disc Pack	HTDP
*HT Disc Pack Fastener Set	HTFS

* For Disc Pack Components, do not include "Series" number in part number.

How to Order Components

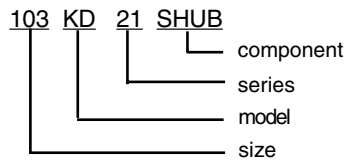

How to Order Disc Pack Components

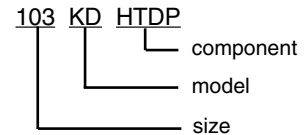

Note: KD21 Hubs are used for KD41 and KD41T floating shaft couplings.

Dimensional Data

Size	A (in)	C (in)	E (in)	G (in)	Typical	
					H (in)	T (in)
103	3.94	.31	1.66	2.57	1.50	2.36
153	5.38	.39	1.94	3.54	1.88	3.15
204	6.38	.50	2.38	4.32	2.62	3.62
254	7.62	.57	3.00	5.34	3.00	4.39
304	9.00	.65	3.56	6.16	3.50	5.67
354	10.50	.81	4.13	6.99	4.25	6.38
404	11.75	.88	4.63	7.91	4.75	6.75
454	12.75	.94	5.25	8.83	5.25	7.75
504	13.88	1.09	5.88	9.62	5.75	8.00
554	15.12	1.22	7.16	10.48	6.25	8.50
604	16.50	1.32	7.66	11.33	6.75	9.25
705	20.50	1.56	9.00	14.07	8.50	11.50
805	23.00	1.84	10.13	15.73	9.50	12.50
905	25.50	1.76	11.81	17.88	11.00	15.50



Visit www.kopflex.com

Ordering Instructions: When ordering floating shaft couplings, be sure to include hp and rpm, shaft separation, and equipment shaft sizes. Applications with very large shaft separations and/or high speeds may require tubular floating shafts due to lateral critical speed considerations.

Important: Care must be exercised in proper selection of any shaft coupling. The Users must assure themselves that the design of the hub to shaft connection is adequate for the duty intended.

Selection Data

Size	Max. Bore (in)	Coupling Rating (HP/100 RPM)	Torque Rating		Total ^① Weight (lbs)	Total ^① WR ² (lb-in ²)	Axial Capacity (in)
			Continuous (in-lb)	Peak (in-lb)			
103	1.75	6.3	4000	8000	10.4	19	±.080
153	2.50	21.6	13600	27200	22.8	77	±.140
204	3.00	57.1	36000	72000	48.2	247	±.110
254	3.75	82.5	52000	104000	64.5	425	±.140
304	4.50	141	89000	178000	101	925	±.170
354	5.00	238	150000	300000	157	1960	±.200
404	5.50	340	215000	430000	237	3760	±.225
454	6.38	405	255000	510000	299	5550	±.250
504	7.00	570	360000	720000	395	8750	±.275
554	7.75	800	505000	1010000	554	14500	±.300
604	8.50	1050	660000	1320000	697	21700	±.320
705	10.75	2400	1510000	3020000	1250	61000	±.270
805	12.00	3670	2310000	4620000	1830	114000	±.310
905	13.50	4130	2600000	5200000	2510	190000	±.400

① Data for two flex units with maximum bores. Weight and WR² values do not include floating shaft or tube.

KD41

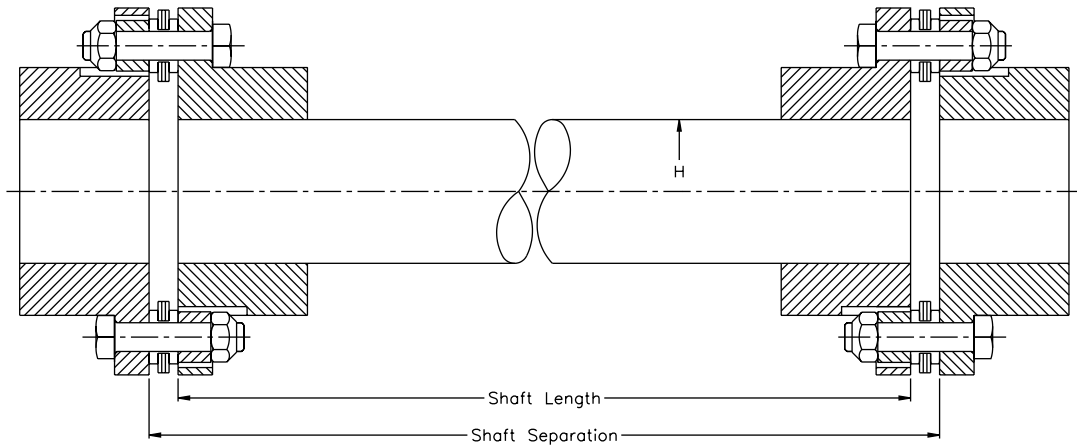

KD41T

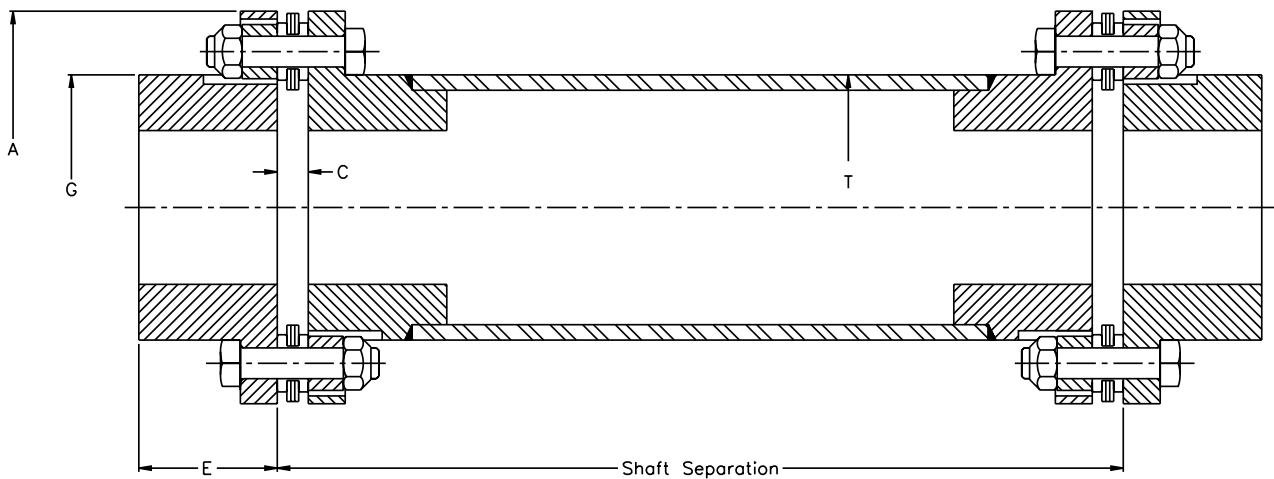

Ordering Instructions: When ordering floating shaft couplings, be sure to include hp and rpm, shaft separation, and equipment shaft sizes. Applications with very large shaft separations and/or high speeds may require tubular floating shafts due to lateral critical speed considerations.

Important: Care must be exercised in proper selection of any shaft coupling. The Users must assure themselves that the design of the hub to shaft connection is adequate for the duty intended.

KD42 & KD42T Floating Shafts

The KD42 coupling is designed as a non-lubricated, drop-in replacement to gear coupling floating shafts. The standard bolt flanges of the KD42 allow the center gear coupling section to be dropped out, leaving rigid hubs in place on the equipment shafts to accept the low maintenance disc coupling shaft section.

The power capacity of the KD42 coupling is the highest in the industry, allowing the easiest conversion from a lubricated coupling to a low maintenance disc coupling. Existing solid shafts can be reused by simply machining the shaft ends to retrofit new disc couplings and dropping the new assembly in place on the rigid hubs.

The KD42 floating shaft coupling uses two flexible half couplings mounted on a solid center shaft, simplifying installation or maintenance. The unitized disc packs, close tolerance bolts and safety overload washers provide superior performance and trouble-free zero backlash operation.

For lighter weight or higher stiffness, a tubular floating shaft design is available. The KD42T has all of the features of the KD42, but with a tubular shaft. For a more economical floating shaft, consider a KD41 disc coupling. For a lower power application, consider the KD51 disc coupling.

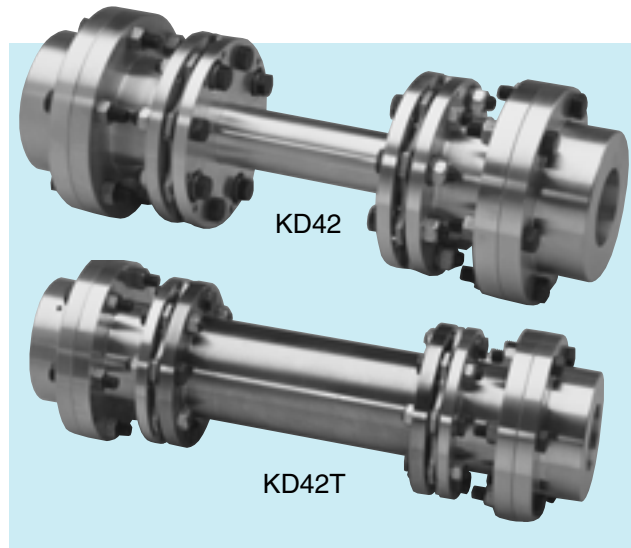

- Direct Gear Coupling Replacement
- Heavy Duty, Larger Sizes
- Solid or Tubular Floating Shafts
- Drop-Out Shaft Section

KD42 Couplings use HT Disc Packs.

Complete Couplings

Complete KD42 and KD42T couplings are supplied without rigid hubs and rigid flange fastener sets. See Gear Rigid Data chart for rigid and fastener part numbers.

Complete KD42 and KD42T couplings are made to order. Contact your local EPT representative to order.

Component Parts

Description	Part Number
Standard Hub	SHUB
*Flex Half	FH
**HT Disc Pack Assembly	HTDP
**HS Disc Pack Fastener Set	HSFS

* Flex Halves are designated by disc/gear size, and include (1) disc pack and (1) disc pack fastener set.

** For Disc Packs Components, do not include "Series" number in the part number.

How to Order Hubs

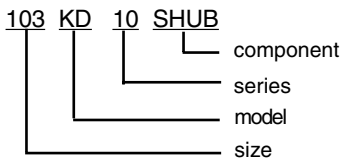

Note: KD10 Hubs are used for KD42 Floating Shaft Couplings.

How to Order Flex Halves

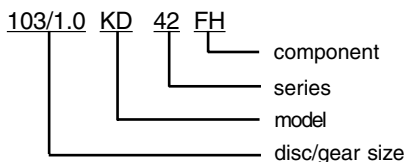

Note: See Interchange Chart for standard and optional sizes.

How to Order Disc Pack Components

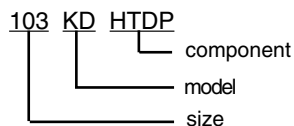

Interchange Chart - Gear to Disc Type Floating Shaft Coupling

GEAR SIZE	DISC COUPLING SIZE													
	103	153	204	254	304	354	404	454	504	554	604	705	805	905
1	•													
1 1/2		•												
2			•											
2 1/2				•										
3					•									
3 1/2						•								
4							•							
4 1/2								•						
5									•					
5 1/2										•				
6											•			
7												•		
8													•	
9														•
10														

• Denotes standard sizes. Shaded blocks are available options.

Gear Rigid Data

Gear Rigid Size	Max Bore (in)	A _R (in)	B _R (in)	E _R (in)	BC (in)	C' Bore	Flange Bolts- UNC (in)	Gear Rigid	Flange Fastener Set
1	2.25	4.56	1.66	1.56	3.75	.09	6 x 1/4	1 RHUB	1 EB FS
1 1/2	2.69	6.00	1.94	1.84	4.81	.09	8 x 3/8	1 1/2 RHUB	1 1/2 EB FS
2	3.38	7.00	2.38	2.28	5.88	.09	6 x 1/2	2 RHUB	2 EB FS
2 1/2	4.00	8.38	3.00	2.91	7.12	.09	6 x 5/8	2 1/2 RHUB	2 1/2 EB FS
3	4.75	9.44	3.56	3.47	8.12	.09	8 x 5/8	3 RHUB	3 EB FS
3 1/2	5.50	11.00	4.12	4.03	9.50	.09	8 x 3/4	3 1/2 RHUB	3 1/2 EB FS
4	6.38	12.50	4.62	4.44	11.00	.19	8 x 3/4	4 RHUB	4 EB FS
4 1/2	7.25	13.62	5.25	5.06	12.00	.19	10 x 3/4	4 1/2 RHUB	4 1/2 EB FS
5	8.50	15.31	5.88	5.69	13.50	.19	8 x 7/8	5 RHUB	5 EB FS
5 1/2	8.00	16.75	7.16	6.97	14.50	.19	14 x 7/8	5 1/2 RHUB	5 1/2 EB FS
6	8.75	18.00	7.66	7.47	15.75	.19	14 x 7/8	6 RHUB	6 EB FS
7	10.00	20.75	9.00	8.75	18.25	.25	16 x 1	7 RHUB	7 EB FS
8	11.00	23.25	10.12	9.81	20.75	.31	16 x 1 1/8	8 RHUB	8 EB FS
9	12.75	26.00	11.19	10.88	23.25	.31	18 x 1 1/4	9 RHUB	9 EB FS
10	13.50	28.00	12.38	12.00	25.25	.38	18 x 1 3/8	10 RHUB	10 EB FS

Selection Data

Size	Flex Max Bore (in)	Continuous Rating HP/100 RPM	Torque Rating		Axial Capacity (in)	A _F (in)	B _F (in)	E _F (in)	Typical	
			Continuous (in-lb)	Peak (in-lb)					H ⁽²⁾ (in)	T (in)
103	1.50	6.3	4000	8000	±.080	3.94	2.35	1.69	1.50	2.36
153	2.12	21.6	13600	27200	±.140	5.38	3.16	2.12	1.88	3.15
204	2.62	57.1	36000	72000	±.110	6.38	4.04	2.75	2.62	3.62
254	3.25	82.5	52000	104000	±.140	7.62	4.44	3.03	3.00	4.39
304	3.75	141	89000	178000	±.170	9.00	5.00	3.59	3.50	5.67
354	4.25	238	150000	300000	±.200	10.50	5.79	4.38	4.25	6.38
404	4.75	340	215000	430000	±.225	11.75	6.62	5.19	4.75	6.75
454	5.50	405	255000	510000	±.250	12.75	6.74	5.31	5.25	7.75
504	5.75	570	360000	720000	±.275	13.88	7.46	6.03	5.75	8.00
554	6.25	800	505000	1010000	±.300	15.12	8.47	6.91	6.25	8.50
604	6.75	920	640000	1280000	±.320	16.50	8.22	7.41	6.75	9.25
705	8.50	1840	1280000	2560000	±.270	20.50	9.50	8.69	8.50	11.50
805	9.50	2230	1780000	3560000	±.310	23.00	11.00	9.81	9.50	12.50
905	11.50	4130	2600000	5200000	±.400	25.50	11.82	10.88	11.00	15.50

KD 42

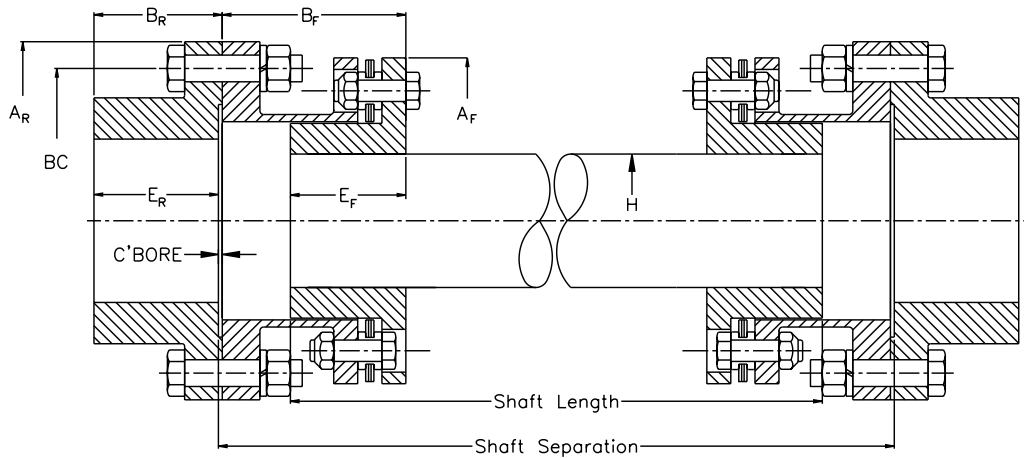

KD42T

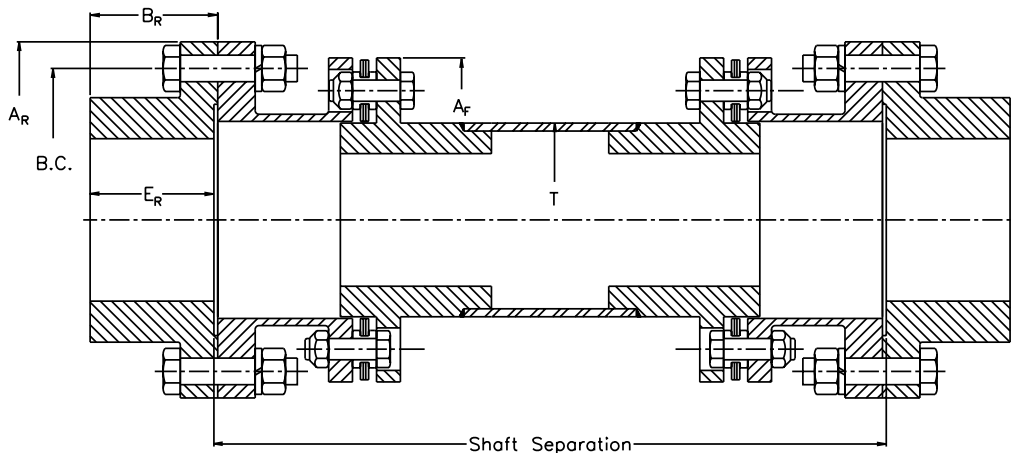

Ordering Instructions: When ordering floating shaft couplings, be sure to include hp and rpm, shaft separation, and equipment shaft sizes. Applications with very large shaft separations and/or high speeds may require tubular floating shafts due to lateral critical speed considerations.

Important: Care must be exercised in proper selection of any shaft coupling. The Users must assure themselves that the design of the hub to shaft connection is adequate for the duty intended.

Selection Data

Size	Continuous Rating HP/100 RPM	Torque Rating		A _F (in)	B _F (in)	T (in)	Total Slide (in)	Axial Adjustment (in)
		Continuous (in-lb)	Peak (in-lb)					
204	57.1	36000	72000	6.38	4.04	3.62	4.33	±1.50
254	82.5	52000	104000	7.62	4.44	4.09	4.33	±1.50
304	141	89000	178000	9.00	5.00	5.67	4.33	±1.50
354	238	150000	300000	10.50	5.79	5.67	4.33	±1.50
404	340	215000	430000	11.75	6.62	6.50	4.33	±1.50
454	405	255000	510000	12.75	6.74	6.50	4.33	±1.50
504	570	360000	720000	13.88	7.46	8.58	5.31	±2.00
554	800	505000	1010000	15.12	8.47	8.58	5.31	±2.00

Refer to Page 48 for Flange Connection Data.

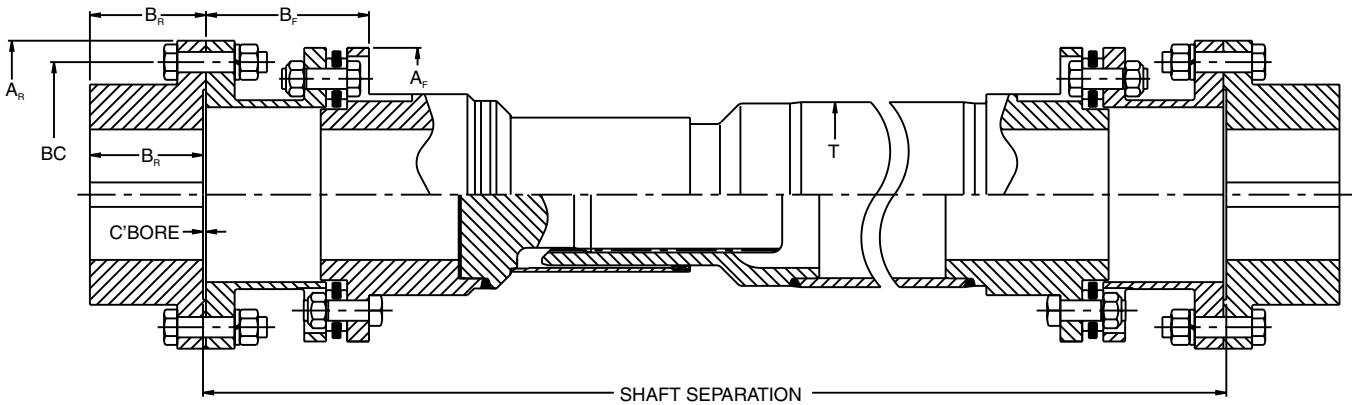

Interchange Chart - Gear to Disc Type Floating Shaft Coupling

GEAR SIZE	DISC COUPLING SIZE													
	103	153	204	254	304	354	404	454	504	554	604	705	805	905
1	•													
1 1/2		•												
2			•											
2 1/2				•										
3					•									
3 1/2						•								
4							•							
4 1/2								•						
5									•					
5 1/2										•				
6											•			
7												•		
8													•	
9														•
10														

• Denotes standard sizes. Shaded blocks are available options.



Visit www.kopflex.com

The KD5 coupling is designed for light to medium duty applications **requiring only angular misalignment capacity** as in three bearing installations or floating shaft arrangements.

Consisting of three main parts, two hubs and a disc pack, the KD5 simplifies installation or maintenance. The close tolerance bolts and safety overload washers provide superior performance.

For complete floating shaft assemblies, consider a KD51 disc coupling. For higher power requirements, consider a KD4 single flex disc coupling.

KD5 Couplings use LT Disc Packs.

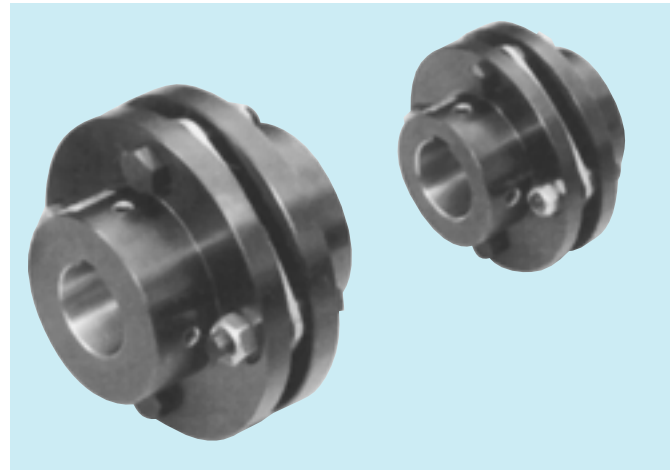

- Angular Misalignment Capacity
- Light and Medium Duty
- Most Economical
- Non-Unitized Disc Packs

Complete Couplings

Coupling Size	Complete Coupling with 2 Std. Hubs	
	Rough Bore	Finish Bore
022	022 KD 5 SS	022 KD 5 SS FB
042	042 KD 5 SS	042 KD 5 SS FB
072	072 KD 5 SS	072 KD 5 SS FB
092	092 KD 5 SS	092 KD 5 SS FB
102	102 KD 5 SS	102 KD 5 SS FB
132	132 KD 5 SS	132 KD 5 SS FB
162	162 KD 5 SS	162 KD 5 SS FB
212	212 KD 5 SS	212 KD 5 SS FB
252	252 KD 5 SS	252 KD 5 SS FB
292	292 KD 5 SS	292 KD 5 SS FB
322	322 KD 5 SS	322 KD 5 SS FB
362	362 KD 5 SS	362 KD 5 SS FB

Component Parts

Description	Part Number
Standard Hub	SHUB
*LT Parts Kit	LTPK
*LT Disc Pack Fastener Set	LTFS

* For Disc Packs Components, do not include "Series" number in the part number.

How to Order Components

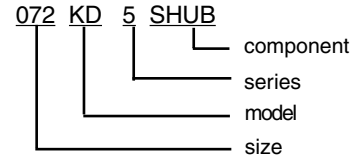

How to Order Disc Pack Components

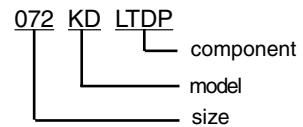

Coupling Size	Stock Bores																											
	1/2	5/8	3/4	7/8	1	1 1/16	1 3/16	1 1/4	1 3/8	1 7/16	1 1/2	1 5/8	1 3/4	1 7/8	1 15/16	2	2 1/8	2 3/16	2 1/4	2 3/8	2 7/16	2 1/2	2 5/8	2 11/16	2 3/4	2 7/8	2 15/16	
022	X	X	X																									
042	X	X	X	X																								
072		X	X	X	X	X	X	X																				
092			X	X	X	X	X	X	X																			
102				X	X	X	X	X	X	X																		
132									X	X	X	X	X	X														
162									X	X	X	X	X	X	X	X	X	X	X	X	X	X	X	X	X	X	X	X
212									X	X	X	X	X	X	X	X	X	X	X	X	X	X	X	X	X	X	X	X

Selection Data

Size	Max. Bore (in)	Coupling Rating (HP/100 RPM)	Torque Rating		Maximum Speed RPM	Total® Weight (lbs)	Total® WR ² (lb-in ²)	Axial Capacity (in)
			Continuous (in-lb)	Peak (in-lb)				
022	0.75	0.28	175	350	20000	0.73	0.4	±.030
042	0.94	0.56	350	700	20000	1.32	0.7	±.030
072	1.31	1.4	870	1740	20000	1.87	2.1	±.039
092	1.38	2.5	1570	3140	18000	2.86	4.2	±.047
102	1.69	3.4	2170	4340	15000	4.19	7.3	±.055
132	2.00	6.2	3900	7800	13000	9.48	19	±.062
162	2.31	11.0	6950	13900	12000	15.2	40	±.070
212	2.88	17.9	11300	22600	10000	25.4	90	±.098
252	3.31	28.9	18200	36400	8000	36.2	180	±.105
292	3.75	46.8	29500	59000	7500	61.7	300	±.125
322	4.38	74.6	47000	94000	3400	72.8	600	±.150
362	4.75	96.8	61000	122000	3100	81.6	1100	±.157

① Data based on maximum bores.

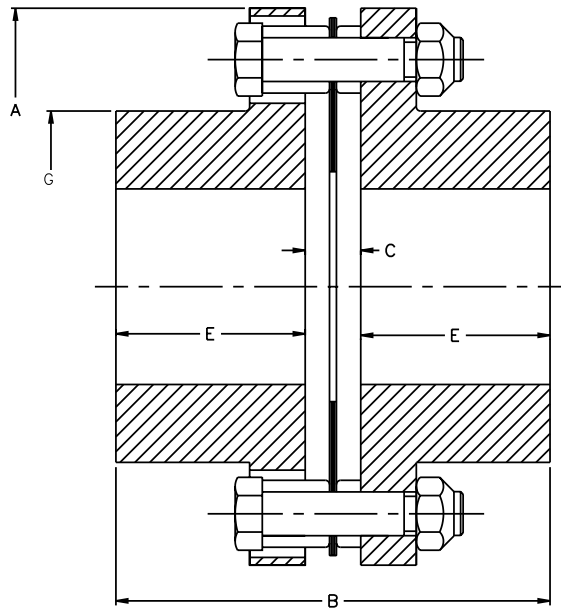

Size	A (in)	B (in)	C (in)	E (in)	G (in)
022	2.24	1.80	0.22	0.79	1.26
042	2.66	2.24	0.24	1.00	1.34
072	3.19	2.26	0.26	1.00	1.85
092	3.66	2.59	0.33	1.13	1.93
102	4.09	3.08	0.44	1.32	2.36
132	4.96	3.70	0.46	1.62	2.80
162	5.62	4.22	0.46	1.88	3.31
212	6.61	5.16	0.66	2.25	4.17
252	7.64	5.67	0.67	2.50	4.65
292	8.43	6.85	0.85	3.00	5.39
322	9.69	7.94	0.94	3.50	6.14
362	10.87	9.07	1.07	4.00	6.65



Visit www.kopflex.com

The KD50 coupling is designed for light and medium duty applications requiring moderate shaft separations. The minimal number of components yields an economical disc coupling solution to spacer applications.

Consisting of two hubs, a center spacer, and two disc packs, the KD50 simplifies installation and maintenance. The disc packs and close tolerance bolts provide good dynamic balance. AGMA Class 8 is standard, as-manufactured. The close tolerance bolts and safety overload washers provide superior performance.

For higher power requirements, consider a KD21 disc coupling. For longer spans, consider a KD51 floating shaft coupling.

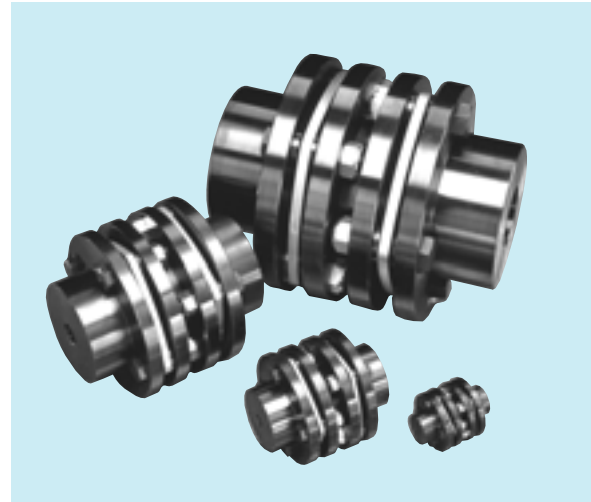

KD50 Couplings use LT Disc Packs.

- Light to Medium Duty
- Smaller Sizes
- Economical Spacer Series
- Standard Shaft Separations
- Non-Unitized Disc Packs

Complete Couplings

Coupling Size	Between Shaft Ends	Complete Coupling with 2 Std. Hubs	
		Rough Bore	Finish Bore
022	0.98	022 KD 50 SS096	022 KD 50 SS096 FB
	1.42	042 KD 50 SS142	042 KD 50 SS142 FB
072	1.54	072 KD 50 SS154	072 KD 50 SS154 FB
	3.50	072 KD 50 SS350	072 KD 50 SS350 FB
092	1.85	092 KD 50 SS185	092 KD 50 SS185 FB
	3.50	092 KD 50 SS350	092 KD 50 SS350 FB
	4.38	092 KD 50 SS438	092 KD 50 SS438 FB
	5.00	092 KD 50 SS500	092 KD 50 SS500 FB
102	2.09	102 KD 50 SS209	102 KD 50 SS209 FB
	3.50	102 KD 50 SS350	102 KD 50 SS350 FB
	4.88	102 KD 50 SS468	102 KD 50 SS468 FB
	5.00	102 KD 50 SS500	102 KD 50 SS500 FB
	7.00	102 KD 50 SS700	102 KD 50 SS700 FB
132	2.44	132 KD 50 SS244	132 KD 50 SS244 FB
	3.50	132 KD 50 SS350	132 KD 50 SS350 FB
	4.38	132 KD 50 SS438	132 KD 50 SS438 FB
	5.00	132 KD 50 SS500	132 KD 50 SS500 FB
	7.00	132 KD 50 SS700	132 KD 50 SS700 FB

Coupling Size	Between Shaft Ends	Complete Coupling with 2 Std. Hubs	
		Rough Bore	Finish Bore
162	2.72	162 KD 50 SS272	162 KD 50 SS272 FB
	4.38	162 KD 50 SS438	162 KD 50 SS438 FB
	5.00	162 KD 50 SS500	162 KD 50 SS500 FB
	5.50	162 KD 50 SS550	162 KD 50 SS550 FB
	7.00	162 KD 50 SS700	162 KD 50 SS700 FB
212	3.07	212 KD 50 SS307	212 KD 50 SS307 FB
	5.00	212 KD 50 SS500	212 KD 50 SS500 FB
	5.50	212 KD 50 SS550	212 KD 50 SS550 FB
	7.00	212 KD 50 SS700	212 KD 50 SS700 FB
252	3.50	252 KD 50 SS350	252 KD 50 SS350 FB
	5.50	252 KD 50 SS550	252 KD 50 SS550 FB
	7.00	252 KD 50 SS700	252 KD 50 SS700 FB
292	3.82	292 KD 50 SS382	292 KD 50 SS382 FB
	5.50	292 KD 50 SS550	292 KD 50 SS550 FB
	7.00	292 KD 50 SS700	292 KD 50 SS700 FB
322	4.29	322 KD 50 SS429	322 KD 50 SS429 FB
	8.00	322 KD 50 SS800	322 KD 50 SS800 FB
362	5.28	362 KD 50 SS528	362 KD 50 SS528 FB
	9.00	362 KD 50 SS900	362 KD 50 SS900 FB

Component Parts

Description	Part Number
Standard Hub	SHUB
*LT Disc Pack	LTDP
*LT Disc Pack Fastener Kit	LTFS

How to Order Components

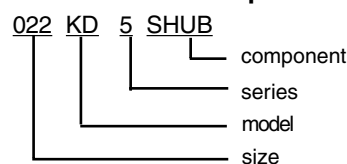

How to Disc Pack Components

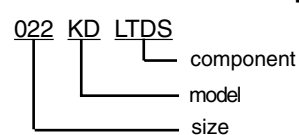

* For Disc Packs Components, do not include "Series" number in the part number.

Note: KD5 Hubs are used on KD50 Couplings.



Visit www.kopflex.com

Selection Data

Size	Max. Bore (in)	Coupling Rating (HP/100 RPM)	Max.Torque Rating		Maximum Speed RPM	Total Weight (lbs)	Total WR ² (lb-in ²)	Axial Capacity (in)
			Continuous (in-lb)	Peak (in-lb)				
022	0.75	0.28	175	350	20000	1.0	0.6	±.063
042	0.94	0.56	350	700	20000	2.4	1.5	±.063
072	1.31	1.4	870	1740	20000	3.7	4.0	±.079
092	1.38	2.5	1570	3140	18000	8.7	8.3	±.094
102	1.69	3.4	2170	4340	15000	8.1	14	±.110
132	2.00	6.2	3900	7800	13000	14.5	32	±.126
162	2.31	11.0	6950	13900	12000	22.7	66	±.142
212	2.88	17.9	11300	22600	10000	35.4	140	±.197
252	3.31	28.9	18200	36400	8000	51.0	280	±.213
292	3.75	46.8	29500	59000	7500	88.4	470	±.260
322	4.38	74.6	47000	94000	3400	121.0	1000	±.299
362	4.75	96.8	61000	122000	3100	132.0	2000	±.315

① Data based on maximum bores.

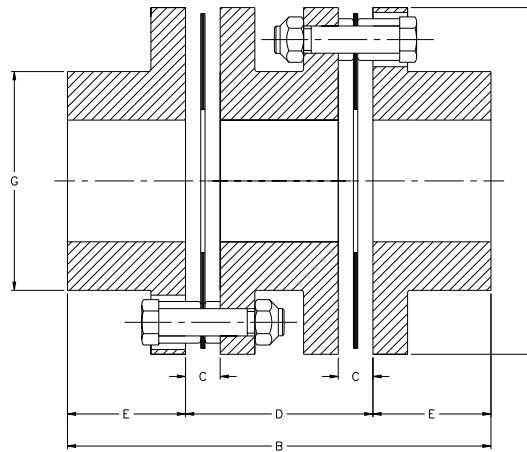

Size	A	B	C	D Standard	E	G	Stock "D" Dimension (in)							
							3 1/2	4 3/8	5	5 1/2	7	8	9	
022	2.24	2.54	0.22	0.96	0.79	1.26								
042	2.66	3.42	0.24	1.42	1.00	1.34								
072	3.19	3.54	0.26	1.54	1.00	1.85	X							
092	3.66	4.11	0.33	1.85	1.12	1.93	X	X	X					
102	4.09	4.73	0.44	2.09	1.32	2.36	X	X	X		X			
132	4.96	5.68	0.46	2.44	1.62	2.80	X	X	X		X			
162	5.62	6.48	0.46	2.72	1.88	3.31		X	X	X	X			
212	6.61	7.57	0.66	3.07	2.25	4.17			X	X	X			
252	7.64	8.50	0.67	3.50	2.50	4.65			X	X	X			
292	8.43	9.82	0.85	3.82	3.00	5.39			X	X	X			
322	9.69	11.29	0.94	4.29	3.50	6.14							X	
362	10.87	13.28	1.07	5.28	4.00	6.65								X

Coupling Size	Stock Bores																											
	1/2	5/8	3/4	7/8	1	1 1/16	1 3/16	1 1/4	1 3/8	1 7/16	1 1/2	1 5/8	1 3/4	1 7/8	1 15/16	2	2 1/8	2 3/16	2 1/4	2 3/8	2 7/16	2 1/2	2 5/8	2 11/16	2 3/4	2 7/8	2 15/16	
022	X	X	X																									
042	X	X	X	X																								
072		X	X	X	X	X	X	X																				
092			X	X	X	X	X	X	X																			
102				X	X	X	X	X	X	X	X																	
132									X	X	X	X	X	X														
162									X	X	X	X	X	X	X	X	X	X	X	X	X	X	X	X	X	X	X	X
212														X	X	X	X	X	X	X	X	X	X	X	X	X	X	X

The KD51 & KD51T couplings are designed for light and medium duty applications requiring longer shaft separations. The minimal number of components yields an economical disc coupling solution to floating shaft applications.

The KD51 floating shaft coupling uses two single flex halves in conjunction with a solid center shaft, which installs or drops out simplifying installation or maintenance. The KD51T uses a tubular floating shaft for lighter weight. The close tolerance bolts and safety overload washers provide superior performance.

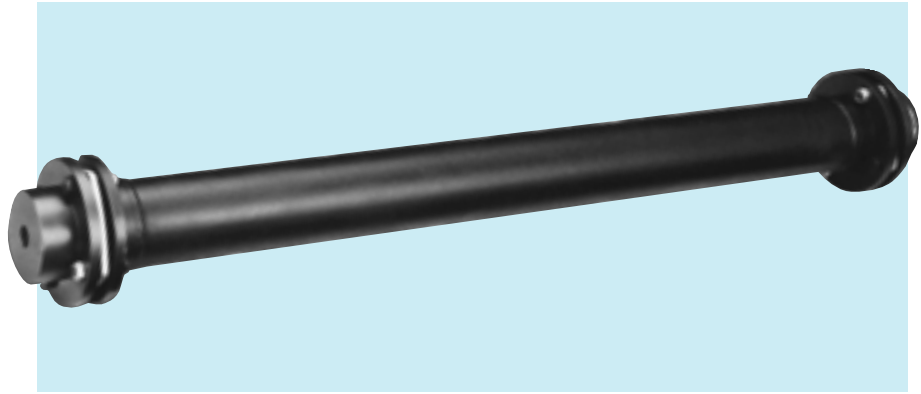

- Light to Medium Duty
- Smaller Sizes
- Economical Floating Shaft Series
- Non-Unitized Disc Packs

For higher power applications, consider a KD41 floating shaft disc coupling.

KD51 Couplings use Non-Unitized LT Disc Packs.

Coupling Size	Stock Bores																											
	1/2	5/8	3/4	7/8	1	1 1/16	1 3/16	1 1/4	1 3/8	1 7/16	1 1/2	1 5/8	1 3/4	1 7/8	1 15/16	2	2 1/8	2 3/16	2 1/4	2 3/8	2 7/16	2 1/2	2 5/8	2 11/16	2 3/4	2 7/8	2 15/16	
022	X	X	X																									
042	X	X	X	X																								
072		X	X	X	X	X	X	X																				
092				X	X	X	X	X	X																			
102					X	X	X	X	X	X	X	X																
132									X	X	X	X	X	X														
162									X	X	X	X	X	X	X													
212									X	X	X	X	X	X	X	X	X	X	X	X	X	X	X	X	X	X	X	X

Complete Couplings

Complete KD51 and KD51T couplings are made to order. Contact your local EPT representative to order.

Component Parts

Description	Part Number
Standard Hub	SHUB
*LT Disc Pack	LTDP
*LT Disc Pack Fastener Set	LTFS

* For Disc Packs Components, do not include "Series" number in the part number.

How to Order Components

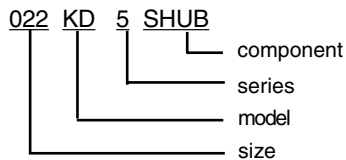

How to Order Disc Pack Components

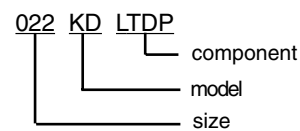

Note: KD5 Hubs are used on KD51 and KD51T Couplings.



Visit www.kopflex.com

Selection Data

Size	Max. Bore (in)	Coupling Rating (HP/100 RPM)	Max. Torque Rating		Total ^① Weight (lbs)	Total ^① WR ² (lb-in ²)	Axial Capacity (in)
			Continuous (in-lb)	Peak (in-lb)			
022	0.75	0.28	1.75	350	1.46	0.8	±.063
042	0.94	0.56	350	700	2.64	1.4	±.063
072	1.31	1.4	870	1740	3.76	4.2	±.079
092	1.38	2.5	1570	3140	5.72	8.4	±.094
102	1.69	3.4	2170	4340	8.38	14.6	±.110
132	2.00	6.2	3900	7800	19.96	38	±.126
162	2.31	11.0	6950	13900	30.4	80	±.142
212	2.88	17.9	11300	22600	50.8	180	±.197
252	3.31	28.9	18200	36400	72.4	360	±.213
292	3.75	46.8	29500	59000	123.4	600	±.260
322	4.38	74.6	47000	94000	145.6	1200	±.299
362	4.75	96.8	61000	122000	163.2	2200	±.315

① Data for two flex units with maximum bores. Weight and WR² values do not include floating shaft or tube.

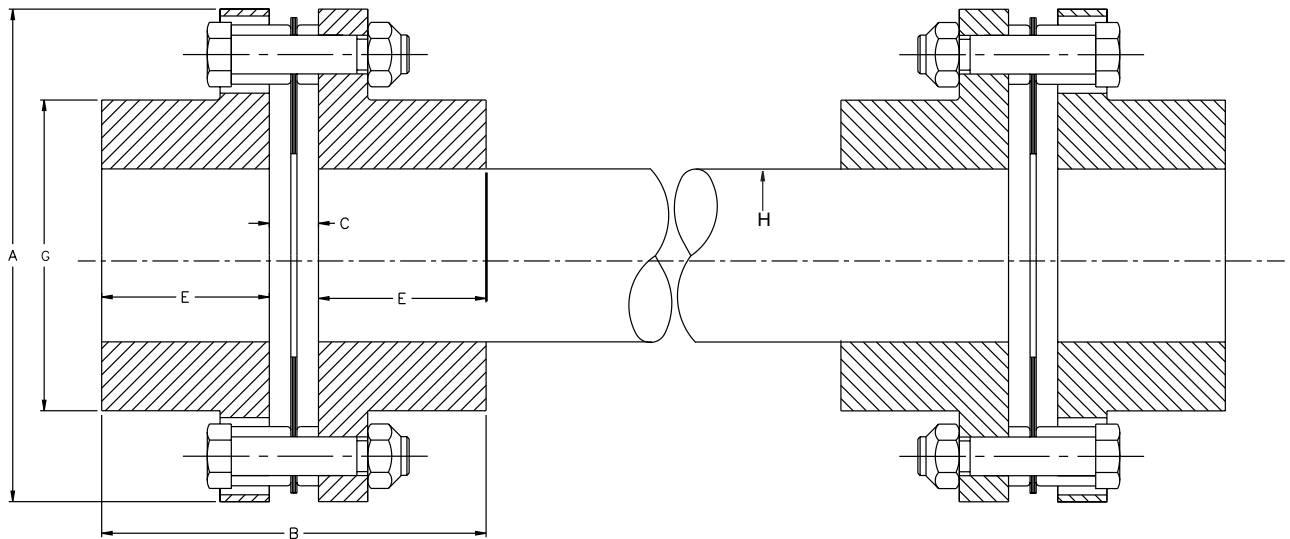

Size	A (in)	C (in)	E (in)	G (in)	Typical H (in)
022	2.24	0.2	0.79	1.26	
042	2.66	0.24	1.00	1.34	.88
072	3.19	0.26	1.00	1.85	1.25
092	3.66	0.33	1.13	1.93	1.25
102	4.09	0.44	1.32	2.36	1.50
132	4.96	0.46	1.62	2.80	1.88
162	5.63	0.46	1.88	3.31	2.25
212	6.61	0.66	2.25	4.17	2.75
252	7.64	0.67	2.50	4.65	3.25
292	8.43	0.85	3.00	5.39	3.50
322	9.69	0.94	3.50	6.14	4.25
362	10.87	1.07	4.00	6.65	4.50

HIGH PERFORMANCE COUPLINGS

KOP-FLEX®

HIGH PERFORMANCE DISC COUPLINGS...

Available In Four Standard Styles...

Designed And Manufactured To Meet API 671 As Standard

These couplings are engineered to accommodate a broad range of demanding operating conditions: boiler feed pumps, centrifugal and axial compressors, generator sets, test stands, gas and steam turbines, marine drives, etc.

The HP disc coupling is the preferred choice for demanding turbomachinery applications. Superior quality and a wide variety of standard and custom designs backed by unsurpassed engineering expertise make KOP-FLEX the industry leader.

- Inherent fail-safe designs
- KOPLON* coated flexible disc elements for maximum life
- Factory assembled
- Greatest reduced moment available
- Dynamically balanced

High Performance Flexible Diaphragm Couplings

The patented Flexible Diaphragm Coupling from KOP-FLEX® brand couplings transmits torque from the driving shaft via a rigid hub, then through a flexible diaphragm to a spacer. The diaphragm deforms while transmitting this torque to accommodate misalignment. The spacer in turn drives matching components attached to the driven equipment. Outstanding design features include:

- Field-replaceable Stockable Diaphragms
- Specially-Contoured One-Piece Diaphragm Design
- Patented Diaphragm Shape
- Piloted Fits
- Diaphragms are 15.5 PH Shot-Peened Stainless Steel
- Inherently Low Windage Design
- Conforms To API 671 Specifications

High Performance Gear Couplings

- Thousands in Service
- Choose From Straight or Crowned Nitrided Gear Teeth, Depending on your Application
- Precision Lapped Teeth, if Required
- Heat-treated Alloy Components

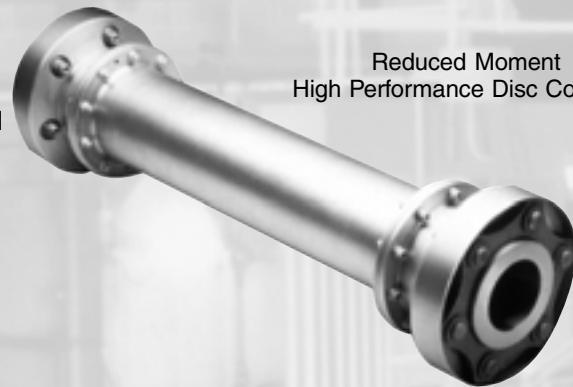

Reduced Moment
High Performance Disc Coupling



Size #5.5 MDM-J
diaphragm coupling



Size #6 Gear Coupling
G.E. MS5001 Gas Turbine Driven
Compressor Train

*KOPLON is a trademark of E. I. du Pont de Nemours and Company. This trade name, trademark and/or registered trademark is used herein for product comparison purposes only, is the property of the respective owner and is not owned or controlled by Emerson Power Transmission Corporation (EPT). EPT does not represent or warrant the accuracy of this document.

Request a copy of Catalog KHP-00 or visit www.kop-flex.com