

INDUSTRIAL BELT AND DRIVE PREVENTIVE MAINTENANCE

For a long and trouble-free service life



HIGH PERFORMANCE AND COMPREHENSIVE PRODUCT RANGE

Throughout the years, the Gates Corporation has played a key role in the creation and development of high quality belts. Gates' continuous product development has resulted in a comprehensive programme of V-belts, synchronous belts, tensioners, pulleys, flexible couplings and complete drive systems covering a multitude of applications. Typical examples are V-belts such as Predator®, Quad-Power® II, Super HC® MN, Hi-Power®, Predator® PowerBand®, Quad-Power® II PowerBand®, Polyflex® JB™ and Micro-V®.

The latest innovations in Gates' synchronous belt range are Poly Chain® GT Carbon™, the most powerful polyurethane synchronous belt in the market with patented carbon tensile cord design, designed for high torque, low speed drives, and PowerGrip® GT3 rubber synchronous belt with optimised GT tooth profile available in small as well as in large pitches, covering a wide range of industrial applications.

All Gates European Power Transmission operations are ISO 9001 and ISO 14001 accredited. The international ISO 9001 assessment covers design, development, production, installation and servicing of products and is evidence of Gates' solid commitment to quality. Gates also achieved the ISO 14001 standard by demonstrating that environmental issues and protection are managed within a coordinated framework of controls and well-defined procedures.

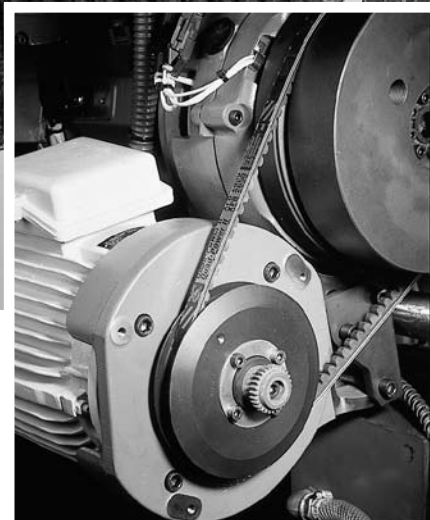
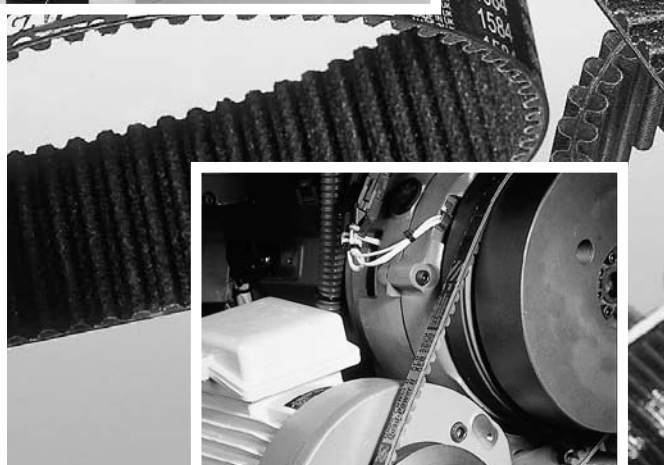
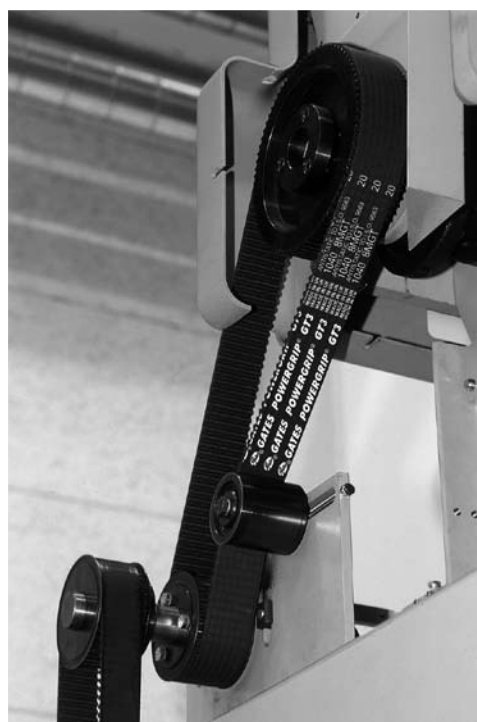
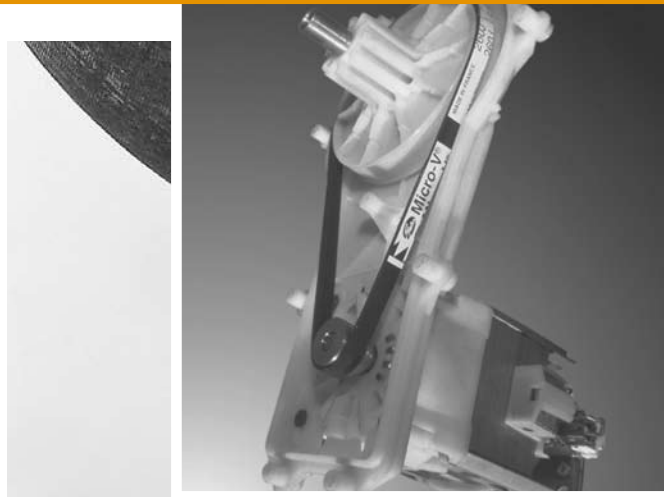



GATES COST SAVING PROGRAMME

The Gates cost saving programme includes plant surveys to evaluate current belt drive efficiencies and the calculation of concrete cost saving opportunities for a specific drive.

For more information on this subject, see page 58. On page 61 you will find an inquiry sheet for an expertise of your machine park.

- I. Introduction**
 - 1. Why preventive maintenance? 2
 - 2. Components of a good maintenance programme 2
- II. A safe working environment** 3
- III. Preventive “routine” maintenance**
 - 1. Simple drive inspection 4
 - 2. Frequency of inspection 4
 - 3. When to perform preventive maintenance 4
- IV. Drive shutdown and thorough inspection**
 - 1. Guard inspection 5
 - 2. Belt inspection 5
 - 3. Pulley inspection 6
 - 4. Check alignment tolerances 6
 - 5. Check other drive components 6
 - 6. Check belt tension 7
- V. Belt and pulley installation**
 - 1. V-belt installation 9
 - 2. Synchronous belt installation 10
 - 3. Pulley installation and alignment 10
- VI. Belt identification**
 - 1. Industrial belt types 11
 - 2. Sections and nominal dimensions: V-belts 22
 - 3. Sections and nominal dimensions: synchronous belts 25
- VII. Cross-reference list: V-belts** 28
- VIII. Cross-reference list: synchronous belts** 30
- IX. Belt drive performance evaluation**
 - 1. Upgrading drive performance 32
 - 2. Improving poor drive performance 32
- X. Troubleshooting guide: V-belts**
 - 1. Problems on V-belt drives 33
 - 2. Problem/cause/solution table 34
- XI. Troubleshooting guide: synchronous belts**
 - 1. Problems on synchronous belt drives 38
 - 2. Problem/cause/solution table 39
- XII. Troubleshooting methods and tools**
 - 1. Eyes, ears, nose and hands 41
 - 2. Squirt bottle with soapy water 41
 - 3. Ball of string 41
 - 4. Belt and sheave gauge 41
 - 5. Long straight edge 41
 - 6. MRO engineering tool bag 41
- XIII. Belt storage**
 - 1. General guidelines 43
 - 2. Methods of storage 43
 - 3. Effects of storage 43
- XIV. Technical data** 44
- XV. Support** 58

I. INTRODUCTION

1. Why preventive maintenance?

When compared to chain drives (with constant lubrication problems), or gear drives (with mechanical problems and high costs), belt drives are the most cost-effective and reliable means of power transmission. This reliability can however only be obtained when belts and drives are properly maintained.

The potential for long service life is built into every Gates belt. When coupled to a regular maintenance programme, your belts and drives will run relatively trouble-free for a long period of time. Always inspect belts and drives before they fail. This will reduce costly downtime and production delays.

This manual has been designed as a guide to help you install and maintain Gates industrial belts, including standard V-belts, multi-ribbed belts and synchronous belts. Through proper installation and maintenance, the service life of your belt drives will dramatically improve — reducing downtime and production standstills.

Sources of drive problems

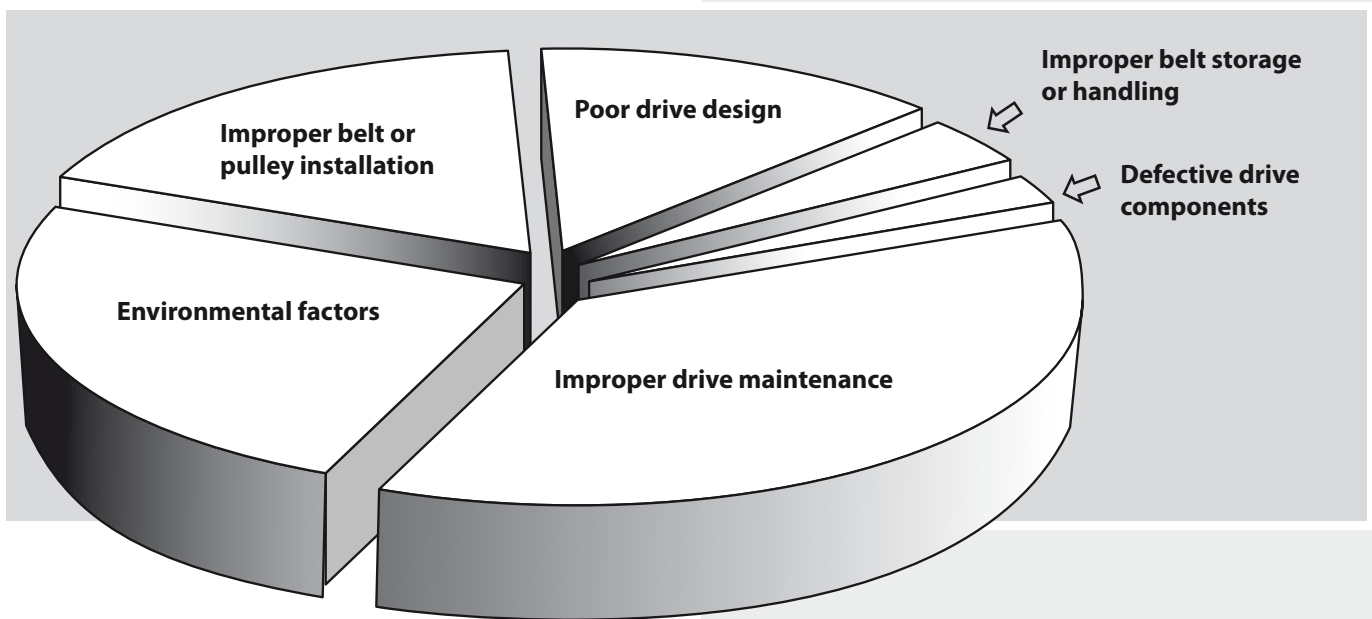

2. Components of a good maintenance programme

A complete and effective maintenance programme should include following elements:

- maintaining a safe working environment;
- regular belt drive inspections;
- proper belt installation procedures;
- belt product knowledge;
- belt drive performance evaluations;
- troubleshooting.

All these aspects will be dealt with in the different sections of this manual.

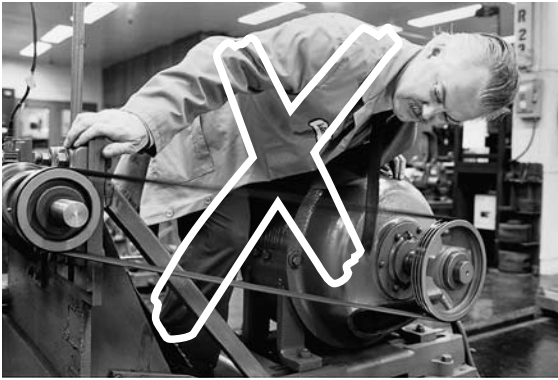

No loose or bulky clothing.

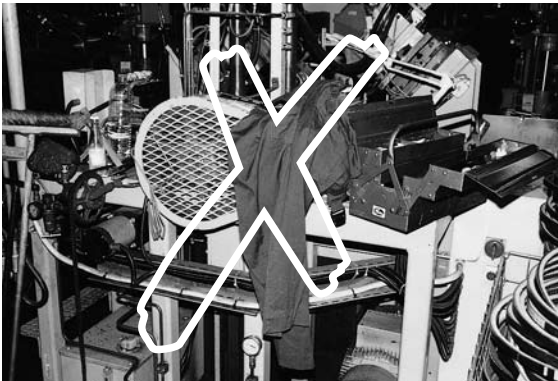

Do not clutter area around belt drive.

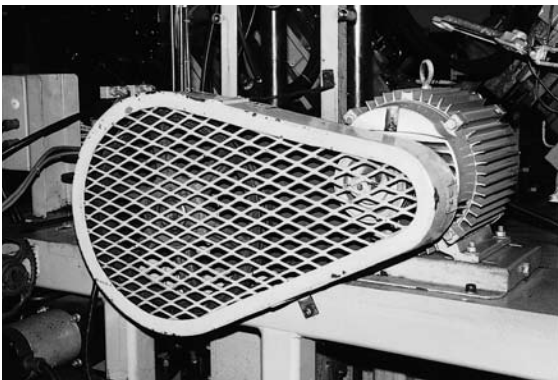

A properly guarded belt drive.

It is common sense to establish a safe working environment in and around your belt drives. Besides making maintenance easier, the following precautions will ensure safety for the operator.

1. Trained personnel

Always have trained personnel working on your belt drives.

2. Always turn equipment off

Turn off the power to the drive before you start working, even if you are going for a brief inspection. Lock the control box and tag it with a warning sign "Down for maintenance. Do not turn power on." Keep the key in your pocket. For added safety, and if possible, remove fuses. Inspecting the drive usually involves watching the machine running - but never touch it before it stops.

3. Check position of components

Make sure all machine components are in a "safe" position. Place fly-wheels, counterweights, gears and clutches in a neutral position to avoid accidental movements. Always follow the manufacturer's recommendations for safe maintenance practices.

4. Wear proper clothing

Never wear loose or bulky clothes (e.g. ties, loose sleeves, lab coats) around belt drives. Wear gloves when inspecting pulleys to avoid being cut by nicks or sharply worn pulley edges.

5. Maintain safe access to the drives

Keep the areas around the drive free of clutter, debris and other obstructions. Floors should be clean and free of oil and debris to ensure good footing and balance of the operator whilst working on the machine.

6. Drive guards

Always keep drives properly guarded. Every belt drive must be completely guarded while in operation. A makeshift, partial guard is often more dangerous, since it gives a false sense of security and encourages unsafe action. Besides being a safety asset, a good guard makes your maintenance job easier since it protects the drive from outside damaging influences.

7. Test run

Before you put your drive back into normal operation, have a "test run" to check whether everything functions normally. Make any verifications necessary and take corrective action if needed.

A properly designed guard has following features:

- it completely encloses the drive;
- it is equipped with grills or vents for good ventilation;
- the size of the openings must be adequate, i.e. small enough to prevent "pinch points";
- it is preferably equipped with an automatic shut-off device which deactivates the drive as soon as the guard is removed;
- it has accessible inspection doors or panels;
- it can easily be removed and replaced if damaged;
- where necessary, it should protect the drive from weather, debris and damage.

III. PREVENTIVE “ROUTINE” MAINTENANCE

Maintenance has two aspects: shorter, regular preventive inspections and thorough inspections with a longer period of machine shutdown. This section deals with the first type of routine inspection.

1. Simple drive inspection

A good way to begin preventive maintenance is making periodic drive inspection a normal part of your maintenance rounds.

Look and listen

Look and listen for any unusual vibration or sound while observing the guarded drive in operation. A well-designed and maintained drive will operate smoothly and quietly.

Guard inspection

Inspect the guard for looseness or damage. Keep it free of debris and grime buildup. Any accumulation of material on the guard will act as insulation and could cause the drive to run hotter.

Temperature is an important factor of belt performance and durability. For example, above 60°C an internal temperature increase of 10°C (50°F) – or approximately 20°C (68°F) rise in ambient temperature – may cut V-belt life in half.

Oil and grease

Also look for oil or grease dripping from the guard. This may indicate over-lubricated bearings. Oil and grease attack rubber compounds, causing them to swell and distort. This will lead to early belt failure.

Attachments

Finally, check motor mounts for proper tightness. Check takeup slots or rails to see that they are clean and lightly lubricated.

2. Frequency of inspection

The following factors will influence the frequency of drive inspection:

- drive operating speed;
- drive operating cycle;
- critical nature of equipment;
- temperature extremes in environment;
- environmental factors;
- accessibility of equipment.

Experience with your own equipment will be the best guide to how often you need to inspect the belt drives. High speeds, heavy loads, frequent start/stop conditions, extreme temperatures and drives operating on critical equipment will mean more frequent inspections.

3. When to perform preventive maintenance

The following guidelines will help you establish a preventive maintenance schedule.

Critical drives

A quick visual and hearing inspection may be needed every one to two weeks.

Normal drives

With most drives, a quick visual and hearing inspection can be performed once a month.

Complete inspection

A drive shutdown, for a thorough inspection of belts or pulleys and other drive components may be required every three to six months. See section IV.

IV. DRIVE SHUTDOWN AND THOROUGH INSPECTION

Belt drives regularly require a thorough inspection. By following the list below, you can maintain a drive efficiently, safely and with very little effort. When properly maintained and used under normal conditions, a well-designed industrial belt drive is capable of operating for several years.



Shut off power and lock controls.

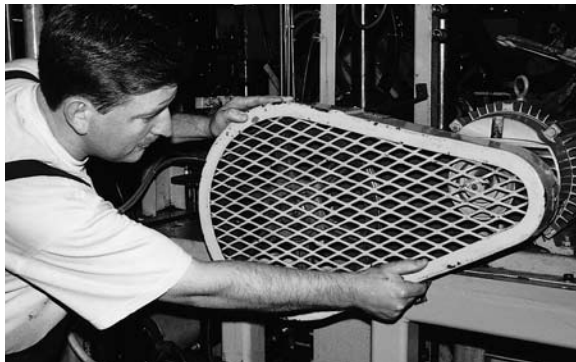

Guard inspection.

Preventive maintenance checklist

1. Turn off power to the drive. Lock the control box and tag it with a warning sign "Down for maintenance. Do not turn power on."
2. Place all machine components in a safe (neutral) position.
3. Remove and inspect guard. Check for signs of wear or rubbing against drive components. Clean guard as needed.
4. Inspect belt for wear or damage. Replace as needed. Page 9 outlines V-belt replacement procedure while page 10 covers synchronous belt replacement procedure.
5. Inspect pulleys for wear or damage. Replace if worn. Page 10 explains pulley replacement procedure.
6. Inspect other drive components such as bearings, shafts, motor mounts and takeup rails.
7. Inspect static conductive earthing system (if used) and replace components as needed.
8. Check belt tension and adjust as needed.
9. Recheck pulley alignment.
10. Reinstall belt guard.
11. Turn power on and restart drive. Look and listen for anything unusual.

These steps are covered in detail further in this manual.

Once the drive has been disconnected from power supply and tagged, and the machine components are in safe position, remove the guard and begin inspection.

1. Guard inspection

Check guards for wear or possible damage. Look for signs of wear or rubbing against drive components. Clean them to prevent their becoming insulated and closed to ventilation. Clean off any grease or oil that may have been spilled onto the guard from over-lubricated bearings.

2. Belt inspection

By observing signs of unusual belt wear or damage, you will be able to troubleshoot possible drive problems.

Mark a point on the belt, or one of the belts on a multiple V-belt drive. Work your way around the belt(s), checking for cracks, frayed spots, cuts or unusual wear patterns.

Check the belt for excessive heat. Belts do warm up while operating, but temperatures must not exceed certain limits. Your hand can tolerate up to about 45°C (113°F); if belts are too hot to touch, troubleshooting may be needed.

In that case, check the temperature range of the belt you are using.

Belts should be replaced if they show obvious signs of cracking, fraying, unusual wear or loss of teeth in a synchronous belt.

Belt inspection.



IV. DRIVE SHUTDOWN AND THOROUGH INSPECTION

When rotating drives by hand to ensure correct tracking of the belt, care must be taken not to trap fingers between the belt and pulley. Rotation of large synchronous drives by pulling on the belt is particularly hazardous where entrapment of fingers between pulley flanges and the belt can result in immediate amputation of the finger(s).

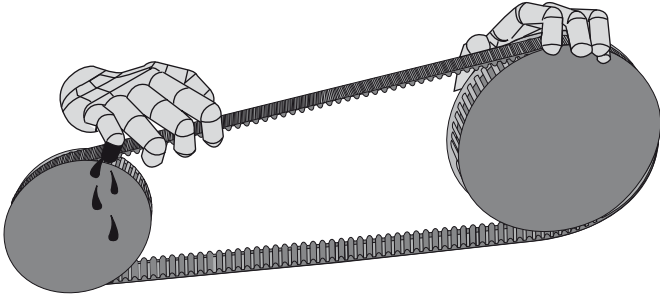

3. Pulley inspection

If belts have been removed from the drive, check pulleys for unusual wear or obvious signs of damage. Wear is not always obvious. Use Gates sheave gauges to check V-grooves. For synchronous belt drives, check the pulley diameters over the width of the pulley to ensure they are consistent and meet our tolerances (see Gates Drive Design Manual E2/20099).

Always check pulleys for proper alignment and mounting. Improperly aligned pulleys result in reduced service life.

The main causes of misalignment are:

- pulleys are improperly located on the shafts;
- motor shafts and driven machine shafts are not parallel;
- pulleys are tilted due to improper mounting.

Forms of misalignment

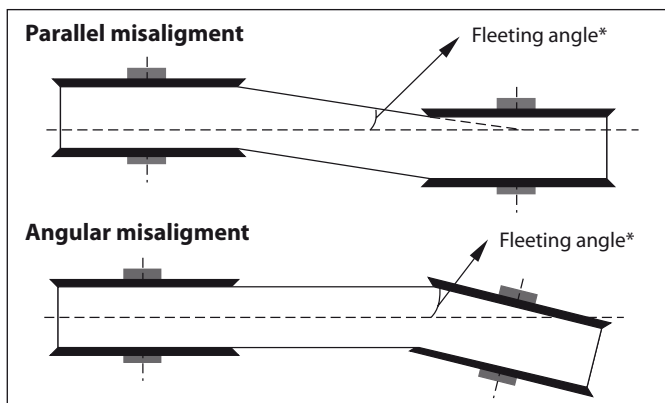

* Refer to "4. Check alignment tolerances".

To check alignment, you will need a straight edge or, for long centre distance drives, heavy string. Line the straight edge or string along a machined face of both pulleys as shown on the picture below. Misalignment will show up as a gap between the face of the pulley and the straight edge or string. When using this method, make sure the distance between the groove edge and the outer rim of both pulleys is identical. Pulleys can also be checked for tilting with a spirit level.

Use a straight edge to check pulley alignment.

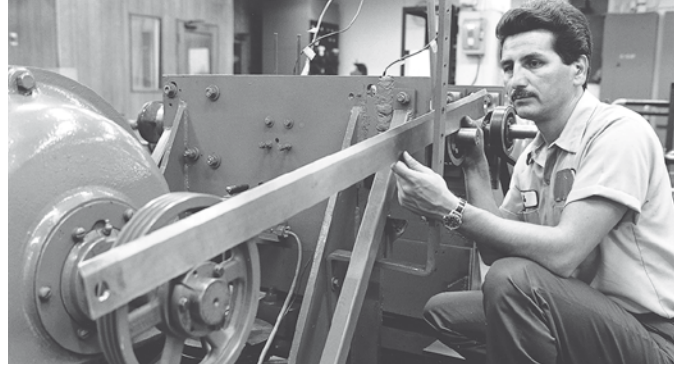

LASER AT-1 laser alignment device



The LASER AT-1 identifies parallel as well as angular misalignment between the pulleys and is suitable for pulley diameters of 60 mm and larger. Mounted in a few seconds, the laser line projected on the targets allows you to quickly ascertain and

correct misalignment. It can be used on both horizontally and vertically mounted machines. For more information please see leaflet E2/20121.

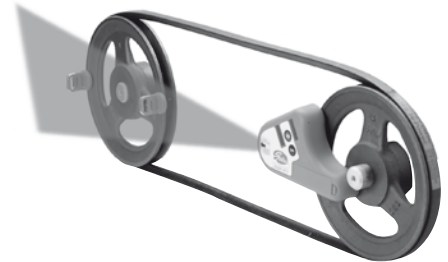

4. Check alignment tolerances

As a general rule, the deviation on pulley alignment on V-belt drives should not exceed $1/2^\circ$ or 5 mm per 500 mm of drive centre distance. Alignment for synchronous, Polyflex® and Micro-V® belts should be controlled within $1/4^\circ$ or 2.5 mm per 500 mm of drive centre distance.

The greater the misalignment, the greater the chance of belt instability, increased belt wear and V-belt turnover.

Max deviation of pulley alignment	Per 500 mm of drive centre distance	
	(°)	(mm)
V-belt	1/2	5
Polyflex®	1/4	2.5
Micro-V®	1/4	2.5
Synchronous belts	1/4	2.5

5. Check other drive components

Always examine bearings for proper alignment and lubrication. Also check motor mounts for correct tightness. Be sure takeup rails are free of debris, obstructions, dirt or rust.

6. Check belt tension

The final step is to check belt tension, and, if necessary, retension the belt. Note that retensioning is not recommended for synchronous belts.

If too little tension is applied, V-belts may slip or synchronous belts may jump teeth.

The correct tension is the lowest tension at which the belts will transmit power when the drive is at full load. The general procedure to check belt tension is as follows.

- A. Measure at the centre of the span (t) the force required to deflect the belt on the drive 2 mm per 100 mm span length (synchronous belts) or 1 mm per 100 mm span length (V-belts) from its normal position.
- B. If the measured force is less than the minimum recommended deflection force, the belts should be tightened.
- C. New belts can be tensioned until the deflection force per belt is as close as possible to the maximum recommended deflection force.
- D. To facilitate tension measuring Gates has developed the sonic tension meter.

Sonic tension meter



The sonic tension meter measures tension by analysing the sound waves which the belt produces when strummed. A belt vibrates at a particular frequency based on its tension, mass and span length. The tension transforms this frequency into a tension

value. The hand-held tension meter, running on batteries or on the mains (adapter included), is supplied with two types of sensors (rigid and flexible), either of which is quickly attached to meet a specific need.

1. Important warning: when using the 507C sonic tension meter, the drive must be switched off.
2. Enter belt unit weight (provided with operating instructions), width and span on the keypad. This data remains in the meter even after shut-off.
3. Hold the small sensor up to the belt span and strum the belt slightly to make it vibrate.
4. Press the "measure" button. The computer processes the variations in sound pressure emanating from the belt span. The belt tension values are displayed on the panel in Newtons. If desired, the belt span frequencies can be displayed directly in Hz.

Warning: Gates sonic tension meter is not certified for use in explosion risk areas.

For more detailed information, e.g. suitability of the tension meter for different belt product lines, please contact your Gates representative.

For more details on the use of Gates' sonic tension meters, please consult Gates' sonic tension meter manual (E/20136).

Belt section	Small pulley diameter	Recommended deflection force*	
	mm	N	
		min	max

Quad-Power® II			
XPZ / 3VX	56	7	11
	60 - 63	8	13
	67 - 71	9	14
	75 - 80	10	15
	85 - 95	11	16
	100 - 125	13	19
XPA	132 - 180	16	24
	80 - 125	18	27
XPB / 5VX	132 - 200	22	31
	112 - 118	24	36
XPC	125 - 140	27	41
	150 - 170	30	47
	180 - 200	36	53
	212 - 280	38	55
	300 - 400	41	64
	180 - 236	50	75
XPA	250 - 355	65	95
	375 - 530	80	110

Super HC® MN / Super HC® / VulcoPlus™			
SPZ / SPZ-MN / 3V	56 - 67	7	10
	71	8	11
	75 - 80	9	13
	85 - 95	10	15
	100 - 125	12	17
SPA / SPA-MN	132 - 180	13	19
	80 - 95	12	16
	100 - 125	14	21
	132 - 200	19	28
SPB / SPB-MN / 5V	212 - 250	20	30
	112 - 150	23	36
	160 - 200	29	44
	212 - 280	36	50
	300 - 400	38	58
SPC / SPC-MN	180 - 236	40	60
	250 - 355	51	75
	375 - 530	60	90
8V / 25 J	317 - 431	76	113
	457 - 610	88	133
8VK	380 - 437	97	145
	450 - 600	112	166

Hi-Power® / VulcoPower™			
Z	60 - 67	6	8
	71 - 80	7	9
	85 - 100	8	11
	106 - 140	9	12
	150 - 224	10	14
A	60 - 80	7	12
	85 - 90	9	13
	95 - 106	10	15
	112 - 180	13	20
B	80 - 106	11	17
	112 - 118	14	20
	125 - 140	15	23
	150 - 170	19	27
	180 - 1250	22	33
C	150 - 170	21	33
	180	24	35
	190	26	38
	200 - 212	30	45
	224 - 265	33	50
	280 - 400	38	58
D	300 - 335	51	73
	355 - 400	56	82
	425 - 560	65	99

* This recommendation is for uncritical drive configurations. For critical drives individual design calculations are required.

IV. DRIVE SHUTDOWN AND THOROUGH INSPECTION

Single tension tester

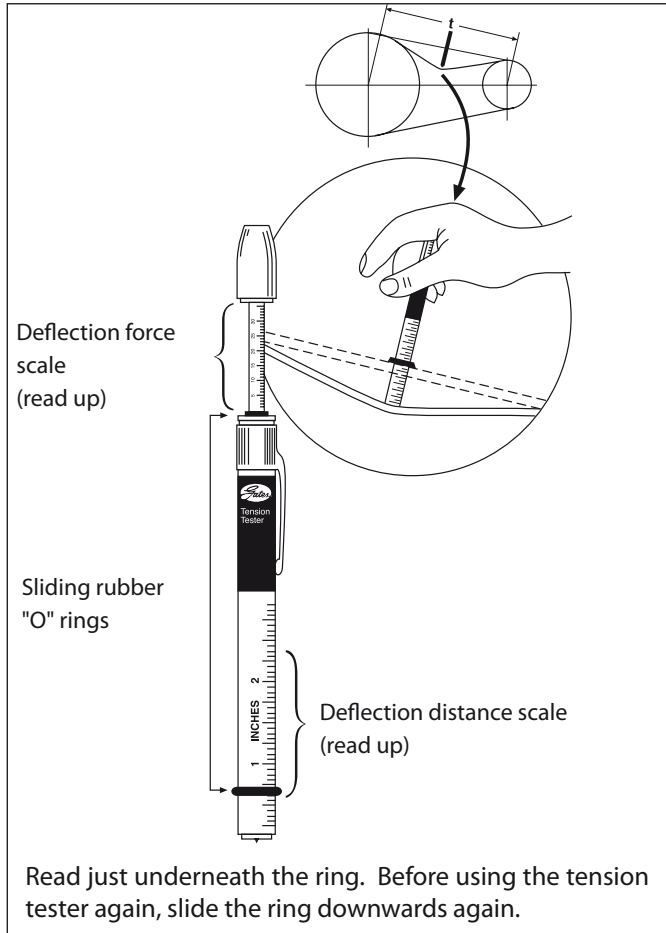

Double tension tester

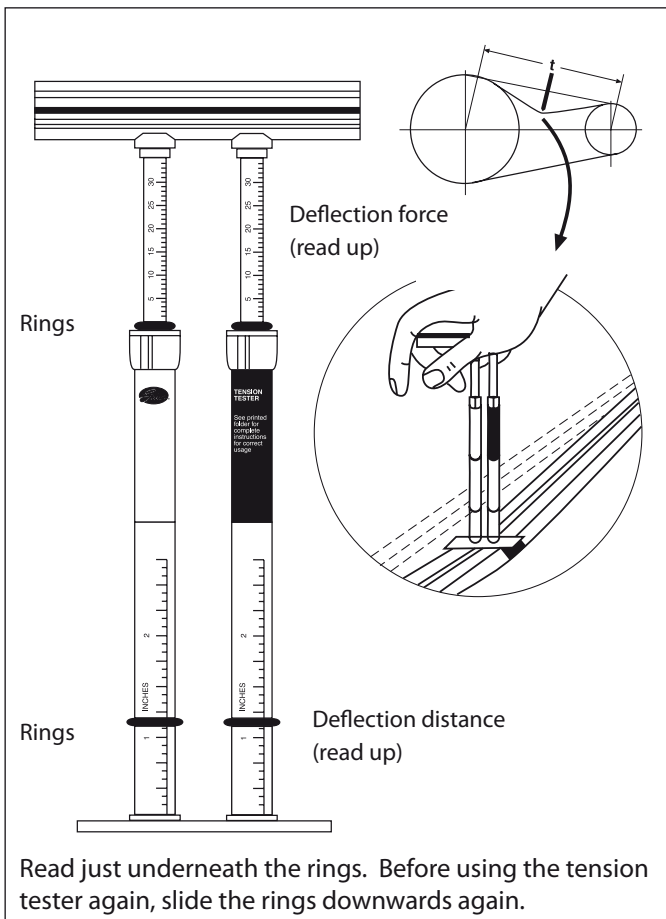

Conventional tension testers

Unlike the sonic tension meter, Gates' conventional tension testers measure deflection force. The Single tension tester measures up to ± 120 N and the Double tension tester up to ± 300 N. Both testers consist of a calibrated spring with two scales: one to measure the deflection and another to measure the applied force.

The reading of these scales can be done as follows.

1. Measure the span length (t).
2. The calculated deflection should be positioned with the lower ring on the distance scale. The upper ring should be on the zero position of the deflection force scale.
3. Put the tension tester perpendicular to the span and in the middle of the span. Exercise enough pressure to the tension tester to deflect the belt by the amount indicated by the lower ring. A straight edge, laid across the pulleys, can help accuracy of reading.
4. The upper ring will slide up the upper scale and indicates the deflection force. Read at the bottom edge of the ring. When you use the Double tension tester you can read the values just underneath the rings and calculate the sum of both values. This value has to be compared with the calculated min./max. forces (see Synchronous Drive Design Manual E2/20099).

In tensioning a Gates PowerBand® belt, multiply the deflection force (see table on page 7 by the number of belts in the PowerBand®. The tension tester can be applied as indicated above to deflect the entire PowerBand®, providing a small board or metal plate is placed on top of the band so that all belts are deflected uniformly. As a reference for measuring deflection, a straight edge can be laid across the pulleys. If the deflection force exceeds 30 kg (66 pounds) - the maximum reading on the tester - use a large spring scale or consult your Gates representative.

When the decision has been made to install a belt, either as a replacement or on a new drive, follow these recommendations for proper installation. Also ensure correct pulley mounting and alignment.



Pulley gauges make wear detection easier.

1. V-belt installation

1. After the power has been turned off, isolated (i.e. locked) and the guard removed, loosen the motor mounting bolts. Move the motor until the belt is slack and it can be removed without prising. Never prise off a belt!
2. Remove old belts. Check them for unusual wear. Excessive wear may indicate problems with drive design or maintenance procedures.
3. Select correct replacement belt. Refer to the belt identification charts on pages 22 - 24 for belt selection information.
4. You can clean belts and pulleys with a rag slightly dampened with a light, non-volatile solvent. Avoid soaking or brushing the solvent on the belt. Do not sand or scrape the belt with a sharp object to remove grease or debris. Belts must be dry before using on a drive.
5. Inspect pulleys for wear and damage. Gates sheave gauges* make it easy to see if grooves are worn. If more than 0.4 mm of wear can be seen, the pulley should be replaced. Make sure the pulleys are properly aligned (*available from Gates).
6. Inspect other drive components such as bearings and shafts for alignment, wear, lubrication,...
7. Install a new belt or belt set. Replace all belts on multiple belt drives. Do not mix old and new belts. Older belts do not retain tension as well as new belts. If you mix belts, the load may be carried only by the new belts. This can result in premature failure. Also, never mix belts from different manufacturers. Belts with different origins may have different characteristics that can cause the belts to work against each other, resulting in unusual strain and short service life.
8. Take up centre distance on the drive, rotate the drive by hand for a few revolutions until proper tension is obtained on the tension tester. Some long belts may appear to hang unevenly when installed. It is normal for belts within match tolerances to create noticeable differences in deflection. This "catenary effect" is a curve made by a cord of uniform weight suspended between two points. This appearance will change with proper run-in and tensioning.
9. Secure motor mounting bolts to correct torque.
10. Replace guard.
11. Let the belts run in for a while. This process consists of starting the drive, letting it run under full load, and then stopping, checking and retensioning to recommended values. Running the belts under full load allows them to seat themselves in the grooves. If possible, let the drive run for about 24 hours. Even letting them run overnight, or over a lunch break, is better than nothing. This run-in period will reduce the future need for retensioning.
12. During start-up, look and listen for unusual noise or vibration. It is a good idea to shut down the machine and check the bearings and motor. If they feel hot, the belt tension may be too tight. Or the bearing may be misaligned or improperly lubricated.

V. BELT AND PULLEY INSTALLATION

2. Synchronous belt installation

1. After the power has been turned off, isolated (i.e. locked) and the guard removed, loosen the motor mounting bolts. Move the motor until the belt is slack and it can be removed without prising. **Never prise off a belt!**
2. Remove old belt and check it for unusual wear. Excessive wear may indicate problems with drive design or maintenance procedures.
3. Select correct replacement belt. Refer to the belt identification charts on pages 25 - 27 for belt selection information.
4. Pulleys can be cleaned with a rag slightly dampened with a light, non-volatile solvent. Do not sand or scrape the pulley with a sharp object to remove grease or debris. Pulleys must be dry before using on a drive.
5. Inspect pulleys for unusual or excessive wear. Also check alignment. Correct alignment is more critical with synchronous belt drives.
6. Check other drive components such as bearings and shafts for alignment, wear, lubrication,...
7. Install new belt over pulleys. Do not prise or use force.
8. Take up centre distance on the drive until proper tension is obtained on the tension tester. Rotate the drives by hand for a few revolutions and recheck tension.
9. Secure motor mounting bolts to correct torque. Be sure all drive components are secure since any change in drive centres during operation will result in poor belt performance.
10. Although belts will not require further tensioning, we recommend starting up the drive and observing performance. Look and listen for any unusual noise or vibration. It is a good idea to shut down the machine and check the bearings and the motor. If they feel hot, the belt tension may be too high. Or the bearings may be misaligned or improperly lubricated.

3. Pulley installation and alignment

It is extremely important that pulleys be installed and aligned properly. Any pulley must be correctly assembled, and bolts or setscrews tightened to the correct torque.

Most pulleys are attached to the shaft with a tapered bushing which fits a mating tapered bore in the pulley. This type of system consists of a bushing, a pulley and often a setscrew and key. Bushings come in several diameters. This allows a reduction in the parts inventory required in your plant because one bushing can be used with a number of different size pulleys.

Taper bushes

To install, insert the bushing into the pulley. Match holes (not threads) and slip the entire unit onto the shaft. Put screws into the holes that are threaded in the pulley only. Align the pulleys and tighten the screws. As the bushing is wedged inward, it contacts and grips the shaft.

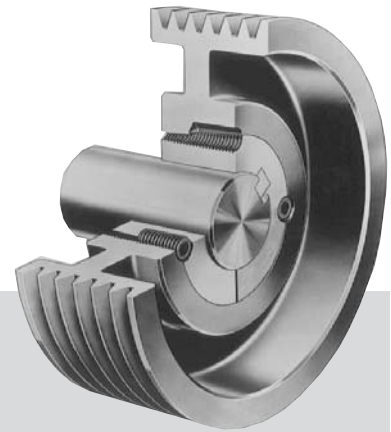

Taper bush

Recommended wrench torque values
to use in tightening taper bushes

Bushing no.	Screw tightening torque (Nm)
1008	5.6
1108	5.6
1210	20.0
1215	20.0
1310	20.0
1610	20.0
1615	20.0
2012	30.0
2517	50.0
2525	50.0
3020	90.0
3030	90.0
3525	115.0
3535	115.0
4030	170.0
4040	170.0
4535	190.0
4545	190.0
5040	270.0
5050	270.0

When preventive maintenance inspections indicate that belts need replacing, it is important you install the appropriate belts. Consequently, you should be able to identify the various types and sizes available to achieve quick and correct replacement. The information on the following pages will help you become familiar with the belt types used in industry.

1. Industrial belt types

Gates manufactures many belt types to fit nearly any application you can name. Always make sure you select the appropriate belt for your application. Even though they may look similar, belts have different characteristics. Do not use light-duty belts on heavy-duty drives, and do not interchange sections. If in doubt carefully measure the top width, or use the pulley gauges.

V-belts

Quad-Power® II - Raw edge, moulded notch, narrow section V-belt

The Quad-Power® II V-belt features a moulded notch design and is ideal for heavy-duty, high-speed V-belt drives. It replaces traditional V-belts on heavy-duty applications where space and weight savings are critical.

- Higher power ratings: 15% higher power rating values than previous generations, providing the same service life.
- Moulded notch construction improves flexibility, reduces bending stress and provides improved performance.
- Tough tensile members resist fatigue and shock loads.
- Higher power ratings than classical sections: narrower drives through fewer belts reduce total drive cost.
- Temperature ranges from -30°C up to +60°C.*
- Match system: all sizes meet Gates **UNISET** tolerances, they can be installed without matching.
- **Static conductive (ISO 1813)** and can as such be used in the conditions described in the Directive 94/9/EC – ATEX.

Available in XPZ, XPA, XPB and XPC sections and in ISO datum lengths from 630 mm up to 5000 mm.

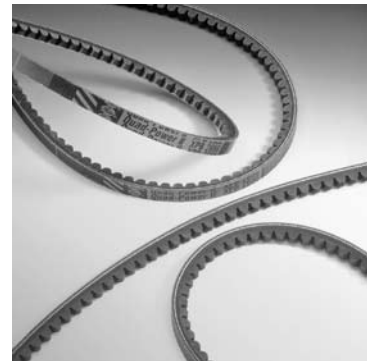

Super HC® MN - Raw edge, moulded notch, narrow section V-belt

Super HC® moulded notch V-belts put more power where high speeds, high speed ratios or small pulley diameters are required, thus offering significant advantages over classical section V-belts.

- Straight ground sidewalls give uniform wedging action.
- Tough tensile members resist fatigue and shock loads.
- More power in the same space or same power in 1/3 to 1/2 less space as compared to classical section V-belts.
- Temperature ranges from -30°C up to +60°C.*
- Match system: all sizes meet Gates **UNISET** tolerances, they can be installed without matching.
- **Static conductive (ISO 1813)** and can as such be used in the conditions described in the Directive 94/9/EC – ATEX.

Available in SPZ-MN, SPA-MN, SPB-MN and SPC-MN sections and in ISO datum lengths from 560 mm up to 4750 mm.

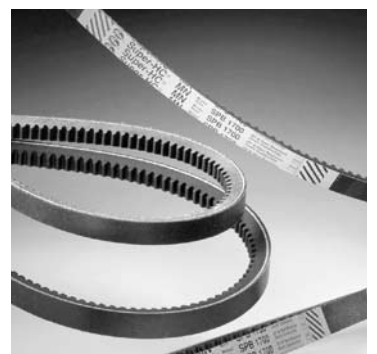

VI. BELT IDENTIFICATION

Super HC® - Wrapped, narrow section V-belt

The Super HC® narrow section V-belt is a popular wrapped construction and suits an extensive range of industries including mining, quarry and heavy construction.

- Arched top, concave sidewalls and rounded corners provide uniform tensile loading and uniform pulley sidewall contact for excellent belt service life and reduced pulley wear.
- The Flex Weave® oil and heat resistant cover protects the belt core from the toughest environments.
- The vulcanised Flex-bonded tensile cords provide superior resistance to tensile and flexing forces, fatigue and shock loads.
- Temperature ranges from -30°C up to +60°C.*
- Match system: all sizes meet Gates **UNISET** tolerances, they can be installed without matching.
- **Static conductive (ISO 1813)** and can as such be used in the conditions described in the Directive 94/9/EC – ATEX.

Super HC® is available in SPZ, SPA, SPB and SPC sections and in ISO datum lengths from 487 mm up to 16500 mm.



Hi-Power® - Wrapped, classical section V-belt

The wrapped classical section Hi-Power® V-belt has a long reputation for reliability on agricultural and industrial applications.

- The concave sidewalls straighten out to the exact shape of the pulley grooves, ensuring full contact with the sides of the pulley.
- The arched top provides superior strength to prevent “dishing” and distortion of the tensile section, providing maximum belt life.
- The Flex Weave® oil and heat resistant cover protects the belt core from the toughest environments.
- The vulcanised Flex-bonded tensile cords provide superior resistance to tensile and flexing forces, fatigue and shock loads.
- Temperature ranges from -30°C up to +60°C.*
- Match system: all sizes meet Gates **UNISET** tolerances, they can be installed without matching.
- **Static conductive (ISO 1813)** and can as such be used in the conditions described in the Directive 94/9/EC – ATEX.

Hi-Power® is available in Z, A, B, C and D sections and in ISO datum lengths from 447 mm up to 16846 mm. Also available with double-V profile in AA, BB, CC and DD sections and in ISO datum lengths from 940 mm up to 10690 mm.



VulcoPower™ - Wrapped, classical section V-belt

Gates VulcoPower™ V-belts are built for a reliable and durable performance on heavy-duty industrial drives. They offer a combination of advantages only available in Gates quality belts – all at an attractive price.

- Excellent performance/cost ratio.
- Belt compound converts forces on the sidewalls into longitudinal forces in the tensile member.
- Textile cover provides grip and protects against abrasion.
- Polyester tensile member withstands occasional or recurrent shock loads.
- Temperature ranges from -30°C up to +60°C.*
- Match system: all sizes meet Gates **UNISET** tolerances, they can be installed without matching.
- **Static conductive (ISO 1813)** and can as such be used in the conditions described in the Directive 94/9/EC – ATEX.

Available in Z, A, B and C sections and in ISO datum lengths from 435 mm up to 7165 mm.



VulcoPlus™ - Wrapped, narrow section V-belt

If your application requires high speeds, high speed ratios or small pulley diameters, Gates VulcoPlus™ is the ideal solution. This replacement belt is recommended for use on all industrial heavy-duty, narrow section V-belt drives.

- Excellent performance/cost ratio.
- Belt compound converts tensile forces on the sidewalls into longitudinal forces in the tensile member.
- Textile cover provides grip and protects against abrasion.
- Polyester tensile member withstands occasional or recurrent shock loads.
- Temperature ranges from -30°C up to +60°C.*
- Match system: all sizes meet Gates **UNISET** tolerances, they can be installed without matching.
- **Static conductive (ISO 1813)** and can as such be used in the conditions described in the Directive 94/9/EC – ATEX.

Available in SPZ, SPA, SPB and SPC sections and in ISO datum lengths from 562 mm up to 11200 mm.



VI. BELT IDENTIFICATION

Predator® PowerBand® - Wrapped, narrow section multiple V-belt

Gates Predator® V-belts are the markets' leading V-belts. Unique in their extreme robustness and high load carrying capability they are unrivalled. They are excellent problem solvers that perform well in harsh environments and in extremely demanding applications where standard V-belts have performance issues.

- At least 40% higher power ratings than standard construction V-belts.
- Chloroprene rubber compounds provide superb oil and heat resistance.
- Double fabric cover offers extreme abrasion and wear resistance.
- Specially treated extra tough cover withstands slip and shear forces at peak loads without generating excessive heat and resists penetration by foreign materials.
- Non-rubber surfaced cover allows momentary slippage due to excessive overloads without damaging the belt.
- Aramid tensile cords provide extraordinary strength, durability and virtually zero stretch.
- Predator® single belts are available on demand in AP, BP, CP, SPBP, SPCP and 8VP sections in lengths over 1,400 mm. They are specially designed for applications where PowerBand® belts are not an option, e.g. where debris needs to pass through the space between individual belts without damaging the belt section.
- Temperature ranges from -30°C up to +60°C.*
- Predator® PowerBand® belts are **static conductive (ISO 1813)** (except for 8VP) and can as such be used in the conditions described in the Directive 94/9/EC – ATEX; for detailed info on the static conductivity of Predator® single belts, please contact your Gates representative.

Available in SPBP, SPCP, 9JP, 15JP and 8VP sections and in lengths from 1400 mm up to 15240 mm.

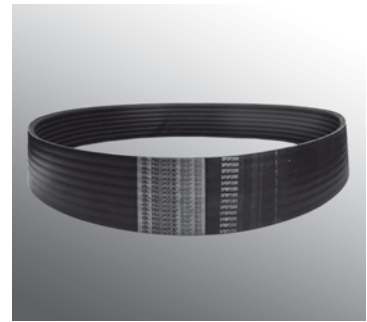

Quad-Power® II PowerBand® - Raw edge, moulded notch, narrow section multiple V-belt

Gates Quad-Power® II PowerBand® offers a stable position in the pulleys and a smooth running solution for drives where single belts vibrate.

- Strong band controls belt-to-belt distance and prevents sideways bending.
- Elastomeric compound protects the belt against heat, ozone and sunlight.
- Flat back construction reduces noise when used with a back side idler or tensioner.
- Flex-bonded tensile cords make the belt highly resistant to tensile and flexing forces, fatigue and shock loads.
- Temperature ranges from -30°C up to +60°C.*
- Match system: all sizes meet Gates **UNISSET** tolerances, they can be installed without matching.
- **Static conductive (ISO 1813)** and can as such be used in the conditions described in the Directive 94/9/EC – ATEX.

Available in XPZ, XPA, XPB, 3VX and 5VX sections and in lengths from 635 mm up to 5080 mm.

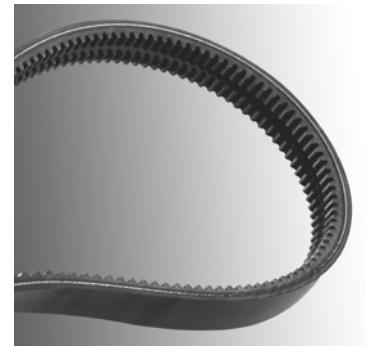

Super HC® and Hi-Power® PowerBand® - Wrapped, narrow section/classical section multiple V-belt

Gates Super HC® PowerBand® and Hi-Power® PowerBand® offer a solution for drives where single belts vibrate, turn over or jump of the pulleys.

- Strong band controls belt-to-belt distance and prevents sideways bending.
- Concave sides and arched top.
- Elastomeric compound protects the belt against heat, ozone and sunlight.
- Flex-Weave® cover protects the belt core from the toughest environments.
- Flex-bonded tensile cords make the belt highly resistant to tensile and flexing forces, fatigue and shock loads.
- Temperature ranges from -30°C up to +60°C.*
- **Static conductive (ISO 1813)** and can as such be used in the conditions described in the Directive 94/9/EC – ATEX.

Super HC® PowerBand® belts are available in SPB, SPC, 9J/3V, 15J/5V and 25J/8V sections and in lengths from 1250 mm up to 15240 mm. Hi-Power® PowerBand® belts are available in B, C and D sections and in lengths from 935 mm up to 16784 mm.



PowerRated® - Green textile wrapped V-belt

PowerRated® V-belts have a higher power capacity than conventional light-duty belts. They are ideal for heavy shock loaded and back idler driven lawn and garden equipment.

- Strong aramid tensile cords.
- Cord reinforcement and low friction wrapping improve clutching operation.
- Temperature ranges from -30°C up to +60°C.*

Available in 3L, 4L and 5L sections and in outside lengths from 406 mm up to 2515 mm.



Multi-Speed™ - Wide raw edge V-belt

The Multi-Speed™ V-belt for variable speed drives adjusts itself automatically to the pulley groove providing a wide range of speeds and speed ratios.

- High load-carrying capacity.
- Notching increases flexibility and ensures maximum heat dispersion.
- Strong transverse rigidity.
- Uniform undercord thickness ensures smooth running.
- Temperature ranges from -30°C up to +60°C.*

Available in ISO profiles with lengths from 630 mm up to 3150 mm. Additional Gates line covers the most popular applications.



VI. BELT IDENTIFICATION

Polyflex® and Polyflex® JB™ - Polyurethane V-belt/multiple V-belt

Because of their small sections Polyflex® belts are ideal for compact short centre and small diameter drives. Polyflex® JB™ multiple V-belts as well as Polyflex® single belts can operate at very high shaft speeds up to 30000 rpm.

- Polyurethane compound with high friction coefficient cast as a single unit after tensile cords are positioned in the mould.
- 60° angle better supports the tensile section providing even load distribution.
- Polyflex® JB™ joined belt construction improves stability.
- Temperature ranges from -54°C up to +85°C.*

Polyflex® JB™ multiple V-belts are available in 3M-JB, 5M-JB, 7M-JB and 11M-JB sections and in effective lengths from 175 mm up to 2293 mm.

Polyflex® single belts are available in 3M, 5M, 7M and 11M sections and in effective lengths from 180 mm up to 2300 mm.

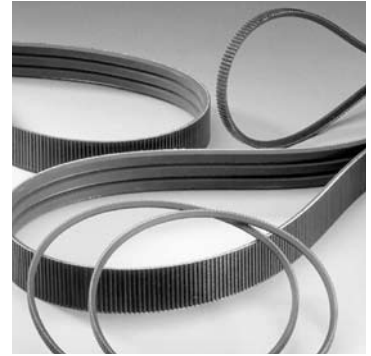

Micro-V® - Multi-ribbed V-belt

Industrial Micro-V® belts feature truncated V-ribs which increase flexibility, reduce heat build-up and improve crack resistance. This unique design lets the belt perform at extra high speeds on smaller diameter pulleys.

- The truncated design stands for: a power capacity increase up to 80% higher than RMA standards, better tolerance of debris in the pulley groove.
- Polyester tensile member provides superior resistance to fatigue and shock loads.
- Highly resistant to oil and heat.
- Temperature ranges from -30°C up to +60°C.*
- **Static conductive (ISO 1813)** and can as such be used in the conditions described in the Directive 94/9/EC – ATEX.

Available in PJ, PL and PM sections and in effective lengths from 406 mm up to 9931 mm.

Slabs in PK section up to 2500 mm are available on request.



* NOTE

For applications outside this range, please consult your Gates representative.

Synchronous belts

Synchronous belts are identified by:

1. **Belt pitch:** distance (mm) between two adjacent tooth centres as measured on the belt's pitch line.
2. **Belt pitch length:** circumference (mm) as measured along the pitch line.
3. **Width:** top width (mm).
4. **Tooth profile:** see pages 25 - 27 for the easiest way to identify this.

Synchronous belts run on pulleys, which are specified by the following:

1. **Pitch:** distance (mm) between groove centres, measured on the pulley pitch circle. The pitch circle coincides with the pitch line of the mating belt.
2. **Number of pulley grooves.**
3. **Width:** face width.

NOTE: - The pulley's pitch diameter is always greater than its outside diameter.
 - Also note that the belt tooth and pulley grooves should always be of the same profile (shape).
Never interchange pulley and tooth types!

Poly Chain® GT Carbon™ - Polyurethane synchronous belt with patented carbon tensile cords

Poly Chain® GT Carbon™ is Gates' new polyurethane synchronous belt with patented carbon tensile cord designed for high torque, low speed drives. The materials development engineers from Gates are the first to have incorporated a high fatigue-resisting carbon fibre tensile cord into the belt which is made of a new polyurethane compound. Consequently, Poly Chain® GT Carbon™ is the most powerful synchronous belt in the market providing a maintenance-free, energy saving and environmentally friendly operation.

- Highest power capacity: at least 25% higher power ratings than Poly Chain® GT2 belts.
- The basic belt consists of a newly developed, lightweight polyurethane compound which is chemically resistant and ensures optimum adhesion with the carbon tensile cords.
- The carbon tensile cords provide higher power ratings, high strength, improved fatigue and shock load resistance, increased flexibility, excellent reverse bending stress, high length stability and virtually zero stretch.
- Available in 8MGT and 14MGT pitches operating on existing Poly Chain® pulleys.
- Clean, quiet, compact, durable, maintenance-free, energy saving and environmentally friendly operation.
- Unparalleled savings in weight, space and money.
- Temperature ranges from -54°C to +85°C.*
- **Now also available in 2 special belt constructions:**
 - **Poly Chain® GT Carbon™ High Temperature**
Special polyurethane compound provides superb heat resistance. It enables the belt to remain fully operational under extreme temperatures ranging up to 120°C and even up to 140°C during shorter periods;
 - **Poly Chain® GT Carbon™ Hot Oil**
Special polyurethane compound provides superb oil and heat resistance, ensuring a problem-free operation in oil environments at temperatures ranging up to 120°C (suitable for transfer cases, gear boxes...).

Available in 8MGT and 14MGT pitches and in pitch lengths from 640 mm up to 4480 mm.

Also available in Mini Poly Chain® GT Carbon™ with GT teeth in 8M pitch and in pitch lengths from 248 mm up to 608 mm.

Poly Chain® GT™ Carbon High Temperature and Poly Chain® GT™ Carbon Hot Oil are available in standard lengths up to 2000 mm. The belts are only available on request. For more detailed information and correct usage, please contact your Gates representative.

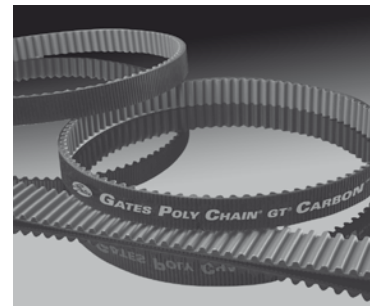

VI. BELT IDENTIFICATION

Poly Chain® GT2 - Polyurethane synchronous belt

Poly Chain® GT2 belts with aramid tensile cords have been designed for optimum performance on high torque, low speed drives in any industrial application. They operate on Poly Chain® pulleys, available from stock in more than 160 different outside diameters.

- Substantially increased power ratings, ensuring the same service life.
- Uniquely formulated polyurethane is resistant to chemicals and contaminants.
- Tensile cords provide extraordinary power carrying capacity and flex fatigue life.
- Virtually maintenance-free, no re-tensioning needed and therefore an excellent alternative to roller chain.
- Temperature ranges from -54°C to +85°C.*

Available in 8MGT and 14MGT pitches and in pitch lengths from 640 mm up to 4480 mm.

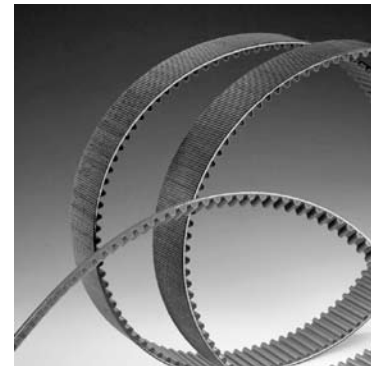

PowerGrip® GT3 - Rubber synchronous belt with optimised GT tooth profile

PowerGrip® GT3 is Gates' latest development in synchronous rubber belts. This technically advanced belt covers the widest range of industrial applications. The PowerGrip® GT3 belt transmits up to 30% more power than the previous generation belts. The entire PowerGrip® GT3 range is suited both for new drive designs and for replacements on existing drives without any adaptation of the system.

- Upgraded construction with fibreglass tensile cords, elastomeric teeth and backing and nylon facing.
- Improved tooth jump resistance.
- High capacity belt with reduced noise levels.
- No lubrication needed.
- Temperature ranges from -30°C up to +100°C.*
- **8MGT and 14MGT pitches are static conductive (ISO 9563)** and can as such be used in the conditions described in the Directive 94/9/EC - ATEX.

Available in 2MGT, 3MGT, 5MGT, 8MGT and 14MGT pitches and in pitch lengths from 74 mm up to 6860 mm.



PowerGrip® HTD® - Rubber synchronous belt with HTD® tooth profile

PowerGrip® HTD® belts are ideal for high power transmission in low speed and high torque applications.

- Special curvilinear tooth design improves stress distribution and allows higher overall loading.
- Designed for speeds up to 20000 rpm and load capacities up to 1000 kW.
- Economical operation, no lubrication needed, no need for adjustment due to stretch and wear.
- Temperature ranges from -30°C up to +100°C.*
- **14M pitches are static conductive (ISO 9563)** and can as such be used in the condition described in the Directive 94/9/EC - ATEX.

Available in 3M, 5M, 8M, 14M and 20M pitches and in pitch lengths from 105 mm up to 6600 mm.



PowerGrip® CTB - Classical synchronous belt

The PowerGrip® classical synchronous belt offers a maintenance-free and economical alternative to conventional drives like chains and gears.

- Power transmission of up to 150 kW and speeds of up to 10000 rpm.
- Efficiencies up to 99%.
- Wide range of load capacities and speed ratios.
- Temperature ranges from -30°C up to +100°C.*

Available in standard MXL (0.08 inches), XL, L, H, XH and XXH pitches according to ISO 5296 and in pitch lengths from 73 mm up to 4572 mm.

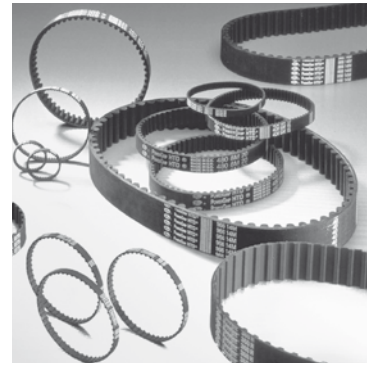

Twin Power® - Double-sided synchronous belt

Due to its double and directly opposite teeth, Twin Power® synchronous belts ensure high loading capacity on contra-rotating drives and ensure smooth running and high flexibility.

- Transmission of 100% of its maximum rated load from either side of the belt. Alternatively, it can transmit a load on both sides provided the sum of the loads does not exceed the maximum capacity.
- Available with the classical trapezoidal but also with HTD® or unique GT tooth profile.
- Temperature ranges from -30°C up to +100°C.*

Available in PowerGrip® GT2 8MGT and 14MGT and pitch lengths from 480 mm up to 6860 mm; PowerGrip® HTD® 5M and pitch lengths from 425 mm up to 2525 mm; PowerGrip® XL, L and H and pitch lengths from 381 mm up to 4318 mm.

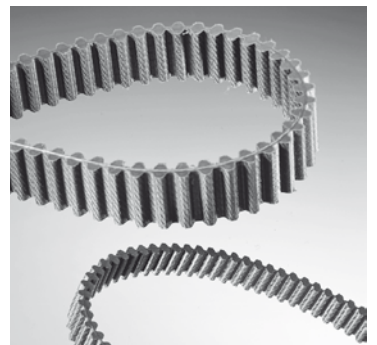

Long Length - Open-end synchronous belt

Long Length belts are especially suited for linear movements (automated doors, warehouse conveyors and elevators), accurate positioning (machine tools, x-y co-ordinate machines) and reversal drives (computers, printers and office equipment).

- High power transmission and high positioning accuracy.
- Length stability thanks to high modulus tensile members.
- Easy to attach with clamping fixtures.
- Temperature ranges from -30°C up to +100°C.*

Available pitches and lengths:

Elastomeric compound: PowerGrip® XL, L, H; HTD® 3M, 5M, 8M & 14M; GT 3MR, 5MR & 8MR (30 m lengths);

Polyurethane compound: Poly Chain® GT Carbon™ 8MGT & 14MGT (30 m lengths).

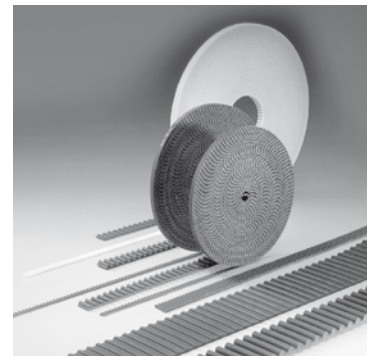

LiftPower™ - Open-end flat belt

LiftPower™ belts have been designed for optimum performance on lifting and handling applications to move platforms and/or weights. They are an ideal alternative to hydraulic cylinders in scissors-type lifting tables and to chains and steel cables in vertical transport of motor vehicles in high rise stores. LiftPower™ belts run on flat pulleys.

- Use of steel cords or high performance steel cords results in very low elongation and increased flexibility compared to steel cables.
- Smooth-running and higher speeds compared to chains and steel cables.
- Reduced noise level.
- Fabric on the back of the belt ensures less friction and high wear resistance.
- Temperature ranges from -30°C up to +100°C.*

Available on demand on rolls of 100 m.

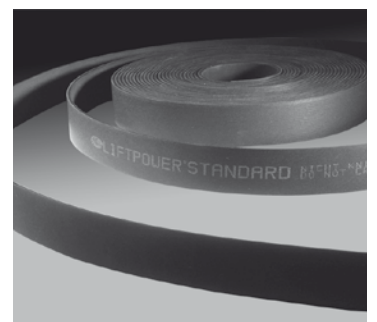

VI. BELT IDENTIFICATION

TransMotion™ - Rubber synchronous belt with conveyor cord

TransMotion™ is the most powerful rubber belt in the market for conveyor applications. TransMotion™ guarantees a 100% reliability when it is used for conveyor lines in the most diverse industries.

- Technically advanced compound with elastomeric teeth and backing and nylon facing.
- Conveyor cord provides superior tooth jump resistance and shock load resistance. Allows use in wash down applications.
- **Static conductive (ISO 9563)** and can as such be used in the conditions described in the Directive 94/9/EC – ATEX.
- Temperature ranges from -30°C up to +100°C.*

Available in 8MGT pitch and in pitch lengths from 384 mm up to 4400 mm.

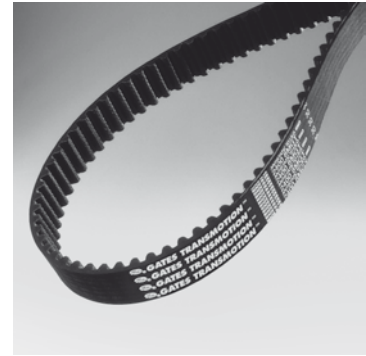

PowerPainT™ - Paint and varnish compatible synchronous belt

PowerPainT™ synchronous belt is specifically developed for use in painting areas, as found in the automotive and white goods industries where contamination of the painted product, from whatever source, is unacceptable.

- Precision-formed elastomeric teeth with curvilinear profile improve stress distribution and provide high power capacity.
- Accurately spaced teeth provide high positioning accuracy and optimum efficiency.
- Tough tensile cords ensure excellent flex life and high resistance to elongation.
- Temperature ranges from -30°C up to +100°C.*

Available pitches:

Poly Chain® GT Carbon™ 8MGT & 14MGT; Poly Chain® GT2 8MGT & 14MGT; PowerGrip® GT3 5MGT, 8MGT & 14MGT; PowerGrip® HTD® 3M, 5M, 8M & 14M; TransMotion™ 8MGT; Long Length PowerGrip® GT 3MR, 5MR & 8MR; Long Length PowerGrip® HTD® 3M, 5M, 8M & 14M; Long Length PowerGrip® XL, L & H and Long Length Poly Chain® 8MGT & 14MGT.

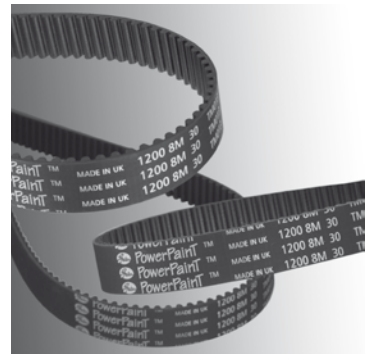

Synchro-Power® - Open-end/endless polyurethane synchronous belt

Gates Synchro-Power® polyurethane belts provide maximum power transmission combined with perfect tooth meshing and tight and accurate tolerances. Polyurethane is extremely wear and fatigue resistant and at the same time highly flexible. Gates Synchro-Power® belts are both available as endless and as open-end belt and can be used in a wide variety of applications in the printing industry, textile industry, food industry etc. Gates Synchro-Power® blue sleeves are the most recent addition to the PU range. They are available up to 200 mm width and can easily be recognised by their blue colour.

- Tough and flexible polyurethane compound of consistent quality.
- Resistance to elongation, wear and fatigue.
- Wide range of tooth profiles to meet innumerable application requirements.
- Synchro-Power® is available in:
 - Synchro-Power® sleeves, which are truly endless and have no joint, are supplied with steel tensile cords.
 - Synchro-Power® Long Length belts, which are manufactured as open-end extruded belts, are supplied with steel, stainless steel or aramid tensile cords, depending on the belt construction.
- Temperature ranges from -5°C up to +70°C.*



Please refer to the Gates Industrial Belt Catalogue (ref. E2/20054) for specifics, or consult your Gates representative for more information.

* NOTE
For applications outside this range, please consult your Gates representative.

Flexible couplings

EuroGrip® coupling

EuroGrip® flexible couplings feature OGEE lines allowing the coupling to act as a torque/life indicator for the drive, and a high damping capacity, which makes them especially suitable for direct drive applications in pumps and compressors.

- Sleeves of high-performance elastomeric compound.
- End pieces of high-grade aluminium reduce weight and inertia. Available either with finished bore and keyway or to suit a taper bush.
- Zero backlash results in high positioning accuracy.
- High vibration damping.
- Quiet in operation.
- High tolerance of combinations of radial and angular misalignment.
- Temperature ranges from -25°C up to +100°C.

Available in sizes 19, 28, 42, 48 and 60 and bored to suit taper bush or a plain bore and keyway.

For detailed sleeve and end-piece dimensions of EuroGrip® couplings, please see catalogue E2/20103.









VI. BELT IDENTIFICATION

2. Sections and nominal dimensions: V-belts





Predator®

Wrapped, narrow section/classical section V-belt

		WIDTH mm	HEIGHT mm
	AP	13	8
	BP	17	11
	CP	22	14
	SPBP	16	13
	SPCP	22	18
	8VP	26	23





Quad-Power® II

Raw edge, moulded notch, narrow section V-belt

		WIDTH mm	HEIGHT mm
	XPZ/3VX	10	8
	XPA	13	10
	XPB/5VX	16	13
	XPC	22	18





Super HC® MN

Raw edge, moulded notch, narrow section V-belt

		WIDTH mm	HEIGHT mm
	SPZ-MN/ 3VX	10	8
	SPA-MN	13	10
	SPB-MN/ 5VX	16	13
	SPC-MN	22	18





Super HC®

Wrapped, narrow section V-belt

		WIDTH mm	HEIGHT mm
	SPZ/3V	10	8
	SPA	13	10
	SPB/5V	16	13
	SPC	22	18
	8V	26	23





Hi-Power®

Wrapped, classical section V-belt

		WIDTH mm	HEIGHT mm
	Z	10	6
	A	13	8
	B	17	11
	C	22	14
	D	32	19





VulcoPower™

Wrapped, classical section V-belt

		WIDTH mm	HEIGHT mm
	Z	10	6
	A	13	8
	B	17	11
	C	22	14





VulcoPlus™

Wrapped, narrow section V-belt

		WIDTH mm	HEIGHT mm
	SPZ/3V	10	8
	SPA	13	10
	SPB/5V	16	13
	SPC	22	18





Predator® PowerBand®

Wrapped, narrow section multiple V-belt

		WIDTH mm	HEIGHT mm	PITCH mm
	SPBP	16	13	19.00
	SPCP	22	18	25.50
	9JP/3VP	10	8	10.30
	15JP/5VP	16	13	17.50
	25JP/8VP	26	23	28.60

Quad-Power® II PowerBand®









Raw edge, moulded notch, narrow section multiple V-belt

		WIDTH mm	HEIGHT mm	PITCH mm
	XPZ	10	8	12.00
	XPA	13	10	15.00
	XPB	16	13	19.00
	3VX	10	8	10.30
	5VX	16	13	17.50

VI. BELT IDENTIFICATION



Super HC® and Hi-Power® PowerBand®

Wrapped, narrow section/classical section multiple V-belt

		WIDTH mm	HEIGHT mm	PITCH mm
	SPB	16	13	19.00
	SPC	22	18	25.50
	9J/3V	10	8	10.30
	15J/5V	16	13	17.50
	25J/8V	26	23	28.60
	B	17	10	19.05
	C	22	12	25.40
	D	32	19	36.50





PowerRated®

Wrapped, green textile V-belt

		WIDTH inch	HEIGHT inch
	3L	3/8	7/32
	4L	1/2	5/16
	5L	21/32	3/8





Polyflex® JB™

Polyurethane multiple V-belt

		WIDTH mm	HEIGHT mm	PITCH mm
	3M-JB	3	2.28	3.35
	5M-JB	5	3.30	5.30
	7M-JB	7	5.33	8.50
	11M-JB	11	7.06	13.20





Polyflex®

Polyurethane V-belt

		WIDTH mm	HEIGHT mm
	3M	3	2.28
	5M	5	3.30
	7M	7	5.33
	11M	11	6.85

Micro-V®



Multi-ribbed V-belt

		HEIGHT mm	PITCH mm
	PJ	3.50	2.34
	PK	4.45	3.56
	PL	9.50	4.70
	PM	16.50	9.40

3. Sections and nominal dimensions: synchronous belts

Poly Chain® GT Carbon™

Polyurethane synchronous belt with patented carbon tensile cords

		PITCH mm	TOTAL HEIGHT mm	TOOTH HEIGHT mm
	8MGT	8	5.90	3.40
	14MGT	14	10.20	6.00





Poly Chain® GT2

Polyurethane synchronous belt

		PITCH mm	TOTAL HEIGHT mm	TOOTH HEIGHT mm
	8MGT	8	5.90	3.40
	14MGT	14	10.20	6.00





PowerGrip® GT3

Rubber synchronous belt with optimised GT tooth profile

		PITCH mm	TOTAL HEIGHT mm	TOOTH HEIGHT mm
	2MGT	2	1.52	0.71
	3MGT	3	2.41	1.12
	5MGT	5	3.81	1.92
	8MGT	8	5.60	3.40
	14MGT	14	10.00	6.00







PowerGrip® HTD®

Rubber synchronous belt with HTD® tooth profile

		PITCH mm	TOTAL HEIGHT mm	TOOTH HEIGHT mm
	3M	3	2.40	1.20
	5M	5	3.80	2.10
	8M	8	6.00	3.40
	14M	14	10.00	6.10
	20M	20	13.20	8.40

PowerGrip® CTB







Classical synchronous belt

		PITCH inch	TOTAL HEIGHT mm	TOOTH HEIGHT mm
	MXL	0.08	1.14	0.51
	XL	1/5	2.30	1.27
	L	3/8	3.50	1.91
	H	1/2	4.00	2.29
	XH	7/8	11.40	6.36
	XXH	1 1/4	15.20	9.53

VI. BELT IDENTIFICATION













Twin Power®

Double-sided synchronous belt

		PITCH	TOTAL HEIGHT mm	TOOTH HEIGHT mm
PowerGrip® GT2		mm		
	8MGT	8	8.80	3.40
	14MGT	14	15.34	5.82
PowerGrip® CTB		inch		
	XL	1/5	3.05	1.27
	L	3/8	4.58	1.91
	H	1/2	5.95	2.29
PowerGrip® HTD®		mm		
	5M	5	5.70	2.10

Long Length

Open-end synchronous belt

		PITCH	TOTAL HEIGHT mm	TOOTH HEIGHT mm
PowerGrip® GT		mm		
	3MR	3	2.41	1.12
	5MR	5	3.81	1.92
	8MR	8	5.60	3.34
PowerGrip® HTD®		mm		
	3M	3	2.40	1.10
	5M	5	3.80	2.10
	8M	8	6.00	3.40
	14M	14	10.00	6.00
PowerGrip® CTB		inch		
	XL	1/5	2.30	1.27
	L	3/8	3.60	1.91
	H	1/2	4.30	2.29
Poly Chain® GT Carbon™		mm		
	8MGT	8	5.90	3.40
	14MGT	14	10.20	6.00

LiftPower™

Open-end flat belt

		WIDTH mm	HEIGHT mm
	LL-LIFTP	Max. 150	2.50
	LL-LIFTP-HP	Max. 150	3.00

TransMotion™

Rubber synchronous belt with conveyor cord

		PITCH mm	TOTAL HEIGHT mm	TOOTH HEIGHT mm
	8MGT	8	6.60	3.40

Synchro-Power®

Open-end/endless polyurethane synchronous belt

T series

Standard synchronous belts for conveying and moderate power transmission applications

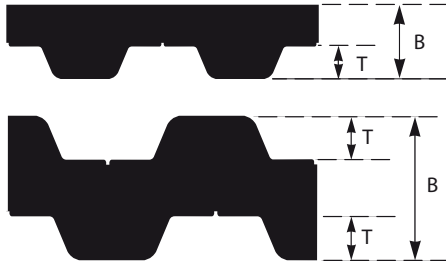

	PITCH mm	T mm	B mm
T2.5	2.5	0.70	1.30
T5	5	1.20	2.20
T10	10	2.50	4.50
T20	20	5.00	8.00
DL-T5	5	1.20	3.30
DL-T10	10	2.50	6.80

AT series

High strength synchronous belts for power transmission and high accuracy positioning applications



	PITCH mm	T mm	B mm
AT5	5	1.20	2.70
AT10	10	2.50	4.50
AT20	20	5.00	8.00

ATL series

Special linear drive belts with extra reinforced steel tensile cords designed for the highest strength and accuracy



	PITCH mm	T mm	B mm
ATL5	5	1.20	2.70
ATL10	10	2.50	4.80
ATL20	20	5.00	8.00

Trapezoidal series

Standard synchronous belts with trapezoidal tooth profile for driving and conveying applications



	PITCH mm	T mm	B mm
XL	5.08	1.27	2.29
L	9.525	1.90	3.56
H	12.7	2.29	4.06
XH	22.225	6.35	11.18

HTD® series

HTD® belts with curvilinear tooth profile with the benefits of advanced polyurethane and steel tensile cords



	PITCH mm	T mm	B mm
HTD 5M	5	2.10	3.60
HTD 8M	8	3.40	5.60
HTD 14M	14	6.00	10.00

STD series

High strength open-end belts with the benefits of advanced polyurethane and steel tensile cords



	PITCH mm	T mm	B mm
STD 5M	5	1.90	3.30
STD 8M	8	3.00	5.10

Flat series

Polyurethane flat belt with steel reinforcement for conveying applications



	B mm
F8	2.00
F12	3.20

VII. CROSS-REFERENCE LIST: V-BELTS

Belt type/brand		Optibelt	PTS Strongbelt	ContiTech	Roulunds	Megadyne	
Classical banded (Z, A, B, C, D, E)	Hi-Power® VulcoPower™	Optibelt VB	Classical V-belts	Conti-V® Standard MultiFlex	Roflex® Classical	Oleostatic®	
Narrow banded (SPZ, SPA, SPB, SPC)	Super HC® VulcoPlus™	Optibelt SK Red Power II	Wedge belt Super Power	Conti-V® Standard UltraFlex	Roflex® Narrow	SP Kompattex®	
Narrow moulded notch (SPZ, SPA, SPB, SPC)	Super HC® MN	Optibelt Super X-Power	Moulded cogged, raw edge wedge belt	Conti-V® Advance FO-Z Advance FO®- Power	Roflex RE-X® Roflex X®	Linea X Power-Wedge®	
(XPZ, XPA, XPB, XPC)	Quad-Power® II	Optibelt Super X-Power		Advance FO®- Power	Roflex RE-X®	Linea X Power-Wedge®	
Joined classical banded (A, B, C)	Hi-Power® PowerBand®	Optibelt KB	Kraftband with classical V-belt	Conti-V® Multibelt	Roflex-Joined®	PluriBand®	
Joined narrow banded (SPB, SPC, 9J, 15J, 25J/8V)	Super HC® PowerBand®	Optibelt KB Red Power II	Kraftband with wedge belt Strongbelt Super Power	Conti-V® Multibelt		PluriBand®	
Joined narrow moulded notch (3VX, 5VX, XPZ, XPA, XPB)	Quad-Power® II PowerBand®	Optibelt KBX	Kraftband with moulded cogged, raw edge wedge				
Premium classical banded (AP, BP, CP - aramid cord)	Predator®						
Premium narrow banded (SPAP, SPBP, SPCP - aramid cord)	Predator®	Optibelt Blue Power					
Premium joined narrow banded (SPBP, SPCP, 9JP, 15JP, 8VP - aramid cord)	Predator® PowerBand®	Optibelt Blue Power					
Double V (AA, BB, CC, DD)	Hi-Power® Dubl-V	Optibelt DK	Double-V belt		Roflex® Double-V	EsaFlex®	
Premium fractional horse power (2L, 3L, 4L, 5L)	PoweRated®				Roflex-Garden® V-belts	XDV	
Polyurethane V-belt (60°) (3M, 5M, 7M, 11M)	Polyflex®	Optibelt WR	V-belt- angle 60° polyurethane				
Joined polyurethane V-belt (60°) (3M-JB, 5M-JB, 7M-JB, 11M-JB)	Polyflex JB™						
V-ribbed (H, J, K, L, M)	Micro-V®	Optibelt RB	Ribbed belt	Multirib®+E4 Power	Roflex® Multi-Rib	PV	
Variable speed	Multi-Speed™	Optibelt Super VX	Moulded cogged, raw edge variable speed belt	Varispeed® (Varidur, Agridur)	Ro-Vari®	Varisect	

VII. CROSS-REFERENCE LIST: V-BELTS

	Stomil	SKF	Colmant Cuvelier	Fenner	Pix	Goodyear	Bando	Mitsuboshi
	Classic V-belt	Wrapped classical belt	Veco 100*	Fenner® Classic PB V-Belts	Power Wrap	Torque-Flex® V	Classical V-belt	Conventional
	Narrow V-belt	Wrapped wedge belt Wrapped narrow wedge	Veco 200*	Fenner® PowerPlus® wedgebelt	Power Wrap		Narrow SP Power Ace®	Maxstar wedge
		Cogged raw edge wedge belt	Veco GTX	Fenner® CRE PLUS® wedge belt Fenner® Quattro PLUS® belt	Power Edge	Torque Flex® Wedge Hy-T® Wedge	Power Ace® Cog Narrow SPX	Maxstar wedge supreme
				Fenner® Quattro PLUS® belt				
	Joined banded	Banded classical belt			Power Bank	Hy-T® Torque Team® Plus	Power King® Combo Power Scrum	Conventional Banded
	Joined banded	Banded wedge belt	Vecoband®	Fenner® Concord Plus®	Power Bank	Hy-T® Torque Team® Wedge	Power Ace® Combo	Multi Maxstar
						Hy-T® Torque Team® V	Power Ace® Cog Combo	Multi Maxstar
	Double side V-belt	Double classical (Hex) belt			Power Hex	Hex belt	Double V	
					Pix Lawn & Garden	Insta-Power™	UltraPower AG	
						Neothane®	Banflex	Polymax
							Banflex® Combo	Multi Polymax
		Ribbed belt		Fenner® Poly Drive Ribbed belts	Power Rib	Poly-V	Rib Ace®	Ribstar
	Wide V-belt		Variveco		Power Vari	Variable Speed	Power Max®	Variable Speed

VIII. CROSS-REFERENCE LIST: SYNCHRONOUS BELTS

Belt type/brand		Optibelt	PTS Strongbelt	ContiTech	Megadyne	
Trapezoidal (MXL, XL, L, H, XH, XXH)	PowerGrip® CTB	Optibelt ZR	Timing belt - inch	Synchrobel®	Isoran®	
High torque (3 mm, 5 mm, 8 mm, 14 mm, 20 mm)	PowerGrip® HTD®	Optibelt Omega Optibelt HTD®/STD®	Strongbelt M	Synchrobel® (HTD/STD)	RPP®	
Increase power rating (2 mm, 3 mm, 5 mm, 8 mm, 14 mm)	PowerGrip® GT3	Optibelt Omega HP Optibelt Omega FanPower	Strongbelt Premium	Synchroforce® CXP (III) (HTD/STD)	RPP® Plus	
Increase power rating (2 mm, 3 mm, 5 mm, 8 mm, 14 mm)	PowerGrip® GT3			Synchroforce® Supreme		
Increase power rating - improved cord (8 mm, 14 mm)	TransMotion™	Optibelt Omega HL		Synchroforce® CXA(III) (HTD/STD) Synchroforce® Extreme	RPP® Gold RPPC Ultimate	
High performance, high torque (8 mm, 14 mm)	Poly Chain® GT2			SynchroChain® CTD		
Ultimate performance, unbeaten torque (8 mm, 14 mm)	Poly Chain® GT Carbon™					
Double sided (XL, L, H, 3 mm, 5 mm, 8 mm, 14 mm)	Twin Power® CTB Twin Power® GT2	Optibelt ZR-D Optibelt HTD®-D	Double Timing belt - M	SynchroTwin® DH SynchroTwin® CXPIII	RPP® DD Isoran® DD	
Open end - rubber	Long Length	Optibelt Linear	Open-ended timing belt	SynchroLine®		
Paint and varnish compatible	PowerPaint™	Optibelt Rainbow		Synchrocolor®	MegaPaint®	

VIII. CROSS-REFERENCE LIST: SYNCHRONOUS BELTS

	SKF	Colmant Cuveliers	Fenner	Pix	Goodyear	Bando	Mitsuboshi
	Timing belt	Veco® Synchro Standard	Fenner® Classical	X' treme® Classical	Positive Drive Pd™	Synchro-Link®	Timing Belt G Timing Belt U
	HiTD	Veco® Synchro HTB	Fenner® HTD	X' treme® HTD	Hi-Performance Pd™ Plus	Synchro-Link® STS	
			Fenner® Torque Drive Plus®		SuperTorque Pd™		
					Falcon HTC™		
	Double sided timing belt Double sided HiTD belt		Twin Power®		Dual Positive Drive™ Dual Hi- Performance PD™	Synchro-Link® double sided	
			Long Length®		Open-end PD™	Open-end	

IX. BELT DRIVE PERFORMANCE EVALUATION

To provide proper maintenance, you need to understand the nature of the belt drives in your plant.

You know the expected belt service life of each drive. And you are aware of the capabilities and limitations of this equipment. Sometimes, however, it is necessary to give some thought to belt service life, especially on these occasions:

- When belt service life is meeting expectations, but you would like to reduce existing maintenance and downtime;
- When belt service life is below the expected performance level and the situation must be improved.

1. Upgrading drive performance

A belt drive can sometimes be upgraded to improve performance. The first step is to see if simple improvements can be made at minimal costs. This involves checking the drive design for adequate capacity.

Here are examples of minor changes that could improve performance:

- increase pulley diameters;
- increase the number of belts, or use wider belt;
- add vibration dampening to the system;
- improve guard ventilation to reduce operating temperature;
- make sure pulley and back idler diameters are above the minimum recommended diameters;
- use premium belts rather than general purpose types;
- replace worn pulleys;
- keep pulleys properly aligned;
- always place idler on span with lowest tension;
- re-tension newly installed friction belts after a 4-24 hour run-in period;
- review proper belt installation and maintenance procedures.

If further improvement is needed, the next step is to upgrade the drive to a higher performance belt system.

Gates is the recognised industry leader in product innovation and belt drive technology. New products and applications are continually made available to Gates customers.

You may have a problem or excessive maintenance costs with a non-belt drive, such as a gear or chain drive. Your local Gates representative can offer you excellent advice as to whether or not a belt drive could solve the problem and reduce your maintenance costs.

Your local Gates distributor or representative can help you upgrade your existing drives and reduce your maintenance and downtime costs.

2. Improving poor drive performance

If your belt drive is correctly designed, installed and maintained, it will need very little attention. Occasionally, however, a drive may be accidentally damaged or knocked out of adjustment.

Changing operating requirements or environmental conditions can also create problems. The following troubleshooting guide is designed to help you identify and correct poor drive performance problems.

When troubleshooting a drive problem, your goal is to identify the cause(s) and then to take appropriate corrective action. The information in this section will help you put your drive back in operation.

Start by a description of the problem.

- What is wrong?
- When did it happen?
- How often does it happen?
- What is the drive application?
- Have the machine operations or output changed?
- What kind(s) of belts are you using?
- What are your expectations for belt performance in this application?

Using the lists on these pages, check the problems you observe. Then move to the problem/cause/solution table on pages 34 - 40.

1. Problems on V-belt drives

Premature belt failure

- Broken belt(s)
- Belt(s) fail(s) to carry load (slip), without visible reason
- Edge cord failure
- Belt delamination or undercord separation

Severe or abnormal belt wear

- Wear on belt top surface
- Wear on belt top corners
- Wear on belt sidewalls
- Wear on belt bottom corners
- Wear on belt bottom surface
- Undercord cracking
- Burn or hardening on bottom or sidewall
- Extensive hardening of belt exterior
- Belt surface flaking, sticky or swollen

V-belts turn over or come off drive

- Single belt
- One or more belts in a set
- Joined or banded belts

Belt stretches beyond available takeup

- Single belt
- Multiple belts stretch unequally
- All belts stretch equally

Belt noise

- Squeal or "chirp"
- Slapping noise
- Rubbing sound
- Grinding sound
- Unusually loud drive

Unusual vibration

- Belts flapping
- Excessive vibration in drive system

Banded (joined) belt problems

- Tie-band separation
- Top of tie-band frayed, worn or damaged
- PowerBand® comes off drive
- One or more strands run outside of pulley

Problems with pulleys

- Broken or damaged pulley
- Severe, rapid groove wear

Problems with drive components

- Bent or broken shafts
- Damaged guard

Hot bearings



- Belt overtensioned
- Pulleys too small
- Poor bearing condition
- Pulleys too far out on shaft
- Belt slippage

Performance problems



- Incorrect driveN speeds

X. TROUBLESHOOTING GUIDE: V-BELTS

2. Problem/cause/solution table

	SYMPTOMS	PROBABLE CAUSE	SOLUTION
PREMATURE BELT FAILURE	Broken belt(s) 	<ol style="list-style-type: none"> 1. Underdesigned drive 2. Belt rolled or prised onto pulley 3. Object falling into drive 4. Severe shock load 	<ol style="list-style-type: none"> 1. Redesign using Gates Drive Design Manual (E2/20070). 2. Use drive takeup when installing. 3. Provide adequate guard or drive protection. 4. Redesign to accommodate shock load.
	Belt fails to carry load (slip); no visible reason	<ol style="list-style-type: none"> 1. Underdesigned drive 2. Damaged tensile member 3. Worn pulley grooves 4. Centre distance movement 	<ol style="list-style-type: none"> 1. Redesign using Gates Drive Design Manual (E2/20070). 2. Follow correct installation procedure. 3. Check for groove wear, replace as needed. 4. Check drive for centre distance movement during operation.
	Edge cord failure	<ol style="list-style-type: none"> 1. Pulley misalignment 2. Damaged tensile member 	<ol style="list-style-type: none"> 1. Check and correct alignment. 2. Follow installation procedure.
	Belt delamination or undercord separation	<ol style="list-style-type: none"> 1. Pulleys too small 2. Back idler too small 	<ol style="list-style-type: none"> 1. Check drive design, replace with larger pulleys. 2. Increase back idler to acceptable diameter.
SEVERE OR ABNORMAL BELT WEAR	Wear on belt top surface	<ol style="list-style-type: none"> 1. Rubbing against guard 2. Idler malfunction 	<ol style="list-style-type: none"> 1. Replace or repair guard. 2. Replace idler.
	Wear on belt top corner	<ol style="list-style-type: none"> 1. Belt-to-pulley fit incorrect (belt too small for groove) 	<ol style="list-style-type: none"> 1. Use correct belt-to-pulley combination.
	Wear on belt sidewalls 	<ol style="list-style-type: none"> 1. Belt slip 2. Misalignment 3. Worn pulleys 4. Incorrect belt 	<ol style="list-style-type: none"> 1. Retension until slipping stops. 2. Realign pulleys. 3. Replace pulleys. 4. Replace with correct belt size.
	Wear on belt bottom corners	<ol style="list-style-type: none"> 1. Belt-to-pulley fit incorrect 2. Worn pulleys 	<ol style="list-style-type: none"> 1. Use correct belt-to-pulley combination. 2. Replace pulleys.
	Wear on belt bottom surface 	<ol style="list-style-type: none"> 1. Belt bottoming on pulley groove 2. Worn pulleys 3. Debris in pulleys 	<ol style="list-style-type: none"> 1. Use correct belt/pulley match. 2. Replace pulleys. 3. Clean pulleys.
	Undercord cracking	<ol style="list-style-type: none"> 1. Pulley diameter too small 2. Belt slip 3. Back idler too small 4. Improper storage 	<ol style="list-style-type: none"> 1. Use larger diameter pulleys. 2. Retension. 3. Use larger diameter back idler. 4. Do not coil belt too tightly, kink or bend. Avoid heat and direct sunlight.

X. TROUBLESHOOTING GUIDE: V-BELTS

	SYMPTOMS	PROBABLE CAUSE	SOLUTION
SEVERE OR ABNORMAL BELT WEAR	<p>Burn or hardening on bottom or sidewall</p> 	<ol style="list-style-type: none"> 1. Belt slip 2. Worn pulleys 3. Underdesigned drive 4. Shaft movement 	<ol style="list-style-type: none"> 1. Retension until slipping stops. 2. Replace pulleys. 3. Redesign using Gates Drive Design Manual (E2/20070). 4. Check for centre distance changes.
	<p>Extensive hardening of belt exterior</p>	<ol style="list-style-type: none"> 1. Hot drive environment 	<ol style="list-style-type: none"> 1. Improve ventilation to drive.
	<p>Belt surface flaking, sticky or swollen</p> 	<ol style="list-style-type: none"> 1. Oil or chemical contamination 	<ol style="list-style-type: none"> 1. Do not use belt dressing. Eliminate sources of oil, grease or chemical contamination.
V-BELTS TURN OVER OR COME OFF DRIVE	<p>Involves single or multiple belts</p> 	<ol style="list-style-type: none"> 1. Shock loading or vibration 2. Foreign material in grooves 3. Misaligned pulleys 4. Worn pulley grooves 5. Damaged tensile member 6. Incorrectly placed flat idler pulley 7. Mismatched belt set 8. Poor drive design 	<ol style="list-style-type: none"> 1. Check drive design. Use Gates PowerBand® belts. 2. Shield grooves and drive. 3. Realign pulleys. 4. Replace pulleys. 5. Use correct installation and belt storage procedure. 6. Carefully place flat idler on slack side of drive as close as possible to driveR pulleys. 7. Replace with new set of matched belts. Do not mix old and new belts. 8. Check for centre distance stability and vibration dampening.
BELT STRETCHES BEYOND AVAILABLE TAKEUP	<p>Multiple belts stretch unequally</p>	<ol style="list-style-type: none"> 1. Misaligned drive 2. Debris in pulleys 3. Broken tensile member or cord damaged 4. Mismatched belt set 	<ol style="list-style-type: none"> 1. Realign and retension drive. 2. Clean pulleys. 3. Replace all belts, install properly. 4. Install matched belt set.
	<p>Single belt, or where all belts stretch evenly</p>	<ol style="list-style-type: none"> 1. Insufficient takeup allowance 2. Grossly overloaded or underdesigned drive 3. Broken tensile members 	<ol style="list-style-type: none"> 1. Check takeup. Use allowance specified in Gates Drive Design Manual (E2/20070). 2. Redesign drive. 3. Replace belt, install properly.
BELT NOISE	<p>Squeal or "chirp"</p>	<ol style="list-style-type: none"> 1. Belt slip 2. Contamination 	<ol style="list-style-type: none"> 1. Retension. 2. Clean belts and pulleys.
	<p>Slapping noise</p>	<ol style="list-style-type: none"> 1. Loose belts 2. Mismatched set 3. Misalignment 	<ol style="list-style-type: none"> 1. Retension. 2. Install matched belt set. 3. Realign pulleys so all belts share load equally.
	<p>Rubbing sound</p>	<ol style="list-style-type: none"> 1. Guard interference 	<ol style="list-style-type: none"> 1. Repair, replace or redesign guard.

X. TROUBLESHOOTING GUIDE: V-BELTS

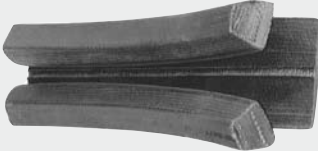
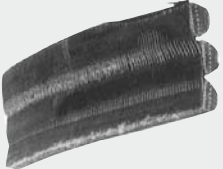
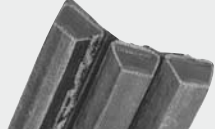
	SYMPTOMS	PROBABLE CAUSE	SOLUTION
BELT NOISE	Grinding sound	1. Damaged bearings	1. Replace, align and lubricate.
	Unusually loud drive	1. Incorrect belt 2. Worn pulleys 3. Debris in pulleys	1. Use correct belt size. Use correct belt tooth profile for pulleys on synchronous drive. 2. Replace pulleys. 3. Clean pulleys, improve shielding, remove rust, paint or dirt from grooves.
UNUSUAL VIBRATION	Belts flapping	1. Belts undertensioned 2. Mismatched belts 3. Pulley misalignment	1. Retension. 2. Install new matched set. 3. Align pulleys.
	Excessive vibration in drive system	1. Incorrect belt 2. Poor machine or equipment design 3. Pulley out of round 4. Loose drive components	1. Use correct belt section in pulley. 2. Check structure and brackets for adequate strength. 3. Replace pulley. 4. Check machine components and guards, motor mounts, motor pads, bushings, brackets and framework for stability, adequate design strength, proper maintenance and proper installation.
BANDED (JOINED) BELT PROBLEMS	Tie-band separation 	1. Worn pulleys 2. Improper groove spacing	1. Replace pulleys. 2. Use standard groove pulleys.
	Top of tie-band frayed, worn or damaged 	1. Interference with guard 2. Back idler malfunction or damaged	1. Check guard. 2. Repair or replace back idler.
	PowerBand® comes off drive	1. Debris in pulleys	1. Clean grooves. Use single belts to prevent debris from being trapped in grooves.
	One or more ribs run outside of pulley 	1. Misalignment 2. Undertensioned	1. Realign drive. 2. Retension.

X. TROUBLESHOOTING GUIDE: V-BELTS

	SYMPTOMS	PROBABLE CAUSE	SOLUTION
PULLEY PROBLEMS	Broken or damaged pulley	<ol style="list-style-type: none"> 1. Incorrect pulley installation 2. Foreign objects falling into drive 3. Excessive rim speeds 4. Incorrect belt installation 	<ol style="list-style-type: none"> 1. Do not tighten bushing bolts beyond recommended torque values. 2. Use adequate drive guard. 3. Keep pulley rim speeds below maximum recommended values. 4. Do not prise belts onto pulleys.
	Severe, rapid groove wear	<ol style="list-style-type: none"> 1. Excessive belt tension 2. Sand, debris or contamination 	<ol style="list-style-type: none"> 1. Retension, check drive design. 2. Clean and shield drive as well as possible.
PROBLEMS WITH OTHER DRIVE COMPONENTS	Bent or broken shaft	<ol style="list-style-type: none"> 1. Extreme belt overtension 2. Overdesigned drive* 3. Accidental damage 4. Machine design error 	<ol style="list-style-type: none"> 1. Retension. 2. Check drive design, may need to use smaller or fewer belts. 3. Redesign drive guard. 4. Check machine design.
	Damaged guard	<ol style="list-style-type: none"> 1. Accidental damage or poor guard design 	<ol style="list-style-type: none"> 1. Repair, redesign for durability.
HOT BEARINGS	Belt overtensioned	<ol style="list-style-type: none"> 1. Worn grooves - belts bottoming and will not transmit power until overtensioned* 2. Improper tension 	<ol style="list-style-type: none"> 1. Replace pulleys, tension drive properly. 2. Retension.
	Pulleys too small	<ol style="list-style-type: none"> 1. Motor manufacturer's pulley diameter recommendation not followed 	<ol style="list-style-type: none"> 1. Redesign using Gates Drive Design Manual (E2/20070).
	Poor bearing condition	<ol style="list-style-type: none"> 1. Bearing underdesigned 2. Bearing not properly maintained 	<ol style="list-style-type: none"> 1. Check bearing design. 2. Align and lubricate bearing.
	Pulleys too far out on shaft	<ol style="list-style-type: none"> 1. Error or obstruction problem 	<ol style="list-style-type: none"> 1. Place pulleys as close as possible to bearings. Remove obstructions.
	Belt slippage	<ol style="list-style-type: none"> 1. Drive undertensioned 	<ol style="list-style-type: none"> 1. Retension.
PERFORMANCE PROBLEMS	Incorrect driveN speeds	<ol style="list-style-type: none"> 1. Design error 2. Belt slip 	<ol style="list-style-type: none"> 1. Use correct driveR/driveN pulley size for desired speed ratio. 2. Retension drive.

* Using too many belts, or belts that are too large, can severely stress motor or driveN shafts. This can happen when load requirements are reduced on a drive, but the belts are not redesigned accordingly. This can also happen when a drive is greatly overdesigned. Forces created from belt tensioning are too great for the shafts.

XI. TROUBLESHOOTING GUIDE: SYNCHRONOUS BELTS

1. Problems on synchronous belt drives

Belt problems

- Unusual noise
- Tension loss
- Excessive belt edge wear
- Tensile break
- Belt cracking
- Premature tooth wear
- Tooth shear

Pulley problems

- Flange failure
- Unusual pulley wear

Performance problems





- Belt tracking problems
- Excessive temperature: bearings, housings, shafts, etc.
- Shafts out of synchronisation
- Vibration
- Incorrect driveN speeds

2. Problem/cause/solution table

	SYMPTOMS	PROBABLE CAUSE	SOLUTION
PROBLEMS WITH SYNCHRONOUS BELTS	Unusual noise	<ol style="list-style-type: none"> 1. Misaligned drive 2. Too low or high tension 3. Back idler 4. Worn pulley 5. Bent guide flange 6. Belt speed too high 7. Incorrect belt profile for pulley (i.e. HTD®, GT, etc) 8. Subminimal diameter 9. Excess load 	<ol style="list-style-type: none"> 1. Correct alignment. 2. Adjust to recommended value. 3. Use inside idler. 4. Replace pulley. 5. Replace guide flange. 6. Redesign drive. 7. Use proper belt/pulley combination. 8. Redesign drive using larger diameters. 9. Redesign drive for increased capacity.
	Tension loss	<ol style="list-style-type: none"> 1. Weak support structure 2. Excessive pulley wear 3. Fixed (non-adjustable) centres 4. Excessive debris 5. Excessive load 6. Subminimal diameter 7. Belt, pulley or shafts running too hot 8. Unusual belt degradation 	<ol style="list-style-type: none"> 1. Reinforce structure. 2. Use other pulley material. 3. Use inside idler for belt adjustment. 4. Remove debris, check guard. 5. Redesign drive for increased capacity. 6. Redesign drive using larger diameters. 7. Check for conductive heat transfer from prime mover. 8. Reduce ambient drive temperature to +85°C (185°F) maximum.

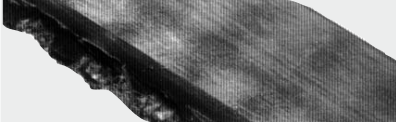
XI. TROUBLESHOOTING GUIDE: SYNCHRONOUS BELTS

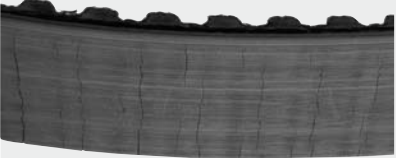
PROBLEMS WITH SYNCHRONOUS BELTS

SYMPTOMS	PROBABLE CAUSE	SOLUTION
<p>Excessive belt edge wear</p> 	<ol style="list-style-type: none"> 1. Damage due to handling 2. Flange damage 3. Belt too wide 4. Belt tension too low 5. Rough flange surface finish 6. Improper tracking 7. Belt hitting drive guard or bracketry 	<ol style="list-style-type: none"> 1. Follow proper handling instructions. 2. Repair flange or replace pulley. 3. Use proper width pulley. 4. Adjust tension to recommended value. 5. Replace or repair flange (to eliminate abrasive surface). 6. Correct alignment. 7. Remove obstruction or use inside idler.
<p>Tensile break</p> 	<ol style="list-style-type: none"> 1. Excessive shock load 2. Subminimal diameter 3. Improper belt handling and storage prior to installation 4. Debris or foreign object in drive 5. Extreme pulley run-out 	<ol style="list-style-type: none"> 1. Redesign drive for increased capacity. 2. Redesign drive using larger diameters. 3. Follow proper handling and storage procedures. 4. Remove object and check guard. 5. Replace pulley.
<p>Belt cracking</p> 	<ol style="list-style-type: none"> 1. Subminimal diameter 2. Back idler 3. Extreme low temperature at start-up 4. Extended exposure to harsh chemicals 5. Cocked bushing/pulley assembly 	<ol style="list-style-type: none"> 1. Redesign drive using larger diameter. 2. Use inside idler or increase diameter of back idler. 3. Pre-heat drive environment. 4. Protect drive. 5. Install bushing as per instructions.
<p>Premature tooth wear</p> 	<ol style="list-style-type: none"> 1. Too low or too high belt tension 2. Belt running partly off unflanged pulley 3. Misaligned drive 4. Incorrect belt profile for pulley (i.e. HTD®, GT, etc) 5. Worn pulley 6. Rough pulley teeth 7. Damaged pulley 8. Pulley not to dimensional specification 9. Belt hitting drive bracketry or other structure 10. Excessive load 11. Insufficient hardness of pulley material 12. Excessive debris 13. Cocked bushing/pulley assembly 	<ol style="list-style-type: none"> 1. Adjust to recommended value. 2. Correct alignment. 3. Correct alignment. 4. Use proper belt/pulley combination. 5. Replace pulley. 6. Replace pulley. 7. Replace pulley. 8. Replace pulley. 9. Remove obstruction or use idler. 10. Redesign drive for increased capacity. 11. Use a more wear-resistant pulley. 12. Remove debris, check guard. 13. Install bushings as per instructions.
<p>Tooth shear</p> 	<ol style="list-style-type: none"> 1. Excessive shock loads 2. Less than 6 teeth in mesh 3. Extreme pulley run-out 4. Worn pulley 5. Back idler 6. Incorrect belt profile for pulley (i.e. HTD®, GT, etc) 7. Misaligned drive 8. Belt undertensioned 	<ol style="list-style-type: none"> 1. Redesign drive for increased capacity. 2. Redesign drive. 3. Replace pulley. 4. Replace pulley. 5. Use inside idler. 6. Use proper belt/pulley combination. 7. Correct alignment. 8. Adjust tension to recommended value.

XI. TROUBLESHOOTING GUIDE: SYNCHRONOUS BELTS

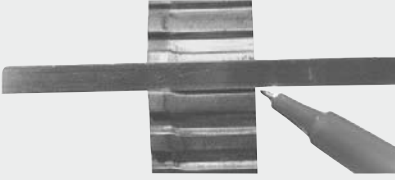
	SYMPTOMS	PROBABLE CAUSE	SOLUTION
SPROCKET PROBLEMS	Flange failure	1. Belt forcing flange off	1. Correct alignment or properly secure flange to pulley.
	Unusual pulley wear 	1. Pulley has too little wear resistance (e.g. plastic, soft metals, aluminium) 2. Misaligned drive 3. Excessive debris 4. Excessive load 5. Too low or too high belt tension 6. Incorrect belt profile for pulley (i.e. HTD®, GT, etc)	1. Use alternative pulley material. 2. Correct alignment. 3. Remove debris, check guard. 4. Redesign drive for increased capacity. 5. Adjust tension to recommended value. 6. Use proper belt/pulley combination.
PERFORMANCE PROBLEMS WITH SYNCHRONOUS BELTS	Belt tracking problems	1. Belt running partly off unflanged pulley 2. Centres exceed 8 times small pulley diameter and both pulleys are flanged 3. Excessive belt edge wear	1. Correct alignment. 2. Correct parallel alignment to set belt to track on both pulleys. 3. Correct alignment.
	Excessive temperature: belt, bearings, housings or shafts, etc.	1. Misaligned drive 2. Too low or too high belt tension 3. Incorrect belt profile for pulley (i.e. HTD®, GT, etc)	1. Correct alignment. 2. Adjust tension to recommended value. 3. Use proper belt/pulley combination.
	Shafts out of synchronisation	1. Design error 2. Incorrect belt	1. Use correct pulley sizes. 2. Use correct belt with correct tooth profile for grooves.
	Vibration	1. Incorrect belt profile for pulley combination (i.e. HTD®, GT, etc) 2. Too low or too high belt tension 3. Bushing or key loose	1. Use proper belt/pulley. 2. Adjust tension to recommended value. 3. Check and reinstall as per instructions.
	Incorrect driveN speeds	1. Design error	1. Redesign drive.

What to do when all else fails

We have made every effort to cover all of the common drive problems that you may encounter. However, if the problem still exists after all your troubleshooting efforts have been exhausted, contact your Gates distributor. If he cannot solve the problem for you, he will put you in touch with a Gates representative. Expert help is always available to you.

To determine the cause of a drive problem, you can rely on a range of tools from the surprisingly simple to the technical - some of which are available from Gates. An overview of the possibilities.

1. Eyes, ears, nose and hands

Observing the drive while in operation or at rest may indicate problem areas. Can you see anything unusual about the way the belt travels around the drive? Do you smell warm rubber? Is the drive frame flexing under load? Do you hear chirping, squealing or grinding noises? Is there an accumulation of fabric dust under the drive which may interfere with the belts?

Once the drive is shut down, you can use your hands. Your hand can tolerate up to about 45°C (113°F), the maximum temperature at which a properly maintained belt should operate. If you cannot touch the belt after operation, this could indicate a problem which causes heat buildup.

Feel the pulley grooves. They should be smooth, free of nicks and debris. Inspect the belt for unusual wear patterns, signs of burning or cracking.

2. Squirt bottle with soapy water

When a belt drive is excessively noisy, the belt is often incorrectly blamed. With V- or Micro-V® belt drives, spray the belt with soapy water while the drive is running. If the noise goes away or decreases, the belt is part of the problem. If you still hear the same noise, the problem is likely to be due to other drive components.

3. Ball of string

Variation in drive centre distance, often caused by a weak supporting structure, can cause problems from vibration to short belt life. To determine if centre distance variation exists, turn off the drive and tightly tie a piece of string from the driveR to the driveN shaft.

Start up the drive and note if the string stretches almost to the point of breaking, or goes slack. If either is the case, the problem could be centre distance variation. It is particularly important you observe the string at the moment of start-up, when the loads are highest.

String can also be used to check pulley alignment.

4. Belt and sheave gauge

If you suspect a belt-to-pulley groove mismatch in a V-belt drive, belt and sheave gauges can be used to check dimensions. These are also handy for identifying a belt section for replacements, and for checking pulley grooves for wear. Available from Gates.



5. Long straight edge

While V-belts can be somewhat forgiving of misalignment, this condition can still affect V-belt performance. Even slight misalignment can cause major problems on a synchronous drive.

Use a long straight edge to quickly check drive alignment. Simply lay the straight edge across the pulley faces and note the points of contact (or lack of contact). Remember to check whether pulleys are identical before starting.

6. MRO engineering tool bag



Nearly 100 years of continuous research enables us to offer unique experience in solving drive system problems. Gates technical teams have the expertise to develop

the right drive system solution for any problem. And not unimportant... they use a set of handy and practical tools to conduct drive analysis.

Gates offers you this complete set of specialised tools gathered together in one bag, the Gates MRO engineering tool bag. To facilitate belt drive inspection and maintenance of your machinery, you simply need to have the right tool at hand.

XII. TROUBLESHOOTING METHODS AND TOOLS

Analytical tools

Strobe light

You cannot always see what is happening to a drive while it is in operation. The strobe light allows you to stop the action to get a better idea of the dynamic forces affecting the drive. This instrument is best used after initial diagnosis of the problem because it helps pinpoint the cause. It will help you identify such things as single or dual mode belt span vibration and frame flexure. It is also used to measure and check rotation and vibration movements and to facilitate the measurement of very small objects or hard-to-access places. (Note: this tool is available from Gates.)



Infra-red thermometer

While your hands can be the first check for belt temperature problems, the infra-red thermometer allows you to measure belt temperatures more accurately. The device collects the infra-red energy radiated by the belt and transforms it into a temperature value. It offers quick and reliable surface temperature readings without contact.

(Note: this tool is available from Gates.)



Laser alignment device

LASER AT-1 identifies parallel as well as angular misalignment between the pulleys and is suitable for pulley diameters of 60 mm and larger. Mounted in a few seconds, the laser line projected on the targets allows you to quickly ascertain and correct misalignment. It can be used on both horizontally and vertically mounted machines.

(Note: this tool is available from Gates.)



Sound level meter

This A/C rated instrument allows you to quickly and accurately measure the noise level your drive produces in dB. It distinguishes noises ranging from 30 dB to 130 dB.

(Note: this tool is only available when buying the Gates MRO tool bag and cannot be bought separately.)



Digital multimeter

If belts are failing prematurely, it is possible the drive load was underestimated when the drive was designed. Use the digital multimeter to check the actual load being delivered by an electric motor. The clamp-on style allows you to do this safely, without baring wires or worrying about electrical connections. This tool can also be used to troubleshoot vibration problems if they are caused by electrical sources such as arcing switches, power surges or electrical connections.

(Note: this tool is only available when buying the Gates MRO tool bag and cannot be bought separately.)



3 Tension meters

Improper belt tension, either too high or too low, can cause belt drive problems.

Although the “experienced thumb” will suit ordinary V-belt drives, Gates recommends the use of the tension gauge for critical drives. Several tension meter types are available. The pencil type suits most situations. To facilitate tension measuring, Gates has developed two tension testers. The “Single tension tester” measures deflection force of up to ± 12 kg and the “Double tension tester” measures deflection force of up to ± 30 kg.

Gates also supplies the 507 sonic tension meter working with sound waves. The prime advantage of this device is complete reliability and hence repeatability of measurement. The 507C sonic tension meter ensures simple and extremely accurate tension measurement by analysing sound waves from the belt through the sensor. It processes the input signals and displays the accurate tension measurement digitally. Consult your Gates representative for suitability of the tension meter for different belt product lines.

Also consult pages 7 to 8 for more information. (Note: all tension meters are available from Gates.)

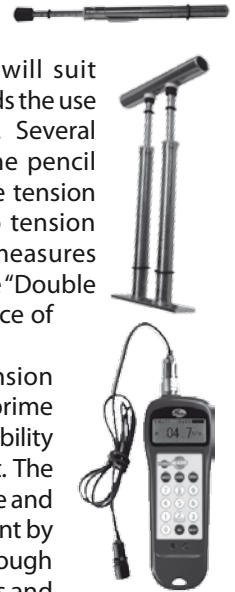

Digital caliper

By means of this device you can determine pulley, belt and other components’ dimensions, ranging from 0.01 mm to 150 mm.

(Note: this tool is only available when buying the Gates MRO tool bag and cannot be bought separately.)



Support tools

- Flashlight
- 2 different screwdriver sets
- Eye protector
- Length gauge
- Multitool
- Inspection mirror
- Ear protector
- Overall
- Digital camera

(Note: these tools are only available when buying the Gates MRO tool bag and cannot be bought separately.)

Under favourable storage conditions, good quality belts retain their initial serviceability and dimensions. Conversely, unfavourable conditions can adversely affect performance and cause dimensional changes.

1. General guidelines

Store your belts in a cool and dry environment with no direct sunlight. When stacked on shelves, the stacks should be small enough to prevent distortion of the bottom belts. When stored in containers, the container size should be sufficiently limited for the same reason.

Caution:

- Do not store belts on floors unless a suitable container is provided. They may be exposed to waterleaks or moisture or be damaged due to traffic.
- Do not store belts near windows (sunlight / moisture).
- Do not store belts near radiators or heaters or in the air flow from heating devices.
- Do not store belts in the vicinity of transformers, electric motors, or other electric devices that may generate ozone.
- Avoid areas where evaporating solvents or other chemicals are present in the atmosphere.
- Do not store belts in a configuration that would result in bend diameters less than the minimum recommended pulley diameter for normal bends and less than 1.2 times the minimum recommended diameters for reverse bends (consult section XI for minimum recommended diameters).

2. Methods of storage

2.1 V-belts

V-belts are often stored on pegs. Very long belts should be stored on sufficiently large pins (of not less than the minimum bend diameter), or crescent-shaped “saddles”, to prevent their weight from causing distortion. Long V-belts may be coiled in loops for easy distortion-free storage.

2.2 Joined V-belts and multi-ribbed belts

Like V-belts, these belts may be stored on pins or saddles with precaution to avoid distortion. However, belts of this type up to approx. 3000 mm are normally shipped in a “nested” configuration, and it is necessary that especially joined V-belts be stored in a naturally relaxed form, and only nested or rolled up for transportation.

2.3 Synchronous belts

For synchronous belts, nests are formed by laying a belt on its side on a flat surface and placing as many belts inside the first belt as possible without undue force. When tight, the nests can be stacked without damage. Belts over approx. 3000 mm may be “rolled up” and tied for shipment. These rolls may be stacked for easy storage. Avoid small bend radii by inserting card tubes in the packaging.

2.4 Variable speed belts

These belts are more sensitive to distortion than most other belts. Hanging them from pins or racks is not recommended. These belts should be stored on shelves. Variable speed belts are often shipped in “sleeves” slipped over the belt. They should be stored on shelves in these sleeves. If they are shipped “nested”, untie the nests and store them in a relaxed position.

3. Effects of storage

The quality of belts has not been found to change significantly within 8 years of proper storage at temperatures up to 30°C (86°F) and relative humidity below 70%. Also there must be no exposure to direct sunlight. Ideal storage conditions are between 5°C (41°F) and 30°C (86°F).

If storage temperature is in excess of 30°C (86°F), the storage time will be reduced and belt service levels could be significantly reduced also. Under no circumstances should storage temperatures above 46°C (115°F) be reached.

With a significant increase in humidity, it is possible for fungus or mildew to form on stored belts. This does not appear to cause serious belt damage but should be avoided if possible.

Equipment using belts is sometimes stored or left idle for longer periods (6 months or more). It is recommended that the tension on the belts be relaxed during such periods. Equipment storage conditions should be consistent with the guidelines for belt storage. If this is impossible, remove the belts and store them separately.

Maximum number of coils for V-belts

Belt cross section	Belt length (mm)	Coils	Loops
Z, SPZ, A, SPA, B, SPB, 3L, 4L, 5L	<1500	0	1
	1500-3000	1	3
	3000-4600	2	5
	>4600	3	7
C, SPC	<1900	0	1
	1900-3700	1	3
	3700-6000	2	5
	>6000	3	7
D	<3000	0	1
	3000-6100	1	3
	6100-8400	2	5
	8400-10600	3	7
	>10600	4	9
8V	<4600	0	1
	4600-6900	1	3
	6900-9900	2	5
	9900-12200	3	7
	>12200	4	9

V-BELTS

Groove dimension nomenclature for V-belts

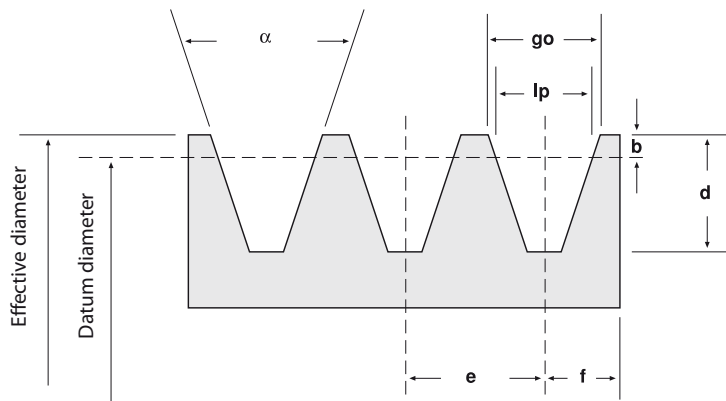

Table 1

Groove dimensions and tolerances according to ISO 4183, DIN 2211 and DIN 2217 engineering standards

Belt section	Datum width lp mm	Datum diameter mm	Groove angle α	go mm	d mm	e mm	f* mm	b mm
Z** SPZ*** XPZ	8,5	63 to 80 > 80	34° ± 1° 38° ± 1°	9.72 9.88	11 (+0.25/-0) 11 (+0.25/-0)	12 ± 0.30 12 ± 0.30	8 ± 0.6 8 ± 0.6	2 2
A** SPA*** XPA	11	90 to 118 > 118	34° ± 1° 38° ± 1°	12.68 12.89	13,75 (+0.25/-0) 13,75 (+0.25/-0)	15 ± 0.30 15 ± 0.30	10 ± 0.6 10 ± 0.6	2.75 2.75
B** SPB*** SPB-PB XPB	14	140 to 190 > 190	34° ± 1° 38° ± 1°	16.14 16.41	17,5 (+0.25/-0) 17,5 (+0.25/-0)	19 ± 0.40 19 ± 0.40	12,5 ± 0.8 12,5 ± 0.8	3.5 3.5
C** SPC*** SPC-PB XPC	19	224 to 315 > 315	34° ± 1/2° 38° ± 1/2°	21.94 22.31	24 (+0.25/-0) 24 (+0.25/-0)	25.5 ± 0.50 25.5 ± 0.50	17 ± 1.0 17 ± 1.0	4.8 4.8
D** mm	27	355 to 500 > 500	36° ± 1/2° 38° ± 1/2°	32 32	28 (min.) 28 (min.)	37 ± 0.60 37 ± 0.60	24 (±2) 24 (±2)	8.1 8.1
E** mm	32	500 to 630 > 630	36° ± 1/2° 38° ± 1/2°	40 40	33 (min.) 33 (min.)	44.5 ± 0.70 44.5 ± 0.70	29 (±2) 29 (±2)	12 12

Tolerances on datum diameters can be calculated by applying the tolerance (+ 1.6 /- 0%) to the nominal value of the datum diameter in mm.

* These tolerances have to be taken into account when aligning the pulleys.

** According to DIN 2217.

*** According to DIN 2211 and ISO 4183.

Table 2
Groove dimensions and tolerances for Hi-Power® PowerBand® according to RMA engineering standards

Belt section	Effective diameter mm	Groove angle α $\pm 1/2^\circ$	go mm	d mm ± 0.79	e* mm ± 0.60	f mm
A - PowerBand®	< 140	34°	12.55 ± 0.13	12.45	15.88	9.53 (+1.78/-0)
	> 140	38°	12.80 ± 0.13	12.45	15.88	9.53 (+1.78/-0)
B - PowerBand®	< 180	34°	16.18 ± 0.13	14.73	19.05	12.70 (+3.80/-0)
	> 180	38°	16.51 ± 0.13	14.73	19.05	12.70 (+3.80/-0)
C - PowerBand®	< 200	34°	22.33 ± 0.18	19.81	25.40	17.48 (+3.80/-0)
	200 to 315	36°	22.53 ± 0.18	19.81	25.40	17.48 (+3.80/-0)
	> 315	38°	22.73 ± 0.18	19.81	25.40	17.48 (+3.80/-0)
D - PowerBand®	< 355	34°	31.98 ± 0.18	26.67	36.53	22.23 (+6.35/-0)
	355 to 450	36°	32.28 ± 0.18	26.67	36.53	22.23 (+6.35/-0)
	> 450	38°	32.59 ± 0.18	26.67	36.53	22.23 (+6.35/-0)

* Summation of the deviations from "e" for all grooves in any pulley shall not exceed ± 1.2 mm.

Table 3
Groove dimensions and tolerances for Super HC® PowerBand® according to ISO 5290 engineering standards

Belt section	Effective diameter mm	Groove angle α $\pm 1/4^\circ$	go mm ± 0.13	d mm (+0.25/-0)	e* mm ± 0.40	f mm
9J PowerBand®	< 90	36°	8.9	8.9	10.3	9 (+2.4/-0)
	90 to 150	38°	8.9	8.9	10.3	9 (+2.4/-0)
	151 to 300	40°	8.9	8.9	10.3	9 (+2.4/-0)
	> 300	42°	8.9	8.9	10.3	9 (+2.4/-0)
15J PowerBand®	< 250	38°	15.2	15.2	17.5	13 (+3.2/-0)
	250 to 400	40°	15.2	15.2	17.5	13 (+3.2/-0)
	>400	42°	15.2	15.2	17.5	13 (+3.2/-0)
25J PowerBand®	< 400	38°	25.4	25.4	28.6	19 (+6.3/-0)
	400 to 560	40°	25.4	25.4	28.6	19 (+6.3/-0)
	> 560	42°	25.4	25.4	28.6	19 (+6.3/-0)

* Summation of the deviations from "e" for all grooves in any pulley shall not exceed ± 0.5 mm for 9J and 15J, ± 0.8 mm for 25J.

Table 4
Groove dimensions and tolerances for Super HC® PowerBand® according to RMA engineering standards

Belt section	Datum width mm	Effective diameter mm	Groove angle α $\pm 1/4^\circ$	go mm ± 0.13	d mm (minimum)	e* mm ± 0.40	f mm	b mm
3V/3VX and PowerBand®	8.45	< 90	36°	8.89	8.6	10.32	8.73 (+2.4/-0)	0.65
		90 to 150	38°	8.89	8.6	10.32	8.73 (+2.4/-0)	0.65
		151 to 300	40°	8.89	8.6	10.32	8.73 (+2.4/-0)	0.65
		> 300	42°	8.89	8.6	10.32	8.73 (+2.4/-0)	0.65
5V/5VX and PowerBand®	14.40	< 250	38°	15.24	15.0	17.46	12.70 (+3.2/-0)	1.25
		250 to 400	40°	15.24	15.0	17.46	12.70 (+3.2/-0)	1.25
		> 400	42°	15.24	15.0	17.46	12.70 (+3.2/-0)	1.25
8V/8VK and PowerBand®	23.65	< 400	38°	25.4	25.1	28.58	19.05 (+6.3/-0)	2.54
		400 to 560	40°	25.4	25.1	28.58	19.05 (+6.3/-0)	2.54
		> 560	42°	25.4	25.1	28.58	19.05 (+6.3/-0)	2.54

* Summation of the deviations from "e" for all grooves in any pulley shall not exceed ± 0.79 mm.

MICRO-V® BELTS

Groove dimension nomenclature for Micro-V® belts

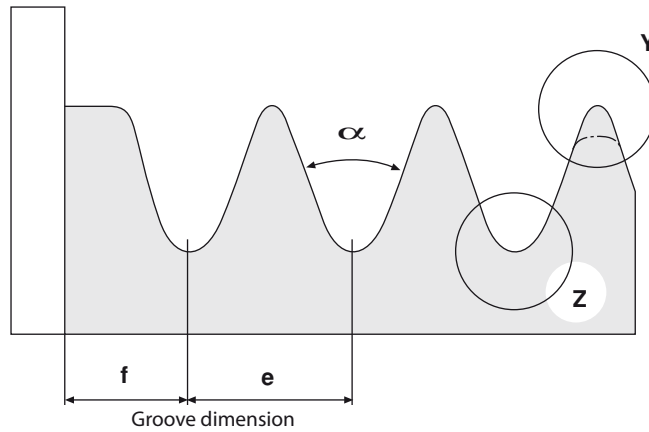

Detail Y: Groove top

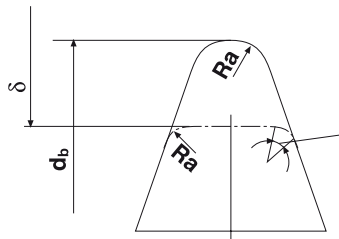

The design of the groove top may not exceed indicated minimum and maximum values (depending on pulley manufacture).

Detail Z: Groove bottom

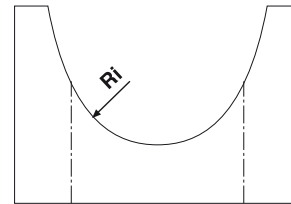

The groove bottom design may not exceed the indicated Ri value (depending on pulley manufacture).

Table 5

Groove dimensions and tolerances for Micro-V® according to DIN 7867 and ISO 9981 engineering standards

Belt section	Groove angle α	e* mm	Ri mm max.	Ra mm min.	f mm min.
PJ	$40 \pm 1/2^\circ$	2.34 ± 0.03	0.40	0.20	1.8
PK	$40 \pm 1/2^\circ$	3.56 ± 0.05	0.50	0.25	2.5
PL	$40 \pm 1/2^\circ$	4.70 ± 0.05	0.40	0.40	3.3
PM	$40 \pm 1/2^\circ$	9.40 ± 0.08	0.75	0.75	6.4

* Summation of the deviations from "e" for all grooves in any pulley shall not exceed ± 0.30 mm.

POLYFLEX® JB™ BELTS

Groove dimension nomenclature for Polyflex® JB™ belts

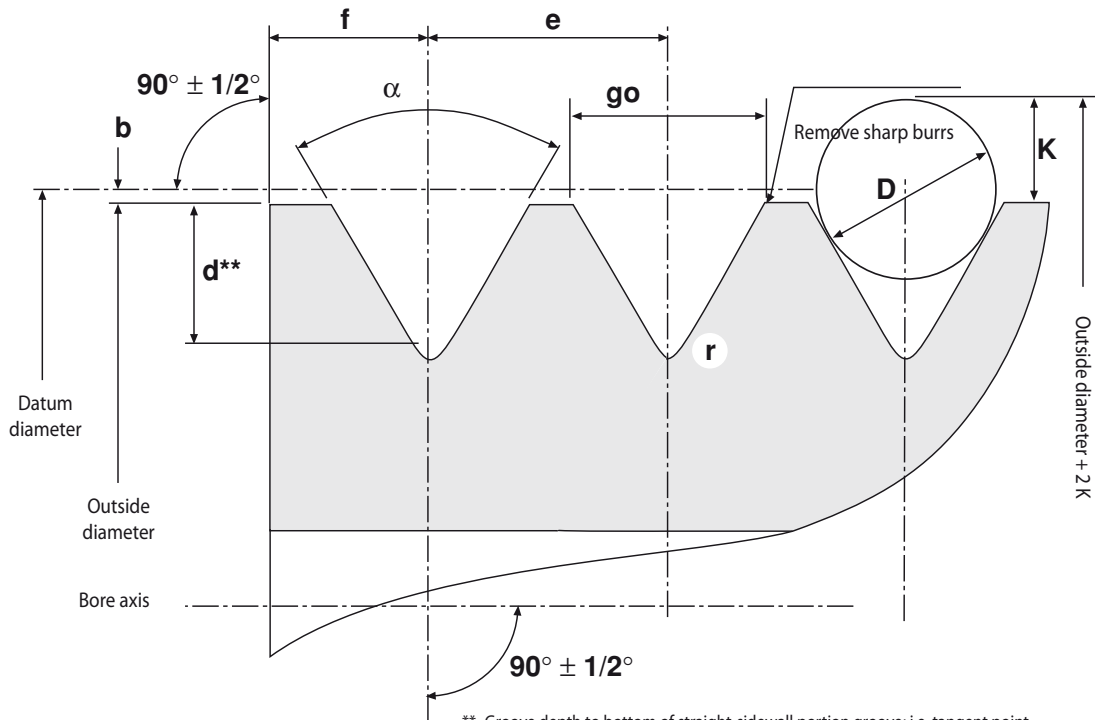

** Groove depth to bottom of straight-sidewall portion groove; i.e. tangent point of "d" and "r" dimensions.

Table 6
Groove dimensions and tolerances for Polyflex® JB™

Groove designation	Outside diameter	Groove angle α $\pm 1/4^\circ$	go mm ± 0.05 mm	d** mm	e mm $\pm 0.13/-0.5$	f mm min.	r mm max.	2K mm ± 0.15	D mm ± 0.2	2b mm
3M	17-23	60°	2.80	3.00	3.35	2.23	0.3	4.15	3.00	1.9
	> 23	62°	2.80	3.00	3.35	2.23	0.3	4.16	3.00	1.9
5M	26-32	60°	4.50	3.28	5.30	3.45	0.4	5.71	4.50	3.3
	33-97	62°	4.50	3.15	5.30	3.45	0.4	5.75	4.50	3.3
	> 97	64°	4.50	3.05	5.30	3.45	0.4	5.79	4.50	3.3
7M	42-76	60°	7.10	5.28	8.50	5.65	0.6	10.20	7.50	4.5
	> 76	62°	7.10	5.08	8.50	5.65	0.6	10.25	7.50	4.5
11M	67-117	60°	11.20	8.51	13.20	8.60	0.8	15.10	11.50	5.4
	> 117	62°	11.20	8.20	13.20	8.60	0.8	15.19	11.50	5.4

NOTES:

- The sides of the groove shall not exceed 3 micron (RMS) roughness.
- The summation of the deviations from "e" for all grooves in any pulley shall not exceed ± 0.30 mm.
- The tolerance on the outside diameter is:
0.13 mm for pulleys with 26 mm through 125 mm outside diameter
0.38 mm for pulleys with 126 mm through 250 mm outside diameter
0.76 mm for pulleys with 251 mm through 500 mm outside diameter
1.27 mm for pulleys with 501 mm outside diameter and more.
- Radial run-out shall not exceed 0.13 mm TIR* for outside diameters up through 250 mm.
Add 0.01 mm TIR* per 25 mm of outside diameter more than 250 mm.
- Axial run-out shall not exceed 0.03 mm TIR* per 25 mm of outside diameter for diameters up through 500 mm.
Add 0.01 mm TIR* per 25 mm of outside diameter for diameters more than 500 mm.

* TIR: Total Indicator Reading.

** Groove depth to bottom of straight-sidewall portion groove; i.e. tangent point of "d" and "r" dimensions.

POLY CHAIN® GT, POWERGRIP® GT AND POWERGRIP® HTD® BELTS

Pulley bore/face diameter tolerance specifications

Gates recommends that pulleys are precision made to close tolerances. Inaccurate manufacture or reboring may result in poor drive performance. Permissible tolerances for bore (B) and for outside diameter (OD) are shown in the tables on this page. Working surface should be free from surface defects and be to 3.2 µm or better.

Pulley tolerance band

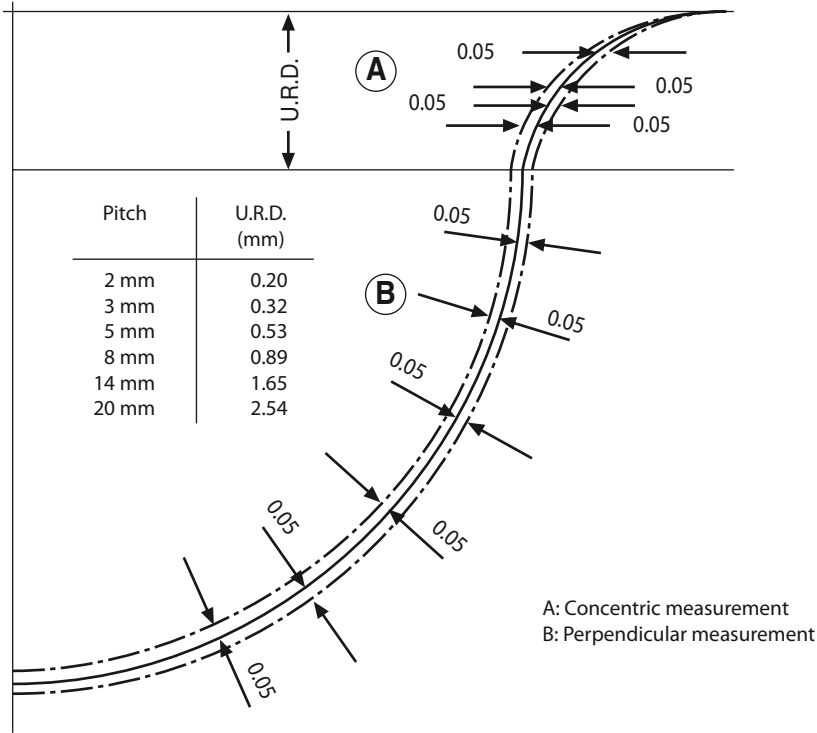

* 8M and 14M HTD® pulleys are suitable for PowerGrip® GT3 belts.

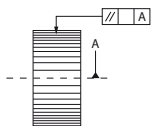

Helix angle

Grooves should be parallel to the axis of the bore within 0.01 per 10 mm.

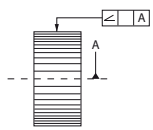

Draft

The maximum permissible draft is 0.01 mm per 10 mm of face width, but it must not exceed the outside diameter tolerance.

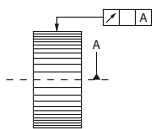

Eccentricity

Allowable amount from pulley bore to outside diameter (OD) is shown below.

Outside diameter (OD) mm	Total eccentricity
Up to 203	0.1
Over 203	0.005 per 10 mm of diameter (may not exceed the tolerance on face diameter)

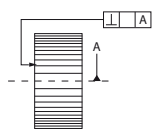

Parallelism

Bore of pulley to be perpendicular to vertical faces of pulley within 0.01 per 10 mm of radius with a maximum of 0.51 mm T.I.R.

Table 7
Recommended maximum outside diameters for cast-iron pulleys

Maximum shaft speed	Maximum allowable pulley diameter	
	rpm	mm
500	1260	49.60
750	840	33.07
1000	630	24.80
1250	504	19.84
1500	420	16.53
1750	360	14.17
2000	315	12.40
2500	252	9.92
3000	210	8.27
4000	157	6.18
5000	126	4.96
6000	105	4.13
8000	79	3.11
10000	63	2.48

Table 8
Standard electric motors

Table No. 8 shows an overview on standard electric motors according to DIN 42672, Part 1, and DIN 42673, Part 1. Per size different motor types are available. The summary overview includes information on maximum acceptable bearing loads. These values are very generic and refer to standard radial contact groove ball bearings. Purpose of the minimum pulley diameter recommendations is to prevent the use of too small pulleys, which can lead to shaft or bearing damage because the belt pull goes up as the pulley diameter goes down.

As the specific electric motor design can vary per manufacturer, this overview table is meant for general orientation only. Consult the motor manufacturer.

Standard E-motor size	Power at 50 Hz kW				Shaft diameter mm	Maximum acceptable bearing load N (Nominal value)	Recommended minimum V-pulley diameter mm (Datum diameter)
	3000 rpm	1500 rpm	1000 rpm	750 rpm			
80	0.75/1.1	0.55/0.75	0.37/0.55	-	19	710	63
90S	1.5	1.1	0.75	-	24	940	71
90L	2.2	1.5	1.1	-	24	940	71
100L	3.0	2.2/3.0	1.5	0.75/1.1	28	1200	90
112M	4.0	4.0	2.2	1.5	28	1220	90
132S	5.5/7.5	5.5	3.0	2.2	38	1720	112
132M	-	7.5	4.0/5.5	3.0	38	1720	112
160M	11.0/15.0	11.0	7.5	4.0/5.5	42	2400	125
160L	18.5/22.0	15.0/18.5	11.0	7.5	42/48	2400	125
180M	22.0/30.0	18.5/22.0	15.0	11.0	48/55	2800	140
180L	37.0	22.0/30.0	15.0/18.5	11.0/15.0	48/55	2800	140
200M	45.0	37.0	22.0	18.5	60	3650	160
200L	30/37/55	30.0/45.0	18.5/22/30	15.0/22.0	55/60	3650	160
225M	45.0	45.0/55.0	30.0/37.0	22.0/30.0	55/60/65	3950	180
225S	-	37.0	-	18.5	60	3950	180
250M	55.0	45.0/55.0	30.0/37.0	22.0/30.0	60/65	4850	200

XIV. TECHNICAL DATA

Table 9
Minimum recommended idler diameters

	Belt section	Min O.D. of grooved inside idler		Min O.D. of flat outside idler	
		mm	inch	mm	inch
Predator® single belt	SPBP	160	6.30	250	9.84
	SPCP	250	9.84	400	15.75
	AP	85	3.35	110	4.33
	BP	112	4.41	160	6.30
	CP	160	6.30	220	8.66
	8VP	317	12.48	445	17.52
Quad-Power® II	XPZ / 3VX	56	2.20	85	3.35
	XPA	80	3.15	120	4.72
	XPB / 5VX	112	4.41	168	6.61
	XPC	180	7.09	270	10.63
Super HC® MN	SPZ	56	2.20	85	3.35
	SPA	80	3.15	120	4.72
	SPB	112	4.41	168	6.61
	SPC	180	7.09	270	10.63
Super HC®	SPZ / 3V / 9J	71	2.80	120	4.72
	SPA	100	3.94	160	6.30
	SPB / 5V / 15 J	160	6.30	250	9.84
	SPC	250	9.84	350	13.78
	8V / 25J	315	12.40	450	17.72
	8VK	425	16.73	500	19.69
Hi-Power®	Z	60	2.36	90	3.54
	A	85	3.35	110	4.33
	B	112	4.41	160	6.30
	C	160	6.30	220	8.66
	D	300	11.81	350	13.78
	E	500	19.69	600	23.62
Hi-Power® Dubl-V	AA	85	3.35	*	*
	BB	112	4.41	*	*
	CC	160	6.30	*	*
	DD	330	12.99	*	*
VulcoPower™	Z	60	2.36	90	3.54
	A	85	3.35	110	4.33
	B	112	4.41	160	6.30
	C	160	6.30	220	8.66
VulcoPlus™	SPZ	71	2.80	120	4.72
	SPA	100	3.94	160	6.30
	SPB	160	6.30	250	9.84
	SPC	250	9.84	400	15.75

Table 9 (continued)
Minimum recommended idler diameters

	Belt section	Min O.D. of grooved inside idler		Min O.D. of flat outside idler	
		mm	inch	mm	inch
Predator® PowerBand®	SPBP	160	6.30	250	9.84
	SPCP	250	9.84	400	15.75
	9JP	71	2.80	110	4.33
	15JP	160	6.30	250	9.84
	8VP	317	12.48	445	17.52
Quad-Power® II PowerBand®	3VX	71	2.80	100	3.94
	5VX	112	4.41	180	7.09
	XPZ	56	2.20	80	3.15
	XPA	96	3.78	144	5.67
	XPB	135	5.31	192	7.56
Super HC® PowerBand®	SPB	160	6.30	250	9.84
	SPC	250	9.84	400	15.75
	9J / 3V	71	2.80	108	4.25
	15J / 5V	160	6.30	250	9.84
	25J / 8V	317	12.48	445	17.52
Hi-Power® PowerBand®	B	137	5.39	180	7.09
	C	228	8.98	300	11.81
	D	330	12.99	430	16.93
PowerRated®	3L	38	1.50	50	1.97
	4L	64	2.52	83	3.27
	5L	89	3.50	116	4.57
Polyflex® JB™	3M-JB	17	0.67	*	*
	5M-JB	26	1.02	*	*
	7M-JB	42	1.65	*	*
	11M-JB	67	2.64	*	*
Polyflex®	3M	17	0.67	*	*
	5M	26	1.02	*	*
	7M	42	1.65	*	*
	11M	67	2.64	*	*
Micro-V®	PJ	20	0.79	32	1.26
	PL	75	2.95	115	4.53
	PM	180	7.09	270	10.63

XIV. TECHNICAL DATA

Table 10
Minimum recommended pulley sizes for synchronous belts

	Belt pitch	Min. recommended pulley size N° of grooves	Min. back idler diameter mm
Poly Chain® GT Carbon™	8MGT	22	85
	14MGT	28	190
Poly Chain® GT2	8MGT	22	*
	14MGT	28	*
PowerGrip® GT3	2MGT	10	10
	3MGT	16	25
	5MGT	18	45
	8MGT	22	85
	14MGT	28	190
PowerGrip® HTD®	3M	10	15
	5M	14	35
	8M	22	85
	14M	28	190
	20M	34	325
PowerGrip®	MXL	10	10
	XL	10	25
	L	10	45
	H	14	85
	XH	18	190
	XXH	18	260
TransMotion™	8M	22	85
Twin Power®	Belt pitch	Minimum N° of grooves	N° of grooves
	XL	10	10
	L	10	10
	H	14	14
	5M	14	14
	8MGT	22	22
14MGT	28	28	

Table 10 (continued)
Minimum recommended pulley sizes for synchronous belts

	Belt pitch	Min. recommended pulley size N° of grooves	Min. back idler diameter mm
Synchro-Power®	T2.5	12	20
	T5	10	30
	T10	14	80
	AT5	15	60
	AT10	15	120
	T5DL	12	20
	T10DL	18	57
Synchro-Power® LL	T5	10	30
	T10	14	80
	T10HF	12	60
	T20	15	120
	AT5	15	60
	AT10	15	120
	ATL10	25	150
	ATL10HF	20	130
	AT20	18	180
	ATL20	30	250
	HTD5M	14	60
	HTD8M	20	120
	HTD14M	28	180
	HTDL14M	43	250
	HPL14M	44	250
	STD5M	14	60
	STD8M	20	120
	XL	10	30
	L	10	60
	H	14	80
XH	12	150	

XIV. TECHNICAL DATA

Table 11
Minimum installation and takeup allowance

V-BELTS																	
Datum length mm	Minimum installation allowance - mm																Minimum takeup allowance mm
	V-belt section																
	XPZ 3VX SPZ 3V	XPA SPA	XPB 5VX SPB 5V	SPC	8V 8VK	9J PB	15J PB	8V PB 25J PB	Z	A	A PB	B	B PB SPB PB	C	C PB SPC PB	D	All sections
420 - 1199	15	20	-	-	-	30	-	-	15	20	30	25	35	40	50	-	25
1200 - 1999	20	25	25	-	-	35	55	-	20	20	30	30	40	40	50	50	35
2000 - 2749	20	25	25	35	40	35	55	85	20	25	35	30	40	40	50	50	40
2750 - 3499	20	25	25	35	40	35	55	85	-	25	35	30	40	40	50	50	45
3500 - 4499	20	25	25	35	40	35	55	85	-	25	35	30	40	50	60	55	55
4500 - 5499	-	25	25	35	45	-	55	90	-	25	35	40	50	50	60	60	65
5500 - 6499	-	-	35	40	45	-	60	90	-	25	35	40	50	50	60	60	85
6500 - 7999	-	-	35	40	45	-	60	90	-	-	-	40	50	50	60	65	95
8000 -	-	-	35	45	50	-	60	100	-	-	-	-	50	50	60	65	110

PB = PowerBand®

MICRO-V® BELTS				
Effective length mm	Minimum installation allowance - mm			Minimum takeup allowance mm
	Micro-V® belt section			
	PJ	PL	PM	All sections
- 500	10			10
501 - 1000	15			20
1001 - 1500	15	25		25
1501 - 2000	20	25		35
2001 - 2500	20	30	40	40
2501 - 3000		30	40	45
3001 - 4000		35	45	60
4001 - 5000			45	65
5001 - 6000			50	70
6001 - 7500			55	85
7501 - 9000			65	100
9001 -			70	115

POLYFLEX® JB™ BELTS						
Effective length mm	Minimum installation allowance - mm				Minimum takeup allowance mm	
	Polyflex® JB™ belt section					
	3M-JB	5M-JB	7M-JB	11M-JB	All sections	
180 - 272	5	-	-	-	-	
280 - 300	7.5	10	-	-	5	
307 - 710	10	15	15	25	15	
730 - 1090	-	25	25	30	30	
1120 - 1500	-	30	30	35	35	
1550 - 1900	-	-	30	40	35	
1950 - 2300	-	-	40	50	45	

Table 12
Installation and tensioning allowance

SYNCHRONOUS BELTS					
	Belt length	Min. standard installation allowance (flanged pulleys removed for installation)	Min. installation allowance (one pulley flanged)	Min. installation allowance (both pulleys flanged)	Min. tensioning allowance (any drive)
	mm	mm	mm	mm	mm
Poly Chain® GT Carbon™ 8MGT Poly Chain® GT2 8MGT	- 1000	1.8	23.8	35.1	0.8
	1001 - 1780	2.8	24.6	35.9	0.8
	1781 - 2540	3.3	25.1	36.6	1.0
	2541 - 3300	4.1	25.9	37.4	1.0
	3301 - 4600	5.3	27.1	38.6	1.3
Poly Chain® GT Carbon™ 14MGT Poly Chain® GT2 14MGT	- 1000	1.8	33.0	51.8	0.8
	1001 - 1780	2.8	34.0	52.8	0.8
	1781 - 2540	3.3	34.5	53.3	1.0
	2541 - 3300	4.1	35.3	54.1	1.0
	3301 - 4600	5.3	36.5	55.3	1.3
PowerGrip® GT3 5MGT PowerGrip® HTD® 5M	- 500	1.0	14.5	20.0	0.8
	501 - 1000	1.3	14.8	20.3	0.8
	1001 - 1500	1.8	15.3	20.8	1.0
	1501 - 2260	2.3	15.8	21.3	1.3
	2261 - 3020	2.8	16.3	21.8	1.3
PowerGrip® GT3 8MGT PowerGrip® HTD® 8M	- 500	1.0	22.6	33.8	0.8
	501 - 1000	1.3	22.9	34.1	0.8
	1001 - 1500	1.8	23.4	34.6	1.0
	1501 - 2260	2.3	23.9	35.1	1.3
	2261 - 3020	2.8	24.4	35.6	1.3
	3021 - 4020	3.6	25.2	36.4	1.3
	4021 - 4780	4.3	25.9	37.1	1.3
	4781 - 6860	5.4	27.0	38.2	1.3
PowerGrip® GT3 14MGT PowerGrip® HTD® 14M	- 500	1.0	36.6	59.2	0.8
	501 - 1000	1.3	36.9	59.5	0.8
	1001 - 1500	1.8	37.4	60.0	1.0
	1501 - 2260	2.3	37.9	60.5	1.3
	2261 - 3020	2.8	38.4	61.0	1.3
	3021 - 4020	3.6	39.2	61.8	1.3
	4021 - 4780	4.3	39.9	62.5	1.3
	4781 - 6860	5.4	41.0	63.6	1.3
PowerGrip® HTD® 20M	- 500	1.0	48.0	78.5	0.8
	501 - 1000	1.3	48.3	78.8	0.8
	1001 - 1500	1.8	48.8	79.3	1.0
	1501 - 2260	2.3	49.3	79.8	1.3
	2261 - 3020	2.8	49.8	80.3	1.3
	3021 - 4020	3.6	50.6	81.1	1.3
	4021 - 4780	4.3	51.3	81.8	1.3
	4781 - 6860	5.4	52.4	82.9	1.3

XIV. TECHNICAL DATA

Table 12 (continued)
Installation and tensioning allowance

	Belt length mm	Min. standard installation allowance (flanged pulleys removed for installation) mm	Min. installation allowance (one pulley flanged) mm	Min. installation allowance (both pulleys flanged) mm	Min. tensioning allowance (any drive) mm
PowerGrip® XL	90 - 127	0.50	12.20	18.50	0.50
	128 - 254	0.75	12.50	18.75	0.75
	255 - 508	1.00	12.70	19.00	0.75
	509 - 1016	1.30	13.00	19.30	1.00
	1017 - 1524	1.80	13.50	19.80	1.30
	1525 - 4572	3.10	14.80	21.10	2.10
PowerGrip® L	90 - 127	0.50	16.80	22.10	0.50
	128 - 254	0.75	17.00	22.40	0.75
	255 - 508	1.00	17.30	22.60	0.75
	509 - 1016	1.30	17.60	22.90	1.00
	1017 - 1524	1.80	18.10	23.40	1.30
	1525 - 4572	3.10	19.40	24.70	2.10
PowerGrip® H	90 - 127	0.50	16.80	24.90	0.50
	128 - 254	0.75	17.00	25.20	0.75
	255 - 508	1.00	17.30	25.40	0.75
	509 - 1016	1.30	17.60	25.70	1.00
	1017 - 1524	1.80	18.10	26.20	1.30
	1525 - 4572	3.10	19.40	27.50	2.10
PowerGrip® XH	90 - 127	0.50	29.50	49.30	0.50
	128 - 254	0.75	29.80	49.60	0.75
	255 - 508	1.00	30.00	49.80	0.75
	509 - 1016	1.30	30.30	50.10	1.00
	1017 - 1524	1.80	30.80	50.60	1.30
	1525 - 4572	3.10	32.10	51.90	2.10
PowerGrip® XXH	90 - 127	0.50	39.40	67.80	0.50
	128 - 254	0.75	39.70	68.10	0.75
	255 - 508	1.00	39.90	68.30	0.75
	509 - 1016	1.30	40.20	68.60	1.00
	1017 - 1524	1.80	40.70	69.10	1.30
	1525 - 4572	3.10	42.00	70.40	2.10

Table 13
Estimating belt length from drive components
 (2 pulleys)

$$\text{Belt length} = 2C + 1.57 (D + d) + \frac{(D - d)^2}{4C}$$

Where: C = shaft centre distance

a) For PowerRated®, Polyflex®, Micro-V® and all RMA PowerBand® belts :

belt length = belt effective length
 D = O.D. of larger pulley
 d = O.D. of smaller pulley

b) For Predator®, Super HC® MN, Super HC®, Hi-Power®, VulcoPower™, VulcoPlus™ and all metric PowerBand® belts:

belt length = datum length
 D = datum diameter of larger pulley
 d = datum diameter of smaller pulley

c) For synchronous belts:

belt length = pitch length
 D = pitch diameter of larger pulley = N° teeth x pitch/π
 d = pitch diameter of smaller pulley = N° teeth x pitch/π

Weights and measures

1 lbf	=	0.454 kgf
1 lbf	=	4.448 N
1 kgf	=	9.807 N
1 lbf in	=	0.113 Nm
1 ft	=	0.3048 m
1 in	=	25.4 mm
1 ft²	=	0.093 m²
1 in²	=	645.16 mm²
1 ft³	=	0.028 m³
1 in³	=	16.387 cm³
1 oz	=	28.35 g
1 lb	=	0.454 kg
1 UK ton	=	1.016 ton
1 UK gal	=	4.546 litres
1 UK pint	=	0.568 litre
1 radian	=	57.296 degrees
1 degree	=	0.0175 radian
1 HP	=	0.746 kW

XV. SUPPORT

Behind our leading industrial products is an entire company of professionals, armed with solutions. Whether driven by people, equipment or technology, Gates provides a wide range of services to optimise belt drive performance and deliver the best value to customers in return for their investment in Gates' products.

Save energy and costs with Gates cost saving programme!

Are high maintenance costs and premature belt failures an issue at your plant? Are you sure your drive system works in the most economic way? The Gates cost saving programme contains all the tools and support necessary to redesign your problem drive and to calculate how to make your transmission even more efficient.

Gates Area Account Managers are available to conduct performance evaluations on your plant and develop a maintenance recommendation plan for energy cost savings, that will optimise all belt drives in your facility.

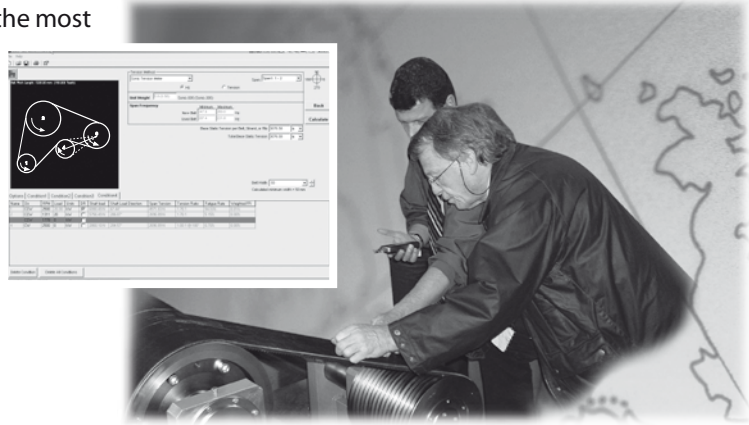

This is how it works:

- We evaluate current belt drive efficiencies using Gates DesignFlex® and Cost Saving Calculation Tool.
- We calculate energy savings gained by replacing problem drives or chain drives with energy-efficient ones.
- We identify problem drive applications and develop a programme to increase their reliability.
- We recommend longer-lasting products that will enhance productivity and improve equipment reliability.
- We determine ways to reduce maintenance costs (retensioning, lubrication, ...).
- We develop a preventative maintenance programme to maximise the life of all belt drives in your facility.

Energy saving example

Heat, ventilation and air conditioning

- Motor: 40 kW, 11,450 rpm, 89% efficient

Hours used: 24 hours/day, 7 days/week, 52 weeks/year

Energy cost: 0.06645 EUR/kWh

- Cost of a new synchronous belt drive: 765.6 EUR
- Assume a 5% increase in efficiency over a V-belt drive

Annual energy cost:

40 kW x 8,736 hours x 0.06645 EUR = 23,220.30 EUR

Annual energy savings:

23,220.30 EUR x 0.05 = 1,161 EUR

- Payback period:

765.60 EUR / 1,161 EUR = 0.66 years or 7 months

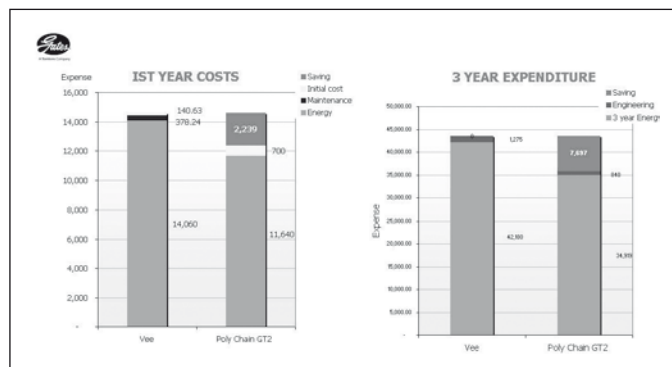
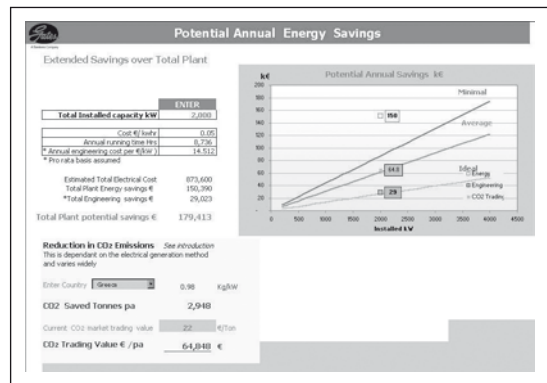

Gates drive design software

Gates puts forward two fast and easy resources for selecting and maintaining belt drive systems.

DesignFlex® Pro™ and Design IQ™, online drive design and engineering tools, assist designers in quickly selecting optimum drive solutions. With the Gates multilingual DesignFlex® Pro™ programme, you can design a drive in minutes, and get every possible drive solution that fits your design parameters. Plus, you can print, e-mail and create a PDF of the design specifications. Design IQ™ provides a blank slate for designing multipoint and complex serpentine belt drives. Utilising a specific Gates product that you have identified, as well as your drive specifications, the software will calculate belt tension, shaft load, belt length and more.

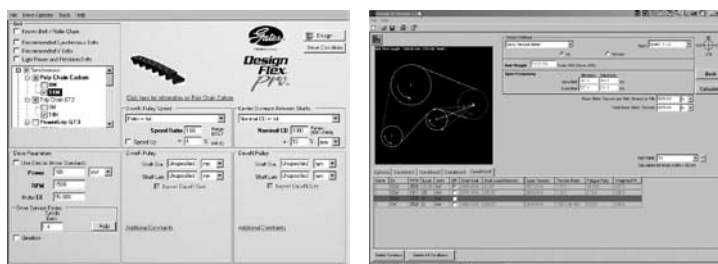

Gates e-commerce website

By going online registered Gates distributors can find the most current product information, enter orders 24 hours/day and track orders at any time. Gates electronic price lists both in EXCEL and PDF formats can be consulted from the e-commerce website www.gates-online.com. To request free printed copies of the price list available in several languages, just contact your Gates representative.

Gates literature and website

Please consult our website at www.gates.com/europe/pti for specific and updated information on all Gates industrial belt products and our list of available literature. Industrial Power Transmission brochures and leaflets can be downloaded there. Distributors may link up with the Gates European site thus supplying visitors with updated information on the European Gates organisation.

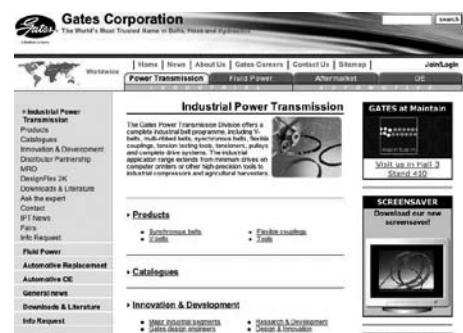

REACH: Environment-friendly and safe quality products

REACH is a new European Community regulation on chemicals and their safe use. It stands for Registration, Evaluation, Authorisation and Restriction of Chemical substances (2006/1907/EC). The aim of REACH is to improve the protection of human health and the environment through the better and earlier identification of the intrinsic properties of chemical substances. From its respect for the environment to industrial safety, Gates takes its responsibility in the production of industrial belts very seriously and adheres scrupulously to the requirements laid down in the REACH regulation. All substances in our belt products requiring registration have been registered in the central database run by the European Chemicals Agency (ECHA). This database can be consulted in order to check products on REACH conformity. **All standard V-belts and synchronous belts, listed in the Gates Industrial Power Transmission Catalogue (E2/20054), are REACH compliant, except for PowerRated®, Super HC® PowerBand® SPC and the 5 smallest Micro-V® belts with DIN/ISO effective length ranging from 406 mm up to 508 mm (PJ406, PJ432, PJ457, PJ483 and PJ508).**

Gates manufacturing and distribution in Europe

Gates Power Transmission Industrial has product dedicated production sites in Germany, Poland, Scotland, France and Spain. Distribution is handled from one central warehouse in Ghent (Belgium).



Request for an expertise of your machine park

If you want to save energy and costs? Have your plant checked by a Gates representative or Gates distributor.

Fill out this form and give it to a Gates representative.

You can also fax it to Martine Meert (+32 53 76 27 13) or e-mail it (martinem@gates.com) and we will contact you.

Your company:.....

Your industry

- Chemistry and petrochemistry
- Food, pharmaceutical
- Automobile
- Wood, paper
- Consumer goods (non food)
- Aggregates
- Textile
- Environment

Name:

Your position within the company:

Address:

.....

Telephone:

Fax:

E-mail:





All Gates' European Power Transmission operations are ISO 9001, ISO 14001 and OHSAS 18001 registered.

Important

Every effort has been made to ensure the accuracy and comprehensiveness of the information included in this manual. However, Gates cannot be held responsible for errors or omissions and for alterations occurred after release for printing; or if Gates products are used in special or exceptional circumstances without prior consultation with and clearance from a Gates representative.

This issue is released May 2009 and supersedes all previous versions of this preventive maintenance manual. If your preventive maintenance manual is more than 2 years old, please consult a Gates representative to check whether you have the latest version.



A Tomkins Company

BELGIUM

Gates Power Transmission Europe bvba
Dr. Carlierlaan 30
9320 Erembodegem
TL: (32) 53 76 28 41
FX: (32) 53 76 26 09

FRANCE

Gates France S.A.R.L.
B.P. 37
2, Rue de la Briqueterie
Zone Industrielle
95380 Louvres
TL: (33) 1 34 47 41 45
FX: (33) 1 34 72 20 54

GERMANY

Gates GmbH Aachen
Eisenbahnweg 50
52068 Aachen
TL: (49) 241 5108 226
FX: (49) 241 5108 297

ITALY

Gates S.R.L.
Via Senigallia 18
(Int. 2 - Blocco A - Edificio 1)
20161 Milano MI
TL: (39) 02 662 16 222
FX: (39) 02 662 21 851

RUSSIA

Gates CIS LLC
1-st Dobryninsky per.
building 15/7
Moscow - 115 093
TL: (7) 495 933 83 78
FX: (7) 495 648 92 72

www.gates.com/europe/pti
ptindustrial@gates.com

Your distributor: