

FYH[®]

BALL BEARING UNITS



CAT.NO.3300

NIPPON PILLOW BLOCK CO.,LTD.



Ball Bearing Units (contents)

Technical section

1	Structure and features	3
2	Models	6
3	Selection of units	16
4	Rating life of bearings	19
5	Bearing load	22
6	Allowable rotating speed	29
7	Operating temperature and bearing specifications	30
8	Strength of housings	31
9	Design of shaft and base	36
10	Nomenclature	41
11	Accuracy and internal clearance	43
12	Materials	48
13	Performance	50
14	Handlings.....	52

Appendix table

1	Simplified chart of ball bearing unit combinations	240
2	Tightening torques of housings and cast iron cover mounting bolts	242
3	Tightening torques of inner rings and eccentric locking collar set screws	243
4	Tightening torques of adapter lock nuts (reference)	243
5	Machining dimensions of holes of housing dowel pins ...	244
6	Dimensional tolerances of shafts	246
7	Dimensional tolerances of housing bores	248
8	Basic tolerance values	250
9	SI unit conversion charts	251
10	Inch-meter conversion chart	252
11	Hardness conversion chart	253
12	Viscosity conversion chart	254
13	Mechanical properties of metal materials (reference) ...	255
14	Hexagon socket head cap screws (abstract from JIS B 1176)	256
15	Hexagon head bolts (abstract from JIS B 1180)	258
16	Hexagon head nuts (abstract from JIS B 1181)	260
17	Comparison table of Part No. by manufacturers (cylindrical bore type)	261

Technical section	Technical section
Pillow type units	
Square four-bolt flange type units	
Oval flange type units	
Round flange cartridge type units	
Stamped steel plate flange type units	
Take-up type units	
Cartridge type units	
Hanger type units	
Ball bearing inserts	
Parts and accessories	Parts and accessories
Example of use	Example of use
Appendix table	Appendix table

Contents

Technical section

1 Structure and features

1.1 Structure 3
 1.2 Features 4

2 Models

2.1 Model list 6
 2.2 Models and features 8
 2.3 Units for special use 14

3 Selection of units

3.1 Outline of selection 16
 3.2 Selection of model specifications 17
 3.3 Selection of bearings from
 a maintenance viewpoint 18

4 Rating life of bearings

4.1 Basic rating life and basic load rating 19
 4.2 Calculation of rating life 19
 4.3 Grease life 21

5 Bearing load

5.1 Loads applied to bearings 22
 5.2 Distribution of bearing load 24
 5.3 Dynamic equivalent load 24
 5.4 Basic static load rating and
 static equivalent load 25
 5.5 Example of applied calculation 26

6 Allowable rotating speed

6.1 Allowable rotating speed 29
 6.2 Rotational speed adjustment due to
 shaft fit 30

7 Operating temperature and bearing specifications

7.1 Operating temperature range 30
 7.2 Operating temperature and
 internal clearance of bearings 30

8 Strength of housings

8.1 Strength of cast iron housings 31
 8.2 Strength of cast steel housings 35
 8.3 Strength of stamped steel housings 35
 8.4 Strength of stainless steel housings 35
 8.5 Strength of die-cast housings 35

9 Design of shaft and base

9.1 Design of shaft 36
 9.2 Mounting base design 39
 9.3 Machining of pin hole for
 locating housings 40

10 Nomenclature 41

11 Accuracy and internal clearance

11.1 Accuracy of bearings 43
 11.2 Accuracy of housings 45
 11.3 Internal bearing clearance 47

12 Materials

12.1 Bearing material 48
 12.2 Housing material 48
 12.3 Materials of parts and accessories 49

13 Performance

13.1 Bearing friction torque 50
 13.2 Bearing temperature increase 50
 13.3 Dustproof and waterproof performance
 51

14 Handlings

14.1 Installation 52
 14.2 Test run inspection 55
 14.3 Periodic inspection 56
 14.4 Supply of grease 56
 14.5 Replacing bearings 59

Unit dimensional table

15 Dimensional tables for ball bearing units	60
1 Pillow type units	
Pillow type units	62
Thick pillow type units	86
Tapped-base pillow type units	90
High centerheight pillow type units	92
Lightweight pillow type units	94
Clean series pillow type units	96
Stainless steel series pillow type units	98
Steel plate pillow type units	104
2 Square four-bolt flange type units	
Square four-bolt flange type units	106
Square four-bolt flange cartridge type units	124
Stainless steel series square four-bolt flange type units	128
3 Oval flange type units	
Oval two-bolt flange type units	130
Adjustable oval two-bolt flange type units	146
Three-bolt flange type units	148
Lightweight oval two-bolt flange type units	150
Clean series oval two-bolt flange type units	152
Stainless steel series oval two-bolt flange type units	154
4 Round flange cartridge type units	158
5 Stamped steel plate flange type units	
Stamped steel plate round three-bolt flange type units	168
Stamped steel plate oval two-bolt flange type units	170
6 Take-up type units	
Take-up type units	172
Stainless steel series take-up type units	188
Section steel frame take-up type units	190
Channel steel frame take-up type units	192
Steel plate frame take-up type units	198
7 Other units	
Cartridge type units	202
Hanger type units	208
8 Ball bearing inserts	210
9 Bearing adapters	230

Parts and accessories

16 Parts and accessories	
16.1 Part No. of steel plate covers	234
16.2 Part No. of cast iron covers	235
16.3 Nominal code and dimensions of grease nipples and reducing socket	236
16.4 Nominal code and dimensions of Allen key wrench	236
17 Example of use	237
18 Appendix table (contents)	239
1 Simplified chart of ball bearing unit combinations	240
2 Tightening torques of housings and cast iron cover mounting bolts	242
3 Tightening torques of inner rings and eccentric locking collar set screws	243
4 Tightening torques of adapter lock nuts (reference)	243
5 Machining dimensions of holes of housing dowel pins	244
6 Dimensional tolerances of shafts	246
7 Dimensional tolerances of housing bores ...	248
8 Basic tolerance values	250
9 SI unit conversion charts	251
10 Inch-meter conversion chart	252
11 Hardness conversion chart	253
12 Viscosity conversion chart	254
13 Mechanical properties of metal materials (reference)	255
14 Hexagon socket head cap screws (abstract from JIS B 1176)	256
15 Hexagon head bolts (abstract from JIS B 1180)	258
16 Hexagon head nuts (abstract from JIS B 1181)	260
17 Comparison table of Part No. by manufacturers (cylindrical bore type)	261

FYH®

BALL BEARING UNITS

FYH BALL BEARING UNITS

CATALOG. NO. 3300

We produce a broad range of mounted bearings from small lightweight units to large heavy-duty units to meet a wide variety of industries and applications worldwide.

The **Ceraball Bearing Series**, a revolutionary style of bearing, was started by our unique idea of combining the highest grades of ceramic and steel, and now meets various needs in leading Japanese biochemical industries, information technology, aerospace, automotive manufacturing, and ocean development businesses.

This catalog introduces a section of “**Ceraball Bearings for special environments**”. We believe this new line will help to reduce bearing maintenance as well as minimize maintenance costs and downtime.

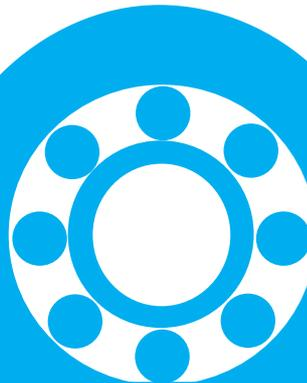

fyhbearings.com

★The contents of this catalogue are subject to change without prior notice. Every possible effort has been made to ensure that the data listed in this catalog is correct. However, we can not assume responsibility for any errors or omissions.

All rights reserved.

1 Structure and features

FYH Ball Bearing Units are manufactured to exacting standards comprising grease sealed deep groove ball bearings and housings in various forms. Self-aligning units allow for easy installation and are supplied with grease nipples in order to facilitate quick and convenient re-lubrication.

1.1 Structure

FYH Ball Bearing Units are constructed of high carbon chromium bearing steel and have precision honed raceways and riveted steel cages (Fig. 1.1).

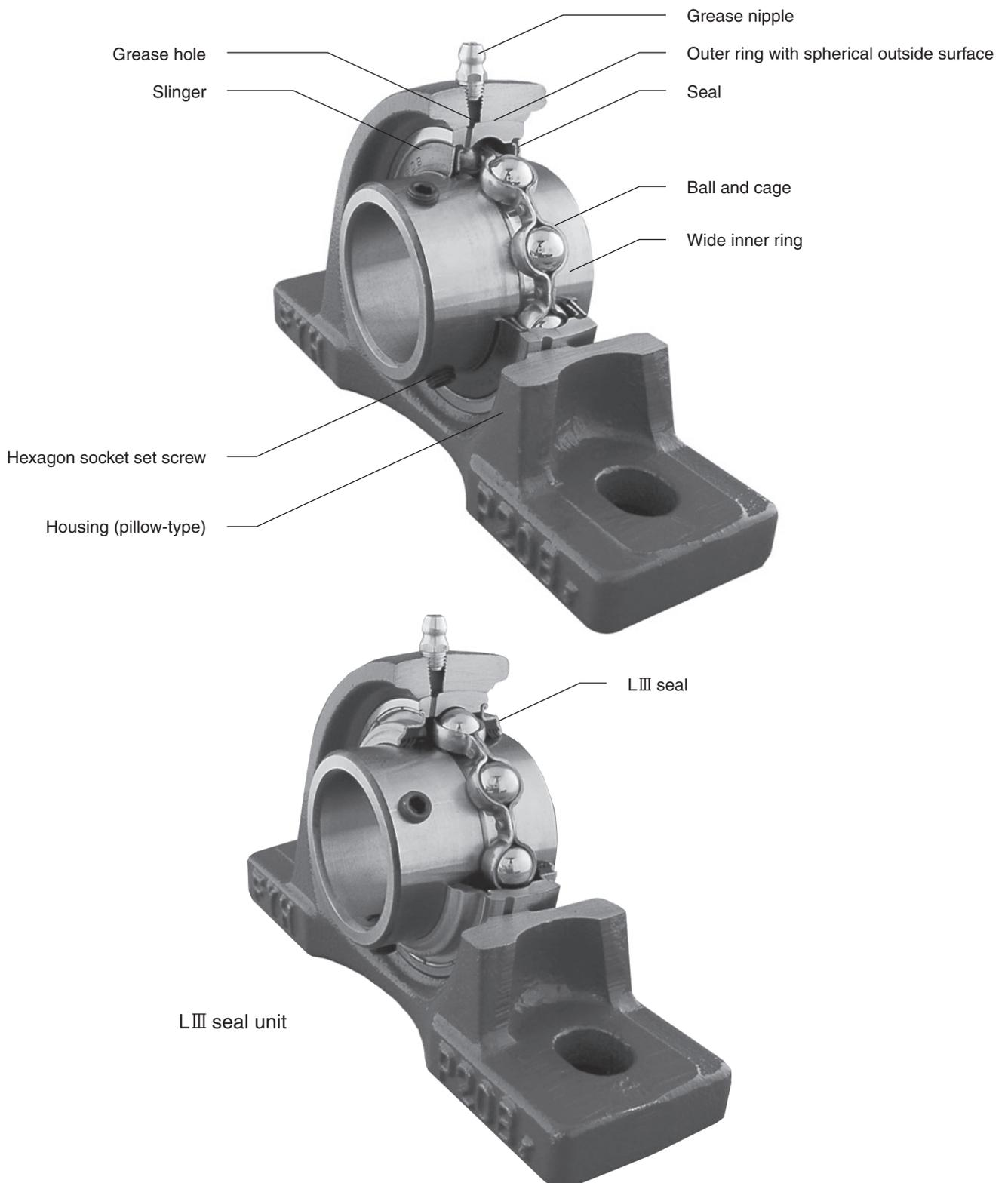

Fig. 1.1 Structure of ball bearing units (representative example)

1 Structure and features

1.2 Features

FYH Ball Bearing Units have many features and are available in various models. A wide selection of mounted units is offered to fit virtually any application.

1 Supreme load capacity and accuracy

FYH Ball Bearing Units feature an internal structure identical to single row deep groove ball bearings and bear significant radial load, as well as a great deal of axial load in both directions. The hardened steel balls exhibit a high degree of "roundness" and the races are highly polished to accommodate a smoother ride at a wide range of speeds.

2 Rational self-aligning mechanism and optimal fit

FYH Ball Bearing Units have the special ability to self-align inside the housing because of the spherical shape of the outer diameter of the bearing insert and the concave shape of the inner diameter of the housing into which it fits. This design allows the bearing unit to self-adjust for shaft deviation and thereby eliminate abnormal bearing load. Therefore, the original rated life of the bearing can be guaranteed.

Since the spherical outside surface of the bearing is precision ground and the spherical bore of the housing is machined by a boring machine with great accuracy, optimal fitting of the bearing and the housing can be obtained, as well as superior aligning performance.

The allowable aligning angle of standard ball bearing units is 3°, while units with covers is 1°.

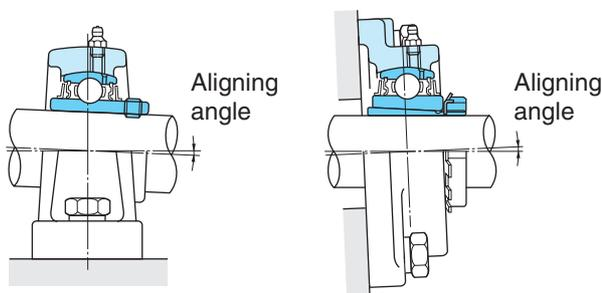

Fig. 1.2 Allowable aligning angle of ball bearing units

3 Superior sealing performance

FYH Ball Bearing Units efficiently prevent grease from leaking out of the interior of the bearing, and perform extremely well at keeping contaminants, such as dust and water, from entering. This is achieved by installing the seal to the outer ring of the bearing and installing the slinger to the inner ring of the bearing.

The seal is made of synthetic rubber with supreme oil proof characteristics, and the lip of the seal contacts with the inner ring of the bearing with optimal tension.

When operating in moist or dusty environments, the triple lip seal unit (suffix code : L3) or a covered unit (accessory code : C, CD, FC, FD) is recommended.

The triple lip seal unit or unit with cover helps prevent ingress of water and dust from the outside, and extends the rated life of the bearing.

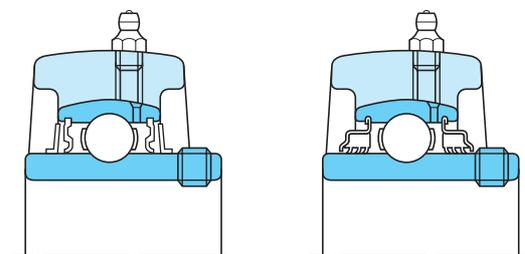

Standard type

Triple lip seal type
(Suffix code : L3)

	Steel plate cover type	Cast iron cover type
Open type	 (Accessory code : C)	 (Accessory code : C, FC)
Open & Closed type	 (Accessory code : CD)	 (Accessory code : CD, FCD)

Unit with covers

Fig. 1.3 Sealing mechanism of ball bearing units

4 Simple lubrication

FYH Ball Bearing Units are tapped to accept a grease nipple which is also supplied with every mounted unit. Bearings are pre-lubricated at the factory and do not require additional grease upon installation. When operating in excessively moist, dusty, or hot environments it is recommended that grease be supplied at regular intervals. If appropriately maintained, the rated life of the bearing can be extended.

The grease nipples that are supplied with FYH mounted units include 1/4-28 for smaller units and 1/8 PT for larger units. Additional styles are available upon request.

5 Highly rigid and rugged cast iron housings

FYH Ball Bearing Units housings are designed so that they are optimized for reduction of deformation due to centralization of stress and load. Only the best material is selected to be cast by a highly advanced technique or press working technique, depending on the housing.

Since any abnormal load on the bearing is eliminated by the housing, the life of the bearing can be extended. A special baked on coating helps resist corrosion and protect the surface of the housing for an extended period of time.

6 Simple installation and handling

FYH Ball Bearing Units interchange with many different models and can be bolted to machinery without any modification. The exact amount of clearance is allowed between the bore and the shaft to allow a perfect fit.

Therefore, FYH Ball Bearing Units do not require any additional lubrication or seal installation. As a result, handling and downtime can be drastically reduced.

Three different locking mechanisms are available :

- (1) set screw
- (2) eccentric locking collar
- (3) tapered adapter

Mounting the bearing to the shaft can be executed easily and securely by adopting any of these methods.

7 Series and models

FYH Ball Bearing Units are available in various series and models.

Reliability of machinery or equipment, used together with these units, can be improved by selecting and using units optimal for the application and operating conditions.

- Triple seal bearing series
- Unit with cover series
Water, dust, and debris protection
- Heat and cold resistant series
- Clean series
Compact, lightweight, and corrosion resistant
- Stainless steel series
Corrosion resistant
- Cast steel series
Rugged housings
- Ceraball series
Ability to withstand severe environments, exposure to water, chemicals, high temperature, or high speed

2 Models

2 Models

2.1 Model list

Table 2.1 and Table 2.2 show the models of FYH Ball Bearing Units and ball bearing inserts.

Table 2.1 FYH Ball Bearing Units models

Model	Type	Bearing bore dia. Surface (fixing to shaft)	Model code	Shaft dia.		Dimension table
				(inch)	(mm)	
1 Pillow type	(1) Standard	Cylindrical bore (with set screws)	UCP	1/2 – 4	12 – 140	P.62
		Cylindrical bore (with eccentric locking collar)	NAP	1/2 – 2 15/16	12 – 75	P.68
			NAPK	1/2 – 2 15/16	12 – 75	P.70
		Tapered bore (with adapter)	UKP	3/4 – 4 1/2	20 – 125	P.72
	(2) Cast steel type	Cylindrical bore (with set screws)	UCP-sc	7/8 – 4	25 – 140	P.78
		Tapered bore (with adapter)	UKP-sc	3/4 – 4 1/2	20 – 125	P.82
	(3) Thick type	Cylindrical bore (with set screws)	UCIP	1 1/2 – 4	40 – 140	P.86
		Tapered bore (with adapter)	UKIP	1 1/4 – 4 1/2	35 – 125	P.88
	(4) Tapped-base type	Cylindrical bore (with set screws)	UCPA	1/2 – 2	12 – 50	P.90
	(5) High centerheight type	Cylindrical bore (with set screws)	UCPH	1/2 – 2	12 – 50	P.92
(6) Lightweight type	Cylindrical bore (with set screw locking)	BLP	1/2 – 1 9/16	12 – 40	P.94	
	Cylindrical bore (with eccentric locking collar)	ALP				
(7) Clean series	Cylindrical bore (with set screws)	UP	N/A	10 – 30	P.96	
(8) Stainless steel series	Cylindrical bore (with set screws)	UCSP-H1S6	N/A	20 – 50	P.98	
		UCSPA-H1S6	N/A	20 – 40	P.100	
		USP-S6	N/A	10 – 30	P.102	
(9) Steel plate type	Cylindrical bore (with set screw locking)	SBPP	1/2 – 1 1/4	12 – 30	P.104	
	Cylindrical bore (with eccentric locking collar)	SAPP				
2 Square four-bolt flange type	(1) Standard	Cylindrical bore (with set screws)	UCF	1/2 – 4	12 – 140	P.106
		Cylindrical bore (with eccentric locking collar)	UCF-E	1/2 – 3 7/16	12 – 85	P.112
			NANF	1/2 – 2 7/16	12 – 60	P.116
		Tapered bore (with adapter)	UKF	3/4 – 4 1/2	20 – 125	P.118
	(2) Piloted cartridge flange type	Cylindrical bore (with set screws)	UCFS	1 – 4	25 – 140	P.124
Tapered bore (with adapter)		UKFS	3/4 – 4 1/2	20 – 125	P.126	
(3) Stainless steel series	Cylindrical bore (with set screws)	UCSF-H1S6	N/A	20 – 50	P.128	
3 Oval flange type	(1) Two-bolt type	Cylindrical bore (with set screws)	UCFL	1/2 – 4	12 – 130	P.130
			UCFL-E	1/2 – 3 1/4	12 – 85	P.136
		Cylindrical bore (with eccentric locking collar)	NANFL	1/2 – 2 3/16	12 – 55	P.140
		Tapered bore (with adapter)	UKFL	3/4 – 4 1/2	20 – 115	P.142
	(2) Adjustable oval two-bolt type	Cylindrical bore (with set screws)	UCFA	1/2 – 2 3/16	12 – 55	P.146
	(3) Three-bolt type	Cylindrical bore (with set screws)	UCFB	1/2 – 2	12 – 50	P.148
	(4) Lightweight two-bolt type	Cylindrical bore (with set screw locking)	BLF	1/2 – 1 7/16	12 – 35	P.150
Cylindrical bore (with eccentric locking collar)		ALF				
(5) Clean series two-bolt type	Cylindrical bore (with set screws)	UFL	N/A	8 – 30	P.152	
(6) Stainless steel series two-bolt type	Cylindrical bore (with set screws)	UCSFL-H1S6	N/A	20 – 50	P.154	
		USFL-S6	N/A	10 – 30	P.156	
4 Round flange cartridge type	Cylindrical bore (with set screws)	UCFC	1/2 – 4	12 – 100	P.158	
		UCFCX-E	1 – 4	25 – 100	P.162	
		UKFC	3/4 – 3 1/2	20 – 90	P.164	
5 Stamped steel plate flange type	(1) Round three-bolt flange type	Cylindrical bore (with set screw locking)	SBPF	1/2 – 1 7/16	12 – 35	P.168
		Cylindrical bore (with eccentric locking collar)	SAPF			
(2) Oval two-bolt flange type	Cylindrical bore (with set screw locking)	SBPFL	1/2 – 1 7/16	12 – 35	P.170	
		Cylindrical bore (with eccentric locking collar)				SAPFL

Table 2.1 FYH Ball Bearing Units models (continued)

Model	Type	Bearing bore dia. Surface (fixing to shaft)	Model code	Shaft dia.		Dimension table
				(inch)	(mm)	
6 Take-up type	(1) Standard	Cylindrical bore (with set screws)	UCT	$\frac{1}{2} - 4$	12 – 140	P.172
		Tapered bore (with adapter)	UCT-E UKT	$\frac{1}{2} - 3 \frac{7}{16}$ $\frac{3}{4} - 4 \frac{1}{2}$	12 – 85 20 – 125	P.178 P.182
	(2) Stainless steel series	Cylindrical bore (with set screws)	UCST-H1S6	N/A	20 – 50	P.188
	(3) Section steel frame type	Cylindrical bore (with set screws)	UCTH	$\frac{1}{2} - 2 \frac{1}{2}$	12 – 65	P.190
	(4) Channel steel frame type	Cylindrical bore (with set screws)	UCTL UCTU	N/A N/A	20 – 45 40 – 90	P.192 P.194
(5) Steel plate frame type	Cylindrical bore (with set screws)	SBPTH	N/A	12 – 25	P.198	
		SBNPTH	N/A	12 – 25	P.200	
7 Cartridge type		Cylindrical bore (with set screws)	UCC	$\frac{1}{2} - 4$	12 – 140	P.202
		Tapered bore (with adapter)	UKC	$\frac{3}{4} - 4 \frac{1}{2}$	20 – 125	P.206
8 Hanger type		Cylindrical bore (with set screws)	UCHA	$\frac{1}{2} - 3$	12 – 75	P.208

Table 2.2 Bearing insert models

Model	Type	Bearing bore dia. Surface (fixing to shaft)	Model code	Shaft dia.		Dimension table
				(inch)	(mm)	
Ball bearing inserts	(1) Standard	Cylindrical bore (with set screws)	UC	$\frac{1}{2} - 4$	12 – 140	P.210
	(2) Standard	Tapered bore (with adapter)	UK	$\frac{3}{4} - 4 \frac{1}{2}$	20 – 125	P.218
	(3) Standard	Cylindrical bore (with eccentric locking collar)	NA	$\frac{1}{2} - 3$	12 – 75	P.224
	(4) Lightweight	Cylindrical bore (with set screws)	SB	$\frac{1}{2} - 1 \frac{1}{2}$	12 – 40	P.210
	(5) Lightweight	Cylindrical bore (with eccentric locking collar)	SA	$\frac{1}{2} - 1 \frac{9}{16}$	12 – 40	P.224
			SA-F	$\frac{1}{2} - 2 \frac{3}{16}$	12 – 55	
	(6) Clean	Cylindrical bore (with set screws)	SU	N/A	8 – 30	P.210
	(7) Stainless steel	Cylindrical bore (with set screws)	UC-S6	N/A	20 – 50	P.216
			SU-S6	N/A	10 – 30	
	(8) Cylindrical outside surface (with lubricating mechanism and snap ring)	Cylindrical bore (with set screws)	ER	$\frac{1}{2} - 2 \frac{7}{16}$	12 – 60	P.228
(9) Cylindrical outside surface	Cylindrical bore (with set screws)	RB	$\frac{1}{2} - 1 \frac{9}{16}$	12 – 40	P.228	
(10) Adapter		H300X	$\frac{3}{4} - 3$	20 – 80	P.230	
		H2300X	$\frac{3}{4} - 4 \frac{1}{2}$	20 – 125		

2.2 Models and features

FYH Ball Bearing Units are available in a variety of styles and sizes.

Models and features of the Ball Bearing Units are shown below.

1 Pillow type units

1 Pillow type units : P.62



UCP



UKP

Cylindrical bore (with set screws)

L3

C, CD (FC, FCD)¹⁾

Cylindrical bore (with eccentric locking collar)

Tapered bore (with adapter)

L3

C, CD (FC, FCD)¹⁾

2 Thick pillow type units : P.86

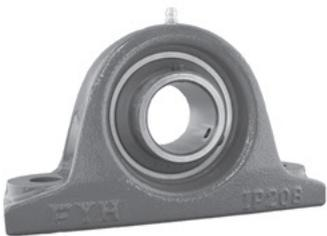

UCIP



UKIP

Cylindrical bore (with set screws)

L3

C, CD (FC, FCD)¹⁾

Tapered bore (with adapter)

L3

C, CD (FC, FCD)¹⁾

Note ¹⁾ Descriptions of codes for units with covers are shown in the table below. (common to all the models)

Diameter series	Code	Descriptions
2	C, CD	Stamped steel plate cover type
	FC, FCD	Cast iron cover type
X	C, CD	From X05 to X17 : stamped steel plate cover type X18 and X20 : cast iron cover type
	C, CD	Cast iron cover type

3 Tapped-base pillow type units : P.90

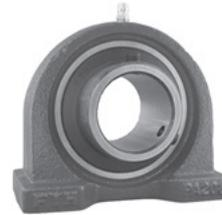

UCPA

Cylindrical bore (with set screws)

L3

4 High centerheight pillow type units : P.92



UCPH

Cylindrical bore (with set screws)

L3

5 Lightweight pillow type units : P.94



BLP



ALP

Cylindrical bore (with set screw locking)

Cylindrical bore (with eccentric locking collar)

6 Clean series pillow type units : P.96

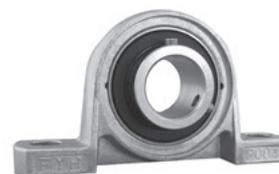

UP

Cylindrical bore (with set screws)

C, CD : Rubber coating cover type

7 Stainless steel series pillow type units : P.98

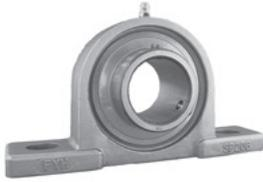

UCSP-H1S6

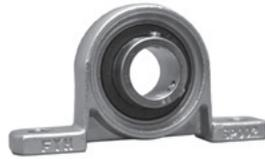

USP-S6

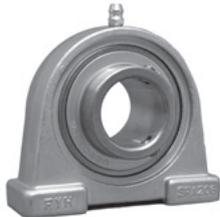

UCSPA-H1S6

Cylindrical bore (with set screws)
C, CD : Stainless steel plate cover type
 Compact
C, CD : Rubber coating cover type

8 Steel plate pillow type units : P.104



SBPP

SAPP

Cylindrical bore (with set screw locking)
 Cylindrical bore (with eccentric locking collar)

2 Square four-bolt flange type units

1 Square four-bolt flange type units : P.106



UCF

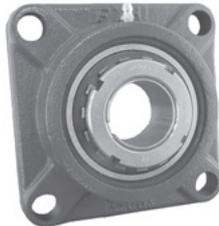

UKF

Cylindrical bore (with set screws)
L3
C, D (FC, FD)¹⁾
 Cylindrical bore (with eccentric locking collar)
 Tapered bore (with adapter)
L3
C, D (FC, FD)¹⁾

2 Square four-bolt flange cartridge type units : P.124



UCFS

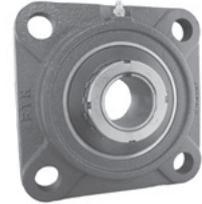

UKFS

Cylindrical bore (with set screws)
L3
C, D
 Tapered bore (with adapter)
L3
C, D

3 Stainless steel series square four-bolt flange type units : P.128



UCSF-H1S6

Cylindrical bore (with set screws)
C, D : Stainless steel plate cover type

3 Oval flange type units

1 Oval two-bolt flange type units : P.130



UCFL



UKFL

Cylindrical bore (with set screws)
L3
C, D (FC, FD)¹⁾
 Cylindrical bore (with eccentric locking collar)
 Tapered bore (with adapter)
L3
C, D (FC, FD)¹⁾

2 Models

(3 Oval flange type units)

2 Adjustable oval two-bolt flange type units : P.146



UCFA

Cylindrical bore (with set screws)
L3

3 Three-bolt flange type units : P.148



UCFB

Cylindrical bore (with set screws)
L3

4 Lightweight oval two-bolt flange type units : P.150



BLF

Cylindrical bore (with set screw locking)



ALF

Cylindrical bore (with eccentric locking collar)

5 Clean series oval two-bolt flange type units : P.152



UFL

Cylindrical bore (with set screws)
C, D : Rubber coating cover type

6 Stainless steel series oval two-bolt flange type units : P.154



UCSFL-H1S6

Cylindrical bore (with set screws)
C, D : Stainless steel cover type



USFL0-S6

Compact

C, D : Rubber coating cover type

4 Round flange cartridge type units

Round flange cartridge type units : P.158



UCFC

Cylindrical bore (with set screws)
L3

C, D (FC, FD)¹⁾

Tapered bore (with adapter)

L3

C, D (FC, FD)¹⁾



UKFC

5 Stamped steel plate flange type units

1 Stamped steel plate round three-bolt flange type units : P.168



SBPF

Cylindrical bore (with set screw locking)

Cylindrical bore (with eccentric locking collar)

SAPF

As for the descriptions of Note ¹⁾, see page 8.

2 Stamped steel plate oval two-bolt flange type units : P.170



SBPFL

Cylindrical bore (with set screw locking)

SAPFL

Cylindrical bore (with eccentric locking collar)

6 Take-up type units

1 Take-up type units : P.172



UCT

Cylindrical bore (with set screws)

L3

C, CD (FC, FCD)¹⁾

Tapered bore (with adapter)

L3

C, CD (FC, FCD)¹⁾



UKT

3 Section steel frame take-up type units : P.190



UCTH

Cylindrical bore (with set screws)

L3

C, CD (FC, FCD)¹⁾

4 Channel steel frame take-up type units : P.192



UCTL

Cylindrical bore (with set screws)

L3

C, CD (FC, FCD)¹⁾

2 Stainless steel series take-up type units : P.188



UCST-H1S6

Cylindrical bore (with set screws)

C, CD : Stainless steel plate cover type

5 Steel plate frame take-up type units : P.198



SBPTH

Cylindrical bore (with set screws)

SBNPTH

As for the descriptions of Note ¹⁾, see page 8.

7 Other units

1 Cartridge type units : P.202



UCC

Cylindrical bore (with set screws)

L3

Tapered bore (with adapter)

L3



UKC

8 Ball bearing inserts

1 UC type bearing : P.210



UC

Cylindrical bore (with set screws)

L3

2 UK type bearing : P.218



UK

Tapered bore (with adapter)

L3

2 Hanger type units : P.208



UCHA

Cylindrical bore (with set screws)

L3

3 Ceraball bearing series



Cylindrical bore (with set screws)

UC2 (X, 3)...Y1 type

UC2 S6...Y2 type

3 NA type bearing : P.224



NA

Cylindrical bore (with eccentric locking collar)

4 SB type bearing : P.210



SB

Cylindrical bore (with set screws)

5 SA type bearing : P.224



SA

SA-F

Cylindrical bore (with eccentric locking collar)

6 SU type bearing (clean series) : P.210



SU

Cylindrical bore (with set screws)

7 ER bearing inserts : P.228



ER

Cylindrical bore (with set screws),
cylindrical outside surface, lubricating mechanism,
set screw

8 RB bearing inserts : P.228



RB

Cylindrical bore (with set screws),
cylindrical outside surface

2.3 Units for special use

To meet customer requests for bearings with special purposes FYH offers a variety of bearing options to meet their needs. Various features allow FYH bearings to work in many non-standard environments and conditions.

The following information shows some of the ways FYH can offer solutions to your non-standard bearing needs.

1 LIII (L3) units

The triple lip seal is composed of a three lip seal glued to the steel shield plate with vulcanized adhesive. The triple lip seal prevents dust, mud, & water from accessing the raceway of the bearing. The triple lip ensures long bearing life in even the most severe environmental conditions.

The L3 seals are fit to the outer ring of the bearing and do not require the insert to be handled any differently than a standard model. The L3 seal allows for the same amount of misalignment as a standard insert. The L3 seal retains its' sealing performance for the life of the unit.

The L3 unit is helpful in keeping contaminant out of the insert, prolonging life and minimizing bearing change-outs. The L3 insert is available in the UC series as well as the UK series.

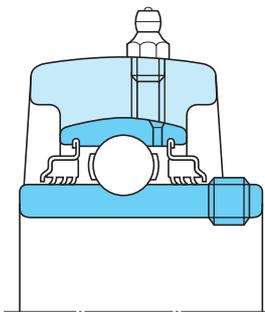

Fig. 2.1 Structure of LIII units

2 Units with covers (accessory code C, D, FC, FD)

Covers can be fitted onto most types of housings with some machining necessary. The covers come in both pressed steel type as well as cast iron. Covers are available in open and closed designs. The open design has a hole with a rubber seal that allows shafting to pass through it. The closed design would be used on a pillow

block where shafting will not pass through. The covers help ensure that dust and other environmental contaminants will not reach the insert. The covers help improve the rating life of bearing units where conditions have caused other bearings to fail.

Open pressed steel covers use C, open cast iron covers use FC. Closed covers use D for pressed steel and FD for the cast iron type. Pillow blocks can have covers on both sides, and can come in open/open or open/closed designs.

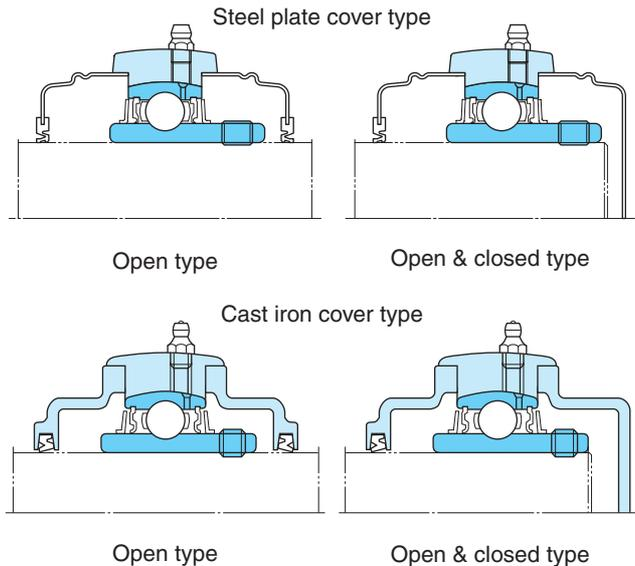

Fig. 2.2 Model and structure of units with cover

3 High temperature / Low temperature units (accessory code high temperature D1K2 re-lube, D9K2 pre-lube low temperature D2K2)

For applications that require bearing units to be used at a higher or lower temperature range than our standard models FYH offers several options. For high temperature units that require lubrication please specify D1K2 type of inserts. For high temperature units that do not require lubrication specify D9K2. The D9K2 insert uses a fluoro-grease, that allows for high heat resistance and operation for a long period of time. Specifications of the high temperature and low temperature grease units are shown in Table 2.3.

Table 2.3 Specifications of heat resistant units and cold resistant units

Category	Special code	Operating temperature range (°C)	Grease	Seal rubber material	Bearing internal clearance	
					UC type	UK type
Ordinary	(no code)	-20 to 100	Alvania No.2, Gold No.3A or equivalence (lithium soap)	Nitrile	CN	C3
Stainless steel	S6	-20 to 100	BEL. RAY NO TOXHD2TC	Nitrile	C3	-
Heat resistant	D1K2	-40 to 180	SH44M (lithium soap)	Silicone	C4	C5
Heat resistant	D9K2	-20 to 220	DemnumL-200 (fluorinated grease)	Silicone	C4	C5
Heat resistant	D9P4	-20 to 250	DemnumL-200 (fluorinated grease)	-	C4	C5
Cold resistant	D2K2	-50 to 120	SH33M (lithium soap)	Silicone	CN	C3

Remark As for the supplying interval in case of faulty temperature and environment, see P.57.

4 High speed units (special code K3)

High speed units are used in applications where low torque and high RPM's are necessary. These units use a non-contact seal that allows for a free spin that cuts down on temperature, and allows for low torque start-up. These units are often used in the printing and textile machinery applications.

5 Units for blowers (special code S5)

Ball bearing units for blowers must meet the demands of high speed rotation, low vibration, low noise and decreased temperature output.

To meet these performance needs FYH produces the S5 series of units for blowers. These units use non-contact seals, as well as an improved machining accuracy to cut down on heat, noise, and vibration.

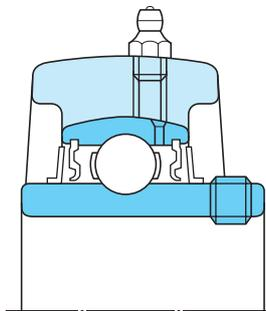

Fig. 2.3 Structure of bearing units for blowers

6 Clean series units

Our clean series unit is a compact design that allows for light conveying in many manufacturing applications. The setscrew design allows for easy installation, as well as reversing. The housing is made of a special alloy, and the insert is zinc plated. Covers coated with rubber increase adhesion with the housing and can be ordered separately in both open and closed designs. The clean series comes in metric sizes only from 10 mm to 30 mm. They are available in both pillow block and 2-bolt flange.

7 Stainless steel series (special code S6)

Our stainless steel series is designed for food, pharmaceutical and other applications that experience frequent wash down or chemical splash. The stainless steel inserts come with USDA approved food grade grease (H1) standard. The insert is composed of 440 grade stainless steel. Stainless covers are available for these units to give additional protection. The operating temperature range is from $-20\text{ }^{\circ}\text{C}$ to $+100\text{ }^{\circ}\text{C}$.

8 Ceraball bearing units (special code Y1 to Y7)

Ceraball bearings have Silicon Nitride (Si_3N_4) ceramic balls, and ensure stable performance for long periods of time even in special operating environments. These environments include : high temperature, corrosion, high speed rotation, low torque, and vacuum.

Y1 type (high speed rotation)

- This bearing is designed for applications with high speed rotation in which the dN value exceeds 200 000. This is made possible by the lightweight ceramic balls.

Y2 type (standard)

- This is the standard model in the Ceraball series. It is designed to withstand temperatures of $250\text{ }^{\circ}\text{C}$. It resists corrosive conditions such as heated steam, chemical and solvents. It can be used in clean room conditions due to its' low dust and low torque properties. It will also perform well in insulated or vacuum conditions.

Y3 type (extra high temperature)

- This bearing is designed for environments that experience temperature in excess of $300\text{ }^{\circ}\text{C}$, and where greasing is hard to execute. For these applications FYH offers the Y3 type of bearing with solid lubricant used for the cage. These bearings are designed to withstand temperatures of up to $450\text{ }^{\circ}\text{C}$.

Y7 type (anticorrosion type)

- This bearing is designed to perform in areas where standard bearings fail. This bearing is suited to corrosive environments where bearings may be exposed to solvents, or underwater applications. This bearing is best for light loads and low speed rotation.

3 Selection of units

3 Selection of units

3.1 Outline of selection

FYH ball bearings are available in many models and types. To make sure that you are selecting the bearings that will best suit your application many factors must be considered. These include : the structure and space limitations of

the machinery, operating conditions, load, temperature, and speed. The life you will get out of the bearing unit will greatly depend on proper selection.

Procedures for choosing the correct ball bearing unit are shown in **Table 3.1**.

Table 3.1 Procedures of selection of ordinary ball bearing units

Procedures of selection	Items to be examined	Operating conditions to be considered	Reference
1 Selection of model	<ul style="list-style-type: none"> · Pillow type · Flange type · Take-up type · Cartridge type · Hanger type 	Structure of machinery, mounting space, mounting dimensions	2 Models (P.6)
2 Selection of shaft dia. and dia. series	<ul style="list-style-type: none"> · Bearing bore dia. : From 8 to 140 mm · Dia. series : 0, 2, X, 3 	Rating life of bearings required, load applied to bearings, rotating speed	4 Rating life of bearings (P.19) 5 Bearing load (P.22) 6 Allowable rotating speed (P.29)
3 Selection against atmosphere	<ul style="list-style-type: none"> · L3 type · Cover type · Clean series · Stainless steel series · Ceramic series · For high speed use · For blower 	Environment (dusts, mud water, moisture, chemicals), rotating speed	2 Models (P.6) (P.14) 6 Allowable rotating speed (P.29)
4 Selection against temperature	<ul style="list-style-type: none"> · Heat resistant type · Cold resistant type · Ceraball series · Measures against expansion and contraction of shaft · Grease supply 	Bearing temperature	2 Models (P.6) (P.14) 7 Operating temperature and bearing specifications (P.30) 9 Design of shaft and base (P.36) 14 Handlings (P.52)
5 Selection of installing to shaft	<ul style="list-style-type: none"> · Set screw · Adapter · Eccentric locking collar 	Rotating speed, load conditions, handling	2 Models (P.6) 14 Handlings (P.52)
6 Selection of shafts	<ul style="list-style-type: none"> · Dimensional tolerance · Adoption of shouldered shaft · Provision of set screw for shaft · Measures against expansion and contraction of shaft 	Rotating speed, load conditions, bearing temperature	2 Models (P.6) (P.14) 6 Allowable rotating speed (P.29) 9 Design of shaft and base (P.36) 14 Handlings (P.52)
7 Selection of strength of housings	<ul style="list-style-type: none"> · Cast iron · Cast steel · Steel plate 	Load conditions, load directions, presence of impact	8 Strength of housings (P.31)
8 Selection of lubricant	<ul style="list-style-type: none"> · Lubricating type · Non-lubricating type · Centralized lubricating type · Greasing interval 	Environment, importance of machine, bearing temperature, grease life	14 Handlings (P.52)
9 Selection of maintenance and check	<ul style="list-style-type: none"> · Periodic inspection · Grease supply 	Environment, importance of machine, bearing temperature, grease life	14 Handlings (P.52)

3.2 Selection of model specifications

FYH ball bearing units are available in various models and offer options for different operating environments.

When selecting models and specifications of units care must be taken to consider all factors that can affect the bearing life : **Table 3.2** will help with proper selection of ball bearing unit models.

Table 3.2 Outline of selection of ball bearing unit models and specifications

○ : Acceptable or Yes, × : Unacceptable or No

Category	Performance required		Bearing specifications			Applicable housing
	Operating conditions	Installing to shaft	Sealing structure	Model code	Lubrication	
Bearing	General	Set screw Adapter	Seal and slinger	UC UK	○	C, F, FA, FB, FC, FL, FS, HA, IP, P, PA, PH, T, TH, TL, TU
		Eccentric locking collar		NA	○	C, FC, NF, NFL, P, T
	Dustproof and waterproof	Set screw Adapter	L3	UC-L3 UK-L3	○	C, F, FA, FB, FC, FL, FS, HA, IP, P, PA, PH, T, TH, TL, TU
	Lightweight	Set screw	Seal	SB SU	×	LF, LP, PF, PFL, PP, PTH, NPTH, FL0, P0
	Anticorrosion	Set screw	Seal and slinger	UC-S6 Y2 · Y7	○	SF-H1, SFL-H1, SP-H1, SPA-H1
			Seal	SU-S6	×	SFL, SP
Heat resistant Cold resistant For high speed For blower	Set screw Adapter	Seal and slinger	UC UK Y1 · Y2 · Y3	○	C, F, FA, FB, FC, FL, FS, HA, IP, P, PA, PH, T	

Category	Performance required		Housing specifications				Applicable bearing
	Type	Operating conditions	Model code	Material	Presence of cover	Lubrication	
Housing	Pillow type	General	P	Cast iron			UC (-L3), UK (-L3)
		Cast steel (highly strong)	Psc	Cast steel	○	○	
		Thick (highly strong)	IP	Cast iron			
		Tapped-base	PA			○	UC (-L3)
		High centerheight	PH	Cast iron	×	○	UC (-L3)
		Lightweight	LP			×	SB
		Clean	P0	Special light alloy		×	SU
	Anticorrosion	SP-H1, SPA-H1 SP	Stainless steel	○	○	UC-S6	
			Stainless steel		○	UC-S6	
			Stainless steel		×	SU-S6	
	Steel plate	PP	Steel plate	×	×	SB	
	Flange type	Square	F	Cast iron			UC (L3), UK (L3)
		Anticorrosion	SF-H1	Stainless steel		○	UC-S6
Cartridge (square) (round)		FS	Cast iron			UC (L3), UK (L3)	
		FC	Cast iron			UC (L3), UK (L3)	
Oval		FL		○			
Shaft alignment (adjustable oval)		FA	Cast iron	×	○	UC (-L3)	
Cantilever (deformed)		FB		×			
Lightweight (oval)	LF	Cast iron	×	×	SB		
Clean (oval)	FL0	Special light alloy	○		SU		

3 Selection of units

Category	Performance required		Housing specifications				Applicable bearing
	Type	Operating conditions	Model code	Material	Presence of cover	Lubrication	
Housing	Flange type	Anticorrosion (oval)	SFL-H1	Stainless steel	○	○	UC-S6
			SFL	Stainless steel	○	×	SU-S6
		Steel plate (round) (oval)	PF PFL	Steel plate	×	×	SB
	Take-up type	General	T	Cast iron	○	○	UC (-L3), UK (-L3)
		Anticorrosion	ST-H1	Stainless steel	○	○	UC-S6
		Section steel frame type	T	Cast iron	○	○	UC (-L3)
		Channel steel frame type	TL TU	Cast iron	○	○	UC (-L3), UK (-L3)
		Steel plate frame type	PTH NPTH	Steel plate	×	×	SB
	Cartridge type	General	C	Cast iron	×	○	UC (-L3), UK (-L3)
	Hanger type	General	HA	Cast iron	×	○	UC (-L3)

3.3 Selection of bearings from a maintenance viewpoint

FYH ball bearing units require little if any maintenance when being used in general operating conditions. Periodic checks will help ensure that the bearings are performing as required. The periodic checks should be based upon your application. Bearings operating in a clean environment with low load, and low RPM need to be checked less often than units in a dirty environment, with higher loads. Care should be taken to make sure that the bearings are being properly lubricated and that the right kind of grease is being used. If great axial load will be present a shouldered shaft should be used. If the bearing environment is wet or dusty a cover of L III type of insert should be used. In an environment exposed to high or low temperature the type of grease and the material of the seals must be taken fully into consideration.

4 Rating life of bearings

When ball bearing units are installed and operated on a piece of machinery eventually a failure will occur. The period of operation until the unit cannot be used due failure is called the bearing life.

Bearing failure is caused by two main reasons. The first is fatigue of bearing material, and the second is degradation of grease. The life is figured on whichever fail first. Proper bearing lubrication will eliminate grease degradation and allow the full bearing life to be achieved. If the bearing units are run without replenishment of the grease the bearing life will have to be factored by either the grease life or the bearing life. During installation care must be taken not to dent or crack the insert. Proper bearing maintenance and lubrication will ensure long bearing life.

4.1 Basic rating life and basic load rating

4.1.1 Basic rating life

When a bearing is rotated under load, the raceways, the surfaces of the inner and outer rings, and the rolling elements are exposed to load continuously. Damages such as scaling appear eventually on the material (flaking or peel-off). The total rotating frequency until the damage appears is called the “fatigue limit of the bearing”. Fatigue limit of the bearing can vary greatly even if the bearings have the same structure, dimensions, materials, machining methods, and are operated under the same conditions.

To solve this if a group of the same bearings operating under the same conditions the total rotating frequency of 90% of the bearings operating with no damage due to rotating fatigue (life of 90% reliability) is called the basic load rating.

4.1.2 Basic load rating

Dynamic ratings are determined by placing a pure radial load on a radial bearing or by placing a central axial load on a thrust bearing. The dynamic rating is the load that the bearing will withstand for one million cycles before failure of the bearing.

These ratings are referred to as the **basic dynamic radial load rating** (C_r) or the **basic dynamic axial load rating** (C_a). These values are shown in the catalog.

In the ball bearings for ball bearing units, it is indicated as the basic dynamic radial load rating (C_r), and the value is shown in the dimensional table.

4.2 Calculation of rating life

The relation between the basic rating life, the basic dynamic load rating, and the dynamic equivalent load of the ball bearings for ball bearing type units are indicated in **Formula (4.1)**. If the ball bearing unit is being used at a fixed rotating speed, the life is indicated as time. This is shown in **Formula (4.2)**.

$$\text{(Total rotating frequency)} \quad L_{10} = \left(\frac{C_r}{P_r}\right)^3 \dots\dots\dots (4.1)$$

$$\text{(Time)} \quad L_{10h} = \frac{10^6}{60n} \left(\frac{C_r}{P_r}\right)^3 \dots\dots (4.2)$$

Whereas,

- L_{10} : Basic rating life, 10^6 rotations
- L_{10h} : Basic rating life, hr
- C_r : Basic dynamic load rating, N
- P_r : Dynamic equivalent load, N
(see “5 Bearing load”)
- n : Rotating speed, min^{-1}

Calculation of the basic rating life using the life factor (f_h) and the speed factor (f_n) in the **Formula (4.2)** are shown below.

$$L_{10h} = 500 f_h^3 \dots\dots\dots (4.3)$$

$$\text{Life factor} \quad f_h = f_n \cdot \frac{C_r}{P_r} \dots\dots\dots (4.4)$$

$$\begin{aligned} \text{Speed factor} \quad f_n &= \left(\frac{10^6}{500 \times 60n}\right)^{1/3} \\ &= (0.03n)^{-1/3} \dots\dots\dots (4.5) \end{aligned}$$

Values of f_n , f_h and L_{10h} can be found using the nomogram of **Fig. 4.1**.

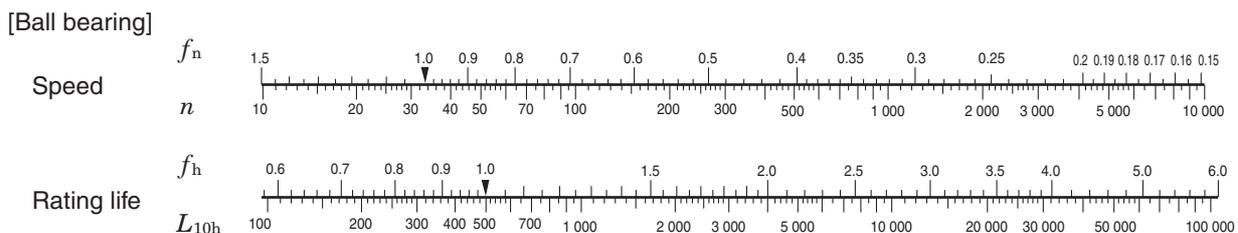

Fig. 4.1 Relation between basic rating life (L_{10h}) and rotating speed (n), speed factor (f_n), and life factor (f_h)

4.2.1 Correction of basic load rating due to temperature

If a ball bearing unit is used at a high temperature the physical composition of the bearing material is changed, leading to decreased hardness. This decreased hardness leads to the basic dynamic load rating being reduced. Once the structure of the bearing material has been changed, it will remain this way for the life of the unit, even when it returns to room temperature.

When using a ball bearing unit at 150 °C or more, the basic load rating must be corrected by multiplying the basic dynamic load rating shown in the dimensional table by the temperature factor shown in **Table 4.1**.

Table 4.1 Temperature factor

Bearing temperature, °C	125	150	175	200	250
Temperature factor	1	1	0.95	0.9	0.75

4.2.2 Corrected rating life

The basic L_{10} rating life shown in **Formula (4.1)** is the fatigue life of a bearing with 90% reliability ; there are circumstances where bearings need greater reliability. The bearing life may be extended by using special materials. Other conditions including lubrication may influence the bearing life.

The corrected rating life is found by taking the basic rating life and using the points in **Formula (4.6)** into consideration.

$$L_{na} = a_1 a_2 a_3 L_{10} \dots\dots\dots (4.6)$$

Whereas,

- L_{na} : Corrected rating life, 10^6 rotations
Life that characteristics of bearing and operating conditions are taken into consideration with reliability $100-n\%$ (breakage probability)
- L_{10} : Basic load rating, 10^6 rotations
Life with 90% reliability
- a_1 : Reliability factor see (1)
- a_2 : Bearing characterization factor see (2)
- a_3 : Operating condition factor see (3)

(1) Reliability factor a_1

Table 4.2 shows the values used when a corrected bearing life that has less than a 10% breakage probability is necessary.

Table 4.2 Reliability factor a_1

Reliability, %	L_{na}	a_1
90	L_{10a}	1
95	L_{5a}	0.62
96	L_{4a}	0.53
97	L_{3a}	0.44
98	L_{2a}	0.33
99	L_{1a}	0.21

(2) Bearing characterization factor a_2

The material make-up of a bearing can have an affect on its' basic rating life. Factors that can influence the bearing include : bearing material (type of steel), production procedures, and bearing design. Bearing characterization is shown as the factor a_2 .

FYH ball bearing inserts use high quality vacuum degassed bearing steel as standard material. This material allows for a longer rating life. For FYH ball bearing units the bearing characterization factor a_2 is 1 ($a_2 = 1$). When bearings with special materials are used for a longer fatigue limit the characterization factor can be shown as a_2 being greater than 1 ($a_2 > 1$).

(3) Operating condition factor a_3

Operating conditions may directly influence the life of the bearing (especially proper or improper greasing). The basic rating life should be corrected using the operating condition factor a_3 . If lubrication is being maintained the factor $a_3 = 1$. If excellent re-lubrication practices are being maintained the factor $a_3 > 1$ should be applied.

If any of the following operating conditions are applicable the condition should be applied as $a_3 < 1$.

- (1) Kinematical viscosity of lubricant during operation is low Ball bearing : $13 \text{ mm}^2/\text{s}$ or less, roller bearing : $20 \text{ mm}^2/\text{s}$ or less
- (2) Rotating speed is low $d_m n$: 10 000 or less
Remark d_m (Pitch dia. of ball set) $\times n$ (Rotating speed)
- (3) Foreign matters are mixed in lubricant

Even if the bearing characterization factor is improved i.e., $a_2 > 1$, the life of the bearing must still be downrated if the combination, $a_2 \times a_3 > 1$.

4.2.3 Required lifetime of bearings

At some point continuing to use a ball bearing unit does not lead to economical operation. Operating conditions, the type of bearing units used, and the type of machine the bearing is used on all influence the lifetime of the bearing.

The required lifetime of the ball bearing units is shown in **Table 4.3**.

Table 4.3 Required life time of ball bearing units (reference)

Operating conditions	Machines used	Required life time, hr
Operated in short period or intermittently	Home electric appliances, electric tool, agricultural machinery, hoist, etc.	4 000 – 8 000
Discontinuously but for a long period	Factory motor, ordinary gear, etc.	12 000 – 20 000
Always operated for 8 hours or longer a day or operated continuously for a long period	General machinery, blower, etc.	20 000 – 30 000
Operated continuously for 24 hours, no fault is allowed	Electric power plant facility, mine drainage facility, etc.	100 000 –200 000

4.3 Grease life

The grease life for ball bearing units is influenced by : the level of the load, rotating speed of the bearing, and the operating temperature.

The grease life for ball bearing units being used under appropriate operating conditions can be found by the formula shown below.

$$\log L = 6.10 - 4.40 \times 10^{-6} d_m n - 2.50 \left(\frac{P_r}{C_r} - 0.05 \right) - (0.021 - 1.80 \times 10^{-8} d_m n) T \dots\dots\dots (4.7)$$

Whereas,

L : Grease life, hr

d_m : Pitch dia. of ball set, mm

$$d_m = \frac{(D + d)}{2}$$

D : Nominal bearing outer dia.,
 d : Nominal bearing bore dia.)

n : Rotating speed of bearing, min⁻¹

P_r : Dynamic equivalent radial load, N
(see “5 Bearing load”)

C_r : Basic dynamic radial load rating of bearing, N

T : Operating temperature of bearing, °C

Applicable conditions for the **Formula (4.7)** are shown below.

1) Operating temperature of bearing : T °C

To be applied if the following condition is satisfied :
 $T \leq 100$

(If T is smaller than 50 ($T < 50$),
following condition should be applied : $T = 50$.)

If T is larger than 100 ($T > 100$), contact FYH.

2) Rotating speed of bearing : $d_m n$

To be applied if the following condition is satisfied :
 $d_m n \leq 30 \times 10^4$

(If $d_m n$ is smaller than 12.5×10^4 ($d_m n < 12.5 \times 10^4$),
following condition should be applied :
 $d_m n = 12.5 \times 10^4$)

If $d_m n$ is larger than 30×10^4 ($d_m n > 30 \times 10^4$),
contact FYH.

3) Load condition of bearing : $\frac{P_r}{C_r}$

To be applied if the following condition is satisfied :
 $\frac{P_r}{C_r} \leq 0.2$

(If $\frac{P_r}{C_r}$ is smaller than 0.05 ($\frac{P_r}{C_r} < 0.05$),
following condition should be applied : $\frac{P_r}{C_r} = 0.05$)

If $\frac{P_r}{C_r}$ is larger than 0.2 ($\frac{P_r}{C_r} > 0.2$), contact FYH.

Reference figure of grease life obtained by the **Formula (4.7)** is shown in **Fig. 4.2**.

(1) Bearing load $\cdot \frac{P_r}{C_r} = 0.05$

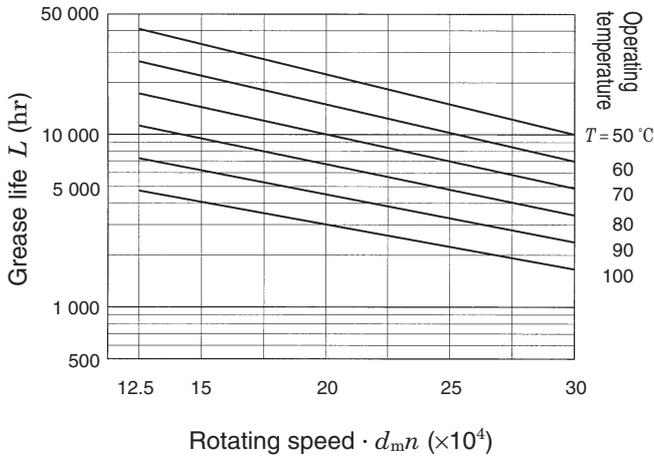

(2) Bearing load $\cdot \frac{P_r}{C_r} = 0.125$

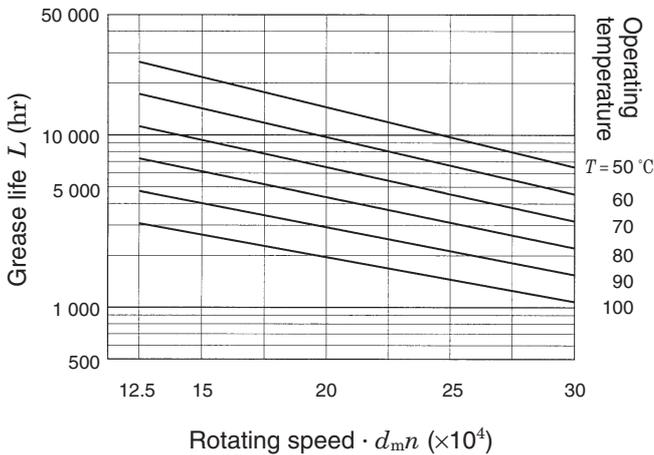

(3) Bearing load $\cdot \frac{P_r}{C_r} = 0.2$

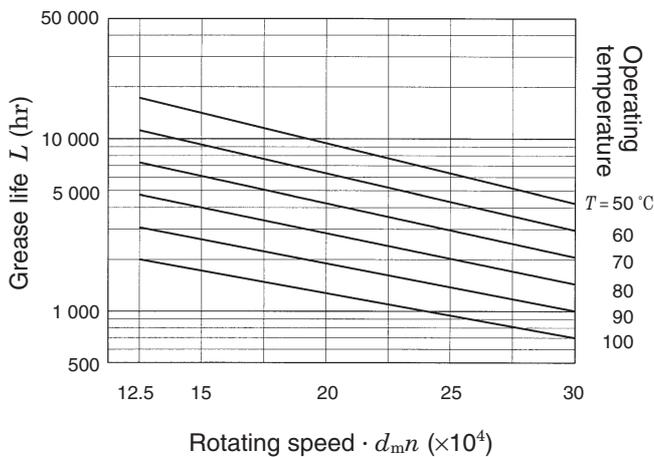

Fig. 4.2 Relation of grease life to bearing load, rotating speed, and operating temperature (reference)

5 Bearing load

Loads applied to bearings come from various considerations. These include the weight of objects supported by the bearing and any resulting shock or dynamic load therefrom, the force exerted by gears and drive belts to pull a load and overcome friction between moving surfaces, e.g., the friction between a conveyor belt and the conveyor frame. In many cases, these loads cannot be determined by a simple calculation.

Since these loads are often fluctuating in intensity, it is difficult to determine the exact magnitude of these loads prior to actual lab or field measurements on the machine involved.

However, in order to approximate the loads involved prior to putting a machine into operation, the following technique may be used. This technique uses multiplication factors that have been determined empirically from sample measurements taken on actual machines in operation.

5.1 Loads applied to bearings

5.1.1 Load factor

Even if the static radial load and the axial load can be accurately calculated, the actual loads are generally greater than this. This is because of vibration and shock loads during actual machine operation.

To find the loads actually applied to a bearing, multiply the values determined for the static load by the following load factors.

$$F = f_w \cdot F_c \dots\dots\dots (5.1)$$

Whereas,

F : Load actually applied to bearing, N

F_c : Theoretically calculated load, N

f_w : Load factor (see **Table 5.1**)

Table 5.1 Load factor f_w

Operating conditions	Applications	f_w
Virtually no vibration or impact	Electric machines and instruments	1 –1.2
Ordinary operation (weak impact)	Agricultural machines and blower	1.2–2
Great vibration and impact	Construction machines and grinders	2 –3

5.1.2 Loads from belts or chain drives

The load calculated for the bearing is equal to the tensile load of the belt. However this load must be multiplied by the load factor (f_w) which accounts for vibration and impact of the machine and a belt factor (f_b) which accounts for the vibration and impact generated through the belt.

When calculating loads for a chain drive, use the same factor (f_b) as used for belt drives.

$$F_b = \frac{2M}{D_p} \cdot f_w \cdot f_b$$

$$= \frac{19.1 \times 10^6 W}{D_p \cdot n} \cdot f_w \cdot f_b \dots\dots\dots (5.2)$$

Whereas,

- F_b : Load actually applied to pulley shaft or sprocket shaft, N
- M : Torque applied to pulley or sprocket, mN · m
- W : Transmitted power, kW
- D_p : Pitch circle dia. of pulley or sprocket, mm
- n : Rotating speed, min⁻¹
- f_w : Load factor (see **Table 5.1**)
- f_b : Belt factor (see **Table 5.2**)

Table 5.2 Belt factor f_b

Belt type	f_b
Toothed belt	1.3–2
V belt	2 –2.5
Flat belt (with tension pulley)	2.5–3
Flat belt	4 –5
Chain	1.2–1.5

5.1.3 Load of gear transmissions

Gear transmissions have a load in the tangential direction (K_t), a load in the radial direction (K_r) and an axial load (K_a). Different types of gears are calculated differently.

The following is a sample of a calculation for an ordinary spur gear arrangement. A flat spur gear will not support an axial load.

- (1) Load applied to gear in tangential direction (tangential line force)

$$K_t = \frac{2M}{D_p} = \frac{19.1 \times 10^6 W}{D_p n} \dots\dots\dots (5.3)$$

- (2) Load applied to gear in radius direction (separating force)

$$K_r = K_t \tan \alpha \dots\dots\dots (5.4)$$

- (3) Synthetic load applied to gear

$$K_g = \sqrt{K_t^2 + K_r^2} = K_t \sec \alpha \dots\dots\dots (5.5)$$

Whereas,

- K_t : Load applied to gear in tangential direction (tangential line force), N
- K_r : Load applied to gear in radius direction (separating force), N
- K_g : Synthetic load applied to gear, N
- M : Torque applied to gear, mN · m
- D_p : Pitch circle dia. of gear, mm
- W : Transmission power, kW
- n : Rotating speed, min⁻¹
- α : Pressure angle of gear, °

Note that the actual gear load must be found by multiplying the theoretical load by the load factor (f_w) obtained by taking into consideration the vibration and impact loads generated while the machine is in operation. The gear factor (f_g) is determined by taking into consideration the accuracy of machining and the finish of the gears.

$$F_g = f_w \cdot f_g \cdot K_g \dots\dots\dots (5.6)$$

Whereas,

- F_g : Load actually applied to gear, N
- K_g : Theoretically synthetic load applied to gear, N
- f_w : Load factor (see **Table 5.1**)
- f_g : Gear factor (see **Table 5.3**)

Table 5.3 Gear factor f_g

Gear type	f_g
Precision gear (both pitch error and tooth profile error should be 0.02 mm or less)	1 –1.1
Ordinary gear (both pitch error and tooth profile error should be 0.1 mm or less)	1.1–1.3

5 Bearing load

5.2 Distribution of bearing load

In order to determine the radial load distribution to each bearing attached to a shaft, use the procedure shown below. Use the load factors shown in **Table 5.1** to account for vibration and impact.

Often a bearing bears an axial load component in addition to the radial component. In this case calculate the total vectored load as shown previously by taking the square root of the sum of the squares of each load.

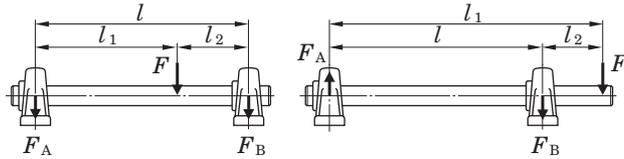

$$F_A = \frac{l_2}{l} \cdot F \quad \dots\dots\dots (5.7)$$

$$F_B = \frac{l_1}{l} \cdot F \quad \dots\dots\dots (5.8)$$

Fig. 5.1 Distribution of load to bearings

5.3 Dynamic equivalent load

In many cases, a bearing is exposed to the combined vector load of both radial and axial load components. Also it is used under more severe conditions of vibration and impact loads. In this case a direct comparison to the dynamic load rating is not appropriate.

In such a case, find the load equivalent to a direct radial (only) load and compare this with the basic dynamic load rating.

The converted virtual load is called dynamic equivalent load (P).

5.3.1 Calculation of dynamic equivalent load

The dynamic equivalent radial load (P_r) of a bearing that bears radial and axial loads as well as vibration and impact is found by the following formula.

$$P_r = XF_r + YF_a \quad \dots\dots\dots (5.9)$$

Whereas,

P_r : Dynamic equivalent radial load, N

F_r : Radial load, N

F_a : Axial load, N

X : Radial load factor (see **Table 5.4**)

Y : Axial load factor (see **Table 5.4**)

Table 5.4 Radial load factor (X) and axial load factor (Y)

$\frac{f_0 F_a}{C_{0r}}$	e	$F_a / F_r \leq e$		$F_a / F_r > e$	
		X	Y	X	Y
0.172	0.19	1	0	0.56	2.30
0.345	0.22				1.99
0.689	0.26				1.71
1.03	0.28				1.55
1.38	0.30				1.45
2.07	0.34				1.31
3.45	0.38				1.15
5.17	0.42				1.04
6.89	0.44				1.00

- Remarks 1. C_{0r} (basic static radial load rating) and f_0 (factor) are shown in the dimensional tables.
 2. If $f_0 F_a / C_{0r}$ does not conform to the table above, find by interpolation.

5.3.2 Average dynamic equivalent load in the case of fluctuating loads

If the level or direction of the load applied to a bearing is fluctuating, it is necessary to find the average dynamic equivalent load to calculate the bearing life.

Table 5.5 shows the method of finding the average dynamic equivalent load under various types of fluctuating conditions.

Table 5.5 Calculation of average dynamic equivalent load in case of fluctuated load

(1) Graduated fluctuation

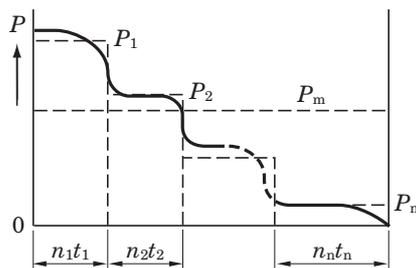

$$P_m = \sqrt[p]{\frac{P_1^p n_1 t_1 + P_2^p n_2 t_2 + \dots + P_n^p n_n t_n}{n_1 t_1 + n_2 t_2 + \dots + n_n t_n}} \quad (5.10)$$

(2) Monotone fluctuation

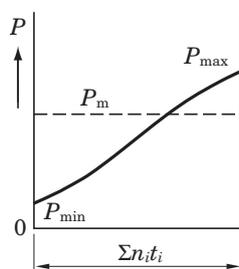

$$P_m = \frac{P_{\min} + 2 P_{\max}}{3} \quad (5.11)$$

(3) Sine curve fluctuation

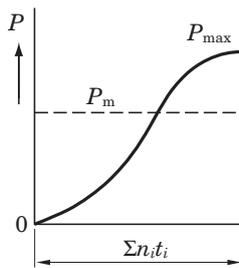

$$P_m = 0.68 P_{\max} \quad (5.12)$$

(4) Sine curve fluctuation (upper half of sine curve)

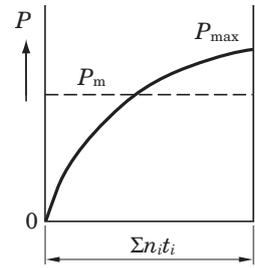

$$P_m = 0.75 P_{\max} \quad (5.13)$$

Whereas,

- P_m : Average dynamic equivalent load, N
- P_1 : Dynamic equivalent load acting for t_1 hours at rotating speed of n_1 , N
- P_2 : Dynamic equivalent load acting for t_2 hours at rotating speed of n_2 , N
- ...
- P_n : Dynamic equivalent load acting for t_n hours at rotating speed of n_n , N
- P_{\min} : Minimum dynamic equivalent load, N
- P_{\max} : Maximum dynamic equivalent load, N
- $\Sigma n_i t_i$: Total rotating frequency for t_1 to t_i hours

5.4 Basic static load rating and static equivalent load

5.4.1 Basic static load rating

If a bearing is exposed to excessive static or impact load even when running at low rotational speed, partial permanent deformation occurs to the contact surface of the raceways of the bearing. The amount of permanent deformation increases with increased loads, and at some point, the bearing will no longer rotate smoothly.

The basic static load rating of a bearing is the static load that generates the calculated contact stresses shown below at the center of the contact surfaces of the raceways.

- (1) Automatic aligning ball bearing 4 600 MPa
- (2) Other ball bearings
(ball bearing for unit is included) 4 200 MPa
- (3) Roller bearing 4 000 MPa

The total permanent deformation that occurs to the raceways and the balls under the above critical contact stresses is 0.000 1 times the diameter of the ball.

In ball bearing units, this is indicated as the basic static radial load rating (C_{0r}) and these values are shown in the dimensional tables.

5 Bearing load

5.4.2 Static equivalent loads

Static equivalent load is the equivalent of the combined (vectored) load converted to the equivalent direct radial load. Static may be considered to be under conditions of no rotation conditions or very low rotating speeds.

Static equivalent radial load (P_{0r}) can be calculated by the formula below.

$$P_{0r} = 0.6 F_r + 0.5 F_a \quad (5.14)$$

$$P_{0r} = F_r \quad (5.15)$$

Whereas,

P_{0r} : Static equivalent radial load, N

F_r : Radial load, N

F_a : Axial load, N

5.4.3 Safety factor

The static equivalent load that can be withstood by a bearing, in addition to the above considerations, sometimes is dependent upon unforeseen conditions in the operating environment. Therefore a safety factor is always built in to insure success in the application.

$$f_s = \frac{C_{0r}}{P_{0r}} \quad (5.16)$$

Whereas,

f_s : Safety factor (see **Table 5.6**)

C_{0r} : Basic static radial load rating, N

P_{0r} : Static equivalent radial load, N

Table 5.6 Safety factor f_s (recommended)

Operating conditions		f_s (Min.)
Being rotated	High rotating accuracy is required	2
	Ordinary operating conditions	1
	Impact	1.5
Not always being rotated (sometimes oscillated)	Ordinary operating conditions	0.5
	Impact, unevenly distributed load	1

5.5 Example of applied calculation

Example 1 Distributing load

Find the load applied to the bearing A and bearing B, if the radial load F_1 ($F_1 = 1.5$ kN) and F_2 ($F_2 = 4.5$ kN) are applied.

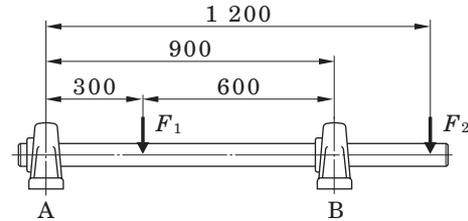

- (1) Find the radial load F_{1A} applied to the bearing A by F_1 , with **Formula (5.7)** and **Formula (5.8)**.

$$F_{1A} = \frac{600}{900} \times 1.5 = 1.0 \text{ (kN)}$$

In a similar manner, find the radial load F_{2A} applied to the bearing A by F_2 .

$$F_{2A} = -\frac{1200 - 900}{900} \times 4.5 = -1.5 \text{ (kN)}$$

Remark Negative load is the upward load.

Radial load F_A applied to the bearing A :

$$F_A = F_{1A} + F_{2A} = 1.0 + (-1.5) = -0.5 \text{ (kN)}$$

- (2) In a similar manner to (1), find the radial load F_B applied to the bearing B.

$$F_{1B} = \frac{300}{900} \times 1.5 = 0.5 \text{ (kN)}$$

$$F_{2B} = \frac{1200}{900} \times 4.5 = 6.0 \text{ (kN)}$$

$$F_B = F_{1B} + F_{2B} = 0.5 + 6.0 = 6.5 \text{ (kN)}$$

Example 2 Calculating load by V-belt transmission

Find the load applied to the bearing A and bearing B when the shaft is driven by the V-belt, transmission power W is 7.5 kW ($W = 7.5$ kW), rotating speed n is 300 min^{-1} ($n = 300 \text{ min}^{-1}$), effective diameter of pulley D_p is 300 mm ($D_p = 300$ mm).

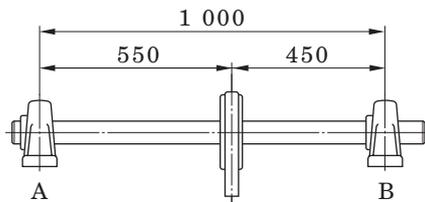

- (1) Find the load actually applied to the pulley shaft F_b with **Formula (5.2)**.

From **Table 5.1**, load factor f_w is 1.2 ($f_w = 1.2$), and the belt factor f_b is 2.5 ($f_b = 2.5$), from **Table 5.2**.

$$F_b = \frac{19.1 \times 10^6 W}{D_p \cdot n} \cdot f_w \cdot f_b$$

$$= \frac{19.1 \times 10^6 \times 7.5}{300 \times 300} \times 1.2 \times 2.5 = 4.78 \text{ (kN)}$$

- (2) Find the load actually applied to the bearing A and bearing B (F_A and F_B) with **Formulas (5.7)** and **(5.8)**.

$$F_A = \frac{450}{1000} \times 4.78 = 2.15 \text{ (kN)}$$

$$F_B = \frac{550}{1000} \times 4.78 = 2.63 \text{ (kN)}$$

Example 3 Calculating dynamic equivalent radial load

Find the dynamic equivalent radial load P_r when the radial load F_r , 1.5 kN ($F_r = 1.5$ kN), and the axial load F_a , 0.85 kN, ($F_a = 0.85$ kN) are applied to the pillow type unit UCP306J (bearing UC306).

- (1) Find the radial load factor (X) and the axial load factor (Y) with using the static radial load rating C_{0r} of UCP306J (bearing UC306), 15.0 kN ($C_{0r} = 15.0$ kN), and **Table 5.4**.

Find the solutions of the following formulas :

$$\frac{f_0 F_a}{C_{0r}} = \frac{13.3 \times 0.85}{15.0} = 0.754, e = 0.264$$

$$\frac{F_a}{F_r} = \frac{0.85}{1.5} = 0.567 > e \text{ (0.264)}$$

Therefore, $X = 0.56$, $Y = 1.68$

- (2) Find the dynamic equivalent radial load P_r with **Formula (5.9)**.

$$P_r = XF_r + YF_a = 0.56 \times 1.5 + 1.68 \times 0.85$$

$$= 2.27 \text{ (kN)}$$

Example 4 Calculating bearing life

Under the conditions shown in the **Example 3**, find the bearing life L_{10h} when a bearing is used for a blower of the rotating speed n , 1000 min^{-1} .

- (1) Select the load factor f_w is 1.2 ($f_w = 1.2$) from **Table 5.1**, and find the bearing load P_r .

$$P_r = f_w \cdot F = 1.2 \times 2.27 = 2.72 \text{ (kN)}$$

- (2) The dynamic radial load rating of UCP306J (bearing UC306), C_r , is 26.7 kN ($C_r = 26.7$ kN), and calculate the bearing life L_{10h} with the **Formula (4.2)**.

$$L_{10h} = \frac{10^6}{60n} \cdot \left(\frac{C_r}{P_r}\right)^3 = \frac{10^6}{60 \times 1000} \times \left(\frac{26.7}{2.72}\right)^3$$

$$\approx 15800 \text{ (hr)}$$

- (3) Calculate bearing life L_{10h} with the nomogram shown in **Fig. 4.1**.

When the rotating speed n is 1000 min^{-1} ($n = 1000 \text{ min}^{-1}$), rotating factor f_n is 0.32 ($f_n = 0.32$). next, find the life factor f_h by speed factor f_n , dynamic radial load rating of bearing C_r , and the bearing load P_r .

$$\text{Life factor } f_h = f_n \cdot \frac{C_r}{P_r} = 0.32 \times \frac{26.7}{2.72} = 3.14$$

From life factor f_h , bearing life $L_{10h} \approx 16000$ hours.

Example 5 Selecting ball bearing units

If a bearing is operated under the following conditions, select the flange type unit (UCF) with at least two years (5000 hours) or longer rating life : rotating speed of shaft n is 1500 min^{-1} ($n = 1500 \text{ min}^{-1}$), and radial load F_r is 5 kN ($F_r = 5$ kN). The radial load F_r includes the load factor and gear factor.

- (1) From the nomogram shown in **Fig. 4.1**, when life time L_h is 5000 hr ($L_h = 5000$ hr), life factor f_h can be found as 2.16 ($f_h \approx 2.16$), and speed factor f_n can be found as 0.28 ($f_n \approx 0.28$) when the rotating speed n is 1500 min^{-1} ($n = 1500 \text{ min}^{-1}$).

$$\text{Dynamic radial load rating } C_r = F_r \cdot \frac{f_h}{f_n} = 5 \times \frac{2.16}{0.28}$$

$$\approx 38.6 \text{ (kN)}$$

- (2) Find the flange type unit that meets the following condition : dynamic radial load rating C_r is 38.6 kN ($C_r = 38.6$ kN). As for the diameter series 2, UCF211J (dynamic radial load rating C_r is 43.4 kN ($C_r = 43.4$ kN)) can be selected.

Example 6 Selecting pillow type units for low speed

If a bearing is used for a dolly under the following conditions, select the pillow type unit (UCP) with 10 000 hours rating life : radial load F_r is 12 kN ($F_r = 12$ kN), and rotating speed is 8 min^{-1} .

- (1) Find the required dynamic radial load rating C_r with using **Formulas (4.4) and (4.5)**.

$$\text{Speed factor } f_n = (0.03n)^{-1/p} = (0.03 \times 8)^{-1/3} \approx 1.61$$

$$\text{Life factor } f_h = \left(\frac{L_{10h}}{500}\right)^{1/p} = \left(\frac{10\,000}{500}\right)^{1/3} \approx 2.71$$

$$\begin{aligned} \text{Dynamic radial load rating } C_r &= P_r \cdot \frac{f_h}{f_n} = 12 \times \frac{2.71}{1.61} \\ &\approx 20.2 \text{ (kN)} \end{aligned}$$

- (2) From **Table 5.6**, define safe factor f_s as 2 ($f_s = 2$), and find the static radial load rating of bearing required C_{0r} .

$$C_{0r} = f_s \cdot P_r = 2 \times 12 = 24 \text{ (kN)}$$

- (3) The unit is used for a dolly, and vibration or impact may occur. Thus, select UCP308J ($C_r = 40.7$ kN, $C_{0r} = 24.0$ kN).

Example 7 Calculating bearing life in case of use at high temperature

Find the bearing life if the heat resistant pillow type unit (UCP215JD1K2) is operated under the following conditions : operating temperature is $175 \text{ }^\circ\text{C}$, radial load F_r is 4 kN ($F_r = 4$ kN), and the rotating speed n is 800 min^{-1} ($n = 800 \text{ min}^{-1}$). Note that the radial load F_r includes load factor and gear factor.

- (1) From **Table 4.1**, find the dynamic load rating C_r with in the case that a bearing is used at $175 \text{ }^\circ\text{C}$.

$$C_r = 67.4 \times 0.95 = 64.0 \text{ (kN)}$$

Find the bearing life L_{10h} with using **Formula (4.2)**.

$$\begin{aligned} L_{10h} &= \frac{10^6}{60n} \cdot \left(\frac{C_r}{P_r}\right)^3 = \frac{10^6}{60 \times 800} \times \left(\frac{64.0}{4}\right)^3 \\ &\approx 85\,000 \text{ (hr)} \end{aligned}$$

- (2) If a bearing unit is operated at $175 \text{ }^\circ\text{C}$, grease is degraded faster, and it cannot be used without lubrication. Supply grease at intervals specified in **Table 14.4**.
- (3) If the shaft is extended excessively, install a bearing unit on the identical shaft on the fixed side (positioning of shaft), and install another bearing unit on the free side (see “9 Design of shaft and base”).

Example 8 Calculating grease life

Find the grease life in the case that pillow type unit UCP204J (bearing UC204) under the following conditions : radial load F_r is 1 kN ($F_r = 1$ kN), and rotating speed n is 800 min^{-1} ($n = 800 \text{ min}^{-1}$). Note that the radial load F_r includes load factor and belt factor. Operating temperature of the bearing should be $40 \text{ }^\circ\text{C}$.

Find the grease life L with using **Formula (4.7)**.

$$\begin{aligned} \log L &= 6.10 - 4.40 \times 10^{-6} d_m n - 2.50 \left(\frac{P_r}{C_r} - 0.05\right) \\ &\quad - (0.021 - 1.80 \times 10^{-8} d_m n) T \\ &= 6.10 - 4.40 \times 10^{-6} \times 12.5 \times 10^4 \\ &\quad - 2.50 \left(\frac{1}{12.8} - 0.05\right) \\ &\quad - (0.021 - 1.80 \times 10^{-8} \times 12.5 \times 10^4) \times 50 \\ &= 4.542 \\ L &\approx 34\,800 \text{ (hr)} \end{aligned}$$

Example 9 Calculating life of bearing units in case of non-lubrication

Find the life of a bearing unit in the case that it is operated under the conditions shown in **Example 8**, but without lubrication.

- (1) Find the rating life of bearings L_{10h} with using **Formula (4.2)**.

$$\begin{aligned} L_{10h} &= \frac{10^6}{60n} \cdot \left(\frac{C_r}{P_r}\right)^3 = \frac{10^6}{60 \times 800} \times \left(\frac{12.8}{1}\right)^3 \\ &\approx 43\,700 \text{ (hr)} \end{aligned}$$

- (2) Compare the grease life L shown in **Example 8** to the rating life of bearings L_h . Then, grease life L is shorter than the bearing rating life. Therefore, life of a bearing unit should be the same as the grease life L , 34 800 hours ($L = 34\,800$ hours).

6 Allowable rotating speed

6.1 Allowable rotating speed

The rotational speed of a bearing is limited by the temperature increase, mainly due to friction. When the bearing reaches the speed limits shown below, it will seize if operated continuously at these levels.

The limiting rotational speed is the maximum speed at which the bearing can be safely operated continuously.

These allowable rotational speeds of a ball bearing unit is dependent upon the dimensions of the bearing, type of seal and the fit of the bearing inner ring to the shaft.

Table 6.1 shows the standard allowable rotating speeds of ball bearing units.

Table 6.1 Allowable rotating speed of ball bearing units (standard value)

Unit : min⁻¹

Bore dia. code	UC type bearing, UC-S6 type bearing, UK type bearing, NA type bearing, ER, RB type bearing										SA type bearing SB type bearing	SU type bearing SU-S6 type bearing
	Standard type, heat resistant (D1K2), cold resistant type (D2K2)			L III type (L3)			Heat resistant type (D9K2)	Heat resistant type (K3), for blower (S5)				
	Diameter series			Diameter series			Diameter series	Diameter series				
	2	X	3	2	X	3	2, X, 3	2	X	3		
8												10 000
00	–			–			–	–			–	10 000
01	5 800			2 300			3 800	8 700			6 800	8 000
02	5 800			2 300			3 800	8 700			6 800	6 600
03	5 800			2 300			3 800	8 700			6 800	5 800
04	5 800	–	–	2 300	–		3 800	8 700	–	–	5 800	5 000
05	5 100	4 300	4 600	2 100	960		3 000	7 700	6 400	6 700	5 100	4 000
06	4 300	3 700	3 900	960	830	–	2 500	6 400	5 500	5 800	4 300	3 300
07	3 700	3 300	3 400	830	750	770	2 100	5 500	5 000	5 100	3 700	–
08	3 300	3 100	3 100	750	690	690	1 900	5 000	4 600	4 600	3 300	
09	3 100	2 800	2 700	690	640	620	1 700	4 600	4 300	4 100	3 100	
10	2 800	2 500	2 400	640	570	550	1 500	4 300	3 800	3 700	2 800	
11	2 500	2 300	2 300	570	520	510	1 400	3 800	3 500	3 400		
12	2 300	2 200	2 100	520	490	470	1 300	3 500	3 200	3 100		
13	2 200	2 100	1 900	490	460	440	1 200	3 200	3 100	2 900		
14	2 100	2 000	1 800	460	440	410	1 100	3 100	2 900	2 700		
15	2 000	1 800	1 700	440	410	380	1 000	2 900	2 700	2 600		
16	1 800	1 700	1 600	410	380	360	940	2 700	2 600	2 400		
17	1 700	1 600	1 500	380	360	340	880	2 600	2 400	2 300		
18	1 600	1 500	1 400	360	340	320	830	2 400	2 300	2 100		
19	–	–	1 400	–	–	310	790	–	–	2 000		
20		1 300	1 300		300	280	750		2 000	1 900		
21		–	1 200		–	–	710		–	1 800		
22			1 100			250	680			1 700		
24			1 100			240	630			1 600		
26			1 000			220	580			1 500		
28			910			200	540			1 400		

Remarks 1. Allowable rotating speed of the units with covers is 80% of the value shown in the table above.

2. If a bearing unit is used with excessively loose fitting, allowable rotating speed must be corrected by multiplying it by the fitting factor f_c shown in **Table 6.2**.

6.2 Rotational speed adjustment due to shaft fit

Normally for easier installation of a bearing to the shaft, a clearance fit is used. The amount of clearance must be factored in to determine the maximum allowable rotational speed. As rotational speed is increased, this clearance fit must be tighter.

Table 6.2 shows the factor that must be used to correct the allowable rotational speed. The maximum rotational speed is determined by multiplying the speed found in **Table 6.1** by the factors below. This table includes the multiplying factors for set screw units as well as units with adapters and eccentric locking collars. Due to the characteristics of units with adapters, a loose fit, h8 or h9, is acceptable. Likewise the eccentric locking collar does not lend itself to loose tolerances and an h5 or j5 fit is recommended to achieve the maximum speed.

Table 6.2 Fitting factor of ball bearing units f_c (recommended)

Type of ball bearing units	Fitting factor f_c					
	Shaft tolerance range class					
	h5, j5	j6	h6	h7	h8	h9
With set screws						
Standard type	–	1	1	0.8	0.5	0.2
L III type (Accessory code : L3)	–	–	–	1	1	0.9
Heat resistant type (Special code : D1K2)	–	–	–	1	1	0.7
Cold resistant type (Special code : D2K2)	–	–	–	1	1	0.7
For high speed (Special code : K3)	–	1	0.8	0.6	–	–
For blower (Special code : S5)	1	–	0.8	0.6	–	–
With adapters	–	–	–	–	1	1
With eccentric locking collar	1	–	–	–	–	–

7 Operating temperature and bearing specifications

7.1 Operating temperature range

The operating temperature of a ball bearing unit depends on the type of grease, the material of the seal and the internal clearance of the bearing.

FYH Ball Bearing Units are available in high temperature (D1K2) and low temperature (D2K2) series, in addition to the standard models to allow selection of the right bearing for your operational temperature (see **Table 2.3**).

The correct unit must be chosen for temperature range and it is equally important to use the specified grease according to the specified schedule.

7.2 Operating temperature and internal clearance of bearings

When bearings are operated in a high ambient temperature environment or when the operating temperature is high because of rotational speed, differential expansion rates occur within the bearing components. This causes higher friction, grease breakdown and eventual seizure.

If the temperature difference between the inner and outer ring is known or can be approximated, then the following **Formula (7.1)** may be applied.

Under these conditions, decrease in the internal clearance must be calculated, and the internal clearance of bearings needs to be selected properly.

$$S_{t1} = \alpha \cdot D_e \cdot \Delta t \dots\dots\dots (7.1)$$

Whereas,

S_{t1} : Decrease in the internal clearance of bearings depending on the difference in the temperatures of the bearing inner ring and the bearing outer ring can be found by formula, mm

α : Line expansion factor of bearing steel, 12.5×10^{-6}

D_e : Raceway dia. of bearing outer ring, mm

Diameter series 2, X $D_e \approx 0.92 D$

Diameter series 3 $D_e \approx 0.9 D$

D : Nominal bearing outer dia., mm

Δt : Difference in temperatures of bearing inner ring and outer ring, °C

If a ball bearing unit is used in a high temperature environment, an abnormal load will be result due to thermal expansion of the shaft. This must be compensated for by allowing free movement of one side of the shaft.

(See “9 Design of shaft and base”)

8 Strength of housings

FYH bearings can withstand very high loads due to the design and the usage of only high quality material. However when high static or impact loads are encountered, the load capacity of the bearing must be determined.

The housing design is such that it can withstand loads from any angle ; however the bearing is strongest with a direct downward load through the base of the bearing. For other load directions, the allowable load must be determined for that direction.

Rigidity of the base and flatness of the mounting surface also influence the housing strength. The equipment designer or installer must examine and do calculations for the complete supporting structure of the bearing.

8.1 Strength of cast iron housings

Although gray cast iron has many superior characteristics, it may fail under impact loads, particularly in a low temperature environment.

Table 8.1 shows the applicable design safety factors for gray cast iron. Fig. 8.1 to 8.8 show the static rupture strength of the various housing types.

Table 8.1 Safety factor of gray cast iron products (recommended)

Property of load	Safety factor of gray cast iron
Static load	4
With vibration	10
With impact	15

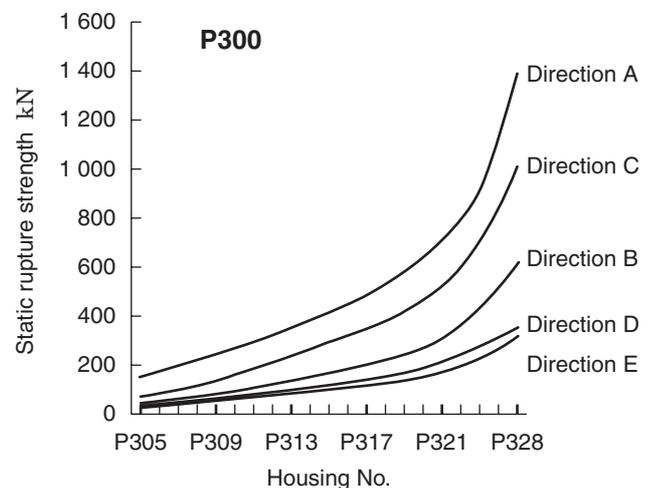
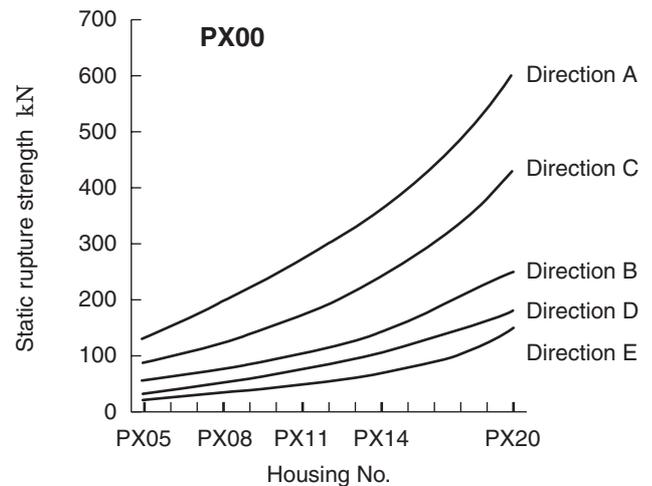
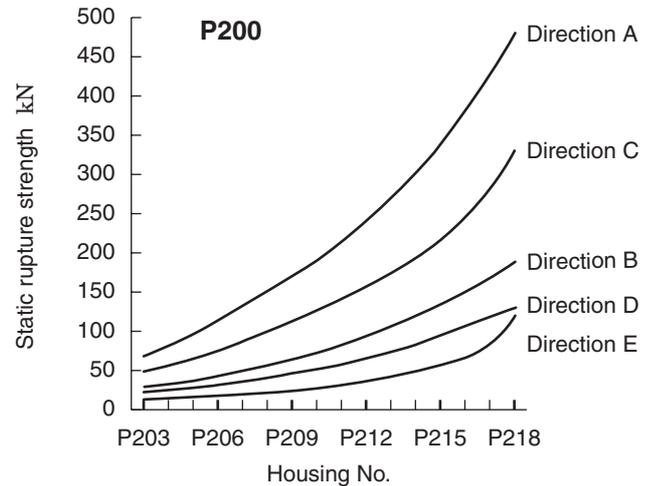
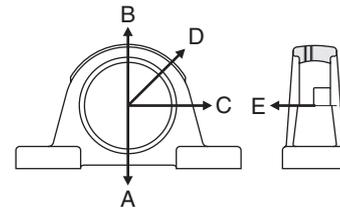

Fig. 8.1 Static rupture strength of pillow type housing (P)

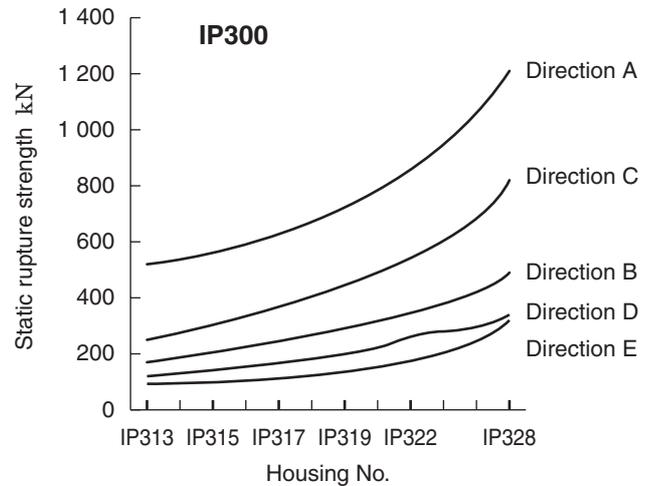
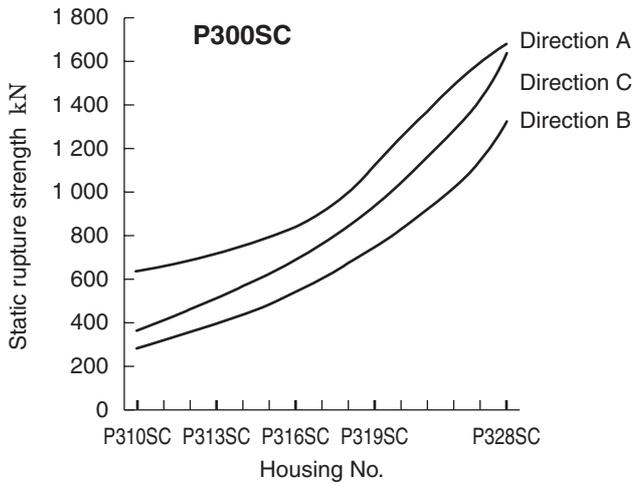
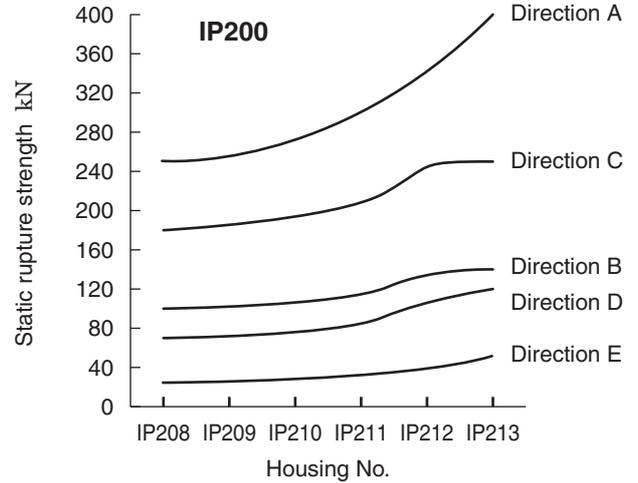
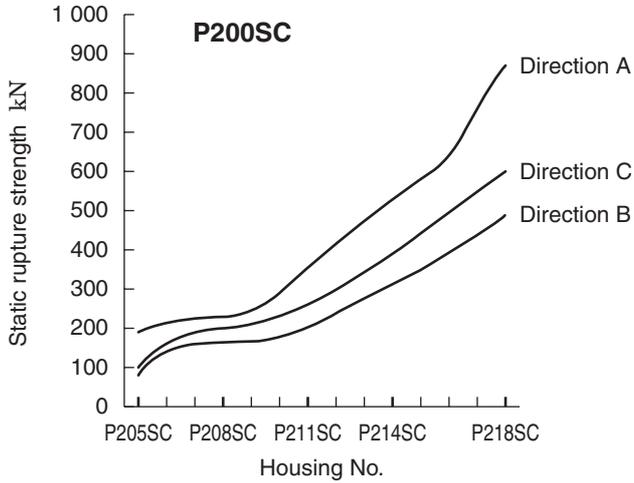
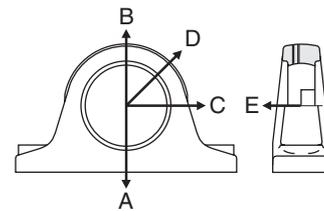
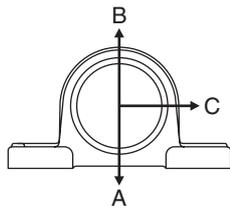

Fig. 8.2 Static rupture strength of cast steel pillow type housings (Psc)

Fig. 8.3 Static rupture strength of thick pillow type housings (IP)

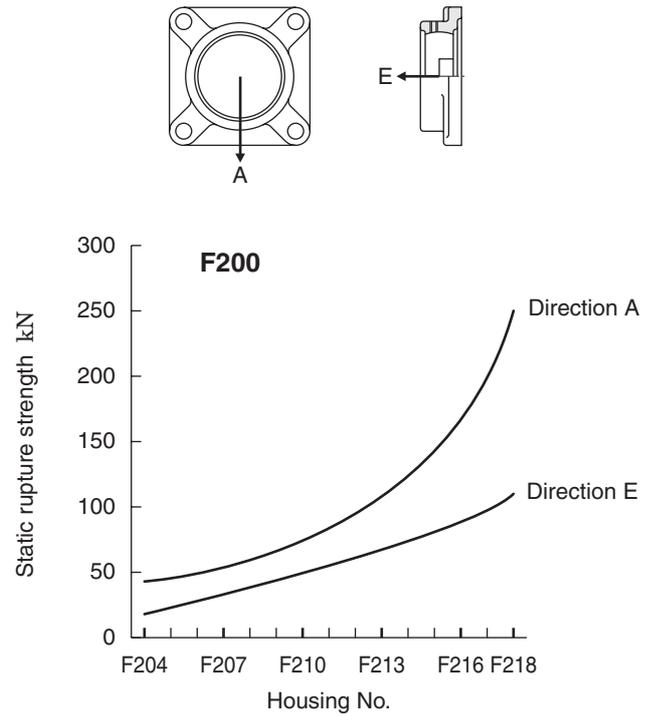
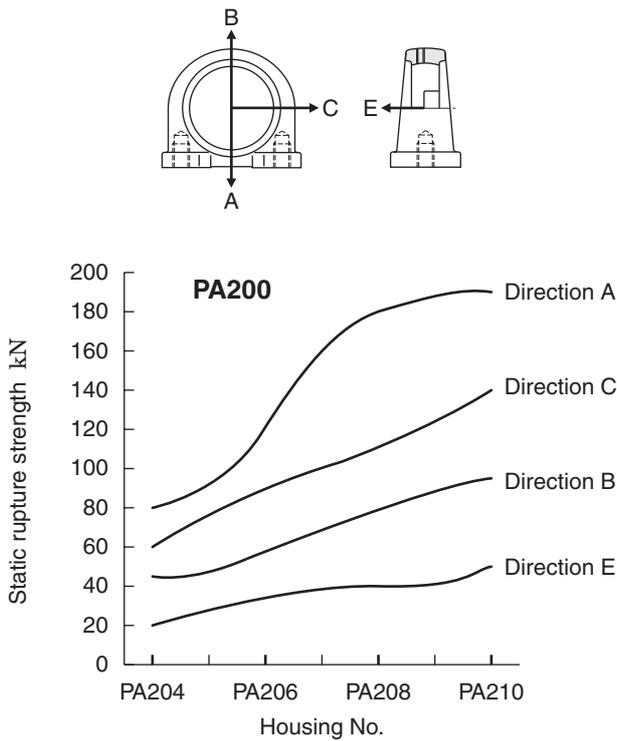

Fig. 8.4 Static rupture strength of tapped base pillow type housings (PA)

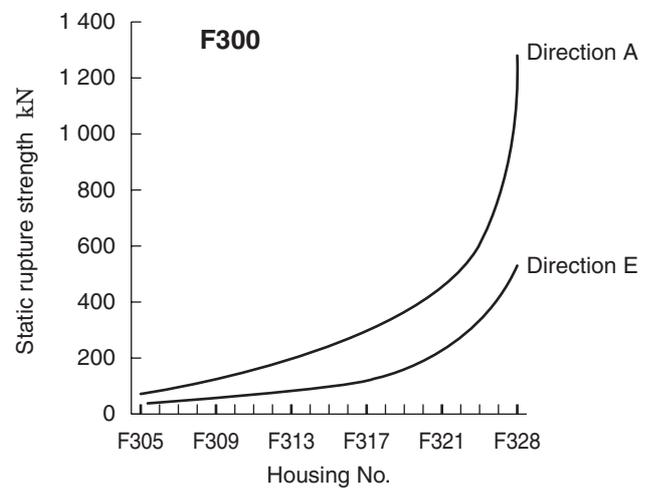
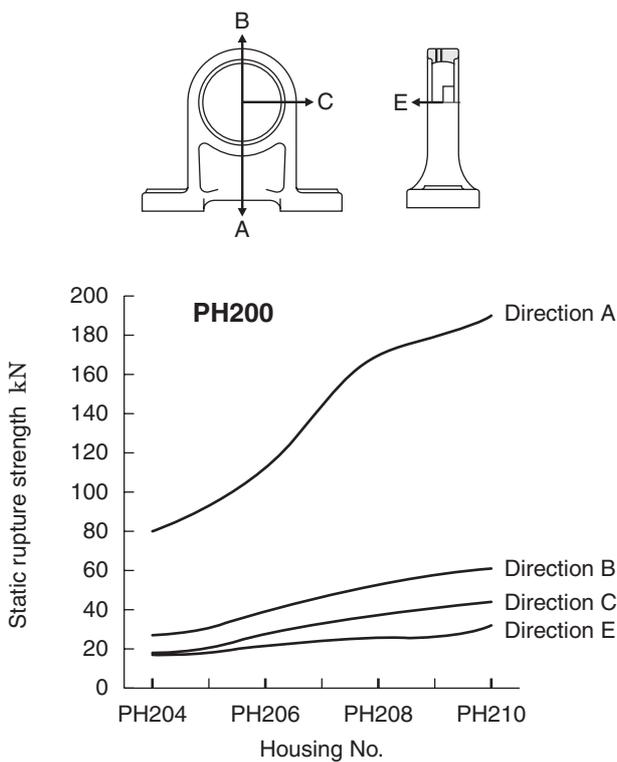
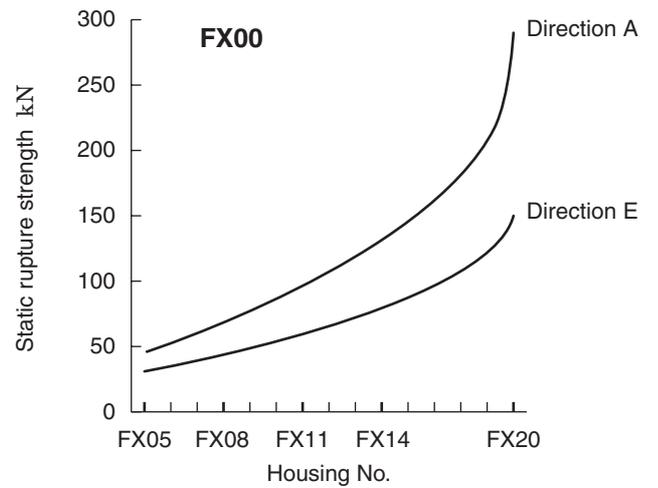

Fig. 8.5 Static rupture strength of higher center height pillow type housings (PH)

Fig. 8.6 Static rupture strength of square flange type housings (F)

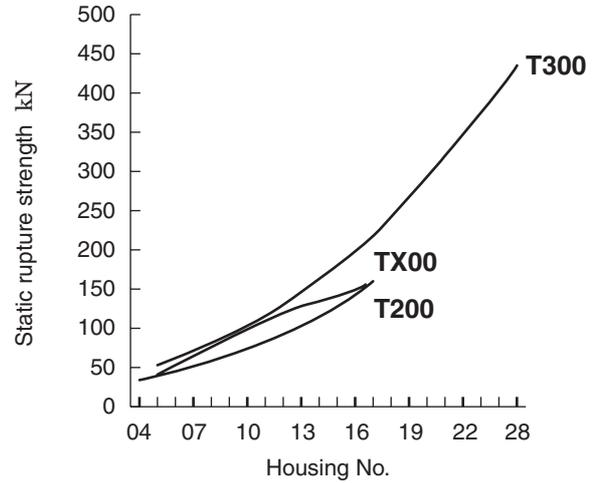
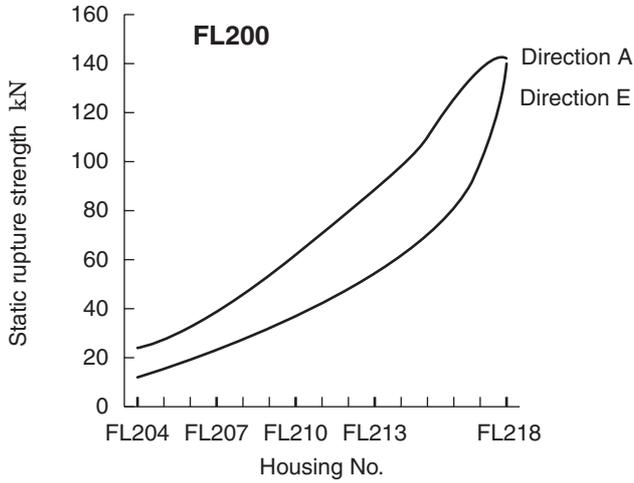
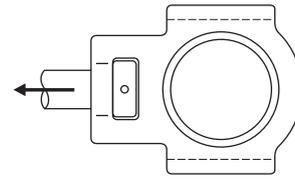
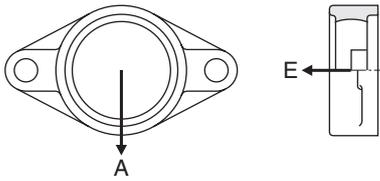

Fig. 8.8 Static rupture strength of take-up type housings (T)

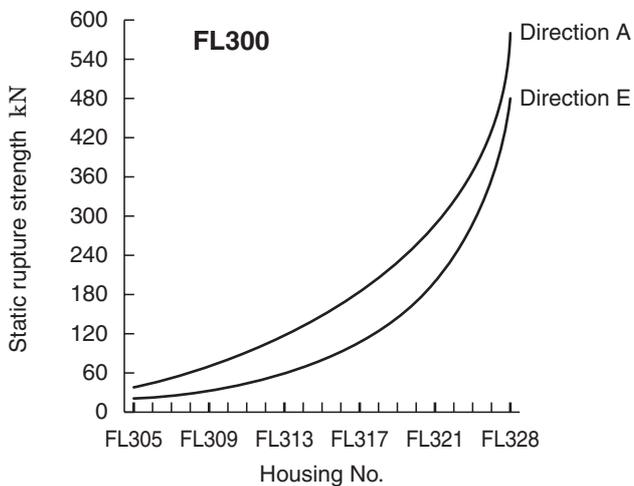
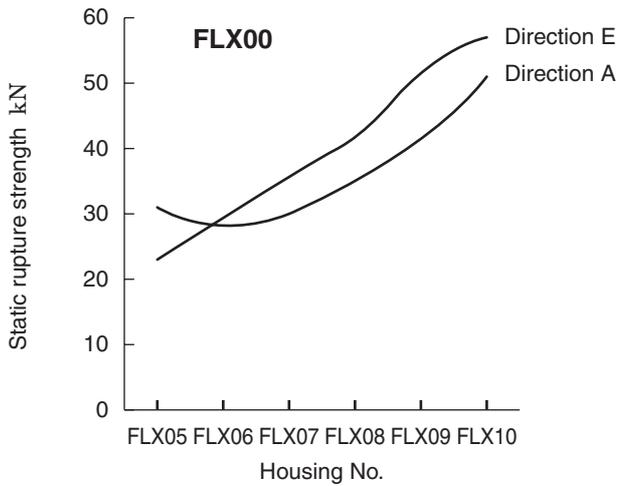

Fig. 8.7 Static rupture strength of oval flange type housings (FL)

8.2 Strength of cast steel housings

Cast steel housings should be selected where high rupture strength and superior impact resistance are required.

FYH manufactures a cast steel pillow block housing (P200sc, P300sc) series.

To determine the allowable load of a cast steel housing, find the static rupture strength of a steel housing from Fig. 8.2 and apply the safety factors for steel shown in Table 8.2.

Table 8.2 Safety factor of cast steel products (recommended)

Property of load	Safety factor of cast steel product
Static load	3
With vibration	5
With impact	10

8.3 Strength of stamped steel housings

The precisely formed stamped steel housing is very rigid, but it is not as strong as cast iron or cast steel housings. Therefore, it will not support loads to the maximum rating of the bearing itself and must be down rated per Table 8.3.

Table 8.3 Allowable load of steel plate housings (recommended)

Load direction	Allowable load of steel plate housings
Radial	Approx. 1/6 of basic dynamic radial load rating of bearing (C_r)
Axial	Approx. 1/18 of basic dynamic radial load rating of bearing (C_r)

8.4 Strength of stainless steel housings

FYH supplies stainless steel housings (SP-H1, SPA-H1, SF-H1, SFL-H1, ST-H1, SP, SFL).

Table 8.4 shows the safety factors for stainless steel products. As for the basic values of the static rupture strength of SP-H1, SPA-H1, SF-H1, SFL-H1, ST-H1 type housings, apply P200 of Fig. 8.1, PA200 of Fig. 8.4, F200 of Fig. 8.6, FL200 of Fig. 8.7 and T200 of Fig. 8.8. For the basic values of the static rupture strength of the SP and SFL type housings, see P000 of Fig. 8.9 and FL000 of Fig. 8.10 and multiply them by 1.5 respectively.

Table 8.4 Safety factor of stainless steel products

Property of load	Safety factor of stainless steel products
Static load	3
With vibration	5
With impact	10

8.5 Strength of die-cast housings

The clean series housing is made of die-cast zinc alloy, but the zinc alloy material is not as strong as cast iron or cast steel. Table 8.5 shows safety factors for die-cast zinc alloy, and Fig. 8.9 and 8.10 show the basic values of the static rupture strength of the die-cast zinc alloy housing.

Table 8.5 Safety factor of zinc alloy die-cast products

Property of load	Safety factor of die-cast products
Static load	8
With vibration	15
With impact	20

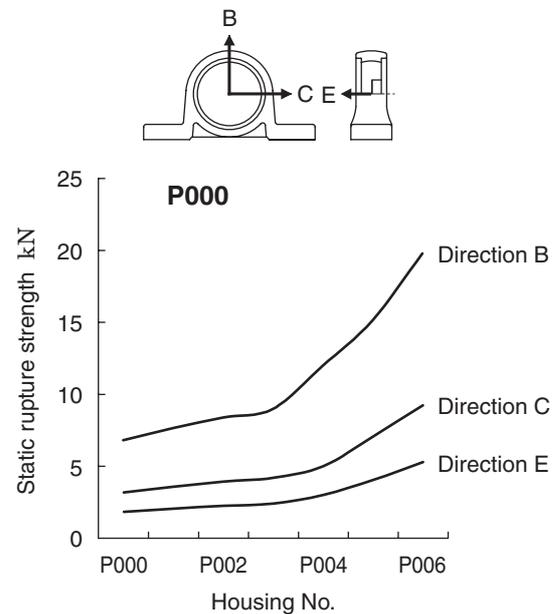

Fig. 8.9 Static rupture strength of clean housings (P)

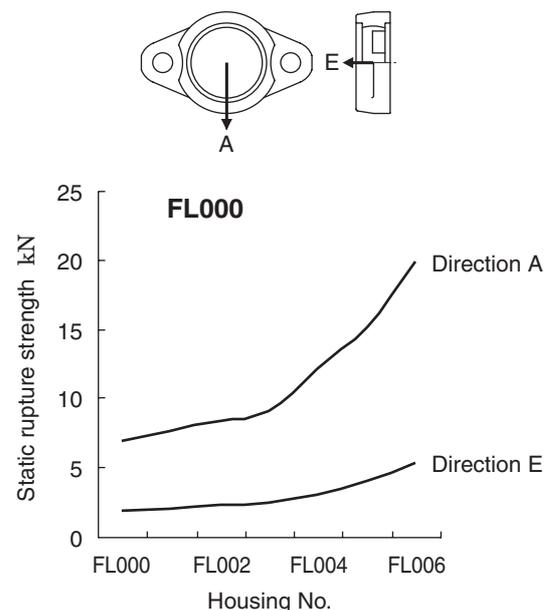

Fig. 8.10 Static rupture strength of clean housings (FL)

9 Design of shaft and base

9.1 Design of shaft

For optimal performance of a ball bearing unit and for maintenance free operation for a long time, the selection of the shaft is very important. The shaft should be of sufficient tensile strength, straight, scratch-free and no burrs should be left.

9.1.1 Dimensional accuracy of shaft

(1) Dimensional tolerance of shaft used for set screw bearings

For bearings with set screws, a relatively looser class of fit makes assembly easier and is perfectly acceptable

at low operating speeds. The clearance fit between the i.d. of the bearing inner ring and the shaft must be decreased as the rotational speed is increased.

Table 9.1 shows the guidelines for the tolerance class for the rotational speed of the bearing with set screws.

If the bearing with set screws is exposed to a heavy load ($P_r/C_r > 0.12$), vibration or heavy impact, use a tighter shaft tolerance than normal.

Table 9.2 shows the tolerances for tight fits.

Table 9.3 shows the recommended roundness and cylindricity of the shaft used.

Table 9.1 Dimensional tolerance of shaft used for cylindrical bore bearing with set screws (recommended) (clearance fitting or intermediate fitting)

Unit : μm

Shaft dia. (mm)		Dimensional tolerance of shaft							
		j6		h6		h7		h8	
Over	Incl.	Max.	Min.	Max.	Min.	Max.	Min.	Max.	Min.
6	10	+ 7	- 2	0	- 9	0	-15	0	-22
10	18	+ 8	- 3	0	-11	0	-18	0	-27
18	30	+ 9	- 4	0	-13	0	-21	0	-33
30	50	+11	- 5	0	-16	0	-25	0	-39
50	80	+12	- 7	0	-19	0	-30	0	-46
80	120	+13	- 9	0	-22	0	-35	0	-54
120	180	+14	-11	0	-25	0	-40	0	-63
Applicable rotating speed dn^1		Over 120 000		Over 100 000, incl. 120 000		Over 60 000, incl. 100 000		Incl. 60 000	

Note ¹ $dn = d$ (bearing bore dia., mm) $\times n$ (rotating speed, min^{-1})

Table 9.2 Dimensional tolerance of shaft used for cylindrical bore bearing with set screws (recommended) (intermediate fitting or tight fitting)

Unit : μm

Shaft dia. (mm)		Dimensional tolerance of shaft					
		k6		k7		m6	
Over	Incl.	Max.	Min.	Max.	Min.	Max.	Min.
6	10	+10	+1	+16	+1	+15	+ 6
10	18	+12	+1	+19	+1	+18	+ 7
18	30	+15	+2	+23	+2	+21	+ 8
30	50	+18	+2	+27	+2	+25	+ 9
50	80	+21	+2	+32	+2	+30	+11
80	120	+25	+3	+38	+3	+35	+13
120	180	+28	+3	+43	+3	+40	+15

Table 9.3 Recommended accuracy of shaft used for ball bearing units

Unit : μm

Shaft dia. (mm)		Tolerance of shaft roundness and cylindricity (max.)
Over	Incl.	
6	10	6
10	18	8
18	30	9
30	50	11
50	80	13
80	120	15
120	180	18

(2) Dimensional tolerances of shafts for blowers (used with set screw bearings)

In bearings used in blowers (special code : S5), machining accuracy of the internal bearing clearance (C2) is required to reduce vibration and noise during operation.

Therefore, the shaft tolerance classes shown in **Table 9.4** are recommended for bearings with set screws.

Table 9.4 Dimensional tolerance of shaft used for bearings (set screw type) for blowers

Unit : μm

Shaft dia. (mm)		Dimensional tolerance of shaft			
		h5		j5	
Over	Incl.	Max.	Min.	Max.	Min.
10	18	0	- 8	+5	- 3
18	30	0	- 9	+5	- 4
30	50	0	-11	+6	- 5
50	80	0	-13	+6	- 7
80	120	0	-15	+6	- 9
120	180	0	-18	+7	-11

(3) Dimensional tolerance of shaft used with tapered bore bearings

Since tapered bore bearings are fixed to the shaft with an adapter, a looser fit is allowable since the adapter provides excellent concentricity. This makes mounting of the bearing to the shaft much easier.

Table 9.5 shows the dimensional tolerance of the shaft used with tapered bore bearings (with adapters).

Table 9.5 Dimensional tolerance of shaft used for tapered bore bearings (with adapters) (recommended)

Unit : μm

Shaft dia. (mm)		Dimensional tolerance of shaft			
		h8		h9	
Over	Incl.	Max.	Min.	Max.	Min.
18	30	0	-33	0	- 52
30	50	0	-39	0	- 62
50	80	0	-46	0	- 74
80	120	0	-54	0	- 87
120	180	0	-63	0	-100

(4) Dimensional tolerance of shaft with eccentric locking collar

Eccentric lock bearings have a greater clearance (more eccentricity) between the shaft and the inner ring of the bearing when installed. Therefore the shaft tolerances must be tighter (h5 or j5) to reduce the clearance (eccentricity). Therefore the same clearance fits are recommended as with blower bearings, **Table. 9.4**.

9.1.2 Dimensions of shouldered shafts

When using a set screw or eccentric lock bearing which is exposed to a high axial load, excessive vibration or impact, a shouldered shaft may be used. The inner ring of the bearing is then tightened in place with a nut, if the shaft is threaded or with a locking ring otherwise.

Table 9.6 shows the shoulder diameter and the fillet radius of the shouldered shaft.

Table 9.6 Recommended shoulder diameter and fillet radius of a shouldered shaft

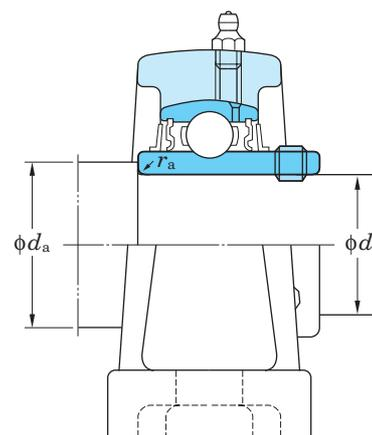

Unit : mm

Bore dia. code	Nominal bearing bore dia. d	UC200, UCX00		UC300	
		Shoulder dia. d_a	Fillet roundness radius r_a (max.)	Shoulder dia. d_a	Fillet roundness radius r_a (max.)
01	12	17	0.6		
02	15	20	0.6		
03	17	22	0.6		
04	20	30	1	-	-
05	25	35	1	35	1
06	30	40	1	40	1
07	35	45	1	45	1.5
08	40	50	1	50	1.5
09	45	55	1	55	1.5
10	50	60	1	60	2
11	55	65	1.5	65	2
12	60	70	1.5	75	2
13	65	75	1.5	80	2
14	70	80	1.5	85	2
15	75	85	1.5	90	2
16	80	90	2	95	2
17	85	95	2	100	2.5
18	90	100	2	105	2.5
19	95	-	-	110	2.5
20	100	-	-	115	2.5
21	105	-	-	120	2.5
22	110			125	2.5
24	120			135	2.5
26	130			150	3
28	140			160	3

9.1.3 High temperature applications

In general, two or more bearing units are used per shaft. If the distance between the bearings is small, or if the temperature change of the shaft is small, the both bearings may be fixed in position.

However, if the distance between the bearings is large and the shaft is exposed to heat, then only one bearing should be fixed and the opposing bearing must be free to float in the axial direction.

This is because shaft expansion due to temperature change of the shaft causes a high axial load and failure of fixed bearings. The amount of shaft expansion due to temperature change may be calculated by **Formula (9.1)**.

$$\Delta l = \alpha \cdot \Delta t \cdot l \dots\dots\dots (9.1)$$

Whereas,

- Δl : Expansion of shaft, mm
- α : Linear expansion coefficient of shaft
in the case of ordinary steel, $11\sim 12 \times 10^{-6}$
- Δt : Temperature increase, °C
- l : Installation distance of unit, mm

Proper installation procedures for a shaft exposed to temperature changes are shown below.

(1) Installation with a dog point set screw on the free side

To accommodate expansion in the axial direction, the bearing must be installed so that the shaft can move freely in the axial direction.

To accomplish this, the shaft must be grooved for full dog point set screw (special code : G6). This is on the free side only. The dog point screw allows free movement in the axial direction and provides force to rotate the bearing in the radial direction.

Fig. 9.1 shows an example of the structure of a bearing with a key groove on the shaft and a full dog point set screw. **Table 9.7** shows the dimensions of the key groove for the full dog point set screw.

The tolerance class of the shaft to be used is h7.

If the temperature of the shaft is higher than that of the bearing, then a looser fit tolerance class is specified.

When using this method to allow for free expansion, there is the possibility of fretting corrosion between the shaft and the inner race. In order to prevent fretting corrosion, a high temperature grease must be applied to the inner ring of the bearing and the shaft prior to installation.

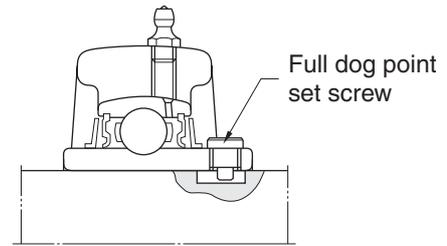
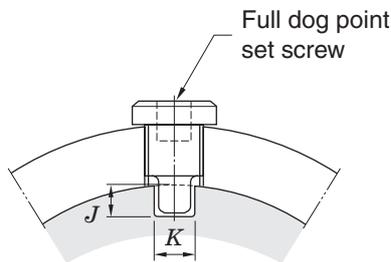

Fig. 9.1 Use on free side with full dog point set screw

Table 9.7 Dimensions of key groove for full dog point set screw (use on free side)

Nominal size of set screw	Dimensions of key groove (mm)		Applicable nominal bearing code		
	J	K (Min.)	UC200	UCX00	UC300
M6 × 0.75	5	4	201-206	X05	305, 306
M8 × 1	6	6	207-209	X06-X08	307
M10 × 1.25	6.5	7	210-212	X09-X11	308, 309
M12 × 1.5	7	9	213-218	X12-X17	310-314
M14 × 1.5	7	10		X18	315, 316
M16 × 1.5	8	12		X20	317-319
M18 × 1.5	8	13			320-324
M20 × 1.5	8	15			326, 328



Allowable tolerance of key groove dimension "K" (Recommended value : 0~+0.2)

(2) Installation of cartridge type units on the free side

If the rotational speed is high or the bearing is exposed to high vibration, the cartridge type unit is recommended on the free side. In this case the housing of the cartridge unit is free to move and the bearing insert is rigidly attached to the shaft.

Fig. 9.2 shows the required structure for the cartridge type unit on the free side.

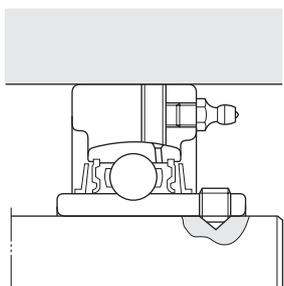

Fig. 9.2 Use of cartridge type units on free side

If, in addition to the expansion of the shaft, the ball bearing itself is exposed to heat, then a calculation of the decrease in internal clearances of the bearing must be made. The appropriate bearing internal clearance must be specified. (see “7 Operating temperature and bearing specifications”).

9.2 Mounting base design

9.2.1 Rigidity of base and flatness of mounting surface

If rigidity of the base on which a ball bearing unit is to be mounted is not sufficient or the flatness of the mounting surface is poor, then vibration or abnormal noise may occur to the bearing during operation. This will lead to failure since the strength of the housing is less since it is not properly supported.

The base must be properly machined accurately to eliminate deformation of the housing.

Fig. 9.3 shows the recommended values for flatness of the mounting surface on which the ball bearing unit is to be installed.

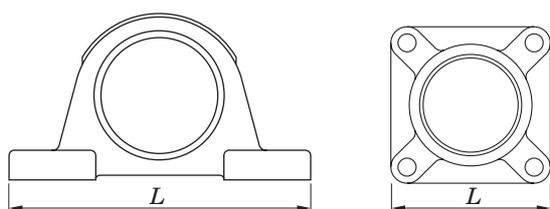

Max. : $L / 1\,000$ mm

Fig. 9.3 Flatness of mounting surface of base (recommended value)

9.2.2 Mounting cartridge type units in high temperature applications

Cartridge units are designed to fit into an accurately bored cylindrical opening in the mounting base. Under ordinary operating conditions, H7 is an adequate choice for the tolerance class of the cylindrically bored hole.

In instances in which both the bearing and the shaft are hot, select G7 as the tolerance class of the cylindrical bore.

If the bearing is exposed to excessive vibration or impact, then an even tighter tolerance class must be specified.

Table 9.8 shows the dimensional requirements for the cylindrical bore.

Table 9.8 Dimensional tolerance of cylindrical bore for mounting cartridge type units (recommended values)

Unit : μm

Nominal bore dia. of cylindrical bore (mm)		Dimensional tolerance of cylindrical bore			
		H7		G7	
Over	Incl.	Max.	Min.	Max.	Min.
50	80	+30	0	+40	+10
80	120	+35	0	+47	+12
120	180	+40	0	+54	+14
180	250	+46	0	+61	+15
250	315	+52	0	+69	+17
315	400	+57	0	+75	+18

9.2.3 Installation of take-up units

A take-up unit is positioned between two guide rails and enables linear adjustment by means of the threaded rod and bolt.

Table 9.9 shows the dimensions of the guide rail, adjuster bolt, and the round nut.

Table 9.9 Dimensions relative to installation of take-up type units (recommended values)

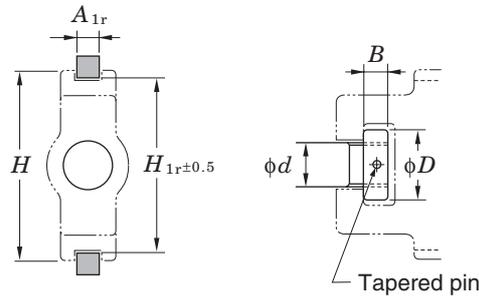

Unit : mm

Nominal bearing code	Dimensions of guide rail			Dimensions of adjuster bolt and round nut		
	A_{1r}	H_{1r}	H (Reference)	d	D	B
T204 T205	11	77	89	16	28	14
T206 T207	11	90	102	18	32	14
T208	15	103	114	24	42	16
T209 T210	15	103	117	24	42	16
T211 T212	20	131	146	30	55	20 27
T213 T214 T215	24	152	167	36	60	27
T216	24	166	184	36	60	27
T217	28	174	198	42	60	30
TX05 TX06	11	90	102	18	32	14
TX07	15	103	114	24	42	16
TX08 TX09	15	103	117	24	42	16
TX10 TX11	20	131	146	30	55	20 27
TX12 TX13 TX14	24	152	167	36	60	27
TX15	26	166	184	36	60	27
TX16 TX17	26	174	198	42	60	30

Remark This table is applicable to the dimensions relative to the stainless steel housing.

Unit : mm

Nominal bearing code	Dimensions of guide rail			Dimensions of adjuster bolt and round nut		
	A_{1r}	H_{1r}	H (Reference)	d	D	B
T305	11	81	89	22	32	12
T306 T307	15	91 101	100 111	24 26	36 40	14
T308 T309	16	113 126	124 138	28 30	45 50	16 18
T310	18	141	151	32	55	20
T311 T312	20	151 161	163 178	34 36	60 65	22 24
T313 T314 T315	24	171 181 193	190 202 216	38 40 40	65 80 80	26 28 28
T316	28	205	230	46	90	34
T317 T318	30	216 230	240 255	46 50	90 95	34 38
T319	32	242	270	50	95	38
T320 T321	32	262	290	52	100	40
T322	36	287	320	55	110	44
T324	42	322	355	60	120	50
T326 T328	47	352 382	385 415	65 70	130 140	55 60

9.3 Machining of pin hole for locating housings

The pillow type, square flange type, and oval flange type housing have the dowel pin seat. If accurate positioning of the housing is required, install it with the dowel pin.

As for the position of the pin for locate the housing and pin diameter, see the **Appendix table 5** at the end of this catalogue.

10 Nomenclature

Nomenclature of FYH Ball Bearing Units conform to JIS B 1557, and comprise the bearing unit model code (comprising bearing model code and housing model code),

diameter series code, bore dia. code, accessory code, and special code.

UC P 207 J L3

Bearing No. :	UC207L3
Housing No. :	P207J

UK P 209 J CD + H309X

Bearing No. :	UK209+H309X
Housing No. :	P209JE1
Steel plate cover No. :	(Open type) C-9x40 (Closed type) D-9

UC F 209 J L3 FD D1K2 G6 A1

Bearing No. :	UC209L3D1K2G6
Housing No. :	F209JA1E3
Cast iron cover No. :	(Closed type) 209FD

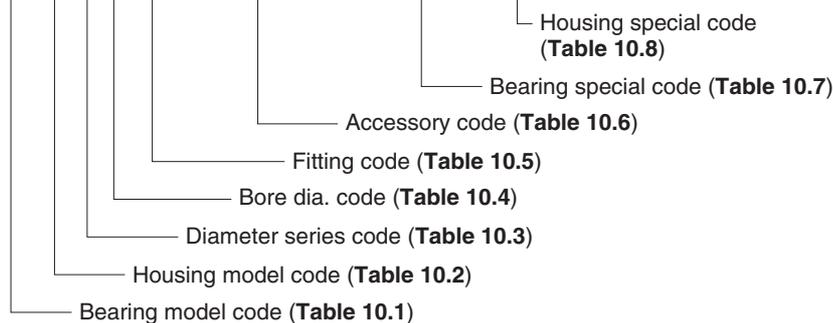

Remark The above code shows an example of Nomenclature structure. It may depend on the bearing unit model.

Table 10.1 Bearing model code

Bearing model code	Details
UC	Cylindrical bore, with set screws
UC-S6	Cylindrical bore, with set screws (stainless steel series)
UK	Tapered bore (for adapter)
NA	Cylindrical bore, with eccentric locking collar
SB	Cylindrical bore, with set screws (lightweight type)
SU	Cylindrical bore, with set screws (clean series)
SU-S6	Cylindrical bore, with set screws (stainless steel series)
ER	Cylindrical bore, with set screws, cylindrical outer diameter, Lubricating mechanism
RB	Cylindrical bore, with set screws, cylindrical outer diameter

Table 10.2 Housing model code (continued)

Housing model code	Details
SP	Pillow type (stainless steel series)
PP	Cast steel pillow type
F	Square four-bolt flange type
FL	Oval two-bolt flange type
FA	Adjustable oval two-bolt flange type
FB	Three-bolt flange type
FC	Round flange cartridge type
FS	Square four-bolt cartridge flange type
FL	Oval two-bolt flange type (clean series)
SF-H1	Square four-bolt flange type (stainless steel series)
SFL-H1	Oval two-bolt flange type (stainless steel series)
SFL	Oval two-bolt flange type (stainless steel series)
PF	Stamped steel plate round three-bolt flange type
PFL	Stamped steel plate oval two-bolt flange type
T	Take-up type
ST-H1	Take-up type (stainless steel series)
TH	Section steel frame take-up type
TL	Light channel steel frame take-up type
TU	Channel steel frame take-up type
PTH	Steel plate frame take-up type
NPTH	Steel plate frame take-up type
C	Cartridge type
HA	Hanger type

Table 10.2 Housing model code

Housing model code	Details
P	Pillow type
P-SC	Cast steel pillow type
IP	Thick pillow type
PA	Tapped-base pillow
PH	High centerheight pillow type
LP	Lightweight pillow type
P	Pillow type (clean series)
SP-H1	Pillow type (stainless steel series)
SPA-H1	Tapped-base pillow (stainless steel series)

Table 10.3 Diameter series code

Diameter series code	Details
2	For light duty
X	For medium duty
3	For heavy duty

Table 10.4 Bore dia. code

Bore dia. code	Details
8	Nominal bearing bore dia. 8 mm
00	Nominal bearing bore dia. 10 mm
01	Nominal bearing bore dia. 12 mm
02	Nominal bearing bore dia. 15 mm
03	Nominal bearing bore dia. 17 mm
04	(Bore dia. code) × 5 = Nominal bearing bore dia. (mm)
or more	
01-8	– (bore dia. code) /16 = nominal bearing bore dia. (inch) (in this case, 8/16 = 1/2 inch = 12.7 mm) As for the bore dia. inch series bearing.

Table 10.5 Fitting code

Fitting code	Details
J	Tolerance class of spherical bore of the housing is J7 (not shown on the bearing that the spherical bore diameter exceeds 120 mm)
H	Tolerance class of spherical bore of the housing is H7
K	Tolerance class of spherical bore of the housing is K7

Table 10.6 Accessory code

Accessory code	Details
C ¹⁾	Cover, open type
D ¹⁾	Cover, closed type
FC	Cast iron cover, open type
FD	Cast iron cover, closed type
L3	Triple lip seal type

Note ¹⁾ Standard specifications of codes C and D are as shown below.
 201–218, X05–X17.....Steel plate cover
 X18–X20, 305–328.....Cast iron cover

Table 10.7 Bearing special code

Item	Bearing special code	Details
Grease	D1	SH44M
	D2	SH33M
	D9	Demnum L-200
Set Screw	G4	Pointed tip
	G6	With full dog point
	G7	With loose prevent nylon
Seal	K2	Silicone rubber
	K3	Non-contact type
Sealing Device	P3	Without seal, slinger
	P4	Without seal
Others	S5	For blower (seal : K3, inner clearance and bearing accuracy are specially controlled)
	S6	Stainless steel bearing

Table 10.8 Housing special code

Item	Housing special code	Details
Grease Nipple Thread Bore dia.	A1	PT1/8 tube thread
	A2	PF1/8 tube thread
	A3	PT1/4 tube thread
	A4	PF1/4 tube thread
Grease Nipple Thread Bore Position	B1	Right
	B2	Left
	B3	45°
	B5	30°
Machining	B7	Both right and left
	E1	Steel plate
	E3	Cast iron cover mounting groove (diameter series 2, X, 3)
Material	E4	Non-lubricating type
	H1	Stainless steel cast steel model (SCS13)
	H5	Rolled steel for general purpose (SS400)
Grease Nipple	SC	Carbon steel cast steel model (SC450)
	N1	B type (67.5°)
	N2	C type (90°)

11 Accuracy and internal clearance

Accuracy of a ball bearing unit is specified in JIS B 1558 (ball bearings for ball bearing units) and JIS B 1559 (housing for ball bearing unit). FYH produces products conforming to these standards.

11.1 Accuracy of bearings

Table 11.1 to Table 11.4 show the accuracy of a ball bearings for ball bearing units.

Ball bearings for blower unit (special code : S5) are produced with higher accuracy than standard models (see Table 11.3).

Table 11.5 shows the tolerance limitations of cylindrical bore bearing inner ring.

Table 11.2 Tolerances and tolerance values of outer rings of ball bearings for ball bearing units

Unit : μm

Nominal bearing outer dia. D (mm)		Variation of tolerance of average outer dia. ΔD_m		Radial runout of outer ring K_{ea}
Over	Incl.	Max.	Min.	Max.
18	30	0	- 9	15
30	50	0	-11	20
50	80	0	-13	25
80	120	0	-15	35
120	150	0	-18	40
150	180	0	-25	45
180	250	0	-30	50
250	315	0	-35	60

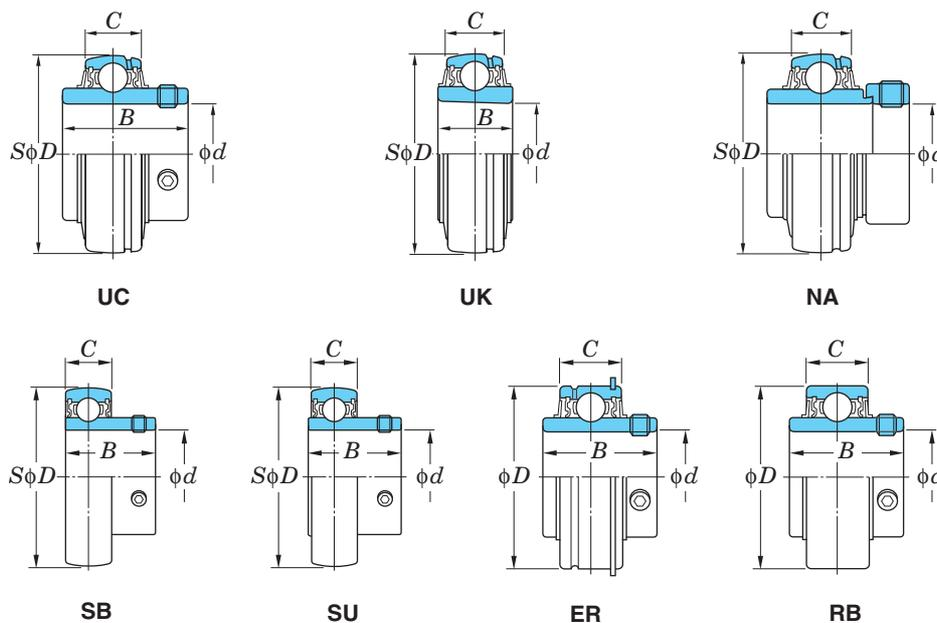

Table 11.1 Tolerances and tolerance values of inner rings of ball bearings for ball bearing units

Unit : μm

Nominal bearing bore dia. d (mm)		Variation of tolerance of average bore dia. in plane Δd_{mp}		Unequal bore dia. in plane V_{dp}	Variation of tolerance of eccentricity on eccentric surface of inner ring and eccentric locking collar ΔH_s		Variation of tolerance of inner ring width ΔB_s		Radial runout of inner ring K_{ia}
Over	Incl.	Max.	Min.	Max.	Max.	Min.	Max.	Min.	Max.
-	10	+15	0	10	+100	-100	0	-120	10
10	18	+15	0	10	+100	-100	0	-120	15
18	31.75	+18	0	12	+100	-100	0	-120	18
31.75	50.8	+21	0	14	+100	-100	0	-120	20
50.8	80	+24	0	16	+100	-100	0	-150	25
80	120	+28	0	19	+100	-100	0	-200	30
120	180	+33	0	22	+100	-100	0	-250	35

11 Accuracy and internal clearance

Table 11.3 Tolerances and tolerance values of inner rings of ball bearing units for blowers (S5)

Unit : μm

Nominal bearing bore dia. d (mm)		Variation of tolerance of average bore dia. in plane Δd_{mp}		Unequal average bore dia. in plane V_{dp}	Radial runout of inner ring K_{ia}
Over	Incl.	Max.	Min.	Max.	Max.
10	18	+13	0	6	7
18	31.75	+13	0	6	8
31.75	50.8	+13	0	10	10
50.8	80	+15	0	10	10
80	120	+18	0	14	13
120	180	+23	0	14	18

Table 11.4 Variation of tolerances and tolerance values of tapered bore on bearing with tapered bore

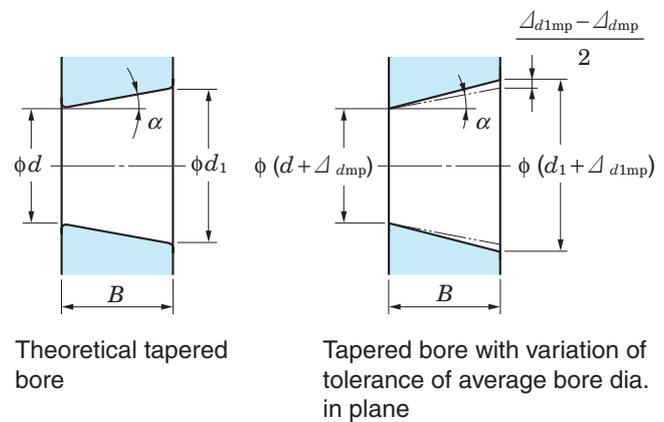

Unit : μm

Nominal bearing bore dia. d , mm		Δd_{mp}		$\Delta d_{1mp} - \Delta d_{mp}$		$V_{dp}^{(1)}$
Over	Incl.	Max.	Min.	Max.	Min.	Max.
18	30	+33	0	+21	0	13
30	50	+39	0	+25	0	16
50	80	+46	0	+30	0	19
80	120	+54	0	+35	0	22
120	180	+63	0	+40	0	40

Note ¹⁾ To be applied to all the radial planes of tapered bore

Remarks 1. Applicable range

Applicable to tapered bore of inner ring of tapered bore radial bearing that standard value of taper ratio is 1/12.

2. Amount code

d_1 : Standard diameter at theoretical large end of tapered bore

$$\text{Standard diameter } d_1 = d + \frac{1}{12} B$$

Δd_{mp} : Variation of tolerance of average bore diameter in plane at theoretical small end of tapered bore

Δd_{1mp} : Variation of tolerance of average bore diameter in plane at theoretical large end of tapered bore

V_{dp} : Unequal bore diameter in plane

B : Nominal inner ring width

α : 1/2 of nominal taper angle of tapered bore

$$\alpha = 2^\circ 23' 9.4''$$

$$= 2.38594^\circ$$

$$= 0.041643 \text{ rad}$$

Table 11.5 Tolerance limitations of chamfered dimensions for the inner ring of cylindrical bore bearings

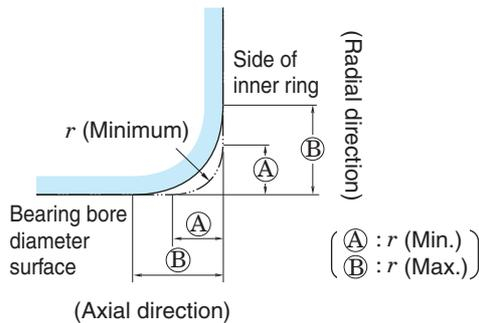

Unit : mm

r (Min.)	r (Max.)	
	Radial direction	Axial direction
0.6	1	2
1	1.5	3
1.1	2	3.5
1.5	2.3	4
2	3	4.5
2.1	4	6.5
2.5	3.8	6
3	5	8
4	6.5	9

Remark Though accurate profile of chamfered surface is not specified, the profile on the axial plane should not exceed the virtual arc of radius r (minimum) that contacts with the side of inner ring and the bearing bore diameter surface.

11.2 Accuracy of housings

This section details the tolerance specifications of the inner diameter of the spherical bore of FYH housings. These values determine how tight or how loose the bearing fits inside the housing.

Table 11.6 shows the tolerance of the diameter of the spherical bore of housings.

Standard tolerance for mounted units, between the outer diameter of the bearing and the inner diameter of the housing, is a class J7 intermediate fit.

A class H7 tolerance allows greater clearance for applications where minor shaft alignment constantly occurs or in environments where higher temperatures can cause thermal expansion. An anti-rotation pin on the outer ring of the bearing is supplied with these units to prevent the outer ring of the bearing from spinning inside the housing.

A class K7 tolerance allows less clearance and is recommended to prevent the outer ring of the bearing from rotating inside the housing.

Fig. 11.1 shows examples of housing dimensions relative to installation position with tolerance values.

Table 11.6 Allowance of spherical bore diameter of housings

Unit : μm

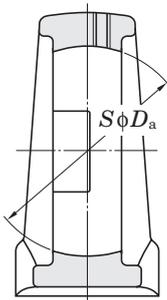

Nominal dia. of spherical bore D_a (mm)		Tolerance class H7		Tolerance class J7		Tolerance class K7	
		Variation of tolerance of spherical bore dia. Δ_{Dam}		Variation of tolerance of spherical bore dia. Δ_{Dam}		Variation of tolerance of spherical bore dia. Δ_{Dam}	
Over	Incl.	Max.	Min.	Max.	Min.	Max.	Min.
18	30	+21	0	+12	- 9	+ 6	-15
30	50	+25	0	+14	-11	+ 7	-18
50	80	+30	0	+18	-12	+ 9	-21
80	120	+35	0	+22	-13	+10	-25
120	180	+40	0	+26	-14	+12	-28
180	250	+46	0	+30	-16	+13	-33
250	315	+52	0	+36	-16	+16	-36

Remark FYH selects J or H, K depending on the applications.

Fig. 11.1 Dimensions relative to installation of housings with tolerances and tolerance values (representative example)

Pillow type housings

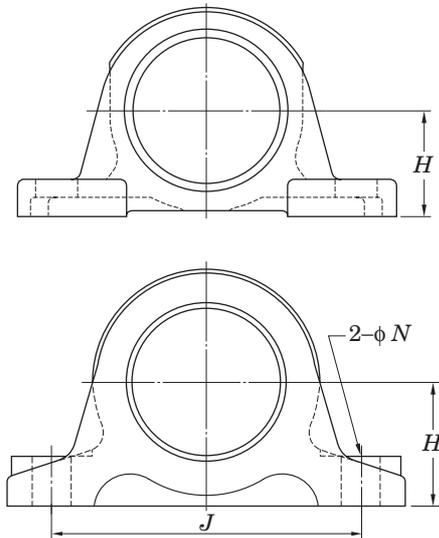

Take-up type housings

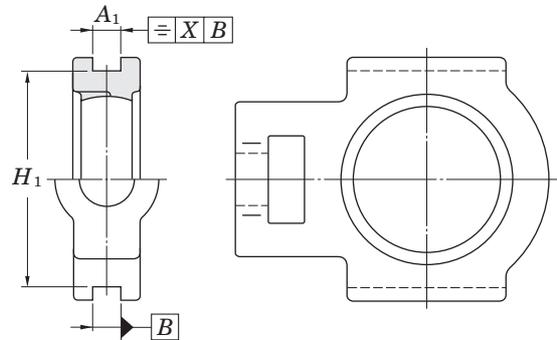

Frame for take-up type units

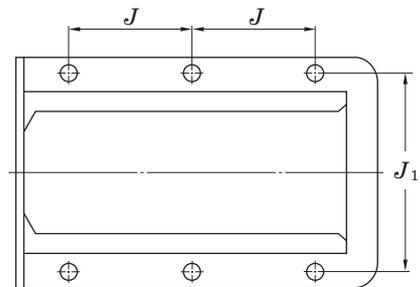

Flange type housings

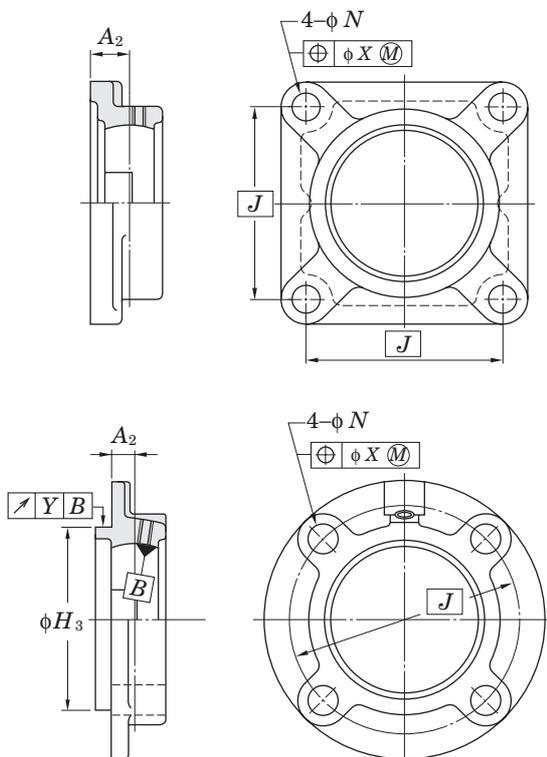

Cartridge type housings

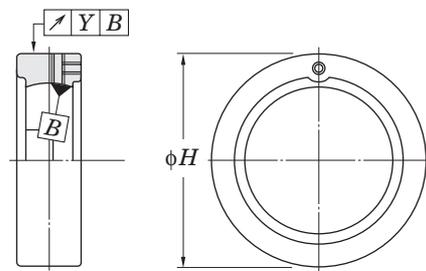

Table 11.7 shows ordinary dimensional tolerance of cut or cast portions not specified in this catalog.

Table 11.7 Ordinary dimensional tolerance not specified respectively

Item	Standard code	Class
Cutting	JIS B 0405	Medium
Casting of cast iron	JIS B 0403	Ordinary
Casting of cast steel	JIS B 0403	Ordinary

Remark Respective tolerances and tolerance values for housing are shown in dimensional tables.

11.3 Internal bearing clearance

Internal bearing clearance is defined as the allowable space between the bearing balls and the raceways. The degree of internal clearance, referred to as “operation clearance”, greatly influences operational life of the bearing as well as characteristics of heat, noise, and vibration.

If the clearance is exceptionally tight between the shaft and the inner ring of the bearing then expansion of the inner ring must be taken into consideration and the correct ball clearance should be selected. Transmission heat from the shaft is also a factor to consider when determining the correct amount of ball clearance (see “7 Operating temperature and bearing specifications”).

Table 11.8 shows the internal clearance applicable to specific operating conditions and Table 11.9 shows the available options of internal clearance.

Table 11.8 Internal clearance applicable to specific operating conditions

Type	Applicable internal clearance	
	Bearing with cylindrical bore	Bearing with tapered bore
Standard type	CN	C3
Stainless steel type	C3	–
Heat resistant type (special code : D1K2)	C4	C5
Heat resistant type (special code : D9K2)	C4	C5
Cold resistant type (special code : D2K2)	CN	C3
High speed type (special code : K3)	CN	C3
For blower (special code : S5)	C2	C3

Remark For bearings with special codes, as those indicated above, the clearance is implied and not indicated in the part number.

Table 11.9 Available options for internal clearance

Unit : μm

Nominal bearing bore dia. d (mm)		Internal clearance											
		C2		CN		GN		C3		C4		C5	
Over	Incl.	Min.	Max.	Min.	Max.	Min.	Max.	Min.	Max.	Min.	Max.	Min.	Max.
6	10	0	7	2	13	–	–	8	23	14	29	20	37
10	18	0	9	3	18	10	25	11	25	18	33	25	45
18	24	0	10	5	20	12	28	13	28	20	36	28	48
24	30	1	11	5	20	12	28	13	28	23	41	30	53
30	40	1	11	6	20	13	33	15	33	28	46	40	64
40	50	1	11	6	23	14	36	18	36	30	51	45	73
50	65	1	15	8	28	18	43	23	43	38	61	55	90
65	80	1	15	10	30	20	51	25	51	46	71	65	105
80	100	1	18	12	36	24	58	30	58	53	84	75	120
100	120	2	20	15	41	28	66	36	66	61	97	90	140
120	140	2	23	18	48	33	81	41	81	71	114	105	160

Remarks 1. Radial internal clearance in this table conforms to JIS B 1558 (ball bearing inserts).

2. Increase in radial internal clearance generated by measured load conforms to the table below. Smaller correction of C2 clearance is applicable to the minimum clearance, while larger correction is applicable to the maximum clearance.

Unit : μm

Nominal bearing bore dia. d (mm)		Measured load	Correction of clearance				
Over	Incl.		N	C2	CN	GN, C3	C4
2.5	18	24.5	3 – 4	4		4	
18	50	49	4 – 5	5		6	
50	280	147	6 – 8	8		9	

12 Materials

12.1 Bearing material

Ball bearing inserts are comprised of inner and outer rings, balls, and riveted ball cages all of which is made of the highest quality of bearing steel.

These bearings possess the following features.

- (1) High elastic limit to resist strong opposing force
- (2) High rolling fatigue strength to allow for heavy loads
- (3) Superior hardness
- (4) Superior wear resistance
- (5) Superior toughness against impact and shock loads
- (6) Superior stability of dimensional tolerances

High carbon chrome bearing steel specified in JIS (Japanese Industrial Standards) for the bearing components are utilized.

To increase reliability and reduce contamination within the material, a vacuum degassing process is executed to reduce non-metallic elements and any oxygen in the steel. After the bearing is assembled it is heat tempered and quenched until the hardness reaches 60HRC.

Table 12.1 shows the chemical components of high carbon chrome bearing steel. Stainless steel bearing inserts (suffix : S6) utilize superior corrosion resistant JIS certified stainless steel.

Riveted steel ball cages are made of JIS certified cold-rolled steel and steel strip which is shown in **Table 12.2**.

12.2 Housing material

Housings are mainly made of gray cast iron, cast carbon steel, and stamped steel. Gray cast iron is the most popular choice for mounted units because of its optimal characteristics of vibration absorption, high strength, and excellent heat dissipation.

Table 12.3 shows the mechanical properties of gray cast iron.

Nodular graphite cast iron (FCD450-10 of JIS G 5502) may be used in addition to these materials.

If superior strength is required for the housings for ball bearing units, select carbon steel cast steel products with higher rupture strength, carbon steel cast steel, or general structural rolled steel with higher strength against impact.

For the material of housings of the clean series unit, zinc alloy die-cast is used, and stainless steel cast steel products are used for housings of the stainless series unit. Cold rolled sheet steels and steel strips are used as the material of housings for the steel plate unit.

Table 12.4 to **12.8** show the mechanical properties of these housing materials.

Nodular graphite cast iron (FCD450-10 of JIS G 5502) may be used, as well as these materials.

Table 12.1 Chemical components of high carbon chrome bearing steel (JIS G 4805)

Code	Chemical components (%)						
	C	Si	Mn	P	S	Cr	Mo
SUJ 2	0.95– 1.10	0.15– 0.35	0.50 or less	0.025 or less	0.025 or less	1.30– 1.60	0.08 or less

Table 12.2 Chemical components of cold rolled steel and steel strip (SPCC) (JIS G 3141)

Code	Chemical components (%)						
	C	Si	Mn	P	S	Ni	Cr
SPCC	0.12 or less	–	0.50 or less	0.040 or less	0.045 or less	–	–

Table 12.3 Mechanical properties of gray cast iron (FC200)

Type code	Tensile strength N/mm ²	Hardness HB
FC200	200 or more	223 or less

Table 12.4 Mechanical properties of carbon steel cast steel products (SC450)

Type code	Yielding point or bearing force N/mm ²	Tensile strength N/mm ²	Extension %	Construc- tion %
SC450	225 or more	450 or more	19 or more	30 or more

Table 12.5 Mechanical properties of carbon steel cast steel products (JIS G 3101)

Type code	Yielding point or bearing force N/mm ²			Tensile strength N/mm ²	Thickness of steel mm	Tensile test piece	Extension %	Bending property		
	Thickness of steel mm							Bending angle	Inside dia.	Test piece
	incl. 16	Over 16 incl. 40	Over 40							
SS400	245 or more	235 or more	215 or more	400– 510	Over 5, 16 max.	No.1A	17 or more	180°	1.5 times of thickness	No.1
					Over 16, 40 max.	No.1A	21 or more			
					Over 40	No.4	23 or more			

Table 12.6 Mechanical properties of zinc alloy die-cast (ZDC02) (JIS H 5301) (Reference)

Code	Tensile strength N/mm ²	Extension %	Impact N · m/cm ²	Hardness HB
ZDC2	285	10	140	82

Table 12.7 Mechanical properties of stainless cast steel products (SCS13) (JIS G 5121)

Type code	Bearing force N/mm ²	Tensile strength N/mm ²	Extension %	Hardness HB
SCS13	185 or more	440 or more	30 or more	183 or more

Table 12.8 Mechanical properties of cold rolled sheet steel and steel strip (SPCC) (JIS G 3141)

Type code	Tensile strength N/mm ²	Extension %
SPCC	270 or more	34 or more

12.3 Materials of parts and accessories

Table 12.9 shows materials of parts and accessories of a ball bearing unit.

Table 12.9 Materials of parts and accessories of ball bearing units

Designations	Materials	Code	Standard code
Seal (standard type)	Nitrile rubber	NBR	–
Seal (heat resistant, cold resistant)	Silicone rubber	VMQ	–
Slinger (flinger)	Cold rolled steel plate and steel strip	SPCC	JIS G 3141
Stainless steel slinger (flinger)	Cold rolled stainless steel plate and steel strip	SUS304-CP, SUS304-CS	JIS G 4305
Steel plate cover	Cold rolled steel plate and steel strip	SPCD	JIS G 3141
Stainless steel plate cover	Cold rolled stainless steel plate and steel strip	SUS304-CP, SUS304-CS	JIS G 4305
Cast iron cover	Gray cast iron products	FC200	JIS G 5501
Hexagon socket set screw	Chrome molybdenum steel	SCM435	JIS G 4105
Stainless steel hexagon socket set screw	Stainless bar steel	SUS410	JIS G 4303
Adapter sleeve for bearing	Mechanical structural carbon steel	S25C	JIS G 4051
Lock nut for bearing	Mechanical structural carbon steel	S25C	JIS G 4051
Washer for bearing	Cold rolled stainless steel plate and steel strip	SPCC	JIS G 3141
Eccentric locking collar	Mechanical structural carbon steel	S20C	JIS G 4051
Grease nipple	Copper and copper alloy rod	C3604 SUM24L	JIS H 3250 JIS G 4804

13 Performance

13.1 Bearing friction torque

Bearing friction torque is the synthesis of rolling friction between the balls, inner and outer rings, sliding friction between the balls and the cages, agitating resistance of lubricants, and friction resistance of the seal.

The specific amount of friction torque is influenced by the particular bearing model, dimensions, bearing load, rotating speed, and lubricating conditions.

Bearings with triple-lip seals and open cover seals will have a greater friction torque and overall greater friction resistance.

Friction torque for bearings can be found by the formulas below.

$$M = M_p + M_k \quad (13.1)$$

$$M_p = \mu \cdot P \cdot \frac{d}{2} \quad (13.2)$$

Whereas,

M : Friction torque of bearing, $mN \cdot m$

M_p : Friction torque of sections changed by load, $mN \cdot m$

M_k : Friction torque of sections changed by rotating speed, $mN \cdot m$

μ : Friction coefficient (0.001 5 to 0.002)

P : Load applied to bearings, N

d : Nominal bearing bore dia., mm

Note that the agitating resistance of lubricants and the friction resistance of the seals are difficult to calculate since the resistance fluctuates with speed.

Fig. 13.1 shows the result of measurement of friction torque of the typical ball bearing unit.

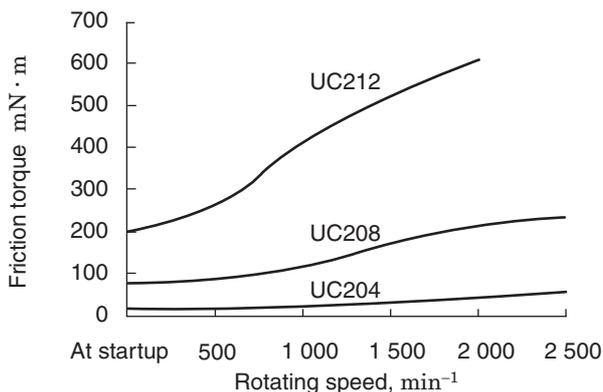

Fig. 13.1 Example of measurement result of ball bearing units

13.2 Bearing temperature increase

The increase in temperature of the bearing is represented as heat energy converted from friction torque in the bearing during operation. The temperature of the bearing during operation increases in proportion to the amount of friction torque, and friction torque increases in proportion to the increase in bearing load.

The increase in temperature of the bearing depends on the heating value generated by friction in the bearing and the amount of heat discharged from the bearing and housing in which it is mounted. Therefore, the temperature level of the bearing is influenced by the environmental conditions of the location in which the bearing unit is installed (quality of heat radiation environment).

Temperature of the bearing unit increases gradually after startup of operation and reaches the maximum level after one or two hours if no abnormalities occur. Then it decreases slightly and enters a steady state (see Fig. 13.2).

In this manner, if the operating conditions are not changed, bearing temperature will remain virtually constant, and measurement of the temperature and assumption of the bearing status are enabled.

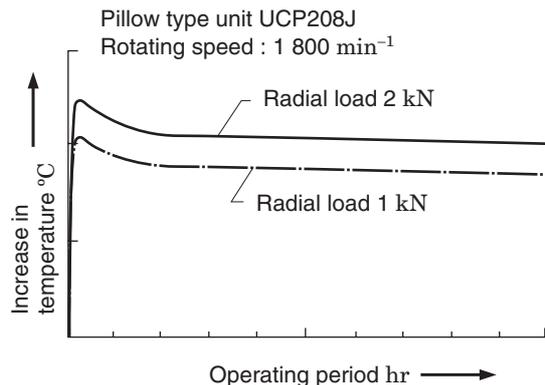

Fig. 13.2 Example of temperature measurement during operation of pillow type units

Increase in temperature during operation of the bearing depends on the type of seal used in the bearing as well as friction torque.

Increase in temperature of triple-lip bearings (suffix code : L3) is greater than that of the standard model, and that of the non-contact seal (suffix code : K3, S5) is lower than the standard model. Bearings for blowers and other high-speed applications are equipped with non-contact seals, with grease or oil, for high-speed operation as well as reduction of heat, vibration, and noise.

13.3 Dustproof and waterproof performance

FYH executes various tests to check dustproof and waterproof performance of different models of bearings. Representative results are shown below.

13.3.1 Dust sprinkle rotating test (dust preventive performance)

In this test, dust is sprinkled directly on the bearing as it is operating in a rotating drum machine. Performance and dust resistance for various sealing mechanisms are judged based on this test.

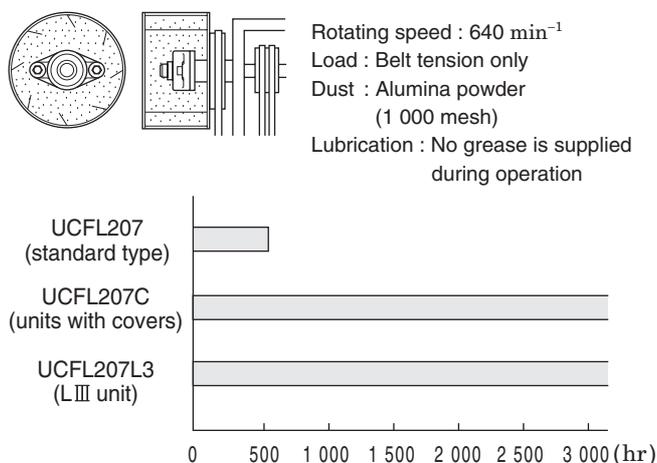

Fig. 13.3 Example of result of dust sprinkle rotating test (dust proof performance)

The standard single-lip bearing exhibited abnormal noise after about 500 hours of operation, and ingress of dust was found.

On the other hand, no abnormality was found in both the triple-lip bearing (suffix code : L3) or the covered unit (suffix code : C) even after 3 000 hours of operation, and therefore superior dustproof performance was established.

13.3.2 Dust immersion rotating test (dustproof performance)

In this test, units are completely buried in dust with impellers installed on the shaft to further stir and circulate the dust. This test is executed under the most severe conditions encountered by mounted bearing units.

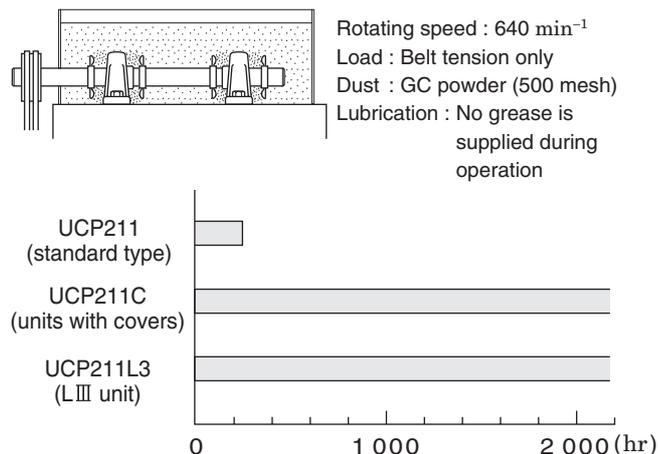

Fig. 13.4 Example result of dust immersion rotating test (dustproof performance)

The standard single-lip bearing exhibited abnormal noise after about 200 hours of operation, and ingress of dust was found.

On the other hand, no abnormality was found in both the triple-lip bearing (suffix code : L3) or the covered unit (suffix code : C) even after 2 000 hours of operation, and therefore superior dustproof performance was established.

13.3.3 Waterproof test

In this test, water is splashed directly onto the units by impellers installed on the shaft.

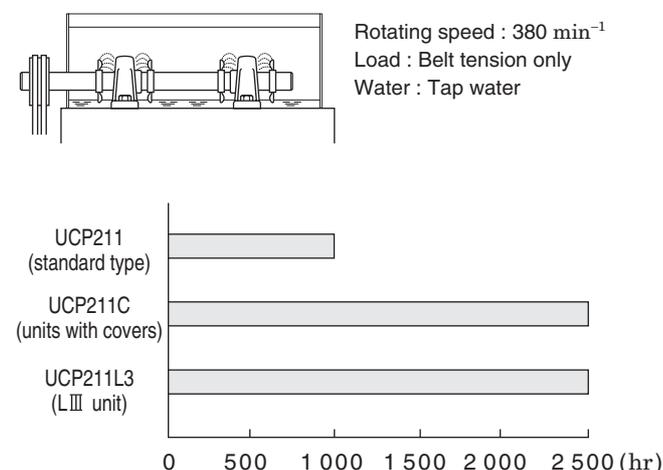

Fig. 13.5 Example result of waterproof performance test

The standard single-lip bearing exhibited rust on the balls and surface of the raceways (inner and outer rings) after about 1 000 hours of operation.

On the other hand, rust was found to the same degree as the standard single-lip bearing in both the triple-lip bearing (suffix code : L3) and the covered unit (suffix code : C) after 2 500 hours of operation.

14 Handlings

One of the predominate features of FYH bearing units is their simplicity of handling and installation. It is of the utmost important that these units are handled and installed correctly to ensure reliable performance.

14.1 Installation

14.1.1 Installation of setscrew units

When installing setscrew units, it is important to tighten the setscrews to the shaft with the specified torque.

If the unit is mounted in an environment where it is exposed to impact or vibration, or if the shaft is rotated in normal and reverse directions, or if rotation is started and stopped frequently and repeatedly, then grind or drill the surface of the shaft where it is contacted by the setscrew with a file or drill in order to create a flat seat (Fig. 14.1) or drilled seat (Fig. 14.2). This will significantly improve the tightening effect of the setscrews.

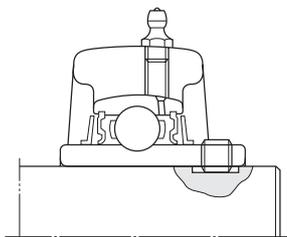

Fig. 14.1 Flat seat provided for shaft
(for improvement in set screw tightening effect)

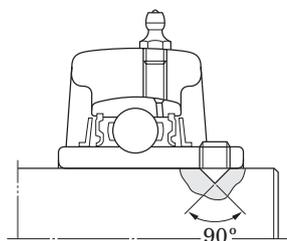

Fig. 14.2 Drilled seat provided for shaft
(for improvement in set screw tightening effect)

If the unit is exposed to great load or excessive vibration, another option is to use a shouldered shaft and tighten the inner ring of the bearing with a shaft nut.

For dimensions of the shouldered shaft, see “9 Design of shaft and base”.

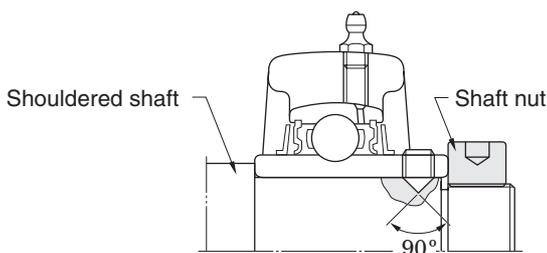

Fig. 14.3 Example of installation with a shouldered shaft and shaft nut

Standard FYH bearings are equipped with double-point setscrews which offer secure tightness to the shaft. Additional styles of setscrews are also available to meet a range of purposes and operating conditions (see Table 14.1).

Table 14.1 Set screws of ball bearings for units

Designations (code)	Details
Double point (no indication)  Double point (G7) Locking finish	The cone point at the center of the screw combined with the round point at the outer edge provide excellent shaft contact and greatly reduce fitting error. A nylon film is fused to the thread surface to prevent the screw from loosening during operation. Prevent looseness with elastic force of nylon film fused to the thread surface.
Pointed (G4) 	The cone point setscrew has a 90° angle and fits a drilled cone seat in the shaft. It allows correct positioning on the shaft and prevents shaft movement in an axial direction.
Full dog point cap (G6) 	The full dog point setscrew fits into the keyed groove in the shaft and allows for expansion and contraction of the shaft.

Shown below are installation procedures for bearing units with setscrews.

- (1) Inspect the unit to ensure that the rigidity of the base, flatness of the mounting surface, and tolerance of the shaft meet the required standards. Check the shaft for bends, burrs, and other flaws.
- (2) Make sure that the tip of the setscrew does not exceed the bearing bore diameter surface.
- (3) Fit the bearing unit onto the shaft and slide it to the specified position. In order to secure a tight fit, press-fit the bearing unit to the shaft with a press, cold-fit by cooling the shaft, or shrink-fit the bearing unit by warming it with an air bath (100 °C or less). Avoid hitting the bearing with a hammer to press-fit the bearing to the shaft.
- (4) Align the bearing unit to the specified position on the base and affix it with washers, if necessary, and bolts (Fig. 14.4). Use a torque wrench to tighten the bolts to the housing to the specified torque setting. For mounting bolt torque specifications, see Appendix table 2 in the back of this catalog.



Fig. 14.4 Installation of setscrew units

(5) Tighten both of the setscrews on the inner ring to the specified torque setting (**Fig. 14.5**). For setscrew torque specifications, see **Appendix table 3** in the back of this catalog.

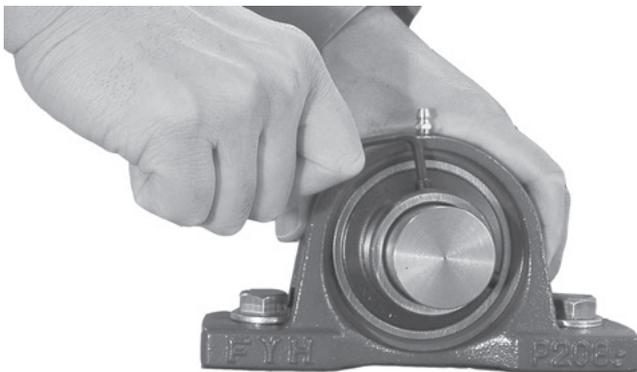

Fig. 14.5 Tightening of set screws

(6) Turn the shaft by hand and tighten the setscrews of all other bearings on the same shaft to the specified torque setting.
 (7) Finally, turn the shaft by hand and make sure that it rotates without any problems.

14.1.2 Installation of adapter style units

Adapter units, comprised of an adapter sleeve, locknut, and washer, can be installed into environments where they are exposed to excessive vibration and impact.

It is of great importance that these units are properly mounted. If the locknut is not properly tightened, the sleeve may be loose which could lead to slippage and wear on the shaft or bearing. Conversely, if the locknut is over-tightened, the inner ring of the bearing can expand and reduce internal ball clearance which could cause excessive heat and premature failure.

Installation procedures for adapter style bearings are shown below.

- (1) Inspect the unit to ensure that the rigidity of the base, flatness of the mounting surface, and tolerance of the shaft meet the required standards. Check the shaft for bends, burrs, and other flaws.
- (2) Slide the adapter sleeve onto the shaft where the bearing unit will be installed.
 If the sleeve is too tight, place a screwdriver in the slotted portion of the sleeve and expand the slot to open the sleeve.
- (3) Slide the bearing unit over the shaft and onto the adapter sleeve, then place a cylindrical reinforcing plate against the inner ring of the front side of the bearing. Seat the adapter sleeve by lightly tapping all around the backside of the sleeve (**Fig. 14.6**).

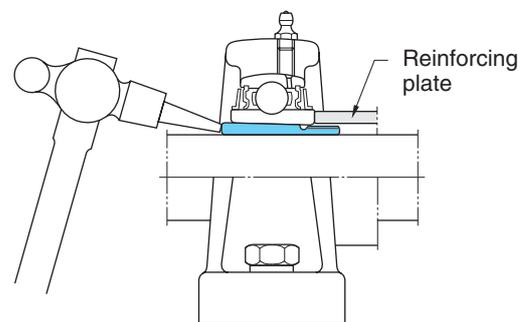

Fig. 14.6 Fitting adapter sleeve to bearing with tapered bore

- (4) Attach the lock washer so that the tab fits into the slot in the sleeve, and, making sure the tapered side is facing the bearing, tighten the locknut on the sleeve by hand.
- (5) Align the bearing unit to the specified position on the base and affix it with washers, if necessary, and bolts. Use a torque wrench to tighten the bolts to the housing to the specified torque setting. For mounting bolt torque specifications, see **Appendix table 2** in the back of this catalog.
- (6) Use a torque wrench to tighten the locknut to the correct specification (**Fig. 14.7**). For locknut torque specifications, see **Appendix table 4** in the back of this catalog.

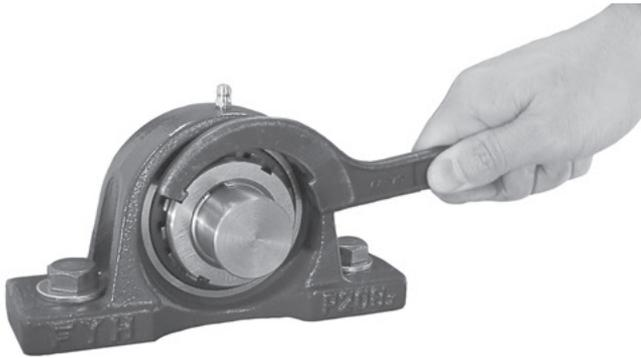

Fig. 14.7 Tightening locknut

- (7A) For pillow block housings, loosen the mounting bolts and adjust the unit axially while rotating the shaft by hand. Then re-tighten the mounting bolts to the correct specification.
- (7B) For flange block housings, the position of the unit must be in the correct axial position in relation to the shaft, so take extra care to properly align them before completing installation.
- (8) Bend one of the tabs on the washer so that it fits into one of the slots on the locknut (**Fig. 14.8**).



Fig. 14.8 Bending claw of washer (Locking locknut)

- (9) Finally, turn the shaft by hand and make sure that it rotates without any problems.

14.1.3 Installation of units with eccentric locking collars

Eccentric locking collar bearings provide another option for shaft locking. Since the rotating force of the shaft increases the tightening force of the eccentric ring to the shaft, this style of bearing allows a secure grip to the shaft.

Since the rotating force of the shaft increases the tightening force of the eccentric ring to the shaft, the unit with eccentric locking collar allows secure fixing of the bearing (**Fig. 14.9**).



Fig. 14.9 Ball bearing units with eccentric locking collar

Installation procedures for eccentric locking collar style bearings are shown below.

- (1) Inspect the unit to ensure that the rigidity of the base, flatness of the mounting surface, and tolerance of the shaft meet the required standards. Check the shaft for bends, burrs, and other flaws.
- (2) Slide the bearing unit onto the shaft, and place it at the specified mounting position.
- (3) Align the bearing unit to the specified position on the base and affix it with washers, if necessary, and bolts (**Fig. 14.4**). Use a torque wrench to tighten the bolts to the housing to the specified torque setting. For mounting bolt torque specifications, see **Appendix table 2** in the back of this catalog.
- (4) Fit the eccentric section of the inner ring of the bearing to the eccentric recessed section of the eccentric locking collar, and rotate the collar in the direction of shaft rotation. Then tighten the setscrew on the eccentric locking collar to the specified torque setting (**Fig. 14.10**). For setscrew torque specifications, see **Appendix table 3** in the back of this catalog.



Fig. 14.10 Installing eccentric locking collar

- (5) Rotate the shaft by hand and then install the next eccentric locking collar unit to the shaft.
- (6) Finally, turn the shaft by hand and make sure that it rotates without any problems.

14.1.4 Installing units with covers

Covers for ball bearing units are available in two types, steel plate and cast iron. Install both the covers at last after installation of the bearing and housing is complete.

Procedures for installation of the ball bearing units with covers are shown below.

- (1) Apply grease all around the seal lip of the cover, and pack the internal space of the cover with grease (approximately 1/3 to 1/2 of the space capacity) (**Fig. 14.11**).

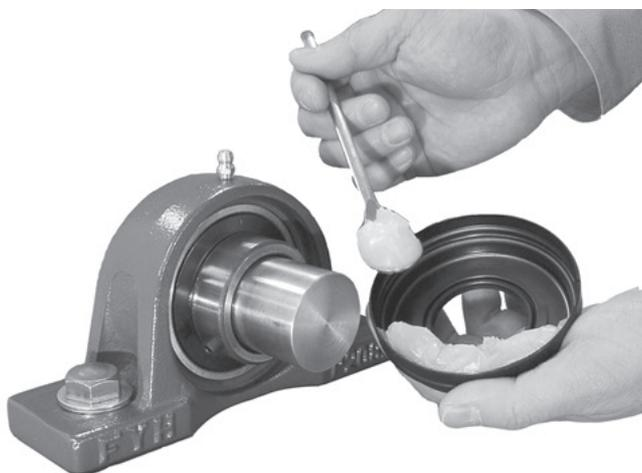
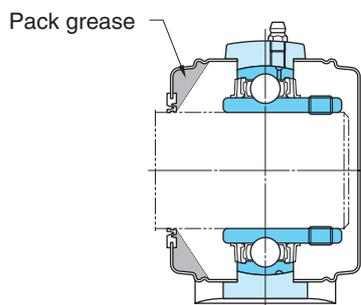

Fig. 14.11 Packing grease in internal space of seal lip of covers

- (2) Put a cover through the shaft, and then, fit the bearing unit to the shaft.
- (3) Fit the cover through the shaft to the cover groove on the housing, and fix it.
- (4A) For the steel plate cover, tap all around the cover evenly with a synthetic resin hammer to prevent deformation, and install it to the housing (**Fig. 14.12**).

To remove the steel plate cover, put a screwdriver into the groove on the periphery of the cover, and slightly pry it.



Fig. 14.12 Installing steel plate covers

- (4B) When installing the cast iron cover, fit the cover to the cover groove of the housing, and fix it with the bolt. For the tightening torque of the cast iron cover mounting bolt, see the **Appendix table 2** at the end of this catalogue.
- (5) Install another cover to the housing in a similar manner.
- (6) Check for abnormality of the installed cover.
- (7) At last, turn the shaft with your hands, and check for abnormality in the rotating status of the bearing.

14.2 Test run inspection

After installation of the ball bearing unit is complete, execute the test run inspection to ensure that it is done appropriately.

The test run inspection should be executed by following the procedures below. Check for abnormality in the bearing unit.

- (1) Turn the shaft with your hands, and make sure that the bearing is rotated smoothly. If any jam, vibration, great rotation torque (heavy), or uneven rotation is found, the bearing is judged to be faulty.
- (2) Execute power run with no load and at a low speed, and check for abnormal noise and vibration.
- (3) Carry out power run under the specified conditions, and check for abnormal noise, vibration, and temperature increase.

Table 14.2 shows the main faults that may occur during the test run inspection of the ball bearing unit and causes.

Table 14.2 Main causes of bearing failure during test runs and their causes

Faults	Causes
Excessive torque, uneven rotating torque	(1) Faulty installation, causes preload on bearing (2) Inappropriate handling or installation, leading to interference of seal with slinger (3) Excessive tightening of locknut (adapter) causing too small internal clearance of bearing
Abnormal noise, abnormal vibration	(1) Improper tightening of set screws or of mounting bolts (2) Excessively large internal clearance of bearings (3) Bent shaft, or shouldered shaft may be machined eccentrically (4) Shaft tolerance chosen improperly (5) Mounting base not rigid or flat
Abnormal temperature increase	(1) Too small internal clearance of bearing (2) Faulty installation, causes preload on bearing (3) load too great (4) Allowable rotational speed exceeded (5) Mounting base not rigid or flat (6) Inappropriate handling or installation, leading to interference of seal with slinger

Table 14.3 Main Faults found during periodic inspection and their causes

Faults	Causes
Excessive torque	(1) Degraded grease (2) Interference of seal with slinger due to excessive supply of grease (3) Deformation of slinger causing interference with seal (4) High load due to shaft expansion
Abnormal noise, abnormal vibration	(1) Improper tightening of set screws or of mounting bolts (2) Wear on inner ring of bearing or shaft due to creep or fretting (3) Ingress of foreign matter (dirt) into bearing (4) Damage to cage or ball rolling surfaces due to rolling fatigue (5) Dent on raceway surface or ball rolling surface because of excessive load (6) Warped or bent shaft
Abnormal temperature increase	(1) Degraded grease (2) Interference of seal with slinger due to excessive supply of grease (3) Deformation of slinger causing interference with seal (4) Looseness of setscrew, eccentric locking ring or adapter lock nut for tapered i.d. bearings (5) Load due to shaft expansion (6) Damage to cage or ball rolling surfaces due to rolling fatigue

14.3 Periodic inspection

FYH Ball Bearing Units do not need to be inspected as frequently as lower quality bearings. However it is good practice to set up an inspection schedule for even these high quality bearings.

Since a ball bearing unit cannot be disassembled for inspection of the internal status of components, the external appearance of the bearing must be inspected to give tell-tale signs of the status and expected life of the bearing. The following characteristics must be checked per the inspection schedule that is established for a particular application.

- (1) Overall appearance
- (2) Looseness of set screw of bearing inner ring or of the mounting bolts
- (3) Noise from vibration
- (4) Temperature of the bearing housing or the inner ring
- (5) Grease supply interval and quantity of grease injected into the bearing (either too much or too little grease can be detrimental to the life of the bearing)

Table 14.3 shows the main faults that are usually found during periodic inspections and their causes.

If any fault is found in a ball bearing unit during an inspection, then immediate action must be taken to correct the situation and prevent deterioration of the bearing components. If serious damage has already occurred to the bearing unit, then the bearing unit must be replaced immediately to prevent damage to other machine components.

14.4 Supply of grease

FYH ball bearing units are supplied with high quality grease packed inside a high quality seal. Therefore, under clean operating conditions at lighter loads and lower speeds at normal temperatures, the bearing may be used with no further lubrication.

However, under harsher operating conditions and environment, the grease will deteriorate much more rapidly. This would include environments exposed to dust, moisture or higher operating temperatures.

In such cases, a regreasing schedule must be established to prevent premature failure of the bearings. The life of the bearing can be greatly extended by proper attention to the regreasing schedule and by supplying the proper amount of grease. Please note that too much grease can be detrimental as well as too little grease.

14.4.1 Grease life and supply intervals

The grease life of a packed ball bearing unit can be found using **Formula (4.7)** on page 21.

The regreasing schedule should be set at 1/4 to 1/3 of the grease life found by the calculation shown above ; however this may be adjusted for particularly demanding environments or conditions.

In addition, some environments may be unusually dirty or wet, and these conditions may be exacerbated by higher temperatures. Under such harsh conditions, a more frequent regreasing schedule will extend the life of the bearing.

Under normal operating conditions, please adhere to the guidelines outlined in **Table 14.4**.

14.4.2 Amount of grease

The amount of grease initially supplied in a new FYH Ball Bearing Unit is approximately 30 to 35% of the internal space capacity of the bearing. If the bearing is ever over greased, the agitation of the grease causes internal friction and heating of the bearing. The first sign of failure will be excessive grease finding its way to the outside of the bearing. DO NOT exceed the initial greasing amount.

Table 14.5 shows the recommended amount of grease to be used for regreasing FYH bearings.

In a severely dusty or wet environment, the amount of grease may be increased by two times, only if operating speeds are low.

- Remarks
1. Table 14.5 applies to UK units as well.
 2. For greasing triple lip (L III) type bearings, use 1 1/2 times the amount of grease recommended in the table.
 3. Values shown in the table are applicable to standard grease (specific gravity : 0.9 g/ml). If a compatible grease of another specific gravity is used, then the proper conversion must be made, to insure that the recommended volume is put into the bearing.

Table 14.5 Amount of recommended grease for ball bearing units

Bore dia. code	Greasing amount, g		
	UC200	UCX00	UC300
01	1.8		
02	1.8		
03	1.8		
04	1.8	–	–
05	1.8	3.3	4.2
06	3.3	4.5	5.9
07	4.5	5.6	8.1
08	5.6	6.5	10.1
09	6.5	7.7	12.6
10	7.7	10.3	18.1
11	10.3	13.2	25
12	13.2	14.9	31
13	14.9	18.2	39
14	18.2	21	47
15	21	25	56
16	25	31	65
17	31	38	78
18	38	48	90
19	–	–	108
20		69	141
21		–	165
22			198
24			237
26			291
28			337

Table 14.4 Grease schedule of ball bearing units

Operating temperature, °C		Grease Intervals			Bearing used	Grease supplied
Over	Incl.	Substantially clean	Excessive dust	Excessive dust and moisture		
	50	(3 months) not necessary	(2 months) 1 year	(1 month) 4 months	(Low temperature D2K2) ¹⁾	Shell Alvania RL2,
50	70	1 year	4 months	1 month	Standard bearing	Gold No.3 or equivalent
70	100	6 months	2 months	2 weeks		
100	120	2 months	2 weeks	5 days	High temperature	SH44M
120	150	2 weeks	5 days	2 days	D1K2	
150	180	1 week	2 days	1 day		

Note ¹⁾ Greasing intervals in parentheses are applicable to low temperature grease (D2K2).

Remark Greasing intervals shown in this table are applicable to a unit operated for 8 to 10 hours per day. If the time of operation is greater than this range, then a more frequent greasing interval must be specified. For example, if the unit is operated 16 to 20 hours per day, then the greasing interval must be twice as frequent.

14.4.3 Types of grease supplied

Many different types of grease are available for use in ball bearings. However, if a non-compatible grease is used, particularly a non-lithium based grease, then performance may be drastically reduced.

Please use the grease recommended in **Table 2.3** to assure optimum performance of your bearings.

If another grease is used in an emergency situation, for instance, please assure that this grease is compatible, with a lithium base, at the minimum.

14.4.4 Relubricating the unit at the specified interval

Note **Fig. 14.13** which shows the grease nipple, grease groove and grease holes for relubrication of the unit.

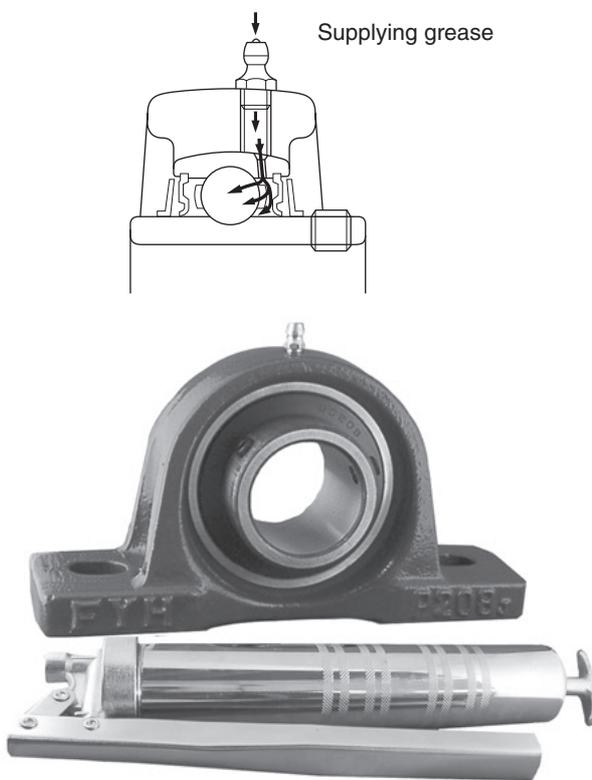

Fig. 14.13 Supplying grease to ball bearing units

- (1) Clean the grease nipple and the area around it to prevent dirt and foreign material from entering the unit.
- (2) Clean the grease gun and pack clean grease.
- (3) Grease the unit with the recommended amount of grease.

When lubricating the ball bearing unit, slowly turn the shaft with your hand. This causes the fresh grease to be uniformly distributed inside the unit.

If it is difficult to access the standard straight type nipple with a grease gun, the 45° and 90° angled units are available as an option. See the picture below of these grease nipples. Please contact us with your special needs.

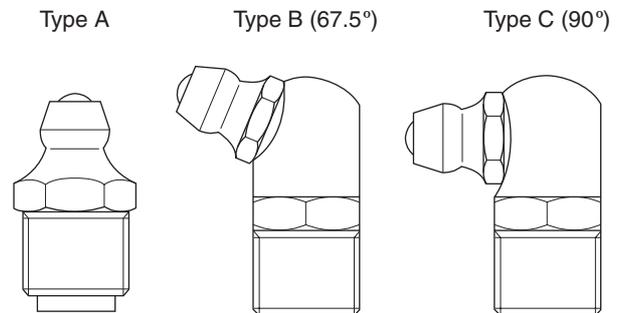

Fig. 14.14 Types of grease nipple for ball bearing units

When using a centralized automatic lubrication system, with ball bearings, it is important to use softer grease than normal. The grease should be specified with a “worked penetration number” between 300 and 380. This is NLGI grade “0” or “1”. Piping from the lubricating system must be sized so that the specified volume of grease is applied.

Piping must be connected to the threaded hole on the ball bearing unit. This is either 1/4-28 tapered threads for units up to “2” in size or 1/8 PT (BSPT) for ball bearing units larger than “2” shaft diameter. If the piping size used is larger than the threaded hole in the ball bearing unit, then the appropriate reducing coupling (or street elbow) must be used to fit the threaded hole.

Fig. 14.15 shows the body of a pipe reducer.

When using an automatic centralized lubrication system, it is imperative to assure that the correct volume of grease is supplied to each individual bearing as specified in **Table 14.5**. The total amount of grease is a multiple of the number of bearings being supplied by the central system.

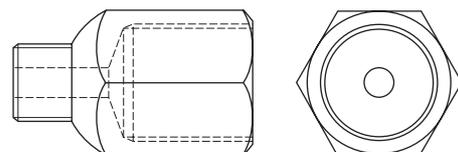

Fig. 14.15 Reducing coupling for centralized lubrication systems

For details of grease nipples and reducing couplings, see “**16 Parts and accessories**”.

14.5 Replacing bearings

If a bearing insert needs to be replaced, it is not always necessary to replace the housing, if the housing is undamaged. Simply insert a new bearing into the old housing, after carefully inspecting the housing to assure that it is not damaged.

Replacement procedures for a bearing insert are listed below.

- (1) Remove the complete bearing unit from the shaft and mounting base.
- (2) Screw in the set screws so that the head of the set screw does not protrude outside the O.D. of the inner race. Otherwise the head of the set screw may damage the bearing seat inside the housing.
- (3) Turn the bearing 90° with a hammer handle or a bar or pipe until the bearing is horizontal.
- (4) Remove the bearing insert from the housing via the bearing groove in the housing.

Reverse the above procedure to put in a new bearing insert. Insure that the set screws are screwed in before proceeding with the replacement.

15 Dimensional tables for ball bearing units

15 Dimensional tables for ball bearing units (contents)

1 Pillow type units

Pillow type units

UCP (<i>d</i> 12 ~ 140)	62
NAP (<i>d</i> 12 ~ 75)	68
NAPK (<i>d</i> 12 ~ 75)	70
UKP (<i>d</i> ₁ 20 ~ 125)	72
UCP-SC (<i>d</i> 25 ~ 140)	78
UKP-SC (<i>d</i> ₁ 20 ~ 125)	82

Thick pillow type units

UCIP (<i>d</i> 40 ~ 140)	86
UKIP (<i>d</i> ₁ 35 ~ 125)	88

Tapped-base pillow type units

UCPA (<i>d</i> 12 ~ 50)	90
--------------------------------	----

High centerheight pillow type units

UCPH (<i>d</i> 12 ~ 50)	92
--------------------------------	----

Lightweight pillow type units

BLP, ALP (<i>d</i> 12 ~ 40)	94
------------------------------------	----

Clean series pillow type units

UP (<i>d</i> 10 ~ 30)	96
------------------------------	----

Stainless steel series pillow type units

UCSP-H1S6 (<i>d</i> 20 ~ 50)	98
UCSPA-H1S6 (<i>d</i> 20 ~ 40)	100
USP-S6 (<i>d</i> 10 ~ 30)	102

Steel plate pillow type units

SBPP, SAPP (<i>d</i> 12 ~ 30)	104
--------------------------------------	-----

2 Square four-bolt flange type units

Square four-bolt flange type units

UCF (<i>d</i> 12 ~ 140)	106
UCF-E (<i>d</i> 12 ~ 85)	112
NANF (<i>d</i> 12 ~ 60)	116
UKF (<i>d</i> ₁ 20 ~ 125)	118

Square four-bolt flange cartridge type units

UCFS (<i>d</i> 25 ~ 140)	124
UKFS (<i>d</i> ₁ 20 ~ 125)	126

Stainless steel series

square four-bolt flange type units

UCSF-H1S6 (<i>d</i> 20 ~ 50)	128
-------------------------------------	-----

3 Oval flange type units

Oval two-bolt flange type units

UCFL (<i>d</i> 12 ~ 130)	130
UCFL-E (<i>d</i> 12 ~ 85)	136
NANFL (<i>d</i> 12 ~ 55)	140
UKFL (<i>d</i> ₁ 20 ~ 115)	142

Adjustable oval two-bolt flange type units

UCFA (<i>d</i> 12 ~ 55)	146
--------------------------------	-----

Three-bolt flange type units

UCFB (<i>d</i> 12 ~ 50)	148
--------------------------------	-----

Lightweight oval two-bolt flange type units

BLF, ALF (<i>d</i> 12 ~ 35)	150
------------------------------------	-----

Clean series oval two-bolt flange type units

UFL (<i>d</i> 8 ~ 30)	152
------------------------------	-----

Stainless steel series

oval two-bolt flange type units

UCSFL-H1S6 (<i>d</i> 20 ~ 50)	154
USFL-S6 (<i>d</i> 10 ~ 30)	156

4 Round flange cartridge type units

UCFC (<i>d</i> 12 ~ 100)	158
UCFCX-E (<i>d</i> 25 ~ 100)	162
UKFC (<i>d</i> ₁ 20 ~ 90)	164

5 Stamped steel plate flange type units

Stamped steel plate

round three-bolt flange type units

SBPF, SAPF (<i>d</i> 12 ~ 35)	168
--------------------------------------	-----

Stamped steel plate

oval two-bolt flange type units

SBPFL, SAPFL (<i>d</i> 12 ~ 35)	170
--	-----

6 Take-up type units

Take-up type units

UCT (<i>d</i> 12 ~ 140)	172
UCT-E (<i>d</i> 12 ~ 85)	178
UKT (<i>d</i> ₁ 20 ~ 125)	182

Stainless steel series take-up type units

UCST-H1S6 (<i>d</i> 20 ~ 50)	188
-------------------------------------	-----

Section steel frame take-up type units

UCTH (<i>d</i> 12 ~ 65)	190
--------------------------------	-----

Channel steel frame take-up type units

UCTL (<i>d</i> 20 ~ 45)	192
UCTU (<i>d</i> 40 ~ 90)	194

Steel plate frame take-up type units

SBPTH (<i>d</i> 12 ~ 25)	198
SBNPTH (<i>d</i> 12 ~ 25)	200

7 Other units

Cartridge type units

UCC (<i>d</i> 12 ~ 140)	202
UKC (<i>d</i> ₁ 20 ~ 125)	206

Hanger type units

UCHA (<i>d</i> 12 ~ 75)	208
--------------------------------	-----

8 Ball bearing inserts

Cylindrical bore (with set screws)

UC, SB, SU (<i>d</i> 8 ~ 140)	210
--------------------------------------	-----

Stainless steel series,

cylindrical bore (with set screws)

UC-S6 (<i>d</i> 20 ~ 50)	216
SU-S6 (<i>d</i> 10 ~ 30)	216

Tapered bore (with adapter)

UK (<i>d</i> ₁ 20 ~ 125)	218
--	-----

Cylindrical bore

(with eccentric locking collar)

SA, SA-F, NA (<i>d</i> 12 ~ 75)	224
--	-----

Cylindrical bore (with set screws), cylindrical outside surface

ER, RB (<i>d</i> 12 ~ 60)	228
----------------------------------	-----

9 Bearing adapters

H300X, H2300X (<i>d</i> ₁ 20 ~ 125)	230
---	-----

Pillow type units

UCP
Cylindrical bore (with set screws)
d 12 ~ (45) mm

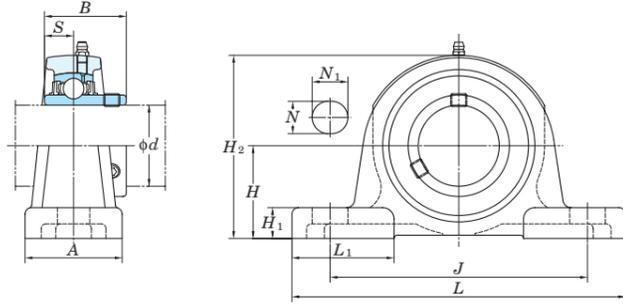

With Pressed Steel Cover

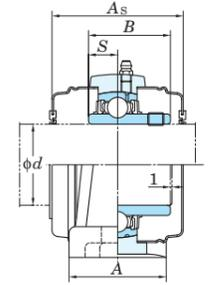

With Cast Iron Cover

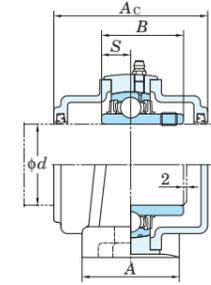

Variations of tolerance of distance from mounting bottom to center of spherical bore (ΔH_s)

Housing No.	ΔH_s
P203~P210	± 0.15
P211~P218	± 0.2
PX20	± 0.3
P305~P310	± 0.15
P311~P318	± 0.2
P319~P328	± 0.3

Forms and dimensions of H_{2c} of P204JE3 and P205JE3 (housing with cast iron cover) are shown below.



Shaft Dia. mm inch d	Dimensions inch mm												Bolt Size inch mm	Standard			Mass kg	Basic Load Ratings kN		Factor f_0	With Pressed Steel Cover				With Cast Iron Cover			
	H	L	A	J	N	N_1	H_1	H_2	L_1	B	S	Unit No.		Housing No.	Bearing No.	Unit No.		Dimension mm inch	Mass kg		Unit No.	Dimension mm inch	Mass kg					
12 15 17	$1/2$ $5/8$	$1\ 3/16$	5	$1\ 1/2$	$3\ 3/4$	$1/2$	$23/32$	$15/32$	$2\ 3/8$	$1\ 1/2$	1.220	0.500	$3/8$	UCP201 UCP201-8 UCP202 UCP202-10 UCP203	P203	UC201 UC201-8 UC202 UC202-10 UC203	0.63 0.63 0.61 0.61 0.60	12.8	6.65	13.2	UCP201C UCP201CD UCP202C UCP202CD UCP203C UCP203CD	$44\ 1\ 23/32$	0.63 — 0.61 — 0.60	— — — — —	— — — — —	— — — — —		
		$1\ 5/16$	5	$1\ 1/2$	$3\ 3/4$	$1/2$	$23/32$	$1/2$	$2\ 17/32$	$1\ 1/2$	1.220	0.500	$3/8$	UCP204-12 UCP204	P204	UC204-12 UC204	0.66 0.66	12.8	6.65	13.2	UCP204C UCP204CD	$44\ 1\ 23/32$	0.66	UCP204FC UCP204FCD	62	$2\ 7/16$	0.96	
		$1\ 7/8$ $15/16$	$1\ 7/16$	$5\ 1/2$	$1\ 1/2$	$4\ 1/8$	$1/2$	$23/32$	$1/2$	$2\ 25/32$	$1\ 11/16$	1.343	0.563	$3/8$	UCP205-14 UCP205-15 UCP205 UCP205-16	P205	UC205-14 UC205-15 UC205 UC205-16	0.80 0.80 0.80 0.80	14.0	7.85	13.9	UCP205C UCP205CD	48	$1\ 7/8$	0.80	UCP205FC UCP205FCD	66	$2\ 19/32$
25	1	$1\ 3/4$	$6\ 1/4$	2	$4\ 11/16$	$21/32$	$31/32$	$5/8$	$3\ 3/8$	$1\ 27/32$	1.500	0.626	$1/2$	UCPX05 UCPX05-16	PX05	UCX05 UCX05-16	1.5 1.5	19.5	11.3	13.9	UCPX05C UCPX05CD	52	$2\ 1/16$	1.5	— —	— —	— —	
		$1\ 49/64$	$6\ 7/8$	$1\ 3/4$	$5\ 3/16$	$21/32$	$25/32$	$5/8$	$3\ 11/32$	$2\ 5/32$	1.496	0.591	$1/2$	UCP305 UCP305-16	P305	UC305 UC305-16	1.7 1.7	21.2	10.9	12.6	— —	— —	— —	UCP305C UCP305CD	76	3	2.3	
		$1\ 11/16$	$6\ 1/2$	$1\ 7/8$	$4\ 3/4$	$21/32$	$13/16$	$19/32$	$3\ 5/16$	$2\ 3/32$	1.500	0.626	$1/2$	UCP206-18 UCP206 UCP206-19 UCP206-20	P206	UC206-18 UC206 UC206-19 UC206-20	1.3 1.3 1.3 1.3	19.5	11.3	13.9	UCP206C UCP206CD	52	$2\ 1/16$	1.3	UCP206FC UCP206FCD	70	$2\ 3/4$	1.8
30	$1\ 3/16$ $1\ 1/4$	$1\ 7/8$	$6\ 7/8$	$2\ 1/4$	5	$21/32$	$31/32$	$21/32$	$3\ 21/32$	$2\ 5/32$	1.689	0.689	$1/2$	UCPX06 UCPX06-19 UCPX06-20	PX06	UCX06 UCX06-19 UCX06-20	2.1 2.1 2.1	25.7	15.4	13.9	UCPX06C UCPX06CD	59	$2\ 5/16$	2.1	— —	— —	— —	
		$1\ 31/32$	$7\ 3/32$	$1\ 31/32$	$5\ 1/2$	$21/32$	$25/32$	$21/32$	$3\ 3/4$	$2\ 3/32$	1.693	0.669	$1/2$	UCP306	P306	UC306	2.2	26.7	15.0	13.3	— —	— —	— —	UCP306C UCP306CD	82	$3\ 7/32$	2.8	
		$1\ 7/8$	$6\ 9/16$	$1\ 7/8$	5	$21/32$	$13/16$	$5/8$	$3\ 21/32$	2	1.689	0.689	$1/2$	UCP207-20 UCP207-21 UCP207-22 UCP207 UCP207-23	P207	UC207-20 UC207-21 UC207-22 UC207 UC207-23	1.6 1.6 1.6 1.6 1.6	25.7	15.4	13.9	UCP207C UCP207CD	59	$2\ 5/16$	1.6	UCP207FC UCP207FCD	78	$3\ 1/16$	2.3
35	$1\ 7/16$ $1\ 3/8$ $1\ 7/16$	$2\ 1/8$	8	$2\ 1/4$	$5\ 11/16$	$21/32$	$1\ 3/16$	$3/4$	$4\ 1/8$	$2\ 17/32$	1.937	0.748	$1/2$	UCPX07-22 UCPX07 UCPX07-23	PX07	UCX07-22 UCX07 UCX07-23	2.7 2.7 2.7	29.1	17.8	14.0	UCPX07C UCPX07CD	68	$2\ 11/16$	2.7	— —	— —	— —	
		$2\ 13/64$	$8\ 9/32$	$2\ 7/32$	$6\ 9/16$	$21/32$	$31/32$	$3/4$	$4\ 7/32$	$2\ 9/16$	1.890	0.748	$1/2$	UCP307	P307	UC307	3.0	33.4	19.3	13.2	— —	— —	— —	UCP307C UCP307CD	88	$3\ 15/32$	3.8	
		$1\ 15/16$	$7\ 1/4$	$2\ 1/8$	$5\ 13/32$	$21/32$	$13/16$	$21/32$	$3\ 27/32$	$2\ 1/4$	1.937	0.748	$1/2$	UCP208-24 UCP208-25 UCP208	P208	UC208-24 UC208-25 UC208	2.0 2.0 2.0	29.1	17.8	14.0	UCP208C UCP208CD	68	$2\ 11/16$	2.0	UCP208FC UCP208FCD	86	$3\ 3/8$	2.8
40	$1\ 1/2$ $1\ 9/16$	$2\ 5/16$	$8\ 3/4$	$2\ 5/8$	$6\ 1/8$	$25/32$	$1\ 1/4$	$13/16$	$4\ 1/2$	$2\ 25/32$	1.937	0.748	$5/8$	UCPX08-24 UCPX08	PX08	UCX08-24 UCX08	3.5 3.5	34.1	21.3	14.0	UCPX08C UCPX08CD	68	$2\ 11/16$	3.5	— —	— —	— —	
		$2\ 23/64$	$8\ 21/32$	$2\ 3/8$	$6\ 11/16$	$21/32$	$1\ 1/16$	$3/4$	$4\ 21/32$	$2\ 9/16$	2.047	0.748	$1/2$	UCP308-24 UCP308	P308	UC308-24 UC308	3.8 3.8	40.7	24.0	13.2	— —	— —	— —	UCP308C UCP308CD	96	$3\ 25/32$	4.8	
		$1\ 5/8$	$7\ 15/32$	$2\ 1/8$	$5\ 3/4$	$21/32$	$13/16$	$21/32$	$4\ 3/16$	$2\ 3/8$	1.937	0.748	$1/2$	UCP209-26 UCP209-27 UCP209-28 UCP209	P209	UC209-26 UC209-27 UC209-28 UC209	2.2 2.2 2.2 2.2	34.1	21.3	14.0	— — — UCP209C UCP209CD	68	$2\ 11/16$	2.2	— — — UCP209FC UCP209FCD	88	$3\ 15/32$	3.0
45	$1\ 3/4$	$2\ 5/16$	$8\ 3/4$	$2\ 5/8$	$6\ 1/8$	$25/32$	$1\ 5/16$	$13/16$	$4\ 9/16$	$2\ 25/32$	2.031	0.748	$5/8$	UCPX09-28 UCPX09	PX09	UCX09-28 UCX09	3.7 3.7	35.1	23.3	14.4	UCPX09C UCPX09CD	73	$2\ 7/8$	3.7	— —	— —	— —	

Remarks 1. In Part No. of unit and units with covers, fitting codes follow bore diameter numbers. (See Table 10.5 in P.42.)
2. Part No. of applicable grease nipples are shown below.
A-1/4-28UNF..... 201~210, X05~X09, 305~308
A-PT1/8..... 211~218, X10~X20, 309~328

3. As for the triple seal type product (from 201 to 205 are the double seal type products), accessory code L3 (or L2) follows the Part No. of unit or bearing. (Example of Part No. : UCP206JL3, UC206L3)
4. For the dimensions and forms of applicable bearings, see the dimensional tables of ball bearing for unit.
5. Representative examples of the forms of housing are indicated.

Pillow type units

UCP
Cylindrical bore (with set screws)
d (75) ~ 140 mm

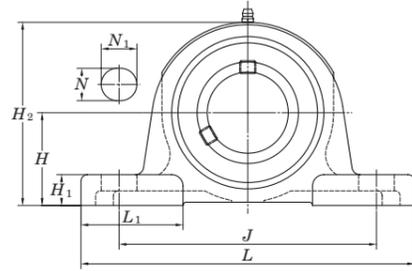
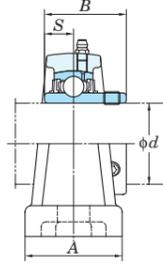

With Pressed Steel Cover

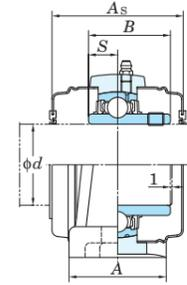

With Cast Iron Cover

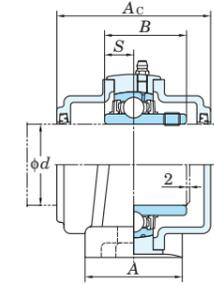

Variations of tolerance of distance from mounting bottom to center of spherical bore (ΔH_s)

Housing No.			ΔH_s
P203~P210	PX05~PX10	P305~P310	± 0.15
P211~P218	PX11~PX18	P311~P318	± 0.2
	PX20	P319~P328	± 0.3

Forms and dimensions of H_{2c} of P204JE3 and P205JE3 (housing with cast iron cover) are shown below.



Shaft Dia. mm inch d	Dimensions inch mm												Bolt Size inch mm	Standard			Mass kg	Basic Load Ratings kN		Factor f_0	With Pressed Steel Cover				With Cast Iron Cover			
	H	L	A	J	N	N ₁	H ₁	H ₂	L ₁	B	S	Unit No.		Housing No.	Bearing No.	Unit No.		Dimension mm inch	Mass kg		Unit No.	Dimension mm inch	Mass kg					
75 3	3 15/16	14 31/32	3 15/16	11 13/32	1 1/16	1 9/16	1 3/8	7 25/32	4 7/32	3.228	1.260	7/8	UCP315-47															
	100	380	100	290	27	40	35	198	107	82	32	M22	UCP315	P315	UC315													
													UCP315-48															
80	3 1/2	11 1/2	3 1/16	9 1/8	31/32	1 3/8	1 1/4	6 27/32	3 3/8	3.252	1.311	3/4	UCP216-50															
	88.9	292	78	232	25	35	32	174	86	82.6	33.3	M20	UCP216	P216	UC216													
	4	15	4	11 1/8	1 1/16	2 9/32	1 11/32	7 11/16	4 9/16	3.374	1.343	7/8	UCPX16	PX16	UCX16	UCP216C	UCP216CD	108	4 1/4	9.0	UCP216FC	UCP216FCD	138	5 7/16	11.4			
85	3 3/4	12 7/32	3 9/32	9 23/32	31/32	1 9/16	1 1/4	7 9/32	3 17/32	3.374	1.343	3/4	UCP217-52															
	95.2	310	83	247	25	40	32	185	90	85.7	34.1	M20	UCP217	P217	UC217													
	4	15	4	11 1/8	1 1/16	2 3/8	1 11/32	7 7/8	4 9/16	3.780	1.563	7/8	UCPX17	PX17	UCX17	UCP217C	UCP217CD	112	4 13/32	10.8	UCP217FC	UCP217FCD	142	5 19/32	13.5			
90	3 1/2	12 7/8	3 15/32	10 5/16	1 1/16	2 5/32	1 11/32	7 29/32	4 23/32	3.780	1.563	7/8	UCP218-56															
	101.6	327	88	262	27	45	34	198	104	96	39.7	M22	UCP218	P218	UC218													
	4	15	4 3/8	11 1/8	1 1/16	2 3/8	1 1/2	8 1/32	4 9/16	4.094	1.689	7/8	UCPX18	PX18	UCX18	UCP218C	UCP218CD	122	4 13/16	13.9	UCP218FC	UCP218FCD	152	6	17.0			
95	4 11/64	16 17/32	4 11/32	12 19/32	1 5/16	1 25/32	1 9/16	8 21/32	4 23/32	3.780	1.575	1	UCP317	P317	UC317													
	112	420	110	320	33	45	40	220	120	96	40	M27	UCP318-56															
	4 59/64	18 1/2	4 23/32	14 3/16	1 13/32	1 31/32	1 13/16	9 3/4	4 29/32	4.055	1.614	1 1/8	UCP319	P319	UC319													
100	5	17	4 3/4	13 1/4	1 5/16	2 9/16	1 25/32	9 21/32	4 31/32	4.626	1.937	1	UCPX20	PX20	UCX20													
	127	432	121	337	33	65	45	245	126	117.5	49.2	M27	UCP20-63															
	5 33/64	19 9/32	4 23/32	14 31/32	1 13/32	1 31/32	1 13/16	10 3/4	5 1/2	4.252	1.654	1 1/8	UCP320	P320	UC320													
105	140	490	120	380	36	50	46	273	140	108	42	M30	UCP320-63															
	5 59/64	19 9/32	4 23/32	14 31/32	1 13/32	1 31/32	1 13/16	10 3/4	5 1/2	4.409	1.732	1 1/8	UCP321	P321	UC321													
	140	490	120	380	36	50	46	278	140	112	44	M30	UCP322	P322	UC322													
110	5 29/32	20 15/32	5 1/2	15 3/4	1 9/16	2 5/32	1 31/32	11 21/32	5 29/32	4.606	1.811	1 1/4	UCP324	P324	UC324													
	150	520	140	400	40	55	50	296	150	117	46	M33	UCP326	P326	UC326													
	6 19/64	22 7/16	5 1/2	17 23/32	1 9/16	2 5/32	1 31/32	12 7/16	6 5/16	4.961	2.008	1 1/4	UCP328	P328	UC328													
120	7 3/32	23 5/8	5 1/2	18 29/32	1 9/16	2 5/32	1 31/32	13 21/32	7 11/16	5.315	2.126	1 1/4	UCP324C	P324	UC324													
	160	570	140	450	40	55	50	316	160	126	51	M33	UCP326C	P326	UC326													
	6 19/64	22 7/16	5 1/2	17 23/32	1 9/16	2 5/32	1 31/32	12 7/16	6 5/16	4.961	2.008	1 1/4	UCP328C	P328	UC328													
130	7 3/32	23 5/8	5 1/2	18 29/32	1 9/16	2 5/32	1 31/32	13 21/32	7 11/16	5.315	2.126	1 1/4	UCP324C	P324	UC324													
	180	600	140	480	40	55	50	355	195	135	54	M33	UCP326C	P326	UC326													
	7 7/8	24 13/32	5 1/2	19 11/16	1 9/16	2 5/32	2 3/8	15 15/32	7 9/32	5.709	2.323	1 1/4	UCP328C	P328	UC328													
140	200	620	140	500	40	55	60	393	185	145	59	M33	UCP328C	P328	UC328													
	7 7/8	24 13/32	5 1/2	19 11/16	1 9/16	2 5/32	2 3/8	15 15/32	7 9/32	5.709	2.323	1 1/4	UCP328C	P328	UC328													
	200	620	140	500	40	55	60	393	185	145	59	M33	UCP328C	P328	UC328													

Remarks 1. In Part No. of unit and units with covers, fitting codes follow bore diameter numbers. (See Table 10.5 in P.42.)
2. Part No. of applicable grease nipples are shown below.
A-1/4-28UNF..... 201~210, X05~X09, 305~308
A-PT1/8..... 211~218, X10~X20, 309~328

3. As for the triple seal type product (from 201 to 205 are the double seal type products), accessory code L3 (or L2) follows the Part No. of unit or bearing. (Example of Part No. : UCP206JL3, UC206L3)
4. For the dimensions and forms of applicable bearings, see the dimensional tables of ball bearing for unit.
5. Representative examples of the forms of housing are indicated.

NAP
Cylindrical bore
(with eccentric locking collar)
d 12 ~ 75 mm

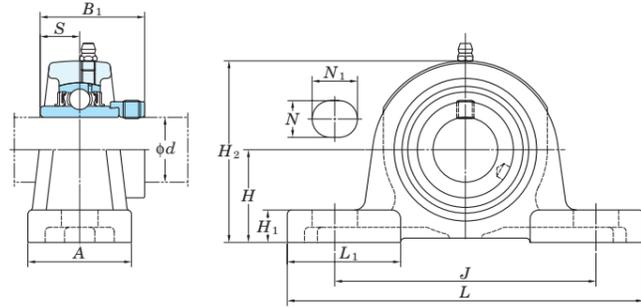

Variations of tolerance of distance from mounting bottom to center of spherical bore (ΔH_s)

Housing No.	Unit : mm
P203-P210	±0.15
P211-P215	±0.2

Shaft Dia. mm inch d	Dimensions inch mm											Bolt Size inch mm	Unit No.	Housing No.	Bearing No.	Basic Load Ratings kN		Factor f_0	Mass kg
	H	L	A	J	N	N ₁	H ₁	H ₂	L ₁	B ₁	S					C _r	C _{0r}		
12 1/2	1 3/16	5	1 1/2	3 3/4	1/2	23/32	15/32	2 3/8	1 1/2	1.720	0.673	3/8	NAP201 NAP201-8 NAP202 NAP202-10 NAP203	P203	NA201 NA201-8 NA202 NA202-10 NA203	12.8	6.65	13.2	0.71 0.69 0.66
15 5/8	30.2	127	38	95	13	18	12	60	38	43.7	17.1	M10							
17																			
20 3/4	1 5/16	5	1 1/2	3 3/4	1/2	23/32	1/2	2 17/32	1 1/2	1.720	0.673	3/8	NAP204-12 NAP204	P204	NA204-12 NA204	12.8	6.65	13.2	0.73
25 7/8 15/16	1 7/16	5 1/2	1 1/2	4 1/8	1/2	23/32	1/2	2 25/32	1 11/16	1.748	0.689	3/8	NAP205-14 NAP205-15 NAP205 NAP205-16	P205	NA205-14 NA205-15 NA205 NA205-16	14.0	7.85	13.9	0.87
30 1 1/8	1 11/16	6 1/2	1 7/8	4 3/4	21/32	13/16	19/32	3 5/16	2 3/32	1.906	0.720	1/2	NAP206-18 NAP206 NAP206-19 NAP206-20	P206	NA206-18 NA206 NA206-19 NA206-20	19.5	11.3	13.9	1.4
35 1 1/4 1 5/16 1 3/8	1 7/8	6 9/16	1 7/8	5	21/32	13/16	5/8	3 21/32	2	2.012	0.740	1/2	NAP207-20 NAP207-21 NAP207-22 NAP207 NAP207-23	P207	NA207-20 NA207-21 NA207-22 NA207 NA207-23	25.7	15.4	13.9	1.8
40 1 1/2 1 9/16	1 15/16	7 1/4	2 1/8	5 13/32	21/32	13/16	21/32	3 27/32	2 1/4	2.217	0.843	1/2	NAP208-24 NAP208-25 NAP208	P208	NA208-24 NA208-25 NA208	29.1	17.8	14.0	2.1
45 1 5/8 1 11/16 1 3/4	2 1/8	7 15/32	2 1/8	5 3/4	21/32	13/16	21/32	4 3/16	2 3/8	2.217	0.843	1/2	NAP209-26 NAP209-27 NAP209-28 NAP209	P209	NA209-26 NA209-27 NA209-28 NA209	34.1	21.3	14.0	2.4
50 1 7/8 1 15/16 2	2 1/4	8 1/8	2 3/8	6 1/4	25/32	7/8	3/4	4 7/16	2 15/32	2.469	0.969	5/8	NAP210-30 NAP210-31 NAP210 NAP210-32	P210	NA210-30 NA210-31 NA210 NA210-32	35.1	23.3	14.4	3.1
55 2 2 3/16	2 1/2	8 5/8	2 3/8	6 23/32	25/32	7/8	3/4	4 29/32	2 3/4	2.811	1.094	5/8	NAP211-32 NAP211-34 NAP211 NAP211-35	P211	NA211-32 NA211-34 NA211 NA211-35	43.4	29.4	14.4	3.9
60 2 1/4 2 3/8 2 7/16	2 3/4	9 1/2	2 3/4	7 1/4	25/32	31/32	7/8	5 7/16	3	3.063	1.220	5/8	NAP212-36 NAP212 NAP212-38 NAP212-39	P212	NA212-36 NA212 NA212-38 NA212-39	52.4	36.2	14.4	5.2
65 2 1/2	3	10 7/16	2 3/4	8	31/32	1 3/16	31/32	5 29/32	3 1/16	3.374	1.343	3/4	NAP213-40 NAP213	P213	NA213-40 NA213	57.2	40.1	14.4	6.5
70 2 3/4	3 1/8	10 15/32	2 27/32	8 9/32	31/32	1 3/16	1 3/32	6 5/32	3 1/16	3.374	1.343	3/4	NAP214-44 NAP214	P214	NA214-44 NA214	62.2	44.1	14.5	7.7
75 2 15/16	3 1/4	10 13/16	2 29/32	8 17/32	31/32	1 3/16	1 3/32	6 3/8	3 5/32	3.626	1.469	3/4	NAP215-47 NAP215	P215	NA215-47 NA215	67.4	48.3	14.5	7.9

Remarks 1. In Part No. of unit, fitting codes follow bore diameter numbers. (See Table 10.5 in P.42.)
 2. Part No. of applicable grease nipples are shown below.
 A-1/4-28UNF..... 201~210
 A-PT1/8..... 211~215

3. As for the triple seal type product (from 201 to 205 are the double seal type products), accessory code L3 (or L2) follows the Part No. of unit or bearing. (Example of Part No. : NAP206JL3, NA206L3)
 4. For the dimensions and forms of applicable bearings, see the dimensional tables of ball bearing for unit.
 5. Representative examples of the forms of housing are indicated.

NAPK
Cylindrical bore
(with eccentric locking collar)
d 12 ~ 75 mm

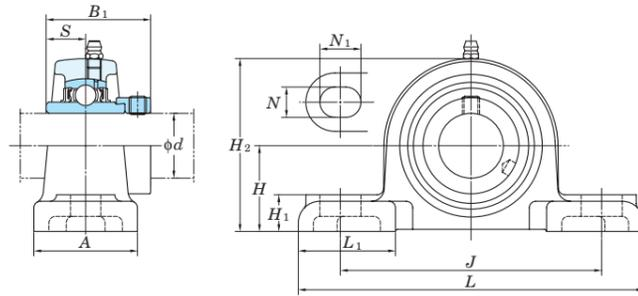

Variations of tolerance of distance from mounting bottom to center of spherical bore (ΔH_s)

Housing No.	ΔH_s
PK204~PK210	±0.15
PK211~PK215	±0.2

Shaft Dia mm <i>d</i>	inch	Dimensions inch mm											Bolt Size inch	Unit No.	Housing No.	Bearing No.	Basic Load Ratings kN		Factor f_0	Mass kg		
		<i>H</i>	<i>L</i>	<i>A</i>	<i>J</i>	<i>N</i>	<i>N</i> ₁	<i>H</i> ₁	<i>H</i> ₂	<i>L</i> ₁	<i>B</i> ₁	<i>S</i>					<i>C</i> _r	<i>C</i> _{0r}				
12	1/2														3/8	NAPK201 NAPK201-8 NAPK202 NAPK202-10 NAPK203 NAPK204-12 NAPK204	PK204	NA201 NA201-8 NA202 NA202-10 NA203 NA204-12 NA204	12.8	6.65	13.2	0.82
15	5/8	1 1/4	5 1/4	1 5/8	3 27/32	7/16	9/16	9/16	2 15/32	1 25/32	1.72	0.673										
17	3/4	31.8	133	41	98	11	14	14	63	45	43.7	17.1										
20	7/8													3/8	NAPK205-14 NAPK205-15 NAPK205 NAPK205-16	PK205	NA205-14 NA205-15 NA205 NA205-16	14.0	7.85	13.9	1	
25	15/16	1 5/16	5 1/2	1 23/32	4 1/8	7/16	9/16	5/8	2 11/16	1 25/32	1.748	0.689										
	1	33.3	140	44	105	11	14	16	68	45	44.4	17.5										
30	1 1/8													1/2	NAPK206-18 NAPK206 NAPK206-19 NAPK206-20	PK206	NA206-18 NA206 NA206-19 NA206-20	19.5	11.3	13.9	1.4	
	1 3/16	1 9/16	6 5/16	1 7/8	4 3/4	9/16	3/4	2 1/32	3 5/32	1 25/32	1.906	0.72										
	1 1/4	39.7	160	48	121	14	19	17	80	45	48.4	18.3										
35	1 1/4													1/2	NAPK207-20 NAPK207-21 NAPK207-22 NAPK207 NAPK207-23	PK207	NA207-20 NA207-21 NA207-22 NA207 NA207-23	25.7	15.4	13.9	2	
	1 5/16	1 13/16	6 9/16	1 7/8	5	9/16	3/4	3/4	3 5/8	1 25/32	2.012	0.74										
	1 3/8	46	167	48	127	14	19	19	92	45	51.1	18.8										
40	1 1/2													1/2	NAPK208-24 NAPK208-25 NAPK208	PK208	NA208-24 NA208-25 NA208	29.1	17.8	14.0	2.5	
	1 9/16	1 15/16	7 1/8	2 1/8	5 1/2	9/16	3/4	3/4	3 15/16	1 31/32	2.217	0.843										
	1 5/8	49.2	181	54	140	14	19	19	100	50	56.3	21.4										
45	1 5/8													1/2	NAPK209-26 NAPK209-27 NAPK209-28 NAPK209	PK209	NA209-26 NA209-27 NA209-28 NA209	34.1	21.3	14.0	2.7	
	1 11/16	2 1/16	7 15/32	2 1/8	5 3/4	9/16	3/4	25/32	4 3/16	2 1/16	2.217	0.843										
	1 3/4	52.4	190	54	146	14	19	20	106	52	56.3	21.4										
50	1 7/8													1/2	NAPK210-30 NAPK210-31 NAPK210 NAPK210-32	PK210	NA210-30 NA210-31 NA210 NA210-32	35.1	23.3	14.4	3.2	
	1 15/16	2 3/16	8	2 1/4	6 1/4	9/16	3/4	7/8	4 13/32	25/32	2.469	0.969										
	2	55.6	203	57	159	14	19	22	112	55	62.7	24.6										
55	2													5/8	NAPK211-32 NAPK211-34 NAPK211 NAPK211-35	PK211	NA211-32 NA211-34 NA211 NA211-35	43.4	29.4	14.4	4.6	
	2 1/8	2 7/16	9 1/8	2 3/8	7 1/8	23/32	15/16	3 1/32	4 7/8	2 19/32	2.811	1.094										
	2 3/16	61.9	232	60	181	18	24	25	124	66	71.4	27.8										
60	2 1/4													5/8	NAPK212-36 NAPK212 NAPK212-38 NAPK212-39	PK212	NA212-36 NA212 NA212-38 NA212-39	52.4	36.2	14.4	5.2	
	2 3/8	2 11/16	9 1/2	2 17/32	7 17/32	23/32	15/16	13/32	5 11/32	2 9/16	3.063	1.22										
	2 7/16	68.3	241	64	191	18	24	28	136	65	77.8	31										
75	2 15/16													3/4	NAPK215-47 NAPK215	PK215	NA215-47 NA215	67.4	48.3	14.5	9.6	
		84.1	304	82	241	22	32	38	165	87	92.1	37.3										

Remarks 1. In Part No. of unit and units with covers, fitting codes follow bore diameter numbers. (See Table 10.5 in P.42.)
 2. Part No. of applicable grease nipples are shown below.
 A-1/4-28UNF 201~210
 A-PT1/8 211~215

3. For the dimensions and forms of applicable bearings, see the dimensional tables of ball bearing for unit.
 4. Representative examples of the forms of housing are indicated.

Pillow type units

UKP
Tapered bore (with adapter)
d₁ 20 ~ (50) mm

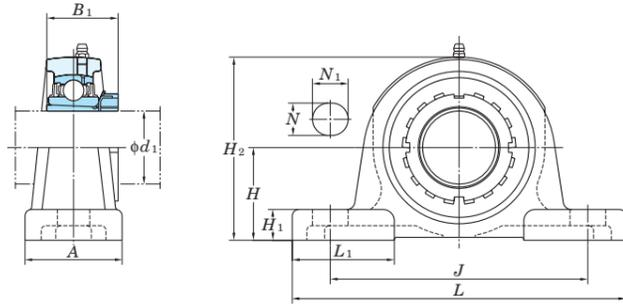

With Pressed Steel Cover

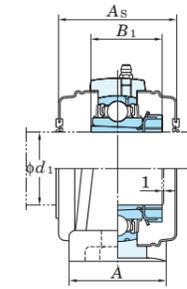

With Cast Iron Cover

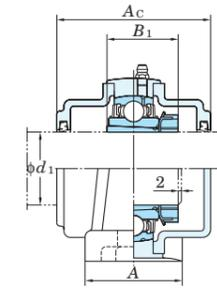

Variations of tolerance of distance from mounting bottom to center of spherical bore (ΔH_s)

Housing No.			ΔH_s
P205-P210	PX05-PX10	P305-P310	± 0.15
P211-P218	PX11-PX18	P311-P318	± 0.2
	PX20	P319-P328	± 0.3

Forms and dimensions of H_{2c} of P205JE3 (housing with cast iron cover) are shown below.

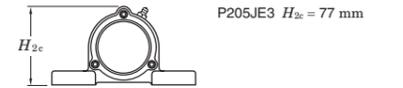

Shaft Dia. mm inch	Dimensions											Bolt Size inch mm	Standard			Adapter ¹⁾ No.	Mass kg	Basic			With Pressed Steel Cover				With Cast Iron Cover			
	inch mm												Unit No.	Housing No.	Bearing No.			Load Ratings kN	Factor	Unit No.		Dimension mm inch	Mass kg	Unit No.		Dimension mm inch	Mass kg	
d ₁	H	L	A	J	N	N ₁	H ₁	H ₂	L ₁	B ₁ ¹⁾					C _r	C _{0r}	f ₀	Open Type	One Side Closed Type	A _s		Open Type	One Side Closed Type	A _c				
20	3/4	1 7/16	5 1/2	1 1/2	4 1/8	1/2	23/32	1/2	2 25/32	1 11/16	1 5/32(1 3/8)	3/8	UKP205	P205	UK205													
		36.5	140	38	105	13	18	13	71	43	29(35)	M10																
	3/4	1 3/4	6 1/4	2	4 11/16	21/32	31/32	5/8	3 3/8	1 27/32	1 3/8	1/2	UKPX05	PX05	UKX05													
25	3/4	1 49/64	6 7/8	1 3/4	5 3/16	21/32	25/32	5/8	3 11/32	2 5/32	1 3/8	1/2	UKP305	P305	UK305													
		45	175	45	132	17	20	16	85	55	35	M14																
	1	1 11/16	6 1/2	1 7/8	4 3/4	21/32	13/16	19/32	3 5/16	2 3/32	1 7/32(1 1/2)	1/2	UKP206	P206	UK206													
30	1	1 7/8	6 7/8	2 1/4	5	21/32	31/32	21/32	3 21/32	2 5/32	1 1/2	1/2	UKPX06	PX06	UKX06													
		47.6	175	57	127	17	25	17	93	55	38	M14																
	1 1/8	1 7/8	6 9/16	1 7/8	5	21/32	13/16	5/8	3 21/32	2	1 3/8(1 11/16)	1/2	UKP207	P207	UK207													
35	1 1/8	2 1/8	8	2 1/4	5 11/16	21/32	1 9/16	3/4	4 1/8	2 17/32	1 11/16	1/2	UKPX07	PX07	UKX07													
		54	203	57	144	17	30	19	105	64	43	M14																
	1 1/8	2 13/64	8 9/32	2 7/32	6 5/16	21/32	31/32	3/4	4 7/32	2 9/16	1 11/16	1/2	UKP307	P307	UK307													
40	1 1/4	1 15/16	7 1/4	2 1/8	5 13/32	21/32	13/16	21/32	3 27/32	2 1/4	1 13/32(1 13/16)	1/2	UKP208	P208	UK208													
		49.2	184	54	137	17	21	17	98	57	36(46)	M14																
	1 1/4	2 5/16	8 3/4	2 5/8	6 1/8	25/32	1 1/4	13/16	4 1/2	2 25/32	1 13/16	5/8	UKPX08	PX08	UKX08													
45	1 3/8	2 23/64	8 21/32	2 3/8	6 11/16	21/32	1 1/16	3/4	4 21/32	2 9/16	1 13/16	1/2	UKP308	P308	UK308													
		60	220	60	170	17	27	19	118	65	46	M14																
	1 1/2	2 1/8	7 15/32	2 1/8	5 3/4	21/32	13/16	21/32	4 3/16	2 3/8	1 17/32(1 31/32)	1/2	UKP209	P209	UK209													
50	1 5/8	2 5/16	8 3/4	2 5/8	6 1/8	25/32	1 5/16	13/16	4 9/16	2 25/32	1 31/32	5/8	UKPX09	PX09	UKX09													
		58.7	222	67	156	20	33	21	116	71	50	M16																
	1 1/2	2 41/64	9 21/32	2 5/8	7 15/32	25/32	1 3/16	13/16	5 3/16	2 15/16	1 31/32	5/8	UKP309	P309	UK309													
55	1 5/8	2 67/64	10 13/16	2 15/16	8 11/32	25/32	1 3/8	15/16	5 13/16	3 15/32	2 5/32	5/8	UKP210	P210	UK210													
		67	245	67	190	20	30	21	132	75	50	M16																
	1 3/4	2 1/4	8 1/8	2 3/8	6 1/4	25/32	7/8	3/4	4 7/16	2 15/32	1 21/32(2 5/32)	5/8	UKPX10	PX10	UKX10													
60	1 3/4	2 1/2	9 1/2	2 7/8	6 23/32	25/32	1 13/32	7/8	4 31/32	3	2 5/32	5/8	UKP310	P310	UK310													
		63.5	241	73	171	20	36	22	126	76	55	M16																
	1 3/4	2 51/64	10 13/16	2 15/16	8 11/32	25/32	1 3/8	15/16	5 13/16	3 15/32	2 5/32	5/8	UKP211	P211	UK211													
65	1 7/8	2 1/2	8 5/8	2 3/8	6 23/32	25/32	7/8	3/4	4 29/32	2 3/4	1 25/32(2 5/16)	5/8	UKPX11	PX11	UKX11													
		63.5	219	60	171	20	22	19	125	70	45(59)	M16																
	2	2 1/2	8 5/8	2 3/8	6 23/32	25/32	7/8	3/4	4 29/32	2 3/4	1 25/32(2 5/16)	5/8	UKP211	P211	UK211													

Note 1) Codes shown in parentheses indicate the dimensions and Part No. of applicable adapter (H2300X series) for UK200L3 series (triple seal type).

Remarks 1. In Part No. of unit and units with covers, fitting codes follow bore diameter numbers. (See Table 10.5 in P.42.)

2. Part No. of applicable grease nipples are shown below.
A-1/4-28UNF.....205-210, X05-X09, 305-308
A-PT1/8.....211-218, X10-X20, 309-328

3. In Part No. of unit with adapters and bearing with adapters, Part No. of applicable adapter follow the Part No. shown in the dimensional tables. (Example of Part No. : UKP206J + H306X, UK206 + H306X)
4. As for the triple seal type product (205 is the double seal type product), accessory code L3 (or L2) follows the Part No. of unit or bearing.
5. For the dimensions and forms of applicable bearings and adapters, see the dimensional tables of ball bearing for unit and adapter.
6. Representative examples of the forms of housing are indicated.

Pillow type units

UKP
Tapered bore (with adapter)
 d_1 90 ~ 125 mm

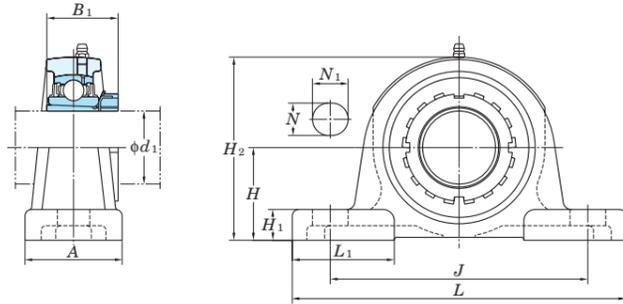

With Pressed Steel Cover

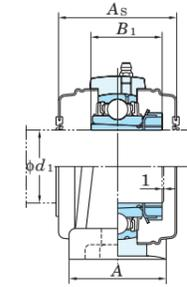

With Cast Iron Cover

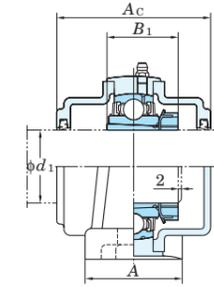

Variations of tolerance of distance from mounting bottom to center of spherical bore (ΔH_s)

Housing No.			Unit : mm
P205~P210	PX05~PX10	P305~P310	± 0.15
P211~P218	PX11~PX18	P311~P318	± 0.2
	PX20	P319~P328	± 0.3

Forms and dimensions of H_{2c} of P205JE3 (housing with cast iron cover) are shown below.



Shaft Dia. mm inch	Dimensions inch mm											Bolt Size inch mm	Standard			Adapter ¹⁾ No.	Mass kg	Basic Load Ratings kN		Factor f_0	With Pressed Steel Cover			With Cast Iron Cover				
	d_1	H	L	A	J	N	N_1	H_1	H_2	L_1	$B_1^{1)}$		Unit No.	Housing No.	Bearing No.			Unit No.	Dimension mm inch		Mass kg	Unit No.	Dimension mm inch	Mass kg				
90 3 1/2	5	17	4 3/4	13 1/4	1 5/16	2 9/16	1 25/32	9 21/32	4 31/32	3 13/16	1	UKPX20	PX20	UKX20	HE2320X	29.3	133	105	14.4	-	-	-	-	-	-	-	-	-
	127	432	121	337	33	65	45	245	126	97	M27				H2320X	29.3							UKPX20C	UKPX20CD	186	7 5/16	34.3	
100 4	5 33/64	19 9/32	4 23/32	14 31/32	1 13/32	1 31/32	1 13/16	10 3/4	5 1/2	3 13/16	1 1/8	UKP320	P320	UK320	HE2320X	34.8	173	141	13.2	-	-	-	-	-	-	-	-	
	140	490	120	380	36	50	46	273	140	97	M30				H2320X	34.8							UKP320C	UKP320CD	174	6 27/32	41.0	
110 -	5 29/32	20 15/32	5 1/2	15 3/4	1 9/16	2 5/32	1 31/32	11 21/32	5 29/32	4 1/8	1 1/4	UKP322	P322	UK322	H2322X	43.9	205	180	13.2	-	-	-	-	-	-	-	-	
	150	520	140	400	40	55	50	296	150	105	M33				HE2322X	43.9							UKP322C	UKP322CD	188	7 13/32	50.8	
115 4 1/2	6 19/64	22 7/16	5 1/2	17 23/32	1 9/16	2 5/32	1 31/32	12 7/16	6 5/16	4 13/32	1 1/4	UKP324	P324	UK324	H2324	55.7	207	185	13.5	-	-	-	-	-	-	-	-	
	160	570	140	450	40	55	50	316	160	112	M33				H2324	55.7							UKP324C	UKP324CD	196	7 23/32	66.0	
125 -	7 3/32	23 5/8	5 1/2	18 29/32	1 9/16	2 5/32	1 31/32	13 21/32	7 11/16	4 3/4	1 1/4	UKP326	P326	UK326	HE2326	71.9	229	214	13.6	-	-	-	-	-	-	-	-	
	180	600	140	480	40	55	50	355	195	121	M33				H2326	71.9							UKP326C	UKP326CD	214	8 7/16	85.2	
125 -	7 7/8	24 13/32	5 1/2	19 11/16	1 9/16	2 5/32	2 3/8	15 15/32	7 9/32	5 5/32	1 1/4	UKP328	P328	UK328	H2328	92.5	253	246	13.6	-	-	-	-	-	-	-	-	
	200	620	140	500	40	55	60	393	185	131	M33				H2328	92.5							UKP328C	UKP328CD	222	8 3/4	109	

Note 1) Codes shown in parentheses indicate the dimensions and Part No. of applicable adapter (H2300X series) for UK200L3 series (triple seal type).

Remarks 1. In Part No. of unit and units with covers, fitting codes follow bore diameter numbers. (See Table 10.5 in P.42.)

2. Part No. of applicable grease nipples are shown below.

A-1/4-28UNF.....205~210, X05~X09, 305~308
A-PT1/8.....211~218, X10~X20, 309~328

3. In Part No. of unit with adapters and bearing with adapters, Part No. of applicable adapter follow the Part No. shown in the dimensional tables.

(Example of Part No. : UKP206J + H306X, UK206 + H306X)

4. As for the triple seal type product (205 is the double seal type product), accessory code L3 (or L2) follows the Part No. of unit or bearing.

5. For the dimensions and forms of applicable bearings and adapters, see the dimensional tables of ball bearing for unit and adapter.

6. Representative examples of the forms of housing are indicated.

Pillow type units

UCP-SC
Cylindrical bore (with set screws),
cast steel housing
d 25 ~ 70 mm

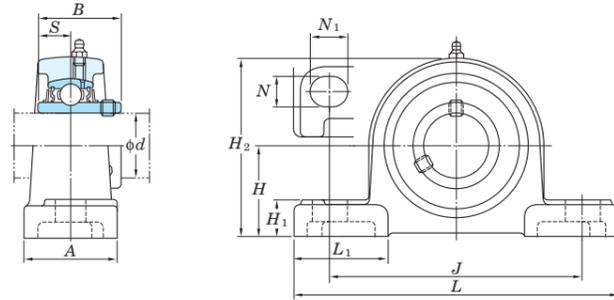

With Cast Iron Cover

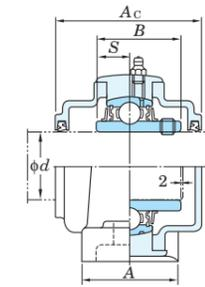

Variations of tolerance of distance from mounting bottom to center of spherical bore (ΔH_s)

Housing No.		Unit : mm
P205SC-P210SC	P310SC	±0.15
P211SC-P218SC	P311SC-P318SC	±0.2
	P319SC-P328SC	±0.3

Shaft Dia. mm inch d	Dimensions inch mm												Bolt Size inch mm	Standard			Mass kg	Basic Load Ratings kN		Factor f_0	With Cast Iron Cover						
	H	L	A	J	N	N ₁	H ₁	H ₂	L ₁	B	S	Unit No.		Housing No.	Bearing No.	C _r		C _{0r}	Open Type		One Side Closed Type	Dimension mm inch A _c	Mass kg				
25 7/8 15/16 1	1 7/16	5 1/2	1 1/2	4 1/8	1/2	23/32	5/8	2 25/32	1 11/16	1.343	0.563	3/8	UCP205-14SC	P205SC	UC205-14	0.90	14.0	7.85	13.9	-	-	-	-				
	36.5	140	38	105	13	18	16	71	43	34.1	14.3	M10	UC205-15		UC205					-	-	-	-	-	-		
													UCP205-16SC		UC205-16					-	-	-	-	-	-	-	-
													UCP205-15SC		UC205-15					-	-	-	-	-	-	-	-
30 1 1/8 1 3/16 1 1/4	1 11/16	6 1/2	1 7/8	4 3/4	21/32	13/16	23/32	3 3/8	2 3/32	1.500	0.626	1/2	UCP206-18SC	P206SC	UC206-18	1.5	19.5	11.3	13.9	-	-	-	-				
	42.9	165	48	121	17	21	18	86	53	38.1	15.9	M14	UC206		UCP206SCFC					UCP206SCFCD	70	2 3/4	2.0				
													UCP206-19SC		UC206-19					-	-	-	-	-	-	-	-
													UCP206-20SC		UC206-20					-	-	-	-	-	-	-	-
35 1 1/4 1 5/16 1 3/8 1 7/16	1 7/8	6 9/16	1 7/8	5	21/32	13/16	3/4	3 25/32	2	1.689	0.689	1/2	UCP207-20SC	P207SC	UC207-20	1.9	25.7	15.4	13.9	-	-	-	-				
	47.6	167	48	127	17	21	19	96	51	42.9	17.5	M14	UC207-21		UC207-21					-	-	-	-	-	-		
													UCP207-21SC		UC207-22					-	-	-	-	-	-	-	-
													UCP207-22SC		UC207					UCP207SCFC	UCP207SCFCD	78	3 1/16	2.6			
40 1 1/2 1 9/16	1 15/16	7 1/4	2 1/8	5 13/32	21/32	13/16	3/4	3 15/16	2 1/4	1.937	0.748	1/2	UCP207-23SC	P208SC	UC207-23	1.9	29.1	17.8	14.0	-	-	-	-				
	49.2	184	54	137	17	21	19	100	57	49.2	19	M14	UC208-24		UC208-24					-	-	-	-	-	-		
													UCP208-24SC		UC208-25					-	-	-	-	-	-	-	-
													UCP208SC		UC208					UCP208SCFC	UCP208SCFCD	86	3 3/8	3.1			
45 1 5/8 1 11/16 1 3/4	2 1/8	7 15/32	2 1/8	5 3/4	21/32	13/16	25/32	4 1/4	2 3/8	1.937	0.748	1/2	UCP209-26SC	P209SC	UC209-26	2.5	34.1	21.3	14.0	-	-	-	-				
	54	190	54	146	17	21	20	108	60	49.2	19	M14	UC209-27		UC209-27					-	-	-	-	-	-		
													UCP209-27SC		UC209-28					-	-	-	-	-	-	-	-
													UCP209-28SC		UC209					UCP209SCFC	UCP209SCFCD	88	3 15/32	3.3			
50 1 7/8 1 15/16 2	2 1/4	8 1/8	2 3/8	6 1/4	25/32	7/8	7/8	4 17/32	2 15/32	2.031	0.748	5/8	UCP210-30SC	P210SC	UC210-30	3.2	35.1	23.3	14.4	-	-	-	-				
	57.2	206	60	159	20	22	22	115	63	51.6	19	M16	UC210-31		UC210-31					-	-	-	-	-	-		
													UCP210-31SC		UC210					UCP210SCFC	UCP210SCFCD	97	3 13/16	4.2			
													UCP210SC		UC210-32					-	-	-	-	-	-	-	
55 2 2 1/8 2 3/16	2 5/16	10 13/16	2 15/16	8 11/32	25/32	1 3/8	1 1/16	5 13/16	3 15/32	2.402	0.866	5/8	UCP210-32SC	P310SC	UC310	9.2	62.0	38.3	13.2	UCP310SCC	UCP310SCCD	110	4 11/32	10.8			
	75	275	75	212	20	35	27	148	88	61	22	M16	UCP211-32SC		UC211-32					-	-	-	-	-	-		
													UCP211-34SC		UC211-34					-	-	-	-	-	-	-	-
													UCP211SC		UC211					UCP211SCFC	UCP211SCFCD	99	3 29/32	5.2			
60 2 1/4 2 3/8 2 7/16	3 5/32	12 7/32	3 5/32	9 9/32	25/32	1 1/2	1 3/16	6 7/32	3 17/32	2.598	0.984	5/8	UCP211-35SC	P311SC	UC311	10.9	71.6	45.0	13.2	UCP311SCC	UCP311SCCD	114	4 1/2	12.7			
	80	310	80	236	20	38	30	158	90	66	25	M16	UCP212-36SC		UC212-36					-	-	-	-	-	-		
													UCP212SC		UC212					UCP212SCFC	UCP212SCFCD	114	4 1/2	6.7			
													UCP212-38SC		UC212-38					-	-	-	-	-	-	-	
65 2 1/2 2 1/2	3 11/32	13	3 11/32	9 27/32	31/32	1 1/2	1 1/4	6 5/8	4 1/16	2.795	1.024	3/4	UCP212-39SC	P312SC	UC312	12.6	81.9	52.2	13.2	UCP312SCC	UCP312SCCD	124	4 7/8	14.9			
	85	330	85	250	25	38	32	168	103	71	26	M20	UCP213-40SC		UC213-40					-	-	-	-	-	-		
													UCP213SC		UC213					UCP213SCFC	UCP213SCFCD	114	4 1/2	8.1			
													UCP213-40SC		UC313-40					-	-	-	-	-	-	-	
70 2 3/4 2 3/4	3 35/64	13 3/8	3 17/32	10 1/4	31/32	1 1/2	1 3/8	7	4 11/32	2.953	1.181	3/4	UCP313SC	P313SC	UC313	14.2	92.7	59.9	13.2	UCP313SCC	UCP313SCCD	122	4 13/16	16.3			
	90	340	90	260	25	38	35	178	110	75	30	M20	UCP214-44SC		UC214-44					-	-	-	-	-	-		
													UCP214SC		UC214					UCP214SCFC	UCP214SCFCD	124	4 7/8	9.0			
													UCP214-44SC		UC314-44					-	-	-	-	-	-	-	
70 2 3/4	3 47/64	14 3/16	3 17/32	11 1/32	1 1/16	1 9/16	1 1/2	7 13/32	4 11/32	3.071	1.299	7/8	UCP314SC	P314SC	UC314	14.9	104	68.2	13.2	UCP314SCC	UCP314SCCD	124	4 7/8	17.2			
	95	360	90	280	27	40	38	188	110	78	33	M22	UCP314SC		UC314					-	-	-	-	-	-		

Remarks 1. In Part No. of unit and units with covers, fitting codes follow bore diameter numbers. (See Table 10.5 in P.42.)

2. Part No. of applicable grease nipples are shown below.

A-1/4-28UNF..... 205~210

A-PT1/8..... 211~218, 310~328

3. As for the triple seal type product (205 is the double seal type product), accessory code L3 (or L2) follows the Part No. of unit or bearing.

(Example of Part No. : UCP206JSL3, UC206L3)

4. For the dimensions and forms of applicable bearings and adapters, see the dimensional tables of ball bearing for unit.

Pillow type units

UCP-SC
Cylindrical bore (with set screws),
cast steel housing
d 75 ~ 140 mm

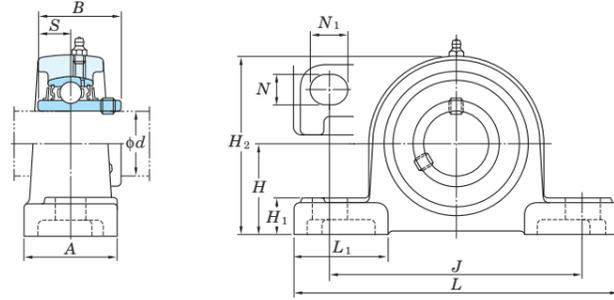

With Cast Iron Cover

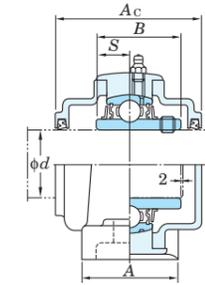

Variations of tolerance of distance from mounting bottom to center of spherical bore (ΔH_s) Unit : mm

Housing No.		ΔH_s
P205SC-P210SC	P310SC	±0.15
P211SC-P218SC	P311SC-P318SC	±0.2
	P319SC-P328SC	±0.3

Shaft Dia. mm inch d	Dimensions inch mm												Bolt Size inch mm	Standard			Mass kg	Basic Load Ratings kN		Factor f ₀	With Cast Iron Cover			
	H	L	A	J	N	N ₁	H ₁	H ₂	L ₁	B	S	Unit No.		Housing No.	Bearing No.	C _r		C _{0r}	Unit No.		Dimension mm inch	Mass kg		
75 2 15/16 3	3 1/4	10 13/16	2 29/32	8 17/32	3 1/32	1 3/16	1 5/32	6 15/32	3 5/32	3.063	1.311	3/4	UCP215-47SC	P215SC	UC215-47	7.7			-	-	-			
	82.6	275	74	217	25	30	29	164	80	77.8	33.3	M20	UCP215SC		UC215	7.7	67.4	48.3	14.5	UCP215SCFC	UCP215SCFCD	124 4 7/8	9.6	
													UCP215-48SC		UC215-48	7.7				-	-	-		
75 2 15/16 3	3 15/16	14 31/32	3 15/16	11 13/32	1 1/16	1 9/16	1 1/2	7 7/8	4 7/32	3.228	1.260	7/8	UCP315-47SC	P315SC	UC315-47	20.7				-	-	-		
	100	380	100	290	27	40	38	200	107	82	32	M22	UCP315SC		UC315	20.7	113	77.2	13.2	UCP315SCC	UCP315SCCD	134 5 9/32	23.2	
													UCP315-48SC		UC315-48	20.7				-	-	-		
80 3 1/8	3 1/2	11 1/2	3 1/16	9 1/8	3 1/32	1 3/8	1 7/32	6 15/16	3 3/8	3.252	1.311	3/4	UCP216-50SC	P216SC	UC216-50	9.3				-	-	-		
	88.9	292	78	232	25	35	31	176	86	82.6	33.3	M20	UCP216SC		UC216	9.3	72.7	53.0	14.6	UCP216SCFC	UCP216SCFCD	138 5 7/16	11.7	
80 -	4 11/64	15 3/4	4 11/32	11 13/16	1 1/16	1 9/16	1 1/2	8 5/16	4 23/32	3.386	1.339	7/8	UCP316SC	P316SC	UC316	24.2	123	86.7	13.3	UCP316SCC	UCP316SCCD	138 5 7/16	27.1	
	106	400	110	300	27	40	38	211	120	86	34	M22								-	-	-		
																					-	-	-	
85 3 1/4	3 3/4	12 7/32	3 9/32	9 23/32	3 1/32	1 9/16	1 5/16	7 13/32	3 17/32	3.374	1.343	3/4	UCP217-52SC	P217SC	UC217-52	11.7				-	-	-		
	95.2	310	83	247	25	40	33	188	90	85.7	34.1	M20	UCP217SC		UC217	11.7	84.0	61.9	14.5	UCP217SCFC	UCP217SCFCD	142 5 19/32	14.4	
													UCP317SC	P317SC	UC317	28.4	133	96.8	13.3	UCP317SCC	UCP317SCCD	146 5 3/4	31.7	
85 -	4 13/32	16 17/32	4 11/32	12 19/32	1 5/16	1 25/32	1 25/32	8 3/4	4 23/32	3.780	1.575	1								-	-	-		
	112	420	110	320	33	45	45	222	120	96	40	M27									-	-	-	
																					-	-	-	
90 3 1/2	4	12 7/8	3 15/32	10 5/16	1 1/16	1 25/32	1 3/8	7 7/8	4 3/32	3.780	1.563	7/8	UCP218-56SC	P218SC	UC218-56	13.5				-	-	-		
	101.6	327	88	262	27	45	35	200	104	96	39.7	M22	UCP218SC		UC218	13.5	96.1	71.5	14.5	UCP218SCFC	UCP218SCFCD	152 6	16.6	
													UCP318-56SC	P318SC	UC318-56	30.9	143	107	13.3	-	-	-		
90 3 1/2	4 41/64	16 15/16	4 11/32	13	1 5/16	1 25/32	1 25/32	9 7/32	4 23/32	3.780	1.575	1	UCP318-56SC		UC318-56	30.9				-	-	-		
	118	430	110	330	33	45	45	234	120	96	40	M27	UCP318SC		UC318	30.9	143	107	13.3	UCP318SCC	UCP318SCCD	150 5 29/32	34.7	
																					-	-	-	
95 -	4 59/64	18 1/2	4 23/32	14 3/16	1 13/32	1 31/32	2	9 3/4	4 29/32	4.055	1.614	1 1/8	UCP319SC	P319SC	UC319	37.9	153	119	13.3	UCP319SCC	UCP319SCCD	162 6 3/8	42.2	
	125	470	120	360	36	50	51	248	125	103	41	M30									-	-	-	
100 3 15/16 4	5 33/64	19 9/32	4 23/32	14 31/32	1 13/32	1 31/32	2	10 3/4	5 1/2	4.252	1.654	1 1/8	UCP320SC	P320SC	UC320	45.2				-	-	-		
	140	490	120	380	36	50	51	273	140	108	42	M30	UCP320-63SC		UC320-63	45.2	173	141	13.2	-	-	-		
													UCP320-64SC		UC320-64	45.2				-	-	-		
110 -	5 29/32	20 15/32	5 1/2	15 3/4	1 9/16	2 5/32	2 1/4	11 21/32	5 29/32	4.606	1.811	1 1/4	UCP322SC	P322SC	UC322	53.1	205	180	13.2	UCP322SCC	UCP322SCCD	188 7 13/32	59.9	
	150	520	140	400	40	55	57	296	150	117	46	M33									-	-	-	
120 -	6 19/64	22 7/16	5 1/2	17 23/32	1 9/16	2 5/32	2 1/4	12 7/16	6 5/16	4.961	2.008	1 1/4	UCP324SC	P324SC	UC324	69.0	207	185	13.5	UCP324SCC	UCP324SCCD	196 7 23/32	78.5	
	160	570	140	450	40	55	57	316	160	126	51	M33									-	-	-	
130 -	7 3/32	23 5/8	5 1/2	18 29/32	1 9/16	2 5/32	2 1/4	13 21/32	7 11/16	5.315	2.126	1 1/4	UCP326SC	P326SC	UC326	85.6	229	214	13.6	UCP326SCC	UCP326SCCD	214 8 7/16	97.7	
	180	600	140	480	40	55	57	355	195	135	54	M33									-	-	-	
140 -	7 7/8	24 13/32	5 1/2	19 11/16	1 9/16	2 5/32	2 3/4	15 15/32	7 9/32	5.709	2.323	1 1/4	UCP328SC	P328SC	UC328	114	253	246	13.6	UCP328SCC	UCP328SCCD	222 8 3/4	129	
	200	620	140	500	40	55	70	393	185	145	59	M33									-	-	-	

Remarks 1. In Part No. of unit and units with covers, fitting codes follow bore diameter numbers. (See Table 10.5 in P.42.)
2. Part No. of applicable grease nipples are shown below.
A-1/4-28UNF 205~210
A-PT1/8 211~218, 310~328

3. As for the triple seal type product (205 is the double seal type product), accessory code L3 (or L2) follows the Part No. of unit or bearing.
(Example of Part No. : UCP206JSCL3, UC206L3)
4. For the dimensions and forms of applicable bearings and adapters, see the dimensional tables of ball bearing for unit.

Pillow type units

UKP-SC
Tapered bore (with adapter),
cast steel housing
d₁ 20 ~ 75 mm

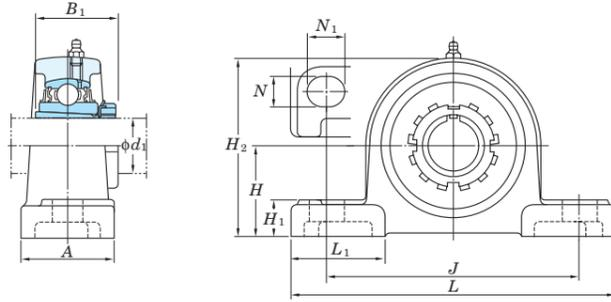

With Cast Iron Cover

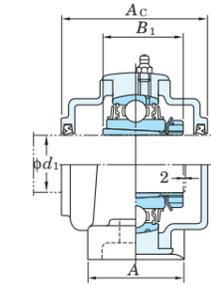

Variations of tolerance of distance from mounting bottom to center of spherical bore (ΔH_s)

Housing No.		Unit : mm
P205SC-P210SC	P310SC	±0.15
P211SC-P218SC	P311SC-P318SC	±0.2
	P319SC-P328SC	±0.3

Shaft Dia. mm inch	Dimensions inch mm											Bolt Size inch mm	Standard			Adapter ¹⁾ No.	Mass kg	Basic Load Ratings kN		Factor f ₀	With Cast Iron Cover			
	H	L	A	J	N	N ₁	H ₁	H ₂	L ₁	B ₁ ¹⁾	Unit No.		Housing No.	Bearing No.	Unit No.			Dimension mm inch	Mass kg					
20 3/4	1 7/16	5 1/2	1 1/2	4 1/8	1/2	23/32	5/8	2 25/32	1 11/16	1 5/32(1 3/8)	3/8	M10	UKP205SC	P205SC	UK205	HE305X(HE2305X) H305X(H2305X)	1.0 1.0	14.0 7.85	13.9	-	-	-		
	36.5	140	38	105	13	18	16	71	43	29(35)														
25 1	1 11/16	6 1/2	1 7/8	4 3/4	21/32	13/16	23/32	3 3/8	2 3/32	1 7/32(1 1/2)	1/2	M14	UKP206SC	P206SC	UK206	H306X(H2306X) HE306X(HE2306X)	1.6 1.6	19.5 11.3	13.9	UKP206SCFC	UKP206SCFCD	70	2 3/4	2.1
	42.9	165	48	121	17	21	18	86	53	31(38)														
30 1 1/8	1 7/8	6 9/16	1 7/8	5	21/32	13/16	3/4	3 25/32	2	1 3/8(1 11/16)	1/2	M14	UKP207SC	P207SC	UK207	HS307X(HS2307X) H307X(H2307X)	2.1 2.1	25.7 15.4	13.9	UKP207SCFC	UKP207SCFCD	78	3 1/16	2.8
	47.6	167	48	127	17	21	19	96	51	35(43)														
35 1 3/8	1 15/16	7 1/4	2 1/8	5 13/32	21/32	13/16	3/4	3 15/16	2 1/4	1 13/32(1 13/16)	1/2	M14	UKP208SC	P208SC	UK208	HE308X(HE2308X) HS308X(HS2308X) H308X(H2308X)	2.4 2.4 2.4	29.1 17.8	14.0	UKP208SCFC	UKP208SCFCD	86	3 3/8	3.2
	49.2	184	54	137	17	21	19	100	57	36(46)														
40 1 1/2	2 1/8	7 15/32	2 1/8	5 3/4	21/32	13/16	25/32	4 1/4	2 3/8	1 17/32(2 31/32)	1/2	M14	UKP209SC	P209SC	UK209	HE309X(HE2309X) H309X(H2309X) HS309X(HS2309X)	2.7 2.7 2.7	34.1 21.3	14.0	UKP209SCFC	UKP209SCFCD	88	3 15/32	3.5
	54	190	54	146	17	21	20	108	60	39(50)														
45 1 3/4	2 1/4	8 1/8	2 3/8	6 1/4	25/32	7/8	7/8	4 17/32	2 15/32	1 21/32(2 5/32)	5/8	M16	UKP210SC	P210SC	UK210	HE310X(HE2310X) H310X(H2310X)	3.3 3.3	35.1 23.3	14.4	UKP210SCFC	UKP210SCFCD	97	3 13/16	4.3
	57.2	206	60	159	20	22	22	115	63	42(55)														
50 1 7/8	2 5/8	10 13/16	2 15/16	8 11/32	25/32	1 3/8	1 1/16	5 13/16	3 15/32	2 5/32	5/8	M16	UKP310SC	P310SC	UK310	HE2310X H2310X	9.3 9.3	62.0 38.3	13.2	UKP310SCC	UKP310SCCD	110	4 11/32	11.0
	75	275	75	212	20	35	27	148	88	55														
55 2 1/8	2 1/2	8 5/8	2 3/8	6 23/32	25/32	7/8	15/16	5	2 3/4	1 25/32(2 5/16)	5/8	M16	UKP211SC	P211SC	UK211	HS311X(HS2311X) H311X(H2311X) HE311X(HE2311X)	4.2 4.2 4.2	43.4 29.4	14.4	UKP211SCFC	UKP211SCFCD	99	3 29/32	5.4
	63.5	219	60	171	20	22	24	127	70	45(59)														
60 2 3/8	3 5/32	12 7/32	3 5/32	9 9/32	25/32	1 1/2	1 3/16	6 7/32	3 17/32	2 5/16	5/8	M16	UKP311SC	P311SC	UK311	HS2311X H2311X HE2311X	11.2 11.2 11.2	71.6 45.0	13.2	UKP311SCC	UKP311SCCD	114	4 1/2	13.1
	80	310	80	236	20	38	30	158	90	59														
65 2 1/2	2 3/4	9 1/2	2 3/4	7 1/4	25/32	31/32	31/32	5 15/32	3	1 27/32(2 7/16)	5/8	M16	UKP212SC	P212SC	UK212	HS312X(HS2312X) H312X(H2312X)	5.1 5.1	52.4 36.2	14.4	UKP212SCFC	UKP212SCFCD	114	4 1/2	6.6
	69.8	241	70	184	20	25	25	139	76	47(62)														
70 2 3/4	3 11/32	13	3 11/32	9 27/32	31/32	1 1/2	1 1/4	6 5/8	4 1/16	2 7/16	3/4	M20	UKP312SC	P312SC	UK312	HS2312X H2312X	12.5 12.5	81.9 52.2	13.2	UKP312SCC	UKP312SCCD	124	4 7/8	14.9
	85	330	85	250	25	38	32	168	103	62														
75 2 3/4	3	10 7/16	2 3/4	8	31/32	1 3/16	1 3/32	5 15/16	3 1/16	1 31/32(2 9/16)	3/4	M20	UKP213SC	P213SC	UK213	HE313X(HE2313X) H313X(H2313X) HS313X(HS2313X)	6.3 6.3 6.3	57.2 40.1	14.4	UKP213SCFC	UKP213SCFCD	114	4 1/2	8.0
	76.2	265	70	203	25	30	28	151	78	50(65)														
80 2 3/8	3 35/64	13 3/8	3 17/32	10 1/4	31/32	1 1/2	1 3/8	7	4 11/32	2 9/16	3/4	M20	UKP313SC	P313SC	UK313	HE2313X H2313X HS2313X	14.3 14.3 14.3	92.7 59.9	13.2	UKP313SCC	UKP313SCCD	122	4 13/16	16.5
	90	340	90	260	25	38	35	178	110	65														
85 2 1/2	3 1/4	10 13/16	2 29/32	8 17/32	31/32	1 3/16	1 5/32	6 15/32	3 5/32	2 5/32(2 7/8)	3/4	M20	UKP215SC	P215SC	UK215	HE315X(HE2315X) H315X(H2315X)	7.9 7.9	67.4 48.3	14.5	UKP215SCFC	UKP215SCFCD	124	4 7/8	9.8
	82.6	275	74	217	25	30	29	164	80	55(73)														
90 2 1/2	3 15/16	14 31/32	3 15/16	11 13/32	1 1/16	1 9/16	1 1/2	7 7/8	4 7/32	2 7/8	7/8	M22	UKP315SC	P315SC	UK315	HE2315X H2315X	20.9 20.9	113 77.2	13.2	UKP315SCC	UKP315SCCD	134	5 9/32	23.7
	100	380	100	290	27	40	38	200	107	73														
95 2 3/4	3 1/2	11 1/2	3 1/16	9 1/8	31/32	1 3/8	1 7/32	6 15/16	3 3/8	2 5/16(3 1/16)	3/4	M20	UKP216SC	P216SC	UK216	HE316X(HE2316X) H316X(H2316X)	9.6 9.6	72.7 53.0	14.6	UKP216SCFC	UKP216SCFCD	138	5 7/16	12.0
	88.9	292	78	232	25	35	31	176	86	59(78)														
100 2 3/4	4 11/64	15 3/4	4 11/32	11 13/16	1 1/16	1 9/16	1 1/2	8 5/16	4 23/32	3 1/16	7/8	M22	UKP316SC	P316SC	UK316	HE2316X H2316X	24.2 24.2	123 86.7	13.3	UKP316SCC	UKP316SCCD	138	5 7/16	27.3
	106	400	110	300	27	40	38	211	120	78														
105 3	3 3/4	12 7/32	3 9/32	9 23/32	31/32	1 9/16	1 5/16	7 13/16	3 17/32	2 15/32(3 7/32)	3/4	M20	UKP217SC	P217SC	UK217	H317X(H2317X) HE317X(HE2317X)	12.0 12.0	84.0 61.9	14.5	UKP217SCFC	UKP217SCFCD	142	5 19/32	14.7
	95.2	310	83	247	25	40	33	188	90	63(82)														
110 3	4 13/32	16 17/32	4 11/32	12 19/32	1 5/16	1 25/32	1 25/32	8 3/4	4 23/32	3 7/32	1	M27	UKP317SC	P317SC	UK317	H2317X HE2317X	28.3 28.3	133 96.8	13.3	UKP317SCC	UKP317SCCD	146	5 3/4	31.8
	112	420	110	320	33	45	45	222	120	82														

Note 1) Codes shown in parentheses indicate the dimensions and Part No. of applicable adapter (H2300X series) for UK200L3 series (triple seal type).

Remarks 1. In Part No. of unit and units with covers, fitting codes follow bore diameter numbers. (See Table 10.5 in P.42.)

2. Part No. of applicable grease nipples are shown below.
A-1/4-28UNF.....205~210
A-PT1/8.....211~218, 310~328

3. In Part No. of unit with adapters and bearing with adapters, Part No. of applicable adapter follow the Part No. shown in the dimensional tables.

(Example of Part No. : UKP206JSC + H306X, UK206 + H306X)

4. As for the triple seal type product (205 is the double seal type product), accessory code L3 (or L2) follows the Part No. of unit or bearing.

(Example of Part No. : UKP206JL3 + H2306X, UK206L3 + H2306X)

5. For the dimensions and forms of applicable bearings and adapters, see the dimensional tables of ball bearing for unit and adapter.

Pillow type units

UKP-SC
Tapered bore (with adapter),
cast steel housing
*d*₁ 80 ~ 125 mm

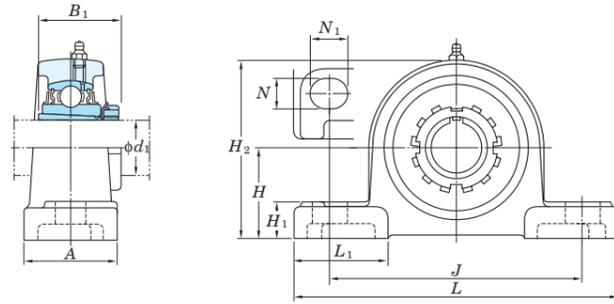

With Cast Iron Cover

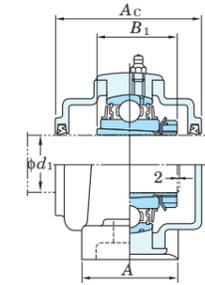

Variations of tolerance of distance from mounting bottom to center of spherical bore (ΔH_s)

Housing No.		ΔH_s
P205SC-P210SC	P310SC	±0.15
P211SC-P218SC	P311SC-P318SC	±0.2
	P319SC-P328SC	±0.3

Shaft Dia. mm inch	Dimensions inch mm											Bolt Size inch mm	Standard			Adapter ¹⁾ No.	Mass kg	Basic Load Ratings kN		Factor <i>f</i> ₀	With Cast Iron Cover				
	<i>H</i>	<i>L</i>	<i>A</i>	<i>J</i>	<i>N</i>	<i>N</i> ₁	<i>H</i> ₁	<i>H</i> ₂	<i>L</i> ₁	<i>B</i> ₁ ¹⁾	Unit No.		Housing No.	Bearing No.	<i>C</i> _r			<i>C</i> _{0r}	Unit No. Open Type		Unit No. One Side Closed Type	Dimension mm inch	Mass kg		
80	4	12 7/8	3 15/32	10 5/16	1 1/16	1 25/32	1 3/8	7 7/8	4 3/32	2 9/16(3 3/8)	7/8	UKP218SC	P218SC	UK218		H318X(H2318X)	15.3	96.1	71.5	14.5	UKP218SCFC	UKP218SCFCD	152 6	18.4	
	4 41/64	16 15/16	4 11/32	13	1 5/16	1 25/32	1 25/32	9 7/32	4 23/32	3 3/8	1	UKP318SC	P318SC	UK318		H2318X	31.0	143	107	13.3	UKP318SCC	UKP318SCCD	150 5 29/32	35.2	
85	3 1/4	18 1/2	4 23/32	14 3/16	1 13/32	1 31/32	2	9 3/4	4 29/32	3 17/32	1 1/8	UKP319SC	P319SC	UK319		HE2319X H2319X	38.2 38.2	153	119	13.3	UKP319SCC	UKP319SCCD	162 6 3/8	42.9	
	5 33/64	19 9/32	4 23/32	14 31/32	1 13/32	1 31/32	2	10 3/4	5 1/2	3 13/16	1 1/8	UKP320SC	P320SC	UK320		HE2320X H2320X	44.9 44.9	173	141	13.2	UKP320SCC	UKP320SCCD	174 6 27/32	51.1	
100	5 29/32	20 15/32	5 1/2	15 3/4	1 9/16	2 5/32	2 1/4	11 21/32	5 29/32	4 1/8	1 1/4	UKP322SC	P322SC	UK322		H2322X HE2322X	53.0 53.0	205	180	13.2	UKP322SCC	UKP322SCCD	188 7 13/32	59.9	
	150	520	140	400	40	55	57	296	150	105	M33	UKP324SC	P324SC	UK324		H2324	69.3	207	185	13.5	UKP324SCC	UKP324SCCD	196 7 23/32	79.6	
110	6 19/64	22 7/16	5 1/2	17 23/32	1 9/16	2 5/32	2 1/4	12 7/16	6 5/16	4 13/32	1 1/4	UKP326SC	P326SC	UK326		HE2326 H2326	85.4 85.4	229	214	13.6	UKP326SCC	UKP326SCCD	214 8 7/16	98.7	
	180	600	140	480	40	55	57	355	195	121	M33	UKP328SC	P328SC	UK328		H2328	114	253	246	13.6	UKP328SCC	UKP328SCCD	222 8 3/4	131	
125	7 7/8	24 13/32	5 1/2	19 11/16	1 9/16	2 5/32	2 3/4	15 15/32	7 9/32	5 9/32	1 1/4														

Note 1) Codes shown in parentheses indicate the dimensions and Part No. of applicable adapter (H2300X series) for UK200L3 series (triple seal type).

Remarks 1. In Part No. of unit and units with covers, fitting codes follow bore diameter numbers. (See Table 10.5 in P.42.)

2. Part No. of applicable grease nipples are shown below.
 A-1/4-28UNF.....205~210
 A-PT1/8.....211~218, 310~328

3. In Part No. of unit with adapters and bearing with adapters, Part No. of applicable adapter follow the Part No. shown in the dimensional tables.

(Example of Part No. : UKP206JSC + H306X, UK206 + H306X)

4. As for the triple seal type product (205 is the double seal type product), accessory code L3 (or L2) follows the Part No. of unit or bearing.

(Example of Part No. : UKP206JSCL3 + H2306X, UK206L3 + H2306X)

5. For the dimensions and forms of applicable bearings and adapters, see the dimensional tables of ball bearing for unit and adapter.

Thick pillow type units

UCIP
Cylindrical bore (with set screws)
d 40 ~ 140 mm

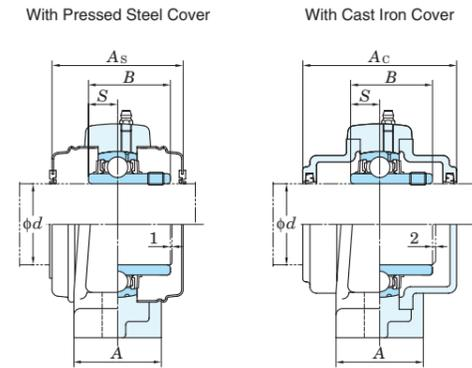
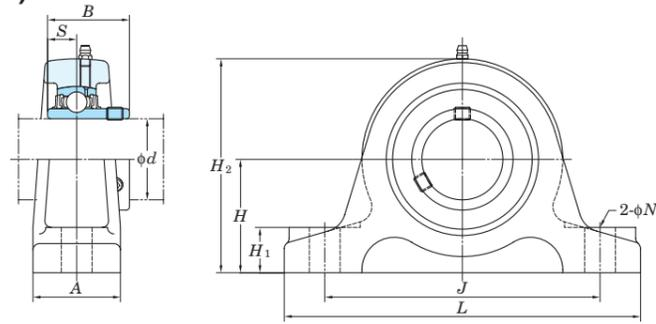

Variations of tolerance of distance from mounting bottom to center of spherical bore (ΔH_s) and variations of tolerance of distance between centers of bolt holes (ΔJ_s)

Housing No.	ΔH_s	ΔJ_s
IP208-IP210	± 0.15	± 0.5
IP211-IP213	± 0.2	± 0.7
IP319-IP328	± 0.3	

Unit : mm

Shaft Dia. mm inch <i>d</i>	Dimensions inch mm										Bolt Size inch mm	Standard Unit No.	Housing No.	Bearing No.	Mass kg	Basic Load Ratings kN <i>C_r</i> <i>C_{0r}</i>	Factor <i>f₀</i>	With Pressed Steel Cover				With Cast Iron Cover						
	<i>H</i>	<i>L</i>	<i>A</i>	<i>J</i>	<i>N</i>	<i>H₁</i>	<i>H₂</i>	<i>B</i>	<i>S</i>	Unit No.								Dimension mm inch <i>A_s</i>	Mass kg	Unit No.	Dimension mm inch <i>A_c</i>	Mass kg						
40 1 1/2 1 9/16	2 23/64 60	7 7/8 200	2 3/8 60	5 29/32 150	3/4 19	3 1/32 25	4 17/32 115	1.937 49.2	0.748 19	5/8 M16	UCIP208-24 UCIP208-25 UCIP208	IP208	UC208-24 UC208-25 UC208	3.4 3.4 3.4	29.1 17.8	14.0	-	-	-	-	-	-	-	-				
																	UCIP208C	UCIP208CD	68	2 11/16	3.4	UCIP208FC	UCIP208FCD	86	3 3/8	4.2		
																	-	-	-	-	-	-	-	-	-	-	-	-
45 1 5/8 1 11/16 1 3/4	2 3/4 70	8 9/32 210	2 3/8 60	6 19/64 160	3/4 19	3 1/32 25	5 1/32 128	1.937 49.2	0.748 19	5/8 M16	UCIP209-26 UCIP209-27 UCIP209-28 UCIP209	IP209	UC209-26 UC209-27 UC209-28 UC209	3.9 3.9 3.9 3.9	34.1 21.3	14.0	-	-	-	-	-	-	-	-	-	-		
																	UCIP209C	UCIP209CD	68	2 11/16	3.9	UCIP209FC	UCIP209FCD	88	3 15/32	4.7		
																	-	-	-	-	-	-	-	-	-	-	-	-
50 1 7/8 1 15/16 2	2 3/4 70	8 21/32 220	2 3/8 60	6 11/16 170	3/4 19	1 3/32 28	5 3/16 132	2.031 51.6	0.748 19	5/8 M16	UCIP210-30 UCIP210-31 UCIP210 UCIP210-32	IP210	UC210-30 UC210-31 UC210 UC210-32	4.8 4.8 4.8 4.8	35.1 23.3	14.4	-	-	-	-	-	-	-	-	-	-		
																	UCIP210C	UCIP210CD	73	2 7/8	4.8	UCIP210FC	UCIP210FCD	97	3 13/16	5.8		
																	-	-	-	-	-	-	-	-	-	-	-	-
55 2 2 1/8 2 3/16	3 5/32 80	9 1/16 230	2 3/8 60	7 3/32 180	3/4 19	1 3/32 28	5 13/16 148	2.189 55.6	0.874 22.2	5/8 M16	UCIP211-32 UCIP211-34 UCIP211 UCIP211-35	IP211	UC211-32 UC211-34 UC211 UC211-35	5.3 5.3 5.3 5.3	43.4 29.4	14.4	-	-	-	-	-	-	-	-	-	-		
																	UCIP211C	UCIP211CD	75	2 15/16	5.3	UCIP211FC	UCIP211FCD	99	3 29/32	6.3		
																	-	-	-	-	-	-	-	-	-	-	-	-
60 2 1/4 2 3/8 2 7/16	3 5/32 80	10 1/4 260	2 3/4 70	7 7/8 200	7/8 22	1 3/16 30	6 3/32 155	2.563 65.1	1.000 25.4	3/4 M20	UCIP212-36 UCIP212 UCIP212-38 UCIP212-39	IP212	UC212-36 UC212 UC212-38 UC212-39	7.2 7.2 7.2 7.2	52.4 36.2	14.4	-	-	-	-	-	-	-	-	-	-		
																	UCIP212C	UCIP212CD	88	3 15/32	7.2	UCIP212FC	UCIP212FCD	114	4 1/2	8.7		
																	-	-	-	-	-	-	-	-	-	-	-	-
65 2 1/2 2 1/2	3 35/64 90	11 1/32 280	2 3/4 70	8 21/32 220	7/8 22	1 3/16 30	6 25/32 172	2.563 65.1	1.000 25.4	3/4 M20	UCIP213-40 UCIP213 UCIP213-40 UCIP213-40	IP213	UC213-40 UC213 UC213-40 UC213-40	8.8 8.8 13.4 13.4	57.2 40.1	14.4	-	-	-	-	-	-	-	-	-	-		
																	UCIP213C	UCIP213CD	88	3 15/32	8.8	UCIP213FC	UCIP213FCD	114	4 1/2	10.5		
																	-	-	-	-	-	-	-	-	-	-	-	-
70 2 3/4 2 3/4	4 21/64 110	13 310	2 15/16 70	10 5/8 250	3 1/32 22	1 3/8 30	8 15/32 208	3.071 75	1.299 30	7/8 M20	UCIP314-44 UCIP314	IP314	UC314-44 UC314	15.3 15.3	104 68.2	13.2	-	-	-	-	-	-	-	-	-			
																	-	-	-	-	-	-	-	-	-	-	-	-
																	-	-	-	-	-	-	-	-	-	-	-	-
75 2 15/16 3	4 23/32 120	13 3/8 340	2 15/16 75	11 1/32 280	3 1/32 25	1 3/8 35	9 1/16 230	3.228 82	1.260 32	7/8 M22	UCIP315-47 UCIP315 UCIP315-48	IP315	UC315-47 UC315 UC315-48	17.6 17.6 17.6	113 77.2	13.2	-	-	-	-	-	-	-	-	-			
																	-	-	-	-	-	-	-	-	-	-	-	-
																	-	-	-	-	-	-	-	-	-	-	-	-
80 -	4 23/32 120	13 25/32 350	3 11/32 85	11 27/64 290	3 1/32 25	1 9/16 40	9 1/4 235	3.386 86	1.339 34	7/8 M22	UCIP316	IP316	UC316	20.3	123 86.7	13.3	-	-	-	-	-	-	-	-	-			
																	-	-	-	-	-	-	-	-	-	-	-	-
																	-	-	-	-	-	-	-	-	-	-	-	-
85 -	5 1/8 130	14 9/16 370	3 11/32 85	12 13/64 310	3 1/32 25	1 9/16 40	10 1/4 255	3.780 96	1.575 40	7/8 M22	UCIP317	IP317	UC317	25.9	133 96.8	13.3	-	-	-	-	-	-	-	-				
																	-	-	-	-	-	-	-	-	-	-	-	-
																	-	-	-	-	-	-	-	-	-	-	-	-
90 3 1/2	5 1/8 130	15 3/4 400	3 11/32 85	13 330	1 5/32 29	1 25/32 45	10 1/4 260	3.780 96	1.575 40	1 M27	UCIP318-56 UCIP318	IP318	UC318-56 UC318	28.6 28.6	143 107	13.3	-	-	-	-	-	-	-	-				
																	-	-	-	-	-	-	-	-	-	-	-	-
																	-	-	-	-	-	-	-	-	-	-	-	-
95 -	5 29/32 150	16 5/32 410	3 11/32 85	13 25/64 340	1 5/32 29	1 25/32 45	11 7/32 285	4.055 103	1.614 41	1 M27	UCIP319	IP319	UC319	31.7	153 119	13.3	-	-	-	-	-	-	-	-				
																	-	-	-	-	-	-	-	-	-	-	-	-
																	-	-	-	-	-	-	-	-	-	-	-	-
100 3 15/16 4	5 29/32 150	16 15/16 430	3 11/32 85	14 11/64 360	1 5/32 29	1 25/32 45	11 5/8 295	4.252 108	1.654 42	1 M27	UCIP320 UCIP320-63 UCIP320-64	IP320	UC320 UC320-63 UC320-64	36.9 36.9 36.9	173 141	13.2	-	-	-	-	-	-	-	-				
																	-	-	-	-	-	-	-	-	-	-	-	-
																	-	-	-	-	-	-	-	-	-	-	-	-
110 -	6 11/16 170	19 9/32 490	3 15/16 100	16 9/64 410	1 1/4 32	1 31/32 50	13 3/16 335	4.606 117	1.811 46	1 1/8 M30	UCIP322	IP322	UC322	52.4	205 180	13.2	-	-	-	-	-	-	-	-				
																	-	-	-	-	-	-	-	-	-	-	-	-
																	-	-	-	-	-	-	-	-	-	-	-	-
120 -	6 11/16 170	20 3/32 510	3 15/16 100	16 59/64 430	1 1/4 32	1 31/32 50	13 19/32 345	4.961 126	2.008 51	1 1/8 M30	UCIP324	IP324	UC324	58.7	207 185	13.5	-	-	-	-	-	-	-	-				
																	-	-	-	-	-	-	-	-	-	-	-	-
																	-	-	-	-	-	-	-	-	-	-	-	-
130 -	7 7/8 200	21 21/32 550	4 11/32 110	18 1/2 470	1 1/4 32	1 31/32 50	15 11/32 390	5.315 135	2.126 54	1 1/8 M30	UCIP326	IP326	UC326	76.2	229 214	13.6	-	-	-	-	-	-	-	-				
																	-	-	-	-	-	-	-	-	-	-	-	-
																	-	-	-	-	-	-	-	-	-	-	-	-
140 -	7 7/8 200	23 7/32 590	4 11/32 110	19 11/16 500	1 3/8 35	2 5/32 55	15 3/4 400	5.709 145	2.323 59	1 1/4 M33	UCIP328	IP328	UC328	87.0	253 246	13.6	-	-	-	-	-	-	-	-				
																	-	-	-	-	-	-	-	-	-	-	-	-
																	-	-	-	-	-	-	-	-	-	-	-	-

Remarks 1. In Part No. of unit and units with covers, fitting codes follow bore diameter numbers. (See Table 10.5 in P.42.)
2. Part No. of applicable grease nipples are shown below.
A-1/4-28UNF 208-210
A-PT1/8 211-213, 313-328

3. As for the triple seal type product, accessory code L3 follows the Part No. of unit or bearing.
(Example of Part No. : UCIP208JL3, UC208L3)
4. As for the dimensions and forms of applicable bearings, see the dimensional tables of ball bearing for unit.

Thick pillow type units

UKIP
Tapered bore (with adapter)
d₁ 35 ~ 125 mm

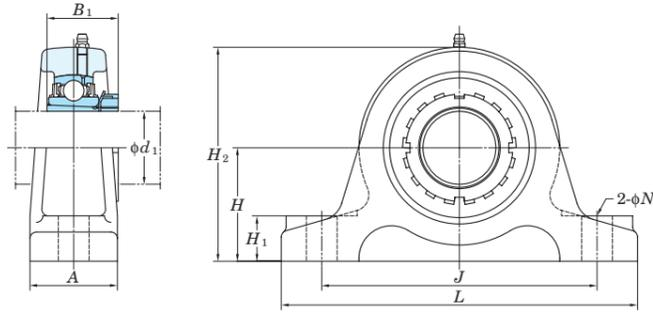

With Pressed Steel Cover

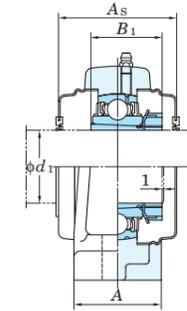

With Cast Iron Cover

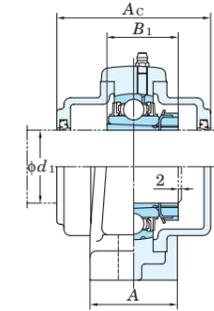

Variations of tolerance of distance from mounting bottom to center of spherical bore (ΔH_s) and variations of tolerance of distance between centers of bolt holes (ΔJ_s)

Housing No.	ΔH_s	ΔJ_s
IP208-IP210	±0.15	±0.5
IP211-IP213	±0.2	±0.7
IP313-IP318	±0.2	
IP319-IP328	±0.3	

Unit : mm

Shaft Dia. mm inch	Dimensions inch mm								Bolt Size inch mm	Unit No.	Housing No.	Standard Bearing No.	Adapter ¹⁾ No.	Mass kg	Basic Load Ratings kN		Factor f ₀	With Pressed Steel Cover			With Cast Iron Cover		
	H	L	A	J	N	H ₁	H ₂	B ₁ ¹⁾							Unit No.	Dimension mm inch		Mass kg	Unit No.	Dimension mm inch	Mass kg		
35 1 1/4 1 3/8	2 23/64	7 7/8	2 3/8	5 29/32	3/4	3 1/32	4 17/32	1 13/32 (1 13/16)	5/8	UKIP208	IP208	UK208	HE308X(HE2308X) HS308X(HS2308X) H308X(H2308X)	3.5	29.1	17.8	14.0	-	-	-	-	-	-
	60	200	60	150	19	25	115	36(46)	M16									UKIP208C	68 2 11/16	3.5	UKIP208FC	86 3 3/8	4.4
40 1 1/2 1 5/8	2 3/4	8 9/32	2 3/8	6 19/64	3/4	3 1/32	5 1/32	1 17/32 (1 31/32)	5/8	UKIP209	IP209	UK209	HE309X(HE2309X) H309X(H2309X) HS309X(HS2309X)	4.0	34.1	21.3	14.0	-	-	-	-	-	-
	70	210	60	160	19	25	128	39(50)	M16									UKIP209C	68 2 11/16	4.0	UKIP209FC	88 3 15/32	4.9
45 1 3/4	2 3/4	8 21/32	2 3/8	6 11/16	3/4	1 3/32	5 3/16	1 21/32 (2 5/32)	5/8	UKIP210	IP210	UK210	HE310X(HE2310X) H310X(H2310X)	4.8	35.1	23.3	14.4	-	-	-	-	-	-
	70	220	60	170	19	28	132	42(55)	M16									UKIP210C	73 2 7/8	4.8	UKIP210FC	97 3 13/16	5.8
50 1 7/8 2	3 5/32	9 1/16	2 3/8	7 3/32	3/4	1 3/32	5 13/16	1 25/32 (2 5/16)	5/8	UKIP211	IP211	UK211	HS311X(HS2311X) H311X(H2311X) HE311X(HE2311X)	5.3	43.4	29.4	14.4	-	-	-	-	-	-
	80	230	60	180	19	28	148	45(59)	M16									UKIP211C	75 2 15/16	5.3	UKIP211FC	99 3 29/32	5.9
55 2 1/8	3 5/32	10 1/4	2 3/4	7 7/8	7/8	1 3/16	6 3/32	1 27/32 (2 7/16)	3/4	UKIP212	IP212	UK212	HS312X(HS2312X) H312X(H2313X)	7.1	52.4	36.2	14.4	-	-	-	-	-	-
	80	260	70	200	22	30	155	47(62)	M20									UKIP212C	88 3 15/32	7.1	UKIP212FC	114 4 1/2	8.6
60 2 1/4 2 3/8	3 35/64	11 1/32	2 3/4	8 21/32	7/8	1 3/16	6 25/32	1 31/32 (2 9/16)	3/4	UKIP213	IP213	UK213	HE313X(HE2313X) H313X(H2313X) HS313X(HS2313X)	8.7	57.2	40.1	14.4	-	-	-	-	-	-
	90	280	70	220	22	30	172	50(65)	M20									UKIP213C	88 3 15/32	8.7	UKIP213FC	114 4 1/2	10.4
65 2 1/2	4 23/32	13 3/8	2 15/16	11 1/32	3 1/32	1 3/8	9 1/16	2 7/8	7/8	UKIP315	IP315	UK315	HE2315X H2315X	13.5	92.7	59.9	13.2	-	-	-	-	-	-
	120	340	75	280	25	35	230	73	M22									UKIP315C	134 5 9/32	13.5	UKIP315FC	134 5 9/32	20.5
70 2 3/4	4 23/32	13 25/32	3 11/32	11 27/64	3 1/32	1 9/16	9 1/4	3 1/16	7/8	UKIP316	IP316	UK316	HE2316X H2316X	17.7	113	77.2	13.2	-	-	-	-	-	-
	120	350	85	290	25	40	235	78	M22									UKIP316C	138 5 7/16	17.7	UKIP316FC	138 5 7/16	23.5
75 3	5 1/8	14 9/16	3 11/32	12 13/64	3 1/32	1 9/16	10 1/32	3 7/32	7/8	UKIP317	IP317	UK317	H2317X HE2317X	20.4	123	86.7	13.3	-	-	-	-	-	-
	130	370	85	310	25	40	255	82	M22									UKIP317C	146 5 3/4	20.4	UKIP317FC	146 5 3/4	29.2
80 -	5 1/8	15 3/4	3 11/32	13	1 5/32	1 25/32	10 1/4	3 3/8	1	UKIP318	IP318	UK318	H2318X	25.7	133	96.8	13.3	-	-	-	-	-	-
	130	400	85	330	29	45	260	86	M27									UKIP318C	150 5 29/32	25.7	UKIP318FC	150 5 29/32	32.9
85 3 1/4	5 29/32	16 5/32	3 11/32	13 25/64	1 5/32	1 25/32	11 7/32	3 17/32	1	UKIP319	IP319	UK319	HE2319X H2319X	32.0	153	119	13.3	-	-	-	-	-	-
	150	410	85	340	29	45	285	90	M27									UKIP319C	162 6 3/8	32.0	UKIP319FC	162 6 3/8	36.7
90 3 1/2	5 29/32	16 15/16	3 11/32	14 11/64	1 5/32	1 25/32	11 5/8	3 13/16	1	UKIP320	IP320	UK320	HE2320X H2320X	36.6	173	141	13.2	-	-	-	-	-	-
	150	430	85	360	29	45	295	97	M27									UKIP320C	174 6 27/32	36.6	UKIP320FC	174 6 27/32	42.8
100 4	6 11/16	19 9/32	3 15/16	16 9/64	1 1/4	1 31/32	13 3/16	4 1/8	1 1/8	UKIP322	IP322	UK322	H2322X HE2322X	52.2	205	180	13.2	-	-	-	-	-	-
	170	490	100	410	32	50	335	105	M30									UKIP322C	188 7 13/32	52.2	UKIP322FC	188 7 13/32	59.1
110 -	6 11/16	20 3/32	3 15/16	16 59/64	1 1/4	1 31/32	13 19/32	4 13/32	1 1/8	UKIP324	IP324	UK324	H2324	59.0	207	185	13.5	-	-	-	-	-	-
	170	510	100	430	32	50	345	112	M30									UKIP324C	196 7 23/32	59.0	UKIP324FC	196 7 23/32	69.3
115 4 1/2	7 7/8	21 21/32	4 11/32	18 1/2	1 1/4	1 31/32	15 11/32	4 3/4	1 1/8	UKIP326	IP326	UK326	HE2326 H2326	76.0	229	214	13.6	-	-	-	-	-	-
	200	550	110	470	32	50	390	121	M30									UKIP326C	214 8 7/16	76.0	UKIP326FC	214 8 7/16	89.3
125 -	7 7/8	23 7/32	4 11/32	19 11/16	1 3/8	2 5/32	15 3/4	4 5/32	1 1/4	UKIP328	IP328	UK328	H2328	87.0	253	246	13.6	-	-	-	-	-	-
	200	590	110	500	35	55	400	131	M33									UKIP328C	222 8 3/4	87.0	UKIP328FC	222 8 3/4	104

Note 1) Codes shown in parentheses indicate the dimensions and Part No. of applicable adapter (H2300X series) for UK200L3 series (triple seal type).

Remarks 1. In Part No. of unit and units with covers, fitting codes follow bore diameter numbers. (See Table 10.5 in P.42.)

2. Part No. of applicable grease nipples are shown below.
A-1/4-28UNF.....208-210
A-PT1/8.....211-213, 313-328

3. In Part No. of unit with adapters and bearing with adapters, Part No. of applicable adapter follow the Part No. shown in the dimensional tables. (Example of Part No. : UKIP208J + H308X, UK208 + H308X)

4. As for the triple seal type product, accessory code L3 follows the Part No. of unit or bearing. (Example of Part No. : UKIP208JL3 + H2308X, UK208L3 + H2308X)

5. For the dimensions and forms of applicable bearings and adapters, see the dimensional tables of ball bearing for unit and adapter.

Tapped-base pillow type units

UCPA
Cylindrical bore (with set screws)
d 12 ~ 50 mm

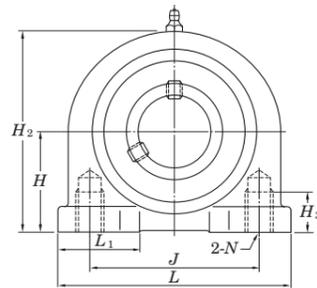
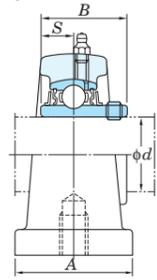
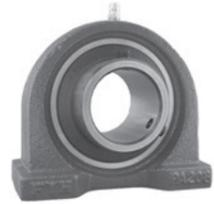

Variations of tolerance of distance from mounting bottom to center of spherical bore (ΔH_s) and variations of tolerance of distance between centers of bolt holes (ΔJ_s)

Housing No.	ΔH_s	ΔJ_s
PA204-PA210	± 0.15	± 0.5

Unit : mm

Shaft Dia. mm inch d	Dimensions inch mm										Unit No.	Housing No.	Bearing No.	Basic Load Ratings kN		Factor f_0	Mass kg	
	H	L	A	J	N	H ₂	H ₃	L ₁	B	S				C _r	C _{0r}			
12 1/2												UCPA201 UCPA201-8	PA204	UC201 UC201-8	12.8	6.65	13.2	0.64
15 5/8	1 3/16	3	1 9/16	2 3/64	M10x1.5	2 3/8	1/2	1 1/16	1.220	0.500	UCPA202 UCPA202-10	UC202 UC202-10						
17 3/4	30.2	76	40	52		60	13	27	31	12.7	UCPA203 UCPA204-12	UC203 UC204-12						
20											UCPA204	UC204						
25 7/8 15/16	1 7/16	3 5/16	1 25/32	2 13/64	M10x1.5	2 25/32	1/2	1 3/16	1.343	0.563	UCPA205-14 UCPA205-15 UCPA205 UCPA205-16	PA205	UC205-14 UC205-15 UC205 UC205-16	14.0	7.85	13.9	0.83	
30 1 1/8	1 11/16	3 11/16	1 31/32	2 19/32	M14x2	3 5/16	23/32	1 13/32	1.500	0.626	UCPA206-18 UCPA206 UCPA206-19 UCPA206-20		UC206-18 UC206 UC206-19 UC206-20					
35 1 1/4 1 5/16 1 3/8	1 7/8	3 11/32	2 5/32	3 5/32	M14x2	3 21/32	25/32	1 5/8	1.689	0.689	UCPA207-20 UCPA207-21 UCPA207-22 UCPA207 UCPA207-23		UC207-20 UC207-21 UC207-22 UC207 UC207-23					
40 1 1/2 1 9/16	1 15/16	4 9/16	2 9/32	3 5/16	M14x2	3 15/16	25/32	1 5/8	1.937	0.748	UCPA208-24 UCPA208-25 UCPA208		UC208-24 UC208-25 UC208					
45 1 5/8 1 11/16 1 3/4	2 9/64	4 23/32	2 3/8	3 35/64	M14x2	4 3/16	31/32	1 21/32	1.937	0.748	UCPA209-26 UCPA209-27 UCPA209-28 UCPA209	PA209	UC209-26 UC209-27 UC209-28 UC209	34.1	21.3	14.0	2.2	
50 1 7/8 1 15/16	2 1/4	5 1/8	2 17/32	3 45/64	M16x2	4 7/16	31/32	1 27/32	2.031	0.748	UCPA210-30 UCPA210-31 UCPA210 UCPA210-32		UC210-30 UC210-31 UC210 UC210-32					

Remarks 1. In Part No. of unit, fitting codes follow bore diameter codes. (See Table 10.5 in P.42.)
 2. Part No. of the applicable grease nipple is A-1/4-28UNF.
 3. As for the triple seal type product (from 201 to 205 are the double seal type products), accessory code L3 (or L2) follows Part No. of unit or bearing. (Example of Part No. : UCPA206JL3, UC206L3)

4. As for the dimensions and forms of applicable bearings, see the dimensional tables of ball bearing for unit.
 5. Tapered bore (with adapter) type products are also available. (Example of Part No. : UKPA205J + H305X, UK205 + H305X)

High centerheight pillow type units

UCPH
Cylindrical bore (with set screws)
d 12 ~ 50 mm

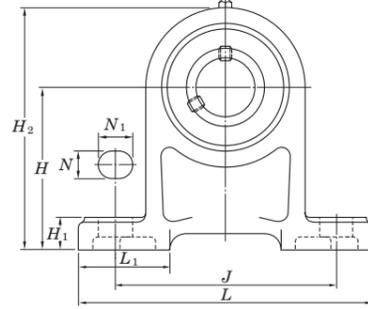
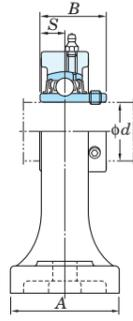

Variations of tolerance of distance from mounting bottom to center of spherical bore (ΔH_s)

Housing No.	ΔH_s
PH204-PH210	±0.15

Shaft Dia. mm inch d	Dimensions inch mm											Bolt Size inch mm	Unit No.	Housing No.	Bearing No.	Basic Load Ratings kN		Factor f_0	Mass kg	
	H	L	A	J	N	N ₁	H ₁	H ₂	L ₁	B	S					C _r	C _{0r}			
12 1/2														UCPH201 UCPH201-8		UC201 UC201-8				0.96
15 5/8	2 3/4	5	1 9/16	3 3/4	1/2	3/4	19/32	3 21/32	1 13/16	1.220	0.500	3/8	UCPH202 UCPH202-10	PH204	UC202 UC202-10	12.8	6.65	13.2	0.94	
17 3/4	70	127	40	95	13	19	15	101	46	31	12.7	M10	UCPH203 UCPH204-12		UC203 UC204-12				0.93	
20													UCPH204		UC204				0.91	
25 7/8 15/16	3 5/32	5 1/2	1 31/32	4 1/8	1/2	3/4	5/8	3 1/2	1 15/16	1.343	0.563	3/8	UCPH205-14 UCPH205-15	PH205	UC205-14 UC205-15	14.0	7.85	13.9	1.2	
25 1	80	140	50	105	13	19	16	114	49	34.1	14.3	M10	UCPH205 UCPH205-16		UC205 UC205-16					
30 1 1/8	3 35/64	6 1/2	1 31/32	4 3/4	21/32	13/16	23/32	5 1/8	1 7/32	1.500	0.626	1/2	UCPH206-18 UCPH206	PH206	UC206-18 UC206	19.5	11.3	13.9	1.6	
30 1 3/16	90	165	50	121	17	21	18	130	56	38.1	15.9	M14	UCPH206-19 UCPH206-20		UC206-19 UC206-20					
30 1 1/4																				
35 1 1/4 1 5/16 1 3/8	3 47/64	6 9/16	2 3/8	5	21/32	13/16	23/32	5 1/2	1 1/8	1.689	0.689	1/2	UCPH207-20 UCPH207-21	PH207	UC207-20 UC207-21	25.7	15.4	13.9	2.0	
35 1 7/16	95	167	60	127	17	21	18	140	54	42.9	17.5	M14	UCPH207-22 UCPH207		UC207-22 UC207					
35 1 7/16													UCPH207-23		UC207-23					
40 1 1/2 1 9/16	3 15/16	7 1/4	2 3/4	5 13/32	21/32	13/16	25/32	5 29/32	2 1/4	1.937	0.748	1/2	UCPH208-24 UCPH208-25	PH208	UC208-24 UC208-25	29.1	17.8	14.0	2.7	
40 1 9/16	100	184	70	137	17	21	20	150	57	49.2	19	M14	UCPH208		UC208					
45 1 5/8 1 11/16 1 3/4	4 9/64	7 15/32	2 3/4	5 3/4	21/32	13/16	25/32	6 7/32	2 9/32	1.937	0.748	1/2	UCPH209-26 UCPH209-27	PH209	UC209-26 UC209-27	34.1	21.3	14.0	3.0	
45 1 3/4	105	190	70	146	17	21	20	158	58	49.2	19	M14	UCPH209-28 UCPH209		UC209-28 UC209					
50 1 7/8 1 15/16	4 21/64	8 1/8	2 3/4	6 1/4	25/32	7/8	7/8	6 1/2	2 9/16	2.031	0.748	5/8	UCPH210-30 UCPH210-31	PH210	UC210-30 UC210-31	35.1	23.3	14.4	3.5	
50 2	110	206	70	159	20	22	22	165	65	51.6	19	M16	UCPH210 UCPH210-32		UC210 UC210-32					

- Remarks 1. In Part No. of unit, fitting codes follow bore diameter codes. (See Table 10.5 in P.42.)
- 2. Part No. of the applicable grease nipple is A-1/4-28UNF.
- 3. As for the triple seal type product (from 201 to 205 are the double seal type products), accessory code L3 (or L2) follows Part No. of unit or bearing. (Example of Part No. : UCPH206JL3, UC206L3)

- 4. As for the dimensions and forms of applicable bearings, see the dimensional tables of ball bearing for unit.
- 5. Tapered bore (with adapter) type products are also available. (Example of Part No. : UKPH205J + H305X, UK205 + H305X)

Lightweight pillow type units

BLP
Cylindrical bore
(with set screw locking)
ALP
Cylindrical bore
(with eccentric locking collar)
d 12 ~ 40 mm

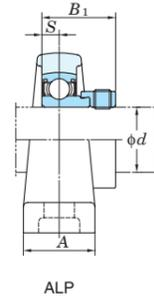
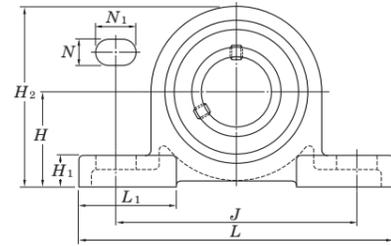
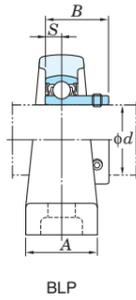

Variations of tolerance of distance from mounting bottom to center of spherical bore (ΔH_s)

Housing No.	Unit : mm
LP203-LP208	±0.15

Shaft Dia. mm inch	Dimensions inch mm												Bolt Size inch mm	Unit No.	Bearing No.	Unit No.	Bearing No.	Housing No.	Basic Load Ratings kN		Factor <i>f</i> ₀	Mass kg		
	<i>H</i>	<i>L</i>	<i>A</i>	<i>J</i>	<i>N</i>	<i>N</i> ₁	<i>H</i> ₁	<i>H</i> ₂	<i>L</i> ₁	<i>S</i>	BLP <i>B</i>	ALP <i>B</i> ₁							<i>C</i> _r	<i>C</i> _{0r}		BLP	ALP	
12 1/2	1 3/16	4 1/2	3 1/32	3 7/16	7/16	5/8	15/32	2 1/4	1 3/8	0.236	0.866	1.122	3/8	M10	BLP201 BLP201-8 BLP202 BLP202-10 BLP203	SB201 SB201-8 SB202 SB202-10 SB203	ALP201 ALP201-8 ALP202 ALP202-10 ALP203	SA201 SA201-8 SA202 SA202-10 SA203	LP203	9.55	4.80	13.2	0.36	0.39
15 5/8	1 5/16	4 29/32	1 1/16	3 13/16	7/16	5/8	1/2	2 25/32	1 1/2	0.276	0.984	1.161	3/8	M10	BLP204-12 BLP204	SB204-12 SB204	ALP204-12 ALP204	SA204-12 SA204	LP204	12.8	6.65	13.2	0.51	0.51
17 3/4	1 7/16	5 1/8	1 5/32	3 15/16	7/16	5/8	1/2	2 25/32	1 17/32	0.295	1.063	1.201	3/8	M10	BLP205-14 BLP205-15 BLP205 BLP205-16	SB205-14 SB205-15 SB205 SB205-16	ALP205-14 ALP205-15 ALP205 ALP205-16	SA205-14 SA205-15 SA205 SA205-16	LP205	14.0	7.85	13.9	0.57	0.61
20 3/4	1 11/16	6 5/32	1 5/16	4 23/32	9/16	13/16	9/16	3 9/32	1 27/32	0.315	1.181	1.335	1/2	M12	BLP206-18 BLP206 BLP206-19 BLP206-20 BLP207-20	SB206-18 SB206 SB206-19 SB206-20 SB207-20	ALP206-18 ALP206 ALP206-19 ALP206-20	SA206-18 SA206 SA206-19 SA206-20	LP206	19.5	11.3	13.9	0.69	0.72
25 1	1 7/8	6 1/2	1 3/8	5	9/16	13/16	5/8	3 21/32	1 31/32	0.335	1.260	1.437	1/2	M12	BLP207-22 BLP207 BLP207-23 BLP208-24	SB207-22 SB207 SB207-23 SB208-24	ALP207-22 ALP207 ALP207-23	SA207-22 SA207 SA207-23	LP207	25.7	15.4	13.9	0.94	1.0
30 1 1/8	2	7 1/4	1 15/32	5 1/2	9/16	7/8	23/32	4 1/32	2 5/32	0.354	1.339	1.595	1/2	M12	BLP208-24 BLP208	SA208-24 SA208	ALP208-24 ALP208	SA208-24 SA208	LP208	29.1	17.8	14.0	1.8	1.9

Remarks 1. In Part No. of unit, fitting codes follow bore diameter codes. (See Table 10.5 in P.42.)
 2. Allowable load to housing in radial direction is approximately half of basic load rating of bearing, *C*_r (when safety factor is 4).
 3. For the dimensions and forms of applicable bearings, see the dimensional tables of ball bearing for unit.

Clean series pillow type units

UP
Cylindrical bore (with set screws)
d 10 ~ 30 mm

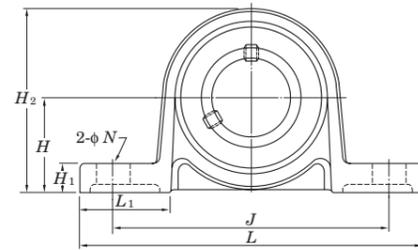
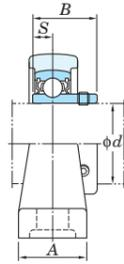
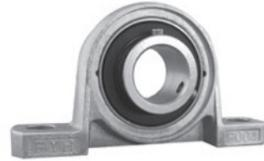

With Through Type Cover

With One Side Sealed Cover

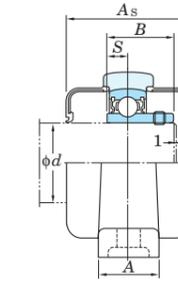
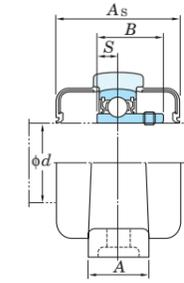

Variations of tolerance of distance from mounting bottom to center of spherical bore (ΔH_s) and variations of tolerance of distance between centers of bolt holes (ΔJ_s)

Housing No.	ΔH_s	ΔJ_s
P000-P006	±0.15	±0.3

Unit : mm

Shaft Dia. mm <i>d</i>	Dimensions inch mm										Bolt Size inch mm	Standard			Mass kg	Basic Load Ratings kN		Factor <i>f</i> ₀	With Rubber Coated Cover		Mass kg
	<i>H</i>	<i>L</i>	<i>A</i>	<i>J</i>	<i>N</i>	<i>H</i> ₁	<i>H</i> ₂	<i>L</i> ₁	<i>B</i>	<i>S</i>		Unit No.	Housing No.	Bearing No.		<i>C</i> _r	<i>C</i> _{0r}		Unit No.	Dimension mm inch <i>A</i> _s	
10	⁴⁵ / ₆₄ 18	2 ⁵ / ₈ 67	⁵ / ₈ 16	2 ³ / ₃₂ 53	⁹ / ₃₂ 7	¹ / ₄ 6	1 ³ / ₈ 35	²³ / ₃₂ 18	0.591 15	0.197 5	¹ / ₄ M6	UP000	P000	SU000	4.55	1.95	12.3	UP000C	UP000CD	29	¹ ⁵ / ₃₂ 0.070
12	³ / ₄ 19	2 ²⁵ / ₃₂ 71	⁵ / ₈ 16	2 ¹³ / ₆₄ 56	⁹ / ₃₂ 7	¹ / ₄ 6	1 ¹ / ₂ 38	³ / ₄ 19	0.591 15	0.197 5	¹ / ₄ M6	UP001	P001	SU001	5.10	2.40	13.2	UP001C	UP001CD	29	¹ ⁵ / ₃₂ 0.090
15	⁵⁵ / ₆₄ 22	3 ⁵ / ₃₂ 80	⁵ / ₈ 16	2 ³¹ / ₆₄ 63	⁹ / ₃₂ 7	⁹ / ₃₂ 7	1 ¹¹ / ₁₆ 43	¹³ / ₁₆ 21	0.650 16.5	0.217 5.5	¹ / ₄ M6	UP002	P002	SU002	5.60	2.85	13.9	UP002C	UP002CD	31	1 ⁷ / ₃₂ 0.11
17	¹⁵ / ₁₆ 24	3 ¹¹ / ₃₂ 85	²³ / ₃₂ 18	2 ⁴¹ / ₆₄ 67	⁹ / ₃₂ 7	⁹ / ₃₂ 7	1 ²⁷ / ₃₂ 47	¹³ / ₁₆ 21	0.689 17.5	0.236 6	¹ / ₄ M6	UP003	P003	SU003	6.00	3.25	14.4	UP003C	UP003CD	33	1 ⁵ / ₁₆ 0.15
20	1 ⁷ / ₆₄ 28	3 ¹⁵ / ₁₆ 100	²⁵ / ₃₂ 20	3 ⁵ / ₃₂ 80	¹³ / ₃₂ 10	¹¹ / ₃₂ 9	2 ⁵ / ₃₂ 55	³¹ / ₃₂ 25	0.827 21	0.276 7	⁵ / ₁₆ M8	UP004	P004	SU004	9.40	5.05	13.9	UP004C	UP004CD	38	1 ¹ / ₂ 0.23
25	1 ¹⁷ / ₆₄ 32	4 ¹³ / ₃₂ 112	²⁵ / ₃₂ 20	3 ³⁵ / ₆₄ 90	¹³ / ₃₂ 10	¹³ / ₃₂ 10	2 ⁷ / ₁₆ 62	1 ³ / ₃₂ 28	0.866 22	0.276 7	⁵ / ₁₆ M8	UP005	P005	SU005	10.1	5.85	14.5	UP005C	UP005CD	40	1 ⁹ / ₁₆ 0.28
30	1 ²⁷ / ₆₄ 36	5 ³ / ₁₆ 132	1 ¹ / ₃₂ 26	4 ¹¹ / ₆₄ 106	¹ / ₂ 13	⁷ / ₁₆ 11	2 ³ / ₄ 70	1 ¹¹ / ₃₂ 34	0.965 24.5	0.295 7.5	³ / ₈ M10	UP006	P006	SU006	13.2	8.25	14.7	UP006C	UP006CD	44	1 ²³ / ₃₂ 0.42

Remarks 1. In Part No. of unit and units with covers, fitting codes follow bore diameter codes. (See Table 10.5 in P.42.)
2. Clean series pillow type unit.
3. For the dimensions and forms of applicable bearings, see the dimensional tables of ball bearing for unit.

UCSP-H1S6
Cylindrical bore (with set screws)
 d 20 ~ 50 mm

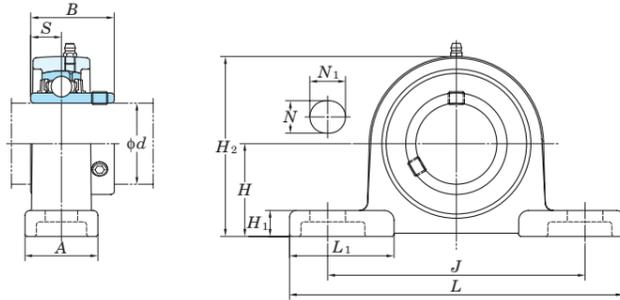
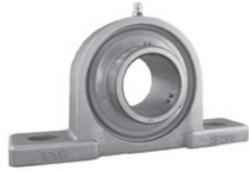

With Pressed Stainless Steel Cover

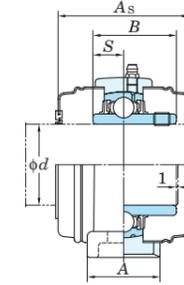

Variations of tolerance of distance from mounting bottom to center of spherical bore (ΔH_s) and variations of tolerance of distance between centers of bolt holes (ΔJ_s)

Housing No.	ΔH_s	ΔJ_s
SP204H1-SP210H1	±0.15	±0.3

Unit : mm

Shaft Dia. mm d	Dimensions											Bolt Size inch mm	Standard			Mass kg	Basic Load Ratings kN		Factor f ₀	With Pressed Stainless Steel Cover		Mass kg
	H	L	A	J	N	N ₁	H ₁	H ₂	L ₁	B	S		Unit No.	Housing No.	Bearing No.		C _r	C _{0r}		Open Type	One Side Closed Type	
20	1 5/16 33.3	5 127	1 3/16 30	3 3/4 95	1/2 13	23/32 18	7/16 11	2 15/32 63	1 21/32 42	1.220 31	0.500 12.7	3/8 M10	UCSP204H1S6	SP204H1	UC204S6	10.9	5.35	13.2	UCSP204H1CS6	UCSP204H1CDS6	45 1 25/32	0.54
25	1 7/16 36.5	5 1/2 140	1 3/16 30	4 1/8 105	1/2 13	3/4 19	15/32 12	2 23/32 69	1 13/16 46	1.343 34.1	0.563 14.3	3/8 M10	UCSP205H1S6	SP205H1	UC205S6	11.9	6.3	13.9	UCSP205H1CS6	UCSP205H1CDS6	49 1 15/16	0.70
30	1 11/16 42.9	6 1/2 165	1 13/32 36	4 3/4 121	21/32 17	13/16 21	1/2 13	3 3/16 81	2 1/8 54	1.500 38.1	0.626 15.9	1/2 M14	UCSP206H1S6	SP206H1	UC206S6	16.5	9.05	13.9	UCSP206H1CS6	UCSP206H1CDS6	53 2 3/32	1.0
35	1 7/8 47.6	6 9/16 167	1 1/2 38	5 127	21/32 17	13/16 21	9/16 14	3 19/32 91	2 51	1.689 42.9	0.689 17.5	1/2 M14	UCSP207H1S6	SP207H1	UC207S6	21.8	12.3	13.9	UCSP207H1CS6	UCSP207H1CDS6	60 2 3/8	1.4
40	1 15/16 49.2	7 1/4 184	1 9/16 40	5 13/32 137	21/32 17	13/16 21	9/16 14	3 13/16 97	2 3/8 60	1.937 49.2	0.748 19	1/2 M14	UCSP208H1S6	SP208H1	UC208S6	24.8	14.3	14.0	UCSP208H1CS6	UCSP208H1CDS6	69 2 23/32	1.7
45	2 1/8 54	7 15/32 190	1 9/16 40	5 3/4 146	21/32 17	13/16 21	19/32 15	4 3/32 104	2 13/32 61	1.937 49.2	0.748 19	1/2 M14	UCSP209H1S6	SP209H1	UC209S6	27.8	16.2	14.0	UCSP209H1CS6	UCSP209H1CDS6	69 2 23/32	1.8
50	2 1/4 57.2	8 1/8 206	1 25/32 45	6 1/4 159	25/32 20	7/8 22	5/8 16	4 3/8 111	2 9/16 65	2.031 51.6	0.748 19	5/8 M16	UCSP210H1S6	SP210H1	UC210S6	29.8	18.6	14.4	UCSP210H1CS6	UCSP210H1CDS6	74 2 29/32	2.3

- Remarks 1. In Part No. of unit and units with covers, fitting codes follow bore diameter codes. (See Table 10.5 in P.42.)
 2. Stainless steel series thin pillow type unit.
 3. Part No. of the applicable grease nipple is A-1/4-28UNFN12.
 4. For the dimensions and forms of applicable bearings, see the dimensional tables of ball bearing for unit.

UCSPA-H1S6
Cylindrical bore (with set screws)
 d 20 ~ 40 mm

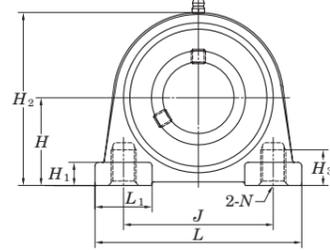
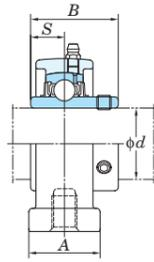

With Pressed Stainless Steel Cover

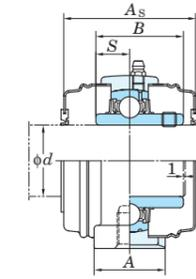

Variations of tolerance of distance from mounting bottom to center of spherical bore (ΔH_s) and variations of tolerance of distance between centers of bolt holes (ΔJ_s)

Housing No.	ΔH_s	ΔJ_s
SPA204H1-SPA208H1	± 0.15	± 0.5

Unit : mm

Shaft Dia. mm d	Dimensions											Standard			Mass kg	Basic Load Ratings kN		Factor f ₀	With Pressed Stainless Steel Cover		Dimension mm As	Mass kg
	H	L	A	J	N	H ₁	H ₂	H ₃	L ₁	B	S	Unit No.	Housing No.	Bearing No.		C _r	C _{0r}		Open Type	One Side Closed Type		
20	1 3/16	3	1 3/16	2 3/64	M10x1.5	13/32	2 3/8	1/2	7/8	1.220	0.500	UCSPA204H1S6	SPA204H1	UC204S6	10.9	5.35	13.2	UCSPA204H1CS6	UCSPA204H1CDS6	45	1 25/32	0.46
	30.2	76	30	52		10	60	13	22	31	12.7											
25	1 7/16	3 5/16	1 3/16	2 13/64	M10x1.5	15/32	2 23/32	1/2	15/16	1.343	0.563	UCSPA205H1S6	SPA205H1	UC205S6	11.9	6.3	13.9	UCSPA205H1CS6	UCSPA205H1CDS6	49	1 15/16	0.63
	36.5	84	30	56		12	69	13	24	34.1	14.3											
30	1 11/16	3 11/16	1 13/32	2 19/32	M14x2	15/32	3 3/16	23/32	1 3/32	1.500	0.626	UCSPA206H1S6	SPA206H1	UC206S6	16.5	9.05	13.9	UCSPA206H1CS6	UCSPA206H1CDS6	53	2 3/32	0.91
	42.9	94	36	66		12	81	18	28	38.1	15.9											
35	1 7/8	3 11/32	1 1/2	3 5/32	M14x2	1/2	3 19/32	25/32	1 3/16	1.689	0.689	UCSPA207H1S6	SPA207H1	UC207S6	21.8	12.3	13.9	UCSPA207H1CS6	UCSPA207H1CDS6	60	2 3/8	1.3
	47.6	110	38	80		13	91	20	30	42.9	17.5											
40	1 15/16	4 9/16	1 9/16	3 5/16	M14x2	1/2	3 13/16	25/32	1 1/4	1.937	0.748	UCSPA208H1S6	SPA208H1	UC208S6	24.8	14.3	14.0	UCSPA208H1CS6	UCSPA208H1CDS6	69	2 23/32	1.5
	49.2	116	40	84		13	97	20	32	49.2	19											

Remarks 1. In Part No. of unit and units with covers, fitting codes follow bore diameter codes. (See Table 10.5 in P.42.)
 2. Part No. of the applicable grease nipple is A-1/4-28UNFN12.
 3. For the dimensions and forms of applicable bearings, see the dimensional tables of ball bearing for unit.

USP-S6
Cylindrical bore (with set screws)
 d 10 ~ 30 mm

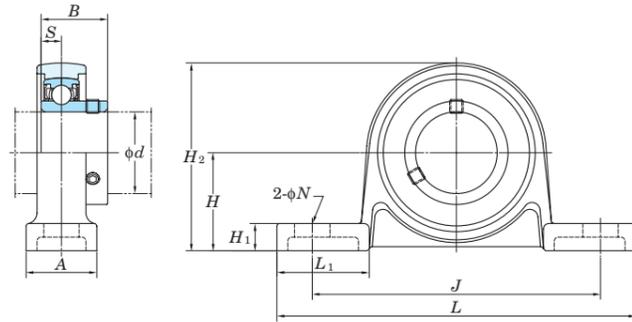

With Through Type Cover

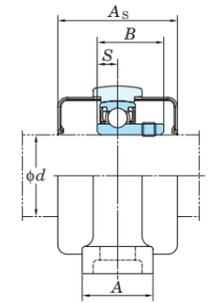

With One Side Sealed Cover

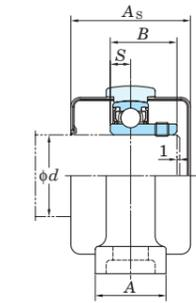

Variations of tolerance of distance from mounting bottom to center of spherical bore (ΔH_s) and variations of tolerance of distance between centers of bolt holes (ΔJ_s)

Housing No.	ΔH_s	ΔJ_s
SP000-SP006	±0.15	±0.3

Unit : mm

Shaft Dia. mm d	Dimensions inch mm										Bolt Size inch mm	Standard			Mass kg	Basic Load Ratings kN		Factor f_0	With Rubber Coated Cover				
	H	L	A	J	N	H_1	H_2	L_1	B	S		Unit No.	Housing No.	Bearing No.		C_r	C_{0r}		Unit No.	Dimension mm inch	Mass kg		
10	$45/64$	$2\ 5/8$	$5/8$	$2\ 3/32$	$9/32$	$3/16$	$1\ 3/8$	$23/32$	0.591	0.197	$1/4$	USP000S6	SP000	SU000S6	0.076	4.55	3.9	1.55	USP000CS6	USP000CDS6	29	$1\ 5/32$	0.076
	18	67	16	53	7	5	35	18	15	5	M6												
12	$3/4$	$2\ 25/32$	$5/8$	$2\ 7/32$	$9/32$	$3/16$	$1\ 15/32$	$23/32$	0.591	0.197	$1/4$	USP001S6	SP001	SU001S6	0.08	5.10	4.3	1.9	USP001CS6	USP001CDS6	29	$1\ 5/32$	0.08
	19	71	16	56	7	5	37	18.5	15	5	M6												
15	$55/64$	$3\ 5/32$	$5/8$	$2\ 15/32$	$9/32$	$1/4$	$1\ 11/16$	$13/16$	0.650	0.217	$1/4$	USP002S6	SP002	SU002S6	0.11	5.60	4.7	2.25	USP002CS6	USP002CDS6	31	$1\ 7/32$	0.11
	22	80	16	63	7	6	42.5	20.5	16.5	5.5	M6												
17	$15/16$	$3\ 11/32$	$23/32$	$2\ 5/8$	$9/32$	$1/4$	$1\ 13/16$	$13/16$	0.689	0.236	$1/4$	USP003S6	SP003	SU003S6	0.14	6.00	5.1	2.6	USP003CS6	USP003CDS6	33	$1\ 5/16$	0.14
	24	85	18	67	7	6	46	21	17.5	6	M6												
20	$1\ 7/64$	$3\ 15/16$	$25/32$	$3\ 5/32$	$13/32$	$5/16$	$2\ 5/32$	$31/32$	0.827	0.276	$5/16$	USP004S6	SP004	SU004S6	0.23	9.40	7.9	4	USP004CS6	USP004CDS6	38	$1\ 1/2$	0.23
	28	100	20	80	10	8	54.5	25	21	7	M8												
25	$1\ 17/64$	$4\ 13/32$	$25/32$	$3\ 17/32$	$13/32$	$11/32$	$2\ 13/32$	$1\ 3/32$	0.866	0.276	$5/16$	USP005S6	SP005	SU005S6	0.28	10.1	8.5	4.65	USP005CS6	USP005CDS6	40	$1\ 9/16$	0.28
	32	112	20	90	10	9	61	27.5	22	7	M8												
30	$1\ 27/64$	$5\ 3/16$	$1\ 1/32$	$4\ 3/16$	$1/2$	$13/32$	$2\ 23/32$	$1\ 11/32$	0.965	0.295	$3/8$	USP006S6	SP006	SU006S6	0.43	13.2	11.2	6.6	USP006CS6	USP006CDS6	44	$1\ 23/32$	0.43
	36	132	26	106	13	10	69	34	24.5	7.5	M10												

Remarks 1. In Part No. of unit and units with covers, fitting codes follow bore diameter codes. (See Table 10.5 in P.42.)
2. Clean size stainless steel series oval pillow type unit.
3. For the dimensions and forms of applicable bearings, see the dimensional tables of ball bearing for unit.

SBPP
Cylindrical bore
(with set screw locking)
SAPP
Cylindrical bore
(with eccentric locking collar)
 d 12 ~ 30 mm

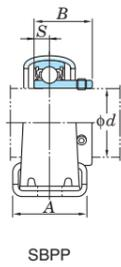

SBPP

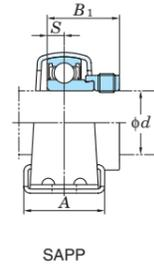
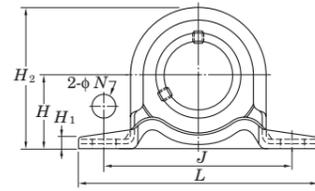

SAPP

Variations of tolerance of distance between centers of bolt holes (ΔL_s) and variations of tolerance of bolt hole diameter (ΔN_s)

Housing No.	ΔL_s	ΔN_s
PP203-PP206	± 0.4	± 0.5

Unit : mm

Shaft Dia mm inch	Dimensions inch mm										Bolt Size inch mm	Unit No.	Bearing No.	Unit No.	Bearing No.	Housing No.	Basic Load Ratings kN		Factor f_0	Mass kg	
	H	L	A	J	N	H_1	H_2	S	SBPP B	SAPP B_1							C_r	C_{0r}		SBPP	SAPP
12 1/2	7/8	3 3/8	31/32	2 43/64	3/8	1/8	1 23/32	0.236	0.866	1.122	5/16 M8	SBPP201 SBPP201-8 SBPP202 SBPP202-10 SBPP203	SB201 SB201-8 SB202 SB202-10 SB203	SAPP201 SAPP201-8 SAPP202 SAPP202-10 SAPP203	PP203	9.55	4.80	13.2	0.16	0.19	
	22.2	86	25	68	9.5	3.2	43.8	6	22	28.5											
15 5/8	1	3 27/32	1 1/4	2 63/64	3/8	1/8	2	0.276	0.984	1.161	5/16 M8	SBPP204-12 SBPP204	SB204-12 SB204	SAPP204-12 SAPP204	PP204	12.8	6.65	13.2	0.23	0.23	
	25.4	98	32	76	9.5	3.2	50.5	7	25	29.5											
17	1 1/8	4 1/4	1 1/4	3 25/64	29/64	5/32	2 7/32	0.295	1.063	1.201	3/8 M10	SBPP205-14 SBPP205-15 SBPP205 SBPP205-16	SB205-14 SB205-15 SB205 SB205-16	SAPP205-14 SAPP205-15 SAPP205 SAPP205-16	PP205	14.0	7.85	13.9	0.28	0.32	
	28.6	108	32	86	11.5	4	56.6	7.5	27	30.5											
20 3/4	1 5/8	4 19/32	1 1/2	3 3/4	29/64	5/32	2 5/8	0.315	1.181	1.335	3/8 M10	SBPP206-18 SBPP206 SBPP206-19 SBPP206-20	SB206-18 SB206 SB206-19 SB206-20	SAPP206-18 SAPP206 SAPP206-19 SAPP206-20	PP206	19.5	11.3	13.9	0.47	0.50	
	33.3	117	38	95	11.5	4	66.3	8	30	33.9											

Remark For the dimensions and forms of applicable bearings, see the dimensional tables of ball bearing for unit.

Square four-bolt flange type units

UCF
Cylindrical bore (with set screws)
d 12 ~ (45) mm

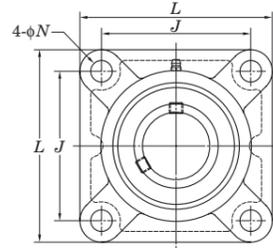
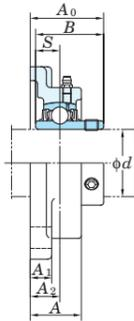

With Pressed Steel Cover

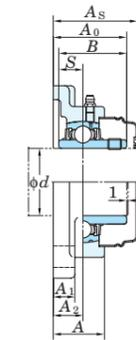

With Cast Iron Cover

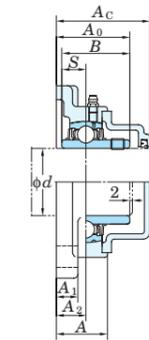

Variations of tolerance of distance from mounting surface to center of spherical bore (ΔA_{2s}) and tolerance of position of bolt hole (X)

Housing No.			ΔA_{2s}	X
F204-F210	FX05-FX10	F305-F315	± 0.5	0.7
F211-F218	FX11-FX20	F311-F328	± 0.8	1

Unit : mm

Variations of tolerance of bolt hole diameter (ΔN_s)

Housing No.			ΔN_s
F204-F218	FX05-FX18	F305-F315	± 0.2
FX20		F316-F328	± 0.3

Unit : mm

Shaft Dia. mm inch	Dimensions										Bolt Size inch mm	Standard			Mass kg	Basic Load Ratings kN		Factor f_0	With Pressed Steel Cover				With Cast Iron Cover			
	inch mm											Unit No.	Housing No.	Bearing No.		Unit No.	Dimension mm inch		Mass kg	Unit No.	Dimension mm inch	Mass kg				
d	L	A	J	N	A ₁	A ₂	A ₀	B	S					C _r	C _{0r}		Open Type	Closed Type	A _s		Open Type	Closed Type	A _c			
12												UCF201					UCF201C	UCF201D	37	1 15/32	0.64	-	-	-	-	
15												UCF201-8					-	-	-	-	-	-	-	-	-	
17												UCF202	F204				UCF202C	UCF202D	37	1 15/32	0.62	-	-	-	-	
20												UCF202-10					-	-	-	-	-	-	-	-	-	
												UCF203					UCF203C	UCF203D	37	1 15/32	0.61	-	-	-	-	
												UCF204-12					-	-	-	-	-	-	-	-	-	
												UCF204					UCF204C	UCF204D	37	1 15/32	0.59	UCF204FC	UCF204FD	46	1 13/16	0.74
												UCF205-14					-	-	-	-	-	-	-	-	-	
												UCF205-15	F205				-	-	-	-	-	-	-	-	-	
												UCF205					UCF205C	UCF205D	40	1 9/16	0.83	UCF205FC	UCF205FD	49	1 15/16	1.0
												UCF205-16					-	-	-	-	-	-	-	-	-	
												UCFX05	FX05				UCFX05C	UCFX05D	44	1 23/32	1.2	-	-	-	-	
												UCFX05-16					-	-	-	-	-	-	-	-	-	
												UCF305	F305				-	-	-	-	-	UCF305C	UCF305D	54	2 1/8	1.6
												UCF305-16					-	-	-	-	-	-	-	-	-	
												UCF206-18					-	-	-	-	-	-	-	-	-	
												UCF206	F206				UCF206C	UCF206D	44	1 23/32	1.1	UCF206FC	UCF206FD	53	2 3/32	1.4
												UCF206-19					-	-	-	-	-	-	-	-	-	
												UCF206-20					-	-	-	-	-	-	-	-	-	
												UCFX06	FX06				UCFX06C	UCFX06D	49	1 15/16	1.6	-	-	-	-	
												UCFX06-19					-	-	-	-	-	-	-	-	-	
												UCFX06-20					-	-	-	-	-	-	-	-	-	
												UCF306	F306				-	-	-	-	-	UCF306C	UCF306D	59	2 5/16	2.2
												UCF207-20					-	-	-	-	-	-	-	-	-	
												UCF207-21					-	-	-	-	-	-	-	-	-	
												UCF207-22	F207				-	-	-	-	-	-	-	-	-	
												UCF207					UCF207C	UCF207D	49	1 15/16	1.5	UCF207FC	UCF207FD	58	2 9/32	1.9
												UCF207-23					-	-	-	-	-	-	-	-	-	
												UCFX07-22	FX07				-	-	-	-	-	-	-	-	-	
												UCFX07					UCFX07C	UCFX07D	55	2 5/32	2.0	-	-	-	-	
												UCFX07-23					-	-	-	-	-	-	-	-	-	
												UCF307	F307				-	-	-	-	-	UCF307C	UCF307D	64	2 17/32	2.7
												UCF208-24					-	-	-	-	-	-	-	-	-	
												UCF208-25	F208				-	-	-	-	-	-	-	-	-	
												UCF208					UCF208C	UCF208D	55	2 5/32	1.9	UCF208FC	UCF208FD	64	2 17/32	2.3
												UCFX08-24	FX08				-	-	-	-	-	-	-	-	-	
												UCFX08					UCFX08C	UCFX08D	56	2 7/32	2.4	-	-	-	-	
												UCF308-24	F308				-	-	-	-	-	-	-	-	-	
												UCF308					-	-	-	-	-	UCF308C	UCF308D	71	2 25/32	3.6
												UCF209-26					-	-	-	-	-	-	-	-	-	
												UCF209-27	F209				-	-	-	-	-	-	-	-	-	
												UCF209-28					-	-	-	-	-	-	-	-	-	
												UCF209					UCF209C	UCF209D	56	2 7/32	2.2	UCF209FC	UCF209FD	66	2 19/32	2.6
												UCFX09-28	FX09				-	-	-	-	-	-	-	-	-	
												UCFX09					UCFX09C	UCFX09D	60	2 3/8	2.7	-	-	-	-	

Remarks 1. In Part No. of unit and units with covers, fitting codes follow bore diameter numbers. (See Table 10.5 in P.42.)

2. Part No. of applicable grease nipples are shown below.

A-1/4-28UNF 201~210, X05~X09, 305~308

A-PT1/8 211~218, X10~X20, 309~328

3. As for the triple seal type product (from 201 to 205 are the double seal type products), accessory code L3 (L2) follows the Part No. of unit or bearing. (Example of Part No. : UCF206JL3, UC206L3)

4. For the dimensions and forms of applicable bearings, see the dimensional tables of ball bearing for unit.

Square four-bolt flange type units

UCF
Cylindrical bore (with set screws)
d (45) ~ (75) mm

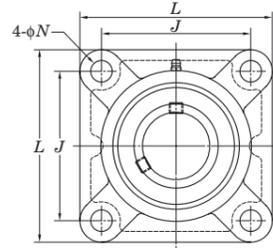
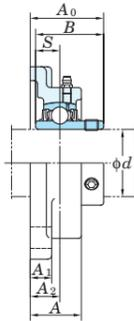

With Pressed Steel Cover

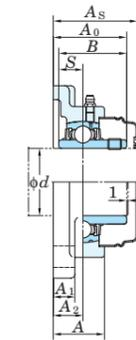

With Cast Iron Cover

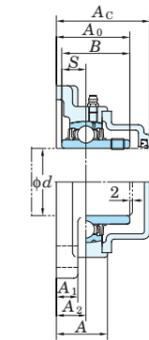

Variations of tolerance of distance from mounting surface to center of spherical bore (ΔA_{2s}) and tolerance of position of bolt hole (X)

Housing No.			ΔA_{2s}	X
F204-F210	FX05-FX10	F305-F310	± 0.5	0.7
F211-F218	FX11-FX20	F311-F328	± 0.8	1

Variations of tolerance of bolt hole diameter (ΔN_s)

Housing No.			ΔN_s
F204-F218	FX05-FX18	F305-F315	± 0.2
	FX20	F316-F328	± 0.3

Shaft Dia. mm inch	Dimensions										Bolt Size inch mm	Standard			Mass kg	Basic Load Ratings kN		Factor f_0	With Pressed Steel Cover				With Cast Iron Cover			
	L	A	J	N	A_1	A_2	A_0	B	S	Unit No.		Housing No.	Bearing No.	Unit No. Open Type		Unit No. Closed Type	Dimension mm inch		Mass kg	Unit No. Open Type	Unit No. Closed Type	Dimension mm inch	Mass kg			
45 1 3/4	6 5/16	1 23/32	4 59/64	3/4	23/32	63/64	2 3/8	2.244	0.866	5/8	UCF309-28	F309	UC309-28	-	-	-	-	-	-	-	-	-	-			
	160	44	125	19	18	25	60	57	22	M16	UCF309	UC309	UCF309C	UCF309D	76	3	UCF309C	UCF309D	76	3	4.6					
50 1 7/8 1 15/16 2 1 15/16	5 5/8	1 9/16	4 3/8	5/8	5/8	55/64	2 5/32	2.031	0.748	1/2	UCF210-30	F210	UC210-30	-	-	-	-	-	-	-	-	-				
	143	40	111	16	16	22	54.6	51.6	19	M14	UCF210-31	UC210-31	UCF210C	UCF210D	59	2 5/16	UCF210FC	UCF210FD	70.5	2 25/32	3.0					
	2										UCF210	UC210	-	-	-	-	-	-	-	-	-					
	1 15/16	6 3/8	1 23/32	5 1/8	3/4	25/32	1 1/32	2 11/32	2.189	0.874	5/8	UCFX10-31	FX10	UCX10-31	-	-	-	-	-	-	-	-				
2	162	44	130	19	20	26	59.4	55.6	22.2	M16	UCFX10	UCX10	UCFX10C	UCFX10D	64	2 17/32	-	-	-	-	-					
-	6 7/8	1 7/8	5 13/64	29/32	3/4	1 7/64	2 5/8	2.402	0.866	3/4	UCF310	F310	UC310	-	-	-	-	-	-	-	-					
2	175	48	132	23	19	28	67	61	22	M20			UCF310C	UCF310D	83	3 9/32	UCF310C	UCF310D	83	3 9/32	5.9					
55 2 2 1/8 2 3/16	6 3/8	1 11/16	5 1/8	3/4	23/32	63/64	2 5/16	2.189	0.874	5/8	UCF211-32	F211	UC211-32	-	-	-	-	-	-	-	-	-				
	162	43	130	19	18	25	58.4	55.6	22.2	M16	UCF211-34	UC211-34	UCF211C	UCF211D	63	2 15/32	UCF211FC	UCF211FD	74.5	2 15/16	4.0					
	2 3/16										UCF211	UC211	-	-	-	-	-	-	-	-	-					
	2	6 7/8	1 15/16	5 5/8	3/4	25/32	1 9/64	2 23/32	2.563	1.000	5/8	UCFX11	FX11	UCX11	UCFX11C	UCFX11D	73	2 7/8	-	-	-	-				
2 3/16	175	49	143	19	20	29	68.7	65.1	25.4	M16	UCFX11-35	UCX11-35	-	-	-	-	-	-	-	-						
2 1/4											UXPX11-36	UCX11-36	-	-	-	-	-	-	-	-						
2	7 9/32	2 1/16	5 33/64	29/32	25/32	1 3/16	2 25/32	2.598	0.984	3/4	UCF311-32	F311	UC311-32	-	-	-	-	-	-	-	-					
-	185	52	140	23	20	30	71	66	25	M20	UCF311	UC311	UCF311C	UCF311D	87	3 7/16	UCF311C	UCF311D	87	3 7/16	6.5					
60 2 1/4 2 3/8 2 7/16	6 7/8	1 7/8	5 5/8	3/4	23/32	1 9/64	2 23/32	2.563	1.000	5/8	UCF212-36	F212	UC212-36	-	-	-	-	-	-	-	-					
	175	48	143	19	18	29	68.7	65.1	25.4	M16	UCF212	UC212	UCF212C	UCF212D	73	2 7/8	UCF212FC	UCF212FD	86	3 3/8	5.0					
	2 7/16										UCF212-38	UC212-38	-	-	-	-	-	-	-	-						
	2	7 3/8	2 5/16	5 55/64	3/4	13/16	1 11/32	2 29/32	2.563	1.000	5/8	UCFX12	FX12	UCX12	UCFX12C	UCFX12D	78	3 1/16	-	-	-	-				
2 3/8	187	59	149	19	21	34	73.7	65.1	25.4	M16	UCFX12-39	UCX12-39	-	-	-	-	-	-	-							
-	195	56	150	23	22	33	78	71	26	M20	UCF312	F312	UC312	-	-	-	-	-	-	-						
2 1/2	7 3/8	1 31/32	5 55/64	3/4	7/8	1 3/16	2 3/4	2.563	1.000	5/8	UCF213-40	F213	UC213-40	-	-	-	-	-	-	-	-					
2 1/2	187	50	149	19	22	30	69.7	65.1	25.4	M16	UCF213	UC213	UCF213C	UCF213D	74	2 29/32	UCF213FC	UCF213FD	87	3 7/16	6.0					
2 1/2	7 3/8	2 5/16	5 55/64	3/4	13/16	1 11/32	3 3/32	2.937	1.189	5/8	UCFX13-40	FX13	UCX13-40	UCFX13C	UCFX13D	83	3 9/32	-	-	-	-					
2 1/2	187	59	149	19	21	34	78.4	74.6	30.2	M16	UCFX13	UCX13	-	-	-	-	-	-	-							
2 1/2	8 3/16	2 9/32	6 17/32	29/32	7/8	1 19/64	3 1/16	2.953	1.181	3/4	UCF313-40	F313	UC313-40	-	-	-	-	-	-	-						
-	208	58	166	23	22	33	78	75	30	M20	UCF313	UC313	UCF313C	UCF313D	94	3 11/16	UCF313C	UCF313D	94	3 11/16	8.9					
70 2 3/4 2 3/4 2 3/4	7 19/32	2 1/8	5 63/64	3/4	7/8	1 7/32	2 31/32	2.937	1.189	5/8	UCF214-44	F214	UC214-44	-	-	-	-	-	-	-	-					
	193	54	152	19	22	31	75.4	74.6	30.2	M16	UCF214	UC214	UCF214C	UCF214D	80	3 5/32	UCF214FC	UCF214FD	93	3 21/32	6.8					
	2 3/4										UCFX14-44	FX14	UCX14-44	-	-	-	-	-	-	-						
	2 3/4	7 3/4	2 3/8	5 63/64	29/32	7/8	1 29/64	3 7/32	3.063	1.331	3/4	UCFX14	UCX14	UCFX14C	UCFX14D	86	3 3/8	-	-	-	-					
2 3/4	197	60	152	23	22	37	81.5	77.8	33.3	M20	UCF314-44	F314	UC314-44	-	-	-	-	-	-	-						
2 3/4	8 29/32	2 13/32	7 1/64	63/64	31/32	1 27/64	3 3/16	3.071	1.299	7/8	UCF314	UC314	UCF314C	UCF314D	98	3 27/32	UCF314C	UCF314D	98	3 27/32	11.2					
2 15/16	226	61	178	25	25	36	81	78	33	M22			-	-	-	-	-	-	-							
75 3 2 15/16 3	7 7/8	2 7/32	6 17/64	3/4	7/8	1 11/32	3 3/32	3.063	1.311	5/8	UCF215-47	F215	UC215-47	-	-	-	-	-	-	-	-					
	200	56	159	19	22	34	78.5	77.8	33.3	M16	UCF215	UC215	UCF215C	UCF215D	83	3 9/32	UCF215FC	UCF215FD	96	3 29/32	7.4					
	2 15/16										UCF215-48	UC215-48	-	-	-	-	-	-	-	-						
	3	7 3/4	2 11/16	5 63/64	29/32	15/16	1 9/16	3 17/32	3.252	1.311	3/4	UCFX15-47	FX15	UCX15-47	UCFX15C	UCFX15D	94	3 11/16	-	-	-	-				
3	197	68	152	23	24	40	89.3	82.6	33.3	M20	UCFX15	UCX15	-	-	-	-	-	-	-							

Remarks 1. In Part No. of unit and units with covers, fitting codes follow bore diameter numbers. (See Table 10.5 in P.42.)
2. Part No. of applicable grease nipples are shown below.
A-1/4-28UNF..... 201~210, X05~X09, 305~308
A-PT1/8..... 211~218, X10~X20, 309~328

3. As for the triple seal type product (from 201 to 205 are the double seal type products), accessory code L3 (L2) follows the Part No. of unit or bearing. (Example of Part No. : UCF206JL3, UC206L3)
4. For the dimensions and forms of applicable bearings, see the dimensional tables of ball bearing for unit.

Square four-bolt flange type units

UCF
Cylindrical bore (with set screws)
d (75) ~ 140 mm

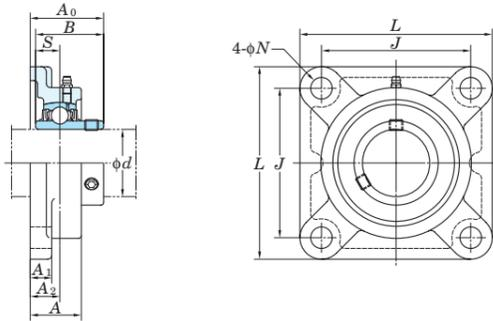

With Pressed Steel Cover With Cast Iron Cover

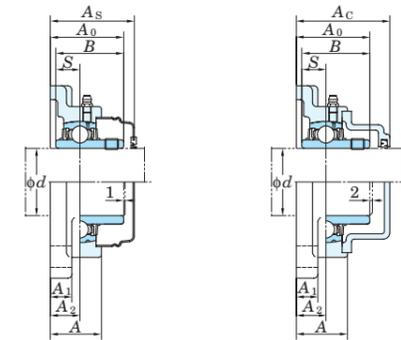

Variations of tolerance of distance from mounting surface to center of spherical bore (ΔA_{2s}) and tolerance of position of bolt hole (X)

Housing No.			ΔA_{2s}	X
F204-F210	FX05-FX10	F305-F310	± 0.5	0.7
F211-F218	FX11-FX20	F311-F328	± 0.8	1

Variations of tolerance of bolt hole diameter (ΔN_s)

Housing No.			ΔN_s
F204-F218	FX05-FX18	F305-F315	± 0.2
	FX20	F316-F328	± 0.3

Shaft Dia. mm inch	Dimensions										Bolt Size inch mm	Standard			Mass kg	Basic Load Ratings kN		Factor f_0	With Pressed Steel Cover				With Cast Iron Cover				
	d	L	A	J	N	A ₁	A ₂	A ₀	B	S		Unit No.	Housing No.	Bearing No.		Unit No.	Dimension mm inch		Mass kg	Unit No.	Dimension mm inch	Mass kg					
75 2 15/16 3	9 9/32	2 19/32	7 1/4	63/64	31/32	1 17/32	3 1/2	3.228	1.260	7/8	UCF315-47 UCF315 UCF315-48	F315	UC315-47 UC315 UC315-48	-	-	-	-	-	-	-	-						
	236	66	184	25	25	39	89	82	32	M22				11.6	113	77.2	13.2	-	-	-	-	-	-				
														11.6						UCF315C	UCF315D	106	4 3/16	12.9			
80 3 1/8	8 3/16	2 9/32	6 1/2	29/32	7/8	1 11/32	3 3/32	3.252	1.311	3/4	UCF216-50 UCF216	F216	UC216-50 UC216	-	-	-	-	-	-	-	-						
	208	58	165	23	22	34	83.3	82.6	33.3	M20				7.3	72.7	53.0	14.6	UCF216C	UCF216D	88	3 15/32	7.3	UCF216FC	UCF216FD	103	4 1/16	8.5
	8 7/16	2 3/4	6 47/64	29/32	15/16	1 9/16	3 19/32	3.374	1.343	3/4				9.4	84.0	61.9	14.5	UCFX16C	UCFX16D	96	3 25/32	9.4	-	-	-	-	
85 3 1/4	8 21/32	2 15/32	6 57/64	29/32	15/16	1 13/32	3 7/16	3.374	1.343	3/4	UCF217-52 UCF217	F217	UC217-52 UC217	-	-	-	-	-	-	-	-						
	220	63	175	23	24	36	87.6	85.7	34.1	M20				8.9	84.0	61.9	14.5	UCF217C	UCF217D	92	3 5/8	8.9	UCF217FC	UCF217FD	107	4 7/32	10.3
	8 7/16	2 3/4	6 47/64	29/32	15/16	1 9/16	3 25/32	3.780	1.563	3/4				10.8	96.1	71.5	14.5	UCFX17C	UCFX17D	101	3 31/32	10.8	-	-	-	-	
90 3 1/2	10 1/4	2 29/32	8 1/32	1 7/32	1 1/16	1 47/64	3 15/16	3.780	1.575	1	UCF317	F317	UC317	-	-	-	-	-	-	-	-						
	260	74	204	31	27	44	100	96	40	M27				15.3	133	96.8	13.3	-	-	-	-	-	-				
	9 1/4	2 11/16	7 23/64	29/32	31/32	1 9/16	3 29/32	3.780	1.563	3/4				11.4	96.1	71.5	14.5	UCF218C	UCF218D	101	3 31/32	11.4	UCF218FC	UCF218FD	116	4 9/16	12.9
95 3 3/8	8 7/16	3	6 47/64	29/32	15/16	1 49/64	4 3/16	4.094	1.689	3/4	UCFX18	FX18	UCX18	-	-	-	-	-	-	-	-						
	214	76	171	23	24	45	106.1	104	42.9	M20				11.9	109	81.9	14.4	-	-	-	-	-	-				
	11 1/32	3	8 1/2	1 3/8	1 3/16	1 47/64	3 15/16	3.780	1.575	1 1/8				18.9	143	107	13.3	-	-	-	-	-	-				
100 3 15/16 4	11 13/32	3 11/16	8 31/32	1 3/8	1 3/16	2 21/64	4 3/4	4.055	1.614	1 1/8	UCF319	F319	UC319	-	-	-	-	-	-	-	-						
	290	94	228	35	30	59	121	103	41	M30				21.6	153	119	13.3	-	-	-	-	-	-				
	10 9/16	3 13/16	8 5/16	1 7/32	1 3/32	2 21/64	5	4.626	1.937	1				19.4	133	105	14.4	-	-	-	-	-	-				
105	12 7/32	3 11/16	9 17/32	1 1/2	1 1/4	2 21/64	5	4.409	1.732	1 1/4	UCFX20-63 UCFX20-64	FX20	UCX20-63 UCX20-64	-	-	-	-	-	-	-	-						
	268	97	211	31	28	59	127.3	117.5	49.2	M27				19.4					UCF320C	UCF320D	146	5 3/4	28.6				
														25.8													
110	12 7/32	3 11/16	9 17/32	1 1/2	1 1/4	2 21/64	5	4.409	1.732	1 1/4	UCF320-63 UCF320-64	F320	UC320-63 UC320-64	-	-	-	-	-	-	-	-						
	310	94	242	38	32	59	125	108	42	M33				25.8	173	141	13.2	-	-	-	-	-					
														25.8													
120	13 3/8	3 25/32	10 15/32	1 39/64	1 3/8	2 23/64	5 9/32	4.606	1.811	1 3/8	UCF321	F321	UC321	-	-	-	-	-	-	-	-						
	340	96	266	41	35	60	131	117	46	M36				30.2	184	153	13.2	-	-	-	-	-					
														35.3	205	180	13.2	-	-	-	-	-					
130	14 9/16	4 11/32	11 27/64	1 39/64	1 9/16	2 9/16	5 1/2	4.961	2.008	1 3/8	UCF322	F322	UC322	-	-	-	-	-	-	-	-						
	370	110	290	41	40	65	140	126	51	M36				47.3	207	185	13.5	-	-	-	-	-					
														65.5	229	214	13.6	-	-	-	-	-					
140	16 3/32	4 17/32	12 19/32	1 39/64	1 25/32	2 9/16	5 3/4	5.315	2.126	1 3/8	UCF324	F324	UC324	-	-	-	-	-	-	-	-						
	410	115	320	41	45	65	146	135	54	M36				65.5	229	214	13.6	-	-	-	-	-					
														65.5	229	214	13.6	-	-	-	-	-					
140	17 23/32	4 29/32	13 25/32	1 39/64	2 5/32	2 61/64	6 11/32	5.709	2.323	1 3/8	UCF326	F326	UC326	-	-	-	-	-	-	-	-						
	450	125	350	41	55	75	161	145	59	M36				93.4	253	246	13.6	-	-	-	-	-					
														93.4	253	246	13.6	-	-	-	-	-					

Remarks 1. In Part No. of unit and units with covers, fitting codes follow bore diameter numbers. (See Table 10.5 in P.42.)
2. Part No. of applicable grease nipples are shown below.
A-1/4-28UNF 201-210, X05-X09, 305-308
A-PT1/8 211-218, X10-X20, 309-328

3. As for the triple seal type product (from 201 to 205 are the double seal type products), accessory code L3 (L2) follows the Part No. of unit or bearing. (Example of Part No. : UCF206JL3, UC206L3)
4. For the dimensions and forms of applicable bearings, see the dimensional tables of ball bearing for unit.

Square four-bolt flange type units

UCF-E
Cylindrical bore (with set screws)
d 12 ~ 55 mm

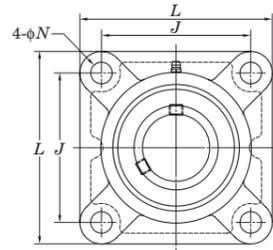
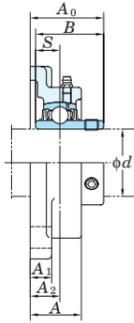

Variations of tolerance of distance from mounting surface to center of spherical bore (ΔA_{2s}) and tolerance of position of bolt hole (X)

Housing No.		ΔA_{2s}	X
F204E-F210E	FX05E-FX10E	± 0.5	0.7
F211E-F217E	FX11E-FX17E	± 0.8	1

Variations of tolerance of bolt hole diameter (ΔN_s)

Housing No.		ΔN_s
F204E-F217E	FX05E-FX17E	± 0.2

Shaft Dia. mm inch	Dimensions inch mm	Bolt Size inch	Unit No.	Housing No.	Bearing No.	Basic Load Ratings kN		Factor f_0	Mass kg
						C_r	C_{0r}		
12 1/2	L: 3 3/8, A: 1, J: 2 33/64, N: 7/16, A1: 7/16, A2: 19/32, A0: 1 5/16, B: 1.220, S: 0.500	3/8	UCF201E, UCF201E-8, UCF202E, UCF202E-10, UCF203E, UCF204E-12, UCF204E	F204E	UC201, UC201-8, UC202, UC202-10, UC203, UC204-12, UC204	12.8	6.65	13.2	0.64, 0.62, 0.61, 0.59
15 5/8	L: 3 3/4, A: 1 1/16, J: 2 3/4, N: 29/64, A1: 1/2, A2: 5/8, A0: 1 13/32, B: 1.343, S: 0.563	3/8	UCF205E-14, UCF205E-15, UCF205E, UCF205E-16	F205E	UC205-14, UC205-15, UC205, UC205-16	14.0	7.85	13.9	0.83
17 3/4	L: 4 1/4, A: 1 3/16, J: 3 17/64, N: 29/64, A1: 1/2, A2: 45/64, A0: 1 19/32, B: 1.500, S: 0.626	3/8	UCFX05E, UCFX05E-16	FX05E	UCX05, UCX05-16	19.5	11.3	13.9	1.2
20	L: 4 1/4, A: 1 7/32, J: 3 17/64, N: 33/64, A1: 1/2, A2: 45/64, A0: 1 19/32, B: 1.500, S: 0.626	7/16	UCF206E-18, UCF206E, UCF206E-19, UCF206E-20	F206E	UC206-18, UC206, UC206-19, UC206-20	19.5	11.3	13.9	1.1
25	L: 4 19/32, A: 1 11/32, J: 3 5/8, N: 33/64, A1: 9/16, A2: 3/4, A0: 1 3/4, B: 1.689, S: 0.689	7/16	UCFX06E, UCFX06E-19, UCFX06E-20	FX06E	UCX06, UCX06-19, UCX06-20	25.7	15.4	13.9	1.6
30	L: 4 19/32, A: 1 11/32, J: 3 5/8, N: 33/64, A1: 19/32, A2: 3/4, A0: 1 3/4, B: 1.689, S: 0.689	7/16	UCF207E-20, UCF207E-21, UCF207E-22, UCF207E, UCF207E-23	F207E	UC207-20, UC207-21, UC207-22, UC207, UC207-23	25.7	15.4	13.9	1.5
35	L: 5 1/8, A: 1 1/2, J: 4 1/64, N: 33/64, A1: 9/16, A2: 53/64, A0: 2 1/32, B: 1.937, S: 0.748	7/16	UCFX07E-22, UCFX07E, UCFX07E-23	FX07E	UCX07-22, UCX07, UCX07-23	29.1	17.8	14.0	2.0
40	L: 5 1/8, A: 1 13/32, J: 4 1/64, N: 35/64, A1: 19/32, A2: 53/64, A0: 2 1/32, B: 1.937, S: 0.748	1/2	UCF208E-24, UCF208E-25, UCF208E	F208E	UC208-24, UC208-25, UC208	29.1	17.8	14.0	1.9
45	L: 5 13/32, A: 1 9/16, J: 4 9/64, N: 19/32, A1: 9/16, A2: 55/64, A0: 2 1/16, B: 1.937, S: 0.748	1/2	UCFX08E-24, UCFX08E	FX08E	UCX08-24, UCX08	34.1	21.3	14.0	2.4
50	L: 5 5/8, A: 1 9/16, J: 4 3/8, N: 19/32, A1: 9/16, A2: 29/32, A0: 2 3/16, B: 2.031, S: 0.748	1/2	UCFX09E-28, UCFX09E	FX09E	UCX09-28, UCX09	35.1	23.3	14.4	2.7
55	L: 6 3/8, A: 1 23/32, J: 5 1/8, N: 21/32, A1: 25/32, A2: 1 1/32, A0: 2 11/32, B: 2.189, S: 0.874	9/16	UCFX10E-31, UCFX10E, UCFX10E-32	FX10E	UCX10-31, UCX10, UCX10-32	43.4	29.4	14.4	3.7
60	L: 6 3/8, A: 1 11/16, J: 5 1/8, N: 43/64, A1: 23/32, A2: 63/64, A0: 2 5/16, B: 2.189, S: 0.874	5/8	UCF211E-32, UCF211E-34, UCF211E, UCF211E-35	F211E	UC211-32, UC211-34, UC211, UC211-35	43.4	29.4	14.4	3.4
65	L: 6 7/8, A: 1 15/16, J: 5 5/8, N: 21/32, A1: 25/32, A2: 1 9/64, A0: 2 23/32, B: 2.563, S: 1.000	9/16	UCFX11E, UCFX11E-35, UCFX11E-36	FX11E	UCX11, UCX11-35, UCX11-36	52.4	36.2	14.4	4.9

Remarks 1. In Part No. of unit, fitting codes follow bore diameter numbers. (See Table 10.5 in P.42.)
2. Part No. of applicable grease nipples are shown below.
A-1/4-28UNF..... 201~208, X05~X09
A-PT1/8..... 211~217, X10~X17

3. As for the triple seal type product (from 201 to 205 are the double seal type products), accessory code L3 (L2) follows the Part No. of unit or bearing. (Example of Part No. : UCF206EJL3, UC206L3)
4. For the dimensions and forms of applicable bearings, see the dimensional tables of ball bearing for unit.

Square four-bolt flange type units

UCF-E
Cylindrical bore (with set screws)
d 60 ~ 85 mm

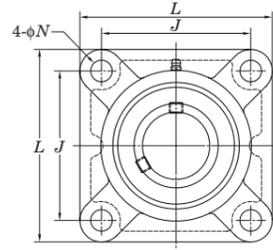
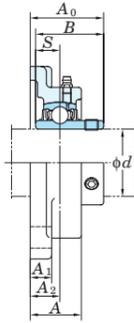

Variations of tolerance of distance from mounting surface to center of spherical bore (ΔA_{2s}) and tolerance of position of bolt hole (X)

Housing No.		ΔA_{2s}	X
F204E-F210E	FX05E-FX10E	± 0.5	0.7
F211E-F217E	FX11E-FX17E	± 0.8	1

Variations of tolerance of bolt hole diameter (ΔN_s)

Housing No.		ΔN_s
F204E-F217E	FX05E-FX17E	± 0.2

Shaft Dia. mm inch	Dimensions inch mm										Bolt Size inch	Unit No.	Housing No.	Bearing No.	Basic Load Ratings kN		Factor f_0	Mass kg
	d	L	A	J	N	A ₁	A ₂	A ₀	B	S					C _r	C _{0r}		
60	2 1/4	6 7/8	1 7/8	5 5/8	43/64	23/32	1 9/64	2 23/32	2.563	1.000	5/8	UCF212E-36 UCF212E UCF212E-38 UCF212E-39	F212E	UC212-36 UC212 UC212-38 UC212-39	52.4	36.2	14.4	4.2
	2 3/8	175	48	143	17	18	29	68.7	65.1	25.4								
	2 7/16	7 3/8	2 5/16	5 55/64	21/32	13/16	1 11/32	2 29/32	2.563	1.000	9/16	UCFX12E UCFX12E-39	FX12E	UCX12 UCX12-39	57.2	40.1	14.4	5.7
65	2 1/2	7 3/8	1 31/32	5 55/64	43/64	7/8	1 3/16	2 3/4	2.563	1.000	5/8	UCF213E-40 UCF213E	F213E	UC213-40 UC213	57.2	40.1	14.4	5.2
	2 1/2	7 3/8	1 31/32	5 55/64	21/32	13/16	1 11/32	3 3/32	2.937	1.189	9/16	UCFX13E-40 UCFX13E	FX13E	UCX13-40 UCX13	62.2	44.1	14.5	6.3
70	2 3/4	7 3/4	2 3/8	5 63/64	25/32	7/8	1 29/64	3 7/32	3.063	1.331	11/16	UCFX14E-44 UCFX14E	FX14E	UCX14-44 UCX14	67.4	48.3	14.5	7.0
	2 15/16	7 3/4	2 11/16	5 63/64	25/32	15/16	1 9/16	3 17/32	3.252	1.311	11/16	UCFX15E-47 UCFX15E UCFX15E-48	FX15E	UCX15-47 UCX15 UCX15-48	72.7	53.0	14.6	8.4
80	3 1/8	8 3/16	2 9/32	6 1/2	3/4	7/8	1 11/32	3 9/32	3.252	1.311	11/16	UCF216E-50 UCF216E	F216E	UC216-50 UC216	72.7	53.0	14.6	7.3
	-	8 7/16	2 3/4	6 47/64	25/32	15/16	1 9/16	3 19/32	3.374	1.343	11/16	UCFX16E	FX16E	UCX16	84.0	61.9	14.5	9.4
85	3 1/4	8 21/32	2 15/32	6 57/64	3/4	15/16	1 13/32	3 7/16	3.374	1.343	11/16	UCF217E-52 UCF217E	F217E	UC217-52 UC217	84.0	61.9	14.5	8.9
	3 7/16	8 7/16	2 3/4	6 47/64	25/32	15/16	1 9/16	3 25/32	3.780	1.563	11/16	UCFX17E UCFX17E-55	FX17E	UCX17 UCX17-55	96.1	71.5	14.5	10.8

Remarks 1. In Part No. of unit, fitting codes follow bore diameter numbers. (See Table 10.5 in P.42.)
2. Part No. of applicable grease nipples are shown below.
A-1/4-28UNF 201~208, X05~X09
A-PT1/8 211~217, X10~X17

3. As for the triple seal type product (from 201 to 205 are the double seal type products), accessory code L3 (L2) follows the Part No. of unit or bearing. (Example of Part No. : UCF206EJL3, UC206L3)
4. For the dimensions and forms of applicable bearings, see the dimensional tables of ball bearing for unit.

Square four-bolt flange type units

NANF
Cylindrical bore
(with eccentric locking collar)
d 12 ~ 60 mm

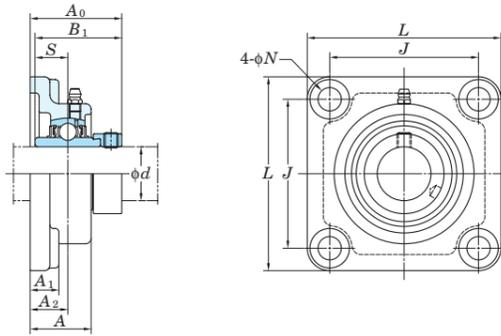

Variations of tolerance of distance from mounting surface to center of spherical bore (Δ_{A2s}) and tolerance of center position of bolt hole (X)

Housing No.	Δ_{A2s}	X
NF204~NF210	± 0.5	0.7
NF211~NF212	± 0.8	1

Variations of tolerance of bolt hole diameter (Δ_{Ns})

Housing No.	Δ_{Ns}
NF204~NF212	± 0.2

Shaft Dia mm inch d	Dimensions inch mm										Bolt Size inch	Unit No.	Housing No.	Bearing No.	Basic Load Ratings kN		Factor f_0	Mass kg
	L	A	J	N	A ₁	A ₂	A ₀	B ₁	S	C _r					C _{0r}			
12 1/2												NANF201 NANF201-8 NANF202 NANF202-10 NANF203 NANF204-12 NANF204	NF204	NA201 NA201-8 NA202 NA202-10 NA203 NA204-12 NA204	12.8	6.65	13.2	0.73
15 5/8	3 3/8	1 5/32	2 33/64	7/16	19/32	3/4	1 25/32	1.720	0.673		3/8							
17 3/4	86	29.5	64	11	15	19	45.6	43.7	17.1									
20												NANF205-14 NANF205-15 NANF205 NANF205-16	NF205	NA205-14 NA205-15 NA205 NA205-16	14.0	7.85	13.9	0.95
25 7/8 15/16	3 3/4	1 7/32	2 3/4	29/64	19/32	25/32	1 27/32	1.748	0.689		3/8							
25 1	95	31	70	11.5	15	20	46.9	44.4	17.5									
30 1 1/8	4 1/4	1 11/32	3 17/64	33/64	5/8	53/64	2	1.906	0.720		7/16							
30 1 3/16	108	34	83	13	16	21	51.1	48.4	18.3									
30 1 1/4												NANF206-18 NANF206 NANF206-19 NANF206-20	NF206	NA206-18 NA206 NA206-19 NA206-20	19.5	11.3	13.9	1.4
35 1 1/4												NANF207-20 NANF207-21 NANF207-22 NANF207 NANF207-23	NF207	NA207-20 NA207-21 NA207-22 NA207 NA207-23	25.7	15.4	13.9	1.8
35 1 5/16	4 19/32	1 7/16	3 5/8	33/64	21/32	27/32	2 1/8	2.012	0.740		7/16							
35 1 3/8	117	36.5	92	13	17	21.5	53.8	51.1	18.8									
35 1 7/16												NANF208-24 NANF208-25 NANF208	NF208	NA208-24 NA208-25 NA208	29.1	17.8	14.0	2.2
40 1 1/2	5 1/8	1 17/32	4 1/64	35/64	21/32	15/16	2 5/16	2.217	0.843		1/2							
40 1 9/16	130	39	102	14	17	24	58.9	56.3	21.4									
45 1 5/8												NANF209-26 NANF209-27 NANF209-28 NANF209	NF209	NA209-26 NA209-27 NA209-28 NA209	34.1	21.3	14.0	2.6
45 1 11/16	5 13/32	1 9/16	4 9/64	5/8	23/32	15/16	2 5/16	2.217	0.843		9/16							
45 1 3/4	137	40	105	16	18	24	58.9	56.3	21.4									
50 1 7/8												NANF210-30 NANF210-31 NANF210 NANF210-32	NF210	NA210-30 NA210-31 NA210 NA210-32	35.1	23.3	14.4	3
50 1 15/16	5 5/8	1 27/32	4 3/8	5/8	25/32	1 1/8	2 5/8	2.469	0.969		9/16							
50 2	143	46.5	111	16	20	28.5	66.6	62.7	24.6									
55 2												NANF211-32 NANF211-34 NANF211 NANF211-35	NF211	NA211-32 NA211-34 NA211 NA211-35	43.4	29.4	14.4	4.1
55 2 1/8	6 3/8	1 31/32	5 1/8	43/64	13/16	1 17/64	2 31/32	2.811	1.094		5/8							
55 2 3/16	162	50	130	17	21	32	75.6	71.4	27.8									
55 2 1/4												NANF212-36 NANF212 NANF212-38 NANF212-39	NF212	NA212-36 NA212 NA212-38 NA212-39	52.4	36.2	14.4	4.9
60 2 3/8	6 7/8	2 5/32	5 5/8	43/64	13/16	1 27/64	3 1/4	3.063	1.220		5/8							
60 2 7/16	175	55	143	17	21	36	82.8	77.8	31									

Remarks 1. In Part No. of unit and units with covers, fitting codes follow bore diameter numbers. (See Table 10.5 in P.42.)
 2. Part No. of applicable grease nipples are shown below.
 A-1/4-28UNF 201~210
 A-PT1/8 211~212

3. For the dimensions and forms of applicable bearings, see the dimensional tables of ball bearing for unit.

Square four-bolt flange type units

UKF
Tapered bore (with adapter)
d₁ 20 ~ (50) mm

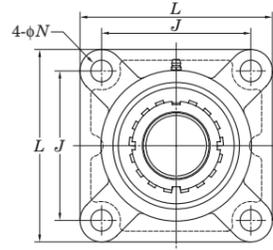
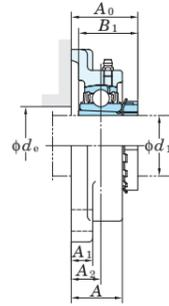

With Pressed Steel Cover

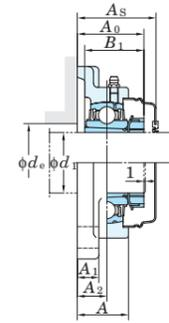

With Cast Iron Cover

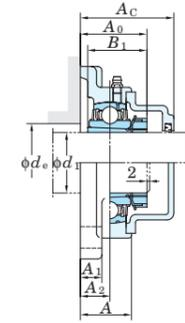

Variations of tolerance of distance from mounting surface to center of spherical bore (ΔA_{2s}) and tolerance of position of bolt hole (X)

Housing No.			ΔA _{2s}	X
F205-F210	FX05-FX10	F305-F310	±0.5	0.7
F211-F218	FX11-FX20	F311-F328	±0.8	1

Unit : mm

Variations of tolerance of bolt hole diameter (ΔN_s)

Housing No.			ΔN _s
F205-F210	FX05-FX10	F305-F315	±0.2
	FX20	F316-F328	±0.3

Unit : mm

Shaft Dia. mm inch	Dimensions										Bolt Size inch mm	Standard			Adapter ¹⁾ No.	Mass kg	Basic			With Pressed Steel Cover			With Cast Iron Cover			
	inch mm											Unit No.	Housing No.	Bearing No.			Load Ratings kN	Factor	Unit No.		Dimension	Mass	Unit No.		Dimension	Mass
d ₁	L	A	J	N	A ₁	A ₂	A ₀ ¹⁾	B ₁ ¹⁾	d _e (min.)					C _r	C _{0r}	f ₀	Open Type	Closed Type	mm inch	kg	Open Type	Closed Type	mm inch	kg		
20	3/4	3 3/4	1 1/16	2 3/4	15/32	1/2	5/8	1 11/32(1 13/32)	1 5/32(1 3/8)	1 3/16	3/8	UKF205	F205	UK205												
		95	27	70	12	13	16	34.5(36)	29(35)	30	M10															
	3/4	4 1/4	1 3/16	3 17/64	15/32	1/2	45/64	1 15/32	1 3/8	1 3/16	3/8	UKFX05	FX05	UKX05	HE2305X	1.2	19.5	11.3	13.9							
25	3/4	4 11/32	1 5/32	3 5/32	5/8	1/2	5/8	1 15/32	1 3/8		M14	UKF305	F305	UK305	HE2305X	1.4	21.2	10.9	12.6							
		110	29	80	16	13	16	37.5	35																	
	1	4 1/4	1 7/32	3 17/64	15/32	1/2	45/64	1 15/32(1 9/16)	1 7/32(1 1/2)	1 13/32	3/8	UKF206	F206	UK206	H306X(H2306X)	1.3	19.5	11.3	13.9							
30	1	4 19/32	1 11/32	3 5/8	5/8	9/16	3/4	1 9/16	1 1/2	1 13/32	1/2	UKFX06	FX06	UKX06	H2306X	1.6	25.7	15.4	13.9							
		117	34	92	16	14	19	40	38	36	M14															
	1	4 29/32	1 1/4	3 47/64	5/8	19/32	45/64	1 5/8	1 1/2		M14	UKF306	F306	UK306	H2306X	1.9	26.7	15.0	13.3							
35	1 1/8	4 19/32	1 11/32	3 5/8	35/64	19/32	3/4	1 5/8(1 11/16)	1 3/8(1 11/16)	1 5/8	7/16	UKF207	F207	UK207	HS307X(HS2307X)	1.6	25.7	15.4	13.9							
		117	34	92	14	15	19	41(43)	35(43)	41	M12															
	1 1/8	5 1/8	1 1/2	4 1/64	5/8	9/16	53/64	1 23/32	1 11/16	1 5/8	1/2	UKFX07	FX07	UKX07	HS2307X	2.0	29.1	17.8	14.0							
40	1 1/8	5 5/16	1 13/32	3 15/16	3/4	5/8	25/32	1 25/32	1 11/16		M16	UKF307	F307	UK307	HS2307X	2.3	33.4	19.3	13.2							
		135	36	100	19	16	20	45.5	43																	
	1 1/4	5 1/8	1 13/32	4 1/64	5/8	19/32	53/64	1 3/4(1 7/8)	1 13/32(1 13/16)	1 13/16	1/2	UKF208	F208	UK208	HE308X(HS2308X)	1.9	29.1	17.8	14.0							
45	1 3/8	130	36	102	16	15	21	44.5(48)	36(46)	46	M14															
	1 1/4	5 13/32	1 9/16	4 9/64	3/4	9/16	55/64	1 27/32	1 13/16	1 13/16	5/8	UKFX08	FX08	UKX08	HE2308X	2.3	34.1	21.3	14.0							
	1 3/8	137	40	105	19	14	22	46.5	46	46	M16															
50	1 1/4	5 29/32	1 9/16	4 13/32	3/4	21/32	29/32	2	1 13/16		5/8	UKF308	F308	UK308	HE2308X	3.1	40.7	24.0	13.2							
	1 3/8	150	40	112	19	17	23	50.5	46		M16															
	1 1/2	5 13/32	1 1/2	4 9/64	5/8	5/8	55/64	1 7/8(2)	1 17/32(1 31/32)	2 1/16	1/2	UKF209	F209	UK209	HE309X(HS2309X)	2.3	34.1	21.3	14.0							
55	1 5/8	137	38	105	16	16	22	47.5(51)	39(50)	52	M14															
	1 1/2	5 5/8	1 9/16	4 3/8	3/4	9/16	29/32	1 29/32	1 31/32	2 1/16	5/8	UKFX09	FX09	UKX09	HE2309X	2.7	35.1	23.3	14.4							
	1 5/8	143	40	111	19	14	23	48.5	50	52	M16															
60	1 1/2	6 5/16	1 23/32	4 59/64	3/4	23/32	63/64	2 5/32	1 31/32		5/8	UKF309	F309	UK309	HE2309X	4.1	48.9	29.5	13.3							
	1 5/8	160	44	125	19	18	25	55	50		M16															
	1 3/4	5 5/8	1 9/16	4 3/8	5/8	5/8	55/64	1 29/32(2 1/16)	1 21/32(2 5/32)	2 9/32	1/2	UKF210	F210	UK210	HE310X(HS2310X)	2.6	35.1	23.3	14.4							
65	1 3/4	143	40	111	16	16	22	48.5(52)	42(55)	58	M14															
	1 3/4	6 3/8	1 23/32	5 1/8	3/4	25/32	1 1/32	2 3/32	2 5/32	2 9/32	5/8	UKFX10	FX10	UKX10	HE2310X	3.6	43.4	29.4	14.4							
	1 3/4	162	44	130	19	20	26	53.5	55	58	M16															
70	1 3/4	6 7/8	1 7/8	5 13/64	29/32	3/4	1 7/64	2 3/8	2 5/32		3/4	UKF310	F310	UK310	HE2310X	5.1	62.0	38.3	13.2							
		175	48	132	23	19	28	60	55		M20															
	1 7/8	6 3/8	1 11/16	5 1/8	3/4	23/32	63/64	2 1/16(2 1/4)	1 25/32(2 5/16)	2 17/32	5/8	UKF211	F211	UK211	HS311X(HS2311X)	3.5	43.4	29.4	14.4							
75	2	162	43	130	19	18	25	52.5(57)	45(59)	64	M16															

Note 1) Codes shown in parentheses indicate the dimensions and Part No. of applicable adapter (H2300X series) for UK200L3 series (triple seal type).

Remarks 1. In Part No. of unit and units with covers, fitting codes follow bore diameter numbers. (See Table 10.5 in P.42.)

2. Part No. of applicable grease nipples are shown below.
A-1/4-28UNF.....205-210, X05-X09, 305-308
A-PT1/8.....211-218, X10-X20, 309-328

3. In Part No. of unit with adapters and bearing with adapters, Part No. of applicable adapter follow the Part No. shown in the dimensional tables. (Example of Part No. : UKF206J + H306X, UK206 + H306X)

4. As for the triple seal type product (205 is the double seal type product), accessory code L3 (L2) follows the Part No. of unit or bearing. (Example of Part No. : UKF206JL3 + H2306X, UK206L3 + H2306X)

5. For the dimensions and forms of applicable bearings and adapters, see the dimensional tables of ball bearing for unit and adapter.

Square four-bolt flange type units

UKF
Tapered bore (with adapter)
d₁ (50) ~ 85 mm

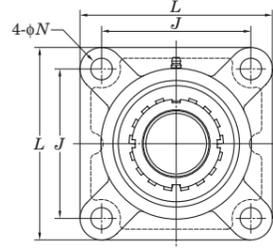
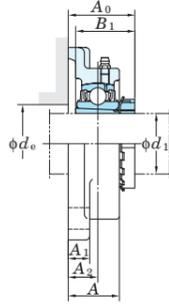

With Pressed Steel Cover

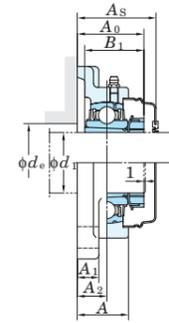

With Cast Iron Cover

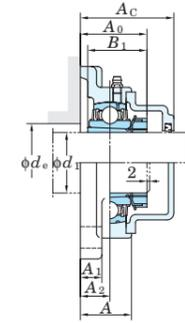

Variations of tolerance of distance from mounting surface to center of spherical bore (ΔA_{2s}) and tolerance of position of bolt hole (X)

Housing No.			ΔA _{2s}	X
F205-F210	FX05-FX10	F305-F310	±0.5	0.7
F211-F218	FX11-FX20	F311-F328	±0.8	1

Variations of tolerance of bolt hole diameter (ΔN_s)

Housing No.			ΔN _s
F205-F218	FX05-FX18	F305-F315	±0.2
	FX20	F316-F328	±0.3

Shaft Dia. mm inch	Dimensions										Bolt Size inch mm	Standard			Adapter ¹⁾ No.	Mass kg	Basic			Factor f ₀	With Pressed Steel Cover			With Cast Iron Cover		
	inch mm											Unit No.	Housing No.	Bearing No.			Load Ratings kN	Unit No. Open Type Closed Type	Dimension mm inch		Mass kg	Unit No. Open Type Closed Type	Dimension mm inch	Mass kg		
d ₁	L	A	J	N	A ₁	A ₂	A ₀ ¹⁾	B ₁ ¹⁾	d _e (min.)					C _r	C _{0r}		A _s			A _c						
50	1 7/8	6 7/8	1 15/16	5 5/8	3/4	25/32	1 9/64	2 1/4	2 5/16	2 17/32	5/8	UKFX11	FX11	UKX11												
	2	175	49	143	19	20	29	57.5	59	64	M16															
	1 7/8	7 9/32	2 1/16	5 33/64	29/32	25/32	1 3/16	2 1/2	2 5/16		3/4	UKF311	F311	UK311												
2	185	52	140	23	20	30	63.5	59																		
55	2 1/8	6 7/8	1 7/8	5 5/8	3/4	23/32	1 9/64	2 5/16(2 19/32)	1 27/32(2 7/16)	2 23/32	5/8	UKF212	F212	UK212												
	2 1/8	175	48	143	19	18	29	58.5(65.5)	47(62)	69	M16															
	2 1/8	7 3/8	2 5/16	5 55/64	3/4	13/16	1 11/32	2 9/16	2 7/16	2 23/32	5/8	UKFX12	FX12	UKX12												
2 1/8	187	59	149	19	21	34	65	62	69	M16																
2 1/8	7 11/16	2 7/32	5 29/32	29/32	7/8	1 19/64	2 3/4	2 7/16		3/4	UKF312	F312	UK312													
2 1/8	195	56	150	23	22	33	69.5	62																		
60	2 1/4	7 3/8	1 31/32	5 55/64	3/4	7/8	1 3/16	2 7/16(2 21/32)	1 31/32(2 9/16)	2 29/32	5/8	UKF213	F213	UK213												
	2 3/8	187	50	149	19	22	30	62(67.5)	50(65)	74	M16															
	2 1/4	7 3/8	2 5/16	5 55/64	3/4	13/16	1 11/32	2 11/16	2 9/16	2 29/32	5/8	UKFX13	FX13	UKX13												
2 3/8	187	59	149	19	21	34	68	65	74	M16																
2 1/4	8 3/16	2 9/32	6 17/32	29/32	7/8	1 19/64	2 13/16	2 9/16		3/4	UKF313	F313	UK313													
2 3/8	208	58	166	23	22	33	71.5	65																		
65	2 1/2	7 7/8	2 7/32	6 17/64	3/4	7/8	1 11/32	2 23/32(2 15/16)	2 5/32(2 7/8)	3 11/32	5/8	UKF215	F215	UK215												
	2 1/2	200	56	159	19	22	34	69(74.5)	55(73)	85	M16															
	2 1/2	7 3/4	2 11/16	5 63/64	29/32	15/16	1 9/16	3	2 7/8	3 11/32	3/4	UKFX15	FX15	UKX15												
2 1/2	197	68	152	23	24	40	76	73	85	M20																
2 1/2	9 9/32	2 19/32	7 1/4	63/64	31/32	1 17/32	3 7/32	2 7/8		7/8	UKF315	F315	UK315													
2 1/2	236	66	184	25	25	39	81.5	73																		
70	2 3/4	8 3/16	2 9/32	6 1/2	29/32	7/8	1 11/32	2 27/32(3 3/32)	2 5/16(3 1/16)	3 17/32	3/4	UKF216	F216	UK216												
	2 3/4	208	58	165	23	22	34	72(78.5)	59(78)	90	M20															
	2 3/4	8 7/16	2 3/4	6 47/64	29/32	15/16	1 9/16	3 1/8	3 1/16	3 17/32	3/4	UKFX16	FX16	UKX16												
2 3/4	214	70	171	23	24	40	79	78	90	M20																
2 3/4	9 27/32	2 11/16	7 23/32	1 7/32	1 1/16	1 1/2	3 1/4	3 1/16		1	UKF316	F316	UK316													
2 3/4	250	68	196	31	27	38	82.5	78																		
75	3	8 21/32	2 15/32	6 57/64	29/32	15/16	1 13/32	3(3 1/4)	2 15/32(3 7/32)	3 25/32	3/4	UKF217	F217	UK217												
	3	220	63	175	23	24	36	76(82.5)	63(82)	96	M20															
	3	8 7/16	2 3/4	6 47/64	29/32	15/16	1 9/16	3 7/32	3 7/32	3 25/32	3/4	UKFX17	FX17	UKX17												
3	214	70	171	23	24	40	82	82	96	M20																
3	10 1/4	2 29/32	8 1/32	1 7/32	1 1/16	1 47/64	3 5/8	3 7/32		1	UKF317	F317	UK317													
3	260	74	204	31	27	44	92	82																		
80	3 1/4	9 1/4	2 11/16	7 23/64	29/32	31/32	1 9/16	3 7/32(3 17/32)	2 9/16(3 3/8)	4 1/32	3/4	UKF218	F218	UK218												
	3 1/4	235	68	187	23	25	40	82(89.5)	65(86)	102	M20															
	3 1/4	8 7/16	3	6 47/64	29/32	15/16	1 49/64	3 15/32	3 3/8	4 1/32	3/4	UKFX18	FX18	UKX18												
3 1/4	214	76	171	23	24	45	88	86	102	M20																
3 1/4	11 1/32	3	8 1/2	1 3/8	1 3/16	1 47/64	3 5/8	3 3/8		1 1/8	UKF318	F318	UK318													
3 1/4	280	76	216	35	30	44	92	86																		
85	3 1/4	11 13/32	3 11/16	8 31/32	1 3/8	1 3/16	2 21/64	4 3/8	3 17/32		1 1/8	UKF319	F319	UK319												
	3 1/4	290	94	228	35	30	59	111	90																	

Note 1) Codes shown in parentheses indicate the dimensions and Part No. of applicable adapter (H2300X series) for UK200L3 series (triple seal type).

Remarks 1. In Part No. of unit and units with covers, fitting codes follow bore diameter numbers. (See Table 10.5 in P.42.)

2. Part No. of applicable grease nipples are shown below.

A-1/4-28UNF.....205~210, X05~X09, 305~308
A-PT1/8.....211~218, X10~X20, 309~328

3. In Part No. of unit with adapters and bearing with adapters, Part No. of applicable adapter follow the Part No. shown in the dimensional tables.

(Example of Part No. : UKF206J + H306X, UK206 + H306X)

4. As for the triple seal type product (205 is the double seal type product), accessory code L3 (L2) follows the Part No. of unit or bearing.

(Example of Part No. : UKF206JL3 + H2306X, UK206L3 + H2306X)

5. For the dimensions and forms of applicable bearings and adapters, see the dimensional tables of ball bearing for unit and adapter.

Square four-bolt flange cartridge type units

UCFS
Cylindrical bore (with set screws)
d 25 ~ 140 mm

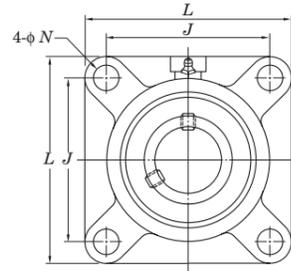
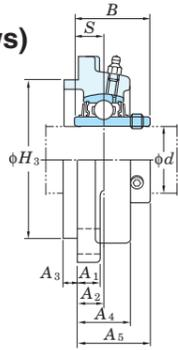

With Cast Iron Cover

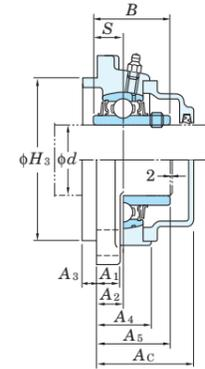

Variations of tolerance of spigot joint outside diameter (ΔH_{3a}), variations of tolerance of distance from mounting surface to center of spherical bore (ΔA_{2a}), tolerance of position of bolt hole (X), and tolerance of circumferential runout of spigot joint (Y)

Variations of tolerance of bolt hole diameter (ΔN_b)

Housing No.	ΔH_{3a}	ΔA_{2a}	Unit : mm	
			X	Y
FS305	0 -0.046	±0.5	0.7	0.2
FS306~FS308	0 -0.054			
FS309~FS310	0 -0.063			
FS311~FS313	0 -0.072	±0.8	1	0.3 ~FS318 FS319~
FS314~FS319	0 -0.081			
FS320~FS322	0 -0.089			
FS324~FS328	0 -0.089			

Housing No.	ΔN_b
FS305~315	±0.2
FS316~328	±0.3

Shaft Dia. mm inch	Dimensions												Bolt Size	Standard			Basic		Factor	With Cast Iron Cover				
	L	H ₃	J	N	A ₁	A ₂	A ₃	A ₄	A ₅	B	S	Unit No.		Housing No.	Bearing No.	Mass	Load Ratings kN	Unit No.		Dimension	Mass			
d	inch mm												inch mm					Open Type	Closed Type	mm	inch	kg		
25 1	4 11/32	3.1496	3 5/32	5/8	1/2	23/64	9/32	7/8	1 1/4	1.496	0.591	1/2	UCFS305	FS305	UC305	1.4								
	110	80	80	16	13	9	7	22	32	38	15	M14	UCFS305-16	UC305-16	1.4	21.2	10.9	12.6	UCFS305C	UCFS305D	47	1 27/32	1.7	
30 -	4 29/32	3.5433	3 47/64	5/8	19/32	25/64	5/16	15/16	1 13/32	1.693	0.669	1/2	UCFS306	FS306	UC306	1.9	26.7	15.0	13.3	UCFS306C	UCFS306D	51	2	2.2
	125	90	95	16	15	10	8	24	36	43	17	M14												
35 -	5 5/16	3.9370	3 15/16	3/4	5/8	7/16	23/64	1 1/16	1 9/16	1.890	0.748	5/8	UCFS307	FS307	UC307	2.3	33.4	19.3	13.2	UCFS307C	UCFS307D	55	2 5/32	2.7
	135	100	100	19	16	11	9	27	40	48	19	M16												
40 1 1/2	5 29/32	4.5276	4 13/32	3/4	21/32	33/64	25/64	1 3/16	1 13/16	2.047	0.748	5/8	UCFS308-24	FS308	UC308-24	3.4	40.7	24.0	13.2	-	-	-	-	-
	150	115	112	19	17	13	10	30	46	52	19	M16	UCFS308	UC308	3.4				UCFS308C	UCFS308D	61	2 13/32	3.9	
45 1 3/4	6 5/16	4.9213	4 59/64	3/4	23/32	35/64	7/16	1 5/16	1 15/16	2.244	0.866	5/8	UCFS309-28	FS309	UC309-28	4.4	48.9	29.5	13.3	-	-	-	-	-
	160	125	125	19	18	14	11	33	49	57	22	M16	UCFS309	UC309	4.4				UCFS309C	UCFS309D	65	2 9/16	5.0	
50 -	6 7/8	5.5118	5 13/64	29/32	3/4	5/8	15/32	1 13/32	2 5/32	2.402	0.866	3/4	UCFS310	FS310	UC310	5.3	62.0	38.3	13.2	UCFS310C	UCFS310D	71	2 25/32	6.1
	175	140	132	23	19	16	12	36	55	61	22	M20												
55 2	7 9/32	5.9055	5 33/64	29/32	25/32	43/64	33/64	1 17/32	2 9/32	2.598	0.984	3/4	UCFS311-32	FS311	UC311-32	6.1	71.6	45.0	13.2	-	-	-	-	-
	185	150	140	23	20	17	13	39	58	66	25	M20	UCFS311	UC311	6.1				UCFS311C	UCFS311D	74	2 29/32	7.0	
60 -	7 11/16	6.2992	5 29/32	29/32	7/8	3/4	35/64	1 21/32	2 17/32	2.795	1.024	3/4	UCFS312	FS312	UC312	7.4	81.9	52.2	13.2	UCFS312C	UCFS312D	81	3 3/16	8.6
	195	160	150	23	22	19	14	42	64	71	26	M20												
65 2 1/2	8 3/16	6.8898	6 17/32	29/32	7/8	19/32	45/64	1 9/16	2 3/8	2.953	1.181	3/4	UCFS313-40	FS313	UC313-40	8.8	92.7	59.9	13.2	-	-	-	-	-
	208	175	166	23	22	15	18	40	60	75	30	M20	UCFS313	UC313	8.8				UCFS313C	UCFS313D	76	3	9.9	
70 2 3/4	8 29/32	7.2835	7 1/64	63/64	31/32	45/64	45/64	1 11/16	2 15/32	3.071	1.299	7/8	UCFS314-44	FS314	UC314-44	11.2	104	68.2	13.2	-	-	-	-	-
	226	185	178	25	25	18	18	43	63	78	33	M22	UCFS314	UC314	11.2				UCFS314C	UCFS314D	80	3 5/32	12.3	
75 2 15/16	9 9/32	7.8740	7 1/4	63/64	31/32	53/64	45/64	1 7/8	2 25/32	3.228	1.260	7/8	UCFS315-47	FS315	UC315-47	13.7	113	77.2	13.2	-	-	-	-	-
	236	200	184	25	25	21	18	48	71	82	32	M22	UCFS315	UC315	13.7				UCFS315C	UCFS315D	88	3 15/32	15.0	
80 -	9 27/32	8.2677	7 23/32	1 7/32	1 1/16	45/64	25/32	1 7/8	2 3/4	3.386	1.339	1	UCFS316	FS316	UC316	15.1	123	86.7	13.3	UCFS316C	UCFS316D	87	3 7/16	16.5
	250	210	196	31	27	18	20	48	70	86	34	M27												
85 -	10 1/4	8.6614	8 1/32	1 7/32	1 1/16	15/16	25/32	2 1/8	3 5/32	3.780	1.575	1	UCFS317	FS317	UC317	17.3	133	96.8	13.3	UCFS317C	UCFS317D	97	3 13/16	18.9
	260	220	204	31	27	24	20	54	80	96	40	M27												
90 3 1/2	11 1/32	9.4488	8 1/2	1 3/8	1 3/16	15/16	25/32	2 7/32	3 5/32	3.780	1.575	1 1/8	UCFS318-56	FS318	UC318-56	21.3	143	107	13.3	-	-	-	-	-
	280	240	216	35	30	24	20	56	80	96	40	M30	UCFS318	UC318	21.3				UCFS318C	UCFS318D	99	3 29/32	23.2	
95 -	11 13/32	9.8425	8 31/32	1 3/8	1 3/16	1 17/32	25/32	2 29/32	3 31/32	4.055	1.614	1 1/8	UCFS319	FS319	UC319	24.5	153	119	13.3	UCFS319C	UCFS319D	120	4 23/32	26.7
	290	250	228	35	30	39	20	74	101	103	41	M30												
100 3 15/16	12 7/32	10.2362	9 17/32	1 1/2	1 1/4	1 17/32	25/32	2 29/32	4 1/8	4.252	1.654	1 1/4	UCFS320	FS320	UC320	29.5	173	141	13.2	UCFS320C	UCFS320D	126	4 31/32	32.3
	310	260	242	38	32	39	20	74	105	108	42	M33	UCFS320-63	UC320-63	29.5				-	-	-	-	-	
105 -	12 7/32	10.2362	9 17/32	1 1/2	1 1/4	1 17/32	25/32	2 29/32	4 7/32	4.409	1.732	1 1/4	UCFS321	FS321	UC321	32.7	184	153	13.2	UCFS321C	UCFS321D	128	5 1/32	35.7
	310	260	242	38	32	39	20	74	107	112	44	M33												
110 -	13 3/8	11.8110	10 15/32	1 39/64	1 3/8	1 3/8	63/64	2 25/32	4 3/16	4.606	1.811	1 3/8	UCFS322	FS322	UC322	39.0	205	180	13.2	UCFS322C	UCFS322D	129	5 3/32	42.4
	340	300	266	41	35	35	25	71	106	117	46	M36												
120 -	14 9/16	12.9921	11 27/64	1 39/64	1 9/16	1 3/8	1 3/16	3 5/32	4 11/32	4.961	2.008	1 3/8	UCFS324	FS324	UC324	50.6	207	185	13.5	UCFS324C	UCFS324D	133	5 1/4	55.4
	370	330	290	41	40	35	30	80	110	126	51	M36												
130 -	16 5/32	14.1732	12 19/32	1 39/64	1 25/32	1 3/8	1 3/16	3 11/32	4 9/16	5.315	2.126	1 3/8	UCFS326	FS326	UC326	67.7	229	214	13.6	UCFS326C	UCFS326D	142	5 29/32	73.8
	410	360	320	41	45	35	30	85	116	135	54	M36												
140 -	17 23/32	15.7480	13 25/32	1 39/64	2 5/32	1 49/64	1 3/16	3 3/4	5 5/32	5.709	2.323	1 3/8	UCFS328	FS328	UC328	94.0	253	246	13.6	UCFS328C	UCFS328D	156	6 5/32	102
	450	400	350	41	55	45	30	95	131	145	59	M36												

Remarks 1. In Part No. of unit and units with covers, fitting codes follow bore diameter numbers. (See Table 10.5 in P.42.)
2. Part No. of applicable grease nipples are shown below.
A-1/4-28UNF..... 305~308
A-PT1/8..... 309~328

3. As for the triple seal type product, accessory code L3 follows the Part No. of unit or bearing. (Example of Part No. : UCFS307JL3, UC307L3)
4. The dimensions and forms of applicable bearings, see the dimensional tables of ball bearing for unit.

Square four-bolt flange cartridge type units

UKFS
Tapered bore (with adapter)
d₁ 20 ~ 125 mm

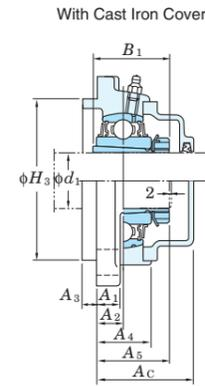
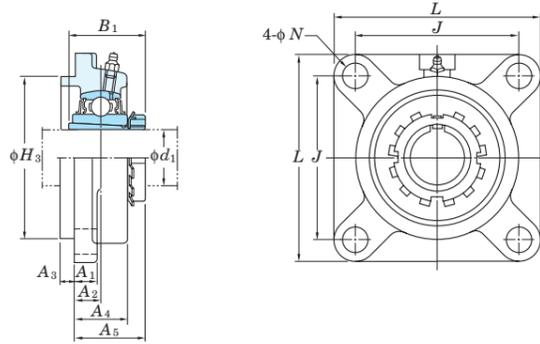

Variations of tolerance of spigot joint outside diameter (Δ_{H3a}), variations of tolerance of distance from mounting surface to center of spherical bore (Δ_{A2a}), tolerance of position of bolt hole (X), and tolerance of circumferential runout of spigot joint (Y)

Variations of tolerance of bolt hole diameter (Δ_{N6})

Housing No.	Δ_{H3a}	Δ_{A2a}	Unit : mm	
			X	Y
FS305	0 -0.046	±0.5	0.7	0.2
FS306-FS308	0 -0.054			
FS309-FS310	0 -0.063			
FS311-FS313	0 -0.072	±0.8	1	0.3 ~FS318 FS319- 0.4
FS315-FS319	0 -0.081			
FS320-FS322	0 -0.089			
FS324-FS328	0 -0.089			

Housing No.	Δ_{N6}
FS305-315	±0.2
FS316-328	±0.3

Shaft Dia. mm inch	Dimensions inch mm											Bolt Size inch mm	Standard			Adapter No.	Mass kg	Basic Load Ratings kN		Factor f ₀	With Cast Iron Cover		
	d ₁	L	H ₃	J	N	A ₁	A ₂	A ₃	A ₄	A ₅	B ₁		Unit No.	Housing No.	Bearing No.			Unit No.	Dimension mm inch		Mass kg		
20 3/4	4 11/32	3.1496	3 5/32	5/8	1/2	23/64	9/32	7/8	1 3/16	1 3/8	1/2	UKFS305	FS305	UK305	HE2305X H2305X	1.4 1.4	21.2 10.9	12.6	-	-	-		
	110	80	80	16	13	9	7	22	30.5	35	M14								UKFS305C	UKFS305D	47	1 27/32	1.7
25 1	4 29/32	3.5433	3 47/64	5/8	19/32	25/64	5/16	15/16	1 5/16	1 1/2	1/2	UKFS306	FS306	UK306	H2306X HE2306X	1.9 1.9	26.7 15.0	13.3	UKFS306C	UKFS306D	51	2	2.2
	125	90	95	16	15	10	8	24	33	38	M14								-	-	-	-	-
30 1 1/8	5 5/16	3.9370	3 15/16	3/4	5/8	7/16	23/64	1 1/16	1 7/16	1 11/16	5/8	UKFS307	FS307	UK307	HS2307X H2307X	2.4 2.4	33.4 19.3	13.2	UKFS307C	UKFS307D	55	2 5/32	2.9
	135	100	100	19	16	11	9	27	36.5	43	M16								-	-	-	-	-
35 1 1/4 1 3/8	5 29/32	4.5276	4 13/32	3/4	21/32	33/64	25/64	1 3/16	1 19/32	1 13/16	5/8	UKFS308	FS308	UK308	HE2308X HS2308X H2308X	3.4 3.4 3.4	40.7 24.0	13.2	UKFS308C	UKFS308D	61	2 13/32	3.9
	150	115	112	19	17	13	10	30	40.5	46	M16								-	-	-	-	-
40 1 1/2 1 5/8	6 5/16	4.9213	4 59/64	3/4	23/32	35/64	7/16	1 5/16	1 23/32	1 31/32	5/8	UKFS309	FS309	UK309	HE2309X H2309X HS2309X	4.4 4.4 4.4	48.9 29.5	13.3	UKFS309C	UKFS309D	65	2 9/16	5.0
	160	125	125	19	18	14	11	33	44	50	M16								-	-	-	-	-
45 1 3/4	6 7/8	5.5118	5 13/64	29/32	3/4	5/8	15/32	1 13/32	1 7/8	2 5/32	3/4	UKFS310	FS310	UK310	HE2310X H2310X	5.3 5.3	62.0 38.3	13.2	UKFS310C	UKFS310D	71	2 25/32	6.1
	175	140	132	23	19	16	12	36	48	55	M20								-	-	-	-	-
50 1 7/8 2	7 9/32	5.9055	5 33/64	29/32	25/32	43/64	33/64	1 17/32	2	2 5/16	3/4	UKFS311	FS311	UK311	HS2311X H2311X HE2311X	6.3 6.3 6.3	71.6 45.0	13.2	UKFS311C	UKFS311D	74	2 29/32	7.2
	185	150	140	23	20	17	13	39	50.5	59	M20								-	-	-	-	-
55 2 1/8	7 11/16	6.2992	5 29/32	29/32	7/8	3/4	35/64	1 21/32	2 3/16	2 7/16	3/4	UKFS312	FS312	UK312	HS2312X H2312X	7.3 7.3	81.9 52.2	13.2	UKFS312C	UKFS312D	81	3 3/16	8.5
	195	160	150	23	22	19	14	42	55.5	62	M20								-	-	-	-	-
60 2 3/8	8 3/16	6.8898	6 17/32	29/32	7/8	19/32	45/64	1 9/16	2 3/32	2 9/16	3/4	UKFS313	FS313	UK313	HE2313X H2313X HS2313X	8.9 8.9 8.9	92.7 59.9	13.2	UKFS313C	UKFS313D	76	3	10.0
	208	175	166	23	22	15	18	40	53.5	65	M20								-	-	-	-	-
65 2 1/2	9 9/32	7.8740	7 1/4	63/64	31/32	53/64	45/64	1 7/8	2 1/2	2 7/8	7/8	UKFS315	FS315	UK315	HE2315X H2315X	13.4 13.4	113 77.2	13.2	UKFS315C	UKFS315D	88	3 15/32	14.8
	236	200	184	25	25	21	18	48	63.5	73	M22								-	-	-	-	-
70 2 3/4	9 27/32	8.2677	7 23/32	1 7/32	1 1/16	45/64	25/32	1 7/8	2 15/32	3 1/16	1	UKFS316	FS316	UK316	HE2316X H2316X	15.1 15.1	123 86.7	13.3	UKFS316C	UKFS316D	87	3 7/16	16.7
	250	210	196	31	27	18	20	48	62.5	78	M27								-	-	-	-	-
75 3	10 1/4	8.6614	8 1/32	1 7/32	1 1/16	15/16	25/32	2 1/8	2 27/32	3 7/32	1	UKFS317	FS317	UK317	H2317X HE2317X	17.1 17.1	133 96.8	13.3	UKFS317C	UKFS317D	97	3 13/16	18.9
	260	220	204	31	27	24	20	54	72	82	M27								-	-	-	-	-
80 -	11 1/32	9.4488	8 1/2	1 3/8	1 3/16	15/16	25/32	2 7/32	2 21/32	3 3/8	1 1/8	UKFS318	FS318	UK318	H2318X	21.4	143 107	13.3	UKFS318C	UKFS318D	99	3 29/32	23.5
	280	240	216	35	30	24	20	56	72	86	M30								-	-	-	-	-
85 3 1/4	11 13/32	9.8425	8 31/32	1 3/8	1 3/16	1 17/32	25/32	2 29/32	2 19/32	3 17/32	1 1/8	UKFS319	FS319	UK319	HE2319X H2319X	24.8 24.8	153 119	13.3	UKFS319C	UKFS319D	120	4 23/32	26.2
	290	250	228	35	30	39	20	74	91	90	M30								-	-	-	-	-
90 3 1/2	12 7/32	10.2362	9 17/32	1 1/2	1 1/4	1 17/32	25/32	2 29/32	2 21/32	3 13/16	1 1/4	UKFS320	FS320	UK320	HE2320X H2320X	29.1 29.1	173 141	13.2	UKFS320C	UKFS320D	126	4 31/32	32.2
	310	260	242	38	32	39	20	74	93	97	M33								-	-	-	-	-
100 4	13 3/8	11.8110	10 15/32	1 39/64	1 3/8	1 3/8	63/64	2 25/32	2 3/4	4 1/8	1 3/8	UKFS322	FS322	UK322	H2322X HE2322X	38.6 38.6	205 180	13.2	UKFS322C	UKFS322D	129	5 3/32	42.1
	340	300	266	41	35	35	25	71	95	105	M36								-	-	-	-	-
110 -	14 9/16	12.9921	11 27/64	1 39/64	1 9/16	1 3/8	1 3/16	3 5/32	3 21/32	4 13/32	1 3/8	UKFS324	FS324	UK324	H2324	50.9	207 185	13.5	UKFS324C	UKFS324D	133	5 1/4	56.0
	370	330	290	41	40	35	30	80	100.5	112	M36								-	-	-	-	-
115 4 1/2	16 5/32	14.1732	12 19/32	1 39/64	1 25/32	1 3/8	1 3/16	3 11/32	4	4 3/4	1 3/8	UKFS326	FS326	UK326	HE2326 H2326	67.5 67.5	229 214	13.6	UKFS326C	UKFS326D	142	5 29/32	74.1
	410	360	320	41	45	35	30	85	101.5	121	M36								-	-	-	-	-
125 -	17 23/32	15.7480	13 25/32	1 39/64	2 5/32	1 49/64	1 3/16	3 3/4	4 5/8	5 5/32	1 3/8	UKFS328	FS328	UK328	H2328	94.0	253 246	13.6	UKFS328C	UKFS328D	156	6 5/32	102
450	400	350	41	55	45	30	95	117.5	131	M36	-								-	-	-	-	

Remarks 1. In Part No. of unit and units with covers, fitting codes follow bore diameter numbers. (See Table 10.5 in P.42.)
2. Part No. of applicable grease nipples are shown below.
A-1/4-28UNF..... 305-308
A-PT1/8..... 309-328

3. In Part No. of unit with adapters and bearing with adapters, Part No. of applicable adapter follow the Part No. shown in the dimensional tables.
(Example of Part No. : UKFS307J + H2307X, UK307 + H2307X)
4. As for the triple seal type product, accessory code L3 follows the Part No. of unit or bearing.
(Example of Part No. : UKFS307JL3 + H2307X, UK307L3 + H2307X)
5. For the dimensions and forms of applicable bearings and adapters, see the dimensional tables of ball bearing for unit and adapter.

Stainless steel series square four-bolt flange type units

UCSF-H1S6
Cylindrical bore (with set screws)
d 20 ~ 50 mm

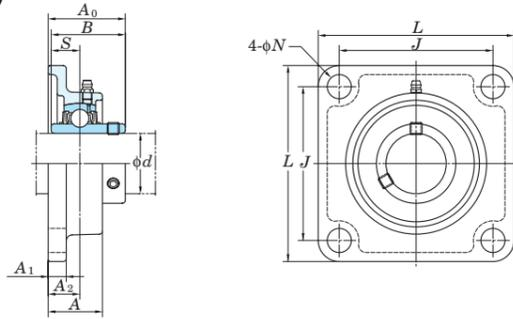

With Pressed Stainless Steel Cover

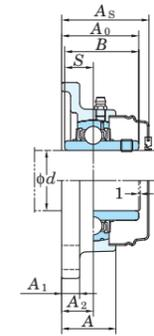

Variations of tolerance of distance from mounting surface to center of spherical bore (ΔA_{2s}) and tolerance of position of bolt hole (X)

Housing No.	ΔA_{2s}	X
SF204 H1-210 H1	± 0.5	0.7

Unit : mm

Variations of tolerance of bolt hole diameter (ΔN_s)

Housing No.	ΔN_s
SF204 H1-210 H1	± 0.2

Unit : mm

Shaft Dia. mm d	Dimensions										Bolt Size inch mm	Unit No.	Standard Housing No.	Bearing No.	Mass kg	Basic Load Ratings kN C_r C_{0r}	Factor f_0	With Pressed Stainless Steel Cover				
	inch mm																	Open Type	Closed Type	Dimension		Mass kg
	L	A	J	N	A ₁	A ₂	A ₀	B	S	A _s										mm	inch	
20	3 3/8 86	1 1/32 26	2 33/64 64	15/32 12	13/32 10	19/32 15	1 5/16 33.3	1.220 31	0.500 12.7	3/8 M10	UCSF204H1S6	SF204H1	UC204S6	0.5	10.9	5.35	13.2	UCSF204H1CS6	UCSF204H1DS6	38	1 1/2	0.5
25	3 3/4 95	1 3/32 27.5	2 3/4 70	15/32 12	13/32 10	5/8 16	1 13/32 35.8	1.343 34.1	0.563 14.3	3/8 M10	UCSF205H1S6	SF205H1	UC205S6	0.85	11.9	6.3	13.9	UCSF205H1CS6	UCSF205H1DS6	40	1 9/16	0.85
30	4 1/4 108	1 7/32 31	3 17/64 83	15/32 12	13/32 10	45/64 18	1 19/32 40.2	1.500 38.1	0.626 15.9	3/8 M10	UCSF206H1S6	SF206H1	UC206S6	1.1	16.5	9.05	13.9	UCSF206H1CS6	UCSF206H1DS6	45	1 25/32	1.1
35	4 19/32 117	1 11/32 34	3 5/8 92	35/64 14	7/16 11	3/4 19	1 3/4 44.4	1.689 42.9	0.689 17.5	7/16 M12	UCSF207H1S6	SF207H1	UC207S6	1.5	21.8	12.3	13.9	UCSF207H1CS6	UCSF207H1DS6	49	1 15/16	1.5
40	5 1/8 130	1 13/32 36	4 1/64 102	5/8 16	15/32 12	53/64 21	2 1/32 51.2	1.937 49.2	0.748 19	1/2 M14	UCSF208H1S6	SF208H1	UC208S6	1.7	24.8	14.3	14.0	UCSF208H1CS6	UCSF208H1DS6	56	2 7/32	1.7
45	5 13/32 137	1 1/2 38	4 9/64 105	5/8 16	1/2 13	55/64 22	2 1/16 52.2	1.937 49.2	0.748 19	1/2 M14	UCSF209H1S6	SF209H1	UC209S6	1.9	27.8	16.2	14.0	UCSF209H1CS6	UCSF209H1DS6	57	2 1/4	1.9
50	5 5/8 143	1 9/16 40	4 3/8 111	5/8 16	1/2 13	55/64 22	2 5/32 54.6	2.031 51.6	0.748 19	1/2 M14	UCSF210H1S6	SF210H1	UC210S6	2.4	29.8	18.6	14.4	UCSF210H1CS6	UCSF210H1DS6	59	2 5/16	2.4

- Remarks 1. In Part No. of unit and units with covers, fitting codes follow bore diameter codes. (See Table 10.5 in P.42.)
 2. Part No. of the applicable grease nipple is A-1/4-28UNFN12.
 3. For the dimensions and forms of applicable bearings, see the dimensional tables of ball bearing for unit.

Oval two-bolt flange type units

UCFL
Cylindrical bore (with set screws)
 d (90) ~ 130 mm

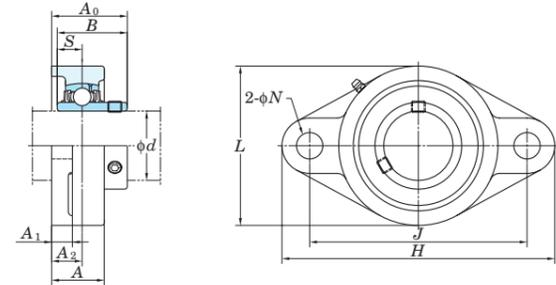

With Pressed Steel Cover With Cast Iron Cover

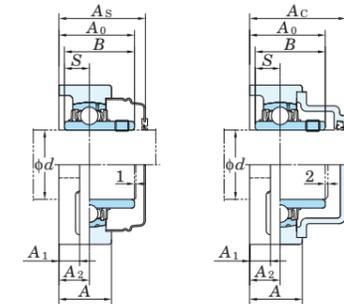

Variations of tolerance of distance from mounting surface to center of spherical bore (ΔA_{2a}) and tolerance of position of bolt hole (X) Unit : mm

Housing No.	ΔA_{2a}	X		
FL204-FL210	FLX05-FLX10	FL305-FL310	±0.5	0.7
FL211-FL218	FL311-FL326		±0.8	1

Variations of tolerance of bolt hole diameter (ΔN_s) Unit : mm

Housing No.	ΔN_s		
FL204-FL218	FLX05-FLX10	FL305-FL311	±0.2
	FL312-FL326		±0.3

Forms and dimensions of L_c of FL204JE3 and FL205JE3 (housing with cast iron cover) are shown below.

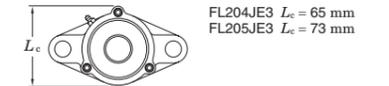

Shaft Dia. mm inch	Dimensions											Bolt Size inch mm	Standard			Mass kg	Basic Load Ratings kN		Factor f_0	With Pressed Steel Cover				With Cast Iron Cover												
	inch												Unit No.	Housing No.	Bearing No.		Unit No.	Dimension mm inch		Mass kg	Unit No.	Dimension mm inch	Mass kg													
	mm																							Open Type	Closed Type	Open Type	Closed Type									
d	H	L	A	J	N	A_1	A_2	A_0	B	S					C_r	C_{0r}		A_s				A_c														
90	3 1/2	15 5/32	9 1/4	3	12 13/32	1 1/2	1 13/32	1 47/64	3 15/16	3.780	1.575	1 1/4	UCFL318-56 UCFL318	FL318	UC318-56 UC318		19.0 19.0	143	107	13.3	-	-	-	-	-	-	-	-	-	-	-	-	-	-	-	-
		385	235	76	315	38	36	44	100	96	40	M33									UCFL318C	UCFL318D	119	4 11/16	20.9											
95	-	15 15/16	9 27/32	3 11/16	13	1 39/64	1 9/16	2 21/64	4 3/4	4.055	1.614	1 3/8	UCFL319	FL319	UC319		24.6	153	119	13.3	-	-	-	-	-	-	-	-	-	-	-	-	-	-	-	
		405	250	94	330	41	40	59	121	103	41	M36									UCFL319C	UCFL319D	140	5 1/2	26.8											
100	3 15/16 4	17 5/16	10 5/8	3 11/16	14 11/64	1 47/64	1 9/16	2 21/64	4 29/32	4.252	1.654	1 1/2	UCFL320 UCFL320-63 UCFL320-64	FL320	UC320 UC320-63 UC320-64		29.4 29.4 29.4	173	141	13.2	-	-	-	-	-	-	-	-	-	-	-	-	-	-	-	
		440	270	94	360	44	40	59	125	108	42	M39									UCFL320C	UCFL320D	146	5 3/4	32.2											
		470	300	96	390	44	42	60	131	117	46	M39									-	-	-	-	-	-	-	-	-	-	-	-	-	-	-	-
110	-	18 1/2	11 13/16	3 25/32	15 23/64	1 47/64	1 21/32	2 23/64	5 9/32	4.606	1.811	1 1/2	UCFL322	FL322	UC322		36.2	205	180	13.2	-	-	-	-	-	-	-	-	-	-	-	-	-	-	-	-
		470	300	96	390	44	42	60	131	117	46	M39									UCFL322C	UCFL322D	154	6 1/16	39.6											
120	-	20 15/32	13	4 11/32	16 59/64	1 27/32	1 7/8	2 9/16	5 1/2	4.961	2.008	1 5/8	UCFL324	FL324	UC324		51.6	207	185	13.5	-	-	-	-	-	-	-	-	-	-	-	-	-	-	-	-
		520	330	110	430	47	48	65	140	126	51	M42									UCFL324C	UCFL324D	163	6 13/32	56.4											
130	-	21 21/32	14 3/16	4 17/32	18 7/64	1 27/32	1 31/32	2 9/16	5 3/4	5.315	2.126	1 5/8	UCFL326	FL326	UC326		61.6	229	214	13.6	-	-	-	-	-	-	-	-	-	-	-	-	-	-	-	-
		550	360	115	460	47	50	65	146	135	54	M42									UCFL326C	UCFL326D	172	6 25/32	67.7											

Remarks 1. In Part No. of unit and units with covers, fitting codes follow bore diameter numbers. (See Table 10.5 in P.42.)
2. Part No. of applicable grease nipples are shown below.
A-1/4-28UNF 201~210, X05~X09, 305~308
A-PT1/8 211~218, X10, 309~326

3. As for the triple seal type product (from 201 to 205 are the double seal type products), accessory code L3 (or L2) follows the Part No. of unit or bearing. (Example of Part No. : UCFL206JL3, UC206L3)
4. For the dimensions and forms of applicable bearings, see the dimensional tables of ball bearing for unit.

Oval tow-bolt flange type units

UCFL-E
Cylindrical bore (with set screws)
d 12 ~ 75 mm

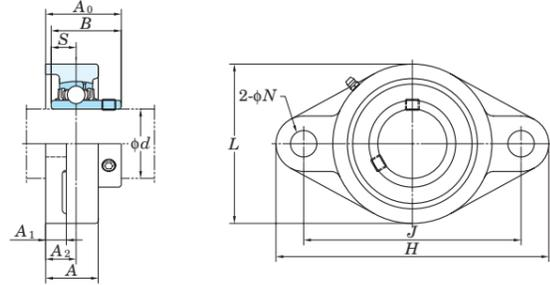

Variations of tolerance of distance from mounting surface to center of spherical bore (ΔA_{2s}) and tolerance of position of bolt hole (X)

Housing No.	ΔA_{2s}	X
FL203E-FL210E	± 0.5	0.7
FL211E-FL217E	± 0.8	1

Variations of tolerance of bolt hole diameter (ΔN_s)

Housing No.	ΔN_s
FL203E-FL217E	± 0.2

Shaft Dia. mm inch d	Dimensions inch mm										Bolt Size inch	Unit No.	Housing No.	Bearing No.	Basic Load Ratings kN		Factor f_0	Mass kg
	H	L	A	J	N	A ₁	A ₂	A ₀	B	S					C _r	C _{0r}		
12 1/2	3 7/32	2 7/32	1	3	25/64	7/16	19/32	1 5/16	1.220	0.500	5/16	UCFL201E UCFL201E-8 UCFL202E UCFL202E-10 UCFL203E	FL203E	UC201 UC201-8 UC202 UC202-10 UC203	12.8	6.65	13.2	0.42
15 5/8	98	56	25.5	76.2	10	11	15	33.3	31	12.7	5/16	UCFL204E-12 UCFL204E	FL204E	UC204-12 UC204	12.8	6.65	13.2	0.4
17											5/16	UCFL205E-14 UCFL205E-15 UCFL205E UCFL205E-16	FL205E	UC205-14 UC205-15 UC205 UC205-16	12.8	6.65	13.2	0.39
20 3/4	4 7/16	2 3/8	1	3 17/32	25/64	7/16	19/32	1 5/16	1.220	0.500	5/16	UCFL206E-18 UCFL206E UCFL206E-19 UCFL206E-20	FL206E	UC206-18 UC206 UC206-19 UC206-20	12.8	6.65	13.2	0.48
25 7/8 15/16	5 1/8	2 11/16	1 1/16	3 57/64	15/32	1/2	5/8	1 13/32	1.343	0.563	3/8	UCFL207E-20 UCFL207E-21 UCFL207E-22 UCFL207E UCFL207E-23	FL207E	UC207-20 UC207-21 UC207-22 UC207 UC207-23	14.0	7.85	13.9	0.64
30 1 1/8	5 13/16	3 5/32	1 7/32	4 19/32	15/32	1/2	45/64	1 19/32	1.500	0.626	3/8	UCFL208E-24 UCFL208E-25 UCFL208E	FL208E	UC208-24 UC208-25 UC208	19.5	11.3	13.9	0.93
35 1 1/4 1 5/16 1 3/8	6 11/32	3 17/32	1 11/32	5 1/8	33/64	9/16	3/4	1 3/4	1.689	0.689	7/16	UCFL209E-26 UCFL209E-27 UCFL209E-28 UCFL209E	FL209E	UC209-26 UC209-27 UC209-28 UC209	3	15.4	13.9	1.2
40 1 1/2 1 9/16	6 7/8	3 15/16	1 13/32	5 21/32	33/64	9/16	53/64	2 1/32	1.937	0.748	7/16	UCFL210E-30 UCFL210E-31 UCFL210E UCFL210E-32	FL210E	UC210-30 UC210-31 UC210 UC210-32	29.1	17.8	14.0	1.6
45 1 5/8 1 11/16 1 3/4	7 13/32	4 1/4	1 1/2	5 27/32	19/32	19/32	55/64	2 1/16	1.937	0.748	1/2	UCFL211E-32 UCFL211E-33 UCFL211E-34 UCFL211E-35	FL211E	UC211-32 UC211-33 UC211-34 UC211-35	34.1	21.3	14.0	1.9
50 1 7/8 1 15/16	7 3/4	4 17/32	1 9/16	6 3/16	19/32	19/32	55/64	2 5/32	2.031	0.748	1/2	UCFL212E-36 UCFL212E UCFL212E-38 UCFL212E-39	FL212E	UC212-36 UC212 UC212-38 UC212-39	35.1	23.3	14.4	2.2
55 2 2 3/16	8 13/16	5 1/8	1 11/16	7 1/4	21/32	23/32	63/64	2 5/16	2.189	0.874	9/16	UCFL213E-40 UCFL213E	FL213E	UC213-40 UC213	43.4	29.4	14.4	3.3
60 2 1/4	9 27/32	5 1/2	1 7/8	7 61/64	21/32	23/32	1 9/64	2 23/32	2.563	1.000	9/16	UCFL214E-44 UCFL214E	FL214E	UC214-44 UC214	52.4	36.2	14.4	4.2
65 2 3/8 2 7/16	10 5/32	6 3/32	1 31/32	8 17/64	21/32	25/32	1 3/16	2 3/4	2.563	1.000	9/16	UCFL215E-47 UCFL215E UCFL215E-48	FL215E	UC215-47 UC215 UC215-48	57.2	40.1	14.4	5.2
70 2 3/4	10 7/16	6 9/16	2 1/8	8 1/2	21/32	25/32	1 7/32	2 31/32	2.937	1.189	9/16							
75 2 15/16 3	10 13/16	6 1/2	2 7/32	8 55/64	3/4	25/32	1 11/32	3 3/32	3.063	1.311	11/16							

Remarks 1. In Part No. of unit, fitting codes follow bore diameter numbers. (See Table 10.5 in P.42.)
2. Part No. of applicable grease nipples are shown below.
A-1/4-28UNF 201~210
A-PT1/8 211~217

3. As for the triple seal type product (from 201 to 205 are the double seal type products), accessory code L3 (or L2) follows the Part No. of unit or bearing. (Example of Part No. : UCFL206EJL3, UC206L3)
4. For the dimensions and forms of applicable bearings, see the dimensional tables of ball bearing for unit.

UCFL-E
Cylindrical bore (with set screws)
d 80 ~ 85 mm

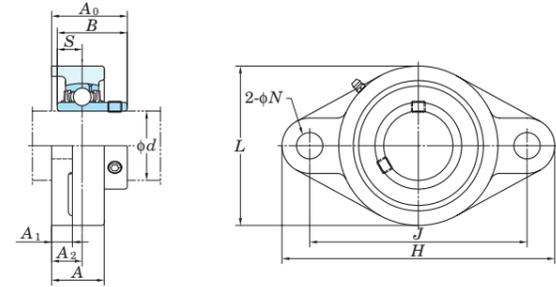

Variations of tolerance of distance from mounting surface to center of spherical bore (ΔA_{2s}) and tolerance of position of bolt hole (X)

Housing No.	ΔA_{2s}	X
FL203E-FL210E	± 0.5	0.7
FL211E-FL217E	± 0.8	1

Unit : mm

Variations of tolerance of bolt hole diameter (ΔN_s)

Housing No.	ΔN_s
FL203E-FL217E	± 0.2

Unit : mm

Shaft Dia. mm inch	Dimensions inch mm											Bolt Size inch	Unit No.	Housing No.	Bearing No.	Basic Load Ratings kN		Factor f_0	Mass kg
	d	H	L	A	J	N	A_1	A_2	A_0	B	S					C_r	C_{0r}		
80 3 1/8	11 13/32	7 3/32	2 9/32	9 11/64	3/4	25/32	1 11/32	3 9/32	3.252	1.311	11/16	UCFL216E-50 UCFL216E	FL216E	UC216-50 UC216	72.7	53.0	14.6	7.8	
	290	180	58	233	19	20	34	83.3	82.6	33.3									
85 3 1/4	12	7 15/32	2 15/32	9 49/64	3/4	7/8	1 27/64	3 7/16	3.374	1.343	11/16	UCFL217E-52 UCFL217E	FL217E	UC217-52 UC217	84.0	61.9	14.5	9.8	
	305	190	63	248	19	22	36	87.6	85.7	34.1									

- Remarks 1. In Part No. of unit, fitting codes follow bore diameter numbers. (See **Table 10.5** in P.42.)
 2. Part No. of applicable grease nipples are shown below.
 A-1/4-28UNF 201~210
 A-PT1/8 211~217

3. As for the triple seal type product (from 201 to 205 are the double seal type products), accessory code L3 (or L2) follows the Part No. of unit or bearing. (Example of Part No. : UCFL206EJL3, UC206L3)
 4. For the dimensions and forms of applicable bearings, see the dimensional tables of ball bearing for unit.

Oval two-bolt flange type units

NANFL
Cylindrical bore
(with eccentric locking collar)
d 12 ~ 55 mm

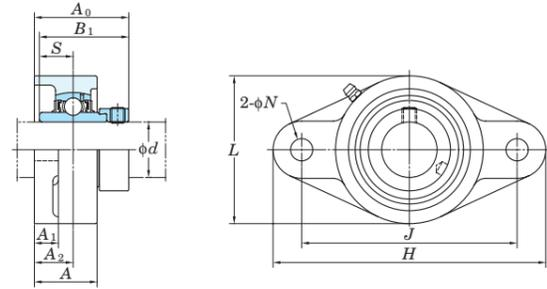

Variations of tolerance of distance from mounting surface to center of spherical bore (Δ_{A2s}) and tolerance of position of bolt hole (X)

Housing No.	Δ_{A2s}	X
NFL204-NFL210	± 0.5	0.7
NFL211	± 0.8	1

Variations of tolerance of bolt hole diameter (Δ_{Ns})

Housing No.	Δ_{Ns}
NFL204-NFL211	± 0.2

Shaft Dia mm inch <i>d</i>	Dimensions inch mm										Bolt Size inch	Unit No.	Housing No.	Bearing No.	Basic Load Ratings kN		Factor f_0	Mass kg
	<i>H</i>	<i>L</i>	<i>A</i>	<i>J</i>	<i>N</i>	<i>A</i> ₁	<i>A</i> ₂	<i>A</i> ₀	<i>B</i> ₁	<i>S</i>					<i>C</i> _r	<i>C</i> _{0r}		
12 1/2												NANFL201 NANFL201-8 NANFL202 NANFL202-10 NANFL203 NANFL204-12 NANFL204	NFL204	NA201 NA201-8 NA202 NA202-10 NA203 NA204-12 NA204	12.8	6.65	13.2	0.59
15 5/8	4 7/16	2 3/8	1 5/32	3 17/32	25/64	7/16	3/4	1 25/32	1.720	0.673	5/16							
17 3/4	113	60	29.5	89.7	10	11	19	45.6	43.7	17.1								
20												NANFL205-14 NANFL205-15 NANFL205 NANFL205-16	NFL205	NA205-14 NA205-15 NA205 NA205-16	14.0	7.85	13.9	0.9
25 7/8 15/16	5 1/8	2 11/16	1 7/32	3 57/64	15/32	1/2	25/32	1 27/32	1.748	0.689	3/8							
25	130	68	31	98.8	12	13	20	46.9	44.4	17.5								
30 1 1/8	5 13/16	3 5/32	1 11/32	4 19/32	15/32	1/2	53/64	2	1.906	0.720	3/8							
30	148	80	34	116.7	12	13	21	51.1	48.4	18.3								
35 1 1/4 1 5/16 1 3/8	6 11/32	3 17/32	1 7/16	5 1/8	33/64	9/16	27/32	2 1/8	2.012	0.740	7/16							
35	161	90	36.5	130.2	13	14	21.5	53.8	51.1	18.8								
40 1 1/2 1 9/16	6 7/8	3 15/16	1 17/32	5 21/32	33/64	9/16	15/16	2 5/16	2.217	0.843	7/16							
40	175	100	39	143.7	13	14	24	58.9	56.3	21.4								
45 1 5/8 1 11/16 1 3/4	7 13/32	4 1/4	1 9/16	5 27/32	19/32	9/16	15/16	2 5/16	2.217	0.843	1/2							
45	188	108	40	148.4	15	14	24	58.9	56.3	21.4								
50 1 7/8 1 15/16	7 3/4	4 17/32	1 27/32	6 3/16	19/32	9/16	1 1/8	2 5/8	2.469	0.969	1/2							
50	197	115	46.5	157	15	14	28.5	66.6	62.7	24.6								
55 2 2 1/8 2 3/16	8 13/16	5 1/8	1 31/32	7 1/4	21/32	25/32	1 17/64	2 31/32	2.811	1.094	9/16							
55	224	130	50	184	16.5	20	32	75.6	71.4	27.8								

Remarks 1. In Part No. of unit and units with covers, fitting codes follow bore diameter numbers. (See Table 10.5 in P.42.)

2. Part No. of applicable grease nipples are shown below.

A-1/4-28UNF 201~210

A-PT1/8 211

3. For the dimensions and forms of applicable bearings, see the dimensional tables of ball bearing for unit.

Oval tow-bolt flange type units

UKFL
Tapered bore (with adapter)
d₁ 20 ~ (50) mm

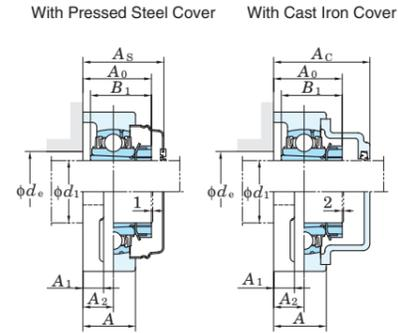
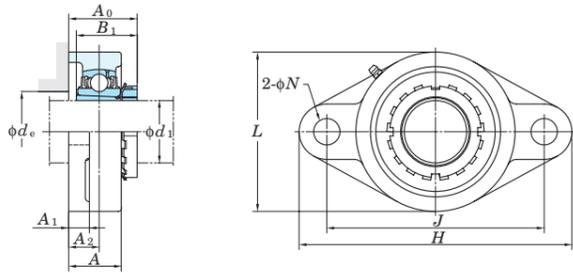

Variations of tolerance of distance from mounting surface to center of spherical bore (ΔA_{2a}) and tolerance of position of bolt hole (X) Unit : mm

Housing No.	ΔA _{2a}	X
FL205-FL210	±0.5	0.7
FL211-FL218	±0.8	1

Variations of tolerance of bolt hole diameter (ΔN_s) Unit : mm

Housing No.	ΔN _s
FL205-FL218	±0.2
FL312-FL326	±0.3

Forms and dimensions of L_c of FL205JE3 (housing with cast iron cover) are shown below.

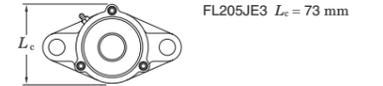

Shaft Dia. mm inch	Dimensions										Bolt Size inch mm	Standard			Adapter ¹⁾ No.	Mass kg	Basic			With Pressed Steel Cover			With Cast Iron Cover																					
	inch mm											Unit No.	Housing No.	Bearing No.			Load Ratings kN	Factor	Unit No. Open Type Closed Type	Dimension mm inch	Mass kg	Unit No. Open Type Closed Type	Dimension mm inch	Mass kg																				
d ₁	H	L	A	J	N	A ₁	A ₂	A ₀ ¹⁾	B ₁ ¹⁾	d _e (min.)				C _r	C _{0r}	f ₀	As		Ac																									
20	3/4	5 1/8	2 11/16	1 1/16	3 57/64	5/8	1/2	5/8	1 11/32(1 13/32)	1 5/32(1 3/8)	1 3/16	1/2	UKFL205	FL205	UK205	HE305X(HE2305X) H305X(H2305X)	0.68 0.68	14.0	7.85	13.9	-	-	-	-	-	-	-	-	-	-	-	-	-	-										
	3/4	5 9/16	3 9/32	1 3/16	4 39/64	15/32	1/2	45/64	1 15/32	1 3/8	1 3/16	3/8	UKFLX05	FLX05	UKX05	HE2305X H2305X	1.0 1.0	19.5	11.3	13.9	UKFL205C	UKFL205D	40	1 9/16	0.68	UKFL205FC	UKFL205FD	49	1 15/16	0.89	-	-	-	-	-	-								
	3/4	5 29/32	3 5/32	1 5/32	4 29/64	3/4	1/2	5/8	1 15/32	1 3/8	-	-	UKFL305	FL305	UK305	HE2305X H2305X	1.1 1.1	21.2	10.9	12.6	UKFLX05C	UKFLX05D	44	1 23/32	1.0	-	-	-	-	-	-	-	-	-	-	-	-	-						
25	1	5 13/16	3 5/32	1 7/32	4 39/64	5/8	1/2	45/64	1 15/32(1 9/16)	1 7/32(1 1/2)	1 13/32	3/8	UKFL206	FL206	UK206	H306X(H2306X) HE306X(HE2306X)	0.97 0.97	19.5	11.3	13.9	UKFL206C	UKFL206D	44	1 23/32	0.97	UKFL206FC	UKFL206FD	53	2 3/32	1.2	-	-	-	-	-	-	-	-	-					
	1	6 5/32	3 3/4	1 11/32	5 1/8	5/8	9/16	3/4	1 9/16	1 1/2	1 13/32	3/8	UKFLX06	FLX06	UKX06	H2306X HE2306X	1.5 1.5	25.7	15.4	13.9	UKFLX06C	UKFLX06D	49	1 15/16	1.5	-	-	-	-	-	-	-	-	-	-	-	-	-	-	-				
	1	7 3/32	3 17/32	1 1/4	5 9/32	29/32	19/32	45/64	1 5/8	1 1/2	-	-	UKFL306	FL306	UK306	H2306X HE2306X	1.5 1.5	26.7	15.0	13.3	-	-	-	-	-	-	-	-	-	-	-	-	-	-	-	-	-	-	-					
30	1 1/8	6 11/32	3 17/32	1 11/32	5 1/8	5/8	9/16	3/4	1 5/8(1 11/16)	1 3/8(1 11/16)	1 5/8	3/8	UKFL207	FL207	UK207	HS307X(HS2307X) H307X(H2307X)	1.3 1.3	25.7	15.4	13.9	UKFL207C	UKFL207D	49	1 15/16	1.3	UKFL207FC	UKFL207FD	58	2 9/32	1.7	-	-	-	-	-	-	-	-	-	-	-			
	1 1/8	6 23/32	4 1/8	1 1/2	5 49/64	5/8	9/16	59/64	1 23/32	1 11/16	1 5/8	3/8	UKFLX07	FLX07	UKX07	HS2307X H2307X	1.8 1.8	29.1	17.8	14.0	UKFLX07C	UKFLX07D	55	2 5/32	1.8	-	-	-	-	-	-	-	-	-	-	-	-	-	-	-	-			
	1 1/8	7 9/32	3 15/16	1 13/32	5 35/64	29/32	5/8	25/32	1 25/32	1 11/16	-	-	UKFL307	FL307	UK307	HS2307X H2307X	1.9 1.9	33.4	19.3	13.2	-	-	-	-	-	-	-	-	-	-	-	-	-	-	-	-	-	-	-	-				
35	1 1/4	6 7/8	3 15/16	1 13/32	5 43/64	5/8	9/16	53/64	1 3/4(1 7/8)	1 13/32(1 13/16)	1 13/16	3/8	UKFL208	FL208	UK208	HE308X(HE2308X) HS308X(HS2308X) H308X(H2308X)	1.6 1.6 1.6	29.1	17.8	14.0	UKFL208C	UKFL208D	55	2 5/32	1.6	UKFL208FC	UKFL208FD	64	2 17/32	2.0	-	-	-	-	-	-	-	-	-	-	-	-	-	-
	1 1/4	7 1/16	4 3/8	1 9/16	5 53/64	5/8	9/16	55/64	1 27/32	1 13/16	1 13/16	3/8	UKFLX08	FLX08	UKX08	HE2308X HS2308X H2308X	2.1 2.1 2.1	34.1	21.3	14.0	UKFLX08C	UKFLX08D	56	2 7/32	2.1	-	-	-	-	-	-	-	-	-	-	-	-	-	-	-	-	-	-	
	1 3/8	7 7/8	4 13/32	1 9/16	6 7/32	29/32	21/32	29/32	2	1 13/16	-	-	UKFL308	FL308	UK308	HE2308X HS2308X H2308X	2.5 2.5 2.5	40.7	24.0	13.2	-	-	-	-	-	-	-	-	-	-	-	-	-	-	-	-	-	-	-	-	-			
40	1 1/2	7 13/32	4 1/4	1 1/2	5 53/64	3/4	19/32	55/64	1 7/8(2)	1 17/32(1 31/32)	2 1/16	5/8	UKFL209	FL209	UK209	HE309X(HE2309X) H309X(H2309X) HS309X(HS2309X)	2.0 2.0 2.0	34.1	21.3	14.0	UKFL209C	UKFL209D	56	2 7/32	2.0	UKFL209FC	UKFL209FD	66	2 19/32	2.5	-	-	-	-	-	-	-	-	-	-	-	-	-	
	1 1/2	7 7/16	4 9/16	1 9/16	6 3/16	5/8	9/16	29/32	1 29/32	1 31/32	2 1/16	3/8	UKFLX09	FLX09	UKX09	HE2309X H2309X HS2309X	2.5 2.5 2.5	35.1	23.3	14.4	UKFLX09C	UKFLX09D	60	2 3/8	2.5	-	-	-	-	-	-	-	-	-	-	-	-	-	-	-	-	-		
	1 5/8	9 1/16	4 29/32	1 23/32	6 31/32	63/64	23/32	63/64	2 5/32	1 31/32	-	-	UKFL309	FL309	UK309	HE2309X H2309X HS2309X	3.6 3.6 3.6	48.9	29.5	13.3	-	-	-	-	-	-	-	-	-	-	-	-	-	-	-	-	-	-	-	-	-			
45	1 3/4	7 3/4	4 17/32	1 9/16	6 3/16	3/4	19/32	55/64	1 29/32(2 1/16)	1 21/32(2 5/32)	2 9/32	5/8	UKFL210	FL210	UK210	HE310X(HE2310X) H310X(H2310X)	2.3 2.3	35.1	23.3	14.4	UKFL210C	UKFL210D	59	2 5/16	2.3	UKFL210FC	UKFL210FD	70.5	2 25/32	2.8	-	-	-	-	-	-	-	-	-	-	-	-		
	1 3/4	8 1/2	5 1/4	1 23/32	7 1/4	3/4	25/32	1 1/32	1 3/32	2 5/32	2 9/32	5/8	UKFLX10	FLX10	UKX10	HE2310X H2310X	3.7 3.7	43.4	29.4	14.4	UKFLX10C	UKFLX10D	64	2 17/32	3.7	-	-	-	-	-	-	-	-	-	-	-	-	-	-	-	-			
	1 3/4	9 7/16	5 1/2	1 7/8	7 23/64	63/64	3/4	1 7/64	2 3/8	2 5/32	-	-	UKFL310	FL310	UK310	HE2310X H2310X	4.4 4.4	62.0	38.3	13.2	-	-	-	-	-	-	-	-	-	-	-	-	-	-	-	-	-	-	-	-				
50	1 7/8	8 13/16	5 1/8	1 11/16	7 1/4	3/4	23/32	63/64	2 1/16(2 1/4)	1 25/32(2 5/16)	2 17/32	5/8	UKFL211	FL211	UK211	HS311X(HS2311X) H311X(H2311X)	3.3 3.3	43.4	29.4	14.4	UKFL211C	UKFL211D	63	2 15/32	3.3	UKFL211FC	UKFL211FD	74.5	2 15/16	3.9	-	-	-	-	-	-	-	-	-	-	-	-		
	2	224	130	43	184	19	18	25	52.5(57)	45(59)	64	M16																																

Note 1) Codes shown in parentheses indicate the dimensions and Part No. of applicable adapter (H2300X series) for UK200L3 series (triple seal type).

Remarks 1. In Part No. of unit and units with covers, fitting codes follow bore diameter numbers. (See Table 10.5 in P.42.)

2. Part No. of applicable grease nipples are shown below.
A-1/4-28UNF.....205-210, X05-X09, 305-308
A-PT1/8.....211-218, X10, 309-326

3. In Part No. of unit with adapters and bearing with adapters, Part No. of applicable adapter follow the Part No. shown in the dimensional tables. (Example of Part No. : UKFL206J + H306X, UK206 + H306X)

4. As for the triple seal type product (205 is the double seal type product), accessory code L3 (or L2) follows the Part No. of unit or bearing. (Example of Part No. : UKFL206JL3 + H2306X, UK206L3 + H2306X)

5. For the dimensions and forms of applicable bearings and adapters, see the dimensional tables of ball bearing for unit and adapter.

UCFA
Cylindrical bore (with set screws)
d 12 ~ 55 mm

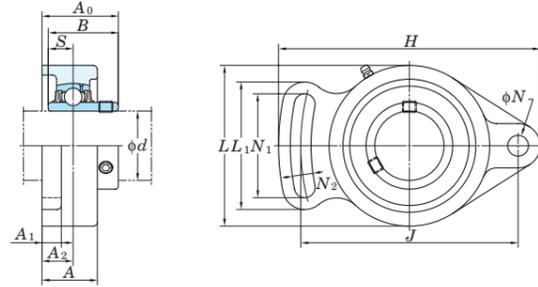

Variations of tolerance of distance from mounting surface to center of spherical bore (Δ_{A2s})

Housing No.	Unit : mm
FA204-FA210	± 0.5
FA211	± 0.8

Variations of tolerance of bolt hole diameter (Δ_{N6})

Housing No.	Unit : mm
FA204-FA211	± 0.2

Shaft Dia. mm inch d	Dimensions inch mm													Bolt Size inch mm	Unit No.	Housing No.	Bearing No.	Basic Load Ratings kN		Factor f_0	Mass kg	
	H	L	A	J	N	N ₁	N ₂	L ₁	A ₁	A ₂	A ₀	B	S					C _r	C _{0r}			
12 1/2																UCFA201 UCFA201-8 UCFA202 UCFA202-10 UCFA203 UCFA204-12 UCFA204	FA204	UC201 UC201-8 UC202 UC202-10 UC203 UC204-12 UC204	12.8	6.65	13.2	0.47 0.45 0.44 0.42
15 5/8	3 27/32	2 5/16	15/16	3 5/64	25/64	1 9/16	13/32	1 31/32	7/16	35/64	1 1/4	1.220	0.500		5/16 M8							
17 3/4	98	59	24	78	10	40	10	50	11	13.8	32.1	31	12.7									
20																UCFA205-14 UCFA205-15 UCFA205 UCFA205-16	FA205	UC205-14 UC205-15 UC205 UC205-16	14.0	7.85	13.9	0.68
25 7/8 15/16	4 7/8	2 3/4	1 1/16	3 55/64	7/16	1 15/16	7/16	2 17/32	1/2	5/8	1 13/32	1.343	0.563		3/8 M10							
25 1	124	70	27	98	11	49	11	64	13	16	35.8	34.1	14.3									
30 1 1/8	5 9/16	3 9/32	1 3/16	4 39/64	7/16	2 7/32	15/32	2 11/16	1/2	45/64	1 9/16	1.500	0.626		3/8 M10							
30 1 3/16	141	83	30	117	11	56	12	68	13	17.8	40	38.1	15.9									
30 1 1/4																UCFA206-18 UCFA206 UCFA206-19 UCFA206-20	FA206	UC206-18 UC206 UC206-19 UC206-20	19.5	11.3	13.9	1.0
35 1 1/4 1 5/16	6 3/32	3 25/32	1 11/32	5 1/8	33/64	2 15/32	1/2	2 15/16	9/16	47/64	1 23/32	1.689	0.689		7/16 M12							
35 1 3/8	155	96	34	130	13	63	13	75	14	18.6	44	42.9	17.5									
35 1 7/16																UCFA207-20 UCFA207-21 UCFA207-22 UCFA207 UCFA207-23	FA207	UC207-20 UC207-21 UC207-22 UC207 UC207-23	25.7	15.4	13.9	1.5
40 1 1/2 1 9/16	6 23/32	4 1/8	1 1/2	5 43/64	33/64	2 3/4	1/2	3 5/16	9/16	13/16	2	1.937	0.748		7/16 M12							
40	171	105	38	144	13	70	13	84	14	20.8	51	49.2	19									
45 1 5/8 1 11/16	7 1/16	4 3/8	1 9/16	5 53/64	19/32	2 27/32	19/32	3 15/32	9/16	55/64	2 1/16	1.937	0.748		1/2 M14							
45 1 3/4	179	111	40	148	15	72	15	88	14	21.8	52	49.2	19									
45																UCFA209-26 UCFA209-27 UCFA209-28 UCFA209	FA209	UC209-26 UC209-27 UC209-28 UC209	34.1	21.3	14	1.7
50 1 7/8 1 15/16	7 7/16	4 9/16	1 9/16	6 3/16	19/32	2 15/16	19/32	3 5/8	9/16	57/64	2 5/32	2.031	0.748		1/2 M14							
50	189	116	40	157	15	75	15	92	14	22.5	55.1	51.6	19									
50																UCFA210-30 UCFA210-31 UCFA210 UCFA210-32	FA210	UC210-30 UC210-31 UC210 UC210-32	35.1	23.3	14.4	2.0
55 2 2 1/8	8 1/2	5 1/4	1 23/32	7 1/4	5/8	3 3/8	5/8	4 1/32	25/32	1 1/64	2 5/16	2.189	0.874		1/2 M14							
55 2 3/16	216	133	44	184	16	86	16	102	20	25.7	59.1	55.6	22.2									
55																UCFA211-32 UCFA211-34 UCFA211 UCFA211-35	FA211	UC211-32 UC211-34 UC211 UC211-35	43.4	29.4	14.4	3.6

Remarks 1. In Part No. of unit and units with covers, fitting codes follow bore diameter numbers. (See Table 10.5 in P.42.)

2. Part No. of applicable grease nipples are shown below.
A-1/4-28UNF 201~210
A-PT1/8.....211

3. As for triple seal type product (from 201 to 205 are the double seal type products), accessory code L3 (or L2) follows Part No. of unit or bearing. (Example of Part No. : UCFA206JL3, UC206L3)

4. For the dimensions and forms of applicable bearings, see the dimensional tables of ball bearing for unit.

5. Tapered bore (with adapter) type products are also available. (Example of Part No. : UKFA205J + H305X, UK205 + H305X)

Three-bolt flange type units

UCFB
Cylindrical bore (with set screws)
d 12 ~ 50 mm

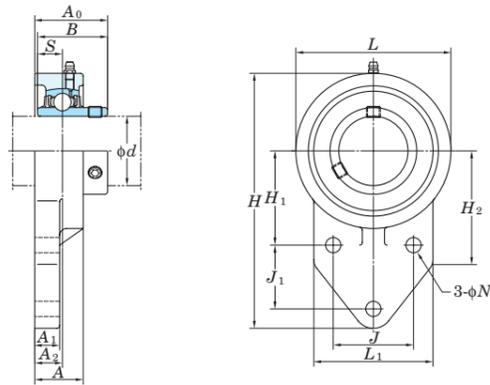

Variations of tolerance of distance from mounting surface to center of spherical bore (ΔA_{2s}), variations of tolerance of distance between centers of bolt holes ($\Delta J_n, \Delta J_{1n}$), variations of tolerance of distance between both grooves (ΔH_{1n})

Housing No.	ΔA_{2s}	ΔJ_n	ΔJ_{1n}	ΔH_{1n}
FB204-FB210	±0.5			

Variations of tolerance of bolt hole diameter (ΔN_s)

Housing No.	ΔN_s
FB204-FB210	±0.2

Shaft Dia. mm inch d	Dimensions inch mm															Bolt Size inch mm	Unit No.	Housing No.	Bearing No.	Basic Load Ratings kN		Factor f_0	Mass kg		
	H	L	A	J	J ₁	N	H ₁	H ₂	L ₁	A ₁	A ₂	A ₀	B	S	C _r					C _{0r}					
12 1/2																5/16	UCFB201 UCFB201-8 UCFB202 UCFB202-10 UCFB203 UCFB204-12 UCFB204	FB204	UC201 UC201-8 UC202 UC202-10 UC203 UC204-12 UC204	12.8	6.65	13.2	0.64 0.62 0.61 0.59		
15 5/8	4 11/32	2 7/16	1 9/16	1 17/64	1 11/16	3/8	1 21/32	2 1/16	2 1/16	1/2	17/32	1 1/4	1.220	0.500		5/16	UCFB205-14 UCFB205-15 UCFB205 UCFB205-16	FB205	UC205-14 UC205-15 UC205 UC205-16	14.0	7.85	13.9	0.68		
17 3/4	110	62	24	32	27	9.5	42	52	52	13	13.5	31.8	31	12.7		M8	UCFB206-18 UCFB206 UCFB206-19 UCFB206-20	FB206	UC206-18 UC206 UC206-19 UC206-20	19.5	11.3	13.9	0.92		
20																5/16	UCFB207-20 UCFB207-21 UCFB207-22 UCFB207 UCFB207-23	FB207	UC207-20 UC207-21 UC207-22 UC207 UC207-23	25.7	15.4	13.9	1.3		
25 7/8 15/16	4 9/16	2 11/16	1 1/32	1 11/32	1 1/16	3/8	1 49/64	2 1/16	2 7/32	1/2	19/32	1 3/8	1.343	0.563		5/16	UCFB208-24 UCFB208-25 UCFB208	FB208	UC208-24 UC208-25 UC208	29.1	17.8	14.0	1.8		
25 1	116	68	26	34	27	9.5	45	52	56	13	15	34.8	34.1	14.3		M8	UCFB209-26 UCFB209-27 UCFB209-28 UCFB209	FB209	UC209-26 UC209-27 UC209-28 UC209	34.1	21.3	14.0	2.0		
30 1 1/8	5 1/8	3 1/16	1 5/32	1 37/64	1 9/64	3/8	1 31/32	2 5/32	2 9/16	1/2	43/64	1 17/32	1.500	0.626		5/16	UCFB210-30 UCFB210-31 UCFB210	FB210	UC210-30 UC210-31 UC210	35.1	23.3	14.4	2.3		
30 1 3/16 1 1/4	130	78	29	40	29	9.5	50	55	65	13	17	39.2	38.1	15.9		M8									
35 1 1/4 1 5/16 1 3/8	5 21/32	3 17/32	1 5/16	1 13/16	1 17/64	3/8	2 11/64	2 7/16	2 3/4	19/32	3/4	1 3/4	1.689	0.689		5/16									
35 1 7/16	144	90	33	46	32	9.5	55	62	70	15	19	44.4	42.9	17.5		M8									
40 1 1/2 1 9/16	6 15/32	3 15/16	1 11/32	1 31/32	1 39/64	7/16	2 23/64	2 27/32	3 1/16	5/8	25/32	1 31/32	1.937	0.748		3/8									
40 1 9/16	164	100	34	50	41	11	60	72	78	16	20	50.2	49.2	19		M10									
45 1 5/8 1 11/16 1 3/4	6 27/32	4 3/16	1 11/32	2 1/8	1 11/16	7/16	2 9/16	3	3 5/32	23/32	25/32	1 31/32	1.937	0.748		3/8									
45 1 3/4	174	106	34	54	43	11	65	76	80	18	20	50.2	49.2	19		M10									
50 1 7/8 1 15/16	7 1/4	4 13/32	1 3/8	2 9/32	1 13/16	7/16	2 43/64	3 7/32	3 3/8	23/32	25/32	2 1/16	2.031	0.748		3/8									
50 2	184	112	35	58	46	11	68	82	86	18	20	52.6	51.6	19		M10									

Remarks 1. In Part No. of unit and units with covers, fitting codes follow bore diameter codes. (See Table 10.5 in P.42.)
 2. Part No. of applicable grease nipple is A-1/4-28UNF.
 3. As for the triple seal type product (from 201 to 205 are the double seal type products), accessory code L3 (or L2) follows Part No. of unit or bearing. (Example of Part No. : UCFB206JL3, UC206L3)

4. For the dimensions and forms of applicable bearings, see the dimensional tables of ball bearing for unit.
 5. Tapered bore (with adapter) type products are also available. (Example of Part No. : UKFB205J + H305X, UK205 + H305X)

Lightweight oval two-bolt flange type units

BLF
Cylindrical bore
(with set screw locking)
ALF
Cylindrical bore
(with eccentric locking collar)
d 12 ~ 35 mm

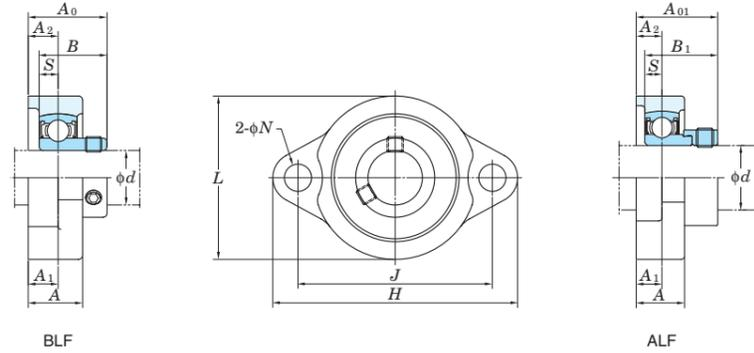

Variations of tolerance of distance from mounting surface to center of spherical bore (ΔA_{2s}) and variations of tolerance of distance between centers of bolt holes (ΔJ_s)

Housing No.	ΔA_{2s}	ΔJ_s
LF203-LF207	±0.5	±0.7

Variations of tolerance of bolt hole diameter (ΔN_s)

Housing No.	ΔN_s
LF203-LF207	±0.2

Shaft Dia. mm inch	Dimensions														Bolt Size inch mm	Unit No.	Bearing No.	Unit No.	Bearing No.	Housing No.	Basic Load Ratings		Factor f_0	Mass	
	inch mm																				kN			kg	
	<i>H</i>	<i>L</i>	<i>A</i>	<i>J</i>	<i>N</i>	<i>A</i> ₁	<i>A</i> ₂	<i>S</i>	BLF		ALF		<i>C_r</i>	<i>C_{0r}</i>							BLF	ALF			
12 1/2	3 3/16	2 1/16	23/32	2 1/2	5/16	3/8	3/8	0.236	1	0.866	1 1/4	1.122	1/4	BLF201	SB201	ALF201	SA201	LF203	9.55	4.80	13.2	0.25	0.28		
15 5/8	81	52	18	63.5	8	9.5	9.5	6	25.5	22	32	28.5	M6	BLF201-8	SB201-8	ALF201-8	SA201-8								
17														BLF202	SB202	ALF202	SA202								
20 3/4	3 17/32	2 3/8	25/32	2 13/16	25/64	7/16	7/16	0.276	1 5/32	0.984	1 5/16	1.161	5/16	BLF202-10	SB202-10	ALF202-10	SA202-10	LF204	12.8	6.65	13.2	0.33	0.33		
25 7/8	90	60	20	71.5	10	11	11	7	29	25	33.5	29.5	M8	BLF203	SB203	ALF203	SA203								
25 15/16	3 3/4	2 17/32	25/32	2 63/64	25/64	7/16	7/16	0.295	1 3/16	1.063	1 11/32	1.201	5/16	BLF204-12	SB204-12	ALF204-12	SA204-12								
30 1 1/8	4 7/16	3	7/8	3 9/16	15/32	15/32	15/32	0.315	1 11/32	1.181	1 1/2	1.335	3/8	BLF204	SB204	ALF204	SA204	LF205	14.0	7.85	13.9	0.38	0.42		
30 1 3/16	113	76	22.5	90.5	12	12	12	8	34	30	37.9	33.9	M10	BLF205-14	SB205-14	ALF205-14	SA205-14								
30 1 1/4														BLF205-15	SB205-15	ALF205-15	SA205-15								
35 1 1/4	4 13/16	3 1/2	15/16	3 15/16	15/32	1/2	33/64	0.335	1 7/16	1.260	1 5/8	1.437	3/8	BLF205	SB205	ALF205	SA205	LF206	19.5	11.3	13.9	0.57	0.60		
35 1 5/16	122	89	24	100	12	13	13	8.5	36.5	32	41	36.5	M10	BLF205-16	SB205-16	ALF205-16	SA205-16								
35 1 3/8														BLF206-18	SB206-18	ALF206-18	SA206-18								
35 1 7/16														BLF206	SB206	ALF206	SA206	LF207	25.7	15.4	13.9	0.77	0.85		
														BLF206-19	SB206-19	ALF206-19	SA206-19								
														BLF206-20	SB206-20	ALF206-20	SA206-20								
														BLF207-20	SB207-20	ALF207-20	SA207-20	LF207	25.7	15.4	13.9	0.77	0.85		
														BLF207-21	SB207-21	ALF207-21	SA207-21								
														BLF207-22	SB207-22	ALF207-22	SA207-22								
														BLF207	SB207	ALF207	SA207	LF207	25.7	15.4	13.9	0.77	0.85		
														BLF207-23	SB207-23	ALF207-23	SA207-23								

Remarks 1. In Part No. of unit and units with covers, fitting codes follow bore diameter codes. (See Table 10.5 in P.42.)
 2. Allowable load to housing in radial direction is approximately half of basic load rating of bearing, C_r (when safety factor is 4).
 3. For the dimensions and forms of applicable bearings, see the dimensional tables of ball bearing for unit.

Clean series oval two-bolt flange type units

UFL
Cylindrical bore (with set screws)
d 8 ~ 30 mm

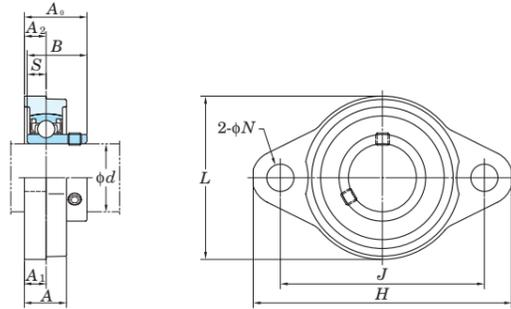

With Through Type Cover With One Side Sealed Cover

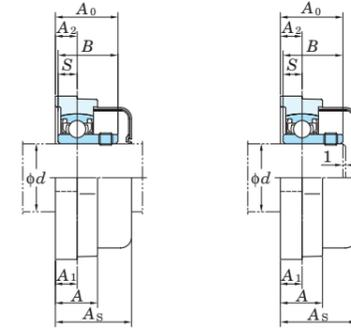

Variations of tolerance of distance from mounting surface to center of spherical bore (ΔA_{2s}) and variations of tolerance of distance between centers of bolt holes (ΔJ_s)

Housing No.	ΔA_{2s}	ΔJ_s
FL08	±0.5	±0.3
FL000-FL006		

Variations of tolerance of bolt hole diameter (ΔN_s)

Housing No.	ΔN_s
FL08	±0.2
FL000-FL006	

Shaft Dia. mm d	Dimensions inch mm										Bolt Size inch mm	Standard			Mass kg	Basic Load Ratings kN		Factor f ₀	With Rubber Coated Cover		
	H	L	A	J	N	A ₁	A ₂	A ₀	B	S		Unit No.	Housing No.	Bearing No.		C _r	C _{0r}		Unit No. Open Type Closed Type	Dimension mm inch	Mass kg
8	1 7/8 48	1 1/16 27	1 1/32 8.5	1 29/64 37	3/16 4.8	5/32 4	5/32 4	1/2 12.5	0.472 12	0.1378 3.5	No.8 M4	FL08	SU08	3.27	1.37	12.4	-	-	-	-	-
10	2 3/8 60	1 13/32 36	1 5/32 12	1 49/64 45	9/32 7	1/4 6	15/64 6	5/8 16	0.591 15	0.197 5	1/4 M6	FL000	SU000	4.55	1.95	12.3	UFL000C	UFL000D	20.5	13/16	0.050
12	2 15/32 63	1 1/2 38	1 15/32 12	1 57/64 48	9/32 7	1/4 6	15/64 6	5/8 16	0.591 15	0.197 5	1/4 M6	FL001	SU001	5.10	2.40	13.2	UFL001C	UFL001D	20.5	13/16	0.065
15	2 5/8 67	1 21/32 42	1/2 13	2 3/32 53	9/32 7	1/4 6.5	1/4 6.5	11/16 17.5	0.650 16.5	0.217 5.5	1/4 M6	FL002	SU002	5.60	2.85	13.9	UFL002C	UFL002D	22	7/8	0.085
17	2 25/32 71	1 13/16 46	9/16 14	2 13/64 56	9/32 7	9/32 7	9/32 7	23/32 18.5	0.689 17.5	0.236 6	1/4 M6	FL003	SU003	6.00	3.25	14.4	UFL003C	UFL003D	23.5	15/16	0.11
20	3 17/32 90	2 5/32 55	5/8 16	2 51/64 71	13/32 10	5/16 8	5/16 8	7/8 22	0.827 21	0.276 7	5/16 M8	FL004	SU004	9.40	5.05	13.9	UFL004C	UFL004D	27	1 1/16	0.18
25	3 3/4 95	2 3/8 60	5/8 16	2 61/64 75	13/32 10	5/16 8	5/16 8	29/32 23	0.866 22	0.276 7	5/16 M8	FL005	SU005	10.1	5.85	14.5	UFL005C	UFL005D	28	1 3/32	0.23
30	4 13/32 112	2 3/4 70	23/32 18	3 11/32 85	1/2 13	11/32 9	23/64 9	1 1/32 26	0.965 24.5	0.295 7.5	3/8 M10	FL006	SU006	13.2	8.25	14.7	UFL006C	UFL006D	31	1 7/32	0.31

Remarks 1. In Part No. of unit and units with covers, fitting codes follow bore diameter codes. (See Table 10.5 in P.42.)
2. Clean series oval flange type unit.
3. For the dimensions and forms of applicable bearings, see the dimensional tables of ball bearing for unit.

UCSFL-H1S6
Cylindrical bore (with set screws)
 d 20 ~ 50 mm

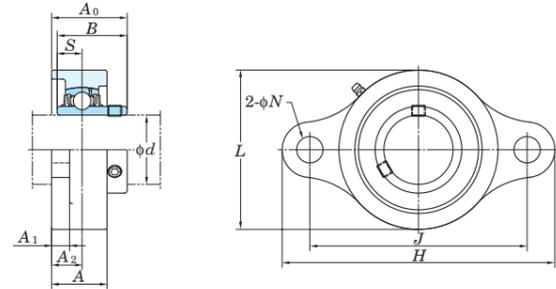

With Pressed Stainless Steel Cover

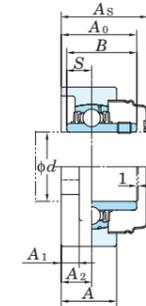

Variations of tolerance of distance from mounting surface to center of spherical bore (ΔA_{2s}) and variations of tolerance of distance between centers of bolt holes (ΔJ_s)

Housing No.	ΔA_{2s}	ΔJ_s
SFL204H1-SFL210H1	± 0.5	0.3

Variations of tolerance of bolt hole diameter (ΔN_s)

Housing No.	ΔN_s
SFL204H1-SFL210H1	± 0.2

Shaft Dia. mm d	Dimensions										Bolt Size inch mm	Standard			Mass kg	Basic Load Ratings kN		Factor f ₀	With Pressed Stainless Steel Cover			
	inch mm											Unit No.	Housing No.	Bearing No.		Open Type	Closed Type		Dimension mm inch	Mass kg		
20	4 7/16	2 3/8	1 1/32	3 35/64	15/32	13/32	19/32	1 5/16	1.220	0.500	3/8	UCSFL204H1S6	SFL204H1	UC204S6	0.43	10.9	5.35	13.2	UCSFL204H1CS6	UCSFL204H1DS6	38 1 1/2	0.43
	113	60	26	90	12	10	15	33.3	31	12.7	M10											
25	5 1/8	2 11/16	1 3/32	3 57/64	5/8	13/32	5/8	1 13/32	1.343	0.563	1/2	UCSFL205H1S6	SFL205H1	UC205S6	0.60	11.9	6.30	13.9	UCSFL205H1CS6	UCSFL205H1DS6	40 1 9/16	0.60
	130	68	27.5	99	16	10	16	35.8	34.1	14.3	M14											
30	5 13/16	3 5/32	1 7/32	4 39/64	5/8	13/32	45/64	1 19/32	1.500	0.626	1/2	UCSFL206H1S6	SFL206H1	UC206S6	0.86	16.5	9.05	13.9	UCSFL206H1CS6	UCSFL206H1DS6	45 1 15/32	0.86
	148	80	31	117	16	10	18	40.2	38.1	15.9	M14											
35	6 11/32	3 11/32	1 11/32	5 1/8	5/8	7/16	3/4	1 3/4	1.689	0.689	1/2	UCSFL207H1S6	SFL207H1	UC207S6	1.1	21.8	12.3	13.9	UCSFL207H1CS6	UCSFL207H1DS6	49 1 15/16	1.1
	161	85	34	130	16	11	19	44.4	42.9	17.5	M14											
40	6 7/8	3 11/16	1 13/32	5 43/64	5/8	15/32	53/64	2 1/32	1.937	0.748	1/2	UCSFL208H1S6	SFL208H1	UC208S6	1.5	24.8	14.3	14.0	UCSFL208H1CS6	UCSFL208H1DS6	56 2 7/32	1.5
	175	94	36	144	16	12	21	51.2	49.2	19	M14											
45	7 13/32	3 15/16	1 1/2	5 53/64	3/4	1/2	55/64	2 1/16	1.937	0.748	5/8	UCSFL209H1S6	SFL209H1	UC209S6	1.8	27.8	16.2	14.0	UCSFL209H1CS6	UCSFL209H1DS6	57 1 1/4	1.8
	188	100	38	148	19	13	22	52.2	49.2	19	M16											
50	7 3/4	4 3/16	1 9/16	6 3/16	3/4	1/2	55/64	2 5/32	2.031	0.748	5/8	UCSFL210H1S6	SFL210H1	UC210S6	2.1	29.8	18.6	14.4	UCSFL210H1CS6	UCSFL210H1DS6	59 2 5/16	2.1
	197	106	40	157	19	13	22	54.6	51.6	19	M16											

- Remarks 1. In Part No. of unit and units with covers, fitting codes follow bore diameter codes. (See Table 10.5 in P.42.)
 2. Stainless steel series thin oval flange type unit.
 3. Part No. of applicable grease nipple is A-1/4-28UNFN12.
 4. For the dimensions and forms of applicable bearings, see the dimensional tables of ball bearing for unit.

USFL-S6
Cylindrical bore (with set screws)
 d 10 ~ 30 mm

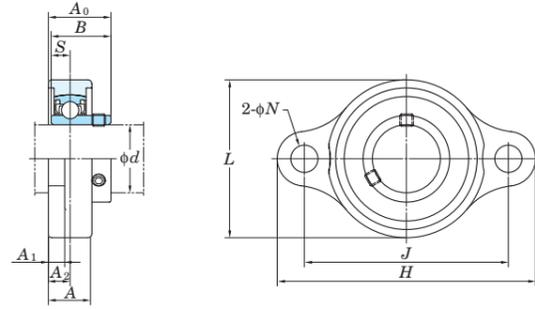

With Through Type Cover With One Side Sealed Cover

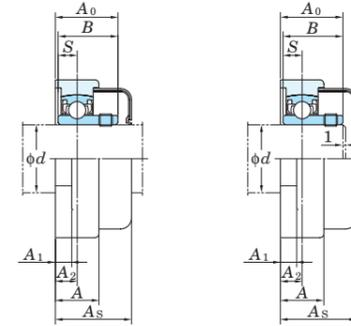

Variations of tolerance of distance from mounting surface to center of spherical bore (ΔA_{2s}) and variations of tolerance of distance between centers of bolt holes (ΔJ_s)

Housing No.	ΔA_{2s}	ΔJ_s
SFL000-SFL006	± 0.5	± 0.3

Unit : mm

Variations of tolerance of bolt hole diameter (ΔN_s)

Housing No.	ΔN_s
SFL000-SFL006	± 0.2

Unit : mm

Shaft Dia. mm d	Dimensions inch mm										Bolt Size inch mm	Standard			Mass kg	Basic Load Ratings kN		Factor f_0	With Rubber Coated Cover		
	H	L	A	J	N	A_1	A_2	A_0	B	S		Unit No.	Housing No.	Bearing No.		C_r	C_{0r}		Unit No. Open Type Closed Type	Dimension mm inch	Mass kg
10	2 3/8 60	1 11/32 34	15/32 12	1 49/64 45	9/32 7	3/16 5	15/64 6	5/8 16	0.591 15	0.197 5	1/4 M6	USFL000S6	SFL000	SU000S6	0.076	3.9 1.55	12.3	USFL000CS6 USFL000DS6	20.5 13/16	0.076	
12	2 15/32 63	1 13/32 36	15/32 12	1 57/64 48	9/32 7	3/16 5	15/64 6	5/8 16	0.591 15	0.197 5	1/4 M6	USFL001S6	SFL001	SU001S6	0.080	4.3 1.9	13.2	USFL001CS6 USFL001DS6	20.5 13/16	0.080	
15	2 5/8 67	1 5/8 41	1/2 13	2 3/32 53	9/32 7	1/4 6	1/4 6.5	11/16 17.5	0.650 16.5	0.217 5.5	1/4 M6	USFL002S6	SFL002	SU002S6	0.1	4.7 2.25	13.9	USFL002CS6 USFL002DS6	22 7/8	0.1	
17	2 25/32 71	1 23/32 44	9/16 14	2 13/64 56	9/32 7	1/4 6	9/32 7	23/32 18.5	0.689 17.5	0.236 6	1/4 M6	USFL003S6	SFL003	SU003S6	0.13	5.1 2.6	14.4	USFL003CS6 USFL003DS6	23.5 15/16	0.13	
20	3 19/32 91	2 3/32 53	5/8 16	2 51/64 71	13/32 10	1/4 6	5/16 8	7/8 22	0.827 21	0.276 7	5/16 M8	USFL004S6	SFL004	SU004S6	0.21	7.9 4	13.9	USFL004CS6 USFL004DS6	27 1 1/16	0.21	
25	3 3/4 95	2 9/32 58	5/8 16	2 51/64 75	13/32 10	1/4 6	5/16 8	29/32 23	0.866 22	0.276 7	5/16 M8	USFL005S6	SFL005	SU005S6	0.23	8.5 4.65	14.5	USFL005CS6 USFL005DS6	28 1 3/32	0.23	
30	4 11/32 110	2 19/32 66	23/32 18	3 11/32 85	1/2 13	9/32 7	23/64 9	1 1/32 26	0.965 24.5	0.295 7.5	3/8 M10	USFL006S6	SFL006	SU006S6	0.33	11.2 6.6	14.7	USFL006CS6 USFL006DS6	31 1 7/32	0.33	

Remarks 1. In Part No. of unit and units with covers, fitting codes follow bore diameter codes. (See Table 10.5 in P.42.)
2. Clean size stainless steel series oval flange type unit.
3. For the dimensions and forms of applicable bearings, see the dimensional tables of ball bearing for unit.

Round flange cartridge type units

UCFC
Cylindrical bore (with set screws)
d 55 ~ 100 mm

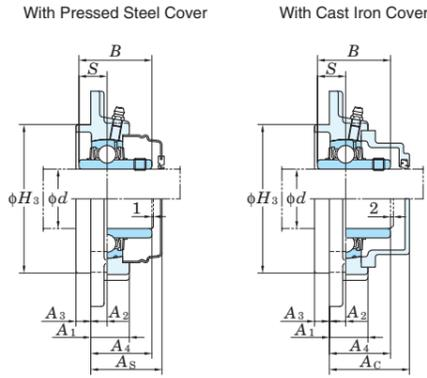
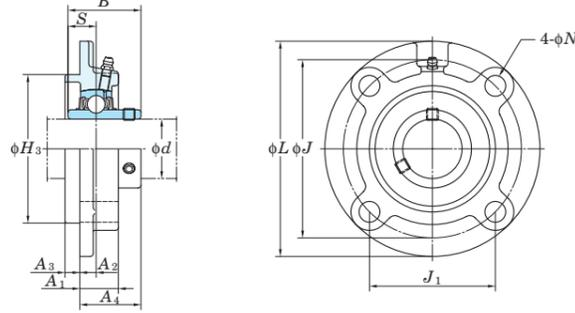

Variations of tolerance of spigot joint outside diameter (ΔH_{3s}), variations of tolerance of distance from mounting surface to center of spherical bore (ΔA_{2s}), tolerance of position of bolt hole (X), and tolerance of circumferential runout of spigot joint (Y)

Housing No.		ΔH_{3s}	ΔA_{2s}	X	Y
FC204-FC206	FCX05	0 -0.046	±0.5	0.7	0.2
FC207-FC210	FCX06-FCX10	0 -0.054			
FC211-FC217	FCX11-FCX15	0 -0.063	±0.8	1	0.3
FC218	FCX16-FCX18 FCX20	0 -0.072			

Variations of tolerance of bolt hole diameter (ΔN_s)

Housing No.		ΔN_s
FC204-FC218	FCX05-FCX20	±0.2

Shaft Dia. mm inch d	Dimensions inch mm											Bolt Size inch mm	Standard			Basic		Factor f ₀	With Pressed Steel Cover			With Cast Iron Cover								
	L	H ₃	J	J ₁	N	A ₁	A ₂	A ₃	A ₄	B	S		Unit No.	Housing No.	Bearibg No.	Mass kg	Load Ratings kN C _r C _{0r}		Unit No. Open Type Closed Type	Dimension mm inch A _s	Mass kg	Unit No. Open Type Closed Type	Dimension mm inch A _c	Mass kg						
55 2 2 1/8 2 3/16	7 9/32	4.9213	5 29/32	4 11/64	3/4	1 7/32	33/64	15/32	1 13/16	2.189	0.874	5/8	FC211	UC211-32	4.2	43.4 29.4	14.4	-	-	-	-	-	-							
	185	125	150	106.1	19	31	13	12	46.4	55.6	22.2	M16		UC211-34				UC211-35	UCFC211C	UCFC211D	51	2	4.2	UCFC211FC	UCFC211FD	62.5	2 15/32	4.8		
	7 3/32	5	5 63/64	4 15/64	5/8	1 1/32	5/32	55/64	1 23/32	2.563	1.000	1/2		UCFCX11				UCX11	4.3	52.4 36.2	14.4	UCFCX11C	UCFCX11D	46	1 13/16	4.3	-	-	-	-
	180	127	152	107.5	16	26	4	22	43.7	65.1	25.4	M14		UCFCX11-35				UCX11-35	4.3	-	-	-	-	-	-	-	-	-		
60 2 1/4 2 3/8 2 7/16	7 11/16	5.3150	6 19/64	4 29/64	3/4	1 13/32	43/64	15/32	2 7/32	2.563	1.000	5/8	FC212	UC212-36	5.0	52.4 36.2	14.4	-	-	-	-	-	-	-						
	195	135	160	113.1	19	36	17	12	56.7	65.1	25.4	M16		UC212				UC212-38	UCFC212C	UCFC212D	61	2 13/32	5.0	UCFC212FC	UCFC212FD	74	2 29/32	5.8		
	7 5/8	5.5118	6 1/2	4 19/32	5/8	1 5/16	7/16	25/32	2	2.563	1.000	1/2		UCFCX12				UCX12	5.3	57.2 40.1	14.4	UCFCX12C	UCFCX12D	55	2 5/32	5.3	-	-	-	-
	194	140	165	116.7	16	33	11	20	50.7	65.1	25.4	M14		UCFCX12-39				UCX12-39	5.3	-	-	-	-	-	-	-	-			
65 2 1/2 2 1/2	8 1/16	5.7087	6 11/16	4 47/64	3/4	1 13/32	5/8	35/64	2 3/16	2.563	1.000	5/8	FC213	UC213-40	5.6	57.2 40.1	14.4	-	-	-	-	-	-	-						
	205	145	170	120.2	19	36	16	14	55.7	65.1	25.4	M16		UC213				UC213-40	UCFC213C	UCFC213D	60	2 3/8	5.6	UCFC213FC	UCFC213FD	73	2 7/8	6.4		
	7 5/8	5.5118	6 1/2	4 19/32	5/8	1 5/16	7/16	25/32	2 3/16	2.937	1.189	1/2		UCFCX13-40				UCX13-40	5.7	62.2 44.1	14.5	-	-	-	-	-	-	-		
	194	140	165	116.7	16	33	11	20	55.4	74.6	30.2	M14		UCFCX13				UCX13	5.7	62.2 44.1	14.5	UCFCX13C	UCFCX13D	60	2 3/8	5.7	-	-	-	-
70 2 3/4 2 3/4	8 15/32	5.9055	6 31/32	4 59/64	3/4	1 9/16	43/64	35/64	2 13/32	2.937	1.189	5/8	FC214	UC214-44	6.8	62.2 44.1	14.5	-	-	-	-	-	-	-						
	215	150	177	125.1	19	40	17	14	61.4	74.6	30.2	M16		UC214				UC214-44	UCFC214C	UCFC214D	66	2 19/32	6.8	UCFC214FC	UCFC214FD	79	3 1/8	7.7		
	8 3/4	6.4567	7 31/64	5 9/32	3/4	1 13/32	35/64	25/32	2 5/16	3.063	1.331	5/8		UCFCX14-44				UCX14-44	7.3	67.4 48.3	14.5	-	-	-	-	-	-			
	222	164	190	134.3	19	36	14	20	58.5	77.8	33.3	M16		UCFCX14				UCX14	7.3	67.4 48.3	14.5	UCFCX14C	UCFCX14D	63	2 15/32	7.3	-	-	-	-
75 2 15/16 3 2 15/16 3	8 21/32	6.2992	7 1/4	5 1/8	3/4	1 9/16	45/64	5/8	2 15/32	3.063	1.331	5/8	FC215	UC215-47	7.2	67.4 48.3	14.5	-	-	-	-	-	-	-						
	220	160	184	130.1	19	40	18	16	62.5	77.8	33.3	M16		UC215				UC215-48	UCFC215C	UCFC215D	67	2 5/8	7.2	UCFC215FC	UCFC215FD	80	3 5/32	8.2		
	8 3/4	6.4567	7 31/64	5 9/32	3/4	1 3/8	15/32	55/64	2 13/32	3.252	1.311	5/8		UCFCX15-47				UCX15-47	8.0	72.7 53.0	14.6	-	-	-	-	-	-			
	222	164	190	134.3	19	35	12	22	61.3	82.6	33.3	M16		UCFCX15				UCX15-48	8.0	72.7 53.0	14.6	UCFCX15C	UCFCX15D	66	2 19/32	8.0	-	-	-	-
80 3 1/8 - 3 1/4	9 7/16	6.6929	7 7/8	5 9/16	29/32	1 31/32	45/64	5/8	2 21/32	3.252	1.311	3/4	FC216	UC216-50	8.7	72.7 53.0	14.6	-	-	-	-	-	-	-						
	240	170	200	141.4	23	42	18	16	67.3	82.6	33.3	M20		UC216				UC216-50	UCFC216C	UCFC216D	72	2 27/32	8.7	UCFC216FC	UCFC216FD	87	3 7/16	9.9		
	10 1/4	7.3228	8 5/8	6 3/32	29/32	1 13/32	25/64	63/64	2 7/16	3.374	1.343	3/4		UCFCX16				UCX16	11.3	84.0 61.9	14.5	UCFCX16C	UCFCX16D	66	2 19/32	11.3	-	-	-	-
	260	186	219	154.8	23	36	10	25	61.6	85.7	34.1	M20		UCFCX16				UCX16	11.3	84.0 61.9	14.5	UCFCX16C	UCFCX16D	66	2 19/32	11.3	-	-	-	-
85 3 1/4 - 3 7/16	9 21/32	7.0866	8 3/16	5 51/64	29/32	1 25/32	45/64	45/64	2 3/4	3.374	1.343	3/4	FC217	UC217-52	10.3	84.0 61.9	14.5	-	-	-	-	-	-	-						
	250	180	208	147.1	23	45	18	18	69.6	85.7	34.1	M20		UC217				UC217-52	UCFC217C	UCFC217D	74	2 29/32	10.3	UCFC217FC	UCFC217FD	89	3 1/2	11.7		
	10 1/4	7.3228	8 5/8	6 3/32	29/32	1 13/32	25/64	63/64	2 5/8	3.780	1.563	3/4		UCFCX17				UCX17	12.9	96.1 71.5	14.5	UCFCX17C	UCFCX17D	71	2 25/32	12.9	-	-	-	-
	260	186	219	154.8	23	36	10	25	66.3	96	39.7	M20		UCFCX17-55				UCX17-55	12.9	96.1 71.5	14.5	-	-	-	-	-	-			
90 3 1/2 - - 3 1/2	10 7/16	7.4803	8 21/32	6 1/8	29/32	1 31/32	55/64	45/64	3 3/32	3.780	1.563	3/4	FC218	UC218-56	13.3	96.1 71.5	14.5	-	-	-	-	-	-	-						
	265	190	220	155.5	23	50	22	18	78.3	96	39.7	M20		UC218-56				UC218-56	UCFC218C	UCFC218D	83	3 9/32	13.3	UCFC218FC	UCFC218FD	98	3 27/32	14.8		
	10 1/4	7.3228	8 5/8	6 3/32	29/32	1 11/16	15/32	1 7/64	2 7/8	4.094	1.689	3/4		UCFCX18				UCX18	13.5	109 81.9	14.4	-	-	-	-	-	-			
	260	186	219	154.8	23	43	12	28	73.1	104	42.9	M20		UCFCX18				UCX18	13.5	109 81.9	14.4	-	-	-	-	-	-			
100 3 15/16 4	10 7/8	8.1102	9 3/8	6 5/8	29/32	2 19/32	55/64	1 7/64	3 9/16	4.626	1.937	3/4	FCX20	UCX20	18.2	133 105	14.4	-	-	-	-	-	-	-						
	276	206	238	168.3	23	66	22	28	90.3	117.5	49.2	M20		UCX20-63				UCX20-63	UCFCX20C	UCFCX20D	116	4 9/16	20.7	-	-	-	-			
	10 7/8	8.1102	9 3/8	6 5/8	29/32	2 19/32	55/64	1 7/64	3 9/16	4.626	1.937	3/4		UCFCX20				UCX20-63	18.2	133 105	14.4	-	-	-	-	-	-			
	276	206	238	168.3	23	66	22	28	90.3	117.5	49.2	M20		UCFCX20-64				UCX20-64	18.2	133 105	14.4	-	-	-	-	-	-			

Remarks 1. In Part No. of unit and units with covers, fitting codes follow bore diameter numbers. (See Table 10.5 in P.42.)
2. Part No. of applicable grease nipples are shown below.
A-1/4-28UNF 201-210, X05-X09
A-PT1/8 211-218, X10-X20

3. As for the triple seal type product (from 201 to 205 are the double seal type products), accessory code L3 (L2) follows the Part No. of unit or bearing. (Example of Part No. : UCFC206JL3, UC206L3)
4. For the dimensions and forms of applicable bearings, see the dimensional tables of ball bearing for unit.

Round flange cartridge type units

UCFCX-E
Cylindrical bore (with set screws)
d 25 ~ 100 mm

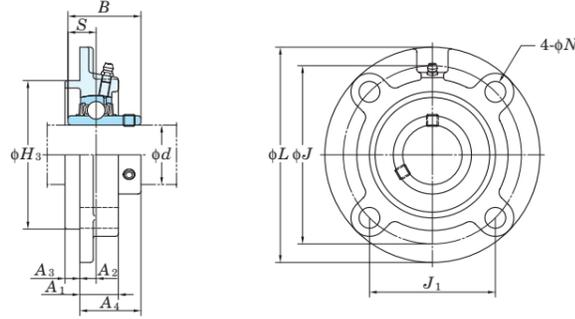

Shaft Dia. mm inch <i>d</i>	Dimensions inch mm											Bolt Size inch mm	Unit No.	Housing No.	Bearing No.	Basic Load Ratings kN		Factor <i>f</i> ₀	Mass kg
	<i>L</i>	<i>H</i> ₃	<i>J</i>	<i>J</i> ₁	<i>N</i>	<i>A</i> ₁	<i>A</i> ₂	<i>A</i> ₃	<i>A</i> ₄	<i>B</i>	<i>S</i>					<i>C</i> _r	<i>C</i> _{0r}		
25 1	4 3/8	3.000	3 5/8	2 9/16	3/8	15/16	25/64	15/64	1 9/32	1.500	0.626	5/16	UCFCX05E UCFCX05E-16	FCX05E	UCX05 UCX05-16	19.5	11.3	13.9	1.2
	111	76.2	92	65	9.5	24	10	6	32.2	38.1	15.9	M8							
30 1 3/16 1 1/4	5	3.375	4 9/16	2 59/64	15/32	7/8	5/16	3/8	1 5/16	1.689	0.689	3/8	UCFCX06E UCFCX06E-19 UCFCX06E-20	FCX06E	UCX06 UCX06-19 UCX06-20	25.7	15.4	13.9	1.5
	127	85.725	105	74.2	12	22.5	8	9.5	33.4	42.9	17.5	M10							
35 1 3/8 1 7/16	5 1/4	3.625	4 3/8	3 3/32	15/32	1 1/32	23/64	7/16	1 17/32	1.937	0.748	3/8	UCFCX07E-22 UCFCX07E UCFCX07E-23	FCX07E	UCX07 UCX07-22 UCX07-23	29.1	17.8	14.0	1.9
	133	92.075	111	78.5	12	26	9	11	39.2	49.2	19	M10							
40 1 1/2	5 1/4	3.625	4 3/8	3 3/32	15/32	1 1/32	23/64	7/16	1 17/32	1.937	0.748	3/8	UCFCX08E-24 UCFCX08E	FCX08E	UCX08-24 UCX08	34.1	21.3	14.0	2.0
	133	92.075	111	78.5	12	26	9	11	39.2	49.2	19	M10							
45 1 3/4	6 3/32	4.250	5 1/8	3 5/8	35/64	31/32	5/16	15/32	1 19/32	2.031	0.748	7/16	UCFCX09E-28 UCFCX09E	FCX09E	UCX09-28 UCX09	35.1	23.3	14.4	2.6
	155	107.95	130	91.9	14	25	8	12	40.6	51.6	19	M12							
50 1 15/16 2	6 3/8	4.5	5 23/64	3 25/32	35/64	31/32	9/32	5/8	1 19/32	2.189	0.874	7/16	UCFCX10E-31 UCFCX10E UCFCX10E-32	FCX10E	UCX10-31 UCX10 UCX10-32	43.4	29.4	14.4	3.2
	162	114.3	136	96.2	14	25	7	16	40.4	55.6	22.2	M12							
60 2 7/16	7 5/8	5.500	6 1/2	4 19/32	5/8	1 5/16	7/16	25/32	2	2.563	1.000	1/2	UCFCX12E UCFCX12E-39	FCX12E	UCX12 UCX12-39	57.2	40.1	14.4	5.3
	194	139.7	165	116.7	16	33	11	20	50.7	65.1	25.4	M14							
65 2 1/2	7 5/8	5.500	6 1/2	4 19/32	5/8	1 5/16	7/16	25/32	2 3/16	2.937	1.189	1/2	UCFCX13E-40 UCFCX13E	FCX13E	UCX13-40 UCX13	62.2	44.1	14.5	5.7
	194	139.7	165	116.7	16	33	11	20	55.4	74.6	30.2	M14							
70 2 3/4	8 3/4	6.375	7 31/64	5 9/32	3/4	1 13/32	35/64	25/32	2 5/16	3.063	1.331	5/8	UCFCX14E-44 UCFCX14E	FCX14E	UCX14-44 UCX14	67.4	48.3	14.5	7.3
	222	161.925	190	134.3	19	36	14	20	58.5	77.8	33.3	M16							
75 2 15/16 3	8 3/4	6.375	7 31/64	5 9/32	3/4	1 3/8	15/32	55/64	2 13/32	3.252	1.311	5/8	UCFCX15E-47 UCFCX15E UCFCX15E-48	FCX15E	UCX15-47 UCX15 UCX15-48	72.7	53.0	14.6	8.0
	222	161.925	190	134.3	19	35	12	22	61.3	82.6	33.3	M16							
80 -	10 1/4	7.375	8 5/8	6 3/32	29/32	1 13/32	25/64	63/64	2 7/16	3.374	1.343	3/4	UCFCX16E	FCX16E	UCX16	84.0	61.9	14.5	11.3
	260	187.325	219	154.8	23	36	10	25	61.6	85.7	34.1	M20							
85 3 7/16	10 1/4	7.375	8 5/8	6 3/32	29/32	1 13/32	25/64	63/64	2 5/8	3.780	1.563	3/4	UCFCX17E UCFCX17E-55	FCX17E	UCX17 UCX17-55	96.1	71.5	14.5	12.9
	260	187.325	219	154.8	23	36	10	25	66.3	96	39.7	M20							
90 -	10 1/4	7.375	8 5/8	6 3/32	29/32	1 11/16	15/32	1 7/64	2 7/8	4.094	1.689	3/4	UCFCX18E	FCX18E	UCX18	109	81.9	14.4	13.5
	260	187.325	219	154.8	23	43	12	28	73.1	104	42.9	M20							
100 3 15/16 4	10 7/8	8.125	9 3/8	6 5/8	29/32	2 19/32	55/64	1 7/64	3 9/16	4.626	1.937	3/4	UCFCX20E UCFCX20E-63 UCFCX20E-64	FCX20E	UCX20 UCX20-63 UCX20-64	133	105	14.4	18.2
	276	206.375	238	168.3	23	66	22	28	90.3	117.5	49.2	M20							

Remarks 1. In Part No. of unit, fitting codes follow bore diameter numbers. (See Table 10.5 in P.42.)
2. Part No. of applicable grease nipples are shown below.
A-1/4-28UNF X05-X09
A-PT1/8 X10-X20

3. As for the triple seal type product (from 201 to 205 are the double seal type products), accessory code L3 (L2) follows the Part No. of unit or bearing. (Example of Part No. : UCFCX06EL3, UCX06L3)
4. For the dimensions and forms of applicable bearings, see the dimensional tables of ball bearing for unit.

Variations of tolerance of spigot joint outside diameter (ΔH_{3s}), variations of tolerance of distance from mounting surface to center of spherical bore (ΔA_{2s}), tolerance of position of bolt hole (X), and tolerance of circumferential runout of spigot joint (Y)

Housing No.	ΔH_{3s}	ΔA_{2s}	Unit : mm	
			X	Y
FCX05E	0 -0.046	±0.5	0.7	0.2
FCX06E-FCX10E	0 -0.054			
FCX12E-FCX15E	0 -0.063	±0.8	1	0.3
FCX16E-FCX18E	0 -0.072			
FCX20E				

Variations of tolerance of bolt hole diameter (ΔN_s)

Housing No.	ΔN_s
FCX05E-FCX20E	±0.2

Round flange cartridge type units

UKFC
Tapered bore (with adapter)
 d_1 (65) ~ 90 mm

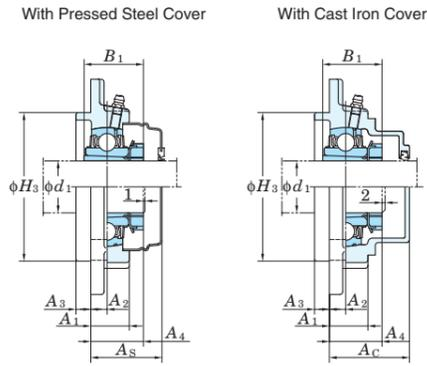
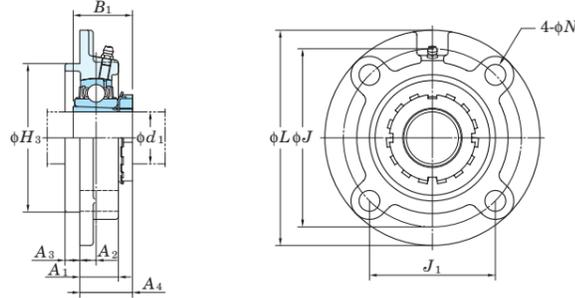

Variations of tolerance of spigot joint outside diameter (ΔH_{3s}), variations of tolerance of distance from mounting surface to center of spherical bore (ΔA_{2s}), tolerance of position of bolt hole (X), and tolerance of circumferential runout of spigot joint (Y)

Housing No.		ΔH_{3s}	ΔA_{2s}	X	Y
FC205-FC206	FCX05	0 -0.046	±0.5	0.7	0.2
FC207-FC210	FCX06-FCX10	0 -0.054			
FC211-FC217	FCX11-FCX15	0 -0.063	±0.8	1	0.3
FC218	FCX16-FCX18	0			
	FCX20	-0.072			

Variations of tolerance of bolt hole diameter (ΔN_s)

Housing No.		ΔN_s
FC204-FC218	FCX05-FCX20	±0.2

Shaft Dia. mm inch	Dimensions inch mm											Bolt Size inch mm	Standard			Adapter ¹⁾ No.	Mass kg	Basic Load Ratings kN		Factor f_0	With Pressed Steel Cover			With Cast Iron Cover				
	d_1	L	H ₃	J	J ₁	N	A ₁	A ₂	A ₃	A ₄ ¹⁾	B ₁ ¹⁾		Unit No.	Housing No.	Bearing No.			Unit No.	Dimension mm inch		Mass kg	Unit No.	Dimension mm inch	Mass kg				
65	2 1/2	8 3/4	6.4567	7 31/64	5 9/32	3/4	1 3/8	15/32	55/64	1 7/8	2 7/8	5/8	UKFCX15	FCX15	UKX15	HE2315X	7.7	72.7	53.0	14.6	-	-	-	-	-	-	-	-
		222	164	190	134.3	19	35	12	22	48	73	M16				H2315X	7.7				UKFCX15C	UKFCX15D	66	2 19/32	7.7	-	-	-
70	2 3/4	9 7/16	6.6929	7 7/8	5 9/16	29/32	1 31/32	45/64	5/8	2 7/32(2 15/32)	2 5/16(3 1/16)	3/4	UKFC216	FC216	UK216	HE316X(HE2316X)	9.0	72.7	53.0	14.6	-	-	-	-	-	-	-	-
		240	170	200	141.4	23	42	18	16	56(62.5)	59(78)	M20				H316X(H2316X)	9.0				UKFC216C	UKFC216D	72	2 27/32	9.0	UKFC216FC	UKFC216FD	87
75	3	10 1/4	7.3228	8 5/8	6 3/32	29/32	1 13/32	25/64	63/64	1 15/16	3 1/16	3/4	UKFCX16	FCX16	UKX16	HE2316X	11.4	84.0	61.9	14.5	-	-	-	-	-	-	-	-
		260	186	219	154.8	23	36	10	25	49	78	M20				H2316X	11.4				UKFCX16C	UKFCX16D	66	2 19/32	11.4	-	-	-
75	3	9 27/32	7.0866	8 3/16	5 51/64	29/32	1 25/32	45/64	45/64	2 9/32(3 17/32)	2 15/32(3 7/32)	3/4	UKFC217	FC217	UK217	H317X(H2317X)	10.4	84.0	61.9	14.5	-	-	-	-	-	-	-	-
		250	180	208	147.1	23	45	18	18	58(64.5)	63(82)	M20				HE317X(HE2317X)	10.4				UKFC217C	UKFC217D	74	2 29/32	10.4	UKFC217FC	UKFC217FD	89
80	3	10 1/4	7.3228	8 5/8	6 3/32	29/32	1 13/32	25/64	63/64	2 1/16	3 7/32	3/4	UKFCX17	FCX17	UKX17	H2317X	12.6	96.1	71.5	14.5	-	-	-	-	-	-	-	-
		260	186	219	154.8	23	36	10	25	52	82	M20				HE2317X	12.6				UKFCX17C	UKFCX17D	71	2 25/32	12.6	-	-	-
80	-	10 7/16	7.4803	8 21/32	6 1/8	29/32	1 31/32	55/64	45/64	2 17/32(2 13/16)	2 9/16(3 3/8)	3/4	UKFC218	FC218	UK218	H318X(H2318X)	13.3	96.1	71.5	14.5	-	-	-	-	-	-	-	-
		265	190	220	155.5	23	50	22	18	64(71.5)	65(86)	M20								UKFC218C	UKFC218D	83	3 9/32	13.3	UKFC218FC	UKFC218FD	98	3 27/32
90	3 1/2	10 1/4	7.3228	8 5/8	6 3/32	29/32	1 11/16	15/32	1 7/64	2 5/32	3 3/8	3/4	UKFCX18	FCX18	UKX18	H2318X	13.0	109	81.9	14.4	-	-	-	-	-	-	-	-
		260	186	219	154.8	23	43	12	28	55	86	M20								UKFCX18C	UKFCX18D	92	3 5/8	15.1	-	-	-	
90	3 1/2	10 7/8	8.1102	9 3/8	6 5/8	29/32	2 19/32	55/64	1 7/64	2 23/32	3 13/16	3/4	UKFCX20	FCX20	UKX20	HE2320X	17.1	133	105	14.4	-	-	-	-	-	-	-	-
		276	206	238	168.3	23	66	22	28	69	97	M20				H2320X	17.1				UKFCX20C	UKFCX20D	116	4 9/16	19.9	-	-	-

Note 1) Codes shown in parentheses indicate the dimensions and Part No. of applicable adapter (H2300X series) for UK200L3 series (triple seal type).

2. Part No. of applicable grease nipples are shown below.
A-1/4-28UNF 205~210, X05~X09
A-PT1/8.....211~218, X10~X20

3. In Part No. of unit with adapters and bearing with adapters, Part No. of applicable adapter follow the Part No. shown in the dimensional tables. (Example of Part No. : UKFC206J + H306X, UK206 + H306X)
4. As for the triple seal type product (205 is the double seal type product), accessory code L3 (or L2) follows the Part No. of unit or bearing. (Example of Part No. : UKFC206JL3 + H2306X, UK206L3 + H2306X)
5. For the dimensions and forms of applicable bearings and adapters, see the dimensional tables of ball bearing for unit and adapter.

Remarks 1. In Part No. of unit and units with covers, fitting codes follow bore diameter numbers. (See Table 10.5 in P.42.)

Stamped steel plate round three-bolt flange type units

SBPF
Cylindrical bore
(with set screw locking)
SAPF
Cylindrical bore
(with eccentric locking collar)
d 12 ~ 35 mm

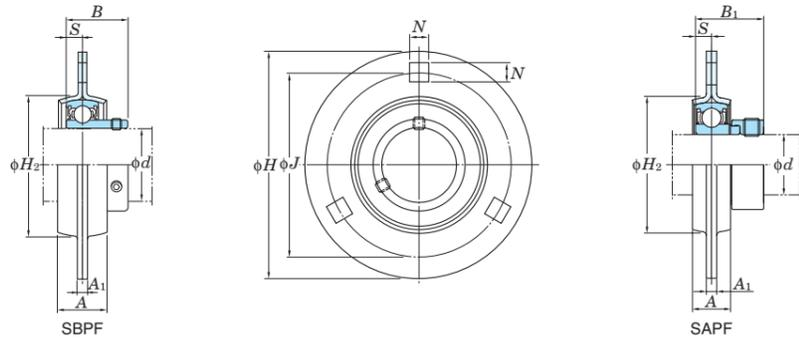

Variations of tolerance of distance between centers of bolt holes (ΔJ_b)
Unit : mm

Housing No.	ΔJ_b
PF203~PF207	±0.4

Variations of tolerance of bolt hole diameter (ΔN_b)
Unit : mm

Housing No.	ΔN_b
PF203~PF207	±0.25

Shaft Dia mm inch <i>d</i>	Dimensions inch mm								SBPF <i>B</i>	SAPF <i>B₁</i>	Bolt Size inch mm	Unit No.	Bearing No.	Unit No.	Bearing No.	Housing No.	Basic Load Ratings kN		Factor <i>f₀</i>	Mass kg	
	<i>H</i>	<i>A</i>	<i>A₁</i>	<i>J</i>	<i>N</i>	<i>H₂</i>	<i>S</i>	<i>C_r</i>									<i>C_{0r}</i>	SBPF		SAPF	
12 1/2	3 3/16	9/16	5/32	2 1/2	9/32	1 15/16	0.236	0.866	1.122	1/4	SBPF201 SBPF201-8	SB201 SB201-8	SAPF201 SAPF201-8	SA201 SA201-8	PF203	9.55	4.80	13.2	0.27	0.3	
15 5/8	81	14	4	63.5	7.1	49	6	22	28.5	M6	SBPF202 SBPF202-10	SB202 SB202-10	SAPF202 SAPF202-10	SA202 SA202-10							
17											SBPF203	SB203	SAPF203	SA203							
20 3/4	3 17/32	5/8	5/32	2 13/16	23/64	25/32	0.276	0.984	1.161	5/16	SBPF204-12 SBPF204	SB204-12 SB204	SAPF204-12 SAPF204	SA204-12 SA204	PF204	12.8	6.65	13.2	0.33	0.33	
25 7/8	3 3/4	23/32	5/32	2 63/64	23/64	2 3/8	0.295	1.063	1.201	5/16	SBPF205-14 SBPF205-15	SB205-14 SB205-15	SAPF205-14 SAPF205-15	SA205-14 SA205-15							
1	95	18	4	76	9	60	7.5	27	30.5	M8	SBPF205	SB205	SAPF205	SA205	PF205	14.0	7.85	13.9	0.38	0.42	
30 1 1/8	4 7/16	3/4	13/64	3 9/16	7/16	2 25/32	0.315	1.181	1.335	3/8	SBPF206-18 SBPF206	SB206-18 SB206	SAPF206-18 SAPF206	SA206-18 SA206							
1 1/4	113	19	5.2	90.5	11	71	8	30	33.9	M10	SBPF206-19 SBPF206-20	SB206-19 SB206-20	SAPF206-19 SAPF206-20	SA206-19 SA206-20	PF206	19.5	11.3	13.9	0.62	0.65	
35 1 1/4	4 13/16	7/8	13/64	3 15/16	7/16	3 3/16	0.335	1.260	1.437	3/8	SBPF207-20 SBPF207-22	SB207-20 SB207-22	SAPF207-20 SAPF207-21	SA207-20 SA207-21							
1 5/8	122	22	5.2	100	11	81	8.5	32	36.5	M10	SBPF207	SB207	SAPF207	SA207	PF207	25.7	15.4	13.9	0.82	0.9	
1 7/16											SBPF207-23	SB207-23	SAPF207-23	SA207-23							

Note 1) *H₂* is the minimum size of the mounting hole.

Remark For the dimensions and forms of applicable bearings, see the dimensional tables of ball bearing for unit.

Stamped steel plate oval two-bolt flange type units

SBPFL
Cylindrical bore
(with set screw locking)
SAPFL
Cylindrical bore
(with eccentric locking collar)
d 12 ~ 35 mm

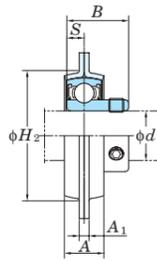

SBPFL

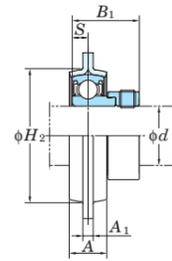
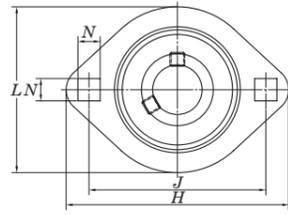

SAPFL

Variations of tolerance of distance between centers of bolt holes (ΔJ_b)
Unit : mm

Housing No.	ΔJ_b
PFL203-PFL207	±0.4

Variations of tolerance of bolt hole diameter (ΔN_b)
Unit : mm

Housing No.	ΔN_b
PFL203-PFL207	±0.25

Shaft Dia mm inch <i>d</i>	Dimensions inch mm								SBPFL <i>B</i>	SAPFL <i>B</i> ₁	Bolt Size inch mm	Unit No.	Bearing No.	Unit No.	Bearing No.	Housing No.	Basic Load Ratings kN		Factor <i>f</i> ₀	Mass kg	
	<i>H</i>	<i>L</i>	<i>A</i>	<i>A</i> ₁	<i>J</i>	<i>N</i>	<i>H</i> ₂	<i>S</i>									<i>C</i> _r	<i>C</i> _{0r}		SBPFL	SAPFL
12 1/2	3 3/16	2 5/16	9/16	5/32	2 1/2	9/32	1 15/16	0.236	0.866	1.122	1/4	SBPFL201 SBPFL201-8	SB201 SB201-8	SAPFL201 SAPFL201-8	SA201 SA201-8	PFL203	9.55	4.80	13.2	0.19	0.22
15 5/8	81	59	14	4	63.5	7.1	49	6	22	28.5	M6	SBPFL202 SBPFL202-10	SB202 SB202-10	SAPFL202 SAPFL202-10	SA202 SA202-10						
17												SBPFL203	SB203	SAPFL203	SA203						
20 3/4	3 17/32	2 5/8	5/8	5/32	2 13/16	23/64	25/32	0.276	0.984	1.161	5/16	SBPFL204-12 SBPFL204	SB204-12 SB204	SAPFL204-12 SAPFL204	SA204-12 SA204	PFL204	12.8	6.65	13.2	0.24	0.24
25 7/8	3 3/4	2 25/32	23/32	5/32	2 63/64	23/64	2 3/8	0.295	1.063	1.201	5/16	SBPFL205-14 SBPFL205-15	SB205-14 SB205-15	SAPFL205-14 SAPFL205-15	SA205-14 SA205-15	PFL205	14.0	7.85	13.9	0.28	0.32
15/16	95	71	18	4	76	9	60	7.5	27	30.5	M8	SBPFL205	SB205	SAPFL205	SA205						
1												SBPFL205-16	SB205-16	SAPFL205-16	SA205-16						
30 1 1/8	4 7/16	3 5/16	3/4	13/64	3 9/16	7/16	2 25/32	0.315	1.181	1.335	3/8	SBPFL206-18 SBPFL206	SB206-18 SB206	SAPFL206-18 SAPFL206	SA206-18 SA206	PFL206	19.5	11.3	13.9	0.38	0.41
13/16	113	84	19	5.2	90.5	11	71	8	30	33.9	M10	SBPFL206-19	SB206-19	SAPFL206-19	SA206-19						
1 1/4												SBPFL206-20	SB206-20	SAPFL206-20	SA206-20						
35 1 1/4	4 13/16	3 11/16	7/8	13/64	3 15/16	7/16	3 3/16	0.335	1.260	1.437	3/8	SBPFL207-20	SB207-20	SAPFL207-20	SA207-20	PFL207	25.7	15.4	13.9	0.66	0.74
15/16	122	94	22	5.2	100	11	81	8.5	32	36.5	M10	SBPFL207-22	SB207-22	SAPFL207-22	SA207-22						
1 3/8												SBPFL207	SB207	SAPFL207	SA207						
1 7/16												SBPFL207-23	SB207-23	SAPFL207-23	SA207-23						

Note 1) *H*₂ is the minimum size of the mounting hole.

Remark For the dimensions and forms of applicable bearings, see the dimensional tables of ball bearing for unit.

Take-up type units

UCT
Cylindrical bore (with set screws)
d 12 ~ (45) mm

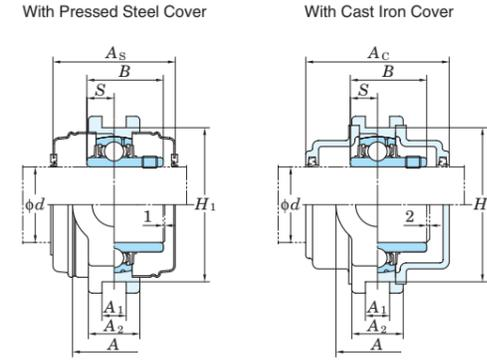
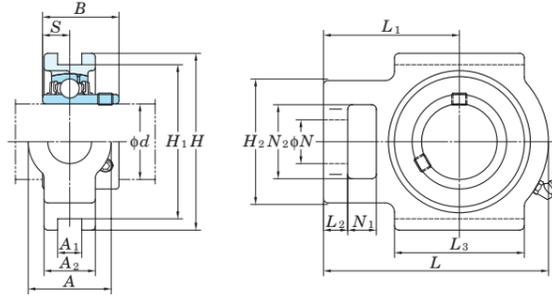

Variations of tolerance of groove width (ΔA_{1s}), variations of tolerance of distance between both grooves (ΔH_{1s}), and tolerance of symmetry of both groove sides (X)

Housing No.		ΔA_{1s}	ΔH_{1s}	X
T204-T210	TX05-TX10 T305-T310	+0.2 0	0 -0.5	0.5
T211-T217	TX11-TX17 T311-T318	+0.3 0	0 -0.8	0.6
	T319-T322			0.7
	T324-T328			0.8

Form and dimensions of L_c of T204JE3 and T205JE3 (housing with cast iron cover) are shown below.

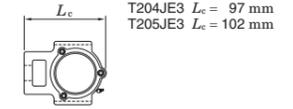

Shaft Dia. mm inch d	Dimensions inch mm															Standard		Bearing No.	Mass kg	Basic Load Ratings kN		Factor f_0	With Pressed Steel Cover			With Cast Iron Cover							
	A	A ₁	A ₂	H	H ₁	H ₂	L	L ₁	L ₂	L ₃	N	N ₁	N ₂	B	S	Unit No.	Housing No.			C _r	C _{0r}		Unit No.	Dimension mm inch	Mass kg	Unit No.	Dimension mm inch	Mass kg					
12	1 1/2															UCT201																	
15	5/8	1 1/4	15/32	13/16	3 1/2	2 63/64	2	3 11/16	2 13/32	13/32	2	3/4	5/8	1 1/4	1.220	0.500	UCT201-8	T204	12.8	6.65	13.2	UCT201C	UCT201CD	44	1 23/32	0.81							
17	3/4	32	12	21	89	76	51	94	61	10	51	19	16	32	31	12.7	UCT202					UCT202C	UCT202CD	44	1 23/32	0.79							
20																	UCT202-10					UCT203C	UCT203CD	44	1 23/32	0.78							
																	UCT203					UCT204C	UCT204CD	44	1 23/32	0.76	UCT204FC	UCT204FCD	62	2 7/16	1.1		
																	UCT204-12																
																	UCT204																
	7/8	1 1/4	15/32	15/16	3 1/2	2 63/64	2	3 13/16	2 7/16	13/32	2	3/4	5/8	1 1/4	1.343	0.563	UCT205-14	T205	14.0	7.85	13.9												
25	15/16	32	12	24	89	76	51	97	62	10	51	19	16	32	34.1	14.3	UCT205-15					UCT205C	UCT205CD	48	1 7/8	0.84	UCT205FC	UCT205FCD	66	2 19/32	1.2		
	1																UCT205																
		1 15/32	15/32	1 3/32	4 1/32	3 1/2	2 7/32	4 7/16	2 3/4	13/32	2 1/4	7/8	5/8	1 15/32	1.500	0.626	UCTX05	TX05	19.5	11.3	13.9	UCTX05C	UCTX05CD	52	2 1/16	1.4							
	1	37	12	28	102	89	56	113	70	10	57	22	16	37	38.1	15.9	UCTX05-16																
		1 13/32	15/32	1 1/32	3 1/2	3 5/32	2 7/16	4 13/16	3	15/32	2 9/16	1 1/32	5/8	1 13/32	1.496	0.591	UCT305	T305	21.2	10.9	12.6												
	1	36	12	26	89	80	62	122	76	12	65	26	16	36	38	15	UCT305-16																
	1 1/8																UCT206-18																
	1 3/16	1 15/32	15/32	1 3/32	4 1/32	3 1/2	2 7/32	4 7/16	2 3/4	13/32	2 1/4	7/8	5/8	1 15/32	1.500	0.626	UCT206	T206	19.5	11.3	13.9	UCT206C	UCT206CD	52	2 1/16	1.3	UCT206FC	UCT206FCD	70	2 3/4	1.8		
	1 1/4	37	12	28	102	89	56	113	70	10	57	22	16	37	38.1	15.9	UCT206-19																
																	UCT206-20																
	1 3/16	1 15/32	15/32	1 3/16	4 1/32	3 1/2	2 17/32	5 3/32	3 1/16	1/2	2 17/32	7/8	5/8	1 15/32	1.689	0.689	UCTX06	TX06	25.7	15.4	13.9	UCTX06C	UCTX06CD	59	2 5/16	1.7							
	1 1/4	37	12	30	102	89	64	129	78	13	64	22	16	37	42.9	17.5	UCTX06-19																
		1 5/8	5/8	1 3/32	3 15/16	3 35/64	2 3/4	5 13/32	3 11/32	9/16	2 29/32	1 3/32	23/32	1 5/8	1.693	0.669	UCT306	T306	26.7	15.0	13.3												
		41	16	28	100	90	70	137	85	14	74	28	18	41	43	17	UCT306																
	1 1/4																UCT207-20																
	1 5/16	1 15/32	15/32	1 3/16	4 1/32	3 1/2	2 17/32	5 3/32	3 1/16	1/2	2 17/32	7/8	5/8	1 15/32	1.689	0.689	UCT207-21	T207	25.7	15.4	13.9												
	1 3/8	37	12	30	102	89	64	129	78	13	64	22	16	37	42.9	17.5	UCT207-22					UCT207C	UCT207CD	59	2 5/16	1.6	UCT207FC	UCT207FCD	78	3 1/16	2.3		
																	UCT207																
	1 7/16																UCT207-23																
	1 3/8	1 15/16	5/8	1 13/32	4 1/2	4 1/64	3 9/32	5 21/32	3 15/32	19/32	3 9/32	1 5/32	3/4	1 15/16	1.937	0.748	UCTX07-22	TX07	29.1	17.8	14.0												
		49	16	36	114	102	83	144	88	15	83	29	19	49	49.2	19	UCTX07					UCTX07C	UCTX07CD	68	2 11/16	2.7							
	1 7/16																UCTX07-23																
		1 25/32	5/8	1 1/4	4 3/8	3 15/16	2 15/16	5 29/32	3 11/16	19/32	3 5/32	1 3/16	25/32	1 25/32	1.890	0.748	UCT307	T307	33.4	19.3	13.2												
		45	16	32	111	100	75	150	94	15	80	30	20	45	48	19	UCT307																
	1 1/2	1 15/16	5/8	1 5/16	4 1/2	4 1/64	3 9/32	5 21/32	3 15/32	5/8	3 9/32	1 5/32	3/4	1 15/16	1.937	0.748	UCT208-24	T208	29.1	17.8	14.0												
	1 9/16	49	16	33	114	102	83	144	88	16	83	29	19	49	49.2	19	UCT208-25					UCT208C	UCT208CD	68	2 11/16	2.5	UCT208FC	UCT208FCD	86	3 3/8	3.3		
																	UCT208																
	1 1/2	1 15/16	5/8	1 13/32	4 19/32	4 1/64	3 9/32	5 21/32	3 7/16	19/32	3 9/32	1 5/32	3/4	1 15/16	1.937	0.748	UCTX08-24	TX08	34.1	21.3	14.0												
		49	16	36	117	102	83	144	87	15	83	29	19	49	49.2	19	UCTX08					UCTX08C	UCTX08CD	68	2 11/16	2.6							
		1 31/32	45/64	1 11/32	4 7/8	4 13/32	3 9/32	6 3/8	3 15/16	21/32	3 1/2	1 1/4	7/8	1 31/32	2.047	0.748	UCT308-24	T308	40.7	24.0	13.2												
		50	18	34	124	112	83	162	100	17	89	32	22	50	52	19	UCT308																
	1 5/8																UCT209-26																
	1 11/16	1 15/16	5/8	1 3/8	4 19/32	4 1/64	3 9/32	5 21/32	3 7/16	5/8	3 9/32	1 5/32	3/4	1 15/16	1.937	0.748	UCT209-27	T209	34.1	21.3	14.0												
	1 3/4	49	16	35	117	102	83	144	87	16	83	29	19	49	49.2	19	UCT209-28																
																	UCT209					UCT209C	UCT209CD	68	2 11/16	2.4	UCT209FC	UCT209FCD	88	3 15/32	3.2		
	1 3/4	1 15/16	5/8	1 1/2	4 19/32	4 1/64	3 9/32	5 7/8	3 17/32	5/8	3 3/8	1 5/32	3/4	1 15/16	2.031	0.748	UCTX09-28	TX09	35.1	23.3	14.4												
		49	16	38	117	102	83	149	90	16	86	29	19	49	51.6	19	UCTX09					UCTX09C	UCTX09CD	73	2 7/8	2.9							

Remarks 1. In Part No. of unit and units with covers, fitting codes follow bore diameter numbers. (See Table 10.5 in P.42.)
2. Part No. of applicable grease nipples are shown below.
B-1/4-28UNF..... 201-210, X05-X09, 305-308
B-PT1/8..... 211-217, X10-X17, 309-328

3. As for the triple seal type product (from 201 to 205 are the double seal type products), accessory code L3 (L2) follows the Part No. of unit or bearing. (Example of Part No. : UCT206JL3, UC206L3)
4. As for the dimensions and forms of applicable bearings, see the dimensional tables of ball bearing for unit.

Take-up type units

UCT
Cylindrical bore (with set screws)
d (45) ~ (75) mm

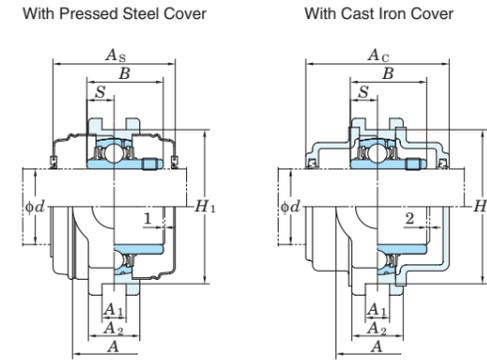
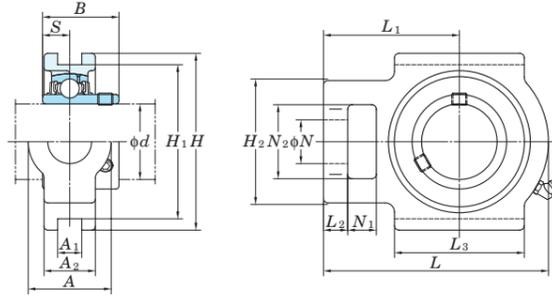

Variations of tolerance of groove width (ΔA_{1s}), variations of tolerance of distance between both grooves (ΔH_{1s}), and tolerance of symmetry of both groove sides (X)

Housing No.		ΔA_{1s}	ΔH_{1s}	X
T204-T210	TX05-TX10	+0.2 0	0 -0.5	0.5
T211-T217	TX11-TX17	+0.3 0	0 -0.8	0.6 0.7 0.8

Form and dimensions of L_c of T204JE3 and T205JE3 (housing with cast iron cover) are shown below.

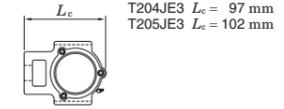

Shaft Dia. mm inch d	Dimensions inch mm																Standard		Bearing No.	Mass kg	Basic			With Pressed Steel Cover			With Cast Iron Cover		
	A	A ₁	A ₂	H	H ₁	H ₂	L	L ₁	L ₂	L ₃	N	N ₁	N ₂	B	S	Unit No.	Housing No.	Load Ratings kN C _r C _{0r}			Factor f ₀	Unit No. Open Type One Side Closed Type	Dimension mm inch A _s	Mass kg	Unit No. Open Type One Side Closed Type	Dimension mm inch A _c	Mass kg		
45 1 3/4	2 5/32	45/64	1 1/2	5 7/16	4 59/64	3 17/32	7	4 11/32	23/32	3 13/16	1 11/32	1 5/16	2 5/32	2.244	0.866	UCT309-28 UCT309	T309	48.9 29.5	13.3	- -	- -	-	-	-	-	-	-		
	55	18	38	138	125	90	178	110	18	97	34	24	55	57	22	UCT210-30 UCT210-31 UCT210 UCT210-32	T210	35.1 23.3	14.4	UCT210C UCT210CD	73 2 7/8	2.6	UCT210FC UCT210FCD	97 3 13/16	3.6				
50 1 15/16	2 17/32	55/64	1 21/32	5 3/4	5 1/8	4 1/32	6 23/32	4 3/16	3/4	3 3/4	1 3/8	3 1/32	2 17/32	2.189	0.874	UCTX10-31 UCTX10 UCTX10-32	TX10	43.4 29.4	14.4	UCTX10C UCTX10CD	75 2 15/16	4.4	- -	- -	-	-			
	64	22	42	146	130	102	171	106	19	95	35	25	64	55.6	22.2	UCT310	T310	62.0 38.3	13.2	- -	- -	-	-	-	-	-			
55 2 3/16	2 13/32	25/32	1 9/16	5 15/16	5 33/64	3 27/32	7 17/32	4 19/32	25/32	4 3/16	1 15/32	1 1/16	2 13/32	2.402	0.866	UCT211-32 UCT211-34 UCT211 UCT211-35	T211	43.4 29.4	14.4	UCT211C UCT211CD	75 2 15/16	4.0	UCT211FC UCT211FCD	99 3 29/32	5.2				
	64	22	38	146	130	102	171	106	19	95	35	25	64	55.6	22.2	UCTX11 UCTX11-35 UCTX11-36	TX11	52.4 36.2	14.4	UCTX11C UCTX11CD	88 3 15/32	5.3	- -	- -	-	-			
60 2 3/8	2 17/32	55/64	1 23/32	5 3/4	5 1/8	4 1/32	7 5/8	4 11/16	3/4	4 1/32	1 3/8	1 1/4	2 17/32	2.563	1.000	UCT311-32 UCT311 UCT311-36	T311	71.6 45.0	13.2	- -	- -	-	-	-	-	-			
	64	22	44	146	130	102	194	119	19	102	35	32	64	65.1	25.4	UCT212-36 UCT212 UCT212-38 UCT212-39	T212	52.4 36.2	14.4	UCT212C UCT212CD	88 3 15/32	4.9	UCT212FC UCT212FCD	114 4 1/2	6.4				
65 2 1/2	2 19/32	55/64	1 23/32	6 13/32	5 29/32	4 1/8	8 5/32	5 13/16	4 17/32	1 17/32	1 5/32	2 19/32	2.598	0.984	UCTX12 UCTX12-39	TX12	57.2 40.1	14.4	UCTX12C UCTX12CD	88 3 15/32	7.4	- -	- -	-	-				
	66	22	44	163	150	105	207	127	21	115	39	29	66	66	25	UCT312	T312	81.9 52.2	13.2	- -	- -	-	-	-	-	-			
70 2 7/16	2 3/4	1 1/32	1 7/8	6 9/16	5 15/16	4 3/8	8 13/16	5 13/32	13/16	4 3/4	1 5/8	1 1/4	2 3/4	2.563	1.000	UCT213-40 UCT213 UCTX13-40 UCTX13	T213	57.2 40.1	14.4	UCT213C UCT213CD	88 3 15/32	6.9	UCT213FC UCT213FCD	114 4 1/2	8.6				
	70	26	44	167	151	111	224	137	21	121	41	32	70	65.1	25.4	UCT313-40 UCT313 UCT214-44 UCT214	T214	62.2 44.1	14.5	UCT214C UCT214CD	98 3 27/32	7.0	UCT214FC UCT214FCD	124 4 7/8	8.9				
75 2 15/16	2 25/32	55/64	1 13/16	7	6 19/64	4 7/16	8 21/32	5 9/16	29/32	4 27/32	1 5/8	1 7/32	2 25/32	2.795	1.024	UCTX14-44 UCTX14 UCT314-44 UCT314	TX14	67.4 48.3	14.5	UCTX14C UCTX14CD	98 3 27/32	7.9	- -	- -	-	-			
	71	22	46	178	160	113	220	135	23	123	41	31	71	71	26	UCT215-47 UCT215 UCT215-48 UCTX15-47 UCTX15 UCTX15-48	T215	67.4 48.3	14.5	UCT215C UCT215CD	98 3 27/32	7.3	UCT215FC UCT215FCD	124 4 7/8	9.2				
75 3	2 3/4	1 1/32	1 31/32	7 15/32	6 11/16	4 9/16	9 3/8	5 3/4	31/32	5 9/32	1 11/16	1 1/4	2 3/4	2.953	1.181	UCT314-44 UCT314	T314	104 68.2	13.2	- -	- -	-	-	-	-	-			
	80	26	50	190	170	116	238	146	25	134	43	32	70	75	30	UCTX15C UCTX15CD	TX15	72.7 53.0	14.6	UCTX15C UCTX15CD	108 4 1/4	8.7	- -	- -	-	-			
75 3	2 3/4	1 1/32	1 7/8	6 9/16	5 15/16	4 3/8	9 1/8	5 1/2	13/16	4 3/4	1 5/8	1 1/4	2 3/4	3.063	1.331	UCT215-47 UCT215 UCT215-48 UCTX15-47 UCTX15 UCTX15-48	T215	67.4 48.3	14.5	UCT215C UCT215CD	98 3 27/32	7.3	UCT215FC UCT215FCD	124 4 7/8	9.2				
	70	26	48	167	151	111	232	140	21	121	41	32	70	77.8	33.3	UCTX15C UCTX15CD	TX15	72.7 53.0	14.6	UCTX15C UCTX15CD	108 4 1/4	8.7	- -	- -	-	-			
75 3	2 3/4	1 1/32	1 7/8	6 9/16	5 15/16	4 3/8	9 1/8	5 1/2	13/16	4 3/4	1 5/8	1 1/4	2 3/4	3.063	1.331	UCT215-47 UCT215 UCT215-48 UCTX15-47 UCTX15 UCTX15-48	T215	67.4 48.3	14.5	UCT215C UCT215CD	98 3 27/32	7.3	UCT215FC UCT215FCD	124 4 7/8	9.2				
	70	26	48	167	151	111	232	140	21	121	41	32	70	77.8	33.3	UCTX15C UCTX15CD	TX15	72.7 53.0	14.6	UCTX15C UCTX15CD	108 4 1/4	8.7	- -	- -	-	-			

Remarks 1. In Part No. of unit and units with covers, fitting codes follow bore diameter numbers. (See Table 10.5 in P.42.)
2. Part No. of applicable grease nipples are shown below.
B-1/4-28UNF..... 201~210, X05~X09, 305~308
B-PT1/8..... 211~217, X10~X17, 309~328

3. As for the triple seal type product (from 201 to 205 are the double seal type products), accessory code L3 (L2) follows the Part No. of unit or bearing. (Example of Part No. : UCT206JL3, UC206L3)
4. As for the dimensions and forms of applicable bearings, see the dimensional tables of ball bearing for unit.

Take-up type units

UCT
Cylindrical bore (with set screws)
d (75) ~ 140 mm

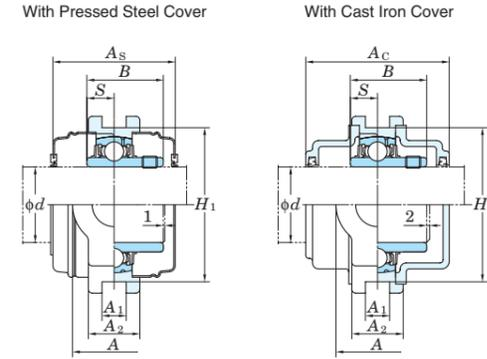
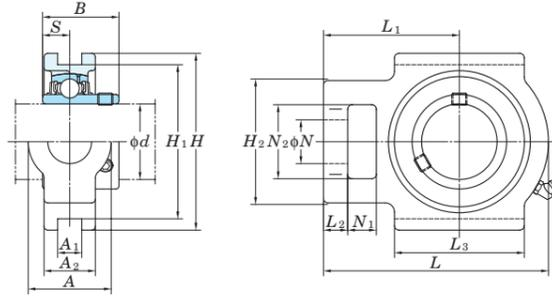

Variations of tolerance of groove width (ΔA_{1s}), variations of tolerance of distance between both grooves (ΔH_{1s}), and tolerance of symmetry of both groove sides (X)

Housing No.		ΔA_{1s}	ΔH_{1s}	X	Unit : mm
T204-T210	TX05-TX10	+0.2	0	0.5	
	T305-T310	0	-0.5		
T211-T217	TX11-TX17	+0.3	0	0.6	
	T311-T318	0	-0.8	0.7	
	T319-T322			0.8	
	T324-T328				

Form and dimensions of L_c of T204JE3 and T205JE3 (housing with cast iron cover) are shown below.

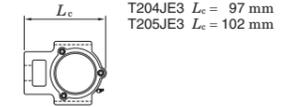

T204JE3 $L_c = 97$ mm
T205JE3 $L_c = 102$ mm

Shaft Dia. mm inch d	Dimensions inch mm															Standard		Bearing No.	Mass kg	Basic Load Ratings kN		Factor f_0	With Pressed Steel Cover			With Cast Iron Cover		
	A	A ₁	A ₂	H	H ₁	H ₂	L	L ₁	L ₂	L ₃	N	N ₁	N ₂	B	S	Unit No.	Housing No.			C _r	C _{0r}		Unit No. Open Type One Side Closed Type	Dimension mm inch A _s	Mass kg	Unit No. Open Type One Side Closed Type	Dimension mm inch A _c	Mass kg
75 2 15/16 3	3 17/32	1 1/32	2 5/32	8 1/2	7 9/16	5 3/16	10 5/16	6 5/16	3 1/32	5 29/32	1 13/16	1 13/32	3 11/32	3.228	1.260	UCT315-47 UCT315 UCT315-48	T315	UC315-47 UC315 UC315-48	13.0 13.0 13.0	113 77.2	13.2	- - -	- - -	- - -	UCT315C UCT315CD	134 5 9/32	15.5	
	2 3/4	1 1/32	2	7 1/4	6 1/2	4 3/8	9 1/4	5 1/2	13/16	4 3/4	1 5/8	1 1/4	2 3/4	3.252	1.311	UCT216-50 UCT216	T216	UC216-50 UC216	8.2 8.2	72.7 53.0	14.6	UCT216C UCT216CD	108 4 1/4	8.2	UCT216FC UCT216FCD	138 5 7/16	10.6	
80 -	2 7/8	1 7/64	2 1/8	7 25/32	6 13/16	4 7/8	10 1/4	6 3/8	1 3/32	6 3/16	1 7/8	1 1/2	2 7/8	3.374	1.343	UCTX16	TX16	UCX16	11.7	84.0 61.9	14.5	UCTX16C UCTX16CD	112 4 13/32	11.7	- -	- -	- -	
	4 1/32	1 3/16	2 3/8	9 1/16	8 1/32	5 29/32	11 3/32	6 27/32	1 3/32	6 5/16	2 3/32	1 21/32	3 27/32	3.386	1.339	UCT316	T316	UC316	16.2	123 86.7	13.3	- -	- -	- -	UCT316C UCT316CD	138 5 7/16	19.1	
85 3 1/4	2 7/8	1 3/16	2 1/8	7 25/32	6 13/16	4 7/8	10 1/4	6 3/8	1 5/32	6 3/16	1 7/8	1 1/2	2 7/8	3.374	1.343	UCT217-52 UCT217	T217	UC217-52 UC217	11.0 11.0	84.0 61.9	14.5	UCT217C UCT217CD	112 4 13/32	11.0	UCT217FC UCT217FCD	142 5 19/32	13.7	
	2 7/8	1 7/64	2 1/8	7 25/32	6 13/16	4 7/8	10 1/4	6 3/8	1 3/32	6 3/16	1 7/8	1 1/2	2 7/8	3.780	1.563	UCTX17 UCTX17-55	TX17	UCX17 UCX17-55	11.7 11.7	96.1 71.5	14.5	UCTX17C UCTX17CD	122 4 13/16	11.7	- -	- -	- -	
90 3 1/2	4 1/32	1 17/64	2 17/32	9 7/16	8 27/64	5 31/32	11 23/32	7 7/32	1 3/16	6 11/16	2 3/32	1 21/32	3 27/32	3.780	1.575	UCT317	T317	UC317	19.0	133 96.8	13.3	- -	- -	- -	UCT317C UCT317CD	146 5 3/4	22.3	
	4 11/32	1 17/64	2 19/32	10 1/32	8 31/32	6 9/16	12 9/32	7 9/16	1 3/16	6 7/8	2 1/4	1 13/16	4 3/16	3.780	1.575	UCT318-56 UCT318	T318	UC318-56 UC318	21.6 21.6	143 107	13.3	- -	- -	- -	UCT318C UCT318CD	150 5 29/32	25.4	
95 -	4 11/32	1 3/8	2 27/32	10 5/8	9 29/64	6 1/2	12 11/16	7 3/4	1 7/32	7 3/32	2 1/4	1 13/16	4 3/16	4.055	1.614	UCT319	T319	UC319	24.9	153 119	13.3	- -	- -	- -	UCT319C UCT319CD	162 6 3/8	29.2	
	4 23/32	1 3/8	2 15/16	11 13/32	10 15/64	6 7/8	13 19/32	8 9/32	1 1/4	7 7/8	2 5/16	1 7/8	4 17/32	4.252	1.654	UCT320 UCT320-63 UCT320-64	T320	UC320 UC320-63 UC320-64	30.7 30.7 30.7	173 141	13.2	- -	- -	- -	UCT320C UCT320CD	174 6 27/32	36.3	
100 3 15/16 4	4 23/32	1 3/8	2 15/16	11 13/32	10 15/64	6 7/8	13 19/32	8 9/32	1 1/4	7 7/8	2 5/16	1 7/8	4 17/32	4.409	1.732	UCT321	T321	UC321	36.7	184 153	13.2	- -	- -	- -	UCT321C UCT321CD	178 7	42.7	
	5 1/8	1 1/2	3 5/32	12 19/32	11 7/32	7 9/32	15 5/32	9 1/4	1 1/2	8 15/32	2 9/16	2 1/16	4 29/32	4.606	1.811	UCT322	T322	UC322	39.7	205 180	13.2	- -	- -	- -	UCT322C UCT322CD	188 7 13/32	46.5	
110 -	5 1/2	1 49/64	3 17/32	13 31/32	12 9/32	8 9/32	17	10 1/2	1 21/32	9 1/16	2 3/4	2 3/8	5 1/2	4.961	2.008	UCT324	T324	UC324	54.4	207 185	13.5	- -	- -	- -	UCT324C UCT324CD	196 7 23/32	63.9	
	5 29/32	1 31/32	3 15/16	15 5/32	13 25/32	8 21/32	18 5/16	11 7/32	1 25/32	9 7/16	2 15/16	2 9/16	5 29/32	5.315	2.126	UCT326	T326	UC326	69.3	229 214	13.6	- -	- -	- -	UCT326C UCT326CD	214 8 7/16	81.4	
120 -	6 3/32	1 31/32	3 15/16	16 11/32	14 51/64	9 1/16	20 9/32	12 13/32	1 31/32	10 1/32	3 3/32	2 3/4	6 3/16	5.709	2.323	UCT328	T328	UC328	85.1	253 246	13.6	- -	- -	- -	UCT328C UCT328CD	222 8 3/4	101	

Remarks 1. In Part No. of unit and units with covers, fitting codes follow bore diameter numbers. (See Table 10.5 in P.42.)
2. Part No. of applicable grease nipples are shown below.
B-1/4-28UNF..... 201-210, X05-X09, 305-308
B-PT1/8..... 211-217, X10-X17, 309-328

3. As for the triple seal type product (from 201 to 205 are the double seal type products), accessory code L3 (L2) follows the Part No. of unit or bearing. (Example of Part No. : UCT206JL3, UC206L3)
4. As for the dimensions and forms of applicable bearings, see the dimensional tables of ball bearing for unit.

Take-up type units

UCT-E
Cylindrical bore (with set screws)
d 12 ~ 50 mm

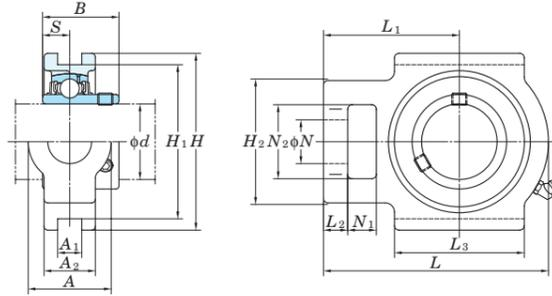

Variations of tolerance of groove width (Δ_{A1s}), variations of tolerance of distance between both grooves (Δ_{H1s}), and tolerance of symmetry of both groove sides (X)
Unit : mm

Housing No.		Δ_{A1s}	Δ_{H1s}	X
T204E-T210E	TX05E-TX10E	+0.2 0	0 -0.5	0.5
T211E-T217E	TX11E-TX17E	+0.3 0	0 -0.8	0.6

Shaft Dia. mm inch d	Dimensions inch mm															Unit No.	Housing No.	Bearing No.	Basic Load Ratings kN		Factor f_0	Mass kg
	A	A ₁	A ₂	H	H ₁	H ₂	L	L ₁	L ₂	L ₃	N	N ₁	N ₂	B	S				C _r	C _{0r}		
12 15 17 20	1/2															UCT201E UCT201E-8 UCT202E UCT202E-10 UCT203E UCT204E-12 UCT204E	T204E	UC201 UC201-8 UC202 UC202-10 UC203 UC204-12 UC204	12.8 6.65	13.2	0.81 0.79 0.78 0.76	
	5/8	1 1/4	17/32	13/16	3 1/2	3	2	3 11/16	2 13/32	13/32	2	3/4	5/8	1 1/4	1.220	0.500						
25	3/4															UCT205E-14 UCT205E-15 UCT205E UCT205E-16	T205E	UC205-14 UC205-15 UC205 UC205-16	14.0 7.85	13.9	0.84	
	7/8	1 1/4	17/32	15/16	3 1/2	3	2	3 13/16	2 7/16	13/32	2	3/4	5/8	1 1/4	1.343	0.563						
30	1															UCTX05E UCTX05E-16	TX05E	UCX05 UCX05-16	19.5 11.3	13.9	1.4	
	15/16	1 15/32	17/32	1 3/32	4 1/32	3 1/2	2 7/32	4 7/16	2 3/4	13/32	2 1/4	7/8	5/8	1 15/32	1.500	0.626						
35	1 1/8															UCT206E-18 UCT206E UCT206E-19 UCT206E-20	T206E	UC206-18 UC206 UC206-19 UC206-20	19.5 11.3	13.9	1.3	
	1 3/16	1 15/32	17/32	1 3/32	4 1/32	3 1/2	2 7/32	4 7/16	2 3/4	13/32	2 1/4	7/8	5/8	1 15/32	1.500	0.626						
40	1 1/4															UCTX06E UCTX06E-19 UCTX06E-20	TX06E	UCX06 UCX06-19 UCX06-20	25.7 15.4	13.9	1.7	
	1 3/16	1 15/32	17/32	1 3/16	4 1/32	3 1/2	2 17/32	5 3/32	3 1/16	1/2	2 17/32	7/8	5/8	1 15/32	1.689	0.689						
45	1 1/4															UCT207E-20 UCT207E-21 UCT207E-22 UCT207E UCT207E-23	T207E	UC207-20 UC207-21 UC207-22 UC207 UC207-23	25.7 15.4	13.9	1.6	
	1 5/16	1 15/32	17/32	1 3/16	4 1/32	3 1/2	2 17/32	5 3/32	3 1/16	1/2	2 17/32	7/8	5/8	1 15/32	1.689	0.689						
50	1 3/8															UCTX07E-22 UCTX07E UCTX07E-23	TX07E	UCX07-22 UCX07 UCX07-23	29.1 17.8	14.0	2.7	
	1 7/16	1 15/16	11/16	1 13/32	4 1/2	4	3 9/32	5 21/32	3 15/32	19/32	3 9/32	1 5/32	3/4	1 15/16	1.937	0.748						
55	1 1/2															UCT208E-24 UCT208E-25 UCT208E	T208E	UC208-24 UC208-25 UC208	29.1 17.8	14.0	2.5	
	1 9/16	1 15/16	11/16	1 5/16	4 1/2	4	3 9/32	5 21/32	3 15/32	19/32	3 9/32	1 5/32	3/4	1 15/16	1.937	0.748						
60	1 1/2															UCTX08E-24 UCTX08E	TX08E	UCX08-24 UCX08	34.1 21.3	14.0	2.6	
	1 7/16	1 15/16	11/16	1 13/32	4 19/32	4	3 9/32	5 21/32	3 7/16	19/32	3 9/32	1 5/32	3/4	1 15/16	1.937	0.748						
65	1 5/8															UCT209E-26 UCT209E-27 UCT209E-28 UCT209E	T209E	UC209-26 UC209-27 UC209-28 UC209	34.1 21.3	14.0	2.4	
	1 11/16	1 15/16	11/16	1 3/8	4 19/32	4	3 9/32	5 21/32	3 7/16	5/8	3 9/32	1 5/32	3/4	1 15/16	1.937	0.748						
70	1 3/4															UCTX09E-28 UCTX09E	TX09E	UCX09-28 UCX09	35.1 23.3	14.4	2.9	
	1 7/8	1 15/16	11/16	1 1/2	4 19/32	4	3 9/32	5 7/8	3 17/32	5/8	3 3/8	1 5/32	3/4	1 15/16	2.031	0.748						
75	1 7/8															UCT210E-30 UCT210E-31 UCT210E UCT210E-32	T210E	UC210-30 UC210-31 UC210 UC210-32	35.1 23.3	14.4	2.6	
	1 15/16	1 15/16	11/16	1 15/32	4 19/32	4	3 9/32	5 7/8	3 17/32	5/8	3 3/8	1 5/32	3/4	1 15/16	2.031	0.748						
80	2															UCTX10E-31 UCTX10E UCTX10E-32	TX10E	UCX10-31 UCX10	43.4 29.4	14.4	4.4	
	1 15/16	2 17/32	1 1/16	1 21/32	5 3/4	5 1/8	4 1/64	6 23/32	4 3/16	3/4	3 3/4	1 3/8	31/32	2 17/32	2.189	0.874						
85	2															UCTX10E-31 UCTX10E UCTX10E-32	TX10E	UCX10-31 UCX10	43.4 29.4	14.4	4.4	
	1 15/16	64	27	42	146	130.17	102	171	106	19	95	35	25	64	55.6	22.2						

Remarks 1. In Part No. of unit and units with covers, fitting codes follow bore diameter numbers. (See Table 10.5 in P.42.)
2. Part No. of applicable grease nipples are shown below.
B-1/4-28UNF 201~210, X05~X09, 305~308
B-PT1/8 211~217, X10~X17, 309~328

3. As for the triple seal type product (from 201 to 205 are the double seal type products), accessory code L3 (L2) follows the Part No. of unit or bearing. (Example of Part No. : UCT206EL3, UC206L3)
4. As for the dimensions and forms of applicable bearings, see the dimensional tables of ball bearing for unit.

Take-up type units

UCT-E
Cylindrical bore (with set screws)
d 55 ~ 85 mm

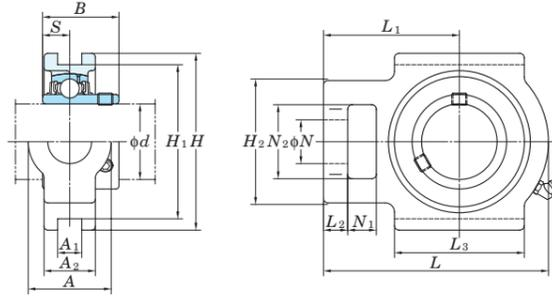

Variations of tolerance of groove width (Δ_{A1s}), variations of tolerance of distance between both grooves (Δ_{H1s}), and tolerance of symmetry of both groove sides (X)
Unit : mm

Housing No.	Δ_{A1s}	Δ_{H1s}	X
T204E-T210E	+0.2 0	0 -0.5	0.5
T211E-T217E	+0.3 0	0 -0.8	0.6

Shaft Dia. mm inch	Dimensions inch mm															Unit No.	Housing No.	Bearing No.	Basic Load Ratings kN		Factor f_0	Mass kg							
	A	A ₁	A ₂	H	H ₁	H ₂	L	L ₁	L ₂	L ₃	N	N ₁	N ₂	B	S				C _r	C _{0r}									
55 2 2 1/8 2 3/16	2 17/32	1 1/16	1 1/2	5 3/4	5 1/8	4 1/64	6 23/32	4 3/16	3/4	3 3/4	1 3/8	3 1/32	2 17/32	2.189	0.874	UCT211E-32 UCT211E-34 UCT211E UCT211E-35	T211E	UC211-32 UC211-34 UC211 UC211-35	43.4	29.4	14.4	4.0							
	64	27	38	146	130.17	102	171	106	19	95	35	25	64	55.6	22.2														
	2 3/16	1 1/16	1 23/32	5 3/4	5 1/8	4 1/64	7 5/8	4 11/16	3/4	4 1/32	1 3/8	1 1/4	2 17/32	2.563	1.000								UCTX11E UCTX11E-35 UCTX11E-36	TX11E	UCX11 UCX11-35 UCX11-36	52.4	36.2	14.4	5.3
	64	27	44	146	130.17	102	194	119	19	102	35	32	64	65.1	25.4														
60 2 1/4 2 3/8 2 7/16	2 17/32	1 1/16	1 21/32	5 3/4	5 1/8	4 1/64	7 5/8	4 11/16	3/4	4 1/32	1 3/8	1 1/4	2 17/32	2.563	1.000	UCT212E-36 UCT212E UCT212E-38 UCT212E-39	T212E	UC212-36 UC212 UC212-38 UC212-39	52.4	36.2	14.4	4.9							
	64	27	42	146	130.17	102	194	119	19	102	35	32	64	65.1	25.4														
	2 7/16	1 1/16	1 7/8	6 9/16	5 15/16	4 3/8	8 13/16	5 13/32	13/16	4 3/4	1 5/8	1 1/4	2 3/4	2.563	1.000								UCTX12E UCTX12E-39	TX12E	UCX12 UCX12-39	57.2	40.1	14.4	7.4
	70	27	48	167	150.8	111	224	137	21	121	41	32	70	65.1	25.4														
65 2 1/2 2 1/2	2 3/4	1 1/16	1 23/32	6 9/16	5 15/16	4 3/8	8 13/16	5 13/32	13/16	4 3/4	1 5/8	1 1/4	2 3/4	2.563	1.000	UCT213E-40 UCT213E UCTX13E-40 UCTX13E	T213E	UC213-40 UC213 UCX13-40 UCX13	57.2	40.1	14.4	6.9							
	70	27	44	167	150.8	111	224	137	21	121	41	32	70	65.1	25.4														
	2 1/2	1 1/16	1 7/8	6 9/16	5 15/16	4 3/8	8 13/16	5 13/32	13/16	4 3/4	1 5/8	1 1/4	2 3/4	2.937	1.189								UCT214E-44 UCT214E	TX14E	UC214-44 UC214	62.2	44.1	14.5	7.6
	70	27	48	167	150.8	111	224	137	21	121	41	32	70	74.6	30.2														
70 2 3/4 2 3/4	2 3/4	1 1/16	1 13/16	6 9/16	5 15/16	4 3/8	8 13/16	5 13/32	13/16	4 3/4	1 5/8	1 1/4	2 3/4	2.937	1.189	UCT214E-44 UCT214E	T214E	UC214-44 UC214	62.2	44.1	14.5	7.0							
	70	27	46	167	150.8	111	224	137	21	121	41	32	70	74.6	30.2														
	2 3/4	1 1/16	1 7/8	6 9/16	5 15/16	4 3/8	9 1/8	5 1/2	13/16	4 3/4	1 5/8	1 1/4	2 3/4	3.063	1.331								UCTX14E-44 UCTX14E	TX14E	UCX14-44 UCX14	67.4	48.3	14.5	7.9
	70	27	48	167	150.8	111	232	140	21	121	41	32	70	77.8	33.3														
75 2 15/16 3 2 15/16 3	2 3/4	1 1/16	1 7/8	6 9/16	5 15/16	4 3/8	9 1/8	5 1/2	13/16	4 3/4	1 5/8	1 1/4	2 3/4	3.063	1.331	UCT215E-47 UCT215E UCT215E-48	T215E	UC215-47 UC215 UC215-48	67.4	48.3	14.5	7.3							
	70	27	48	167	150.8	111	232	140	21	121	41	32	70	77.8	33.3														
	2 15/16	1 1/16	1 7/8	7 1/4	6 1/2	4 3/8	9 1/4	5 1/2	13/16	4 3/4	1 5/8	1 1/4	2 3/4	3.252	1.311								UCTX15E-47 UCTX15E UCTX15E-48	TX15E	UCX15-47 UCX15 UCX15-48	72.7	53.0	14.6	8.7
	70	27	48	184	165	111	235	140	21	121	41	32	70	82.6	33.3														
80 3 1/8 - 3 1/2	2 3/4	1 1/16	2	7 1/4	6 1/2	4 3/8	9 1/4	5 1/2	13/16	4 3/4	1 5/8	1 1/4	2 3/4	3.252	1.311	UCT216E-50 UCT216E	T216E	UC216-50 UC216	72.7	53.0	14.6	8.2							
	70	27	51	184	165	111	235	140	21	121	41	32	70	82.6	33.3														
	3 1/2	1 13/16	2 11/16	7 25/32	6 13/16	4 7/8	10 1/4	6 3/8	1 3/32	6 3/16	1 7/8	1 1/2	2 7/8	3.374	1.343								UCTX16E	TX16E	UCX16	84.0	61.9	14.5	12.4
	89	46	68	198	173	124	260	162	28	157	48	38	73	85.7	34.1														
85 3 1/4 - 3 7/16	3 1/2	1 13/16	2 11/16	7 25/32	6 13/16	4 7/8	10 1/4	6 3/8	1 3/32	6 3/16	1 7/8	1 1/2	2 7/8	3.374	1.343	UCT217E-52 UCT217E	T217E	UC217-52 UC217	84.0	61.9	14.5	12.1							
	89	46	68	198	173	124	260	162	29	157	48	38	73	85.7	34.1														
	3 1/2	1 13/16	2 11/16	7 25/32	6 13/16	4 7/8	10 1/4	6 3/8	1 3/32	6 3/16	1 7/8	1 1/2	2 7/8	3.780	1.563								UCTX17E UCTX17E-55	TX17E	UCX17 UCX17-55	96.1	71.5	14.5	13.3
	89	46	68	198	173	124	260	162	28	157	48	38	73	96	39.7														

Remarks 1. In Part No. of unit and units with covers, fitting codes follow bore diameter numbers. (See Table 10.5 in P.42.)
2. Part No. of applicable grease nipples are shown below.
B-1/4-28UNF 201~210, X05~X09, 305~308
B-PT1/8 211~217, X10~X17, 309~328

3. As for the triple seal type product (from 201 to 205 are the double seal type products), accessory code L3 (L2) follows the Part No. of unit or bearing. (Example of Part No. : UCT206EL3, UC206L3)
4. As for the dimensions and forms of applicable bearings, see the dimensional tables of ball bearing for unit.

Take-up type units

UKT
Tapered bore (with adapter)
d₁ 20 ~ (50) mm

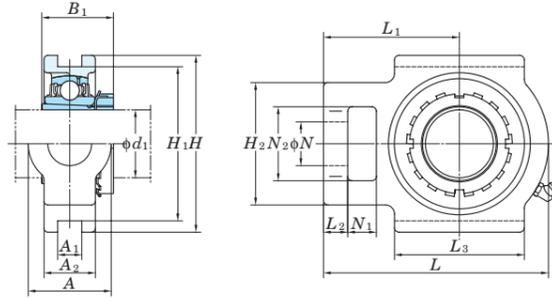

With Pressed Steel Cover

With Cast Iron Cover

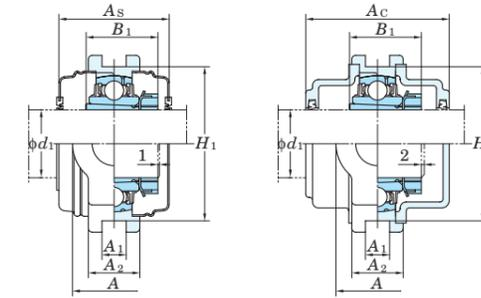

Variations of tolerance of groove width (ΔA_{1s}), variations of tolerance of distance between both grooves (ΔH_{1s}), and tolerance of symmetry of both groove sides (X)

Housing No.		ΔA_{1s}	ΔH_{1s}	X
T205-T210	TX05-TX10	+0.2 0	0 -0.5	0.5
T211-T217	TX11-TX17	+0.3 0	0 -0.8	0.6 0.7 0.8

Form and dimension of L_c of T205JE3 (housing with cast iron cover) are shown below.

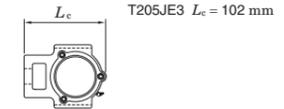

Shaft Dia. mm inch	Dimensions inch mm														Standard			Basic			Factor			With Pressed Steel Cover			With Cast Iron Cover			
	d ₁	A	A ₁	A ₂	H	H ₁	H ₂	L	L ₁	L ₂	L ₃	N	N ₁	N ₂	B ₁ ¹⁾	Unit No.	Housing No.	Bearing No.	Adapter ¹⁾ No.	Mass kg	Load Ratings kN C _r C _{0r}	f ₀	Unit No. Open Type One Side Closed Type	Dimension mm inch	Mass kg	Unit No. Open Type One Side Closed Type	Dimension mm inch	Mass kg		
20	3/4	1 1/4	15/32	15/16	3 1/2	2 63/64	2	3 13/16	2 7/16	13/32	2	3/4	5/8	1 1/4	1 5/32(1 3/8)	UKT205	T205	UK205	HE305X(HE2305X) H305X(H2305X)	0.88 0.88	14.0 7.85	13.9	UKT205C UKT205CD	48 1 7/8	0.88	UKT205FC UKT205FCD	66 2 19/32	1.3		
	3/4	1 15/32	15/32	1 3/32	4 1/32	3 1/2	2 7/32	4 7/16	2 3/4	13/32	2 1/4	7/8	5/8	1 15/32	1 3/8	UKTX05	TX05	UKX05	HE2305X H2305X	1.3 1.3	19.5 11.3	13.9	UKTX05C UKTX05CD	52 2 1/16	1.3	-	-	-		
	3/4	1 13/32	15/32	1 1/32	3 1/2	3 5/32	2 7/16	4 13/16	3	15/32	2 9/16	1 1/32	5/8	1 13/32	1 3/8	UKT305	T305	UK305	HE2305X H2305X	1.5 1.5	21.2 10.9	12.6	-	-	-	UKT305C UKT305CD	76 3	2.1	-	-
25	1	1 15/32	15/32	1 3/32	4 1/32	3 1/2	2 7/32	4 7/16	2 3/4	13/32	2 1/4	7/8	5/8	1 15/32	1 7/32(1 1/2)	UKT206	T206	UK206	H306X(H2306X) HE306X(HE2306X)	1.3 1.3	19.5 11.3	13.9	UKT206C UKT206CD	52 2 1/16	1.3	UKT206FC UKT206FCD	70 2 3/4	1.8		
	1	1 15/32	15/32	1 3/16	4 1/32	3 1/2	2 17/32	5 3/32	3 1/16	1/2	2 17/32	7/8	5/8	1 15/32	1 1/2	UKTX06	TX06	UKX06	H2306X HE2306X	1.7 1.7	25.7 15.4	13.9	UKTX06C UKTX06CD	59 2 5/16	1.7	-	-	-		
	1	1 5/8	5/8	1 3/32	3 15/16	3 35/64	2 3/4	5 13/32	3 11/32	9/16	2 29/32	1 3/32	23/32	1 5/8	1 1/2	UKT306	T306	UK306	H2306X HE2306X	1.9 1.9	26.7 15.0	13.3	-	-	-	UKT306C UKT306CD	82 3 7/32	2.5	-	-
30	1 1/8	1 15/32	15/32	1 3/16	4 1/32	3 1/2	2 17/32	5 3/32	3 1/16	1/2	2 17/32	7/8	5/8	1 15/32	1 3/8(1 11/16)	UKT207	T207	UK207	HS307X(HS2307X) H307X(H2307X)	1.7 1.7	25.7 15.4	13.9	UKT207C UKT207CD	59 2 5/16	1.7	UKT207FC UKT207FCD	78 3 1/16	2.5		
	1 1/8	1 15/16	5/8	1 13/32	4 1/2	4 1/64	3 9/32	5 21/32	3 15/32	19/32	3 9/32	3/4	1 15/16	1 11/16	UKTX07	TX07	UKX07	HS2307X H2307X	2.6 2.6	29.1 17.8	14.0	UKTX07C UKTX07CD	68 2 11/16	2.6	-	-	-			
	1 1/8	1 25/32	5/8	1 1/4	4 3/8	3 15/16	2 15/16	5 29/32	3 11/16	19/32	3 5/32	1 3/16	25/32	1 25/32	1 11/16	UKT307	T307	UK307	HS2307X H2307X	2.4 2.4	33.4 19.3	13.2	-	-	-	UKT307C UKT307CD	88 3 15/32	3.3	-	-
35	1 1/4	1 15/16	5/8	1 5/16	4 1/2	4 1/64	3 9/32	5 21/32	3 15/32	5/8	3 9/32	1 5/32	3/4	1 15/16	1 13/32(1 13/16)	UKT208	T208	UK208	HE308X(HE2308X) HS308X(HS2308X) H308X(H2308X)	2.5 2.5 2.5	29.1 17.8	14.0	UKT208C UKT208CD	68 2 11/16	2.5	UKT208FC UKT208FCD	86 3 3/8	3.4		
	1 1/4	1 15/16	5/8	1 13/32	4 19/32	4 1/64	3 9/32	5 21/32	3 7/16	19/32	3 9/32	1 5/32	3/4	1 15/16	1 13/16	UKTX08	TX08	UKX08	HE2308X HS2308X H2308X	2.6 2.6 2.6	34.1 21.3	14.0	UKTX08C UKTX08CD	68 2 11/16	2.6	-	-	-		
	1 3/8	1 31/32	45/64	1 11/32	4 7/8	4 13/32	3 9/32	6 3/8	3 15/16	21/32	3 1/2	1 1/4	7/8	1 31/32	1 13/16	UKT308	T308	UK308	HE2308X HS2308X H2308X	3.0 3.0 3.0	40.7 24.0	13.2	UKT308C UKT308CD	96 3 25/32	4.0	-	-	-		
40	1 1/2	1 15/16	5/8	1 3/8	4 19/32	4 1/64	3 9/32	5 21/32	3 7/16	5/8	3 9/32	1 5/32	3/4	1 15/16	1 17/32(1 31/32)	UKT209	T209	UK209	HE309X(HE2309X) H309X(H2309X) HS309X(HS2309X)	2.5 2.5 2.5	34.1 21.3	14.0	UKT209C UKT209CD	68 2 11/16	2.5	UKT209FC UKT209FCD	88 3 15/32	3.4		
	1 1/2	1 15/16	5/8	1 1/2	4 19/32	4 1/64	3 9/32	5 7/8	3 17/32	5/8	3 3/8	1 5/32	3/4	1 15/16	1 31/32	UKTX09	TX09	UKX09	HE2309X H2309X HS2309X	2.9 2.9 2.9	35.1 23.3	14.4	UKTX09C UKTX09CD	73 2 7/8	2.9	-	-	-		
	1 5/8	2 5/32	45/64	1 1/2	5 7/16	4 59/64	3 17/32	7	4 11/32	23/32	3 13/16	1 11/32	15/16	2 5/32	1 31/32	UKT309	T309	UK309	HE2309X H2309X HS2309X	4.2 4.2 4.2	48.9 29.5	13.3	UKT309C UKT309CD	102 4 1/32	5.5	-	-	-		
45	1 3/4	1 15/16	5/8	1 15/32	4 19/32	4 1/64	3 9/32	5 7/8	3 17/32	5/8	3 3/8	1 5/32	3/4	1 15/16	1 21/32(2 5/32)	UKT210	T210	UK210	HE310X(HE2310X) H310X(H2310X)	2.7 2.7	35.1 23.3	14.4	UKT210C UKT210CD	73 2 7/8	2.7	UKT210FC UKT210FCD	97 3 13/16	3.8		
	1 3/4	2 17/32	55/64	1 21/32	5 3/4	5 1/8	4 1/32	6 23/32	4 3/16	3/4	3 3/4	1 3/8	31/32	2 17/32	2 5/32	UKTX10	TX10	UKX10	HE2310X H2310X	4.4 4.4	43.4 29.4	14.4	UKTX10C UKTX10CD	75 2 15/16	4.4	-	-	-		
	1 3/4	2 13/32	25/32	1 9/16	5 15/16	5 33/64	3 27/32	7 17/32	4 19/32	25/32	4 3/16	1 15/32	1 1/16	2 13/32	2 5/32	UKT310	T310	UK310	HE2310X H2310X	5.0 5.0	62.0 38.3	13.2	UKT310C UKT310CD	110 4 11/32	6.7	-	-	-		
50	1 7/8	2 17/32	55/64	1 1/2	5 3/4	5 1/8	4 1/32	6 23/32	4 3/16	3/4	3 3/4	1 3/8	31/32	2 17/32	1 25/32(2 5/16)	UKT211	T211	UK211	HS311X(HS2311X) H311X(H2311X)	4.1 4.1	43.4 29.4	14.4	UKT211C UKT211CD	75 2 15/16	4.1	UKT211FC UKT211FCD	99 3 29/32	5.4		
	2	64	22	38	146	130	102	171	106	19	95	35	25	64	45(59)	-	-	-	-	-	-	-	-	-	-	-	-	-		

Note 1) Codes shown in parentheses indicate the dimensions and Part No. of applicable adapter (H2300X series) for UK200L3 series (triple seal type).

Remarks 1. In Part No. of unit and units with covers, fitting codes follow bore diameter numbers. (See Table 10.5 in P.42.)

2. Part No. of applicable grease nipples are shown below.
B-1/4-28UNF.....205-210, X05-X09, 305-308
B-PT1/8.....211-217, X10-X17, 309-328

3. In Part No. of unit with adapters and bearing with adapters, Part No. of applicable adapter follow the Part No. shown in the dimensional tables. (Example of Part No. : UKT206J + H306X, UK206 + H306X)
4. As for the triple seal type product (205 is the double seal type product), accessory code L3 (or L2) follows the Part No. of unit or bearing. (Example of Part No. : UKT206JL3 + H2306X, UK206L3 + H2306X)
5. For the dimensions and forms of applicable bearings and adapters, see the dimensional tables of ball bearing for unit and adapter.

UKT
Tapered bore (with adapter)
 d_1 (50) ~ 100 mm

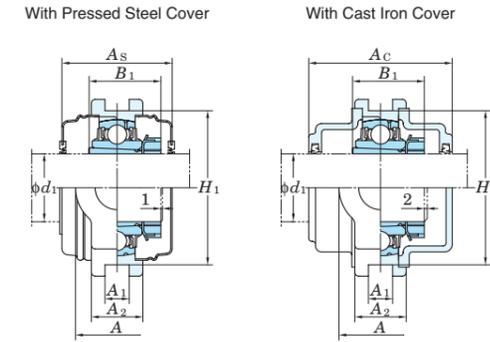
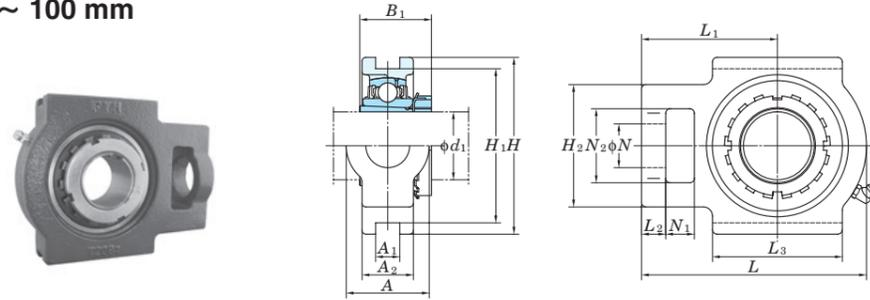

Variations of tolerance of groove width (ΔA_{1s}), variations of tolerance of distance between both grooves (ΔH_{1s}), and tolerance of symmetry of both groove sides (X)

Housing No.		ΔA_{1s}	ΔH_{1s}	X
T205-T210	TX05-TX10	+0.2 0	0 -0.5	0.5
T211-T217	TX11-TX17	+0.3 0	0 -0.8	0.6 0.7 0.8

Form and dimension of L_c of T205JE3 (housing with cast iron cover) are shown below.

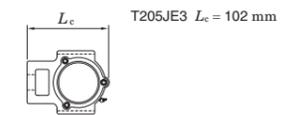

Shaft Dia. mm inch	Dimensions inch mm														Standard			Adapter ¹⁾ No.	Mass kg	Basic Load Ratings kN		Factor f_0	With Pressed Steel Cover			With Cast Iron Cover												
	d_1	A	A ₁	A ₂	H	H ₁	H ₂	L	L ₁	L ₂	L ₃	N	N ₁	N ₂	B ₁ ¹⁾	Unit No.	Housing No.			Bearing No.	Cr		C _{0r}	Unit No. Open Type One Side Closed Type	Dimension mm inch	Mass kg	Unit No. Open Type One Side Closed Type	Dimension mm inch	Mass kg									
50 1 7/8 2	2 17/32	55/64	1 23/32	5 3/4	5 1/8	4 1/32	7 5/8	4 11/16	3/4	4 1/32	1 3/8	1 1/4	2 17/32	2 5/16	UKTX11	TX11	UKX11	5.1	52.4	36.2	14.4	-	-	-	-	-	-	-	-	-								
	64	22	44	146	130	102	194	119	19	102	35	32	64	59								H2311X	5.1	UKTX11C	UKTX11CD	88	3 15/32	5.1	-	-	-	-	-					
	2 19/32	55/64	1 23/32	6 13/32	5 29/32	4 1/8	8 5/32	5	13/16	4 17/32	1 17/32	1 5/32	2 19/32	2 5/16								HS2311X	6.4	-	-	-	-	-	-	-	-	-	-	-	-	-	-	
55 2 1/8 2 1/8	2 19/32	55/64	1 23/32	6 13/32	5 29/32	4 1/8	8 5/32	5	13/16	4 17/32	1 17/32	1 5/32	2 19/32	2 5/16	UKTX12	TX12	UKX12	7.3	57.2	40.1	14.4	-	-	-	-	-	-	-	-	-								
	70	26	48	167	151	111	224	137	21	121	41	32	70	62								H312X(H2312X)	4.8	UKTX12C	UKTX12CD	88	3 15/32	7.3	UKT212C	UKT212CD	88	3 15/32	4.8	UKT212FC	UKT212FCD	114	4 1/2	6.3
	2 25/32	55/64	1 13/16	7	6 19/64	4 7/16	8 21/32	5 5/16	29/32	4 27/32	1 5/8	1 7/32	2 25/32	2 7/16								HS2312X	7.5	-	-	-	-	-	-	-	-	-	-	-	-	-	-	
60 2 3/8 2 3/8	2 3/4	1 1/32	1 23/32	6 9/16	5 15/16	4 3/8	8 13/16	5 13/32	13/16	4 3/4	1 5/8	1 1/4	2 3/4	2 9/16	UKTX13	TX13	UKX13	7.2	62.2	44.1	14.5	-	-	-	-	-	-	-	-	-								
	70	26	48	167	151	111	224	137	21	121	41	32	70	65								HE2313X	7.2	UKTX13C	UKTX13CD	98	3 27/32	7.2	-	-	-	-	-	-	-	-	-	
	2 3/4	1 1/32	1 31/32	7 15/32	6 11/16	4 9/16	9 3/8	5 3/4	31/32	5 9/32	1 11/16	1 1/4	2 3/4	2 9/16								HE2313X	9.4	-	-	-	-	-	-	-	-	-	-	-	-	-	-	
65 2 1/2 2 1/2	2 3/4	1 1/32	1 13/16	6 9/16	5 15/16	4 3/8	8 13/16	5 13/32	13/16	4 3/4	1 5/8	1 1/4	2 3/4	2 5/32(2 7/8)	UKTX15	TX15	UKX15	8.4	72.7	53.0	14.6	-	-	-	-	-	-	-	-	-								
	70	28	48	184	165	111	235	140	21	121	41	32	70	73								H2315X	8.4	UKTX15C	UKTX15CD	108	4 1/4	8.4	UKT215C	UKT215CD	98	3 27/32	7.4	UKT215FC	UKT215FCD	124	4 7/8	9.4
	3 17/32	1 1/32	2 5/32	8 1/2	7 9/16	5 3/16	10 5/16	6 5/16	31/32	5 29/32	1 13/16	1 13/32	3 11/32	2 7/8								HE2315X	13.1	-	-	-	-	-	-	-	-	-	-	-	-	-	-	
70 2 3/4 2 3/4	2 3/4	1 1/32	2	7 1/4	6 1/2	4 3/8	9 1/4	5 1/2	13/16	4 3/4	1 5/8	1 1/4	2 3/4	2 5/16(3 1/16)	UKTX16	TX16	UKX16	8.5	72.7	53.0	14.6	-	-	-	-	-	-	-	-	-								
	73	28	54	198	173	124	260	162	28	157	48	38	73	78								H316X(H2316X)	8.5	UKTX16C	UKTX16CD	112	4 13/32	11.8	UKT216C	UKT216CD	108	4 1/4	8.5	UKT216FC	UKT216FCD	138	5 7/16	11.0
	4 1/32	1 3/16	2 3/8	9 1/16	8 1/32	5 29/32	11 3/32	6 27/32	1 3/32	6 9/16	2 3/32	1 21/32	3 27/32	3 1/16								HE2316X	16.3	-	-	-	-	-	-	-	-	-	-	-	-	-	-	
75 3 3	2 7/8	1 3/16	2 1/8	7 29/32	6 13/16	4 7/8	10 1/4	6 3/8	1 5/32	6 3/16	1 7/8	1 1/2	2 7/8	2 15/32(3 7/32)	UKTX17	TX17	UKX17	11.2	84.0	61.9	14.5	-	-	-	-	-	-	-	-	-								
	73	30	54	198	173	124	260	162	29	157	48	38	73	82								H317X(H2317X)	11.2	UKTX17C	UKTX17CD	122	4 13/16	11.4	UKT217C	UKT217CD	112	4 13/32	11.2	UKT217FC	UKT217FCD	142	5 19/32	14.0
	4 1/32	1 17/64	2 17/32	9 7/16	8 27/64	5 31/32	11 23/32	7 7/32	1 3/16	6 11/16	2 3/32	1 21/32	3 27/32	3 1/32								H2317X	11.4	-	-	-	-	-	-	-	-	-	-	-	-	-	-	
80 - -	4 11/32	1 17/64	2 19/32	10 1/32	8 31/32	6 5/16	12 9/32	7 9/16	1 3/16	6 7/8	2 1/4	1 13/16	4 3/16	3 3/8	UKTX18	TX18	UKX18	21.7	143	107	13.3	-	-	-	-	-	-	-	-	-								
	110	32	66	255	228	160	312	192	30	175	57	46	106	86								H2318X	21.7	-	-	-	-	-	-	-	-	-	-	-	-	-		
	4 11/32	1 3/8	2 27/32	10 5/8	9 29/64	6 1/2	12 11/16	7 3/4	1 7/32	7 3/32	2 1/4	1 13/16	4 3/16	3 17/32								HE2318X	25.2	-	-	-	-	-	-	-	-	-	-	-	-	-	-	
85 3 1/4 -	4 11/32	1 3/8	2 27/32	10 5/8	9 29/64	6 1/2	12 11/16	7 3/4	1 7/32	7 3/32	2 1/4	1 13/16	4 3/16	3 17/32	UKTX19	TX19	UKX19	25.2	153	119	13.3	-	-	-	-	-	-	-	-	-								
	110	35	72	270	240	165	322	197	31	180	57	46	106	90								H2319X	25.2	-	-	-	-	-	-	-	-	-	-	-	-	-		
	4 23/32	1 3/8	2 15/16	11 13/32	10 15/64	6 7/8	13 19/32	8 9/32	1 1/4	7 7/8	2 5/16	1 7/8	4 17/32	3 13/16								HE2320X	30.4	-	-	-	-	-	-	-	-	-	-	-	-	-	-	
90 -	120	35	75	290	260	175	345	210	32	200	59	48	115	97	UKTX20	TX20	UKX20	30.4	173	141	13.2	-	-	-	-	-	-	-	-	-								
	5 1/8	1 1/2	3 5/32	12 19/32	11 7/32	7 9/32	15 5/32	9 1/4	1 1/2	8 15/32	2 9/16	2 1/16	4 29/32	4 1/8								H2320X	39.5	-	-	-	-	-	-	-	-	-	-	-	-	-		
	130	38	80	320	285	185	385	235	38	215	65	52	125	105								HE2322X	39.5	-	-	-	-	-	-	-	-	-	-	-	-	-	-	
100 4 -	130	38	80	320	285	185	385	235	38	215	65	52	125	105	UKTX22	TX22	UKX22	205	180	13.2	-	-	-	-	-	-	-	-	-									
	130	38	80	320	285	185	385	235	38	215	65	52	125	105							H2322X	39.5	-	-	-	-	-	-	-	-	-	-	-	-	-			
	130	38	80	320	285	185	385	235	38	215	65	52	125	105							HE2322X	39.5	-	-	-	-	-	-	-	-	-	-	-	-	-	-		

Note 1) Codes shown in parentheses indicate the dimensions and Part No. of applicable adapter (H2300X series) for UK200L3 series (triple seal type).
Remarks 1. In Part No. of unit and units with covers, fitting codes follow bore diameter numbers. (See Table 10.5 in P.42.)

2. Part No. of applicable grease nipples are shown below.
B-1/4-28UNF.....205-210, X05-X09, 305-308
B-PT1/8.....211-217, X10-X17, 309-328

3. In Part No. of unit with adapters and bearing with adapters, Part No. of applicable adapter follow the Part No. shown in the dimensional tables. (Example of Part No. : UKT206J + H306X, UK206 + H306X)
4. As for the triple seal type product (205 is the double seal type product), accessory code L3 (or L2) follows the Part No. of unit or bearing. (Example of Part No. : UKT206JL3 + H2306X, UK206L3 + H2306X)
5. For the dimensions and forms of applicable bearings and adapters, see the dimensional tables of ball bearing for unit and adapter.

Take-up type units

UKT
Tapered bore (with adapter)
 d_1 110 ~ 125 mm

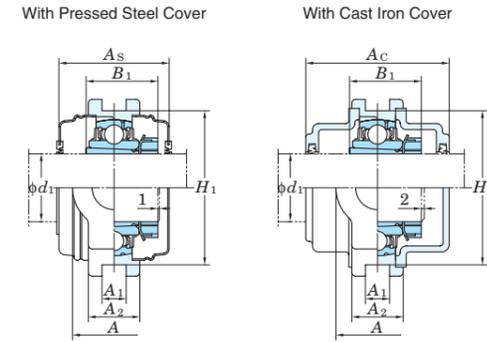
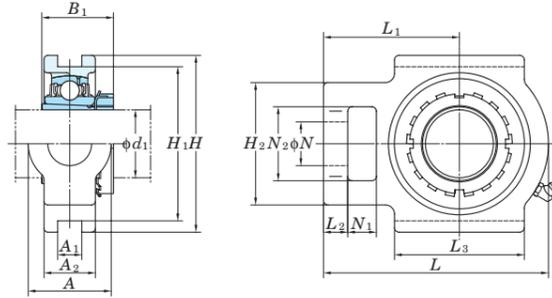

Variations of tolerance of groove width (ΔA_{1s}), variations of tolerance of distance between both grooves (ΔH_{1s}), and tolerance of symmetry of both groove sides (X)

Housing No.		ΔA_{1s}	ΔH_{1s}	X	Unit : mm
T205-T210	TX05-TX10 T305-T310	+0.2 0	0 -0.5	0.5	
T211-T217	TX11-TX17 T311-T318	+0.3 0	0 -0.8	0.6 0.7	
	T319-T322 T324-T328			0.8	

Form and dimension of L_c of T205JE3 (housing with cast iron cover) are shown below.

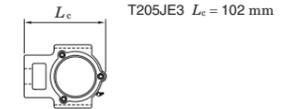

Shaft Dia. mm inch	Dimensions inch mm														Standard			Adapter ¹⁾ No.	Mass kg	Basic Load Ratings kN		Factor f_0	With Pressed Steel Cover			With Cast Iron Cover							
	d_1	A	A ₁	A ₂	H	H ₁	H ₂	L	L ₁	L ₂	L ₃	N	N ₁	N ₂	B ₁ ¹⁾	Unit No.	Housing No.			Bearing No.	Open Type		One Side Closed Type	Dimension mm inch	Mass kg	Open Type	One Side Closed Type	Dimension mm inch	Mass kg				
110	—	5 1/2 140	1 49/64 45	3 17/32 90	13 31/32 355	12 9/32 320	8 9/32 210	17 432	10 1/2 267	1 21/32 42	9 1/16 230	2 3/4 70	2 3/8 60	5 1/2 140	4 13/32 112	UKT324	T324	UK324	H2324	54.7	207	185	13.5	—	—	—	—	—	UKT324C	UKT324CD	196	7 23/32	65.0
115	4 1/2	5 29/32 150	1 31/32 50	3 15/16 100	15 5/32 385	13 25/32 350	8 21/32 220	18 5/16 465	11 7/32 285	1 25/32 45	9 7/16 240	2 15/16 75	2 9/16 65	5 29/32 150	4 3/4 121	UKT326	T326	UK326	HE2326 H2326	69.1 69.1	229	214	13.6	—	—	—	—	—	UKT326C	UKT326CD	214	8 7/16	82.4
125	—	6 3/32 155	1 31/32 50	3 15/16 100	16 11/32 415	14 61/64 380	9 1/16 230	20 9/32 515	12 13/32 315	1 31/32 50	10 1/32 255	3 5/32 80	2 3/4 70	6 5/16 160	5 5/32 131	UKT328	T328	UK328	H2328	85.1	253	246	13.6	—	—	—	—	—	UKT328C	UKT328CD	222	8 3/4	102

Note 1) Codes shown in parentheses indicate the dimensions and Part No. of applicable adapter (H2300X series) for UK200L3 series (triple seal type).

2. Part No. of applicable grease nipples are shown below.
B-1/4-28UNF.....205-210, X05-X09, 305-308
B-PT1/8.....211-217, X10-X17, 309-328

3. In Part No. of unit with adapters and bearing with adapters, Part No. of applicable adapter follow the Part No. shown in the dimensional tables. (Example of Part No. : UKT206J + H306X, UK206 + H306X)
4. As for the triple seal type product (205 is the double seal type product), accessory code L3 (or L2) follows the Part No. of unit or bearing. (Example of Part No. : UKT206JL3 + H2306X, UK206L3 + H2306X)
5. For the dimensions and forms of applicable bearings and adapters, see the dimensional tables of ball bearing for unit and adapter.

Remarks 1. In Part No. of unit and units with covers, fitting codes follow bore diameter numbers. (See Table 10.5 in P.42.)

UCST-H1S6
Cylindrical bore (with set screws)
 d 20 ~ 50 mm

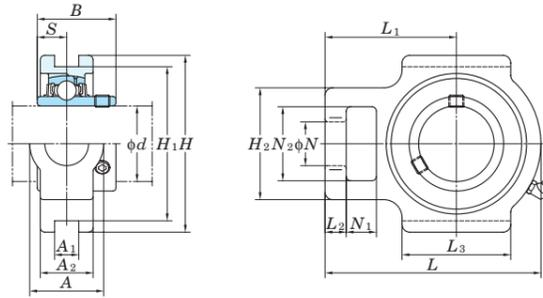

With Pressed Stainless Steel Cover

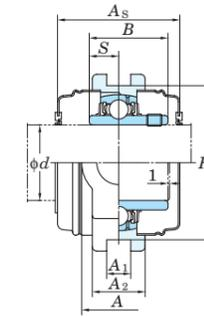

Variations of tolerance of groove width (Δ_{A1s}), variations of tolerance of distance between both grooves (Δ_{H1s}), and tolerance of symmetry of both groove sides (X)

Housing No.	Unit : mm		
	Δ_{A1s}	Δ_{H1s}	X
ST204H1-ST210H1	+0.2 0	0 -0.5	0.5

Shaft Dia. mm d	Dimensions															Standard Unit No.	Housing No.	Bearing No.	Mass kg	Basic Load Ratings kN		Factor f_0	With Pressed Stainless Steel Cover				
	inch mm																			Open Type	One Side Closed Type		Dimension mm inch	Mass kg			
	A	A ₁	A ₂	H	H ₁	H ₂	L	L ₁	L ₂	L ₃	N	N ₁	N ₂	B	S				C_r	C_{0r}				A _s			
20	1 1/4	15/32	29/32	3 1/2	2 63/64	1 13/16	3 1/2	2 5/16	1 1/32	1 23/32	3/4	23/32	1 1/4	1.220	0.500	UCST204H1S6	ST204H1	UC204S6	0.73	10.9	5.35	13.2	UCST204H1CS6	UCST204H1CDS6	45	1 25/32	0.73
	32	12	23	89	76	46	89	59	9	44	19	18	32	31	12.7												
25	1 1/4	15/32	31/32	3 1/2	2 63/64	1 13/16	3 21/32	2 3/8	1 1/32	1 23/32	3/4	23/32	1 1/4	1.343	0.563	UCST205H1S6	ST205H1	UC205S6	0.79	11.9	6.3	13.9	UCST205H1CS6	UCST205H1CDS6	49	1 15/16	0.79
	32	12	25	89	76	46	93	60	9	44	19	18	32	34.1	14.3												
30	1 15/32	15/32	1 1/16	4 1/32	3 1/2	2 1/16	4 3/16	2 5/8	1 1/32	1 31/32	7/8	23/32	1 15/32	1.500	0.626	UCST206H1S6	ST206H1	UC206S6	1.1	16.5	9.05	13.9	UCST206H1CS6	UCST206H1CDS6	53	2 3/32	1.1
	37	12	27	102	89	52	106	67	9	50	22	18	37	38.1	15.9												
35	1 15/32	15/32	1 7/32	4 1/32	3 1/2	2 7/32	4 11/16	2 15/16	7/16	2 7/32	7/8	23/32	1 15/32	1.689	0.689	UCST207H1S6	ST207H1	UC207S6	1.5	21.8	12.3	13.9	UCST207H1CS6	UCST207H1CDS6	60	2 3/8	1.5
	37	12	31	102	89	56	119	75	11	56	22	18	37	42.9	17.5												
40	1 15/16	5/8	1 1/4	4 1/2	4 1/64	2 29/32	5 5/16	3 11/32	9/16	2 17/32	1 5/32	25/32	1 15/16	1.937	0.748	UCST208H1S6	ST208H1	UC208S6	2	24.8	14.3	14.0	UCST208H1CS6	UCST208H1CDS6	69	2 23/32	2
	49	16	32	114	102	74	135	85	14	64	29	20	49	49.2	19												
45	1 15/16	5/8	1 11/32	4 19/32	4 1/64	2 29/32	5 13/32	3 11/32	9/16	2 19/32	1 5/32	25/32	1 15/16	1.937	0.748	UCST209H1S6	ST209H1	UC209S6	2.1	27.8	16.2	14.0	UCST209H1CS6	UCST209H1CDS6	69	2 23/32	2.1
	49	16	34	117	102	74	137	85	14	66	29	20	49	49.2	19												
50	1 15/16	5/8	1 3/8	4 19/32	4 1/64	2 29/32	5 5/8	3 7/16	9/16	2 27/32	1 5/32	25/32	1 15/16	2.031	0.748	UCST210H1S6	ST210H1	UC210S6	2.3	29.8	18.6	14.4	UCST210H1CS6	UCST210H1CDS6	74	2 29/32	2.3
	49	16	35	117	102	74	143	87	14	72	29	20	49	51.6	19												

Remarks 1. In Part No. of unit and units with covers, fitting codes follow bore diameter codes. (See Table 10.5 in P.42.)
 2. Part No. of the applicable grease nipple is A-1/4-28UNFN12.
 3. For the dimensions and forms of applicable bearings, see the dimensional tables of ball bearing for unit.

UCTL
Cylindrical bore (with set screws)
 d 20 ~ 45 mm

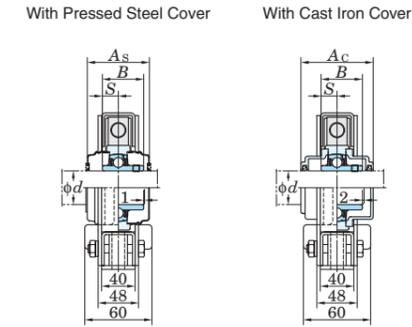
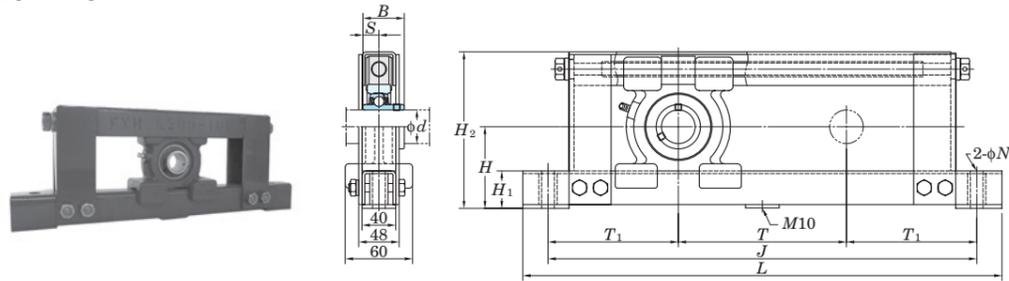

Variations of tolerance of distance from mounting bottom to center of spherical bore (ΔH_s) and variations of tolerance of distance between centers of bolt holes (ΔJ_s)

Nominal unit code	Unit : mm	
	ΔH_s	ΔJ_s
UCTL204-207	±2	±0.5
UCTL208, 209		±0.8

Shaft Dia. mm d	Dimensions mm											Bolt Size mm	Standard			Basic			Factor f_0	With Pressed Steel Cover				With Cast Iron Cover			
	H	H_1	H_2	L	J	N	T	T_1	B	S	Unit No.		Bearing No.	Mass kg	Load Ratings kN		Unit No.	Dimension mm		Mass kg	Unit No.		Dimension mm	Mass kg			
	C_r	C_{or}	Open Type	One Side Closed Type	Open Type	One Side Closed Type	A_s	A_c																			
20	77	44	146	430	370	15	100	135	31	12.7	M12	UC204	6.0	12.8	6.65	13.2	UCTL204C-100	UCTL204CD-100	44	6.0	UCTL204FC-100	UCTL204FCD-100	62	6.5			
	77	44	146	530	470	15	200	135	31	12.7	M12	UC204	7.0	12.8	6.65	13.2	UCTL204C-200	UCTL204CD-200	44	7.0	UCTL204FC-200	UCTL204FCD-200	62	7.5			
	77	44	146	630	570	15	300	135	31	12.7	M12	UC204	7.5	12.8	6.65	13.2	UCTL204C-300	UCTL204CD-300	44	7.5	UCTL204FC-300	UCTL204FCD-300	62	8.0			
	77	44	146	730	670	15	400	135	31	12.7	M12	UC204	8.0	12.8	6.65	13.2	UCTL204C-400	UCTL204CD-400	44	8.0	UCTL204FC-400	UCTL204FCD-400	62	8.5			
25	82	44	156	440	380	15	100	140	34.1	14.3	M12	UC205	7.0	14.0	7.85	13.9	UCTL205C-100	UCTL205CD-100	48	7.0	UCTL205FC-100	UCTL205FCD-100	66	7.5			
	82	44	156	540	480	15	200	140	34.1	14.3	M12	UC205	7.5	14.0	7.85	13.9	UCTL205C-200	UCTL205CD-200	48	7.5	UCTL205FC-200	UCTL205FCD-200	66	8.0			
	82	44	156	640	580	15	300	140	34.1	14.3	M12	UC205	8.0	14.0	7.85	13.9	UCTL205C-300	UCTL205CD-300	48	8.0	UCTL205FC-300	UCTL205FCD-300	66	8.5			
	82	44	156	740	680	15	400	140	34.1	14.3	M12	UC205	9.0	14.0	7.85	13.9	UCTL205C-400	UCTL205CD-400	48	9.0	UCTL205FC-400	UCTL205FCD-400	66	9.5			
30	87	44	166	450	390	15	100	145	38.1	15.9	M12	UC206	7.0	19.5	11.3	13.9	UCTL206C-100	UCTL206CD-100	52	7.0	UCTL206FC-100	UCTL206FCD-100	70	7.5			
	87	44	166	550	490	15	200	145	38.1	15.9	M12	UC206	8.0	19.5	11.3	13.9	UCTL206C-200	UCTL206CD-200	52	8.0	UCTL206FC-200	UCTL206FCD-200	70	8.5			
	87	44	166	650	590	15	300	145	38.1	15.9	M12	UC206	9.0	19.5	11.3	13.9	UCTL206C-300	UCTL206CD-300	52	9.0	UCTL206FC-300	UCTL206FCD-300	70	9.5			
	87	44	166	750	690	15	400	145	38.1	15.9	M12	UC206	9.5	19.5	11.3	13.9	UCTL206C-400	UCTL206CD-400	52	9.5	UCTL206FC-400	UCTL206FCD-400	70	10			
35	92	44	176	460	400	15	100	150	42.9	17.5	M12	UC207	8.0	25.7	15.4	13.9	UCTL207C-100	UCTL207CD-100	59	8.0	UCTL207FC-100	UCTL207FCD-100	78	9.0			
	92	44	176	560	500	15	200	150	42.9	17.5	M12	UC207	8.5	25.7	15.4	13.9	UCTL207C-200	UCTL207CD-200	59	8.5	UCTL207FC-200	UCTL207FCD-200	78	9.5			
	92	44	176	660	600	15	300	150	42.9	17.5	M12	UC207	9.0	25.7	15.4	13.9	UCTL207C-300	UCTL207CD-300	59	9.0	UCTL207FC-300	UCTL207FCD-300	78	10			
	92	44	176	760	700	15	400	150	42.9	17.5	M12	UC207	10	25.7	15.4	13.9	UCTL207C-400	UCTL207CD-400	59	10	UCTL207FC-400	UCTL207FCD-400	78	11			
40	97	44	186	470	410	15	100	155	49.2	19	M12	UC208	8.5	29.1	17.8	14.0	UCTL208C-100	UCTL208CD-100	68	8.5	UCTL208FC-100	UCTL208FCD-100	86	9.5			
	97	44	186	570	510	15	200	155	49.2	19	M12	UC208	9.0	29.1	17.8	14.0	UCTL208C-200	UCTL208CD-200	68	9.0	UCTL208FC-200	UCTL208FCD-200	86	10			
	97	44	186	670	610	15	300	155	49.2	19	M12	UC208	10	29.1	17.8	14.0	UCTL208C-300	UCTL208CD-300	68	10	UCTL208FC-300	UCTL208FCD-300	86	11			
	97	44	186	770	710	15	400	155	49.2	19	M12	UC208	10.5	29.1	17.8	14.0	UCTL208C-400	UCTL208CD-400	68	10.5	UCTL208FC-400	UCTL208FCD-400	86	11.5			
45	100	44	192	480	420	15	100	160	49.2	19	M12	UC209	9.0	34.1	21.3	14.0	UCTL209C-100	UCTL209CD-100	68	9.0	UCTL209FC-100	UCTL209FCD-100	88	10			
	100	44	192	580	520	15	200	160	49.2	19	M12	UC209	9.5	34.1	21.3	14.0	UCTL209C-200	UCTL209CD-200	68	9.5	UCTL209FC-200	UCTL209FCD-200	88	10.5			
	100	44	192	680	620	15	300	160	49.2	19	M12	UC209	10.5	34.1	21.3	14.0	UCTL209C-300	UCTL209CD-300	68	10.5	UCTL209FC-300	UCTL209FCD-300	88	11.5			
	100	44	192	780	720	15	400	160	49.2	19	M12	UC209	11	34.1	21.3	14.0	UCTL209C-400	UCTL209CD-400	68	11	UCTL209FC-400	UCTL209FCD-400	88	12			

- Remarks 1. In Part No. of unit and units with covers, fitting codes follow bore diameter codes. (See Table 10.5 in P.42.)
 2. Part No. of applicable grease nipples is C-1/4-28UNF.
 3. As for the triple seal type product (204 and 205 are the double seal type products), accessory code L3 (or L2) follows the Part No. of unit or bearing. (Example of Part No. : UCTL206JL3-100, UC206L3)
 4. The unit should be mounted so that load is applied to the frame mounting surface vertically and downward.

5. If heavy load ($P_r/C_r > 0.12$), vibration, or impact occurs, contact with FYH.
 6. Tapered bore (with adapter) type bearing units are also available. (Example of Part No. : UKTL206J-100 + H306X, UK206 + H306X)
 7. If frame parts need to be corrosion resistant, contact with FYH.
 8. For the dimensions and forms of applicable bearings, see the dimensional tables of ball bearing for unit.

UCTU
Cylindrical bore (with set screws)
d 40 ~ 80 mm

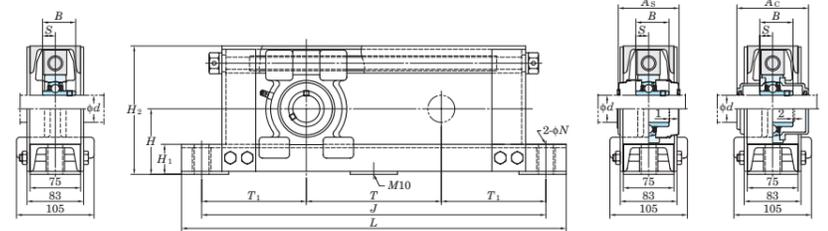

UCTU200

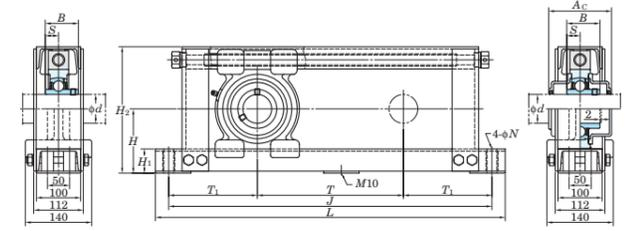

UCTU300

Variations of tolerance of distance from mounting bottom to center of spherical bore (ΔH_s) and variations of tolerance of distance between centers of bolt holes (ΔJ_s)

Nominal unit code	ΔH_s	ΔJ_s
UCTU208-212	±2	±0.8
UCTU313-315		±0.8
UCTU316-318		±1.2

Unit : mm

Shaft Dia. mm <i>d</i>	Dimensions mm											Bolt Size mm	Standard			Basic			With Pressed Steel Cover				With Cast Iron Cover			
	<i>H</i>	<i>H</i> ₁	<i>H</i> ₂	<i>L</i>	<i>J</i>	<i>N</i>	<i>T</i>	<i>T</i> ₁	<i>B</i>	<i>S</i>	Unit No.		Bearing No.	Mass	Load Ratings kN		Factor	Unit No.		Dimension	Mass	Unit No.		Dimension	Mass	
	<i>d</i>	<i>H</i>	<i>H</i> ₁	<i>H</i> ₂	<i>L</i>	<i>J</i>	<i>N</i>	<i>T</i>	<i>T</i> ₁	<i>B</i>	<i>S</i>		mm		kg	<i>C</i> _r	<i>C</i> _{0r}	<i>f</i> ₀	Open Type	One Side Closed Type	mm	kg	Open Type	One Side Closed Type	mm	kg
40	97	44	190	870	810	22	500	155	49.2	19	M18	UCTU208-500	UC208	21	29.1	17.8	14.0	UCTU208C-500	UCTU208CD-500	68	21	UCTU208FC-500	UCTU208FCD-500	86	22	
	97	44	190	970	910	22	600	155	49.2	19	M18	UCTU208-600	UC208	22	29.1	17.8	14.0	UCTU208C-600	UCTU208CD-600	68	22	UCTU208FC-600	UCTU208FCD-600	86	23	
	97	44	190	1070	1010	22	700	155	49.2	19	M18	UCTU208-700	UC208	24	29.1	17.8	14.0	UCTU208C-700	UCTU208CD-700	68	24	UCTU208FC-700	UCTU208FCD-700	86	25	
	97	44	190	1170	1110	22	800	155	49.2	19	M18	UCTU208-800	UC208	26	29.1	17.8	14.0	UCTU208C-800	UCTU208CD-800	68	26	UCTU208FC-800	UCTU208FCD-800	86	27	
	97	44	190	1270	1210	22	900	155	49.2	19	M18	UCTU208-900	UC208	28	29.1	17.8	14.0	UCTU208C-900	UCTU208CD-900	68	28	UCTU208FC-900	UCTU208FCD-900	86	29	
45	102	44	200	880	820	22	500	160	49.2	19	M18	UCTU209-500	UC209	22	34.1	21.3	14.0	UCTU209C-500	UCTU209CD-500	68	22	UCTU209FC-500	UCTU209FCD-500	88	23	
	102	44	200	980	920	22	600	160	49.2	19	M18	UCTU209-600	UC209	24	34.1	21.3	14.0	UCTU209C-600	UCTU209CD-600	68	24	UCTU209FC-600	UCTU209FCD-600	88	25	
	102	44	200	1080	1020	22	700	160	49.2	19	M18	UCTU209-700	UC209	25	34.1	21.3	14.0	UCTU209C-700	UCTU209CD-700	68	25	UCTU209FC-700	UCTU209FCD-700	88	26	
	102	44	200	1180	1120	22	800	160	49.2	19	M18	UCTU209-800	UC209	27	34.1	21.3	14.0	UCTU209C-800	UCTU209CD-800	68	27	UCTU209FC-800	UCTU209FCD-800	88	28	
	102	44	200	1280	1220	22	900	160	49.2	19	M18	UCTU209-900	UC209	29	34.1	21.3	14.0	UCTU209C-900	UCTU209CD-900	68	29	UCTU209FC-900	UCTU209FCD-900	88	30	
50	107	44	210	890	830	22	500	165	51.6	19	M18	UCTU210-500	UC210	23	35.1	23.3	14.4	UCTU210C-500	UCTU210CD-500	73	23	UCTU210FC-500	UCTU210FCD-500	97	24	
	107	44	210	990	930	22	600	165	51.6	19	M18	UCTU210-600	UC210	25	35.1	23.3	14.4	UCTU210C-600	UCTU210CD-600	73	25	UCTU210FC-600	UCTU210FCD-600	97	26	
	107	44	210	1090	1030	22	700	165	51.6	19	M18	UCTU210-700	UC210	27	35.1	23.3	14.4	UCTU210C-700	UCTU210CD-700	73	27	UCTU210FC-700	UCTU210FCD-700	97	28	
	107	44	210	1190	1130	22	800	165	51.6	19	M18	UCTU210-800	UC210	28	35.1	23.3	14.4	UCTU210C-800	UCTU210CD-800	73	28	UCTU210FC-800	UCTU210FCD-800	97	29	
	107	44	210	1290	1230	22	900	165	51.6	19	M18	UCTU210-900	UC210	30	35.1	23.3	14.4	UCTU210C-900	UCTU210CD-900	73	30	UCTU210FC-900	UCTU210FCD-900	97	31	
55	115	44	230	910	850	22	500	175	55.6	22.2	M18	UCTU211-500	UC211	25	43.4	29.4	14.4	UCTU211C-500	UCTU211CD-500	75	25	UCTU211FC-500	UCTU211FCD-500	99	26	
	115	44	230	1010	950	22	600	175	55.6	22.2	M18	UCTU211-600	UC211	27	43.4	29.4	14.4	UCTU211C-600	UCTU211CD-600	75	27	UCTU211FC-600	UCTU211FCD-600	99	28	
	115	44	230	1110	1050	22	700	175	55.6	22.2	M18	UCTU211-700	UC211	28	43.4	29.4	14.4	UCTU211C-700	UCTU211CD-700	75	28	UCTU211FC-700	UCTU211FCD-700	99	29	
	115	44	230	1210	1150	22	800	175	55.6	22.2	M18	UCTU211-800	UC211	30	43.4	29.4	14.4	UCTU211C-800	UCTU211CD-800	75	30	UCTU211FC-800	UCTU211FCD-800	99	31	
	115	44	230	1310	1250	22	900	175	55.6	22.2	M18	UCTU211-900	UC211	32	43.4	29.4	14.4	UCTU211C-900	UCTU211CD-900	75	32	UCTU211FC-900	UCTU211FCD-900	99	33	
60	120	44	240	920	860	22	500	180	65.1	25.4	M18	UCTU212-500	UC212	26	52.4	36.2	14.4	UCTU212C-500	UCTU212CD-500	88	26	UCTU212FC-500	UCTU212FCD-500	114	28	
	120	44	240	1020	960	22	600	180	65.1	25.4	M18	UCTU212-600	UC212	28	52.4	36.2	14.4	UCTU212C-600	UCTU212CD-600	88	28	UCTU212FC-600	UCTU212FCD-600	114	30	
	120	44	240	1120	1060	22	700	180	65.1	25.4	M18	UCTU212-700	UC212	30	52.4	36.2	14.4	UCTU212C-700	UCTU212CD-700	88	30	UCTU212FC-700	UCTU212FCD-700	114	32	
	120	44	240	1220	1160	22	800	180	65.1	25.4	M18	UCTU212-800	UC212	31	52.4	36.2	14.4	UCTU212C-800	UCTU212CD-800	88	31	UCTU212FC-800	UCTU212FCD-800	114	33	
	120	44	240	1320	1260	22	900	180	65.1	25.4	M18	UCTU212-900	UC212	33	52.4	36.2	14.4	UCTU212C-900	UCTU212CD-900	88	33	UCTU212FC-900	UCTU212FCD-900	114	35	
65	145	55	285	940	880	22	500	190	75	30	M18	UCTU313-500	UC313	40	92.7	59.9	13.2	-	-	-	-	UCTU313C-500	UCTU313CD-500	122	42	
	145	55	285	1040	980	22	600	190	75	30	M18	UCTU313-600	UC313	43	92.7	59.9	13.2	-	-	-	-	UCTU313C-600	UCTU313CD-600	122	45	
	145	55	285	1140	1080	22	700	190	75	30	M18	UCTU313-700	UC313	46	92.7	59.9	13.2	-	-	-	-	UCTU313C-700	UCTU313CD-700	122	48	
	145	55	285	1240	1180	22	800	190	75	30	M18	UCTU313-800	UC313	49	92.7	59.9	13.2	-	-	-	-	UCTU313C-800	UCTU313CD-800	122	51	
	145	55	285	1340	1280	22	900	190	75	30	M18	UCTU313-900	UC313	51	92.7	59.9	13.2	-	-	-	-	UCTU313C-900	UCTU313CD-900	122	53	
70	150	55	295	960	900	22	500	200	78	33	M18	UCTU314-500	UC314	44	104	68.2	13.2	-	-	-	-	UCTU314C-500	UCTU314CD-500	124	46	
	150	55	295	1060	1000	22	600	200	78	33	M18	UCTU314-600	UC314	46	104	68.2	13.2	-	-	-	-	UCTU314C-600	UCTU314CD-600	124	48	
	150	55	295	1160	1100	22	700	200	78	33	M18	UCTU314-700	UC314	48	104	68.2	13.2	-	-	-	-	UCTU314C-700	UCTU314CD-700	124	50	
	150	55	295	1260	1200	22	800	200	78	33	M18	UCTU314-800	UC314	51	104	68.2	13.2	-	-	-	-	UCTU314C-800	UCTU314CD-800	124	53	
	150	55	295	1360	1300	22	900	200	78	33	M18	UCTU314-900	UC314	53	104	68.2	13.2	-	-	-	-	UCTU314C-900	UCTU314CD-900	124	55	
75	155	55	305	980	920	22	500	210	82	32	M18	UCTU315-500	UC315	54	113	77.2	13.2	-	-	-	-	UCTU315C-500	UCTU315CD-500	134	57	
	155	55	305	1080	1020	22	600	210	82	32	M18	UCTU315-600	UC315	57	113	77.2	13.2	-	-	-	-	UCTU315C-600	UCTU315CD-600	134	60	
	155	55	305	1180	1120	22	700	210	82	32	M18	UCTU315-700	UC315	59	113	77.2	13.2	-	-	-	-	UCTU315C-700	UCTU315CD-700	134	62	
	155	55	305	1280	1220	22	800	210	82	32	M18	UCTU315-800	UC315	61	113	77.2	13.2	-	-	-	-	UCTU315C-800	UCTU315CD-800	134	64	
	155	55	305	1380	1320	22	900	210	82	32	M18	UCTU315-900	UC315	64	113	77.2	13.2	-	-	-	-	UCTU315C-900	UCTU315CD-900	134	67	
80	160	55	315	1000	940	22	500	220	86	34	M18	UCTU316-500	UC316	57	123	86.7	13.3	-	-	-	-	UCTU316C-500	UCTU316CD-500	138	60	
	160	55	315	1100	1040	22	600	220	86	34	M18	UCTU316-600	UC316	60	123	86.7	13.3	-	-	-	-	UCTU316C-600	UCTU316CD-600	138	63	
	160	55	315	1200	1140	22	700	220	86	34	M18	UCTU316-700	UC316	62	123	86.7	13.3	-	-	-	-	UCTU316C-700	UCTU316CD-700	138	65	
	160	55	315	1300	1240	22	800	220	86	34	M18	UCTU316-800	UC316	64	123	86.7	13.3	-	-	-	-	UCTU316C-800	UCTU316CD-800	138	67	
	160	55	315	1400	1340	22	900	220	86	34	M18	UCTU316-900	UC316	67	123	86.7	13.3	-	-	-	-	UCTU316C-900	UCTU316CD-900	138	70	

- Remarks 1. In Part No. of unit and units with covers, fitting codes follow bore diameter numbers. (See Table 10.5 in P.42.)
 2. Part No. of applicable grease nipples are shown below.
 C-1/4-28UNF..... 208-210
 C-PT1/8..... 211, 212, 313-318
 3. As for the triple seal type product, accessory code L3 follows the Part No. of unit or bearing.
 (Example of Part No. : UCTU208JL3-500, UC208L3)

4. The unit should be mounted so that load is applied to the frame mounting surface vertically and downward.
 5. If heavy load ($P_r/C_r > 0.12$), vibration, or impact occurs, contact with FYH.
 6. Tapered bore (with adapter) type bearing units are also available. (Example of Part No. : UKTU208J-500 + H308X, UK208 + H308X)
 7. If frame parts need to be corrosion resistant, contact with FYH.
 8. For the dimensions and forms of applicable bearings, see the dimensional tables of ball bearing for unit.

UCTU
Cylindrical bore (with set screws)
d 85 ~ 90 mm

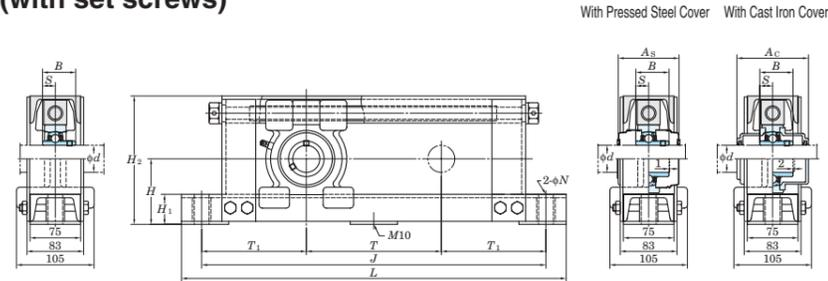

UCTU200

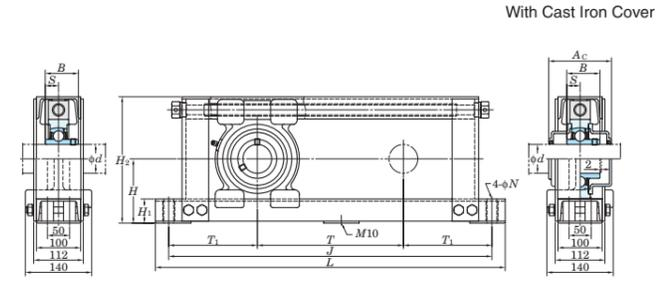

UCTU300

Variations of tolerance of distance from mounting bottom to center of spherical bore (ΔH_s) and variations of tolerance of distance between centers of bolt holes (ΔJ_s)

Nominal unit code	Unit : mm	
	ΔH_s	ΔJ_s
UCTU208-212	±2	±0.8
UCTU313-315		±0.8
UCTU316-318		±1.2

Shaft Dia. mm <i>d</i>	Dimensions mm										Bolt Size mm	Standard			Basic			With Pressed Steel Cover				With Cast Iron Cover			
	<i>H</i>	<i>H</i> ₁	<i>H</i> ₂	<i>L</i>	<i>J</i>	<i>N</i>	<i>T</i>	<i>T</i> ₁	<i>B</i>	<i>S</i>		Unit No.	Bearing No.	Mass kg	Load Ratings kN		<i>f</i> ₀	Unit No.		Dimension mm <i>A</i> _s	Mass kg	Unit No.		Dimension mm <i>A</i> _c	Mass kg
	<i>C</i> _r	<i>C</i> _{0r}	Open Type	One Side Closed Type	Open Type	One Side Closed Type																			
85	165	55	325	1 020	960	22	500	230	96	40	M18	UC317	62	133	96.8	13.3	-	-	-	-	UCTU317C-500	UCTU317CD-500	146	65	
	165	55	325	1 120	1 060	22	600	230	96	40	M18	UC317	64	133	96.8	13.3	-	-	-	-	UCTU317C-600	UCTU317CD-600	146	67	
	165	55	325	1 220	1 160	22	700	230	96	40	M18	UC317	67	133	96.8	13.3	-	-	-	-	UCTU317C-700	UCTU317CD-700	146	70	
	165	55	325	1 320	1 260	22	800	230	96	40	M18	UC317	69	133	96.8	13.3	-	-	-	-	UCTU317C-800	UCTU317CD-800	146	72	
	165	55	325	1 420	1 360	22	900	230	96	40	M18	UC317	71	133	96.8	13.3	-	-	-	-	UCTU317C-900	UCTU317CD-900	146	74	
90	170	55	335	1 050	990	22	500	245	96	40	M18	UC318	65	143	107	13.3	-	-	-	-	UCTU318C-500	UCTU318CD-500	150	68	
	170	55	335	1 150	1 090	22	600	245	96	40	M18	UC318	67	143	107	13.3	-	-	-	-	UCTU318C-600	UCTU318CD-600	150	70	
	170	55	335	1 250	1 190	22	700	245	96	40	M18	UC318	70	143	107	13.3	-	-	-	-	UCTU318C-700	UCTU318CD-700	150	73	
	170	55	335	1 350	1 290	22	800	245	96	40	M18	UC318	72	143	107	13.3	-	-	-	-	UCTU318C-800	UCTU318CD-800	150	75	
	170	55	335	1 450	1 390	22	900	245	96	40	M18	UC318	74	143	107	13.3	-	-	-	-	UCTU318C-900	UCTU318CD-900	150	77	

- Remarks 1. In Part No. of unit and units with covers, fitting codes follow bore diameter numbers. (See Table 10.5 in P.42.)
 2. Part No. of applicable grease nipples are shown below.
 C-1/4-28UNF..... 208~210
 C-PT1/8..... 211, 212, 313~318
 3. As for the triple seal type product, accessory code L3 follows the Part No. of unit or bearing.
 (Example of Part No. : UCTU208JL3-500, UC208L3)

4. The unit should be mounted so that load is applied to the frame mounting surface vertically and downward.
 5. If heavy load ($P_r/C_r > 0.12$), vibration, or impact occurs, contact with FYH.
 6. Tapered bore (with adapter) type bearing units are also available. (Example of Part No. : UKTU208J-500 + H308X, UK208 + H308X)
 7. If frame parts need to be corrosion resistant, contact with FYH.
 8. For the dimensions and forms of applicable bearings, see the dimensional tables of ball bearing for unit.

Steel plate frame take-up type units

SBPTH
Cylindrical bore (with set screws)
 d 12 ~ 25 mm

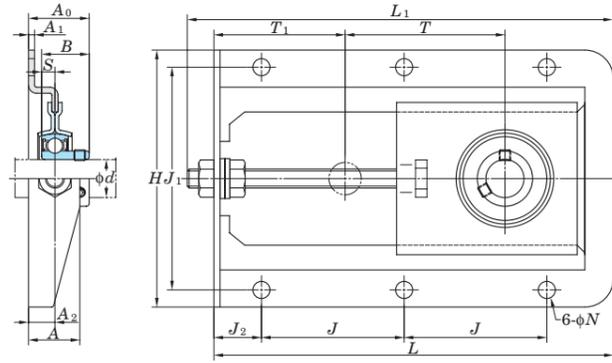

Variations of tolerance of distance between centers of bolt holes ($\Delta J_s, \Delta J_{1s}$)

Nominal unit code	ΔJ_s	ΔJ_{1s}
SBPTH201~SBPTH205	± 0.7	± 0.7

Shaft Dia. mm d	Dimensions																Bolt Size inch mm	Unit No.	Bearing No.	Basic Load Ratings kN		Factor f_0	Mass kg
	H	L	L_1	A	J	J_1	J_2	N	T	T_1	A_1	A_2	A_0	B	S	C_r				C_{0r}			
12	5 5/16	8 9/32	8 21/32	1 1/16	2 61/64	4 39/64	31/32	11/32	3 15/32	2 23/32	1/8	35/64	1 3/16	0.866	0.236	5/16	SBPTH201-90	SB201	9.55	4.80	13.2	0.91	
	135	210	220	27	75	117	25	9	88	69	3.2	13.9	29.9	22	6	M8							
15	5 5/16	8 9/32	8 21/32	1 1/16	2 61/64	4 39/64	31/32	11/32	3 15/32	2 23/32	1/8	35/64	1 3/16	0.866	0.236	5/16	SBPTH202-90	SB202	9.55	4.80	13.2	0.91	
	135	210	220	27	75	117	25	9	88	69	3.2	13.9	29.9	22	6	M8							
17	5 5/16	8 9/32	8 21/32	1 1/16	2 61/64	4 39/64	31/32	11/32	3 15/32	2 23/32	1/8	35/64	1 3/16	0.866	0.236	5/16	SBPTH203-90	SB203	9.55	4.80	13.2	0.91	
	135	210	220	27	75	117	25	9	88	69	3.2	13.9	29.9	22	6	M8							
20	5 5/16	8 9/32	8 21/32	1 1/16	2 61/64	4 39/64	31/32	11/32	3 15/32	2 23/32	1/8	35/64	1 1/4	0.984	0.276	5/16	SBPTH204-90	SB204	12.8	6.65	13.2	0.91	
	135	210	220	27	75	117	25	9	88	69	3.2	13.9	31.9	25	7	M8							
25	5 5/16	8 9/32	8 21/32	1 1/16	2 61/64	4 39/64	31/32	11/32	3 15/32	2 23/32	1/8	35/64	1 5/16	1.063	0.295	5/16	SBPTH205-90	SB205	14.0	7.85	13.9	0.91	
	135	210	220	27	75	117	25	9	88	69	3.2	13.9	33.4	27	7.5	M8							

Remark For the dimensions and forms of applicable bearings, see the dimensional tables of ball bearing for unit.

SBNPTH
Cylindrical bore (with set screws)
 d 12 ~ 25 mm

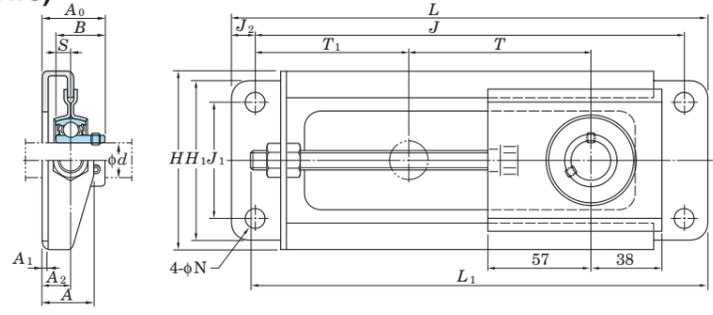

Variations of tolerance of distance between centers of bolt holes ($\Delta J_s, \Delta J_{1s}$)

Nominal unit code	ΔJ_s	ΔJ_{1s}
SBNPTH201~SBNPTH205	± 0.7	± 0.7

Unit : mm

Shaft Dia. mm d	Dimensions																	Bolt Size	Unit No.	Bearing No.	Basic Load Ratings		Factor f_0	Mass kg
	H	H_1	L	L_1	A	J	J_1	J_2	N	T	T_1	A_1	A_2	A_0	B	S	C_r				C_{0r}			
12	$3 \frac{15}{16}$	$3 \frac{17}{32}$	$10 \frac{1}{4}$	$9 \frac{11}{16}$	$1 \frac{1}{16}$	$9 \frac{1}{4}$	$2 \frac{9}{16}$	$\frac{1}{2}$	$\frac{7}{16}$	$3 \frac{15}{16}$	$3 \frac{9}{32}$	$\frac{1}{8}$	$\frac{19}{32}$	$1 \frac{7}{32}$	0.866	0.236	$\frac{5}{16}$	SBNPTH201-100	SB201	9.55	4.80	13.2	0.93	
	100	90	260	246	27	235	65	12.5	11	100	83.5	3.2	15	31	22	6	M8							
15	$3 \frac{15}{16}$	$3 \frac{17}{32}$	$10 \frac{1}{4}$	$9 \frac{11}{16}$	$1 \frac{1}{16}$	$9 \frac{1}{4}$	$2 \frac{9}{16}$	$\frac{1}{2}$	$\frac{7}{16}$	$3 \frac{15}{16}$	$3 \frac{9}{32}$	$\frac{1}{8}$	$\frac{19}{32}$	$1 \frac{7}{32}$	0.866	0.236	$\frac{5}{16}$	SBNPTH202-100	SB202	9.55	4.80	13.2	0.93	
	100	90	260	246	27	235	65	12.5	11	100	83.5	3.2	15	31	22	6	M8							
17	$3 \frac{15}{16}$	$3 \frac{17}{32}$	$10 \frac{1}{4}$	$9 \frac{11}{16}$	$1 \frac{1}{16}$	$9 \frac{1}{4}$	$2 \frac{9}{16}$	$\frac{1}{2}$	$\frac{7}{16}$	$3 \frac{15}{16}$	$3 \frac{9}{32}$	$\frac{1}{8}$	$\frac{19}{32}$	$1 \frac{7}{32}$	0.866	0.236	$\frac{5}{16}$	SBNPTH203-100	SB203	9.55	4.80	13.2	0.93	
	100	90	260	246	27	235	65	12.5	11	100	83.5	3.2	15	31	22	6	M8							
20	$3 \frac{15}{16}$	$3 \frac{17}{32}$	$10 \frac{1}{4}$	$9 \frac{11}{16}$	$1 \frac{1}{16}$	$9 \frac{1}{4}$	$2 \frac{9}{16}$	$\frac{1}{2}$	$\frac{7}{16}$	$3 \frac{15}{16}$	$3 \frac{9}{32}$	$\frac{1}{8}$	$\frac{19}{32}$	$1 \frac{5}{16}$	0.984	0.276	$\frac{5}{16}$	SBNPTH204-100	SB204	12.8	6.65	13.2	0.93	
	100	90	260	246	27	235	65	12.5	11	100	83.5	3.2	15	33	25	7	M8							
25	$3 \frac{15}{16}$	$3 \frac{17}{32}$	$10 \frac{1}{4}$	$9 \frac{11}{16}$	$1 \frac{1}{16}$	$9 \frac{1}{4}$	$2 \frac{9}{16}$	$\frac{1}{2}$	$\frac{7}{16}$	$3 \frac{15}{16}$	$3 \frac{9}{32}$	$\frac{1}{8}$	$\frac{19}{32}$	$1 \frac{11}{32}$	1.063	0.295	$\frac{5}{16}$	SBNPTH205-100	SB205	14.0	7.85	13.9	0.93	
	100	90	260	246	27	235	65	12.5	11	100	83.5	3.2	15	34.5	27	7.5	M8							

Remark For the dimensions and forms of applicable bearings, see the dimensional tables of ball bearing for unit.

Cartridge type units

UCC
Cylindrical bore (with set screws)
d 12 ~ (45) mm

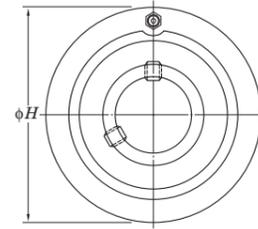
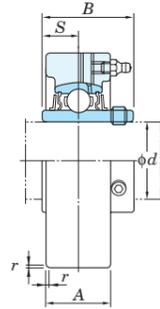

d (45) ~ 90 mm

Variations of tolerance of outside diameter (ΔH_s), variations of tolerance of width (ΔA_s), and tolerance of circumferential runout of outside diameter (Y)

Housing No.		ΔH_s	ΔA_s	Y
C204-C205		0 -0.030	±0.2	0.2
C206-C210	CX05-CX08 C305-C308	0 -0.035		
C211-C213	CX09-CX10 C309-C310	0 -0.040	±0.3	0.3
	C311-C314 C315-C318	0 -0.046		
	C319 C320-C322	0 -0.052		
	C324-C328	0 -0.057		

Shaft Dia. mm inch	Dimensions inch mm					Unit No.	Housing No.	Bearing No.	Basic Load Ratings kN		Factor f_0	Mass kg
	d	H	A	r	B				S	C_r		
12	1/2					UCC201 UCC201-8		UC201 UC201-8				0.52
15	5/8	2.835	25/32	0.06	1.220	UCC202 UCC202-10	C204	UC202 UC202-10	12.8	6.65	13.2	0.50
17	3/4	72	20	1.5	31	UCC203 UCC204-12		UC203 UC204-12				0.49
20						UCC204		UC204				0.47
25	7/8	3.150	55/64	0.06	1.343	UCC205-14 UCC205-15	C205	UC205-14 UC205-15	14.0	7.85	13.9	0.64
	15/16	80	22	1.5	34.1	UCC205		UC205				
	1	3.543	11/16	0.06	1.500	UCC205-16 UCCX05	CX05	UCX05 UCX05-16	19.5	11.3	13.9	1.0
	1	90	27	1.5	38.1	UCCX05-16						
30	1	3.543	11/32	0.08	1.496	UCC305 UCC305-16	C305	UC305 UC305-16	21.2	10.9	12.6	1.5
	1 1/8	3.346	11/16	0.06	1.500	UCC206-18 UCC206	C206	UC206-18 UC206	19.5	11.3	13.9	0.81
	1 3/16	85	27	1.5	38.1	UCC206-19 UCC206-20		UC206-19 UC206-20				
	1 1/4	3.937	13/16	0.08	1.689	UCCX06 UCCX06-19	CX06	UCX06 UCX06-19	25.7	15.4	13.9	1.3
35	1 3/16	100	30	2	42.9	UCCX06-20		UCX06-20				
	1 1/4	3.937	17/64	0.08	1.693	UCC306	C306	UC306	26.7	15.0	13.3	1.7
	1 1/8	3.346	11/16	0.06	1.500	UCC207-20 UCC207-21	C207	UC207-20 UC207-21	25.7	15.4	13.9	0.93
	1 5/16	3.543	17/64	0.08	1.689	UCC207-22 UCC207		UC207-22 UC207				
40	1 3/8	4.331	1 11/32	0.08	1.937	UCC207-23 UCCX07-22	CX07	UCX07 UCX07-22	29.1	17.8	14.0	1.7
	1 7/16	110	34	2	49.2	UCCX07-22		UCX07-22				
	1 3/8	4.331	1 17/64	0.12	1.890	UCCX07 UCCX07-23	C307	UCX07 UCX07-23	33.4	19.3	13.2	2.2
	1 7/16	110	32	3	48	UCC307		UC307				
45	1 1/2	3.937	1 3/16	0.08	1.937	UCC208-24 UCC208-25	C208	UC208-24 UC208-25	29.1	17.8	14.0	1.2
	1 9/16	100	30	2	49.2	UCC208		UC208				
	1 1/2	4.724	1 1/2	0.08	1.937	UCCX08-24 UCCX08	CX08	UCX08-24 UCX08	34.1	21.3	14.0	2.3
45	1 1/2	4.724	1 11/32	0.12	2.047	UCC308-24 UCC308	C308	UC308-24 UC308	40.7	24.0	13.2	2.2
	1 5/8	4.331	1 7/32	0.08	1.937	UCC209-26 UCC209-27	C209	UC209-26 UC209-27	34.1	21.3	14.0	1.5
	1 11/16	110	31	2	49.2	UCC209-28 UCC209		UC209-28 UC209				

Shaft Dia. mm inch	Dimensions inch mm					Unit No.	Housing No.	Bearing No.	Basic Load Ratings kN		Factor f_0	Mass kg
	d	H	A	r	B				S	C_r		
45	1 3/4	4.724	1 1/2	0.08	2.031	UCCX09-28 UCCX09	CX09	UCX09-28 UCX09	35.1	23.3	14.4	2.3
	1 3/4	5.118	1 1/2	0.12	2.244	UCC309-28 UCC309	C309	UC309-28 UC309	48.9	29.5	13.3	2.8
50	1 7/8	4.724	1 19/64	0.08	2.031	UCC210-30 UCC210-31	C210	UC210-30 UC210-31	35.1	23.3	14.4	2.0
	1 15/16	120	33	2	51.6	UCC210		UC210				
	2	5.118	1 37/64	0.1	2.189	UCCX10-31 UCCX10	CX10	UCX10-31 UCX10	43.4	29.4	14.4	2.8
	2	130	40	2.5	55.6	UCCX10-32		UCX10-32				
55	2	5.512	1 37/64	0.12	2.402	UCC310	C310	UC310	62.0	38.3	13.2	3.2
	2 1/8	4.921	1 3/8	0.1	2.189	UCC211-32 UCC211-34	C211	UC211-32 UC211-34	43.4	29.4	14.4	2.2
	2 3/16	125	35	2.5	55.6	UCC211-35		UC211-35				
	2 3/16	5.906	1 21/32	0.1	2.563	UCCX11 UCCX11-35	CX11	UCX11 UCX11-35	52.4	36.2	14.4	4.0
60	2 1/4	5.906	1 47/64	0.12	2.598	UCC311-32 UCC311	C311	UC311-32 UC311	71.6	45.0	13.2	3.9
	2 1/4	150	44	3	66	UCC212-36 UCC212	C212	UC212-36 UC212	52.4	36.2	14.4	2.6
	2 3/8	130	38	2.5	65.1	UCC212-38 UCC212-39		UC212-38 UC212-39				
65	2 7/16	6.299	1 47/64	0.1	2.563	UCCX12 UCCX12-39	CX12	UCX12 UCX12-39	57.2	40.1	14.4	4.6
	2 7/16	160	44	2.5	65.1	UCC312	C312	UC312	81.9	52.2	13.2	4.8
	2 7/16	6.299	1 13/16	0.12	2.795	UCC312						
70	2 1/2	5.512	1 37/64	0.1	2.563	UCC213-40 UCC213	C213	UC213-40 UC213	57.2	40.1	14.4	3.0
	2 1/2	6.693	1 31/32	0.12	2.953	UCC313-40 UCC313-40	C313	UC313-40 UC313	92.7	59.9	13.2	5.7
75	2 3/4	7.087	2 3/64	0.12	3.071	UCC314-44 UCC314	C314	UC314-44 UC314	104	68.2	13.2	6.7
	2 15/16	7.480	2 11/64	0.16	3.228	UCC315-47 UCC315	C315	UC315-47 UC315	113	77.2	13.2	7.8
80	3	190	55	4	82	UCC315-48		UC315-48				
	3	7.874	2 23/64	0.16	3.386	UCC316	C316	UC316	123	86.7	13.3	9.2
85	3	8.465	2 33/64	0.16	3.780	UCC317	C317	UC317	133	96.8	13.3	11.7
	3	215	64	4	96							
90	3 1/2	8.858	2 19/32	0.16	3.780	UCC318-56 UCC318	C318	UC318-56 UC318	143	107	13.3	13.1
	3 1/2	225	66	4	96							

- Remarks 1. In Part No. of unit and units with covers, fitting codes follow bore diameter numbers. (See Table 10.5 in P.42.)
 2. Part No. of applicable grease nipples are shown below.
 A-1/4-28UNF 201-213, X05-X12, 305-308
 A-PT1/8 309-328
 3. As for the triple seal type product (from 201 to 205 are the double seal type products), accessory code L3 (L2) follows the Part No. of unit or bearing. (Example of Part No. : UCC206JL3, UC206L3)
 4. For the dimensions and forms of applicable bearings, see the dimensional tables of ball bearing for unit.

UCC
Cylindrical bore (with set screws)
 d 95 ~ 140 mm

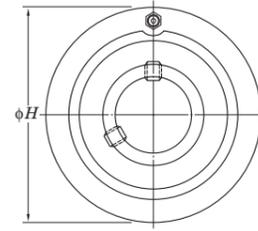
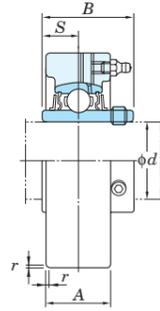

Shaft Dia. mm inch	Dimensions inch mm					Unit No.	Housing No.	Bearing No.	Basic Load Ratings kN		Factor f_0	Mass kg
	H	A	r	B	S				C_r	C_{0r}		
95 —	9.449 240	2 53/64 72	0.16 4	4.055 103	1.614 41	UCC319	C319	UC319	153	119	13.3	15.8
100 3 15/16 4	10.236 260	2 61/64 75	0.16 4	4.252 108	1.654 42	UCC320 UCC320-63 UCC320-64	C320	UC320 UC320-63 UC320-64	173	141	13.2	19.6
105 —	10.236 260	2 61/64 75	0.16 4	4.409 112	1.732 44	UCC321	C321	UC321	184	153	13.2	27.0
110 —	11.811 300	3 5/32 80	0.2 5	4.606 117	1.811 46	UCC322	C322	UC322	205	180	13.2	29.2
120 —	12.598 320	3 35/64 90	0.2 5	4.961 126	2.008 51	UCC324	C324	UC324	207	185	13.5	35.9
130 —	13.386 340	3 15/16 100	0.24 6	5.315 135	2.126 54	UCC326	C326	UC326	229	214	13.6	43.0
140 —	14.173 360	3 15/16 100	0.24 6	5.709 145	2.323 59	UCC328	C328	UC328	253	246	13.6	52.9

- Remarks 1. In Part No. of unit and units with covers, fitting codes follow bore diameter numbers. (See **Table 10.5** in P.42.)
 2. Part No. of applicable grease nipples are shown below.
 A-1/4-28UNF 201~213, X05~X12, 305~308
 A-PT1/8 309~328
 3. As for the triple seal type product (from 201 to 205 are the double seal type products), accessory code L3 (L2) follows the Part No. of unit or bearing. (Example of Part No. : UCC206JL3, UC206L3)
 4. For the dimensions and forms of applicable bearings, see the dimensional tables of ball bearing for unit.

Variations of tolerance of outside diameter (ΔH_s), variations of tolerance of width (ΔA_s), and tolerance of circumferential runout of outside diameter (Y)

Housing No.			ΔH_s	ΔA_s	Y
C204-C205			0 -0.030	±0.2	0.2
C206-C210	CX05-CX08	C305-C308	0 -0.035		
C211-C213	CX09-CX10	C309-C310	0	±0.3	0.3
	CX11-CX12	C311-C314	-0.040		
		C315-C318	0 -0.046		
	C319	0 -0.052			
	C320-C322	0 -0.057	±0.3	0.4	

Unit : mm

Cartridge type units

UKC
Tapered bore (with adapter)
d₁ 20 ~ 45 mm

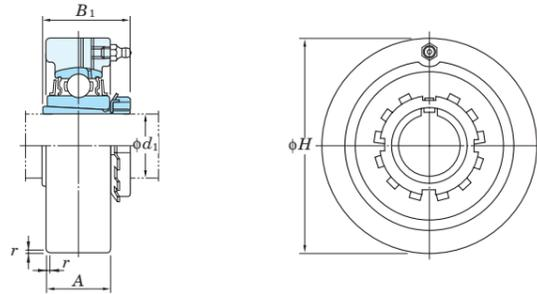

Shaft Dia. mm inch	Dimensions inch mm				Unit No.	Housing No.	Bearing No.	Basic Load Ratings kN		Factor f ₀	Adapter ¹⁾ No.	Mass ¹⁾ kg
	d ₁	H	A	r				B ₁ ¹⁾	C _r			
20	3/4	3.150 80	55/64 22	0.06 1.5	1 5/32(1 3/8) 29(35)	UKC205	C205	UK205	14.0 7.85	13.9	HE305X(HE2305X) H305X(H2305X)	0.68(0.70)
	3/4	3.543 90	11/16 27	0.06 1.5	1 3/8 35	UKCX05	CX05	UKX05	19.5 11.3	13.9	HE2305X H2305X	0.99
	3/4	3.543 90	11/32 26	0.08 2	1 3/8 35	UKC305	C305	UK305	21.2 10.9	12.6	HE2305X H2305X	1.6
25	1	3.346 85	11/16 27	0.06 1.5	1 7/32(1 1/2) 31(38)	UKC206	C206	UK206	19.5 11.3	13.9	H306X(H2306X) HE306X(HE2306X)	0.85(0.89)
	1	3.937 100	13/16 30	0.08 2	1 1/2 38	UKCX06	CX06	UKX06	25.7 15.4	13.9	H2306X HE2306X	1.3
	1	3.937 100	13/16 28	0.08 2	1 1/2 38	UKC306	C306	UK306	26.7 15.0	13.3	H2306X HE2306X	1.8
30	1 1/8	3.543 90	17/64 28	0.08 2	1 3/8(1 11/16) 35(43)	UKC207	C207	UK207	25.7 15.4	13.9	HS307X(HS2307X) H307X(H2307X)	0.97(1.0)
	1 1/8	4.331 110	1 11/32 34	0.08 2	1 11/16 43	UKCX07	CX07	UKX07	29.1 17.8	14.0	HS2307X H2307X	1.7
	1 1/8	4.331 110	1 17/64 32	0.12 3	1 11/16 43	UKC307	C307	UK307	33.4 19.3	13.2	HS2307X H2307X	2.2
35	1 1/4	3.937 100	1 3/16 30	0.08 2	1 13/32(1 13/16) 36(46)	UKC208	C208	UK208	29.1 17.8	14.0	HE308X(HE2308X) HS308X(HS2308X) H308X(H2308X)	1.3(1.4)
	1 1/4	4.724 120	1 1/2 38	0.08 2	1 13/16 46	UKCX08	CX08	UKX08	34.1 21.3	14.0	HE2308X HS2308X H2308X	2.3
	1 1/4	4.724 120	1 11/32 34	0.12 3	1 13/16 46	UKC308	C308	UK308	40.7 24.0	13.2	HE2308X HS2308X H2308X	2.2
40	1 1/2	4.331 110	1 7/32 31	0.08 2	1 17/32(1 31/32) 39(50)	UKC209	C209	UK209	34.1 21.3	14.0	HE309X(H2309X) H309X(H2309X) HS309X(H2309X)	1.6(1.7)
	1 1/2	4.724 120	1 1/2 38	0.08 2	1 31/32 50	UKCX09	CX09	UKX09	35.1 23.3	14.4	HE2309X H2309X HS2309X	2.3
	1 1/2	5.118 130	1 1/2 38	0.12 3	1 31/32 50	UKC309	C309	UK309	48.9 29.5	13.3	HE2309X H2309X HS2309X	2.8
45	1 3/4	4.724 120	1 19/64 33	0.08 2	1 21/32(2 5/32) 42(55)	UKC210	C210	UK210	35.1 23.3	14.4	HE310X(HE2310X) H310X(H2310X)	2.0(2.1)
	1 3/4	5.118 130	1 37/64 40	0.1 2.5	2 5/32 55	UKCX10	CX10	UKX10	43.4 29.4	14.4	HE2310X H2310X	2.8
	1 3/4	5.512 140	1 37/64 40	0.12 3	2 5/32 55	UKC310	C310	UK310	62.0 38.3	13.2	HE2310X H2310X	3.2

Note 1) Numerals shown in parentheses indicate the dimensions, Part No. of applicable adapters (H2300X series), and the unit weight of UK200L3 series (triple seal type).

Remarks 1. In Part No. of unit and units with covers, fitting codes follow bore diameter numbers. (See Table 10.5 in P.42.)

2. Part No. of applicable grease nipples are shown below.

A-1/4-28UNF 205-213, X05-X12, 305-308

A-PT1/8 309-328

3. In Part No. of unit with adapters and bearing with adapters, Part No. of applicable adapter follow the Part No. shown in the dimensional tables. (Example of Part No. : UKC206J + H306X, UK206 + H306X)

4. As for the triple seal type product (205 is the double seal type product), accessory code L3 (or L2) follows the Part No. of unit or bearing. (Example of Part No. : UKC206JL3 + H2306X, UK206L3 + H2306X)

5. As for the dimensions and forms of applicable bearings and adapters, see the dimensional tables of ball bearing for unit and adapter.

d₁ 50 ~ 125 mm

Variations of tolerance of outside diameter (ΔH_s), variations of tolerance of width (ΔA_s), and tolerance of circumferential runout of outside diameter (Y)

Housing No.			ΔH_s	ΔA_s	Y
C205			0 -0.030	±0.2	0.2
C206-C210	CX05-CX08	C305-C308	0 -0.035		
C211-C213	CX09-CX10	C309-C310	0	±0.3	0.3
	CX11-CX12	C311-C314	-0.040		
		C315-C318	0		
		C319	-0.046		
		C320-C322	0 -0.052		
		C324-C328	0 -0.057	±0.3	0.4

Unit : mm

Shaft Dia. mm inch	Dimensions inch mm				Unit No.	Housing No.	Bearing No.	Basic Load Ratings kN		Factor f ₀	Adapter ¹⁾ No.	Mass ¹⁾ kg
	d ₁	H	A	r				B ₁ ¹⁾	C _r			
50	1 7/8	4.921 125	1 3/8 35	0.1 2.5	1 25/32(2 5/16) 45(59)	UKC211	C211	UK211	43.4 29.4	14.4	HS311X(HS2311X) H311X(H2311X) HE311X(HE2311X)	2.3(2.6)
	2	5.906 150	1 21/32 42	0.1 2.5	2 5/16 59	UKCX11	CX11	UKX11	52.4 36.2	14.4	HS2311X H2311X HE2311X	3.8
55	1 7/8	5.906 150	1 47/64 44	0.12 3	2 5/16 59	UKC311	C311	UK311	71.6 45.0	13.2	HS2311X H2311X HE2311X	4.1
	2	5.118 130	1 1/2 38	0.1 2.5	1 27/32(2 7/16) 47(62)	UKC212	C212	UK212	52.4 36.2	14.4	HS312X(HS2312X) H312X(H2312X)	2.5(2.9)
60	2 1/8	6.299 160	1 47/64 44	0.1 2.5	2 7/16 62	UKCX12	CX12	UKX12	57.2 40.1	14.4	HS2312X H2312X	4.4
	2 1/8	6.299 160	1 13/16 46	0.12 3	2 7/16 62	UKC312	C312	UK312	81.9 52.2	13.2	HS2312X H2312X	4.7
65	2 1/4	5.512 140	1 37/64 40	0.1 2.5	1 31/32(2 9/16) 50(65)	UKC213	C213	UK213	57.2 40.1	14.4	HE313X(HE2313X) H313X(H2313X) HS313X(HS2313X)	3.0(3.3)
	2 3/8	6.693 170	1 31/32 50	0.12 3	2 9/16 65	UKC313	C313	UK313	92.7 59.9	13.2	HE2313X H2313X HS2313X	5.8
70	2 1/2	7.480 190	2 11/64 55	0.16 4	2 7/8 73	UKC315	C315	UK315	113 77.2	13.2	HE2315X H2315X	8.0
75	2 3/4	7.874 200	2 23/64 60	0.16 4	3 1/16 78	UKC316	C316	UK316	123 86.7	13.3	HE2316X H2316X	9.2
80	3	8.465 215	2 39/64 64	0.16 4	3 7/32 82	UKC317	C317	UK317	133 96.8	13.3	H2317X HE2317X	11.6
85	3 1/4	8.858 225	2 19/32 66	0.16 4	3 3/8 86	UKC318	C318	UK318	143 107	13.3	H2318X	13.1
90	3 1/2	9.449 240	2 53/64 72	0.16 4	3 17/32 90	UKC319	C319	UK319	153 119	13.3	HE2319X H2319X	16.1
100	4	10.236 260	2 61/64 75	0.16 4	3 13/16 97	UKC320	C320	UK320	173 141	13.2	HE2320X H2320X	19.2
110	4 1/2	11.811 300	3 3/32 80	0.2 5	4 1/8 105	UKC322	C322	UK322	205 180	13.2	H2322X HE2322X	29.1
115	5	12.598 320	3 35/64 90	0.2 5	4 13/32 112	UKC324	C324	UK324	207 185	13.5	H2324	36.2
125	5 1/2	13.386 340	3 19/16 100	0.24 6	4 3/4 121	UKC326	C326	UK326	229 214	13.6	HE2326 H2326	42.8
125	6	14.173 360	3 15/16 100	0.24 6	5 5/32 131	UKC328	C328	UK328	253 246	13.6	H2328	52.9

Hanger type units

UCHA
Cylindrical bore (with set screws)
d 12 ~ 75 mm

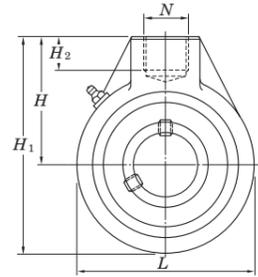
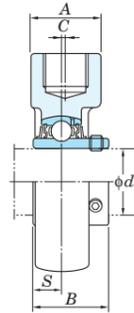

Shaft Dia. mm inch d	Dimensions inch mm										Unit No.	Housing No.	Bearing No.	Basic Load Ratings kN		Factor f ₀	Mass kg
	H	A	L	H ₁	H ₂	N	C	B	S	C _r				C _{0r}			
12 1/2											UCHA201 UCHA201-8 UCHA202 UCHA202-10 UCHA203 UCHA204-12 UCHA204	HA204	UC201 UC201-8 UC202 UC202-10 UC203 UC204-12 UC204	12.8	6.65	13.2	0.77 0.75 0.74 0.72
15 5/8	2 17/32	1 9/16	2 17/32	3 25/32	3/4	PF 3/4	-	1.220	0.500								
17 3/4	64	40	64	96	19	PF 3/4	-	31	12.7								
20											UCHA205-14 UCHA205-15 UCHA205 UCHA205-16 UCHA206-18 UCHA206 UCHA206-19 UCHA206-20	HA205	UC205-14 UC205-15 UC205 UC205-16 UC206-18 UC206 UC206-19 UC206-20	14.0	7.85	13.9	0.87
25 7/8 15/16	2 17/32	1 9/16	3 1/16	4 1/16	3/4	PF 3/4	-	1.343	0.563								
25	64	40	78	103	19	PF 3/4	-	34.1	14.3								
30 1 1/8	2 17/32	1 9/16	3 1/16	4 1/16	3/4	PF 3/4	-	1.500	0.626								
30	64	40	78	103	19	PF 3/4	-	38.1	15.9								
35 1 1/4 1 5/16 1 3/8	2 3/4	1 9/16	3 5/8	4 9/16	3/4	PF 3/4	-	1.689	0.689								
35	70	40	92	116	19	PF 3/4	-	42.9	17.5								
40 1 1/2 1 9/16	2 7/8	1 9/16	3 25/32	4 3/4	3/4	PF 3/4	5/64	1.937	0.748								
40	73	40	96	121	19	PF 3/4	2	49.2	19								
45 1 5/8 1 11/16 1 3/4	3 7/32	1 7/8	4 1/4	5 11/32	13/16	PF 1	13/64	1.937	0.748								
45	82	48	108	136	21	PF 1	5	49.2	19								
50 1 7/8 1 15/16	3 9/32	1 7/8	4 21/32	5 19/32	13/16	PF 1	13/64	2.031	0.748								
50	83	48	118	142	21	PF 1	5	51.6	19								
55 2 2 1/8 2 3/16	3 7/16	2 3/8	4 31/32	5 29/32	31/32	PF 1 1/4	9/32	2.189	0.874								
55	87	60	126	150	25	PF 1 1/4	7	55.6	22.2								
60 2 1/4 2 3/8 2 7/16	4 1/32	2 3/8	5 19/32	6 13/16	1 3/32	PF 1 1/4	23/64	2.563	1.000								
60	102	60	142	173	28	PF 1 1/4	9	65.1	25.4								
65 2 1/2	4 19/32	2 3/4	6 17/32	7 7/8	1 1/4	PF 1 1/2	3/8	2.563	1.000								
65	117	70	166	200	32	PF 1 1/2	9.5	65.1	25.4								
70 2 3/4	4 19/32	2 3/4	6 17/32	7 7/8	1 1/4	PF 1 1/2	3/8	2.937	1.189								
70	117	70	166	200	32	PF 1 1/2	9.5	74.6	30.2								
75 2 15/16 3	4 19/32	2 3/4	6 17/32	7 7/8	1 1/4	PF 1 1/2	3/8	3.063	1.311								
75	117	70	166	200	32	PF 1 1/2	9.5	77.8	33.3								

Remarks 1. In Part No. of unit and units with covers, fitting codes follow bore diameter numbers. (See Table 10.5 in P.42.)

2. Part No. of applicable grease nipples are shown below.

A-1/4-28UNF..... 201~210

A-PT1/8..... 211~215

3. As for the triple seal type product (from 201 to 205 are the double seal type products), accessory code L3 (or L2) follows the Part No. of unit or bearing. (Example of Part No. : UCHA206JL3, UC206L3)

4. For the dimensions and forms of applicable bearings and adapters, see the dimensional tables of ball bearing for unit and adapter.

5. Tapered bore (with adapter) type products are also available. (Example of Part No. : UKHA205J + H305X, UK205 + H305X)

Ball bearing inserts

UC, SB, SU
Cylindrical bore (with set screws)
d 8 ~ (30) mm

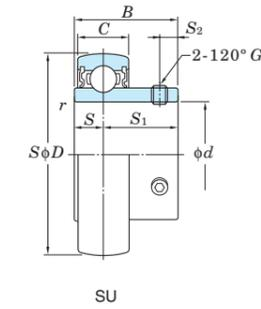
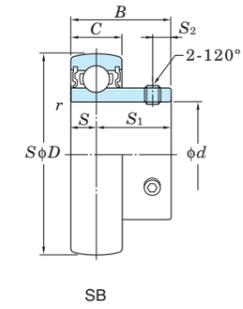
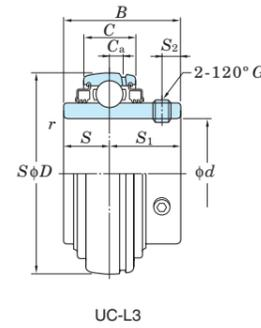
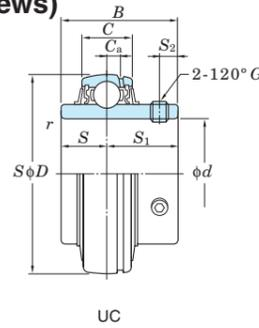

Shaft Dia. mm inch d	Dimensions								Basic Load Ratings kN			Factor f ₀	Bearing No.		Dimensions								Set Screw Brg. Bore G		Mass kg
	D		B		C		r (min.)		C _r	C _{0r}	C _a		S	S ₁		S ₂		mm	inch						
	mm	inch	mm	inch	mm	inch	mm	inch						mm	inch	mm	inch			mm	inch	mm	inch		
8	22	0.866	12	0.472	7	0.276	0.3	0.012	3.27	1.37	12.4	SU08	-	-	-	3.5	0.138	8.5	0.335	2.8	0.110	M3x0.35	-	0.012	
10	26	1.024	15	0.591	8	0.315	0.3	0.012	4.55	1.95	12.3	SU000	-	-	-	5	0.197	10	0.394	3	0.118	M3x0.35	-	0.024	
12	28	1.102	15	0.591	8	0.315	0.3	0.012	5.10	2.40	13.2	SU001	-	-	-	5	0.197	10	0.394	3	0.118	M3x0.35	-	0.026	
	40	1.575	22	0.866	12	0.472	0.6	0.024	9.55	4.80	13.2	SB201	-	-	-	6	0.236	16	0.630	4	0.157	M5x0.5	-	0.10	
-	47	1.850	31	1.220	16	0.630	0.6	0.024	12.8	6.65	13.2	UC201	UC201L2	4	0.157	12.7	0.500	18.3	0.720	5	0.197	M6x0.75	-	0.21	
	40	1.575	22	0.866	12	0.472	0.6	0.024	9.55	4.80	13.2	SB201-8	-	-	-	6	0.236	16	0.630	4	0.157	-	No.10-32UNF	0.10	
-	47	1.850	31	1.220	16	0.630	0.6	0.024	12.8	6.65	13.2	UC201-8	UC201-8L2	4	0.157	12.7	0.500	18.3	0.720	5	0.197	-	1/4-28UNF	0.21	
	32	1.260	16.5	0.650	9	0.354	0.3	0.012	5.60	2.85	13.9	SU002	-	-	-	5.5	0.217	11	0.433	3.3	0.130	M4x0.5	-	0.038	
15	40	1.575	22	0.866	12	0.472	0.6	0.024	9.55	4.80	13.2	SB202	-	-	-	6	0.236	16	0.630	4	0.157	M5x0.5	-	0.10	
	47	1.850	31	1.220	16	0.630	0.6	0.024	12.8	6.65	13.2	UC202	UC202L2	4	0.157	12.7	0.500	18.3	0.720	5	0.197	M6x0.75	-	0.19	
-	40	1.575	22	0.866	12	0.472	0.6	0.024	9.55	4.80	13.2	SB202-10	-	-	-	6	0.236	16	0.630	4	0.157	-	No.10-32UNF	0.10	
	47	1.850	31	1.220	16	0.630	0.6	0.024	12.8	6.65	13.2	UC202-10	UC202-10L2	4	0.157	12.7	0.500	18.3	0.720	5	0.197	-	1/4-28UNF	0.19	
17	35	1.378	17.5	0.689	10	0.394	0.3	0.012	6.00	3.25	14.4	SU003	-	-	-	6	0.236	11.5	0.453	3.3	0.130	M4x0.5	-	0.050	
	40	1.575	22	0.866	12	0.472	0.6	0.024	9.55	4.80	13.2	SB203	-	-	-	6	0.236	16	0.630	4	0.157	M5x0.5	-	0.10	
-	47	1.850	31	1.220	16	0.630	0.6	0.024	12.8	6.65	13.2	UC203	UC203L2	4	0.157	12.7	0.500	18.3	0.720	5	0.197	M6x0.75	-	0.18	
	47	1.850	25	0.984	14	0.551	1	0.039	12.8	6.65	13.2	SB204-12	-	-	-	7	0.276	18	0.709	5	0.197	-	1/4-28UNF	0.15	
-	47	1.850	31	1.220	16	0.630	1	0.039	12.8	6.65	13.2	UC204-12	UC204-12L2	4	0.157	12.7	0.500	18.3	0.720	5	0.197	-	1/4-28UNF	0.16	
	42	1.654	21	0.827	12	0.472	0.6	0.024	9.40	5.05	13.9	SU004	-	-	-	7	0.276	14	0.551	4	0.157	M5x0.5	-	0.080	
20	47	1.850	25	0.984	14	0.551	1	0.039	12.8	6.65	13.2	SB204	-	-	-	7	0.276	18	0.709	5	0.197	M6x0.75	-	0.15	
	47	1.850	31	1.220	16	0.630	1	0.039	12.8	6.65	13.2	UC204	UC204L2	4	0.157	12.7	0.500	18.3	0.720	5	0.197	M6x0.75	-	0.16	
-	52	2.047	27	1.063	15	0.591	1	0.039	14.0	7.85	13.9	SB205-14	-	-	-	7.5	0.295	19.5	0.768	5.5	0.217	-	1/4-28UNF	0.18	
	52	2.047	34.1	1.343	17	0.669	1	0.039	14.0	7.85	13.9	UC205-14	UC205-14L2	5	0.197	14.3	0.563	19.8	0.780	5.5	0.217	-	1/4-28UNF	0.23	
-	52	2.047	27	1.063	15	0.591	1	0.039	14.0	7.85	13.9	SB205-15	-	-	-	7.5	0.295	19.5	0.768	5.5	0.217	-	1/4-28UNF	0.18	
	52	2.047	34.1	1.343	17	0.669	1	0.039	14.0	7.85	13.9	UC205-15	UC205-15L2	5	0.197	14.3	0.563	19.8	0.780	5.5	0.217	-	1/4-28UNF	0.21	
25	47	1.850	22	0.866	12	0.472	0.6	0.024	10.1	5.85	14.5	SU005	-	-	-	7	0.276	15	0.591	4.5	0.177	M5x0.5	-	0.10	
	52	2.047	27	1.063	15	0.591	1	0.039	14.0	7.85	13.9	SB205	-	-	-	7.5	0.295	19.5	0.768	5.5	0.217	M6x0.75	-	0.18	
-	52	2.047	34.1	1.343	17	0.669	1	0.039	14.0	7.85	13.9	UC205	UC205L2	5	0.197	14.3	0.563	19.8	0.780	5.5	0.217	M6x0.75	-	0.20	
	62	2.441	38	1.496	22	0.866	1.1	0.043	21.2	10.9	12.6	UC305	-	-	-	6	0.236	15	0.591	23	0.906	6	0.236	M6x0.75	-
-	62	2.441	38.1	1.500	19	0.748	1	0.039	19.5	11.3	13.9	UCX05	UCX05L3	5	0.197	15.9	0.626	22.2	0.874	6	0.236	M6x0.75	-	0.39	
	52	2.047	27	1.063	15	0.591	1	0.039	14.0	7.85	13.9	SB205-16	-	-	-	7.5	0.295	19.5	0.768	5.5	0.217	-	1/4-28UNF	0.18	
-	52	2.047	34.1	1.343	17	0.669	1	0.039	14.0	7.85	13.9	UC205-16	UC205-16L2	5	0.197	14.3	0.563	19.8	0.780	5.5	0.217	-	1/4-28UNF	0.20	
	62	2.441	38	1.496	22	0.866	1.1	0.043	21.2	10.9	12.6	UC305-16	-	-	-	6	0.236	15	0.591	23	0.906	6	0.236	M6x0.75	-
-	62	2.441	38.1	1.500	19	0.748	1	0.039	19.5	11.3	13.9	UCX05-16	UCX05-16L3	5	0.197	15.9	0.626	22.2	0.874	6	0.236	-	1/4-28UNF	0.38	
	62	2.441	30	1.181	16	0.630	1	0.039	19.5	11.3	13.9	SB206-18	-	-	-	8	0.315	22	0.866	6	0.236	-	1/4-28UNF	0.27	
-	62	2.441	38.1	1.500	19	0.748	1	0.039	19.5	11.3	13.9	UC206-18	UC206-18L2	5	0.197	15.9	0.626	22.2	0.874	6	0.236	-	1/4-28UNF	0.34	
	55	2.165	24.5	0.965	13	0.512	1	0.039	13.2	8.25	14.7	SU006	-	-	-	7.5	0.295	17	0.669	5.5	0.217	M5x0.5	-	0.15	
30	62	2.441	30	1.181	16	0.630	1	0.039	19.5	11.3	13.9	SB206	-	-	-	8	0.315	22	0.866	6	0.236	M6x0.75	-	0.27	
	62	2.441	38.1	1.500	19	0.748	1	0.039	19.5	11.3	13.9	UC206	UC206L3	5	0.197	15.9	0.626	22.2	0.874	6	0.236	M6x0.75	-	0.32	
-	72	2.835	42.9	1.689	20	0.787	1	0.039	25.7	15.4	13.9	UCX06	UCX06L3	5.5	0.217	17.5	0.689	25.4	1.000	6.5	0.256	M8x1	-	0.58	
	72	2.835	43	1.693	24	0.945	1.1	0.043	26.7	15.0	13.3	UC306	-	-	-	6.5	0.256	17	0.669	26	1.024	6	0.236	M6x0.75	-
-	62	2.441	30	1.181	16	0.630	1	0.039	19.5	11.3	13.9	SB206-19	-	-	-	8	0.315	22	0.866	6	0.236	-	1/4-28UNF	0.27	
	62	2.441	38.1	1.500	19	0.748	1	0.039	19.5	11.3	13.9	UC206-19	UC206-19L2	5	0.197	15.9	0.626	22.2	0.874	6	0.236	-	1/4-28UNF	0.32	
-	72	2.835	42.9	1.689	20	0.787	1	0.039	25.7	15.4	13.9	UCX06-19	UCX06-19L3	5.5	0.217	17.5	0.689	25.4	1.000	6.5	0.256	-	5/16-28UNF	0.58	
	62	2.441	30	1.181	16	0.630	1	0.039	19.5	11.3	13.9	SB206-20	-	-	-	8	0.315	22	0.866	6	0.236	-	1/4-28UNF	0.27	
-	62	2.441	38.1	1.500	19	0.748	1	0.039	19.5	11.3	13.9	UC206-20	UC206-20L2	5	0.197	15.9	0.626	22.2	0.874	6	0.236	-	1/4-28UNF	0.30	
	72	2.835	42.9	1.689	20	0.787	1	0.039	25.7	15.4	13.9	UCX06-20	UCX06-20L3	5.5	0.217	17.5	0.689	25.4	1.000	6.5	0.256	-	5/16-24UNF	0.55	
-	72	2.835	32	1.260	17	0.669	1.1	0.043	25.7	15.4	13.9	SB207-20	-	-	-	8.5	0.335	23.5	0.925	6	0.236	-	1/4-28UNF	0.42	
	72	2.835	42.9	1.689	20	0.787	1.1	0.043	25.7	15.4															

Ball bearing inserts

UC, SB, SU
Cylindrical bore (with set screws)
d (30) ~ (60) mm

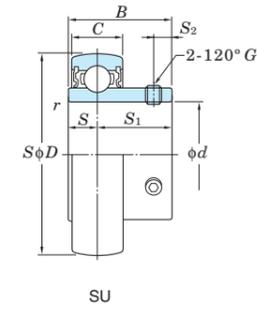
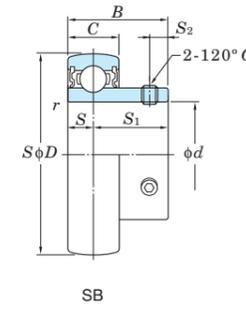
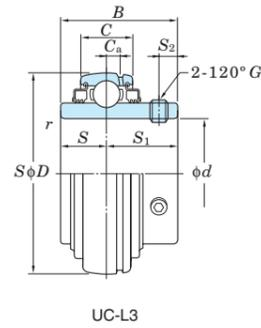
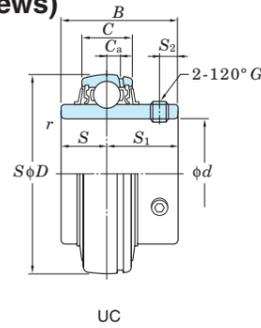

Shaft Dia. mm inch d	Dimensions							Basic Load Ratings kN		Factor f ₀	Bearing No.		Dimensions							Set Screw Brg. Bore G		Mass kg			
	D		B		C		r (min.)		C _r		C _{0r}	Standard	L3 Type	C _a		S		S ₁		S ₂			mm	inch	
	mm	inch	mm	inch	mm	inch	mm	inch						mm	inch	mm	inch	mm	inch	mm	inch				mm
-	1 3/8	72	2.835	32	1.260	17	0.669	1.1	0.043	25.7	15.4	13.9	SB207-22	-	-	-	8.5	0.335	23.5	0.925	6	0.236	-	1/4-28UNF	0.42
		72	2.835	42.9	1.689	20	0.787	1.1	0.043	25.7	15.4	13.9	UC207-22	UC207-22L3	5.5	0.217	17.5	0.689	25.4	1.000	6.5	0.256	-	5/16-24UNF	0.48
		80	3.150	49.2	1.937	21	0.827	1.1	0.043	29.1	17.8	14.0	UCX07-22	UCX07-22L3	6	0.236	19	0.748	30.2	1.189	8	0.315	-	5/16-28UNF	0.75
35	-	72	2.835	32	1.260	17	0.669	1.1	0.043	25.7	15.4	13.9	SB207	-	-	-	8.5	0.335	23.5	0.925	6	0.236	M6x0.75	-	0.42
		72	2.835	42.9	1.689	20	0.787	1.1	0.043	25.7	15.4	13.9	UC207	UC207L3	5.5	0.217	17.5	0.689	25.4	1.000	6.5	0.256	M8x1	-	0.48
		80	3.150	49.2	1.937	21	0.827	1.1	0.043	29.1	17.8	14.0	UCX07	UCX07L3	6	0.236	19	0.748	30.2	1.189	8	0.315	M8x1	-	0.75
		80	3.150	48	1.890	26	1.024	1.5	0.059	33.4	19.3	13.2	UC307	UC307L3	7.5	0.295	19	0.748	29	1.142	8	0.315	M8x1	-	0.71
-	1 7/16	72	2.835	32	1.260	17	0.669	1.1	0.043	25.7	15.4	13.9	SB207-23	-	-	-	8.5	0.335	23.5	0.925	6	0.236	-	1/4-28UNF	0.42
		72	2.835	42.9	1.689	20	0.787	1.1	0.043	25.7	15.4	13.9	UC207-23	UC207-23L3	5.5	0.217	17.5	0.689	25.4	1.000	6.5	0.256	-	5/16-28UNF	0.45
		80	3.150	49.2	1.937	21	0.827	1.1	0.043	29.1	17.8	14.0	UCX07-23	UCX07-23L3	6	0.236	19	0.748	30.2	1.189	8	0.315	-	5/16-28UNF	0.72
-	1 1/2	80	3.150	34	1.339	18	0.709	1.1	0.043	29.1	17.8	14.0	SB208-24	-	-	-	9	0.354	25	0.984	8	0.315	-	5/16-24UNF	0.60
		80	3.150	49.2	1.937	21	0.827	1.1	0.043	29.1	17.8	14.0	UC208-24	UC208-24L3	6	0.236	19	0.748	30.2	1.189	8	0.315	-	5/16-24UNF	0.68
		85	3.346	49.2	1.937	22	0.866	1.1	0.043	34.1	21.3	14.0	UCX08-24	UCX08-24L3	6	0.236	19	0.748	30.2	1.189	8	0.315	-	5/16-28UNF	0.87
-	1 9/16	90	3.543	52	2.047	28	1.102	1.5	0.059	40.7	24.0	13.2	UC308-24	UC308-24L3	8	0.315	19	0.748	33	1.299	10	0.394	M10x1.25	-	1.05
		80	3.150	49.2	1.937	21	0.827	1.1	0.043	29.1	17.8	14.0	UC208-25	UC208-25L3	6	0.236	19	0.748	30.2	1.189	8	0.315	-	5/16-24UNF	0.60
		80	3.150	34	1.339	18	0.709	1.1	0.043	29.1	17.8	14.0	SB208	-	-	-	9	0.354	25	0.984	8	0.315	M8x1	-	0.60
40	-	80	3.150	49.2	1.937	21	0.827	1.1	0.043	29.1	17.8	14.0	UC208	UC208L3	6	0.236	19	0.748	30.2	1.189	8	0.315	M8x1	-	0.64
		85	3.346	49.2	1.937	22	0.866	1.1	0.043	34.1	21.3	14.0	UCX08	UCX08L3	6	0.236	19	0.748	30.2	1.189	8	0.315	M8x1	-	0.83
		90	3.543	52	2.047	28	1.102	1.5	0.059	40.7	24.0	13.2	UC308	UC308L3	8	0.315	19	0.748	33	1.299	10	0.394	M10x1.25	-	1.00
		85	3.346	49.2	1.937	22	0.866	1.1	0.043	34.1	21.3	14.0	UC209-26	UC209-26L3	6	0.236	19	0.748	30.2	1.189	8	0.315	-	5/16-24UNF	0.78
-	1 11/16	85	3.346	49.2	1.937	22	0.866	1.1	0.043	34.1	21.3	14.0	UC209-27	UC209-27L3	6	0.236	19	0.748	30.2	1.189	8	0.315	-	5/16-24UNF	0.74
		85	3.346	49.2	1.937	22	0.866	1.1	0.043	34.1	21.3	14.0	UC209-28	UC209-28L3	6	0.236	19	0.748	30.2	1.189	8	0.315	-	5/16-24UNF	0.70
		90	3.543	51.6	2.031	24	0.945	1.1	0.043	35.1	23.3	14.4	UCX09-28	UCX09-28L3	6	0.236	19	0.748	32.6	1.283	9	0.354	-	3/8-24UNF	0.97
-	1 3/4	100	3.937	57	2.244	30	1.181	1.5	0.059	48.9	29.5	13.3	UC309-28	UC309-28L3	8.5	0.335	22	0.866	35	1.378	10	0.394	M10x1.25	-	1.35
		85	3.346	49.2	1.937	22	0.866	1.1	0.043	34.1	21.3	14.0	UC209	UC209L3	6	0.236	19	0.748	30.2	1.189	8	0.315	M8x1	-	0.68
		90	3.543	51.6	2.031	24	0.945	1.1	0.043	35.1	23.3	14.4	UCX09	UCX09L3	6	0.236	19	0.748	32.6	1.283	9	0.354	M10x1.25	-	0.95
-	1 7/8	100	3.937	57	2.244	30	1.181	1.5	0.059	48.9	29.5	13.3	UC309	UC309L3	8.5	0.335	22	0.866	35	1.378	10	0.394	M10x1.25	-	1.33
		90	3.543	51.6	2.031	24	0.945	1.1	0.043	35.1	23.3	14.4	UC210-30	UC210-30L3	6	0.236	19	0.748	32.6	1.283	9	0.354	-	3/8-24UNF	0.87
		90	3.543	51.6	2.031	24	0.945	1.1	0.043	35.1	23.3	14.4	UC210-31	UC210-31L3	6	0.236	19	0.748	32.6	1.283	9	0.354	-	3/8-24UNF	0.82
-	1 15/16	100	3.937	55.6	2.189	25	0.984	1.1	0.043	43.4	29.4	14.4	UCX10-31	UCX10-31L3	7	0.276	22.2	0.874	33.4	1.315	9	0.354	-	3/8-24UNF	1.32
		90	3.543	51.6	2.031	24	0.945	1.1	0.043	35.1	23.3	14.4	UC210	UC210L3	6	0.236	19	0.748	32.6	1.283	9	0.354	M10x1.25	-	0.80
		100	3.937	55.6	2.189	25	0.984	1.1	0.043	43.4	29.4	14.4	UCX10	UCX10L3	7	0.276	22.2	0.874	33.4	1.315	9	0.354	M10x1.25	-	1.29
-	2	110	4.331	61	2.402	32	1.260	2	0.079	62.0	38.3	13.2	UC310	UC310L3	9	0.354	22	0.866	39	1.535	12	0.472	M12x1.5	-	1.69
		90	3.543	51.6	2.031	24	0.945	1.1	0.043	35.1	23.3	14.4	UC210-32	UC210-32L3	6	0.236	19	0.748	32.6	1.283	9	0.354	-	3/8-24UNF	0.78
		100	3.937	55.6	2.189	25	0.984	1.1	0.043	43.4	29.4	14.4	UCX10-32	UCX10-32L3	7	0.276	22.2	0.874	33.4	1.315	9	0.354	-	3/8-24UNF	1.26
-	2	100	3.937	55.6	2.189	25	0.984	1.5	0.059	43.4	29.4	14.4	UC211-32	UC211-32L3	7	0.276	22.2	0.874	33.4	1.315	9	0.354	-	3/8-24UNF	1.26
		120	4.724	66	2.598	34	1.339	2	0.079	71.6	45.0	13.2	UC311-32	UC311-32L3	10	0.394	25	0.984	41	1.614	12	0.472	M12x1.5	-	2.08
		100	3.937	55.6	2.189	25	0.984	1.5	0.059	43.4	29.4	14.4	UC211-34	UC211-34L3	7	0.276	22.2	0.874	33.4	1.315	9	0.354	-	3/8-24UNF	1.15
55	-	100	3.937	55.6	2.189	25	0.984	1.5	0.059	43.4	29.4	14.4	UC211	UC211L3	7	0.276	22.2	0.874	33.4	1.315	9	0.354	M10x1.25	-	1.11
		110	4.331	65.1	2.563	27	1.063	1.5	0.059	52.4	36.2	14.4	UCX11	UCX11L3	7.5	0.295	25.4	1.000	39.7	1.563	10.5	0.413	M10x1.25	-	1.80
		120	4.724	66	2.598	34	1.339	2	0.079	71.6	45.0	13.2	UC311	UC311L3	10	0.394	25	0.984	41	1.614	12	0.472	M12x1.5	-	1.90
-	2 3/16	100	3.937	55.6	2.189	25	0.984	1.5	0.059	43.4	29.4	14.4	UC211-35	UC211-35L3	7	0.276	22.2	0.874	33.4	1.315	9	0.354	-	3/8-24UNF	1.09
		110	4.331	65.1	2.563	27	1.063	1.5	0.059	52.4	36.2	14.4	UCX11-35	UCX11-35L3	7.5	0.295	25.4	1.000	39.7	1.563	10.5	0.413	-	3/8-24UNF	1.78
		110	4.331	65.1	2.563	27	1.063	1.5	0.059	52.4	36.2	14.4	UCX11-36	UCX11-36L3	7.5	0.295	25.4	1.000	39.7	1.563	10.5	0.413	-	3/8-24UNF	1.7
-	2 1/4	110	4.331	65.1	2.563	27	1.063	1.5	0.059	52.4	36.2	14.4	UC212-36	UC212-36L3	7.5	0.295	25.4	1.000	39.7	1.563	10.5	0.413	-	3/8-24UNF	1.67
		110	4.331	65.1	2.563</																				

Ball bearing inserts

UC, SB, SU
Cylindrical bore (with set screws)
d (60) ~ 140 mm

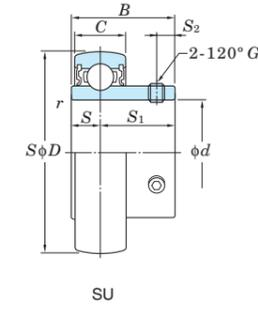
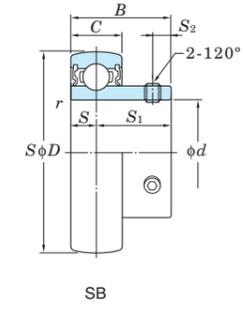
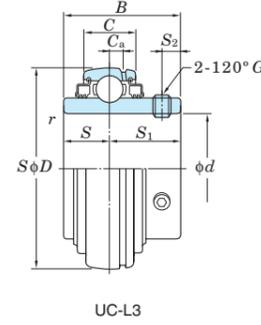
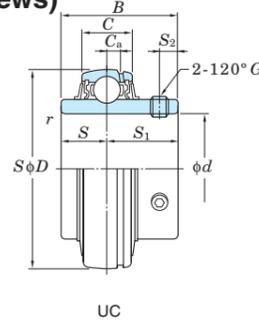

Shaft Dia. mm inch	Dimensions								Basic Load Ratings		Factor f ₀	Bearing No.		Dimensions								Set Screw Brg. Bore G		Mass kg	
	d	D		B		C		r (min.)		C _r		C _{0r}	Standard	L3 Type	C _a		S		S ₁		S ₂		mm		inch
		mm	inch	mm	inch	mm	inch	mm	inch						mm	inch	mm	inch	mm	inch	mm	inch			
-	2 7/16	110	4.331	65.1	2.563	27	1.063	1.5	0.059	52.4	36.2	14.4	UC212-39	UC212-39L3	7.5	0.295	25.4	1.000	39.7	1.563	10.5	0.413	-	3/8-24UNF	1.45
		120	4.724	65.1	2.563	28	1.102	1.5	0.059	57.2	40.1	14.4	UCX12-39	UCX12-39L3	7.5	0.295	25.4	1.000	39.7	1.563	12	0.472	-	1/2-20UNF	1.95
-	2 1/2	120	4.724	65.1	2.563	28	1.102	1.5	0.059	57.2	40.1	14.4	UC213-40	UC213-40L3	7.5	0.295	25.4	1.000	39.7	1.563	12	0.472	-	1/2-20UNF	1.94
		125	4.921	74.6	2.937	30	1.181	1.5	0.059	62.2	44.1	14.5	UCX13-40	UCX13-40L3	9	0.354	30.2	1.189	44.4	1.748	12	0.472	-	1/2-20UNF	2.61
		140	5.512	75	2.953	38	1.496	2.1	0.083	92.7	59.9	13.2	UC313-40	UC313-40L3	12	0.472	30	1.181	45	1.772	12	0.472	M12x1.5	-	3.24
65	-	120	4.724	65.1	2.563	28	1.102	1.5	0.059	57.2	40.1	14.4	UC213	UC213L3	7.5	0.295	25.4	1.000	39.7	1.563	12	0.472	M12x1.5	-	1.86
		125	4.921	74.6	2.937	30	1.181	1.5	0.059	62.2	44.1	14.5	UCX13	UCX13L3	9	0.354	30.2	1.189	44.4	1.748	12	0.472	M12x1.5	-	2.52
		140	5.512	75	2.953	38	1.496	2.1	0.083	92.7	59.9	13.2	UC313	UC313L3	12	0.472	30	1.181	45	1.772	12	0.472	M12x1.5	-	3.16
-	2 3/4	125	4.921	74.6	2.937	30	1.181	1.5	0.059	62.2	44.1	14.5	UC214-44	UC214-44L3	9	0.354	30.2	1.189	44.4	1.748	12	0.472	-	1/2-20UNF	2.06
		130	5.118	77.8	3.063	32	1.260	1.5	0.059	67.4	48.3	14.5	UCX14-44	UCX14-44L3	9	0.354	33.3	1.311	44.5	1.752	12	0.472	-	1/2-20UNF	2.75
		150	5.906	78	3.071	40	1.575	2.1	0.083	104	68.2	13.2	UC314-44	UC314-44L3	12.5	0.492	33	1.299	45	1.772	12	0.472	M12x1.5	-	3.91
70	-	125	4.921	74.6	2.937	30	1.181	1.5	0.059	62.2	44.1	14.5	UC214	UC214L3	9	0.354	30.2	1.189	44.4	1.748	12	0.472	M12x1.5	-	2.05
		130	5.118	77.8	3.063	32	1.260	1.5	0.059	67.4	48.3	14.5	UCX14	UCX14L3	9	0.354	33.3	1.311	44.5	1.752	12	0.472	M12x1.5	-	2.74
		150	5.906	78	3.071	40	1.575	2.1	0.083	104	68.2	13.2	UC314	UC314L3	12.5	0.492	33	1.299	45	1.772	12	0.472	M12x1.5	-	3.90
-	2 15/16	130	5.118	77.8	3.063	32	1.260	1.5	0.059	67.4	48.3	14.5	UC215-47	UC215-47L3	9	0.354	33.3	1.311	44.5	1.752	12	0.472	-	1/2-20UNF	2.23
		140	5.512	82.6	3.252	33	1.299	1.5	0.059	72.7	53.0	14.6	UCX15-47	UCX15-47L3	9	0.354	33.3	1.311	49.3	1.941	14	0.551	-	1/2-20UNF	3.43
		160	6.299	82	3.228	42	1.654	2.1	0.083	113	77.2	13.2	UC315-47	UC315-47L3	14.5	0.571	32	1.260	50	1.969	14	0.551	M14x1.5	-	4.72
75	-	130	5.118	77.8	3.063	32	1.260	1.5	0.059	67.4	48.3	14.5	UC215	UC215L3	9	0.354	33.3	1.311	44.5	1.752	12	0.472	M12x1.5	-	2.21
		140	5.512	82.6	3.252	33	1.299	1.5	0.059	72.7	53.0	14.6	UCX15	UCX15L3	9	0.354	33.3	1.311	49.3	1.941	14	0.551	M12x1.5	-	3.41
		160	6.299	82	3.228	42	1.654	2.1	0.083	113	77.2	13.2	UC315	UC315L3	14.5	0.571	32	1.260	50	1.969	14	0.551	M14x1.5	-	4.70
-	3	130	5.118	77.8	3.063	32	1.260	1.5	0.059	67.4	48.3	14.5	UC215-48	UC215-48L3	9	0.354	33.3	1.311	44.5	1.752	12	0.472	-	1/2-20UNF	2.12
		140	5.512	82.6	3.252	33	1.299	1.5	0.059	72.7	53.0	14.6	UCX15-48	UCX15-48L3	9	0.354	33.3	1.311	49.3	1.941	14	0.551	-	1/2-20UNF	3.32
		160	6.299	82	3.228	42	1.654	2.1	0.083	113	77.2	13.2	UC315-48	UC315-48L3	14.5	0.571	32	1.260	50	1.969	14	0.551	M14x1.5	-	4.61
-	3 1/8	140	5.512	82.6	3.252	33	1.299	2	0.079	72.7	53.0	14.6	UC216-50	UC216-50L3	9	0.354	33.3	1.311	49.3	1.941	14	0.551	-	1/2-20UNF	2.84
80	-	140	5.512	82.6	3.252	33	1.299	2	0.079	72.7	53.0	14.6	UC216	UC216L3	9	0.354	33.3	1.311	49.3	1.941	14	0.551	M12x1.5	-	2.79
		150	5.906	85.7	3.374	35	1.378	2	0.079	84.0	61.9	14.5	UCX16	UCX16L3	10	0.394	34.1	1.343	51.6	2.031	14	0.551	M12x1.5	-	3.87
		170	6.693	86	3.386	44	1.732	2.1	0.083	123	86.7	13.3	UC316	UC316L3	15	0.591	34	1.339	52	2.047	14	0.551	M14x1.5	-	5.60
-	3 1/4	150	5.906	85.7	3.374	35	1.378	2	0.079	84.0	61.9	14.5	UC217-52	UC217-52L3	10	0.394	34.1	1.343	51.6	2.031	14	0.551	-	1/2-20UNF	3.66
85	-	150	5.906	85.7	3.374	35	1.378	2	0.079	84.0	61.9	14.5	UC217	UC217L3	10	0.394	34.1	1.343	51.6	2.031	14	0.551	M12x1.5	-	3.45
		160	6.299	96	3.780	38	1.496	2	0.079	96.1	71.5	14.5	UCX17	UCX17L3	11	0.433	39.7	1.563	56.3	2.217	15	0.591	M12x1.5	-	5.05
		180	7.087	96	3.780	46	1.811	3	0.118	133	96.8	13.3	UC317	UC317L3	15	0.591	40	1.575	56	2.205	16	0.630	M16x1.5	-	6.90
-	3 7/16	160	6.299	96	3.780	38	1.496	2	0.079	96.1	71.5	14.5	UCX17-55	UCX17-55L3	11	0.433	39.7	1.563	56.3	2.217	15	0.591	-	1/2-20UNF	4.80
-	3 1/2	160	6.299	96	3.780	38	1.496	2	0.079	96.1	71.5	14.5	UC218-56	UC218-56L3	11	0.433	39.7	1.563	56.3	2.217	15	0.591	-	1/2-20UNF	4.46
		190	7.480	96	3.780	48	1.890	3	0.118	143	107	13.3	UC318-56	UC318-56L3	15.5	0.610	40	1.575	56	2.205	16	0.630	M16x1.5	-	8.03
		160	6.299	96	3.780	38	1.496	2	0.079	96.1	71.5	14.5	UC218	UC218L3	11	0.433	39.7	1.563	56.3	2.217	15	0.591	M12x1.5	-	4.35
90	-	170	6.693	104	4.094	40	1.575	2	0.079	109	81.9	14.4	UCX18	-	11.5	0.453	42.9	1.689	61.1	2.406	16	0.630	M14x1.5	-	6.00
		190	7.480	96	3.780	48	1.890	3	0.118	143	107	13.3	UC318	UC318L3	15.5	0.610	40	1.575	56	2.205	16	0.630	M16x1.5	-	7.87
		200	7.874	103	4.055	50	1.969	3	0.118	153	119	13.3	UC319	UC319L3	16.5	0.650	41	1.614	62	2.441	18	0.709	M16x1.5	-	8.91
100	-	190	7.480	117.5	4.626	43	1.693	2.1	0.083	133	105	14.4	UCX20	-	13	0.512	49.2	1.937	68.3	2.689	18	0.709	M16x1.5	-	8.56
		215	8.465	108	4.252	54	2.126	3	0.118	173	141	13.2	UC320	UC320L3	18	0.709	42	1.654	66	2.598	20	0.787	M18x1.5	-	11.2
		190	7.480	117.5	4.626	43	1.693	2.1	0.083	133	105	14.4	UCX20-63	-	13	0.512	49.2	1.937	68.3	2.689	18	0.709	-	5/8-18UNF	8.56
-	3 15/16	215	8.465	108	4.252	54	2.126	3	0.118	173	141	13.2	UC320-63	UC320-63L3	18	0.709	42	1.654	66	2.598	20	0.787	M18x1.5	-	11.2
		190	7.480	117.5	4.626	43	1.693	2.1	0.083	133	105	14.4	UCX20-64	-	13	0.512	49.2	1.937	68.3	2.689	18	0.709	-	5/8-18UNF	8.33
		215	8.465	108	4.252	54	2.126	3	0.118	173	141	13.2	UC320-64	UC320-64L3	18	0.709	42	1.654	66	2.598	20	0.787	M18x1.5	-	11.0
105	-	225	8.858	112	4.409	56	2.205	3	0.118	184	153	13.2	UC321	-	19	0.748	44	1.732	68	2.677	20	0.787	M18x1.5		

Ball bearing inserts

UC-S6, SU-S6 (Stainless steel series)
Cylindrical bore (with set screws)
d 10 ~ 50 mm

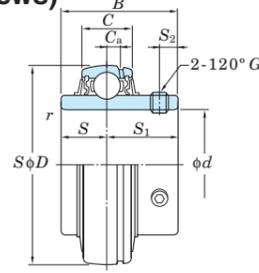

UC-S6

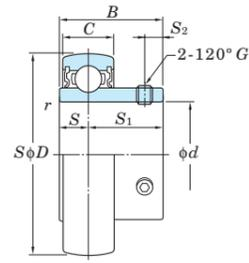

SU-S6

Shaft Dia. mm <i>d</i>	Dimensions							Basic Load Ratings kN		Factor <i>f₀</i>	Bearing No.	Dimensions						Set Screw Dia. <i>G</i>	Mass kg			
	<i>D</i>		<i>B</i>		<i>C</i>		<i>r</i> (min.)		<i>C_r</i>			<i>C_{0r}</i>	<i>C_a</i>	<i>S</i>		<i>S₁</i>				<i>S₂</i>		
	mm	inch	mm	inch	mm	inch	mm	inch			mm	inch	mm	inch	mm	inch	mm	inch				
10	26	1.024	15	0.591	8	0.315	0.3	0.012	3.9	1.55	12.3	SU000S6	-	-	5	0.197	10	0.394	3	0.118	M3×0.35	0.024
12	28	1.102	15	0.591	8	0.315	0.3	0.012	4.3	1.9	13.2	SU001S6	-	-	5	0.197	10	0.394	3	0.118	M3×0.35	0.026
15	32	1.260	16.5	0.650	9	0.354	0.3	0.012	4.7	2.25	13.9	SU002S6	-	-	5.5	0.217	11	0.433	3.3	0.130	M4×0.5	0.038
17	35	1.378	17.5	0.689	10	0.394	0.3	0.012	5.1	2.6	14.4	SU003S6	-	-	6	0.236	11.5	0.453	3.3	0.130	M4×0.5	0.050
20	42	1.654	21	0.827	12	0.472	0.6	0.024	7.9	4	13.9	SU004S6	-	-	7	0.276	14	0.551	4	0.157	M5×0.5	0.080
	47	1.850	31	1.220	16	0.630	1	0.039	10.9	5.35	13.2	UC204S6	4	0.158	12.7	0.500	18.3	0.720	5	0.197	M6×0.75	0.16
25	47	1.850	22	0.866	12	0.472	0.6	0.024	8.5	4.65	14.5	SU005S6	-	-	7	0.276	15	0.591	4.5	0.177	M5×0.5	0.10
	52	2.047	34.1	1.343	17	0.669	1	0.039	11.9	6.3	13.9	UC205S6	5	0.197	14.3	0.563	19.8	0.780	5.5	0.217	M6×0.75	0.20
30	55	2.165	24.5	0.965	13	0.512	1	0.039	11.2	6.6	14.7	SU006S6	-	-	7.5	0.295	17	0.669	5.5	0.217	M5×0.5	0.15
	62	2.441	38.1	1.500	19	0.748	1	0.039	16.5	9.05	13.9	UC206S6	5	0.197	15.9	0.626	22.2	0.874	6	0.236	M6×0.75	0.32
35	72	2.835	42.9	1.689	20	0.787	1.1	0.043	21.8	12.3	13.9	UC207S6	5.5	0.217	17.5	0.689	25.4	1.000	6.5	0.256	M8×1	0.48
40	80	3.150	49.2	1.937	21	0.827	1.1	0.043	24.8	14.3	14.0	UC208S6	6	0.236	19	0.748	30.2	1.189	8	0.315	M8×1	0.64
45	85	3.346	49.2	1.937	22	0.866	1.1	0.043	27.8	16.2	14.0	UC209S6	6	0.236	19	0.748	30.2	1.189	8	0.315	M8×1	0.68
50	90	3.543	51.6	2.031	24	0.945	1.1	0.043	29.8	18.6	14.4	UC210S6	6	0.236	19	0.748	32.6	1.283	8	0.315	M8×1	0.80

Remark S6 series product is the stainless steel series ball bearing for unit.

Ball bearing inserts

UK
Tapered bore (with adapter)
d₁ 20 ~ (50) mm

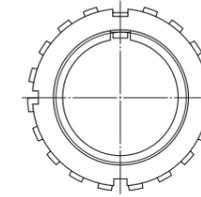
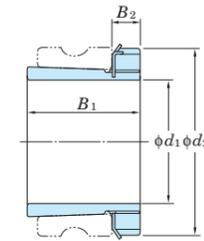
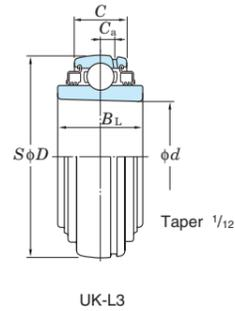
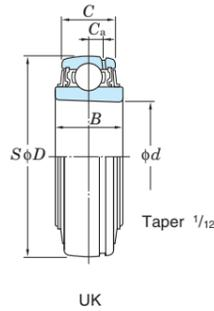

Adapter

Shaft Dia. mm inch	Dimensions inch mm							Basic Load Ratings kN		Factor f ₀	Bearing		Mass kg	H3 Series Adapter				H23 Series Adapter						
	d ₁	d	D	B	B _L	C	C _α	C _r	C _{0r}		No. Standard L3 Type	No. Standard L3 Type		Adapter No.	Dimensions inch mm			Mass kg	Sleeve No.	Adapter No.	Dimensions inch mm			Mass kg
20	3/4	0.984 25	2.047 52	0.827 21	0.945 24	0.669 17	0.197 5	14.0	7.85	13.9	UK205 UK205L2	0.16 0.18	HE305X H305X	1.142 29	0.315 8	1.496 38	0.075	AE305X A305X	HE2305X H2305X	1.378 35	0.315 8	1.496 38	0.095	AE2305X A2305X
	3/4	0.984 25	2.441 62	0.906 23	-	0.748 19	0.197 5	19.5	11.3	13.9	UKX05	-	0.27	-	-	-	-	-	HE2305X H2305X	1.378 35	0.315 8	1.496 38	0.095	AE2305X A2305X
	3/4	0.984 25	2.441 62	1.063 27	-	0.866 22	0.236 6	21.2	10.9	12.6	UK305	-	0.40	-	-	-	-	-	HE2305X H2305X	1.378 35	0.315 8	1.496 38	0.095	AE2305X A2305X
25	1	1.181 30	2.441 62	0.906 23	1.063 27	0.748 19	0.197 5	19.5	11.3	13.9	UK206 UK206L3	0.25 0.29	H306X HE306X	1.220 31	0.315 8	1.772 45	0.11	A306X AE306X	H2306X HE2306X	1.496 38	0.315 8	1.772 45	0.13	A2306X HE2306X
	1	1.181 30	2.835 72	1.024 26	-	0.787 20	0.217 5.5	25.7	15.4	13.9	UKX06	-	0.43	-	-	-	-	-	H2306X HE2306X	1.496 38	0.315 8	1.772 45	0.13	A2306X HE2306X
	1	1.181 30	2.835 72	1.181 30	-	0.945 24	0.256 6.5	26.7	15.0	13.3	UK306	-	0.47	-	-	-	-	-	H2306X HE2306X	1.496 38	0.315 8	1.772 45	0.13	A2306X HE2306X
30	1 1/8	1.378 35	2.835 72	1.024 26	1.181 30	0.787 20	0.217 5.5	25.7	15.4	13.9	UK207 UK207L3	0.37 0.43	HS307X H307X	1.378 35	0.354 9	2.047 52	0.14	AS307X A307X	HS2307X H2307X	1.693 43	0.354 9	2.047 52	0.17	AS2307X A2307X
	1 1/8	1.378 35	3.150 80	1.063 27	-	0.827 21	0.236 6	29.1	17.8	14.0	UKX07	-	0.53	-	-	-	-	-	HS2307X H2307X	1.693 43	0.354 9	2.047 52	0.17	AS2307X A2307X
	1 1/8	1.378 35	3.150 80	1.299 33	1.299 33	1.024 26	0.295 7.5	33.4	19.3	13.2	UK307 UK307L3	0.60 0.60	-	-	-	-	-	-	HS2307X H2307X	1.693 43	0.354 9	2.047 52	0.17	AS2307X A2307X
35	1 1/4	1.575 40	3.150 80	1.063 27	1.339 34	0.827 21	0.236 6	29.1	17.8	14.0	UK208 UK208L3	0.47 0.58	HE308X HS308X H308X	1.417 36	0.394 10	2.283 58	0.19	AE308X AS308X A308X	HE2308X HS2308X H2308X	1.811 46	0.394 10	2.283 58	0.22	AE2308X AS2308X A2308X
	1 1/4	1.575 40	3.346 85	1.142 29	-	0.866 22	0.236 6	34.1	21.3	14.0	UKX08	-	0.58	-	-	-	-	-	HE2308X HS2308X H2308X	1.811 46	0.394 10	2.283 58	0.22	AE2308X AS2308X A2308X
	1 1/4	1.575 40	3.543 90	1.378 35	1.378 35	1.102 28	0.315 8	40.7	24.0	13.2	UK308 UK308L3	0.80 0.80	-	-	-	-	-	-	HE2308X HS2308X H2308X	1.811 46	0.394 10	2.283 58	0.22	AE2308X AS2308X A2308X
40	1 1/2	1.772 45	3.346 85	1.142 29	1.417 36	0.866 22	0.236 6	34.1	21.3	14.0	UK209 UK209L3	0.52 0.65	HE309X H309X HS309X	1.535 39	0.433 11	2.559 65	0.25	AE309X A309X AS309X	HE2309X H2309X HS2309X	1.969 50	0.433 11	2.559 65	0.28	AE2309X A2309X AS2309X
	1 1/2	1.772 45	3.543 90	1.142 29	-	0.945 24	0.236 6	35.1	23.3	14.4	UKX09	-	0.67	-	-	-	-	-	HE2309X H2309X HS2309X	1.969 50	0.433 11	2.559 65	0.28	AE2309X A2309X AS2309X
	1 1/2	1.772 45	3.937 100	1.496 38	1.496 38	1.181 30	0.335 8.5	48.9	29.5	13.3	UK309 UK309L3	1.08 1.08	-	-	-	-	-	-	HE2309X H2309X HS2309X	1.969 50	0.433 11	2.559 65	0.28	AE2309X A2309X AS2309X
45	1 3/4	1.969 50	3.543 90	1.142 29	1.417 36	0.945 24	0.236 6	35.1	23.3	14.4	UK210 UK210L3	0.59 0.65	HE310X H310X	1.654 42	0.472 12	2.756 70	0.30	AE310X A310X	HE2310X H2310X	2.165 55	0.472 12	2.756 70	0.36	AE2310X A2310X
	1 3/4	1.969 50	3.937 100	1.220 31	-	0.984 25	0.276 7	43.4	29.4	14.4	UKX10	-	0.89	-	-	-	-	-	HE2310X H2310X	2.165 55	0.472 12	2.756 70	0.36	AE2310X A2310X
	1 3/4	1.969 50	4.331 110	1.575 40	1.575 40	1.260 32	0.354 9	62.0	38.3	13.2	UK310 UK310L3	1.38 1.38	-	-	-	-	-	-	HE2310X H2310X	2.165 55	0.472 12	2.756 70	0.36	AE2310X A2310X
50	1 7/8	2.165 55	3.937 100	1.220 31	1.575 40	0.984 25	0.276 7	43.4	29.4	14.4	UK211 UK211L3	0.80 1.09	HS311X H311X HE311X	1.772 45	0.472 12	2.953 75	0.35	AS311X A311X AE311X	HS2311X H2311X HE2311X	2.323 59	0.472 12	2.953 75	0.42	AS2311X A2311X AE2311X

Remarks 1. In Part No. of unit with adapters, Part No. of applicable adapters follow the Part No. shown in the dimensional tables.
(Example of Part No. : UK206 + 306X, UK206L3 + H2306X)

2. Adapter series applicable to UK200 series
UK200..... H300X series
UK200L3 (or L2) H2300X series
3. UK205 is the double seal type product (L2).
4. Inch bore diameter series adapters are also available (see the dimensional tables of adapters).

Ball bearing inserts

UK
Tapered bore (with adapter)
d₁ (50) ~ 85 mm

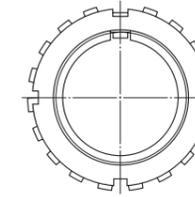
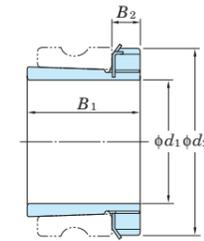
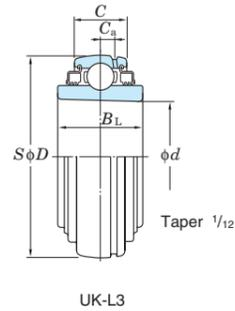
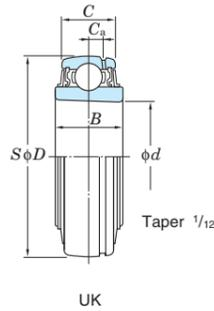

Adapter

Shaft Dia. mm inch	Dimensions inch mm						Basic Load Ratings kN		Factor f ₀	Bearing		Adapter No.	H3 Series Adapter			Sleeve No.	H23 Series Adapter			Adapter No.	Sleeve No.				
	d ₁	d	D	B	B _L	C	C _a	C _r		C _{0r}	No.		Mass kg	Dimensions inch mm	Mass kg		Dimensions inch mm	Mass kg	Dimensions inch mm			Mass kg			
										Standard	L3 Type	Standard	L3 Type	B ₁	B ₂	d ₂	B ₁	B ₂	d ₂						
50	1 7/8	2.165	4.331	1.299	-	1.063	0.295	52.4	36.2	14.4	UKX11	-	1.15	-	-	-	-	-	-	HS2311X H2311X HE2311X	2.323 0.472 2.953	0.42	AS2311X A2311X AE2311X		
	2	55	110	33	-	27	7.5																		
50	1 7/8	2.165	4.724	1.693	1.693	1.339	0.394	71.6	45.0	13.2	UK311	UK311L3	1.78	1.78	-	-	-	-	-	-	-	-	-	AS2311X A2311X AE2311X	
	2	55	120	43	43	34	10																		
55	2 1/8	2.362	4.331	1.299	1.850	1.063	0.295	52.4	36.2	14.4	UK212	UK212L3	1.02	1.41	-	-	-	-	-	-	-	-	-	-	AS2312X A2312X
	2	60	110	33	47	27	7.5																		
55	2 1/8	2.362	4.724	1.417	-	1.102	0.295	57.2	40.1	14.4	UKX12	-	1.45	-	-	-	-	-	-	-	-	-	-	-	AS2312X A2312X
	2	60	120	36	-	28	7.5																		
55	2 1/8	2.362	5.118	1.850	1.850	1.417	0.453	81.9	52.2	13.2	UK312	UK312L3	2.06	2.06	-	-	-	-	-	-	-	-	-	-	AS2312X A2312X
	2	60	130	47	47	36	11.5																		
60	2 1/4	2.559	4.724	1.417	1.850	1.102	0.295	57.2	40.1	14.4	UK213	UK213L3	1.34	1.67	-	-	-	-	-	-	-	-	-	-	AE2313X A2313X AS2313X
	2 3/8	65	120	36	47	28	7.5																		
60	2 1/4	2.559	4.921	1.575	-	1.181	0.354	62.2	44.1	14.5	UKX13	-	1.62	-	-	-	-	-	-	-	-	-	-	-	AE2313X A2313X AS2313X
	2 3/8	65	125	40	-	30	9																		
60	2 1/4	2.559	5.512	1.929	1.929	1.496	0.472	92.7	59.9	13.2	UK313	UK313L3	2.71	2.71	-	-	-	-	-	-	-	-	-	-	AE2313X A2313X AS2313X
	2 3/8	65	140	49	49	38	12																		
65	2 1/2	2.953	5.118	1.575	2.008	1.260	0.354	67.4	48.3	14.5	UK215	UK215L3	1.50	1.99	-	-	-	-	-	-	-	-	-	-	AE2315X A2315X
	2	75	130	40	51	32	9																		
65	2 1/2	2.953	5.512	1.654	-	1.299	0.354	72.7	53.0	14.6	UKX15	-	2.10	-	-	-	-	-	-	-	-	-	-	-	AE2315X A2315X
	2	75	140	42	-	33	9																		
65	2 1/2	2.953	6.299	2.165	2.165	1.654	0.571	113	77.2	13.2	UK315	UK315L3	3.80	3.80	-	-	-	-	-	-	-	-	-	-	AE2315X A2315X
	2	75	160	55	55	42	14.5																		
70	2 3/4	3.150	5.512	1.654	2.165	1.299	0.354	72.7	53.0	14.6	UK216	UK216L3	1.96	2.56	-	-	-	-	-	-	-	-	-	-	AE2316X A2316X
	2	80	140	42	55	33	9																		
70	2 3/4	3.150	5.906	1.732	-	1.378	0.394	84.0	61.9	14.5	UKX16	-	2.64	-	-	-	-	-	-	-	-	-	-	-	AE2316X A2316X
	2	80	150	44	-	35	10																		
70	2 3/4	3.150	6.693	2.165	2.165	1.732	0.591	123	86.7	13.3	UK316	UK316L3	4.39	4.39	-	-	-	-	-	-	-	-	-	-	AE2316X A2316X
	2	80	170	55	55	44	15																		
75	3	3.346	5.906	1.732	2.244	1.378	0.394	84.0	61.9	14.5	UK217	UK217L3	2.42	3.10	-	-	-	-	-	-	-	-	-	-	A2317X AE2317X
	2	85	150	44	57	35	10																		
75	3	3.346	6.299	1.890	-	1.496	0.433	96.1	71.5	14.5	UKX17	-	3.25	-	-	-	-	-	-	-	-	-	-	-	A2317X AE2317X
	2	85	160	48	-	38	11																		
75	3	3.346	7.087	2.362	2.362	1.811	0.591	133	96.8	13.3	UK317	UK317L3	5.30	5.30	-	-	-	-	-	-	-	-	-	-	A2317X AE2317X
	2	85	180	60	60	46	15																		
80	-	3.543	6.299	1.890	2.480	1.496	0.433	96.1	71.5	14.5	UK218	UK218L3	2.90	3.77	-	-	-	-	-	-	-	-	-	-	A2318X AE2318X
	2	90	160	48	63	38	11																		
80	-	3.543	6.693	1.969	-	1.575	0.453	109	81.9	14.4	UKX18	-	3.80	-	-	-	-	-	-	-	-	-	-	-	A2318X
	2	90	170	50	-	40	11.5																		
80	-	3.543	7.480	2.362	2.362	1.890	0.610	143	107	13.3	UK318	UK318L3	6.20	6.20	-	-	-	-	-	-	-	-	-	-	A2318X
	2	90	190	60	60	48	15.5																		
85	3 1/4	3.740	7.874	2.598	2.598	1.969	0.650	153	119	13.3	UK319	UK319L3	7.31	7.31	-	-	-	-	-	-	-	-	-	-	A2319X
	2	95	200	66	66	50	16.5																		

Remarks 1. In Part No. of unit with adapters, Part No. of applicable adapters follow the Part No. shown in the dimensional tables.
(Example of Part No. : UK206 + 306X, UK206L3 + H2306X)

2. Adapter series applicable to UK200 series
UK200..... H300X series
UK200L3 (or L2) H2300X series
3. UK205 is the double seal type product (L2).
4. Inch bore diameter series adapters are also available (see the dimensional tables of adapters).

Ball bearing inserts

UK
Tapered bore (with adapter)
 d_1 90 ~ 125 mm

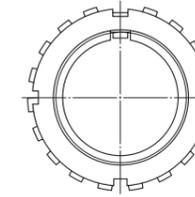
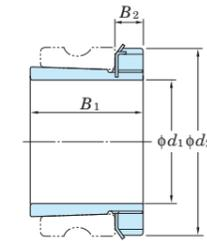
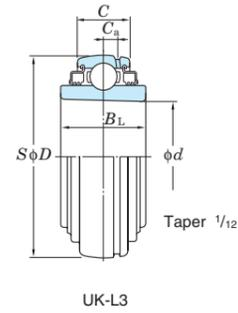
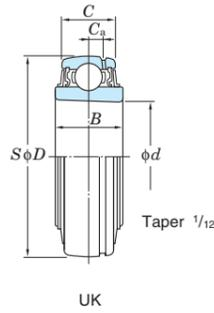

Adapter

Shaft Dia. mm inch	Dimensions inch mm							Basic Load Ratings kN		Factor f_0	Bearing				H3 Series Adapter				H23 Series Adapter				
	d_1	d	D	B	B_L	C	C_a	C_r	C_{0r}		No.	Mass kg		Adapter No.	Dimensions inch mm		Mass kg	Sleeve No.	Adapter No.	Dimensions inch mm		Mass kg	Sleeve No.
												Standard	L3 Type		Standard	L3 Type				B_1	B_2		
90	3 1/2	3.937	7.480	2.126	—	1.693	0.512	133	105	14.4	UKX20	—	5.36	—	—	—	—	HE2320X	3.819	0.787	5.118	2.2	AE2320X
		100	190	54	—	43	13											H2320X	97	20	130		A2320X
90	3 1/2	3.937	8.465	2.677	2.677	2.126	0.709	173	141	13.2	UK320	UK320L3	8.70	8.70	—	—	—	HE2320X	3.819	0.787	5.118	2.2	AE2320X
		100	215	68	68	54	18											H2320X	97	20	130		A2320X
100	4	4.331	9.449	3.071	3.071	2.362	0.787	205	180	13.2	UK322	UK322L3	12.2	12.2	—	—	—	H2322X	4.134	0.827	5.709	2.75	AE2322X
		110	240	78	78	60	20											HE2322X	105	21	145		AE2322X
110	—	4.724	10.236	3.425	3.425	2.520	0.827	207	185	13.5	UK324	UK324L3	16.1	16.1	—	—	—	H2324	4.409	0.866	6.102	3.2	A2324
		120	260	87	87	64	21												112	22	155		
115	4 1/2	5.118	11.024	3.425	3.425	2.677	0.866	229	214	13.6	UK326	UK326L3	18.8	18.8	—	—	—	HE2326	4.764	0.906	6.496	4.6	AE2326
		130	280	87	87	68	22											H2326	121	23	165		A2326
125	—	5.512	11.811	3.819	3.819	2.835	0.906	253	246	13.6	UK328	UK328L3	23.9	23.9	—	—	—	H2328	5.157	0.945	7.087	5.5	A2328
		140	300	97	97	72	23												131	24	180		

Remarks 1. In Part No. of unit with adapters, Part No. of applicable adapters follow the Part No. shown in the dimensional tables.
(Example of Part No. : UK206 + 306X, UK206L3 + H2306X)

2. Adapter series applicable to UK200 series
UK200..... H300X series
UK200L3 (or L2) H2300X series
3. UK205 is the double seal type product (L2).
4. Inch bore diameter series adapters are also available (see the dimensional tables of adapters).

Ball bearing inserts

SA, SA-F, NA
Cylindrical bore
(with eccentric locking collar)
d 12 ~ (30) mm

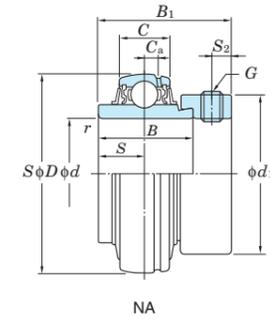
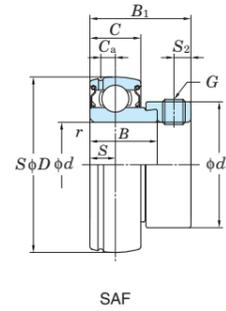
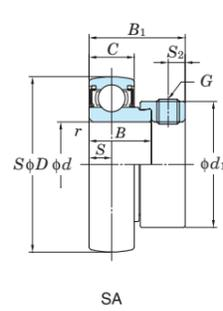

Shaft Dia mm inch <i>d</i>	Dimensions									Basic Load Ratings kN		Factor <i>f</i> ₀	Bearing No.	Dimensions						Set Screw Brg. Bore		Mass kg			
	<i>D</i> mm inch	<i>B</i> mm inch	<i>B</i> ₁ mm inch		<i>C</i> mm inch		<i>r</i> (min.) mm inch		<i>C</i> _r	<i>C</i> _{0r}	<i>C</i> _a mm inch			<i>S</i> mm inch	<i>S</i> ₂ mm inch		<i>d</i> ₁ mm inch		mm	inch					
12	40	1.575	19	0.784	28.5	1.122	12	0.472	0.6	0.024	9.55	4.80	13.2	SA201	-	-	6	0.236	4.8	0.189	28.6	1.126	M6x0.75	-	0.13
	40	1.575	19.1	0.752	28.6	1.126	13	0.512	0.6	0.024	9.55	4.80	13.2	SA201F	3.4	0.134	6.5	0.256	4.8	0.189	28.6	1.126	M6x0.75	-	0.13
	47	1.850	34.2	1.346	43.7	1.720	16	0.630	1	0.039	12.8	6.65	13.2	NA201	4	0.157	17.1	0.673	4.8	0.189	33.3	1.311	M6x0.75	-	0.29
-	40	1.575	19	0.784	28.5	1.122	12	0.472	0.6	0.024	9.55	4.80	13.2	SA201-8	-	-	6	0.236	4.8	0.189	28.6	1.126	-	1/4-28UNF	0.13
	40	1.575	19.1	0.752	28.6	1.126	13	0.512	0.6	0.024	9.55	4.80	13.2	SA201-8F	3.4	0.134	6.5	0.256	4.8	0.189	28.6	1.126	-	1/4-28UNF	0.13
	47	1.850	34.2	1.346	43.7	1.720	16	0.630	1	0.039	12.8	6.65	13.2	NA201-8	4	0.157	17.1	0.673	4.8	0.189	33.3	1.311	-	1/4-28UNF	0.29
15	40	1.575	19	0.784	28.5	1.122	12	0.472	0.6	0.024	9.55	4.80	13.2	SA202	-	-	6	0.236	4.8	0.189	28.6	1.126	M6x0.75	-	0.13
	40	1.575	19.1	0.752	28.6	1.126	13	0.512	0.6	0.024	9.55	4.80	13.2	SA202F	3.4	0.134	6.5	0.256	4.8	0.189	28.6	1.126	M6x0.75	-	0.13
	47	1.850	34.2	1.346	43.7	1.720	16	0.630	1	0.039	12.8	6.65	13.2	NA202	4	0.157	17.1	0.673	4.8	0.189	33.3	1.311	M6x0.75	-	0.27
-	40	1.575	19	0.784	28.5	1.122	12	0.472	0.6	0.024	9.55	4.80	13.2	SA202-10	-	-	6	0.236	4.8	0.189	28.6	1.126	-	1/4-28UNF	0.13
	47	1.850	34.2	1.346	43.7	1.720	16	0.630	1	0.039	12.8	6.65	13.2	NA202-10	4	0.157	17.1	0.673	4.8	0.189	33.3	1.311	-	1/4-28UNF	0.26
	40	1.575	19	0.784	28.5	1.122	12	0.472	0.6	0.024	9.55	4.80	13.2	SA203	-	-	6	0.236	4.8	0.189	28.6	1.126	M6x0.75	-	0.13
17	40	1.575	19.1	0.752	28.6	1.126	13	0.512	0.6	0.024	9.55	4.80	13.2	SA203F	3.4	0.134	6.5	0.256	4.8	0.189	28.6	1.126	M6x0.75	-	0.13
	47	1.850	34.2	1.346	43.7	1.720	16	0.630	1	0.039	12.8	6.65	13.2	NA203	4	0.157	17.1	0.673	4.8	0.189	33.3	1.311	M6x0.75	-	0.25
	47	1.850	20	0.787	29.5	1.161	14	0.551	1	0.039	12.8	6.65	13.2	SA204-12	-	-	7	0.276	4.8	0.189	33.3	1.311	-	1/4-28UNF	0.15
-	47	1.850	21.5	0.846	31	1.220	15	0.591	1	0.039	12.8	6.65	13.2	SA204-12F	3.7	0.146	7.5	0.295	4.8	0.189	33.3	1.311	-	1/4-28UNF	0.19
	47	1.850	34.2	1.346	43.7	1.720	16	0.630	1	0.039	12.8	6.65	13.2	NA204-12	4	0.157	17.1	0.673	4.8	0.189	33.3	1.311	-	1/4-28UNF	0.23
	47	1.850	20	0.787	29.5	1.161	14	0.551	1	0.039	12.8	6.65	13.2	SA204	-	-	7	0.276	4.8	0.189	33.3	1.311	M6x0.75	-	0.15
20	47	1.850	21.5	0.846	31	1.220	15	0.591	1	0.039	12.8	6.65	13.2	SA204F	3.7	0.146	7.5	0.295	4.8	0.189	33.3	1.311	M6x0.75	-	0.19
	47	1.850	34.2	1.346	43.7	1.720	16	0.630	1	0.039	12.8	6.65	13.2	NA204	4	0.157	17.1	0.673	4.8	0.189	33.3	1.311	M6x0.75	-	0.22
	52	2.047	21	0.827	30.5	1.201	15	0.591	1	0.039	14.0	7.85	13.9	SA205-14	-	-	7.5	0.295	4.8	0.189	38.1	1.511	-	1/4-28UNF	0.22
-	52	2.047	34.9	1.374	44.4	1.748	17	0.669	1	0.039	14.0	7.85	13.9	NA205-14	5	0.197	17.5	0.689	4.8	0.189	38.1	1.500	-	1/4-28UNF	0.27
	52	2.047	21	0.827	30.5	1.201	15	0.591	1	0.039	14.0	7.85	13.9	SA205-15	-	-	7.5	0.295	4.8	0.189	38.1	1.311	-	1/4-28UNF	0.22
	52	2.047	21.5	0.846	31	1.220	15	0.591	1	0.039	14.0	7.85	13.9	SA205-15F	3.7	0.146	7.5	0.295	4.8	0.189	38.1	1.311	-	1/4-28UNF	0.23
-	52	2.047	34.9	1.374	44.4	1.748	17	0.669	1	0.039	14.0	7.85	13.9	NA205-15	5	0.197	17.5	0.689	4.8	0.189	38.1	1.500	-	1/4-28UNF	0.29
	52	2.047	21	0.827	30.5	1.201	15	0.591	1	0.039	14.0	7.85	13.9	SA205	-	-	7.5	0.295	4.8	0.189	38.1	1.311	M6x0.75	-	0.22
	52	2.047	21.5	0.846	31	1.220	15	0.591	1	0.039	14.0	7.85	13.9	SA205F	3.7	0.146	7.5	0.295	4.8	0.189	38.1	1.311	M6x0.75	-	0.23
25	52	2.047	34.9	1.374	44.4	1.748	17	0.669	1	0.039	14.0	7.85	13.9	NA205	5	0.197	17.5	0.689	4.8	0.189	38.1	1.500	M6x0.75	-	0.25
	52	2.047	21	0.827	30.5	1.201	15	0.591	1	0.039	14.0	7.85	13.9	SA205-16	-	-	7.5	0.295	4.8	0.189	38.1	1.311	-	1/4-28UNF	0.22
	52	2.047	21.5	0.846	31	1.220	15	0.591	1	0.039	14.0	7.85	13.9	SA205-16F	3.7	0.146	7.5	0.295	4.8	0.189	38.1	1.311	-	1/4-28UNF	0.23
-	52	2.047	34.9	1.374	44.4	1.748	17	0.669	1	0.039	14.0	7.85	13.9	NA205-16	5	0.197	17.5	0.689	4.8	0.189	38.1	1.500	-	1/4-28UNF	0.25
	62	2.441	22	0.866	33.9	1.335	16	0.630	1	0.039	19.5	11.3	13.9	SA206-18	-	-	8	0.315	6	0.236	44.5	1.752	-	5/16-24UNF	0.3
	62	2.441	23.8	0.937	35.7	1.406	18	0.709	1	0.039	19.5	11.3	13.9	SA206-18F	4.7	0.185	9	0.354	6	0.236	44.5	1.752	-	5/16-24UNF	0.34
-	62	2.441	36.5	1.437	48.4	1.906	19	0.748	1	0.039	19.5	11.3	13.9	NA206-18	5	0.197	18.3	0.720	6	0.236	44.5	1.752	-	5/16-24UNF	0.43
	62	2.441	22	0.866	33.9	1.335	16	0.630	1	0.039	19.5	11.3	13.9	SA206	-	-	8	0.315	6	0.236	44.5	1.752	M8x1	-	0.3
	62	2.441	23.8	0.937	35.7	1.406	18	0.709	1	0.039	19.5	11.3	13.9	SA206F	4.7	0.185	9	0.354	6	0.236	44.5	1.752	M8x1	-	0.34
30	62	2.441	36.5	1.437	48.4	1.906	19	0.748	1	0.039	19.5	11.3	13.9	NA206	5	0.197	18.3	0.720	6	0.236	44.5	1.752	M8x1	-	0.41
	62	2.441	22	0.866	33.9	1.335	16	0.630	1	0.039	19.5	11.3	13.9	SA206-19	-	-	8	0.315	6	0.236	44.5	1.752	-	5/16-24UNF	0.3
	62	2.441	23.8	0.937	35.7	1.406	18	0.709	1	0.039	19.5	11.3	13.9	SA206-19F	4.7	0.185	9	0.354	6	0.236	44.5	1.752	-	5/16-24UNF	0.34
-	62	2.441	36.5	1.437	48.4	1.906	19	0.748	1	0.039	19.5	11.3	13.9	NA206-19	5	0.197	18.3	0.720	6	0.236	44.5	1.752	-	5/16-24UNF	0.41
	62	2.441	22	0.866	33.9	1.335	16	0.630	1	0.039	19.5	11.3	13.9	SA206-20	-	-	8	0.315	6	0.236	44.5	1.752	-	5/16-24UNF	0.3
	62	2.441	23.8	0.937	35.7	1.406	18	0.709	1	0.039	19.5	11.3	13.9	SA206-20F	4.7	0.185	9	0.354	6	0.236	44.5	1.752	-	5/16-24UNF	0.34
-	62	2.441	36.5	1.437	48.4	1.906	19	0.748	1	0.039	19.5	11.3	13.9	NA206-20	5	0.197	18.3	0.720	6	0.236	44.5	1.752	-	5/16-24UNF	0.38
	72	2.835	23	0.906	36.5	1.437	17	0.669	1.1	0.043	25.7	15.4	13.9	SA207-20	-	-	8.5	0.335	6.8	0.268	55.6	2.189	-	5/16-24UNF	0.5
	72	2.835	25.4	1.000	38.9	1.531	19	0.748	1.1	0.043	25.7	15.4	13.9	SA207-20F	5.7	0.224	9.5	0.335	6.8	0.268	55.6	2.189	-	5/16-24UNF	0.57
-	72	2.835	37.6	1.480	51.1	2.012	20																		

Ball bearing inserts

SA, SA-F, NA
Cylindrical bore
(with eccentric locking collar)
d (30) ~ 75 mm

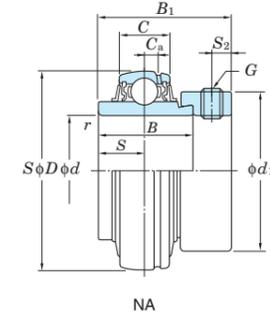
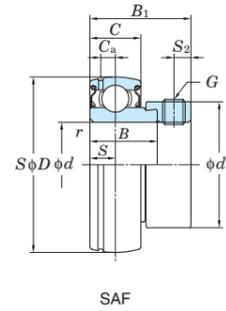
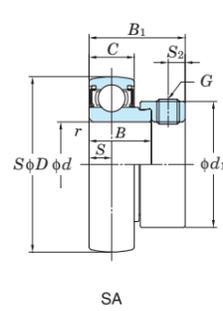

Shaft Dia mm inch	Dimensions										Basic Load Ratings kN		Factor f ₀	Bearing No.	Dimensions						Set Screw Brg. Bore		Mass kg			
	d		D		B		B ₁		C		r (min.)				C _r	C _{0r}	C _a	S		S ₂		d ₁		mm	inch	
	mm	inch	mm	inch	mm	inch	mm	inch	mm	inch	mm	inch						mm	inch	mm	inch	mm				inch
-	1 3/8	72	2.835	23	0.906	36.5	1.437	17	0.669	1.1	0.043	25.7	15.4	13.9	SA207-22	-	-	8.5	0.335	6.8	0.268	55.6	2.189	-	5/16-24UNF	0.5
		72	2.835	25.4	1.000	38.9	1.531	19	0.748	1.1	0.043	25.7	15.4	13.9	SA207-22F	5.7	0.224	9.5	0.335	6.8	0.268	55.6	2.189	-	5/16-24UNF	0.57
		72	2.835	37.6	1.480	51.1	2.012	20	0.787	1.1	0.043	25.7	15.4	13.9	NA207-22	5.5	0.217	18.8	0.740	6.8	0.268	55.6	2.189	-	5/16-24UNF	0.61
35	-	72	2.835	23	0.906	36.5	1.437	17	0.669	1.1	0.043	25.7	15.4	13.9	SA207	-	-	8.5	0.335	6.8	0.268	55.6	2.189	M8x1	-	0.5
		72	2.835	25.4	1.000	38.9	1.531	19	0.748	1.1	0.043	25.7	15.4	13.9	SA207F	5.7	0.224	9.5	0.335	6.8	0.268	55.6	2.189	M8x1	-	0.57
		72	2.835	37.6	1.480	51.1	2.012	20	0.787	1.1	0.043	25.7	15.4	13.9	NA207	5.5	0.217	18.8	0.740	6.8	0.268	55.6	2.189	M8x1	-	0.61
-	1 7/16	72	2.835	23	0.906	36.5	1.437	17	0.669	1.1	0.043	25.7	15.4	13.9	SA207-23	-	-	8.5	0.335	6.8	0.268	55.6	2.189	-	5/16-24UNF	0.5
		72	2.835	25.4	1.000	38.9	1.531	19	0.748	1.1	0.043	25.7	15.4	13.9	SA207-23F	5.7	0.224	9.5	0.335	6.8	0.268	55.6	2.189	-	5/16-24UNF	0.57
		72	2.835	37.6	1.480	51.1	2.012	20	0.787	1.1	0.043	25.7	15.4	13.9	NA207-23	5.5	0.217	18.8	0.740	6.8	0.268	55.6	2.189	-	5/16-24UNF	0.58
-	1 1/2	80	3.150	27	1.063	40.5	1.595	18	0.709	1.1	0.043	29.1	17.8	14.0	SA208-24	-	-	9	0.354	6.8	0.268	60.3	2.374	-	5/16-24UNF	0.67
		80	3.150	30.2	1.189	43.7	1.720	22	0.866	1.1	0.043	29.1	17.8	14.0	SA208-24F	6.4	0.252	11	0.433	6.8	0.268	60.3	2.374	-	5/16-24UNF	0.75
		80	3.150	42.8	1.685	56.3	2.217	21	0.827	1.1	0.043	29.1	17.8	14.0	NA208-24	6	0.236	21.4	0.843	6.8	0.268	60.3	2.374	-	5/16-24UNF	0.83
-	1 9/16	80	3.150	27	1.063	40.5	1.595	18	0.709	1.1	0.043	29.1	17.8	14.0	SA208-25	-	-	9	0.354	6.8	0.268	60.3	2.374	-	5/16-24UNF	0.67
		80	3.150	30.2	1.189	43.7	1.720	22	0.866	1.1	0.043	29.1	17.8	14.0	SA208-25F	6.4	0.252	11	0.433	6.8	0.268	60.3	2.374	-	5/16-24UNF	0.75
		80	3.150	42.8	1.685	56.3	2.217	21	0.827	1.1	0.043	29.1	17.8	14.0	NA208-25	6	0.236	21.4	0.843	6.8	0.268	60.3	2.374	-	5/16-24UNF	0.79
40	-	80	3.150	27	1.063	40.5	1.595	18	0.709	1.1	0.043	29.1	17.8	14.0	SA208	-	-	9	0.354	6.8	0.268	60.3	2.374	M8x1	-	0.67
		80	3.150	30.2	1.189	43.7	1.720	22	0.866	1.1	0.043	29.1	17.8	14.0	SA208F	6.4	0.252	11	0.433	6.8	0.268	60.3	2.374	M8x1	-	0.75
		80	3.150	42.8	1.685	56.3	2.217	21	0.827	1.1	0.043	29.1	17.8	14.0	NA208	6	0.236	21.4	0.843	6.8	0.268	60.3	2.374	M8x1	-	0.78
-	1 5/8	85	3.346	30.2	1.189	43.7	1.720	22	0.866	1.1	0.043	34.1	21.3	14.0	SA209-26F	6	0.236	11	0.433	6.8	0.268	63.5	2.500	-	5/16-24UNF	0.82
		85	3.346	42.8	1.685	56.3	2.217	22	0.866	1.1	0.043	34.1	21.3	14.0	NA209-26	6	0.236	21.4	0.843	6.8	0.268	63.5	2.500	-	5/16-24UNF	0.96
-	1 11/16	85	3.346	30.2	1.189	43.7	1.720	22	0.866	1.1	0.043	34.1	21.3	14.0	SA209-27F	6	0.236	11	0.433	6.8	0.268	63.5	2.500	-	5/16-24UNF	0.82
		85	3.346	42.8	1.685	56.3	2.217	22	0.866	1.1	0.043	34.1	21.3	14.0	NA209-27	6	0.236	21.4	0.843	6.8	0.268	63.5	2.500	-	5/16-24UNF	0.91
-	1 3/4	85	3.346	30.2	1.189	43.7	1.720	22	0.866	1.1	0.043	34.1	21.3	14.0	SA209-28F	6	0.236	11	0.433	6.8	0.268	63.5	2.500	-	5/16-24UNF	0.82
		85	3.346	42.8	1.685	56.3	2.217	22	0.866	1.1	0.043	34.1	21.3	14.0	NA209-28	6	0.236	21.4	0.843	6.8	0.268	63.5	2.500	-	5/16-24UNF	0.87
45	-	85	3.346	30.2	1.189	43.7	1.720	22	0.866	1.1	0.043	34.1	21.3	14.0	SA209F	6	0.236	11	0.433	6.8	0.268	63.5	2.500	M8x1	-	0.82
		85	3.346	42.8	1.685	56.3	2.217	22	0.866	1.1	0.043	34.1	21.3	14.0	NA209	6	0.236	21.4	0.843	6.8	0.268	63.5	2.500	M8x1	-	0.85
		90	3.543	30.2	1.189	43.7	1.720	22	0.866	1.1	0.043	35.1	23.3	14.4	SA210-30F	6.6	0.260	11	0.433	6.8	0.268	69.9	2.752	-	5/16-24UNF	0.85
-	1 7/8	90	3.543	49.2	1.937	62.7	2.469	24	0.945	1.1	0.043	35.1	23.3	14.4	NA210-30	6	0.236	24.6	0.969	6.8	0.268	69.9	2.752	-	5/16-24UNF	1.08
		90	3.543	30.2	1.189	43.7	1.720	22	0.866	1.1	0.043	35.1	23.3	14.4	SA210-31F	6.6	0.260	11	0.433	6.8	0.268	69.9	2.752	-	5/16-24UNF	0.85
		90	3.543	49.2	1.937	62.7	2.469	24	0.945	1.1	0.043	35.1	23.3	14.4	NA210-31	6	0.236	24.6	0.969	6.8	0.268	69.9	2.752	-	5/16-24UNF	1.04
50	-	90	3.543	30.2	1.189	43.7	1.720	22	0.866	1.1	0.043	35.1	23.3	14.4	SA210F	6.6	0.260	11	0.433	6.8	0.268	69.9	2.752	M8x1	-	0.85
		90	3.543	49.2	1.937	62.7	2.469	24	0.945	1.1	0.043	35.1	23.3	14.4	NA210	6	0.236	24.6	0.969	6.8	0.268	69.9	2.752	M8x1	-	1.01
		90	3.543	49.2	1.937	62.7	2.469	24	0.945	1.1	0.043	35.1	23.3	14.4	NA210-32	6	0.236	24.6	0.969	6.8	0.268	69.9	2.752	-	5/16-24UNF	0.99
-	2	100	3.937	32.4	1.276	48.4	1.906	24	0.945	1.5	0.059	43.4	29.4	14.4	SA211-32F	7	0.276	12	0.472	8	0.315	76.2	3.000	-	3/8-24UNF	1.2
		100	3.937	55.5	2.185	71.4	2.811	25	0.984	1.5	0.059	43.4	29.4	14.4	NA211-32	7	0.276	27.8	1.094	8	0.315	76.2	3.000	-	3/8-24UNF	1.58
		100	3.937	32.4	1.276	48.4	1.906	24	0.945	1.5	0.059	43.4	29.4	14.4	SA211-34F	7	0.276	12	0.472	8	0.315	76.2	3.000	-	3/8-24UNF	1.2
-	2 1/8	100	3.937	55.5	2.185	71.4	2.811	25	0.984	1.5	0.059	43.4	29.4	14.4	NA211-34	7	0.276	27.8	1.094	8	0.315	76.2	3.000	-	3/8-24UNF	1.49
		100	3.937	32.4	1.276	48.4	1.906	24	0.945	1.5	0.059	43.4	29.4	14.4	SA211F	7	0.276	12	0.472	8	0.315	76.2	3.000	M10x1.25	-	1.2
		100	3.937	55.5	2.185	71.4	2.811	25	0.984	1.5	0.059	43.4	29.4	14.4	NA211	7	0.276	27.8	1.094	8	0.315	76.2	3.000	M10x1.25	-	1.39
-	2 3/16	100	3.937	32.4	1.276	48.4	1.906	24	0.945	1.5	0.059	43.4	29.4	14.4	SA211-35F	7	0.276	12	0.472	8	0.315	76.2	3.000	-	3/8-24UNF	1.2
		100	3.937	55.5	2.185	71.4	2.811	25	0.984	1.5	0.059	43.4	29.4	14.4	NA211-35	7	0.276	27.8	1.094	8	0.315	76.2	3.000	-	3/8-24UNF	1.36
		110	4.331	61.9	2.437	77.8	3.063	27	1.063	1.5	0.059	52.4	36.2	14.4	NA212-36	7.5	0.295	31	1.220	8	0.315	84.2	3.315	-	3/8-24UNF	2.03
60	2 1/4	110	4.331	61.9	2.437	77.8	3.063	27	1.063	1.5	0.059	52.4	36.2	14.4	NA212	7.5	0.295	31	1.220	8	0.315	84.2	3.315	M10x1.25	-	1.87
		120	4.724	68.2	2.685	85.7	3.374	28																		

Ball bearing inserts

ER, RB
Cylindrical bore (with set screws),
cylindrical outside surface
 d 12 ~ 60 mm

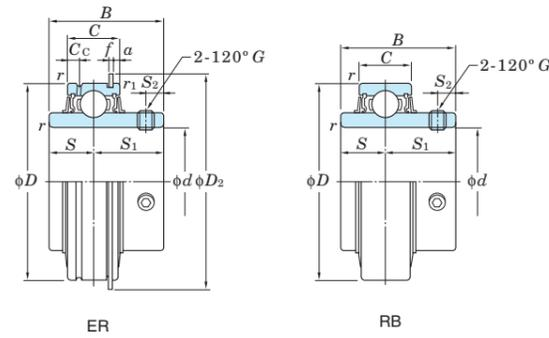

Shaft Dia.		Dimensions					Basic Load Ratings		Factor	Bearing No.		Dimensions							Set Screw Brg. Bore		Mass	
mm	inch	inch mm					C_r	C_{0r}		f_0	(ER)	(RB)	S	S_1	S_2	C_c	a	f	D_2	mm	inch	(ER)
12	1/2	1.850	1.220	0.630	0.024	0.020	12.8	6.65	13.2	ER201	RB201	0.500	0.720	0.197	0.157	0.094	0.042	2.067	M6x0.75	—	0.27	0.27
										ER201-8	RB201-8								—	1/4-28UNF	0.27	0.27
15	5/8	47	31	16	0.6	0.5	12.8	6.65	13.2	ER202	RB202	12.7	18.3	5	4	2.38	1.07	52.5	M6x0.75	—	0.25	0.25
										ER202-10	RB202-10								—	1/4-28UNF	0.25	0.25
17	3/4	1.850	1.220	0.630	0.039	0.020	12.8	6.65	13.2	ER203	RB203	0.500	0.720	0.197	0.157	0.094	0.042	2.067	M6x0.75	—	0.24	0.24
										ER204-12	RB204-12								—	1/4-28UNF	0.22	0.22
20	7/8	47	31	16	1	0.5	12.8	6.65	13.2	ER204	RB204	12.7	18.3	5	4	2.38	1.07	52.5	M6x0.75	—	0.22	0.22
										ER205-14	RB205-14								—	1/4-28UNF	0.3	0.29
25	15/16	2.047	1.343	0.748	0.039	0.020	14.0	7.85	13.9	ER205-15	RB205-15	0.563	0.780	0.217	0.197	0.094	0.042	2.272	—	1/4-28UNF	0.28	0.27
										ER205	RB205								M6x0.75	—	0.27	0.26
30	1	2.441	1.500	0.866	0.039	0.020	19.5	11.3	13.9	ER205-16	RB205-16	14.3	19.8	5.5	5	2.38	1.07	57.7	—	1/4-28UNF	0.27	0.26
										ER206-18	RB206-18								—	1/4-28UNF	0.41	0.4
35	1 1/8	2.835	1.689	0.945	0.043	0.020	25.7	15.4	13.9	ER206	RB206	0.626	0.874	0.236	0.217	0.125	0.065	2.657	M6x0.75	—	0.39	0.38
										ER206-19	RB206-19								—	1/4-28UNF	0.39	0.38
40	1 1/4	3.150	1.937	1.102	0.043	0.020	29.1	17.8	14.0	ER206-20	RB206-20	15.9	22.2	6	5.5	3.18	1.65	67.5	—	1/4-28UNF	0.37	0.36
										ER207-20	RB207-20								—	5/16-24UNF	0.69	0.68
45	1 5/16	2.835	1.689	0.945	0.043	0.020	25.7	15.4	13.9	ER207-21	RB207-21	0.689	1.000	0.256	0.217	0.125	0.065	3.087	—	5/16-24UNF	0.66	0.65
										ER207-22	RB207-22								—	5/16-24UNF	0.64	0.63
50	1 7/8	3.150	1.937	1.102	0.043	0.020	29.1	17.8	14.0	ER207	RB207	17.5	25.4	6.5	5.5	3.18	1.65	78.4	M8x1	—	0.63	0.62
										ER207-23	RB207-23								—	5/16-24UNF	0.61	0.6
55	1 9/16	3.150	1.937	1.102	0.043	0.020	29.1	17.8	14.0	ER208-24	RB208-24	0.748	1.189	0.315	0.236	0.125	0.065	3.402	—	5/16-24UNF	0.85	0.84
										ER208-25	RB208-25								—	5/16-24UNF	0.82	0.81
60	2	4.331	2.563	1.260	0.059	0.020	52.4	36.2	14.4	ER208	RB208	19	30.2	8	6	3.18	1.65	86.4	M8x1	—	0.81	0.78
										ER209-26	—								—	5/16-24UNF	1.0	—
65	2 1/8	3.346	1.937	1.102	0.043	0.020	34.1	21.3	14.0	ER209-27	—	0.748	1.189	0.315	0.236	0.125	0.065	3.598	—	5/16-24UNF	0.96	—
										ER209-28	—								—	5/16-24UNF	0.92	—
70	2 1/4	3.346	1.937	1.102	0.043	0.020	34.1	21.3	14.0	ER209	—	19	30.2	8	6	3.18	1.65	91.4	M8x1	—	0.90	—
										ER210-30	—								—	3/8-24UNF	1.05	—
75	2 3/8	3.543	2.031	1.102	0.043	0.020	35.1	23.3	14.4	ER210-31	—	0.748	1.283	0.354	0.295	0.125	0.095	3.791	—	3/8-24UNF	1.0	—
										ER210	—								—	3/8-24UNF	0.98	—
80	2 7/16	3.543	2.031	1.102	0.043	0.020	35.1	23.3	14.4	ER210-32	—	19	32.6	9	7.5	3.18	2.41	96.3	M10x1.25	—	0.96	—
										ER211-32	—								—	3/8-24UNF	1.56	—
85	2 1/2	3.937	2.189	1.181	0.059	0.020	43.4	29.4	14.4	ER211-34	—	0.874	1.315	0.354	0.295	0.125	0.095	4.185	—	3/8-24UNF	1.45	—
										ER211	—								—	3/8-24UNF	1.41	—
90	2 3/4	3.937	2.189	1.181	0.059	0.020	43.4	29.4	14.4	ER211-35	—	22.2	33.4	9	7.5	3.18	2.41	106.3	M10x1.25	—	1.39	—
										ER212-36	—								—	3/8-24UNF	2.02	—
95	2 7/8	4.331	2.563	1.260	0.059	0.020	52.4	36.2	14.4	ER212	—	1.000	1.563	0.413	0.295	0.125	0.095	4.583	M10x1.25	—	1.89	—
										ER212-38	—								—	3/8-24UNF	1.87	—
100	3	4.331	2.563	1.260	0.059	0.020	52.4	36.2	14.4	ER212-39	—	25.4	39.7	10.5	7.5	3.18	2.41	116.4	—	3/8-24UNF	1.8	—

Ball bearing inserts

H300X, H2300X

d₁ 20 ~ (70) mm

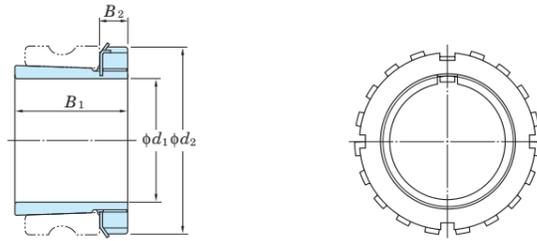

Shaft Dia. d ₁		Dimensions			Adapter No.			Sleeve No.			Lock Nut No.	Washer No.	Mass		
mm	inch	inch mm			(H)	(HE)	(HS)	(H)	(HE)	(HS)			(H)	(HE)	(HS)
20	—	1.142	0.315	1.496	H305X	—	—	A305X	—	—	AN05	AW05X	0.075	—	—
	3/4	29	8	38	—	HE305X	—	—	AE305X	—	AN05	AW05X	—	0.08	—
20	—	1.378	0.315	1.496	H2305X	—	—	A2305X	—	—	AN05	AW05X	0.095	—	—
	3/4	35	8	38	—	HE2305X	—	—	AE2305X	—	AN05	AW05X	—	0.085	—
25	—	1.220	0.315	1.772	H306X	—	—	A306X	—	—	AN06	AW06X	0.11	—	—
	1	31	8	45	—	HE306X	—	—	AE306X	—	AN06	AW06X	—	0.105	—
25	—	1.496	0.315	1.772	H2306X	—	—	A2306X	—	—	AN06	AW06X	0.13	—	—
	1	38	8	45	—	HE2306X	—	—	AE2306X	—	AN06	AW06X	—	0.12	—
30	—	1.378	0.354	2.047	H307X	—	—	A307X	—	—	AN07	AW07X	0.14	—	—
	—	35	9	52	—	—	HS307X	—	—	AS307X	AN07	AW07X	—	—	0.15
30	—	1.693	0.354	2.047	H2307X	—	—	A2307X	—	—	AN07	AW07X	0.17	—	—
	—	43	9	52	—	—	HS2307X	—	—	AS2307X	AN07	AW07X	—	—	0.19
35	—	1.417	0.394	2.283	H308X	—	—	A308X	—	—	AN08	AW08X	0.19	—	—
	1 1/4	36	10	58	—	HE308X	—	—	AE308X	—	AN08	AW08X	—	0.23	—
35	—	1.811	0.394	2.283	H2308X	—	—	A2308X	—	—	AN08	AW08X	0.22	—	—
	—	46	10	58	—	HE2308X	—	—	AE2308X	—	AN08	AW08X	—	0.28	—
40	—	1.535	0.433	2.559	H309X	—	—	A309X	—	—	AN09	AW09X	0.25	—	—
	1 1/2	39	11	65	—	HE309X	—	—	AE309X	—	AN09	AW09X	—	0.28	—
40	—	1.969	0.433	2.559	H2309X	—	—	A2309X	—	—	AN09	AW09X	0.28	—	—
	—	50	11	65	—	HE2309X	—	—	AE2309X	—	AN09	AW09X	—	0.32	—
45	—	1.654	0.472	2.756	H310X	—	—	A310X	—	—	AN10	AW10X	0.30	—	—
	1 3/4	42	12	70	—	HE310X	—	—	AE310X	—	AN10	AW10X	—	0.31	—
45	—	2.165	0.472	2.756	H2310X	—	—	A2310X	—	—	AN10	AW10X	0.36	—	—
	1 3/4	55	12	70	—	HE2310X	—	—	AE2310X	—	AN10	AW10X	—	0.37	—
50	—	1.772	0.472	2.953	H311X	—	—	A311X	—	—	AN11	AW11X	0.35	—	—
	—	45	12	75	—	HE311X	—	—	AE311X	—	AN11	AW11X	—	0.33	—
50	—	2.323	0.472	2.953	H2311X	—	—	A2311X	—	—	AN11	AW11X	0.42	—	—
	—	59	12	75	—	HE2311X	—	—	AE2311X	—	AN11	AW11X	—	0.40	—
55	—	1.850	0.512	3.150	H312X	—	—	A312X	—	—	AN12	AW12X	0.43	—	—
	—	47	13	80	—	—	HS312X	—	—	AS312X	AN12	AW12X	—	—	0.40
55	—	2.441	0.512	3.150	H2312X	—	—	A2312X	—	—	AN12	AW12X	0.48	—	—
	—	62	13	80	—	—	HS2312X	—	—	AS2312X	AN12	AW12X	—	—	0.52
60	—	1.969	0.551	3.346	H313X	—	—	A313X	—	—	AN13	AW13X	0.46	—	—
	—	50	14	85	—	HE313X	—	—	AE313X	—	AN13	AW13X	—	0.56	—
60	—	2.559	0.551	3.346	H2313X	—	—	A2313X	—	—	AN13	AW13X	0.56	—	—
	—	65	14	85	—	HE2313X	—	—	AE2313X	—	AN13	AW13X	—	0.69	—
65	—	2.165	0.591	3.858	H315X	—	—	A315X	—	—	AN15	AW15X	0.83	—	—
	—	55	15	98	—	HE315X	—	—	AE315X	—	AN15	AW15X	—	0.89	—
65	—	2.874	0.591	3.858	H2315X	—	—	A2315X	—	—	AN15	AW15X	1.05	—	—
	—	73	15	98	—	HE2315X	—	—	AE2315X	—	AN15	AW15X	—	1.15	—
70	—	2.323	0.669	4.134	H316X	—	—	A316X	—	—	AN16	AW16X	1.05	—	—
	—	59	17	105	—	HE316X	—	—	AE316X	—	AN16	AW16X	—	1.05	—

H300X, H2300X
 d_1 (70) ~ 125 mm

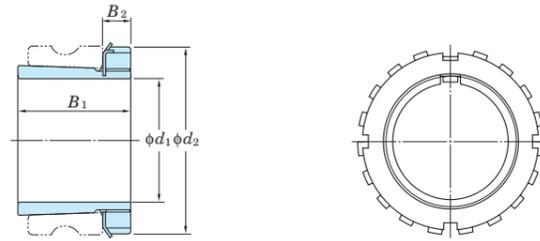

Shaft Dia. d_1			Dimensions			Adapter No.			Sleeve No.			Lock Nut No.	Washer No.	Mass		
mm	inch		inch											kg		
(H)	(HE)	(HS)	B_1	B_2	d_2	(H)	(HE)	(HS)	(H)	(HE)	(HS)			(H)	(HE)	(HS)
70	-	-	3.071	0.669	4.134	H2316X	-	-	A2316X	-	-	AN16	AW16X	1.3	-	-
	2 3/4	-	78	17	105	-	HE2316X	-	-	AE2316X	-					
75	-	-	2.480	0.709	4.331	H317X	-	-	A317X	-	-	AN17	AW17X	1.2	-	-
	3	-	63	18	110	-	HE317X	-	-	AE317X	-					
75	-	-	3.228	0.709	4.331	H2317X	-	-	A2317X	-	-	AN17	AW17X	1.45	-	-
	3	-	82	18	110	-	HE2317X	-	-	AE2317X	-					
80	-	-	2.559	0.709	4.724	H318X	-	-	A318X	-	-	AN18	AW18X	1.4	-	-
	-	-	65	18	120	-	-	-	-	-	-					
80	-	-	3.386	0.709	4.724	H2318X	-	-	A2318X	-	-	AN18	AW18X	1.7	-	-
	-	-	86	18	120	-	-	-	-	-	-					
85	-	-	3.543	0.748	4.921	H2319X	-	-	A2319X	-	-	AN19	AW19X	1.95	-	-
	3 1/4	-	90	19	125	-	HE2319X	-	-	AE2319X	-					
90	-	-	3.819	0.787	5.118	H2320X	-	-	A2320X	-	-	AN20	AW20X	2.2	-	-
	3 1/2	-	97	20	130	-	HE2320X	-	-	AE2320X	-					
100	-	-	4.134	0.827	5.709	H2322X	-	-	A2322X	-	-	AN22	AW22X	2.75	-	-
	4	-	105	21	145	-	HE2322X	-	-	AE2322X	-					
110	-	-	4.409	0.866	6.102	H2324	-	-	A2324	-	-	AN24	AW24	3.2	-	-
	-	-	112	22	155	-	-	-	-	-	-					
115	-	-	4.764	0.906	6.496	H2326	-	-	A2326	-	-	AN26	AW26	4.6	-	-
	4 1/2	-	121	23	165	-	HE2326	-	-	AE2326	-					
125	-	-	5.157	0.945	7.087	H2328	-	-	A2328	-	-	AN28	AW28	5.5	-	-
	-	-	131	24	180	-	-	-	-	-	-					

16 Parts and accessories

16.1 Part No. of steel plate covers

Table 16.1 Part No. of steel plate cover for UC type bearing

Bearing No.	Shaft dia. (mm)	Steel plate cover No.	
		Open type	Sealed type
UC201	12	C- 4×12	D- 4
UC202	15	C- 4×15	D- 4
UC203	17	C- 4×17	D- 4
UC204	20	C- 4×20	D- 4
UC205	25	C- 5×25	D- 5
UC206	30	C- 6×30	D- 6
UC207	35	C- 7×35	D- 7
UC208	40	C- 8×40	D- 8
UC209	45	C- 9×45	D- 9
UC210	50	C-10×50	D-10
UC211	55	C-11×55	D-11
UC212	60	C-12×60	D-12
UC213	65	C-13×65	D-13
UC214	70	C-14×70	D-14
UC215	75	C-15×75	D-15
UC216	80	C-16×80	D-16
UC217	85	C-17×85	D-17
UC218	90	C-18×90	D-18
UCX05	25	C- 6×25	D- 6
UCX06	30	C- 7×30	D- 7
UCX07	35	C- 8×35	D- 8
UCX08	40	C- 9×40	D- 9
UCX09	45	C-10×45	D-10
UCX10	50	C-11×50	D-11
UCX11	55	C-12×55	D-12
UCX12	60	C-13×60	D-13
UCX13	65	C-14×65	D-14
UCX14	70	C-15×70	D-15
UCX15	75	C-16×75	D-16
UCX16	80	C-17×80	D-17
UCX17	85	C-18×85	D-18

Table 16.2 Part No. of steel plate cover for UK type bearing

Bearing No.	Shaft dia. (mm)	Steel plate cover No.	
		Open type	Sealed type
-			
-			
-			
-			
UK205	20	C- 5×20	D- 5
UK206	25	C- 6×25	D- 6
UK207	30	C- 7×30	D- 7
UK208	35	C- 8×35	D- 8
UK209	40	C- 9×40	D- 9
UK210	45	C-10×45	D-10
UK211	50	C-11×50	D-11
UK212	55	C-12×55	D-12
UK213	60	C-13×60	D-13
-			
UK215	65	C-15×65	D-15
UK216	70	C-16×70	D-16
UK217	75	C-17×75	D-17
UK218	80	C-18×80	D-18
UKX05	20	C- 6×20	D- 6
UKX06	25	C- 7×25	D- 7
UKX07	30	C- 8×30	D- 8
UKX08	35	C- 9×35	D- 9
UKX09	40	C-10×40	D-10
UKX10	45	C-11×45	D-11
UKX11	50	C-12×50	D-12
UKX12	55	C-13×55	D-13
UKX13	60	C-14×60	D-14
-			
UKX15	65	C-16×65	D-16
UKX16	70	C-17×70	D-17
UKX17	75	C-18×75	D-18

Remark In the Part No. of the steel plate covers for shouldered shaft, shaft diameter follows the basic code of the cover. For example, Part No. of the cover for a shaft with 30 mm diameter for UC206 is C-6×30.

16.2 Part No. of cast iron covers

Table 16.3 Part No. of cast iron cover for UC type bearing

Bearing No.	Shaft dia. (mm)	Cast iron cover No.		Mounting bolt (reference)
		Open type	Closed type	
UC204	20	204FC×20 (204FC3×20) ¹⁾	204FD (204FD3) ¹⁾	M3 (M4)
UC205	25	205FC×25 (205FC3×25) ¹⁾	205FD (205FD3) ¹⁾	M3 (M4)
UC206	30	206FC×30	206FD	M4
UC207	35	207FC×35	207FD	M4
UC208	40	208FC×40	208FD	
UC209	45	209FC×45	209FD	
UC210	50	210FC×50	210FD	M4
UC211	55	211FC×55	211FD	
UC212	60	212FC×60	212FD	
UC213	65	213FC×65	213FD	M4
UC214	70	214FC×70	214FD	
UC215	75	215FC×75	215FD	
UC216	80	216FC×80	216FD	M5
UC217	85	217FC×85	217FD	
UC218	90	218FC×90	218FD	
UCX18	90	X18C×90 (X18C3×90) ²⁾	X18D (X18D3) ²⁾	M5
UCX20	100	X20C×100 (X20C3×100) ²⁾	X20D (X20D3) ²⁾	
UC305	25	305C×25	305D	M4
UC306	30	306C×30	306D	
UC307	35	307C×35	307D	
UC308	40	308C×40	308D	M5
UC309	45	309C×45	309D	
UC310	50	310C×50	310D	
UC311	55	311C×55	311D	M5
UC312	60	312C×60	312D	
UC313	65	313C×65	313D	
UC314	70	314C×70	314D	M5
UC315	75	315C×75	315D	
UC316	80	316C×80	316D	
UC317	85	317C×85	317D	M5
UC318	90	318C×90	318D	
UC319	95	319C×95	319D	
UC320	100	320C×100	320D	M5
UC321	105	321C×105	321D	
UC322	110	322C×110	322D	
UC324	120	324C×120	324D	M5
UC326	130	326C×130	326D	M8
UC328	140	328C×140	328D	

Table 16.4 Part No. of cast iron cover for UK type bearing

Bearing No.	Shaft dia. (mm)	Cast iron cover No.		Mounting bolt (reference)
		Open type	Closed type	
–				
UK205	20	205FC×20 (205FC3×20) ¹⁾	205FD (205FD3) ¹⁾	M3 (M4)
UK206	25	206FC×25	206FD	M4
UK207	30	207FC×30	207FD	M4
UK208	35	208FC×35	208FD	
UK209	40	209FC×40	209FD	
UK210	45	210FC×45	210FD	M4
UK211	50	211FC×50	211FD	
UK212	55	212FC×55	212FD	
UK213	60	213FC×60	213FD	M4
–				
UK215	65	215FC×65	215FD	
UK216	70	216FC×70	216FD	M5
UK217	75	217FC×75	217FD	
UK218	80	218FC×80	218FD	
UKX18	80	X18C×80 (X18C3×80) ²⁾	X18D (X18D3) ²⁾	M5
UKX20	90	X20C×90 (X20C3×90) ²⁾	X20D (X20D3) ²⁾	
UK305	20	305C×20	305D	M4
UK306	25	306C×25	306D	
UK307	30	307C×30	307D	
UK308	35	308C×35	308D	M5
UK309	40	309C×40	309D	
UK310	45	310C×45	310D	
UK311	50	311C×50	311D	M5
UK312	55	312C×55	312D	
UK313	60	313C×60	313D	
–				
UK315	65	315C×65	315D	M5
UK316	70	316C×70	316D	
UK317	75	317C×75	317D	M5
UK318	80	318C×80	318D	
UK319	85	319C×85	319D	
UK320	90	320C×90	320D	M5
–				
UK322	100	322C×100	322D	
UK324	110	324C×110	324D	M5
UK326	115	326C×115	326D	M8
UK328	125	328C×125	328D	

Note ¹⁾ Items in parentheses are applicable to the pillow type (P), square four-bolt flange type (F), oval flange type (FL), and the take-up type (T) bearings, and can be mounted to housings with three hexagon socket head cap screws (use four to mount other items).

²⁾ Items in parentheses are applicable to the round flange cartridge type bearing (FC), and can be mounted to housings with three hexagon socket head cap screws (use four to mount other items).

Remark In the nominal codes of the cast iron covers for shouldered shaft, shaft diameter follows the basic code of the cover. For example, Part No. of the cover for a shaft with 60 mm diameter for UC210 is 210FC×60.

16.3 Nominal code and dimensions of grease nipples and reducing socket

Table 16.5 Nominal code and dimensions of grease nipple

(1) Nominal code and dimensions of A type grease nipple

(2) Nominal code and dimensions of B and C type grease nipples

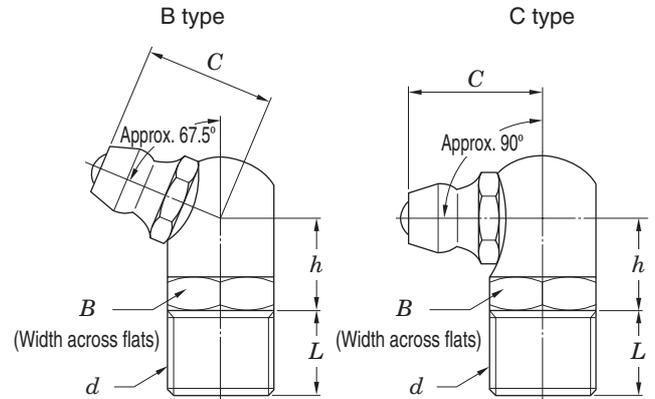
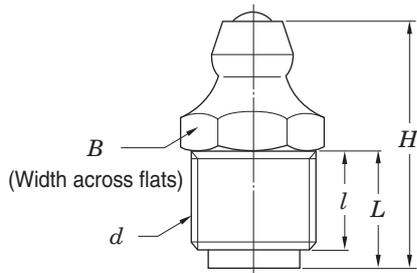

Unit : mm

Nominal grease nipple code	Nominal screw code <i>d</i>	<i>B</i>	<i>H</i>	<i>L</i>	<i>l</i>
A-1/4-28UNF type	1/4-28UNF	7	13.5	5.4	4
A-PT1/8 type	PT1/8	10	20	9.5	8

Unit : mm

Nominal grease nipple code	Nominal screw code <i>d</i>	<i>B</i>	<i>C</i>	<i>h</i>	<i>L</i>
B-1/4-28UNF type	1/4-28UNF	8	9.5	6.5	5
C-1/4-28UNF type					
B-PT1/8 type	PT1/8	10	12.5	8.5	8
C-PT1/8 type					

Table 16.6 Nominal code and dimensions of reducing socket code

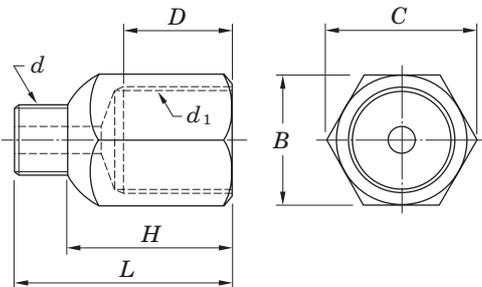

Unit : mm

Nominal code of reducing socket	Nominal male thread code <i>d</i>	Nominal female thread code <i>d</i> ₁	<i>B</i>	<i>C</i>	<i>D</i>	<i>H</i>	<i>L</i>
1/4-28UNF-PT1/8	1/4-28UNF	PT1/8	12	13.8	10	15	20
1/4-28UNF-PF1/8		PF1/8					
1/4-28UNF-PT1/4	1/4-28UNF	PT1/4	17	19.6	11	17	22
1/4-28UNF-PF1/4		PF1/4					
PT1/8-PT1/4	PT1/8	PT1/4	17	19.6	11	19	26
PT1/8-PF1/4		PF1/4					

16.4 Nominal code and dimensions of Allen key wrench

Table 16.7 Nominal code and dimensions of Allen key wrench

Unit : mm

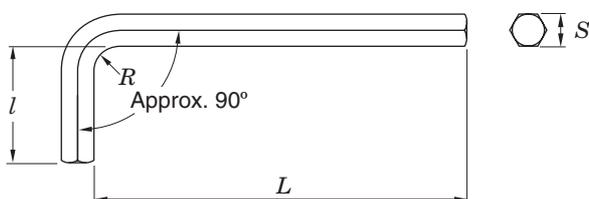

Nominal code of Allen key wrench	<i>S</i>	<i>L</i> (Approx.)	<i>l</i> (Approx.)	<i>R</i> (Approx.)	Applicable set screw
2.5	2.5	56	18	2.5	M5
3	3	63	20	3	M6
4	4	70	25	4	M8
5	5	80	28	5	M10
6	6	90	32	6	M12, M14
8	8	100	36	8	M16, M18
10	10	112	40	10	M20

17 Example of use

Carrier line

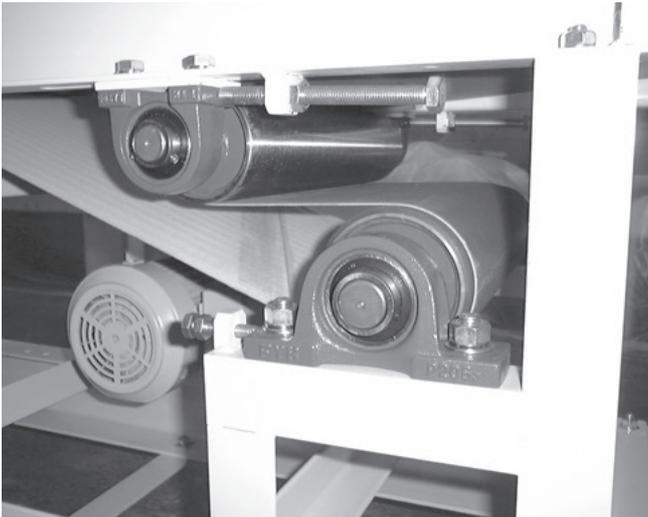

Corrugated plate molding machine

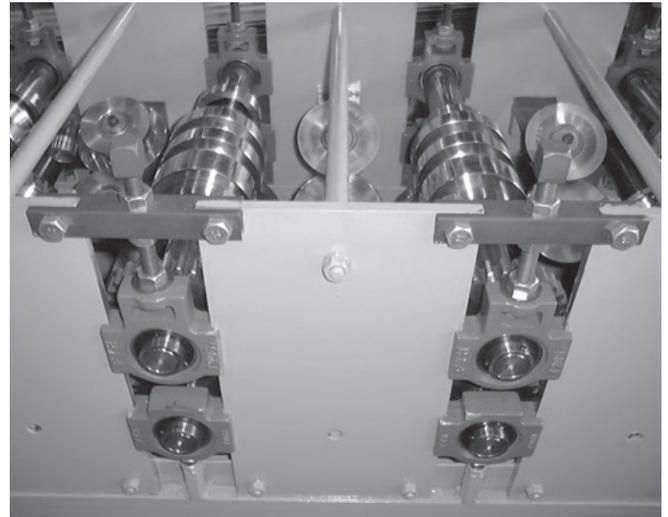

Compost treatment tank

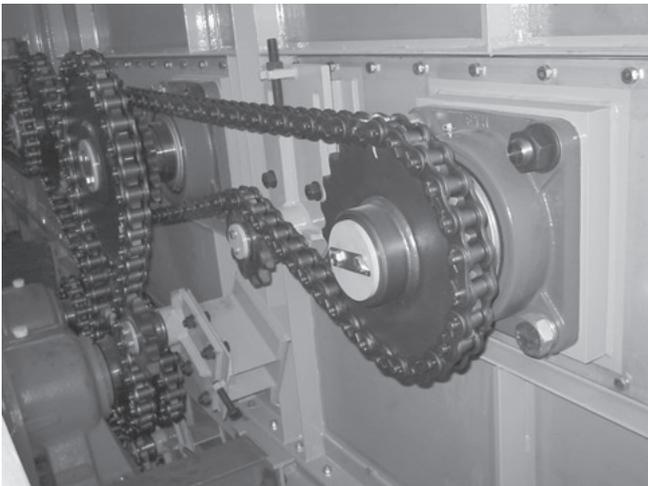

Ash removal conveyor in garbage incineration plant

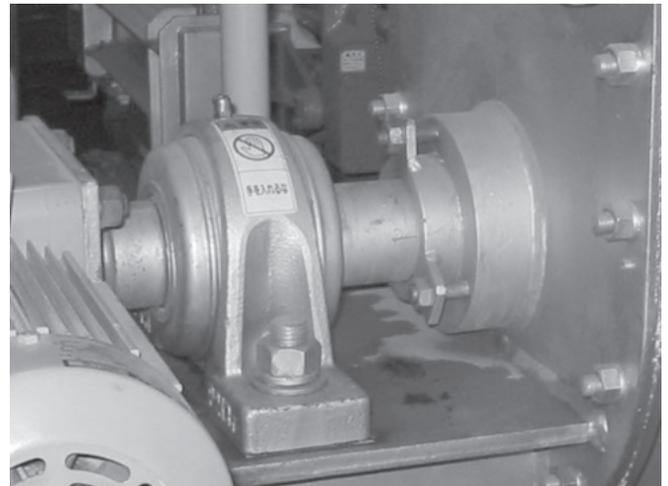

Discharge feeder

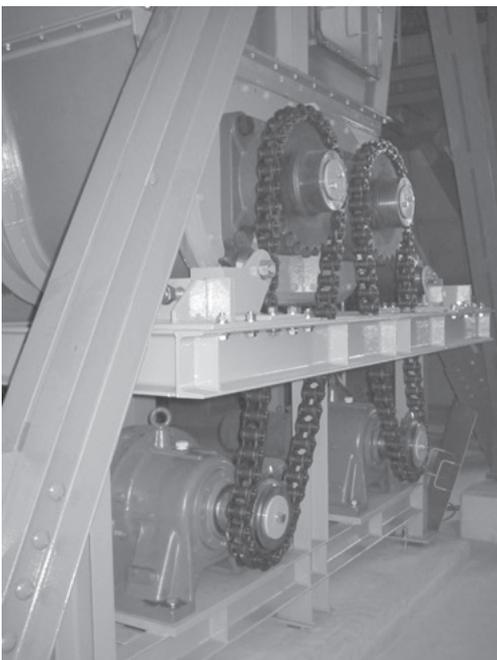

Example of use

FYH ball bearing units are used in various locations depending on applications and specifications.

- Conveyors in pickup and delivery center
- Wood working machine
- Blower
- Textile machine
- Agricultural machine
- Construction machine
- Packing machine
- Heat treatment equipment
- Wastewater treatment facility

Appendix table (contents)

1	Simplified chart of ball bearing unit combinations	240
2	Tightening torques of housings and cast iron cover mounting bolts	242
3	Tightening torques of inner rings and eccentric locking collar set screws ...	243
4	Tightening torques of adapter lock nuts (reference)	243
5	Machining dimensions of holes of housing dowel pins	244
6	Dimensional tolerances of shafts	246
7	Dimensional tolerances of housing bores	248
8	Basic tolerance values	250
9	SI unit conversion charts	251
10	Inch-meter conversion chart	252
11	Hardness conversion chart	253
12	Viscosity conversion chart	254
13	Mechanical properties of metal materials (reference).....	255
14	Hexagon socket head cap screws (abstract from JIS B 1176)	256
15	Hexagon head bolts (abstract from JIS B 1180)	258
16	Hexagon head nuts (abstract from JIS B 1181)	260
17	Comparison table of Part No. by manufacturers (cylindrical bore type)	261

Appendix table 1 Simplified chart of ball bearing unit combinations

Type	Housing for units	Ball bearing inserts							
		Cylindrical bore (with set screws)				Tapered bore (with adapter)			
		UC200	UCX00	UC300	Stainless steel UC200S6	UK200	UKX00	UK300	
Pillow type 	P200, PX00, P300 PK200	UCP200	UCPX00	UCP300		UKP200	UKPX00	UKP300	
	P200SC, P300SC	UCP200SC		UCP300SC		UKP200SC		UKP300SC	
	IP200, IP300 PA200, SPA200H1	UCIP200 UCPA200		UCIP300	UCSPA200H1S6	UKIP200		UKIP300	
	PH200 LP200	UCPH200							
Square four-bolt flange type 	P000, SP000 SP200H1 PP200				UCSP200H1S6				
	F200, FX00, F300 F200E, FX00E SF200H1 NF200 FS300	UCF200 UCF200E	UCFX00 UCFX00E	UCF300	UCSF200H1S6	UKF200	UKFX00	UKF300	
Oval flange type 	FL200, FLX00, FL300 FL200E FA200	UCFL200 UCFL200E UCFA200	UCFLX00	UCFL300		UKFL200	UKFLX00	UKFL300	
	FB200 LF200	UCFB200							
	FL000, SFL000 NFL200 SFL200H1				UCSFL200H1S6				
Round flange cartridge type 	FC200, FCX00, FCX00E	UCFC200	UCFCX00 UCFCX00E			UKFC200	UKFCX00		
Stamped steel plate flange type 	PF200 PFL200								
Take-up type 	T200, TX00, T300 T200E, TX00E ST200H1 T200+H	UCT200 UCT200E	UCTX00 UCTX200E	UCT300	UCST200H1S6	UKT200	UKTX00	UKT300	
	TL200 TU200, TU300	UCTL200 UCTU200		UCTU300		(UKTL200) (UKTU200)		(UKTU300)	
	PTH200 NPTH200								
Cartridge type 	C200, CX00, C300	UCC200	UCCX00	UCC300		UKC200	UKCX00	UKC300	
Hanger type 	HA200	UCHA200							

Appendix table 2 Tightening torques of housings and cast iron cover mounting bolts

(1) Tightening torques of housings mounting bolts (recommended)

Nominal size of screws	Tightening torques N · m
M 6	2.6– 4.7
M 8	6 – 10
M10	12 – 21
M12	21 – 37
M14	34 – 60
M16	53 – 93
M18	77 – 137
M20	104 – 186
M22	143 – 256
M27	266 – 478
M30	360 – 645
M33	494 – 886
M36	631 – 1 130

(2) Tightening torques of cast iron cover mounting bolts (recommended)

Nominal size of screws	Tightening torques, N · m	Part No. of applicable cast iron covers (reference)		
		200 series	X00 series	300 series
M3	0.3– 0.6	204, 205	–	–
M4	0.8– 1.4	204FC3 (FD3), 205FC3 (FD3), 206–215	–	305–307
M5	1.5– 2.8	216–218	X18, X20	308–324
M8	6 – 10	–	–	326, 328

Appendix table 3 Tightening torques of inner rings and eccentric locking collar set screws

(1) Tightening torques of inner rings and eccentric locking collar set screws (metric series) (recommended)

Nominal size of screws	Tightening torques, N · m	Part No. of applicable bearings						
		UC2, RB	UCX	UC3	NA	SB	SU	ER
M 3X0.35	0.7						000, 001	
M 4X0.5	1.8	–					002, 003	
M 5X0.5	3	201X–203X	–	–		201–203	004–006	–
M 6X0.75	4	201–206	X05	305, 306	–	204–207	–	201–206
M 6X1	4	–	–	–	204, 205	–		
M 8X1	8.5	207–209	X06–X08	307	206–210	208		207–209
M10X1.25	17.5	210–212	X09–X11	308, 309	211, 212	–		210–212
M12X1.5	28	213–218	X12–X17	310–314	–			–
M14X1.5	35	–	X18	315, 316				
M16X1.5	56		X20	317–319				
M18X1.5	62		–	320–324				
M20X1.5	83			326, 328				

Remark Tightening torques of set screws for UC2-S6 are identical to that of UC2. As for UC210S6, tightening torque of the set screw M8 × 1 should be applied.

(2) Tightening torques of inner rings and eccentric locking collar set screws (inch series) (recommended)

Nominal size of screws	Tightening torques, N · m	Part No. of applicable bearings		
		UC2-, ER2-, RB2-	UCX-	SB-
10-32UNF	3	–	–	201, 202
1/4-28UNF	4	201–206	X05	204–207
5/16-24UNF	8.5	207–209	X06–X08	208
3/8-24UNF	17.5	210–212	X09–X11	–
1/2-20UNF	28	213–218	X12–X18	
5/8-18UNF	56	–	X20	

Appendix table 4 Tightening torques of adapter lock nuts (reference)

Bore code	Tightening torques, N · m			Bore code	Tightening torques, N · m		
	UK200	UKX00	UK300		UK200	UKX00	UK300
05	24.5	34	29	16	196	255	441
06	29	39	44	17	225	294	530
07	39	49	59	18	265	343	608
08	49	73	78	19	–	–	706
09	59	78	117	20		490	883
10	73	108	147	22		–	1 220
11	98	137	177	24			1 470
12	127	167	225	26			1 770
13	147	196	265	28			2 150
15	167	215	373				

Appendix table 5 Machining dimensions of holes of housing dowel pins

(1) Machining dimensions of holes of pillow type housing (P) dowel pins (recommended)

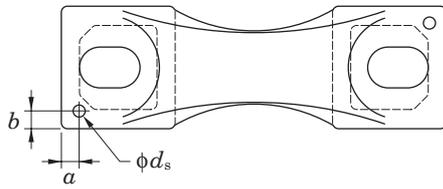

Unit : mm

Nominal code	a	b	d_s (reference)	Pin seat thickness
P203	6	6	4	12
P204	6	6	4	13
P205	6	6	4	13
P206	6	6	4	15
P207	8	8	5	16
P208	8	8	5	17
P209	8	8	5	17
P210	10	10	5	19
P211	10	10	6	19
P212	10	10	6	22
P213	10	10	6	25
P214	12	12	8	28
P215	12	12	8	28
P216	12	12	8	32
P217	12	12	8	32
P218	15	15	8	34
PX05	7	7	5	16
PX06	8	8	5	17
PX07	8	8	5	19
PX08	8	8	5	21
PX09	8	8	5	21
PX10	9	9	6	22
PX11	9	9	6	28
PX12	9	9	6	28
PX13	10	10	8	28
PX14	10	10	8	32
PX15	10	10	8	32
PX16	12	12	8	34
PX17	12	12	8	34
PX18	15	15	10	38
PX20	19	19	10	45
P305	8	8	5	16
P306	10	10	5	17
P307	10	10	5	19
P308	11	11	6	19
P309	11	11	6	21
P310	11	11	6	24
P311	12	12	8	27
P312	12	12	8	29
P313	12	12	8	32
P314	12	12	10	35
P315	14	14	10	35
P316	15	15	10	35
P317	15	15	10	40
P318	15	15	10	40
P319	15	15	10	46
P320	17	17	13	46
P321	17	17	13	46
P322	17	17	13	50
P324	17	17	13	50
P326	20	20	13	50
P328	20	20	13	60

(2) Machining dimensions of holes of cast steel pillow type housing (PSC) dowel pins (recommended)

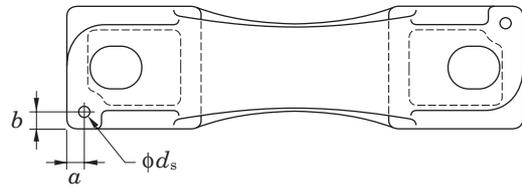

Unit : mm

Nominal code	a	b	d_s (reference)	Pin seat thickness
P205SC	7.5	6	4	16
P206SC	8.5	6	4	18
P207SC	10	6	5	19
P208SC	12	7	5	19
P209SC	10.5	8	5	20
P210SC	10	8	5	22
P211SC	12	8	6	24
P212SC	15	10	6	25
P213SC	12.5	10	6	28
P214SC	10	10	8	28
P215SC	11.5	10	8	29
P216SC	10	11	8	31
P217SC	12.5	11	8	33
P218SC	12.5	11	8	35
P310SC	14	7	6	27
P311SC	18	10	8	30
P312SC	18	10	8	32
P313SC	18	10	8	35
P314SC	17	10	10	38
P315SC	25	13	10	38
P316SC	30	13	10	38
P317SC	27	15	10	45
P318SC	27	15	10	45
P319SC	30	17	10	51
P320SC	30	18	13	51
P322SC	33	20	13	57
P324SC	33	20	13	57
P326SC	33	20	13	57
P328SC	33	20	13	70

(3) Machining dimensions of holes of square flange type housing (F) dowel pins (recommended)

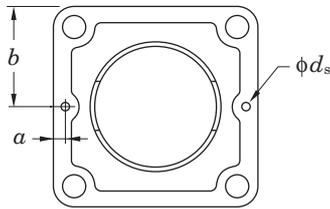

Unit : mm

Nominal code	a	b	d_s (reference)	Pin seat thickness
F204	6	43	4	11
F205	6	47.5	4	13
F206	7.5	54	4	13
F207	7.5	58.5	5	15
F208	7.5	65	5	15
F209	7.5	68.5	5	16
F210	7.5	71.5	5	16
F211	9	81	6	18
F212	9	87.5	6	18
F213	9	93.5	6	22
F214	10	96.5	8	22
F215	10	100	8	22
F216	10	104	8	22
F217	10	110	8	24
F218	10	117.5	8	25
FX05	7.5	54	5	13
FX06	7.5	58.5	5	14
FX07	7.5	65	5	14
FX08	7.5	68.5	5	14
FX09	7.5	71.5	5	14
FX10	9	81	6	20
FX11	9	87.5	6	20
FX12	9	93.5	6	21
FX13	10	93.5	8	21
FX14	10	98.5	8	22
FX15	10	142	8	24
FX16	10	107	8	24
FX17	10	155	8	24
FX18	12	155	10	24
FX20	12	134	10	28
F305	7.5	55	5	13
F306	7.5	62.5	5	15
F307	7.5	67.5	5	16
F308	9	75	6	17
F309	9	80	6	18
F310	9	87.5	6	19
F311	10	92.5	8	20
F312	10	97.5	8	22
F313	10	104	8	22
F314	12	113	10	25
F315	12	118	10	25
F316	12	125	10	27
F317	12	130	10	27
F318	12	140	10	30
F319	12	145	10	30
F320	16	155	13	32
F321	16	155	13	32
F322	16	170	13	35
F324	16	185	13	40
F326	16	205	13	45
F328	16	225	13	55

(4) Machining dimensions of holes of oval flange type housing (FL) dowel pins (recommended)

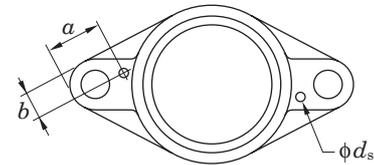

Unit : mm

Nominal code	a	b	d_s (reference)	Pin seat thickness
FL204	26	9	4	11
FL205	32	10	4	13
FL206	34	12	4	13
FL207	34	14	5	14
FL208	35	15	5	14
FL209	40	15	5	15
FL210	41	16	5	15
FL211	43	19	6	18
FL212	52	22	6	18
FL213	50	21	6	20
FL214	52	22	8	20
FL215	53	23	8	20
FL216	56	23	8	20
FL217	57	25	8	22
FL218	57	26	8	23
FLX05	27	12	5	13
FLX06	30	14	5	14
FLX07	32	15	5	14
FLX08	33	15	5	14
FLX09	35	16	5	14
FLX10	37	19	6	20
FL305	32	12	5	13
FL306	46	14	5	15
FL307	44	14	5	16
FL308	45	17	6	17
FL309	53	19	6	18
FL310	53	19	6	19
FL311	52	20	8	20
FL312	60	21	8	22
FL313	60	25	8	25
FL314	68	26	10	28
FL315	64	26	10	30
FL316	74	29	10	32
FL317	75	31	10	32
FL318	74	32	10	36
FL319	80	32	10	40
FL320	86	34	13	40
FL321	86	34	13	40
FL322	86	36	13	42
FL324	94	41	13	48
FL326	95	41	13	50
FL328	103	45	13	60

Appendix table 6 Dimensional tolerances of shafts

Classification of shaft (mm)		Tolerance range class of shaft															
Over	Incl.	d 6	e 6	f 6	g 5	g 6	h 5	h 6	h 7	h 8	h 9	h 10	js 5	js 6	js 7	j 5	j 6
3	6	-30 -38	-20 -28	-10 -18	-4 -9	-4 -12	0 -5	0 -8	0 -12	0 -18	0 -30	0 -48	± 2.5	± 4	± 6	+3 -2	+6 -2
6	10	-40 -49	-25 -34	-13 -22	-5 -11	-5 -14	0 -6	0 -9	0 -15	0 -22	0 -36	0 -58	± 3	± 4.5	± 7	+4 -2	+7 -2
10	18	-50 -61	-32 -43	-16 -27	-6 -14	-6 -17	0 -8	0 -11	0 -18	0 -27	0 -43	0 -70	± 4	± 5.5	± 9	+5 -3	+8 -3
18	30	-65 -78	-40 -53	-20 -33	-7 -16	-7 -20	0 -9	0 -13	0 -21	0 -33	0 -52	0 -84	± 4.5	± 6.5	±10	+5 -4	+9 -4
30	50	-80 -96	-50 -66	-25 -41	-9 -20	-9 -25	0 -11	0 -16	0 -25	0 -39	0 -62	0 -100	± 5.5	± 8	±12	+6 -5	+11 -5
50	80	-100 -119	-60 -79	-30 -49	-10 -23	-10 -29	0 -13	0 -19	0 -30	0 -46	0 -74	0 -120	± 6.5	± 9.5	±15	+6 -7	+12 -7
80	120	-120 -142	-72 -94	-36 -58	-12 -27	-12 -34	0 -15	0 -22	0 -35	0 -54	0 -87	0 -140	± 7.5	±11	±17	+6 -9	+13 -9
120	180	-145 -170	-85 -110	-43 -68	-14 -32	-14 -39	0 -18	0 -25	0 -40	0 -63	0 -100	0 -160	± 9	±12.5	±20	+7 -11	+14 -11
180	250	-170 -199	-100 -129	-50 -79	-15 -35	-15 -44	0 -20	0 -29	0 -46	0 -72	0 -115	0 -185	±10	±14.5	±23	+7 -13	+16 -13
250	315	-190 -222	-110 -142	-56 -88	-17 -40	-17 -49	0 -23	0 -32	0 -52	0 -81	0 -130	0 -210	±11.5	±16	±26	+7 -16	±16
315	400	-210 -246	-125 -161	-62 -98	-18 -43	-18 -54	0 -25	0 -36	0 -57	0 -89	0 -140	0 -230	±12.5	±18	±28	+7 -18	±18
400	500	-230 -270	-135 -175	-68 -108	-20 -47	-20 -60	0 -27	0 -40	0 -63	0 -97	0 -155	0 -250	±13.5	±20	±31	+7 -20	±20
500	630	-260 -304	-145 -189	-76 -120	-	-22 -66	-	0 -44	0 -70	0 -110	0 -175	0 -280	-	±22	±35	-	-
630	800	-290 -340	-160 -210	-80 -130	-	-24 -74	-	0 -50	0 -80	0 -125	0 -200	0 -320	-	±25	±40	-	-
800	1 000	-320 -376	-170 -226	-86 -142	-	-26 -82	-	0 -56	0 -90	0 -140	0 -230	0 -360	-	±28	±45	-	-

* Δ_{dmp} : Variation of tolerance of average bore diameter in plane

Unit : μm (Reference)

												Classification of shaft (mm)		Δ_{dmp}^* of bearing (class 0)
k 5	k 6	k 7	m 5	m 6	m 7	n 5	n 6	p 6	r 6	r 7	Over	Incl.		
+ 6 + 1	+ 9 + 1	+13 + 1	+ 9 + 4	+12 + 4	+ 16 + 4	+13 + 8	+ 16 + 8	+ 20 + 12	+ 23 + 15	+ 27 + 15	3	6	0 - 8	
+ 7 + 1	+10 + 1	+16 + 1	+12 + 6	+15 + 6	+ 21 + 6	+16 +10	+ 19 + 10	+ 24 + 15	+ 28 + 19	+ 34 + 19	6	10	0 - 8	
+ 9 + 1	+12 + 1	+19 + 1	+15 + 7	+18 + 7	+ 25 + 7	+20 +12	+ 23 + 12	+ 29 + 18	+ 34 + 23	+ 41 + 23	10	18	0 - 8	
+11 + 2	+15 + 2	+23 + 2	+17 + 8	+21 + 8	+ 29 + 8	+24 +15	+ 28 + 15	+ 35 + 22	+ 41 + 28	+ 49 + 28	18	30	0 - 10	
+13 + 2	+18 + 2	+27 + 2	+20 + 9	+25 + 9	+ 34 + 9	+28 +17	+ 33 + 17	+ 42 + 26	+ 50 + 34	+ 59 + 34	30	50	0 - 12	
+15 + 2	+21 + 2	+32 + 2	+24 +11	+30 +11	+ 41 + 11	+33 +20	+ 39 + 20	+ 51 + 32	+ 60 + 41	+ 71 + 41	50	65	0 - 15	
									+ 62 + 43	+ 73 + 43	65	80		
+18 + 3	+25 + 3	+38 + 3	+28 +13	+35 +13	+ 48 + 13	+38 +23	+ 45 + 23	+ 59 + 37	+ 73 + 51	+ 86 + 51	80	100	0 - 20	
									+ 76 + 54	+ 89 + 54	100	120		
+21 + 3	+28 + 3	+43 + 3	+33 +15	+40 +15	+ 55 + 15	+45 +27	+ 52 + 27	+ 68 + 43	+ 88 + 63	+103 + 63	120	140	0 - 25	
									+ 90 + 65	+105 + 65	140	160		
									+ 93 + 68	+108 + 68	160	180		
+24 + 4	+33 + 4	+50 + 4	+37 +17	+46 +17	+ 63 + 17	+51 +31	+ 60 + 31	+ 79 + 50	+106 + 77	+123 + 77	180	200	0 - 30	
									+109 + 80	+126 + 80	200	225		
									+113 + 84	+130 + 84	225	250		
+27 + 4	+36 + 4	+56 + 4	+43 +20	+52 +20	+ 72 + 20	+57 +34	+ 66 + 34	+ 88 + 56	+126 + 94	+146 + 94	250	280	0 - 35	
									+130 + 98	+150 + 98	280	315		
+29 + 4	+40 + 4	+61 + 4	+46 +21	+57 +21	+ 78 + 21	+62 +37	+ 73 + 37	+ 98 + 62	+144 +108	+165 +108	315	355	0 - 40	
									+150 +114	+171 +114	355	400		
+32 + 5	+45 + 5	+68 + 5	+50 +23	+63 +23	+ 86 + 23	+67 +40	+ 80 + 40	+108 + 68	+166 +126	+189 +126	400	450	0 - 45	
									+172 +132	+195 +132	450	500		
-	+44 0	+70 0	-	+70 +26	+ 96 + 26	-	+ 88 + 44	+122 + 78	+194 +150	+220 +150	500	560	0 - 50	
									+199 +155	+225 +155	560	630		
-	+50 0	+80 0	-	+80 +30	+110 + 30	-	+100 + 50	+138 + 88	+225 +175	+255 +175	630	710	0 - 75	
									+235 +185	+265 +185	710	800		
-	+56 0	+90 0	-	+90 +34	+124 + 34	-	+112 + 56	+156 +100	+266 +210	+300 +210	800	900	0 -100	
									+276 +220	+310 +220	900	1 000		

Appendix table 7 Dimensional tolerances of housing bores

Classification of shaft (mm)		Tolerance range class of bore														
Over	Incl.	E 6	F 6	F 7	G 6	G 7	H 6	H 7	H 8	H 9	H 10	J 6	J 7	JS 5	JS 6	JS 7
10	18	+ 43 + 32	+ 27 + 16	+ 34 + 16	+17 + 6	+ 24 + 6	+11 0	+ 18 0	+ 27 0	+ 43 0	+ 70 0	+ 6 - 5	+10 - 8	± 4	± 5.5	± 9
18	30	+ 53 + 40	+ 33 + 20	+ 41 + 20	+20 + 7	+ 28 + 7	+13 0	+ 21 0	+ 33 0	+ 52 0	+ 84 0	+ 8 - 5	+12 - 9	± 4.5	± 6.5	±10
30	50	+ 66 + 50	+ 41 + 25	+ 50 + 25	+25 + 9	+ 34 + 9	+16 0	+ 25 0	+ 39 0	+ 62 0	+100 0	+10 - 6	+14 -11	± 5.5	± 8	±12
50	80	+ 79 + 60	+ 49 + 30	+ 60 + 30	+29 +10	+ 40 + 10	+19 0	+ 30 0	+ 46 0	+ 74 0	+120 0	+13 - 6	+18 -12	± 6.5	± 9.5	±15
80	120	+ 94 + 72	+ 58 + 36	+ 71 + 36	+34 +12	+ 47 + 12	+22 0	+ 35 0	+ 54 0	+ 87 0	+140 0	+16 - 6	+22 -13	± 7.5	±11	±17
120	180	+110 + 85	+ 68 + 43	+ 83 + 43	+39 +14	+ 54 + 14	+25 0	+ 40 0	+ 63 0	+100 0	+160 0	+18 - 7	+26 -14	± 9	±12.5	±20
180	250	+129 +100	+ 79 + 50	+ 96 + 50	+44 +15	+ 61 + 15	+29 0	+ 46 0	+ 72 0	+115 0	+185 0	+22 - 7	+30 -16	±10	±14.5	±23
250	315	+142 +110	+ 88 + 56	+108 + 56	+49 +17	+ 69 + 17	+32 0	+ 52 0	+ 81 0	+130 0	+210 0	+25 - 7	+36 -16	±11.5	±16	±26
315	400	+161 +125	+ 98 + 62	+119 + 62	+54 +18	+ 75 + 18	+36 0	+ 57 0	+ 89 0	+140 0	+230 0	+29 - 7	+39 -18	±12.5	±18	±28
400	500	+175 +135	+108 + 68	+131 + 68	+60 +20	+ 83 + 20	+40 0	+ 63 0	+ 97 0	+155 0	+250 0	+33 - 7	+43 -20	±13.5	±20	±31
500	630	+189 +145	+120 + 76	+146 + 76	+66 +22	+ 92 + 22	+44 0	+ 70 0	+110 0	+175 0	+280 0	-	-	-	±22	±35
630	800	+210 +160	+130 + 80	+160 + 80	+74 +24	+104 + 24	+50 0	+ 80 0	+125 0	+200 0	+320 0	-	-	-	±25	±40
800	1 000	+226 +170	+142 + 86	+176 + 86	+82 +26	+116 + 26	+56 0	+ 90 0	+140 0	+230 0	+360 0	-	-	-	±28	±45
1 000	1 250	+261 +195	+164 + 98	+203 + 98	+94 +28	+133 + 28	+66 0	+105 0	+165 0	+260 0	+420 0	-	-	-	±33	±52

* ΔD_{mp} : Variation of tolerance of average outside diameter in plate

Unit : μm (Reference)

													Classification of basic size (mm)		Δ_{Dmp}^* of bearing (class 0)
K 5	K 6	K 7	M 5	M 6	M 7	N 5	N 6	N 7	P 6	P 7	R 7	Over	Incl.		
+ 2 - 6	+ 2 - 9	+ 6 - 12	- 4 - 12	- 4 - 15	0 - 18	- 9 - 17	- 9 - 20	- 5 - 23	- 15 - 26	- 11 - 29	- 16 - 34	10	18	0 - 8	
+ 1 - 8	+ 2 - 11	+ 6 - 15	- 5 - 14	- 4 - 17	0 - 21	- 12 - 21	- 11 - 24	- 7 - 28	- 18 - 31	- 14 - 35	- 20 - 41	18	30	0 - 9	
+ 2 - 9	+ 3 - 13	+ 7 - 18	- 5 - 16	- 4 - 20	0 - 25	- 13 - 24	- 12 - 28	- 8 - 33	- 21 - 37	- 17 - 42	- 25 - 50	30	50	0 - 11	
+ 3 - 10	+ 4 - 15	+ 9 - 21	- 6 - 19	- 5 - 24	0 - 30	- 15 - 28	- 14 - 33	- 9 - 39	- 26 - 45	- 21 - 51	- 30 - 60	50	65	0 - 13	
											- 32 - 62	65	80		
+ 2 - 13	+ 4 - 18	+ 10 - 25	- 8 - 23	- 6 - 28	0 - 35	- 18 - 33	- 16 - 38	- 10 - 45	- 30 - 52	- 24 - 59	- 38 - 73	80	100	0 - 15	
											- 41 - 76	100	120		
+ 3 - 15	+ 4 - 21	+ 12 - 28	- 9 - 27	- 8 - 33	0 - 40	- 21 - 39	- 20 - 45	- 12 - 52	- 36 - 61	- 28 - 68	- 48 - 88	120	140	(150 max.) 0	
											- 50 - 90	140	160	- 18 (Over 150)	
											- 53 - 93	160	180	0 - 25	
+ 2 - 18	+ 5 - 24	+ 13 - 33	- 11 - 31	- 8 - 37	0 - 46	- 25 - 45	- 22 - 51	- 14 - 60	- 41 - 70	- 33 - 79	- 60 - 106	180	200	0 - 30	
											- 63 - 109	200	225		
											- 67 - 113	225	250		
+ 3 - 20	+ 5 - 27	+ 16 - 36	- 13 - 36	- 9 - 41	0 - 52	- 27 - 50	- 25 - 57	- 14 - 66	- 47 - 79	- 36 - 88	- 74 - 126	250	280	0 - 35	
											- 78 - 130	280	315		
											- 87 - 144	315	355		
+ 3 - 22	+ 7 - 29	+ 17 - 40	- 14 - 39	- 10 - 46	0 - 57	- 30 - 55	- 26 - 62	- 16 - 73	- 51 - 87	- 41 - 98	- 93 - 150	355	400	0 - 40	
											- 103 - 166	400	450		
											- 109 - 172	450	500		
-	0 - 44	0 - 70	-	- 26 - 70	- 26 - 96	-	- 44 - 88	- 44 - 114	- 78 - 122	- 78 - 148	- 150 - 220	500	560	0 - 50	
											- 155 - 225	560	630		
-	0 - 50	0 - 80	-	- 30 - 80	- 30 - 110	-	- 50 - 100	- 50 - 130	- 88 - 138	- 88 - 168	- 175 - 255	630	710	0 - 75	
											- 185 - 265	710	800		
-	0 - 56	0 - 90	-	- 34 - 90	- 34 - 124	-	- 56 - 112	- 56 - 146	- 100 - 156	- 100 - 190	- 210 - 300	800	900	0 - 100	
											- 220 - 310	900	1 000		
											- 250 - 355	1 000	1 120		
-	0 - 66	0 - 105	-	- 40 - 106	- 40 - 145	-	- 66 - 132	- 66 - 171	- 120 - 186	- 120 - 225	- 260 - 365	1 120	1 250	0 - 125	
											- 260 - 365	1 120	1 250		

Appendix table 8 Basic tolerance values

Classification of basic size (mm)		Tolerance class (IT)																	
		1	2	3	4	5	6	7	8	9	10	11	12	13	14 ¹⁾	15 ¹⁾	16 ¹⁾	17 ¹⁾	18 ¹⁾
Over	Incl.	Basic tolerance value (μm)											Basic tolerance value (mm)						
–	3	0.8	1.2	2	3	4	6	10	14	25	40	60	0.10	0.14	0.26	0.40	0.60	1.00	1.40
3	6	1	1.5	2.5	4	5	8	12	18	30	48	75	0.12	0.18	0.30	0.48	0.75	1.20	1.80
6	10	1	1.5	2.5	4	6	9	15	22	36	58	90	0.15	0.22	0.36	0.58	0.90	1.50	2.20
10	18	1.2	2	3	5	8	11	18	27	43	70	110	0.18	0.27	0.43	0.70	1.10	1.80	2.70
18	30	1.5	2.5	4	6	9	13	21	33	52	84	130	0.21	0.33	0.52	0.84	1.30	2.10	3.30
30	50	1.5	2.5	4	7	11	16	25	39	62	100	160	0.25	0.39	0.62	1.00	1.60	2.50	3.90
50	80	2	3	5	8	13	19	30	46	74	120	190	0.30	0.46	0.74	1.20	1.90	3.00	4.60
80	120	2.5	4	6	10	15	22	35	54	87	140	220	0.35	0.54	0.87	1.40	2.20	3.50	5.40
120	180	3.5	5	8	12	18	25	40	63	100	160	250	0.40	0.63	1.00	1.60	2.50	4.00	6.30
180	250	4.5	7	10	14	20	29	46	72	115	185	290	0.46	0.72	1.15	1.85	2.90	4.60	7.20
250	315	6	8	12	16	23	32	52	81	130	210	320	0.52	0.81	1.30	2.10	3.20	5.20	8.10
315	400	7	9	13	18	25	36	57	89	140	230	360	0.57	0.89	1.40	2.30	3.60	5.70	8.90
400	500	8	10	15	20	27	40	63	97	155	250	400	0.63	0.97	1.55	2.50	4.00	6.30	9.70
500	630	–	–	–	–	–	44	70	110	175	280	440	0.70	1.10	1.75	2.80	4.40	7.00	11.00
630	800	–	–	–	–	–	50	80	125	200	320	500	0.80	1.25	2.00	3.20	5.00	8.00	12.50
800	1 000	–	–	–	–	–	56	90	140	230	360	560	0.90	1.40	2.30	3.60	5.60	9.00	14.00
1 000	1 250	–	–	–	–	–	66	105	165	260	420	660	1.05	1.65	2.60	4.20	6.60	10.50	16.50
1 250	1 600	–	–	–	–	–	78	125	195	310	500	780	1.25	1.95	3.10	5.00	7.80	12.50	19.50
1 600	2 000	–	–	–	–	–	92	150	230	370	600	920	1.50	2.30	3.70	6.00	9.20	15.00	23.00
2 000	2 500	–	–	–	–	–	110	175	280	440	700	1 100	1.75	2.80	4.40	7.00	11.00	17.50	28.00
2 500	3 150	–	–	–	–	–	135	210	330	540	860	1 350	2.10	3.30	5.40	8.60	13.50	21.00	33.00

Note ¹⁾ Tolerance classes from IT14 to IT18 can not be applied to basic size 1 mm or less.

Appendix table 9 SI unit conversion charts

Force

N	dyn	kgf
1	1×10^5	$1.019\,72 \times 10^{-1}$
1×10^{-5}	1	$1.019\,72 \times 10^{-6}$
9.806 65	$9.806\,65 \times 10^5$	1

Moment of force (torque)

N · m	mN · m	$\mu\text{N} \cdot \text{m}$	kgf · m	kgf · cm	gf · cm
1	1×10^3	1×10^6	$1.019\,72 \times 10^{-1}$	$1.019\,72 \times 10$	$1.019\,72 \times 10^4$
1×10^{-3}	1	1×10^3	$1.019\,72 \times 10^{-4}$	$1.019\,72 \times 10^{-2}$	$1.019\,72 \times 10$
1×10^{-6}	1×10^{-3}	1	$1.019\,72 \times 10^{-7}$	$1.019\,72 \times 10^{-5}$	$1.019\,72 \times 10^{-2}$
9.806 65	$9.806\,65 \times 10^3$	$9.806\,65 \times 10^6$	1	1×10^2	1×10^5
$9.806\,65 \times 10^{-2}$	$9.806\,65 \times 10$	$9.806\,65 \times 10^4$	1×10^{-2}	1	1×10^3
$9.806\,65 \times 10^{-5}$	$9.806\,65 \times 10^{-2}$	$9.806\,65 \times 10$	1×10^{-5}	1×10^{-3}	1

Stress

Pa or N/m ²	MPa or N/mm ²	kgf/mm ²	kgf/cm ²
1	1×10^{-6}	$1.019\,72 \times 10^{-7}$	$1.019\,72 \times 10^{-5}$
1×10^6	1	$1.019\,72 \times 10^{-1}$	$1.019\,72 \times 10$
$9.806\,65 \times 10^6$	9.806 65	1	1×10^2
$9.806\,65 \times 10^4$	$9.806\,65 \times 10^{-2}$	1×10^{-2}	1

Remark 1 Pa = 1 N/m², 1 MPa = 1 N/mm²

Pressure

Pa	kPa	MPa	bar	kgf/cm ²	atm	mmH ₂ O	mmHg or Torr
1	1×10^{-3}	1×10^{-6}	1×10^{-5}	$1.019\,72 \times 10^{-5}$	$9.869\,23 \times 10^{-6}$	$1.019\,72 \times 10^{-1}$	$7.500\,62 \times 10^{-3}$
1×10^3	1	1×10^{-3}	1×10^{-2}	$1.019\,72 \times 10^{-2}$	$9.869\,23 \times 10^{-3}$	$1.019\,72 \times 10^2$	7.500 62
1×10^6	1×10^3	1	1 × 10	$1.019\,72 \times 10$	9.869 23	$1.019\,72 \times 10^5$	$7.500\,62 \times 10^3$
1×10^5	1×10^2	1×10^{-1}	1	1.019 72	$9.869\,23 \times 10^{-1}$	$1.019\,72 \times 10^4$	$7.500\,62 \times 10^2$
$9.806\,65 \times 10^4$	$9.806\,65 \times 10$	$9.806\,65 \times 10^{-2}$	$9.806\,65 \times 10^{-1}$	1	$9.678\,41 \times 10^{-1}$	1×10^4	$7.355\,59 \times 10^2$
$1.013\,25 \times 10^5$	$1.013\,25 \times 10^2$	$1.013\,25 \times 10^{-1}$	1.013 25	1.033 23	1	$1.033\,23 \times 10^4$	$7.600\,00 \times 10^2$
9.806 65	$9.806\,65 \times 10^{-3}$	$9.806\,65 \times 10^{-6}$	$9.806\,65 \times 10^{-5}$	1×10^{-4}	$9.678\,41 \times 10^{-5}$	1	$7.355\,59 \times 10^{-2}$
$1.333\,22 \times 10^2$	$1.333\,22 \times 10^{-1}$	$1.333\,22 \times 10^{-4}$	$1.333\,22 \times 10^{-3}$	$1.359\,51 \times 10^{-3}$	$1.315\,79 \times 10^{-3}$	$1.359\,51 \times 10$	1

Remark 1 Pa = 1 N/m²

Kinematic viscosity

m ² /s	cSt	St
1	1×10^6	1×10^4
1×10^{-6}	1	1×10^{-2}
1×10^{-4}	1×10^2	1

Remark 1 cSt = 1 mm²/s, 1 St = 1 cm²/s

Appendix table 10 Inch-meter conversion chart

Inch	Inches											
	0	1	2	3	4	5	6	7	8	9	10	
	mm											
0	0	0	25.4000	50.8000	76.2000	101.6000	127.0000	152.4000	177.8000	203.2000	228.6000	254.0000
1/64	0.015625	0.3969	25.7969	51.1969	76.5969	101.9969	127.3969	152.7969	178.1969	203.5969	228.9969	254.3969
1/32	0.03125	0.7938	26.1938	51.5938	76.9938	102.3938	127.7938	153.1938	178.5938	203.9938	229.3938	254.7938
3/64	0.046875	1.1906	26.5906	51.9906	77.3906	102.7906	128.1906	153.5906	178.9906	204.3906	229.7906	255.1906
1/16	0.0625	1.5875	26.9875	52.3875	77.7875	103.1875	128.5875	153.9875	179.3875	204.7875	230.1875	255.5875
5/64	0.078125	1.9844	27.3844	52.7844	78.1844	103.5844	128.9844	154.3844	179.7844	205.1844	230.5844	255.9844
3/32	0.09375	2.3812	27.7812	53.1812	78.5812	103.9812	129.3812	154.7812	180.1812	205.5812	230.9812	256.3812
7/64	0.109375	2.7781	28.1781	53.5781	78.9781	104.3781	129.7781	155.1781	180.5781	205.9781	231.3781	256.7781
1/8	0.125	3.1750	28.5750	53.9750	79.3750	104.7750	130.1750	155.5750	180.9750	206.3750	231.7750	257.1750
9/64	0.140625	3.5719	28.9719	54.3719	79.7719	105.1719	130.5719	155.9719	181.3719	206.7719	232.1719	257.5719
5/32	0.15625	3.9688	29.3688	54.7688	80.1688	105.5688	130.9688	156.3688	181.7688	207.1688	232.5688	257.9688
11/64	0.171875	4.3656	29.7656	55.1656	80.5656	105.9656	131.3656	156.7656	182.1656	207.5656	232.9656	258.3656
3/16	0.1875	4.7625	30.1625	55.5625	80.9625	106.3625	131.7625	157.1625	182.5625	207.9625	233.3625	258.7625
13/64	0.203125	5.1594	30.5594	55.9594	81.3594	106.7594	132.1594	157.5594	182.9594	208.3594	233.7594	259.1594
7/32	0.21875	5.5562	30.9562	56.3562	81.7562	107.1562	132.5562	157.9562	183.3562	208.7562	234.1562	259.5562
15/64	0.234375	5.9531	31.3531	56.7531	82.1531	107.5531	132.9531	158.3531	183.7531	209.1531	234.5531	259.9531
1/4	0.25	6.3500	31.7500	57.1500	82.5500	107.9500	133.3500	158.7500	184.1500	209.5500	234.9500	260.3500
17/64	0.265625	6.7469	32.1469	57.5469	82.9469	108.3469	133.7469	159.1469	184.5469	209.9469	235.3469	260.7469
9/32	0.28125	7.1438	32.5438	57.9438	83.3438	108.7438	134.1438	159.5438	184.9438	210.3438	235.7438	261.1438
19/64	0.296875	7.5406	32.9406	58.3406	83.7406	109.1406	134.5406	159.9406	185.3406	210.7406	236.1406	261.5406
5/16	0.3125	7.9375	33.3375	58.7375	84.1375	109.5375	134.9375	160.3375	185.7375	211.1375	236.5375	261.9375
21/64	0.328125	8.3344	33.7344	59.1344	84.5344	109.9344	135.3344	160.7344	186.1344	211.5344	236.9344	262.3344
11/32	0.34375	8.7312	34.1312	59.5312	84.9312	110.3312	135.7312	161.1312	186.5312	211.9312	237.3312	262.7312
23/64	0.359375	9.1281	34.5281	59.9281	85.3281	110.7281	136.1281	161.5281	186.9281	212.3281	237.7281	263.1281
3/8	0.375	9.5250	34.9250	60.3250	85.7250	111.1250	136.5250	161.9250	187.3250	212.7250	238.1250	263.5250
25/64	0.390625	9.9219	35.3219	60.7219	86.1219	111.5219	136.9219	162.3219	187.7219	213.1219	238.5219	263.9219
13/32	0.40625	10.3188	35.7188	61.1188	86.5188	111.9188	137.3188	162.7188	188.1188	213.5188	238.9188	264.3188
27/64	0.421875	10.7156	36.1156	61.5156	86.9156	112.3156	137.7156	163.1156	188.5156	213.9156	239.3156	264.7156
7/16	0.4375	11.1125	36.5125	61.9125	87.3125	112.7125	138.1125	163.5125	188.9125	214.3125	239.7125	265.1125
29/64	0.453125	11.5094	36.9094	62.3094	87.7094	113.1094	138.5094	163.9094	189.3094	214.7094	240.1094	265.5094
15/32	0.46875	11.9062	37.3062	62.7062	88.1062	113.5062	138.9062	164.3062	189.7062	215.1062	240.5062	265.9062
31/64	0.484375	12.3031	37.7031	63.1031	88.5031	113.9031	139.3031	164.7031	190.1031	215.5031	240.9031	266.3031
1/2	0.5	12.7000	38.1000	63.5000	88.9000	114.3000	139.7000	165.1000	190.5000	215.9000	241.3000	266.7000
33/64	0.515625	13.0969	38.4969	63.8969	89.2969	114.6969	140.0969	165.4969	190.8969	216.2969	241.6969	267.0969
17/32	0.53125	13.4938	38.8938	64.2938	89.6938	115.0938	140.4938	165.8938	191.2938	216.6938	242.0938	267.4938
35/64	0.546875	13.8906	39.2906	64.6906	90.0906	115.4906	140.8906	166.2906	191.6906	217.0906	242.4906	267.8906
9/16	0.5625	14.2875	39.6875	65.0875	90.4875	115.8875	141.2875	166.6875	192.0875	217.4875	242.8875	268.2875
37/64	0.578125	14.6844	40.0844	65.4844	90.8844	116.2844	141.6844	167.0844	192.4844	217.8844	243.2844	268.6844
19/32	0.59375	15.0812	40.4812	65.8812	91.2812	116.6812	142.0812	167.4812	192.8812	218.2812	243.6812	269.0812
39/64	0.609375	15.4781	40.8781	66.2781	91.6781	117.0781	142.4781	167.8781	193.2781	218.6781	244.0781	269.4781
5/8	0.625	15.8750	41.2750	66.6750	92.0750	117.4750	142.8750	168.2750	193.6750	219.0750	244.4750	269.8750
41/64	0.640625	16.2719	41.6719	67.0719	92.4719	117.8719	143.2719	168.6719	194.0719	219.4719	244.8719	270.2719
21/32	0.65625	16.6688	42.0688	67.4688	92.8688	118.2688	143.6688	169.0688	194.4688	219.8688	245.2688	270.6688
43/64	0.671875	17.0656	42.4656	67.8656	93.2656	118.6656	144.0656	169.4656	194.8656	220.2656	245.6656	271.0656
11/16	0.6875	17.4625	42.8625	68.2625	93.6625	119.0625	144.4625	169.8625	195.2625	220.6625	246.0625	271.4625
45/64	0.703125	17.8594	43.2594	68.6594	94.0594	119.4594	144.8594	170.2594	195.6594	221.0594	246.4594	271.8594
23/32	0.71875	18.2562	43.6562	69.0562	94.4562	119.8562	145.2562	170.6562	196.0562	221.4562	246.8562	272.2562
47/64	0.734375	18.6531	44.0531	69.4531	94.8531	120.2531	145.6531	171.0531	196.4531	221.8531	247.2531	272.6531
3/4	0.75	19.0500	44.4500	69.8500	95.2500	120.6500	146.0500	171.4500	196.8500	222.2500	247.6500	273.0500
49/64	0.765625	19.4469	44.8469	70.2469	95.6469	121.0469	146.4469	171.8469	197.2469	222.6469	248.0469	273.4469
25/32	0.78125	19.8438	45.2438	70.6438	96.0438	121.4438	146.8438	172.2438	197.6438	223.0438	248.4438	273.8438
51/64	0.796875	20.2406	45.6406	71.0406	96.4406	121.8406	147.2406	172.6406	198.0406	223.4406	248.8406	274.2406
13/16	0.8125	20.6375	46.0375	71.4375	96.8375	122.2375	147.6375	173.0375	198.4375	223.8375	249.2375	274.6375
53/64	0.828125	21.0344	46.4344	71.8344	97.2344	122.6344	148.0344	173.4344	198.8344	224.2344	249.6344	275.0344
27/32	0.84375	21.4312	46.8312	72.2312	97.6312	123.0312	148.4312	173.8312	199.2312	224.6312	250.0312	275.4312
55/64	0.859375	21.8281	47.2281	72.6281	98.0281	123.4281	148.8281	174.2281	199.6281	225.0281	250.4281	275.8281
7/8	0.875	22.2250	47.6250	73.0250	98.4250	123.8250	149.2250	174.6250	200.0250	225.4250	250.8250	276.2250
57/64	0.890625	22.6219	48.0219	73.4219	98.8219	124.2219	149.6219	175.0219	200.4219	225.8219	251.2219	276.6219
29/32	0.90625	23.0188	48.4188	73.8188	99.2188	124.6188	150.0188	175.4188	200.8188	226.2188	251.6188	277.0188
59/64	0.921875	23.4156	48.8156	74.2156	99.6156	125.0156	150.4156	175.8156	201.2156	226.6156	252.0156	277.4156
15/16	0.9375	23.8125	49.2125	74.6125	100.0125	125.4125	150.8125	176.2125	201.6125	227.0125	252.4125	277.8125
61/64	0.953125	24.2094	49.6094	75.0094	100.4094	125.8094	151.2094	176.6094	202.0094	227.4094	252.8094	278.2094
31/32	0.96875	24.6062	50.0062	75.4062	100.8062	126.2062	151.6062	177.0062	202.4062	227.8062	253.2062	278.6062
63/64	0.984375	25.0031	50.4031	75.8031	101.2031	126.6031	152.0031	177.4031	202.8031	228.2031	253.6031</	

Appendix table 11 Hardness conversion chart

Rockwell C scale 1 471.0 N (150 kgf)	Vickers	Brinell		Rockwell		Shore
		Standard steel ball	Tungsten carbide steel ball	A scale 588.4 N (60 kgf)	B scale 980.7 N (100 kgf)	
68	940			85.6		97
67	900			85.0		95
66	865			84.5		92
65	832		739	83.9		91
64	800		722	83.4		88
63	772		705	82.8		87
62	746		688	82.3		85
61	720		670	81.8		83
60	697		654	81.2		81
59	674		634	80.7		80
58	653		615	80.1		78
57	633		595	79.6		76
56	613		577	79.0		75
55	595	–	560	78.5		74
54	577	–	543	78.0		72
53	560	–	525	77.4		71
52	544	500	512	76.8		69
51	528	487	496	76.3		68
50	513	475	481	75.9		67
49	498	464	469	75.2		66
48	484	451	455	74.7		64
47	471	442	443	74.1		63
46	458	432	432	73.6		62
45	446		421	73.1		60
44	434		409	72.5		58
43	423		400	72.0		57
42	412		390	71.5		56
41	402		381	70.9		55
40	392		371	70.4	–	54
39	382		362	69.9	–	52
38	372		353	69.4	–	51
37	363		344	68.9	–	50
36	354		336	68.4	(109.0)	49
35	345		327	67.9	(108.5)	48
34	336		319	67.4	(108.0)	47
33	327		311	66.8	(107.5)	46
32	318		301	66.3	(107.0)	44
31	310		294	65.8	(106.0)	43
30	302		286	65.3	(105.5)	42
29	294		279	64.7	(104.5)	41
28	286		271	64.3	(104.0)	41
27	279		264	63.8	(103.0)	40
26	272		258	63.3	(102.5)	38
25	266		253	62.8	(101.5)	38
24	260		247	62.4	(101.0)	37
23	254		243	62.0	100.0	36
22	248		237	61.5	99.0	35
21	243		231	61.0	98.5	35
20	238		226	60.5	97.8	34
(18)	230		219	–	96.7	33
(16)	222		212	–	95.5	32
(14)	213		203	–	93.9	31
(12)	204		194	–	92.3	29
(10)	196		187		90.7	28
(8)	188		179		89.5	27
(6)	180		171		87.1	26
(4)	173		165		85.5	25
(2)	166		158		83.5	24
(0)	160		152		81.7	24

Appendix table 12 Viscosity conversion chart

Kinematic viscosity mm ² /s	Saybolt SUS (second)		Redwood R (second)		Engler E (degree)
	100 °F	210 °F	50 °C	100 °C	
2	32.6	32.8	30.8	31.2	1.14
3	36.0	36.3	33.3	33.7	1.22
4	39.1	39.4	35.9	36.5	1.31
5	42.3	42.6	38.5	39.1	1.40
6	45.5	45.8	41.1	41.7	1.48
7	48.7	49.0	43.7	44.3	1.56
8	52.0	52.4	46.3	47.0	1.65
9	55.4	55.8	49.1	50.0	1.75
10	58.8	59.2	52.1	52.9	1.84
11	62.3	62.7	55.1	56.0	1.93
12	65.9	66.4	58.2	59.1	2.02
13	69.6	70.1	61.4	62.3	2.12
14	73.4	73.9	64.7	65.6	2.22
15	77.2	77.7	68.0	69.1	2.32
16	81.1	81.7	71.5	72.6	2.43
17	85.1	85.7	75.0	76.1	2.54
18	89.2	89.8	78.6	79.7	2.64
19	93.3	94.0	82.1	83.6	2.76
20	97.5	98.2	85.8	87.4	2.87
21	102	102	89.5	91.3	2.98
22	106	107	93.3	95.1	3.10
23	110	111	97.1	98.9	3.22
24	115	115	101	103	3.34
25	119	120	105	107	3.46
26	123	124	109	111	3.58
27	128	129	112	115	3.70
28	132	133	116	119	3.82
29	137	138	120	123	3.95
30	141	142	124	127	4.07
31	145	146	128	131	4.20
32	150	150	132	135	4.32
33	154	155	136	139	4.45
34	159	160	140	143	4.57

Kinematic viscosity mm ² /s	Saybolt SUS (second)		Redwood R (second)		Engler E (degree)
	100 °F	210 °F	50 °C	100 °C	
35	163	164	144	147	4.70
36	168	170	148	151	4.83
37	172	173	153	155	4.96
38	177	178	156	159	5.08
39	181	183	160	164	5.21
40	186	187	164	168	5.34
41	190	192	168	172	5.47
42	195	196	172	176	5.59
43	199	201	176	180	5.72
44	204	205	180	185	5.85
45	208	210	184	189	5.98
46	213	215	188	193	6.11
47	218	219	193	197	6.24
48	222	224	197	202	6.37
49	227	228	201	206	6.50
50	231	233	205	210	6.63
55	254	256	225	231	7.24
60	277	279	245	252	7.90
65	300	302	266	273	8.55
70	323	326	286	294	9.21
75	346	349	306	315	9.89
80	371	373	326	336	10.5
85	394	397	347	357	11.2
90	417	420	367	378	11.8
95	440	443	387	399	12.5
100	464	467	408	420	13.2
120	556	560	490	504	15.8
140	649	653	571	588	18.4
160	742	747	653	672	21.1
180	834	840	734	757	23.7
200	927	933	816	841	26.3
250	1 159	1 167	1 020	1 051	32.9
300	1 391	1 400	1 224	1 241	39.5

Remark 1 mm²/s = 1 cSt (centistokes)

Appendix table 13 Mechanical properties of metal materials (reference)

(1) Modulus of longitudinal elasticity, elastic limit, and ultimate strength

Material	Main components and others	Specific gravity	Modulus of longitudinal elasticity (GPa)	Elastic limit σ_e (MPa)	Ultimate strength (MPa)		
					Tensile K_t	Compression K_c	Shear K_s
Gray cast iron (FC150)		7.1–7.3	69	29	118	590	108
(FC200)		7.1–7.3	98	88	137– 216	740	206
(FC250)		7.1–7.3	103	88	176– 314	880	206
White heart malleable cast iron	Residual carbon : 1.6% or less	7.1–7.3	158	196	314– 392	820	382
Black heart malleable cast iron		7.2–7.6	158	196	274– 392	820	382
Carbon steel	General	7.7–7.8	196–216	176–245	314– 830	–	–
Extra mild steel	C 0.05–0.15%	7.8	196	118	Over 372	Virtually identical to tensile strength, provided buckling can be ignored	0.8 K_t
Mild steel	C 0.15–0.25%	7.8	204	157	372– 392		0.75 K_t
Middle hard steel	C 0.25–0.40%	7.8	206	245–294	490– 590		0.75 K_t
Hard steel	C 0.40–0.50%	7.8	216	343	590– 690		0.7 K_t
Maximum hard steel	C 0.50–0.65%	7.8	216	372	690– 830		0.65 K_t
Mild steel	C 0.18% hot rolling	7.8	206	176	421		314
Hard steel	Oil hardening, tempering at 700 °C	7.8	206	343	590		461
Tool steel	C 0.60–1.50% hardening	7.8	216	441	660	820	
Cast steel	General	7.8–7.9	206–211	176–245	343– 600	343–600	284–382
Cast steel (mild)	C 0.15–0.22%	7.8–7.9	206	196	363– 431	363–431	284
Cast steel (middle hard)	C 0.22–0.30%	7.8–7.9	211	225	392– 490	392–490	333
Cast steel (hard)	C 0.30–0.40%	7.9	211	245	490– 590	490–590	382
Nickel steel	C 0.25–0.35% Ni 2–5%	7.85	206–216	333	640– 830	640	401
Chrome steel	C 0.13–0.48% Cr 0.9–1.2%	7.85	206–216	–	780– 980	–	–
Nickel chrome steel	C, Ni, Cr included	7.85	206–216	–	740– 980	–	382–500
Chromium molybdenum steel	C, Cr, Mo included	7.85	206–216	–	830– 980	–	–
Manganese steel	C 0.2–0.46% Mn 1–1.4%	7.85	206–216	–	440–1 080	–	–
Spring steel		7.86	216	735	1 080–1 670	1 670	–
Stainless steel	C, Cr, Ni included	7.75	206–216	–	620	–	410
Brass casting	Cu 60% Zn 40%	8.5	69	–	176– 216	108	147
Brass (forged plate)	Cu 60% Zn 40%	8.4	78– 98	–	274– 392	314	206
Brass (forged rod)	Cu 60% Zn 40%	8.4	82	–	520	314	314
Phosphor bronze casting	Cu 90% Sn 10% P 0.1%	8.8	93–103	–	196– 294	137	176
Phosphor bronze (forging)	Cu 90% Sn 10% P 0.1%	8.8	132	–	294– 980	206	382
Tin		7.28	39– 54	–	27	–	–
Lead		11.34	15– 17	–	20	–	–
Zinc		7.1	78–127	–	78– 176	–	–

(2) Allowable stress

Unit : MPa

Material	Tensile K_t			Compression K_c		Bending K_b			Shear K_s			Torsion K_d		
	<i>a</i>	<i>b</i>	<i>c</i>	<i>a</i>	<i>b</i>	<i>a</i>	<i>b</i>	<i>c</i>	<i>a</i>	<i>b</i>	<i>c</i>	<i>a</i>	<i>b</i>	<i>c</i>
Cast iron (cast)	29– 34	20– 23	10–12	88– 98	59– 65	45– 59	30– 39	15–20	29– 34	20–23	10–12	26– 34	18–23	88–118
Cast iron (machined)	29– 34	20– 23	10–12	88– 98	59– 65	55– 71	–	–	29– 34	20–23	10–12	26– 34	18–23	88–118
Malleable cast iron	44– 69	29– 46	15–23	59– 88	39– 59	44– 98	29– 46	15–23	–	–	–	29– 39	20–26	10– 13
Cast steel	59–118	39– 78	20–39	88–147	59– 98	74–118	49– 78	25–39	47– 94	31–63	16–31	47– 94	31–63	16– 31
Mild steel	98–157	66–105	32–52	98–157	66–105	88–147	59– 98	35–49	78–127	52–85	26–42	78–137	52–91	26– 46
Middle hard steel	118–176	78–118	39–59	118–176	78–118	118–176	78–118	39–59	94–137	63–94	31–47	88–137	59–94	29– 47
Nickel steel	118–176	78–118	39–59	118–176	78–118	118–176	78–118	39–59	94–137	63–94	31–47	88–137	59–92	29– 47
Carbon steel casting	88–118	59– 78	29–39	88–118	59– 78	88–118	59– 78	29–39	71– 93	47–63	24–31	35– 47	24–31	12– 16
Brass (rolled)	10– 59	26– 35	13–20	39– 59	26– 39	39– 59	26– 39	13–20	34– 47	21–31	11–16	31– 47	21–31	11– 16
Bronze	29– 39	20– 26	10–13	29– 39	20– 26	29– 39	20– 26	10–13	–	–	–	–	–	–
Phosphor bronze	59– 88	39– 59	20–29	59– 88	39– 59	59– 88	39– 59	20–29	44– 69	29–46	15–23	44– 69	29–46	15– 23
Aluminum casting	10– 12	7– 8	2– 4	–	–	15– 20	10– 13	5– 7	–	–	–	–	–	–

Remarks 1. *a* is applicable in the case of static load, *b* is applicable in the case of dynamic load, and *c* is applicable to in the case of repeated load.

2. Bending allowable stress K_b and torsion allowable stress K_d of cast iron are applicable when the cross section is round and safety factor is within a range from 5 to 6.

Appendix table 14 Hexagon socket head cap screws

Appendix table 14 (1) Hexagon socket head cap screws (abstract from JIS B 1176)

M 1.6 – 24

Allowance of bolt length (ℓ)

Unit : mm

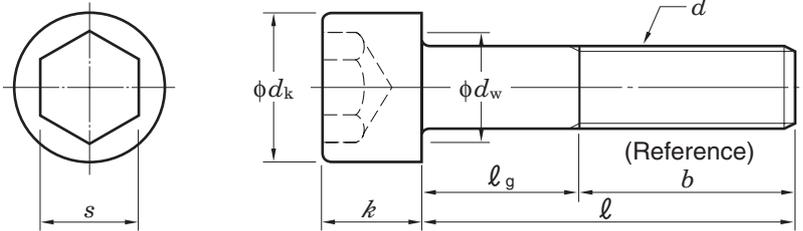

Bolt length (ℓ)		Allowance of length
Over	Incl.	
–	3	± 0.2
3	6	± 0.24
6	10	± 0.29
10	16	± 0.35
16	30	± 0.42
30	50	± 0.5
50	80	± 0.6
80	120	± 0.7
120	180	± 0.8
180	240	± 0.95
240	300	± 1.05

(1) Parts class A M 1.6–24

Unit : mm

Nominal size of screw d	Coarse screw thread pitch	M 1.6	M 2	M 2.5	M 3	M 4	M 5	M 6	M 8	M 10	M 12	(M 14)	M 16	(M 18)	M 20	(M 22)	M 24
Head dia. d_k		3	3.8	4.5	5.5	7	8.5	10	13	16	18	21	24	27	30	33	36
Head height k		1.6	2	2.5	3	4	5	6	8	10	12	14	16	18	20	22	24
Bearing surface dia. d_w (min.)		2.72	3.4	4.18	5.07	6.53	8.03	9.38	12.33	15.33	17.23	20.17	23.17	25.87	28.87	31.81	34.81
Nominal size of hexagon socket s		1.5	1.5	2	2.5	3	4	5	6	8	10	12	14	14	17	17	19
Thread length b (reference)		15	16	17	18	20	22	24	28	32	36	40	44	48	52	56	60

Nominal length ℓ	M 1.6	Body length ℓ_g (max.)																
2.5																		
3			M 2															
4				M 2.5														
5					M 3													
6						M 4												
8							M 5											
10								M 6										
12									M 8									
16										M 10								
20											M 12							
25												M 14						
30													M 16					
35																		
40																		
45																		
50																		
55																		
60																		
65																		
70																		
80																		
90																		
100																		
110																		
120																		
130																		
140																		
150																		
160																		
180																		
200																		

- Remarks
1. Priority is given to the nominal sizes of screws without parentheses.
 2. Nominal lengths (ℓ) to be recommended for the nominal sizes of screw are within the range enclosed by bold lines in the column of "Body length ℓ_g ". In the column of "Body length ℓ_g ", thread of the screw with length shorter than that indicated under dotted lines should be continuous. For the continuous thread stud screw, the incomplete thread portion length under the neck of the screw should be approximately three times of the thread pitch.
 3. The sides of the head of screw should be single or double knurled. The d_k values in the table are the maximum values without knurls.
 4. Roundness or chamfers on the bearing surface should be provided between the diameter of the head (d_k) and the diameter of bearing surface (d_w), and the surface should be free from burrs.

Appendix table 14 (2) Hexagon socket head cap screws (abstract from JIS B 1176)

M 27 – 52

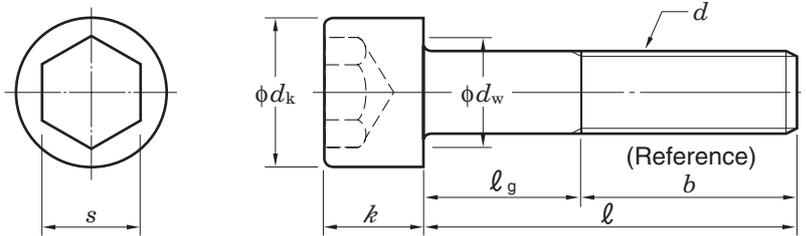

Allowance of bolt length (ℓ)

Unit : mm

Bolt length (ℓ)		Allowance of length
Over	Incl.	
–	3	± 0.2
3	6	± 0.24
6	10	± 0.29
10	16	± 0.35
16	30	± 0.42
30	50	± 0.5
50	80	± 0.6
80	120	± 0.7
120	180	± 0.8
180	240	± 0.95
240	300	± 1.05

(2) Parts class A M 27–52

Unit : mm

Nominal size of screw d	Coarse screw thread pitch	(M 27)	M 30	(M 33)	M 36	(M 39)	M 42	(M 45)	M 48	(M 52)
Head dia. d_k		40	45	50	54	58	63	68	72	78
Head height k		27	30	33	36	39	42	45	48	52
Bearing surface dia. d_w (min.)		38.61	43.61	48.61	52.54	56.34	61.34	66.34	70.34	76.34
Nominal size of hexagon socket s		19	22	24	27	27	32	32	36	36
Thread length b (reference)		66	72	78	84	90	96	102	108	116

Nominal length ℓ	(M 27)	M 30	Body length l_g (max.)							
45										
50										
55										
60										
65										
70										
80	(M 27)									(M 52)
90	24									
100	34	M 30	(M 33)							
110	44	38	32							
120	54	48	42							
130	64	58	52							
140	74	68	62							
150	84	78	72							
160	94	88	82							
180	114	108	102							
200	134	128	122							
220	154	148	142							
240	174	168	162							
260	194	188	182							
280	214	208	202							
300	234	228	222							

- Remarks
1. Priority is given to the nominal sizes of screws without parentheses.
 2. Nominal lengths (ℓ) to be recommended for the nominal sizes of screw are within the range enclosed by bold lines in the column of "Body length l_g ". In the column of "Body length l_g ", thread of the screw with length shorter than that indicated under dotted lines should be continuous. For the continuous thread stud screw, the incomplete thread portion length under the neck of the screw should be approximately three times of the thread pitch.
 3. The sides of the head of screw should be single or double knurled. The d_k values in the table are the maximum values without knurls.
 4. Roundness or chamfers on the bearing surface should be provided between the diameter of the head (d_k) and the diameter of bearing surface (d_w), and the surface should be free from burrs.

Appendix table 15 Hexagon head bolts

Appendix table 15 (1) Hexagon head bolts (abstract from JIS B 1180)

Parts class A M 1.6 – 24

Allowance of bolt length (ℓ)

Unit : mm

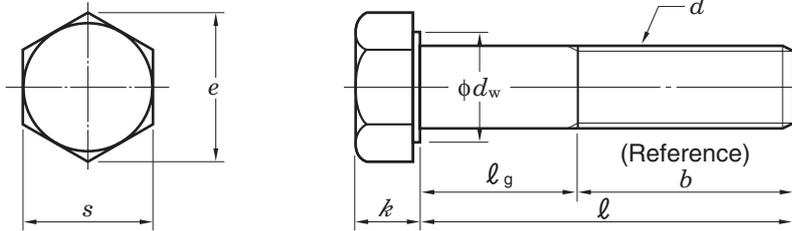

Bolt length (ℓ)		Allowance of length
Over	Incl.	
–	20	± 0.35
20	30	± 0.42
30	50	± 0.5
50	80	± 0.6
80	120	± 0.7
120	150	± 0.8

(1) Parts class A M 1.6–24

Unit : mm

Nominal size of screw d	Coarse screw thread pitch	M 1.6	M 2	M 2.5	M 3	(M 3.5)	M 4	M 5	M 6	M 8	M 10	M 12	(M 14)	M 16	(M 18)	M 20	(M 22)	M 24
		Fine thread	–	–	–	–	–	–	–	–	M 8 x 1	M 10 x 1	M 12 x 1.5	–	M 16 x 1.5	–	M 20 x 1.5	–
		–	–	–	–	–	–	–	–	(M 10 x 1.25)	(M 12 x 1.25)	(M 14 x 1.5)	–	(M 18 x 1.5)	(M 20 x 2)	(M 22 x 1.5)	–	–
Bearing surface dia. d_w (min.)		2.27	3.07	4.07	4.57	5.07	5.88	6.88	8.88	11.63	14.63	16.63	19.64	22.49	25.34	28.19	31.71	33.61
Width across flats s (max.)		3.2	4	5	5.5	6	7	8	10	13	16	18	21	24	27	30	34	36
Width across corners e (min.)		3.41	4.32	5.45	6.01	6.58	7.66	8.79	11.05	14.38	17.77	20.03	23.36	26.75	30.14	33.53	37.72	39.98
Head height k (basic)		1.1	1.4	1.7	2	2.4	2.8	3.5	4	5.3	6.4	7.5	8.8	10	11.5	12.5	14	15
Thread length b (reference)	$\ell \leq 125$	9	10	11	12	13	14	16	18	22	26	30	34	38	42	46	50	54
	$125 < \ell \leq 150$	–	–	–	–	–	–	–	–	–	–	–	40	44	48	52	56	60

Nominal length ℓ	Body length ℓ_g (max.)																		
12	3	M 2	M 2.5																
16	7	6	5	M 3	(M 3.5)														
20	10	9	8	7	M 4	M 5													
25	14	13	12	11	9	M 6													
30	18	17	16	14	12														
35	22	21	19	17	M 8														
40	26	24	22	18	M 10														
45	29	27	23	19	M 12														
50	34	32	28	24	20														
55	37	33	29	25	(M 14)														
60	42	38	34	30	26	M 16													
65	43	39	35	31	27	(M 18)													
70	48	44	40	36	32	28	M 20												
80	58	54	50	46	42	38	34	(M 22)	M 24										
90	64	60	56	52	48	44	40	36	33										
100	74	70	66	62	58	54	50	46	42										
110	80	76	72	68	64	60	56	52	48										
120	90	86	82	78	74	70	66	62	58										
130	90	86	82	78	74	70													
140	100	96	92	88	84	80													
150	106	102	98	94	90														

As for the bolts with nominal length within this area, standards of continuous thread stud hexagon head bolt (parts class A) should be observed.

- Remarks 1. Priority is given to the nominal sizes of screws without parentheses.
 2. Nominal lengths (ℓ) to be recommended for the nominal sizes of screw are within the range enclosed by bold lines.
 3. Body length ℓ_g (maximum) should be found by the following formula : ℓ_g (maximum) = Nominal length (ℓ) – Thread length (b)

Appendix table 15 (2) Hexagon head bolts (abstract from JIS B 1180)

Parts class B M 16 – 64

Allowance of bolt length (ℓ)

Unit : mm

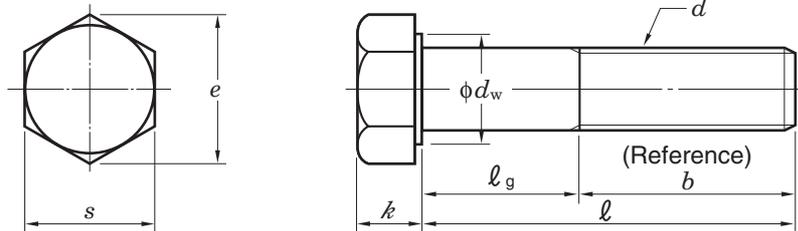

Bolt length (ℓ)		Allowance of length
Over	Incl.	
–	80	±1.5
80	90	±1.7
90	120	±1.75
120	180	±2
180	240	±2.3
240	300	±2.6
300	400	±2.85
400	500	±3.15

(2) Parts class B M 16–64

Unit : mm

Nominal size of screw d	Coarse screw thread pitch	M 16	(M 18)	M 20	(M 22)	M 24	(M 27)	M 30	(M 33)	M 36	(M 39)	M 42	(M 45)	M 48	(M 52)	M 56	(M 60)	M 64
		Fine thread	M 16 x 1.5	–	M 20 x 1.5	–	M 24 x 2	–	M 30 x 2	–	M 36 x 3	–	M 42 x 3	–	M 48 x 3	–	M 56 x 4	–
		–	(M 18 x 1.5)	(M 20 x 2)	(M 22 x 1.5)	–	(M 27 x 2)	–	(M 33 x 2)	–	(M 39 x 3)	–	(M 45 x 3)	–	(M 52 x 4)	–	(M 60 x 4)	–
Bearing surface dia. d_w (min.)		22	24.85	27.7	31.35	33.25	38	42.75	46.55	51.11	55.86	59.95	64.7	69.45	74.2	78.66	83.41	88.16
Width across flats s (max.)		24	27	30	34	36	41	46	50	55	60	65	70	75	80	85	90	95
Width across corners e (min.)		26.17	29.56	32.95	37.29	39.55	45.2	50.85	55.37	60.79	66.44	71.3	76.95	82.6	88.25	93.56	99.21	104.86
Head height k (basic)		10	11.5	12.5	14	15	17	18.7	21	22.5	25	26	28	30	33	35	38	40
Thread length b (reference)	$\ell \leq 125$	38	42	46	50	54	60	66	–	–	–	–	–	–	–	–	–	–
	$125 < \ell \leq 200$	44	48	52	56	60	66	72	78	84	90	96	102	108	116	–	–	–
	$200 < \ell \leq 500$	–	–	–	69	73	79	85	91	97	103	109	115	121	129	137	145	153

Nominal length ℓ	Body length ℓ_g (max.)																	
65	(M 18)																	
70	M 20																	
80	(M 22) M 24																	
90	(M 27)																	
100	40 M 30																	
110	50 44																	
120	60 54 (M 33)																	
130	64 58 M 36																	
140	74 68 62 56 (M 39)																	
150	84 78 72 66 60 M 42																	
160	116	112	108	104	100	94	88	82	76	70	64	(M 45)	M 48					
180	132 128 124 120 114 108 102 96 90 84 78 72 (M 52)																	
200	148 144 140 134 128 122 116 110 104 98 92 84 M 56																	
220	151 147 141 135 129 123 117 111 105 99 91 83 (M 60)																	
240	161 155 149 143 137 131 125 119 111 103 95 M 64																	
260	181 175 169 163 157 151 145 139 131 123 115 107																	
280	195 189 183 177 171 165 159 151 143 135 127																	
300	215 209 203 197 191 185 179 171 163 155 147																	
320	229 223 217 211 205 199 191 183 175 167																	
340	243 237 231 225 219 211 203 195 187																	
360	263 257 251 245 239 231 223 215 207																	
380	277 271 265 259 251 243 235 227																	
400	291 285 279 271 263 255 247																	
420	311 305 299 291 283 275 267																	
440	325 319 311 303 295 287																	
460	339 331 323 315 307																	
480	359 351 343 335 327																	
500	371 363 355 347																	

As for the bolts with nominal length within this area, standards of continuous thread stud hexagon head bolt (parts class A or B) should be observed.

- Remarks 1. Priority is given to the nominal sizes of screws without parentheses.
- 2. Nominal lengths (ℓ) to be recommended for the nominal sizes of screw are within the range enclosed by bold lines.
- 3. Body length ℓ_g (maximum) should be found by the following formula : ℓ_g (maximum) = Nominal length (ℓ) – Thread length (b)

Appendix table 16 Hexagon head nuts (abstract from JIS B 1181)

Parts class A M 1.6 – 16
 Parts class B M 18 – 64

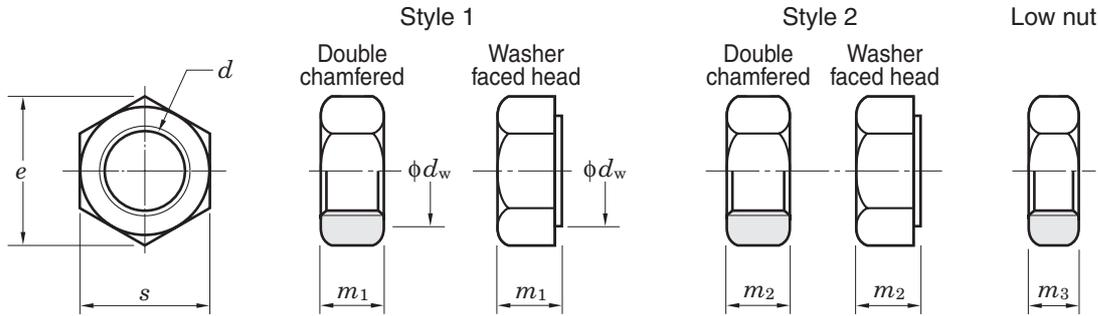

(1) Parts class A M 1.6–16

Unit : mm

Nominal size of screw <i>d</i>	Coarse screw thread pitch	M 1.6	M 2	M 2.5	M 3	(M 3.5)	M 4	M 5	M 6	M 8	M 10	M 12	(M 14)	M 16
	Fine thread		–	–	–	–	–	–	–	–	M 8 × 1	M 10 × 1	M 12 × 1.5	–
Bearing surface dia. d_w (min.)		2.27	3.07	4.07	4.57	5.07	5.88	6.88	8.88	11.63	14.63	16.63	19.64	22.49
Width across flats <i>s</i> (max.)		3.2	4	5	5.5	6	7	8	10	13	16	18	21	24
Width across corners <i>e</i> (min.)		3.41	4.32	5.45	6.01	6.58	7.66	8.79	11.05	14.38	17.77	20.03	23.36	26.75
Height	m_1 (max.)	1.3	1.6	2	2.4	2.8	3.2	4.7	5.2	6.8	8.4	10.8	12.8	14.8
	m_2 (max.)	–	–	–	–	–	–	5.1	5.7	7.5	9.3	12	14.1	16.4
	m_3 (max.)	1	1.2	1.6	1.8	2	2.2	2.7	3.2	4	5	6	7	8

Remark Priority is given to the nominal sizes of screws without parentheses.

(2) Parts class B M 18–64

Unit : mm

Nominal size of screw <i>d</i>	Coarse screw thread pitch	(M 18)	M 20	(M 22)	M 24	(M 27)	M 30	(M 33)	M 36	(M 39)	M 42	(M 45)	M 48	(M 52)	M 56	(M 60)	M 64
	Fine thread		–	M 20 × 1.5	–	M 24 × 2	–	M 30 × 2	–	M 36 × 3	–	M 42 × 3	–	M 48 × 3	–	M 56 × 4	–
Bearing surface dia. d_w (min.)		24.85	27.7	31.35	33.25	38	42.75	46.55	51.11	55.86	59.95	64.7	69.45	74.2	78.66	83.41	88.16
Width across flats <i>s</i> (max.)		27	30	34	36	41	46	50	55	60	65	70	75	80	85	90	95
Width across corners <i>e</i> (min.)		29.56	32.95	37.29	39.55	45.2	50.85	55.37	60.79	66.44	71.3	76.95	82.6	88.25	93.56	99.21	104.86
Height	m_1 (max.)	15.8	18	19.4	21.5	23.8	25.6	28.7	31	33.4	34	36	38	42	45	48	51
	m_2 (max.)	17.6	20.3	21.8	23.9	26.7	28.6	32.5	34.7	–	–	–	–	–	–	–	–
	m_3 (max.)	9	10	11	12	13.5	15	16.5	18	19.5	21	22.5	24	26	28	30	32

Remark Priority is given to the nominal sizes of screws without parentheses.

Appendix table 17 Comparison table of Part No. by manufacturers (cylindrical bore type)

17.1 Pillow type bearing units

	FYH · JTEKT	ASAHI	NSK	NTN
With pressed steel cover	UCP2·C UCP2·CD	UCP2·C UCP2·E	Z-UCP2·D1 ZM-UCP2·D1	S-UCP2·D1 SM-UCP2·D1
With cast iron cover	UCP2·FC UCP2·FCD UCP3·C UCP3·CD	CUCP2·C CUCP2·CE CUCP3·C CUCP3·CE	C-UCP2·D1 CM-UCP2·D1 C-UCP3·D1 CM-UCP3·D1	C-UCP2·D1 CM-UCP2·D1 C-UCP3·D1 CM-UCP3·D1
Cast steel type	UCP2SC UCP3SC	UCPK2· UCPK3·		
Thick type	UCIP2· UCIP3·	UCIP2· UCIP3·	UCIP2· UCIP3·	UCIP2· UCIP3·
Tapped-base type	UCPA2·	UCPA2·	UCUP2·D1	UCUP2·D1
High centerheight type	UCPH2·	UCPH2·	UCHP2·D1	UCHP2·D1
Lightweight type	BLP2· ALP2·	BLLP·	ASPB2· AELPB2·	ASPB2· AELPB2·
Clean series	UP0·	UP0·		
Stainless steel type	UCSP2·H1S6 UCSPA2·H1S6 USP0·S6	MUCP2· MUCPA2	F-UCPM2·/LP03	F-UCPM2·/LP03
Steel plate type	SBPP2· SAPP2·	BPP·	ASPP2· AELPP2·	ASPP2· AELPP2·

17.2 Flange type bearing units

	FYH · JTEKT	ASAHI	NSK	NTN
With pressed steel cover	UCF2·C UCF2·D UCFC2·C UCFC2·D UCFL2·C UCFL2·D	UCF2·C UCF2·E UCFC2·C UCFC2·E UCFL2·C UCFL2·E	Z-UCF2·D1 ZM-UCF2·D1 Z-UCFC2·D1 ZM-UCFC2·D1 Z-UCFL2·D1 ZM-UCFL2·D1	S-UCF2·D1 SM-UCF2·D1 S-UCFC2·D1 SM-UCFC2·D1 S-UCFL2·D1 SM-UCFL2·D1
With cast iron cover	UCF2·FC UCF2·FD UCF3·C UCF3·D UCFC2·FC UCFC2·FD UCFS3·C UCFS3·D UCFL2·FC UCFL2·FD UCFL3·C UCFL3·D	CUCF2·C CUCF2·CE CUCF3·C CUCF3·CE CUCFC2·C CUCFC2·CE CUCFS3·C CUCFS3·CE CUCFL2·C CUCFL2·CE CUCFL3·C CUCFL3·CE	C-UCF2·D1 CM-UCF2·D1 C-UCF3·D1 CM-UCF3·D1 C-UCFC2·D1 CM-UCFC2·D1 C-UCFS3·D1 CM-UCFS3·D1 C-UCFL2·D1 CM-UCFL2·D1 C-UCFL3·D1 CM-UCFL3·D1	C-UCF2·D1 CM-UCF2·D1 C-UCF3·D1 CM-UCF3·D1 C-UCFC2·D1 CM-UCFC2·D1 C-UCFS3·D1 CM-UCFS3·D1 C-UCFL2·D1 CM-UCFL2·D1 C-UCFL3·D1 CM-UCFL3·D1
Adjustable type	UCFA2· UCFB2·	UCFA2· UCFK2·	UCFA2·D1 UCFH2·D1	UCFA2·D1 UCFH2·D1
Lightweight type	BLF2· ALF2·	BLFL·	ASFB2· AELFB2·	ASFB2· AELFB2·
Clean series	UFL0·	UFL0·		
Stainless steel type	UCSF2·H1S6 UCSFL2·H1S6	MUCF2 MUCFL2·	F-UCFM2·/LP03	F-UCFM2·/LP03
Stamped steel plate type	SBPF2· SAPF2· SBPFL2· SAPFL2·	BPF· BPFL·	ASPF2· AELPF2· ASPFL2· AELPFL2·	ASPF2· AELPF2· ASPFL2· AELPFL2·

17.3 Take-up type bearing units

	FYH · JTEKT	ASAHI	NSK	NTN
With pressed steel cover	UCT2·C UCT2·CD	UCT2·C UCT2·E	Z-UCT2·D1 ZM-UCT2·D1	S-UCT2·D1 SM-UCT2·D1
With cast iron cover	UCT2·FC UCT2·FCD UCT3·C UCT3·CD	CUCT2·C CUCT2·CE CUCT3·C CUCT3·CE	C-UCT2·D1 CM-UCT2·D1 C-UCT3·D1 CM-UCT3·D1	S-UCT2·D1 SM-UCT2·D1 C-UCT3·D1 CM-UCT3·D1
Stainless steel type	UCST2·H1S6	MUCT2		
Take-up type with frame	UCTH2····· UCL2····· UCTU2····· UCTU3·····	UCT2···WB UCL2···+WL· UCTU2···+WU· UCTU3···+WU·	UCT2···D1 UCL2···D1 UCM2···D1 UCM3···D1	UCT2···D1 UCL2···D1 UCM2···D1 UCM3···D1
Take-up type with steel plate frame	SBPTH2····· SBNPTH2·····	BTAW201,X	ASPT2·····	ASPT2·····

17.4 Other bearing units

	FYH · JTEKT	ASAHI	NSK	NTN
Hanger type	UCHA2···	UCECH2···	UCHB2···D1	UCHB2···D1

17.5 Bearing

	FYH · JTEKT	ASAHI	NSK	NTN
Ball bearing inserts	UC2··· UK2··· NA2··· SB2··· SA2···	UC2··· UK2··· UG2···+ER B···	UC2···D1 UK2···D1 UEL2···D1 AS2··· AEL2···	UC2···D1 UK2···D1 UEL2···D1 AS2··· AEL2···
Outside surface cylindrical bore type	RB2··· ER2···	UR2··· *1 SER2··· *1	UCS2···LN *1	UCS2···LN *1

*1 Width of the outer ring for these items differs from that of others.

17.6 Special specification items

	FYH · JTEKT	ASAHI	NSK	NTN
Grease (heat resistant)	D1K2	HR5	HT2	HT2
(cold resistant)	D2K2	CR2A	CT1	CT1
(heat resistant)	D9K2	HR23		
Non-contact	K3		U	U
Spherical nodular graphite cast iron	H4		N1	N1
Lubricated type			D1	D1
Non-lubricated type	E4	GOO		

NIPPON PILLOW BLOCK CO., LTD.

HEAD OFFICE/Main Plant

2306 Hirao Miharaku Sakai Osaka 587-0022 JAPAN

TEL: 072-361-3752 FAX: 072-361-4173 E-mail: info@fyhbearings.com

OSAKA SALES

E-mail: exports@fyh.co.jp

osaka@fyh.co.jp

FYH BEARING UNITS USA INC.

FYH BEARING UNITS USA INC.

285 Industrial Drive Wauconda, Illinois 60084, USA

TEL: 847-487-9111 FAX: 847-487-9222 E-mail: sales@fyhusa.com

DOMESTIC BRANCHES IN JAPAN

Tokyo

1-3-49 Katsushima Shinagawaku Tokyo 140-0012 JAPAN

TEL: 03-5767-7270 FAX: 03-5767-7280

E-mail: tokyo@fyhsales.co.jp

Nagoya

2-1-2 Niban Atsutaku Nagoya Aichi 456-0052 JAPAN

TEL: 052-652-1211 FAX: 052-652-0744

E-mail: nagoya@fyhsales.co.jp

Sapporo

E-mail: sapporo@fyhsales.co.jp

Fukuoka

E-mail: kyusyuu@fyhsales.co.jp

Hiroshima

E-mail: fukuyama@fyhsales.co.jp

Shizuoka

E-mail: sizuoka@fyhsales.co.jp

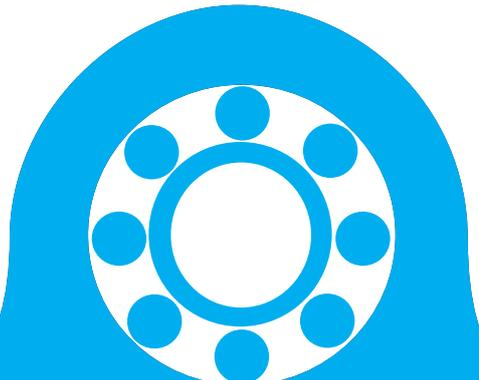



FYH[®]

