

FAG

FAG Aerospace and Super Precision Bearings Division



The Barden Corporation

A Company of the FAG Kugelfischer Group

Super Precision Bearings



Super Precision Bearings

DIN ISO 9001

Publ. No. AC 41 130/3 EA

June 1998

QUALITY SYSTEM

REG.NO 25 751-03



Super Precision Bearings

FAG and Barden have united their decades of experience in the design and manufacture of super precision bearings in the

FAG Aerospace and Super Precision Bearings Division.

The concentration on super precision bearings guarantees utmost quality and flexibility. It is our goal to fulfil your requirements in a trusted and responsible manner.

Contents

Section 1 Miniature and Instrument Bearings	Miniature and Instrument Bearings	8
	Deep groove ball bearings, metric	11
	Deep groove ball bearings, inch	12
	Angular contact ball bearings, separable, non-separable, metric and inch	13
	Deep Groove Ball Bearings	14
	Deep groove ball bearings, metric	17
	Section 2 Super Precision Bearings Axial Thrust Ball Bearings Cylindrical Roller Bearings	P4S a New Standard
	Advantages of Sealed Spindle Bearings	19
	Advantages of Hybrid Spindle Bearings	20
	Spindle Bearings	22
	B719C., B70C., B72C., B719E., B70E., B72E.	25
	HS-HSS719C., HSS70C., HSS719E., HSS70E.	30
	HC-HCS719C., HCS70C., HCS719E., HCS70E.	33
	Ball Screw Support Bearings	36
	7602, 7603, BSB	39
	Double Direction Angular Contact Thrust Ball Bearings	42
	2344, 2347	45
	Cylindrical Roller Bearings	48
	N10	51
	NN30	53
Section 3 Technical Information Engineering	Life Calculation for Super Precision Bearings	56
	Dynamic equivalent loads	56
	Fatigue life of miniature and instrument bearings	57
	Modified life calculation	58
	Static load	62
	Lubrication	63
	Clamping Forces for Ball Screw Support Bearings	67
	Tolerances of Super Precision Bearings	68
	Manufacturing Tolerances for Mating Parts	72
	Bearing seats	72
	Housing bores	74
	Abutment dimensions	76
	Attainable Speeds	84
	Deflection and Rigidity	85
	Preload	93
	Spindle Bearing Sets	98
	Cages for Miniature and Instrument Bearings	99
Closures for Miniature and Instrument Bearings	102	
Notes	103	

Product Line



Miniature and Instrument Bearings
(Page 8)



Deep Groove Ball Bearings
(Page 14)

Super Precision Spindle Bearings
(Page 22)



Ball Screw Support Bearings
(Page 36)

Double Direction Angular Contact Thrust Ball Bearings
(Page 42)



Single Row Cylindrical Roller Bearings
(Page 48)

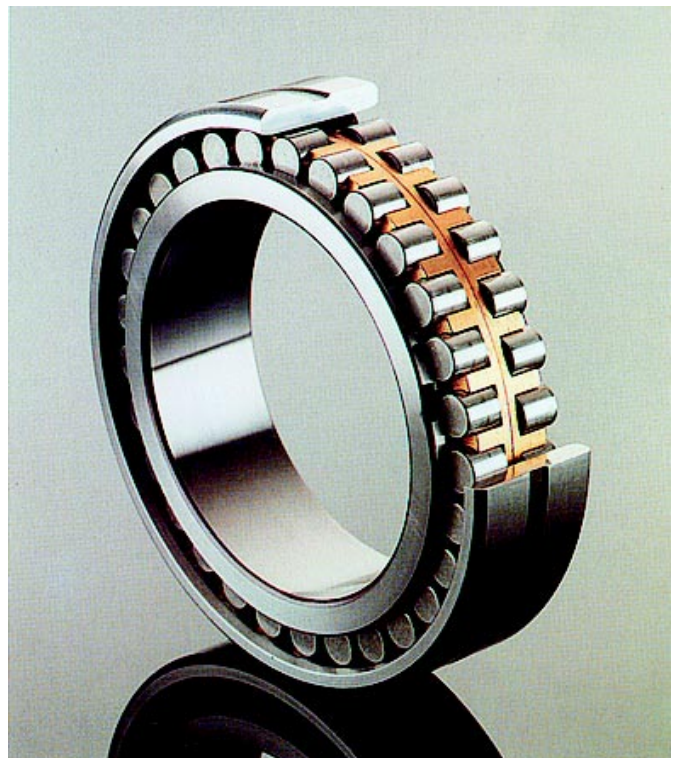

Double Row Cylindrical Roller Bearings
(Page 48)

Manufacturing Facilities



FAG Kugelfischer Georg Schäfer AG, Schweinfurt, Germany

The Barden Corporation (UK) Ltd, Plymouth, UK



Section 1

Miniature and Instrument Bearings



Miniature and Instrument Bearings



Miniature and Instrument Bearings

Typical applications of these very small bearings are :

- gyroscopes
- measuring instruments, e.g. flowmeters
- medical equipment, e.g. dental turbines

The special properties of such bearings are :

- very low and consistent torque
- quiet operation with minimal vibration at very high and very low operating speeds.

All super precision miniature and instrument bearings are manufactured to precision ABEC 7P tolerances.

To accommodate the demanding ap-

plications many different cage and shield/seal variations are offered.

Material

The standard material for rings and balls is corrosion resistant steel AISI 440C. Some types are also available in SAE 52100.

Cages

Standard ball cages for the deep groove bearings are one piece pressed steel snap-in for the smaller, and two piece ribbon cage for the larger sizes. The 'W' cage is of two piece construction de-

signed for 'anti-wind up' specifically for reducing torque peaks. 'TA' a Phenolic snap-in cage is used for medium to high speed. 'PA' is of two piece ribbon construction with a special PTFE coating for use dry at extremes of temperature.

Angular contact bearings are offered with a range of one piece machined 'Halo' designs.

Closures

Precision shields 'SS' having minimal clearance with the inner ring. Synchro-seal seals 'UU' fully contacting and the low friction Flexeals 'FF', a lightly contacting seal suitable for high speeds are

Miniature and Instrument Bearings

SR3 SSWX8K5 VECO-11

Material

- C Ceramic balls
- SAE 52100
- S AISI 440C

Series/Size

- F Flanged outer ring
- R Inch
- W Extended inner ring
- M Metric

Bearing Type

- Deep groove
- Angular contact
- H Non separable
- B Separable

Closures

- SS Double shield
- FF Double seal, Flexeal
- UU Double sealed, Synchro seal

Cage

- Deep groove
- Pressed steel snap-in
- W Two piece ribbon - loose clinch
- TA One piece snap, phenolic
- PA Two piece ribbon, PTFE coated

- Angular contact
- One piece Halo cage

Special Features

- X, Y Deviation from standard
- K Separating symbol

Lubrication

- O, OJ Oil
- G, GJ Grease

Calibration

Bore/Outside Diameter

- C 2 step IR/OR
- CX0 2 step IR
- COX 2 step OR
- C44 4 step IR/OR
- C40 4 step IR
- C04 4 step OR

Radial Runout

- E Reduced radial runout (< .001 mm)
- R High point marked on IR
- R1 High point marked on OR
- R2 High point marked on IR/OR

Torque

- V Torque controlled
- VK Starting torque controlled
- VM Peak running torque controlled
- VT 100% Peak running torque with traces

Duplex Pairs

- DB Back to back
- DF Face to face
- DT Tandem
- D Universal

Radial Play [µm]

- 1 1 - 5
- 2 3 - 8
- 3 5 - 10
- 4 8 - 13
- 5 13 - 20
- 6 20 - 28

IR = Inner Ring
OR = Outer Ring

Miniature and Instrument Bearings

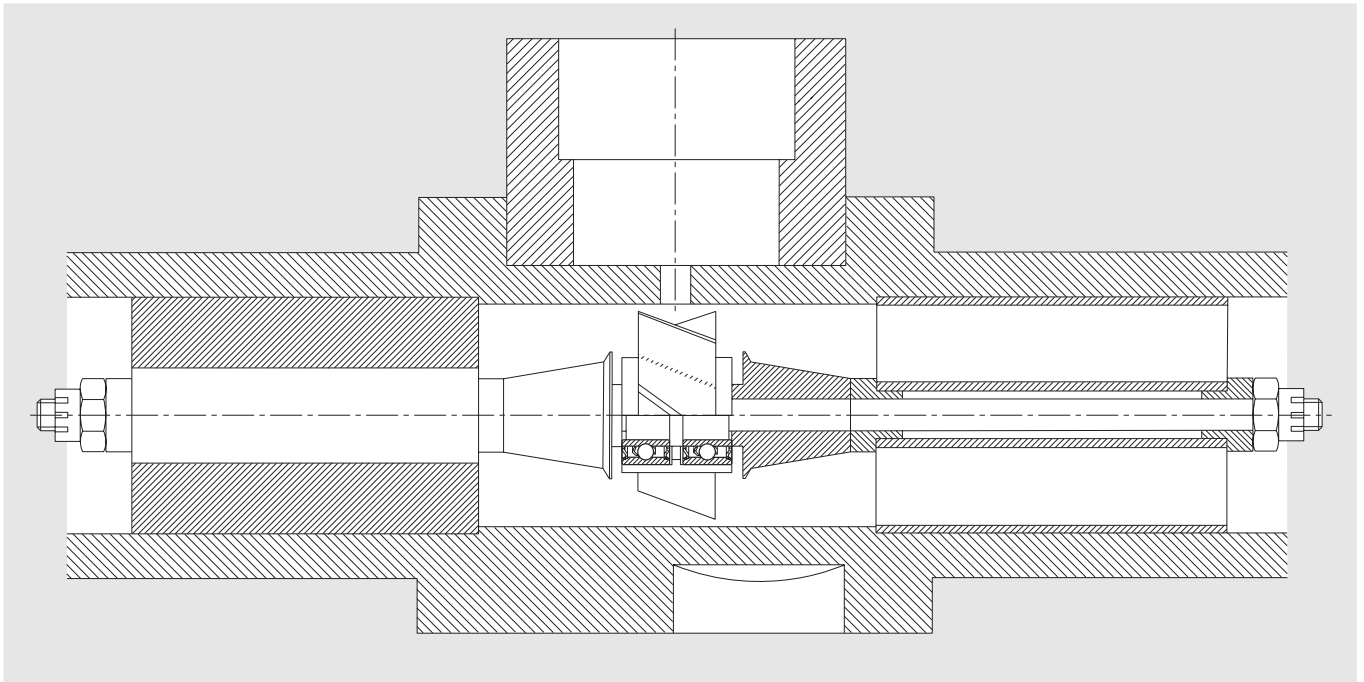

Application - Flowmeter

available as options in many sizes of the deep groove product line.

The relevant selection data and calculation for miniature and instrument ball bearings can be found on pages :

- Life Calculations Page 57
- Lubrication Page 63-66
- Tolerances Page 71
- Manufacturing Tolerances for Mating Parts Page 72-79
- Preload Page 97
- Cages/Closures Page 99-102

Technical Data

- Speed : 90,000 rpm
- Temperature Range : -40 to +70°C
- Load : Axial 17 N maximum
- Radial 3 N maximum

Bearing Selection

SR133SS6DRY

Application details provided courtesy of ITT Barton.

Miniature and Instrument Bearings

Deep groove
metric

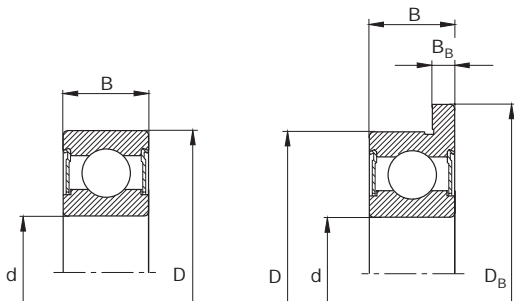

Basic Bearing Number	Dimensions			Flange		Load Rating		Max. Axial Load stat.	Attainable Speed			Weight ≈ kg
	d	D	B	D _B	B _B	dyn. C	stat. C ₀		Pressed cage Grease/Oil rpm	Phenolic snap cage Grease	Oil	
Barden	mm					N						
SF18M1-5SSW	1.5	4	2	5	0.4	85	13	40	160000	—	—	0.0001
S(F)19M1-5SSWY1		5	2	6.5	0.6	111	18	58	125000	—	—	0.0002
S(F)19M2SSWY1	2	6	2.3	7.5	0.6	151	27	76	120000	—	—	0.0004
S(F)38M2-5SSW	2.5	6	2.6	7.1	0.8	169	31	89	100000	240000	240000	0.0003
S(F)19M2-5SSWY1		7	2.5	8.5	0.7	169	31	89	100000	240000	240000	0.0003
S(F)38M3SSW	3	7	3	8.1	0.8	209	40	102	85000	200000	200000	0.0003
S(F)2M3SSWY1		10	4	11.5	1	356	71	133	80000	200000	200000	0.0014
S(F)38M4SSW	4	9	4	10.3	1	356	71	133	80000	200000	200000	0.001
S2M4SSW		13	5	—	—	734	173	325	55000	150000	150000	0.0023
S19M5SSWY1	5	13	4	—	—	694	156	280	40000	100000	100000	0.0022
S18M7WY2	7	14	4	—	—	636	169	316	35000	—	—	0.002

Miniature and Instrument Bearings

Deep groove
inch

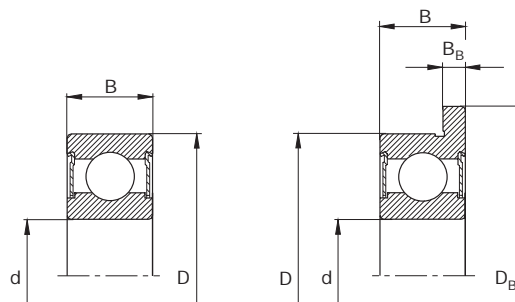

Basic Bearing Number	Dimensions			Flange		Load Rating		Max. Axial Load stat.	Attainable Speed			Weight ≈ kg
	d	D	B	D _B	B _B	dyn. C	stat. C ₀		Pressed cage Grease/Oil rpm	Phenolic snap cage Grease Oil		
Barden	inch					N						
S(F)R0SS*	0.0469	0.1562	0.0937	0.203	0.031	85	13	36	180000	—	—	0.00014
S(F)R1SS*	0.0550	0.1875	0.1094	0.234	0.031	129	22	53	140000	—	—	0.00023
S(F)R1-4SS*	0.0781	0.2500	0.1406	0.296	0.031	169	31	89	100000	220000	220000	0.00045
S(F)R133SS*	0.0937	0.1875	0.0937	0.234	0.031	111	18	58	105000	—	—	0.00014
S(F)R1-5SS*		0.3125	0.1406	0.359	0.031	254	40	85	75000	200000	200000	0.00090
SR144SSWX3	0.1250	0.2500	0.0937	—	—	169	31	89	80000	220000	220000	0.00027
S(F)R144SS*		0.2500	0.1094	0.296	0.031	169	31	89	80000	220000	220000	0.00032
SR2-5SX2*		0.3125	0.1094	—	—	262	44	89	75000	—	—	0.00090
SR154SSX1*		0.3125	0.1094	—	—	169	31	89	80000	220000	220000	0.00090
S(F)R2-5SS*		0.3125	0.1406	0.359	0.031	262	44	89	75000	200000	200000	0.00090
SR164SSWX3		0.3750	0.0937	—	—	169	31	89	80000	220000	220000	0.00090
SR2SSX52*		0.3750	0.1094	—	—	173	36	89	70000	180000	180000	0.00090
S(F)R2-6SS*		0.3750	0.1406	0.422	0.031	356	71	133	65000	160000	160000	0.00140
S(F)R2SS*		0.3750	0.1562	0.440	0.030	294	44	102	65000	160000	160000	0.00140
SR174SSWX5		0.4100	0.0937	—	—	169	31	89	80000	—	—	0.00140
SR174SSX2*		0.4250	0.1094	—	—	200	44	111	70000	—	—	0.00140
SR184SSX2*		0.5000	0.1094	—	—	169	31	89	80000	—	—	0.00230
SR2ASS*		0.5000	0.1719	—	—	294	44	102	50000	140000	140000	0.00360
SR1204SSWX1		0.7500	0.1250	—	—	387	89	196	50000	—	—	0.00450
S(F)R155SS*	0.1562	0.3125	0.1250	0.359	0.036	200	44	111	55000	150000	150000	0.00070
S(F)R156SS*	0.1875	0.3125	0.1250	0.359	0.036	200	44	111	55000	150000	150000	0.00045
S(F)R166SS*		0.3750	0.1250	0.422	0.031	387	89	196	50000	140000	140000	0.00091
SR186SWX3		0.5000	0.1094	—	—	387	89	196	50000	—	—	0.00180
SR186SSX2*		0.5000	0.1562	—	—	387	89	196	50000	—	—	0.00270
S(F)R3SS*		0.5000	0.1960	0.565	0.042	614	120	218	45000	135000	135000	0.00230
SR3SSX8*		0.7500	0.1960	—	—	614	120	218	45000	—	—	0.00910
SR3SSX23*		0.8750	0.1960	—	—	614	120	218	45000	—	—	0.01360
S(F)R168SS	0.2500	0.3750	0.1250	0.422	0.036	169	36	98	48000	—	—	0.00091
S(F)R188SS*		0.5000	0.1875	0.547	0.045	472	120	254	42000	110000	110000	0.00230
S(F)R4SS*		0.6250	0.1960	0.690	0.042	694	156	280	40000	105000	105000	0.00450
SR4ASS*		0.7500	0.2812	—	—	1139	236	274	35000	85000	85000	0.00910
SR4SSX35*		1.0480	0.1960	—	—	694	156	280	42000	—	—	0.01820
S(F)R1810SSW	0.3125	0.5000	0.1562	0.547	0.031	463	120	249	32000	—	—	0.00180
S(F)R6SS*	0.3750	0.8750	0.2812	0.969	0.062	1579	383	574	24000	55000	55000	0.01360
SR8SS	0.5000	1.1250	0.3125	—	—	3403	1543	1023	14000	38000	38000	0.02270
SR10SS	0.6250	1.3750	0.3438	—	—	—	—	—	12000	—	—	0.03640

* W cage available
Enquire for availability of extended inner ring miniature and instrument bearings.

Miniature and Instrument Bearings

Angular contact, separable
metric and inch

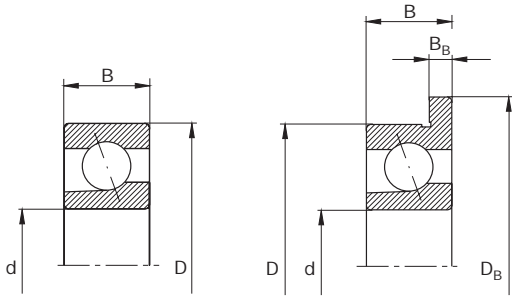

Basic Bearing Number	Dimensions			Flange		Load Rating		Max. Axial Load stat.	Attainable Speed		Standard Radial Play ¹⁾	Weight ≈ kg
	d	D	B	D _B	B _B	dyn. C	stat. C ₀		Grease	Oil		
Barden	mm/inch					N			rpm			
Metric												
S2M3BY3	3	10	4	—	—	289	67	107	230000	315000	6	0.0014
(S)34BX4	4	16	4	—	—	716	147	320	140000	183000	5	0.0091
S19M5BY1	5	13	4	—	—	472	120	254	140000	200000	6	0.0023
(S)34-5B		16	5	—	—	876	147	320	140000	183000	5	0.0045
S19M6BY1	6	15	5	—	—	689	191	307	140000	200000	5	0.0041
36BX1		19	6	—	—	925	274	330	100000	150000	3	0.0092
38BX2	8	22	7	—	—	1535	604	872	80000	125000	5	0.0136
Inch												
(S)(F)R1-5B	0.0937	0.3125	0.1094	0.359	0.023	254	53	89	285000	355000	5	0.0009
(S)(F)R2-5B	0.125	0.3125	0.1094	0.359	0.023	280	67	125	235000	320000	6	0.0011
(S)(F)R2B		0.375	0.1562	0.44	0.03	289	67	107	230000	315000	5	0.0014
(S)(F)R3B	0.1875	0.5	0.1562	0.565	0.042	605	151	240	147000	210000	5	0.0023
(S)(F)R4B	0.25	0.625	0.196	0.69	0.042	689	191	307	110000	160000	5	0.0041

¹⁾ Standard radial play for calculating X and Y factors (page 57)

Angular contact, non separable
metric and inch

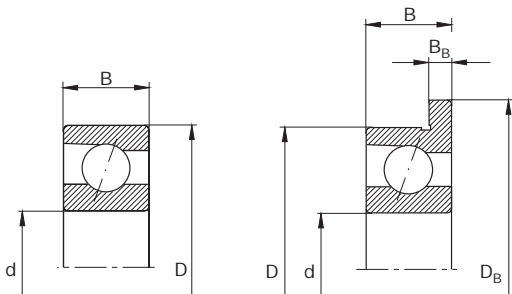

Basic Bearing Number	Dimensions			Flange		Load Rating		Max. Axial Load stat.	Attainable Speed		Standard Radial Play ¹⁾	Weight ≈ kg
	d	D	B	D _B	B _B	dyn. C	stat. C ₀		Grease	Oil		
Barden	mm/inch					N			rpm			
Metric												
34H	4	16	5	—	—	1450	476	516	140000	183000	5	0.005
34-5H	5	16	5	—	—	1450	476	516	140000	183000	5	0.005
36H	6	19	6	—	—	1864	645	770	100000	150000	5	0.009
(S)38H	8	22	7	—	—	2478	654	986	80000	125000	5	0.014
Inch												
R1-5H	0.0937	0.3125	0.1094	—	—	285	87	125	285000	355000	5	0.001
(S)(F)R2-5H	0.125	0.3125	0.1094	0.359	0.023	262	45	89	235000	320000	5	0.001
(S)(F)R2-6H		0.375	0.1094	0.359	0.023	356	71	133	230000	315000	5	0.001
(S)R2H		0.375	0.1562	—	—	400	111	133	230000	315000	5	0.001
(S)R3H	0.1875	0.5	0.1562	—	—	676	178	231	147000	210000	5	0.002
(S)R4H	0.25	0.625	0.196	—	—	756	218	289	110000	160000	5	0.005

¹⁾ Standard radial play for calculating X and Y factors (page 57)

Deep Groove Ball Bearings



Deep Groove Ball Bearings

Super precision deep groove ball bearings are designed to achieve smooth quiet running. They are therefore especially appropriate for applications with high demands for :

- quiet running
- minimum vibration
- ultra high speed

Major application areas are :

- cold air units
- starters for aircraft
- vacuum pumps
- textile machines
- machine tools

All super precision deep groove bearings are manufactured to precision ABEC 7 (ISO P4) tolerances.

To accommodate demanding applications many different cage and shield/seal variations are offered.

Material

The standard material for rings and balls is SAE52100, some sizes are also available in corrosion resistant steel AISI 440C.

Cages

Standard, and particularly suited for high speed, is a phenolic two piece riveted cage with aluminium side plates for strengthening. Also available are two piece ribbon cages and phenolic snap-in cages in some sizes.

Closures

Precision shields 'SS' having minimal clearance with the inner ring, and Flexeals 'FF' a lightly contacting seal suitable for high speeds are available as options in many sizes.

The relevant selection data and calculations for deep groove ball bearings can be found on pages :

- Life Calculations	Page 57
- Lubrication	Page 63-66
- Tolerances	Page 71
- Manufacturing Tolerances for Mating Parts	Page 73-79
- Attainable speed	Page 84
- Preload	Page 97
- Cages/Closures	Page 99-102

Deep Groove Ball Bearings

204SSTX200K6 CG-6

Material

C Ceramic balls
 — SAE 52100
 S AISI 440C

Series/Size

30 Metric instrument bearings
 100 Metric extra light
 200 Metric light

Closures

SS Double shield
 FF Double seal
 Flexeal

Cage

— Pressed steel two piece ribbon cage
 T Two piece riveted, phenolic with aluminium side plates
 TA One piece snap, phenolic

Special Features

X, Y Deviation from standard
 K Separating symbol

Lubrication

O, OJ Oil
 G, GJ Grease

Calibration

Bore/Outside Diameter

C 2 step IR/OR
 CXO 2 step IR
 COX 2 step OR
 C44 4 step IR/OR
 C40 4 step IR
 C04 4 step OR

Radial Runout

E Reduced radial runout (< .001 mm)
 R High point marked on IR
 R1 High point marked on OR
 R2 High point marked on IR/OR

Duplex Pairs

DB Back to back
 DF Face to face
 DT Tandem
 D Universal

Radial Play [µm]

Bearing	3	5	6
34 – 103	5 – 10	13 – 20	20 – 28
104 – 107/ 200 – 205	5 – 13	13 – 23	23 – 36
206 – 209	5 – 13	18 – 30	30 – 43
110	10 – 20	20 – 33	33 – 48

IR = Inner Ring
 OR = Outer Ring

Deep Groove Ball Bearings

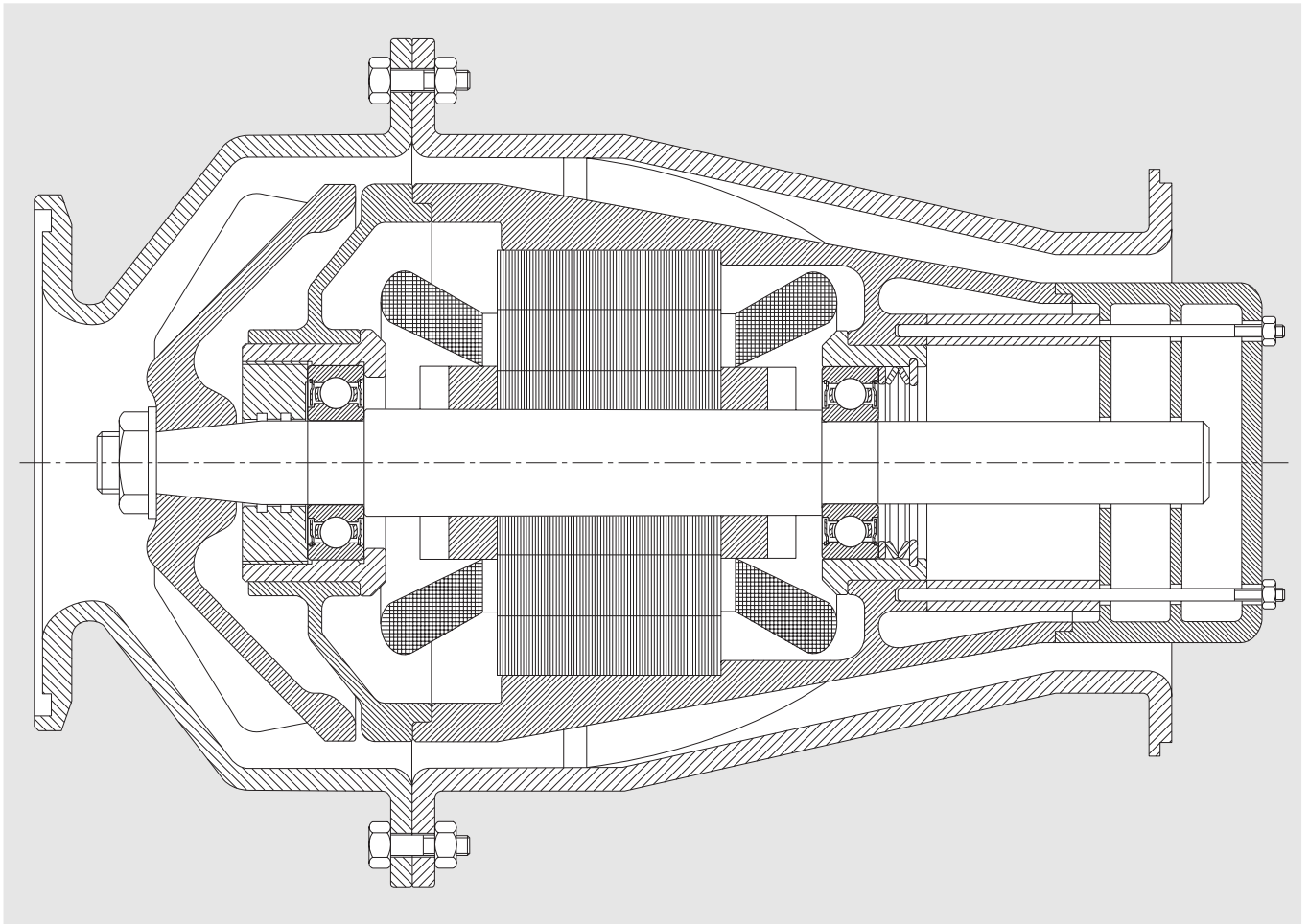

Application - Aircraft Avionic Instrumentation Cooling Fan.

Technical Data

Speed :	22,500 rpm
Temperature Range :	-20 to +90°C
	160°C maximum
Load : Axial	68 N maximum
Radial	48 N maximum

Bearing Selection

S38SSW5CXO G-36

Application details provided courtesy of
Airscrew Howden Ltd.

Deep Groove Ball Bearings

Deep groove ball bearings
metric

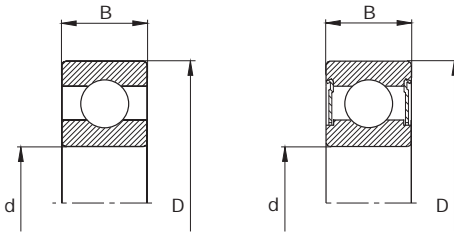

Basic Bearing	Open	Shielded Sealed	Dimensions			Load Rating		Max. Axial Load stat.	Attainable Speed		Two piece riveted phenolic cage		f ₀ Factor	Weight ≈ kg
			d	D	B	dyn. C	stat. C ₀		Steel Ribbon cage Grease/Oil rpm	Phenolic snap cage	Grease	Oil		
Barden			mm			kN								
34(T)	(S)34SS		4	16	5	0.9	0.24	0.4	50000	120000	140000	200000	11.2	0.01
34-5(T)	(S)34-5SS		5	16	5	0.9	0.24	0.4	50000	120000	140000	200000	11.2	0.01
35(T)	(S)35SS			19	6	1.14	0.33	0.52	40000	100000	115000	160000	12	0.01
36(T)	(S)36SS		6	19	6	1.14	0.33	0.52	40000	100000	115000	160000	12	0.01
37(T)	(S)37SS*		7	22	7	1.55	0.52	0.77	32000	75000	86000	120000	12.3	0.01
—	37SSTX2*			22	10.31	2.62	1.34	0.5	—	—	86000	120000	12.3	0.02
38(T)	(S)38SS*		8	22	7	1.55	0.52	0.77	32000	75000	86000	120000	12.3	0.01
—	38SSTX2*			22	10.31	2.62	1.34	0.5	—	—	86000	120000	12.3	0.02
—	38SSTX6*			24	10.31	2.62	1.34	0.5	—	—	86000	120000	12.3	0.02
39(T)	39SS		9	26	8	3.78	1.48	1.38	25000	60000	70000	100000	12.4	0.02
100(T)	100SS*		10	26	8	3.78	1.48	1.38	25000	60000	70000	100000	12.4	0.02
—	100SSTX1*			26	11.51	2.94	0.95	1.92	—	—	70000	80000	12.4	0.03
200(T)	200SS*			30	9	4.48	1.66	2.27	23000	56000	52000	80000	12.3	0.03
101(T)	—		12	28	8	3.3	1.16	2.26	—	50000	58000	80000	13.1	0.02
-	101SSTX1*			28	11.51	4.22	1.81	1.64	—	—	58000	80000	13.1	0.03
201(T)	201SS*			32	10	5.12	1.94	2.49	21000	48000	54000	68000	12.4	0.04
—	9201FFT			32	15.88	5.12	1.94	2.49	—	—	54000	68000	12.4	0.05
—	201SSTX1*		13	32	12.7	5.12	1.94	2.49	—	—	54000	68000	12.4	0.05
102(T)	—		15	32	9	4.18	1.88	2.81	—	—	46000	66000	13.9	0.03
202(T)	—			35	11	5.81	2.27	3.12	17000	38000	44000	54000	12.7	0.05
—	202SSTX1*			35	12.7	5.81	2.27	3.12	—	—	44000	54000	12.7	0.08
103(T)	103SS(T)*		17	35	10	4.98	2.44	1.92	16000	35000	40000	58000	14.1	0.04
203(T)	203SS(T)*			40	12	7.18	3.08	4.87	15000	33000	38000	46000	13.1	0.09
—	9203FFT			40	17.46	7.18	3.08	4.87	—	—	35000	—	13.1	0.12
104T	104SST*		20	42	12	7.45	3.79	4.3	—	—	35000	50000	13.9	0.08
204T	204SST*			47	14	9.67	4.31	6.84	—	—	32000	40000	13.1	0.09
—	9204FFT			47	20.64	9.67	4.31	6.84	—	—	30000	—	13.1	0.12
105T	105SST*		25	47	12	7.57	3.71	9.19	—	—	28000	40000	14.5	0.1
205T	205SST*			52	15	10.6	5.05	7.88	—	—	26000	32000	14	0.13
—	9205FFT			52	20.64	10.6	5.05	7.88	—	—	24000	—	14	0.16
106T	106SST*		30	55	13	10.2	5.4	8.22	—	—	23000	33000	14.8	0.14
206T	206SST*			62	16	14.7	7.24	11.2	—	—	22000	26000	13.8	0.22
—	9206FFT			62	23.81	14.7	7.24	11.2	—	—	20000	—	13.8	0.27
107(T)	107SS(T)*		35	62	14	11.5	6.64	14.1	9000	—	20000	28000	14.8	0.16
207(T)	207SS(T)*			72	17	19.4	9.91	18	8000	—	19000	24000	13.8	0.31
208T	—		40	80	18	22	11.56	27.5	—	—	16000	25000	14	0.35
209T	—		45	85	19	23.9	13.66	23.7	—	—	15000	22000	14.4	0.4
110T	110SST		50	80	16	18.5	11.48	20.6	—	—	14000	20000	15.3	0.45

* Flexeal available (FF)

Section 2 Super Precision Bearings



P4S - A New Standard Advantages of Sealed FAG HSS and HCS Spindle Bearings

Sealed FAG Spindle Bearings HSS and HCS - Maintenance Free and Lu- bricated for Life.

Grease is the common lubricant used for bearings in machine tool spindles. It lowers lubrication and maintenance costs, and improves the machinery environment to a large extent. Bearings which are greased for life present an economical design solution.

Sealed HCS and HSS bearing are available in all sizes up to 130 mm diameter.

FAG is the first manufacturer of sealed spindle bearings that are ready to assemble, lubricated for life, and therefore maintenance free.

The following important advantages of these sealed bearings have been confirmed many times by manufacturers of machine tools and users alike :

- ease of handling during assembly
- no washing
- no greasing
- no danger of contamination during greasing or assembly
- high level of cleanliness in the bearing - precondition for a long working life
- the correct type and quantity of grease in the bearing
- the type and quantity of grease and sealing system are suited to one another
- no frictional losses - the RSD is a non contact seal
- good sealing action both from outside and inside effects
- the grease base oil remains in the bearing
- air flow and ventilation through the bearing are greatly reduced
- the grease neither dries out nor is it contaminated by polluted air flow
- since additional sealing can be simplified the moment arm is reduced
- the grease stays in the bearing if the spindle is inclined during operation
- faster replacement of bearing, - but not at the cost of cleanliness in the bearing

P4S - a new standard for high precision bearings with running accuracy improved by 100 %

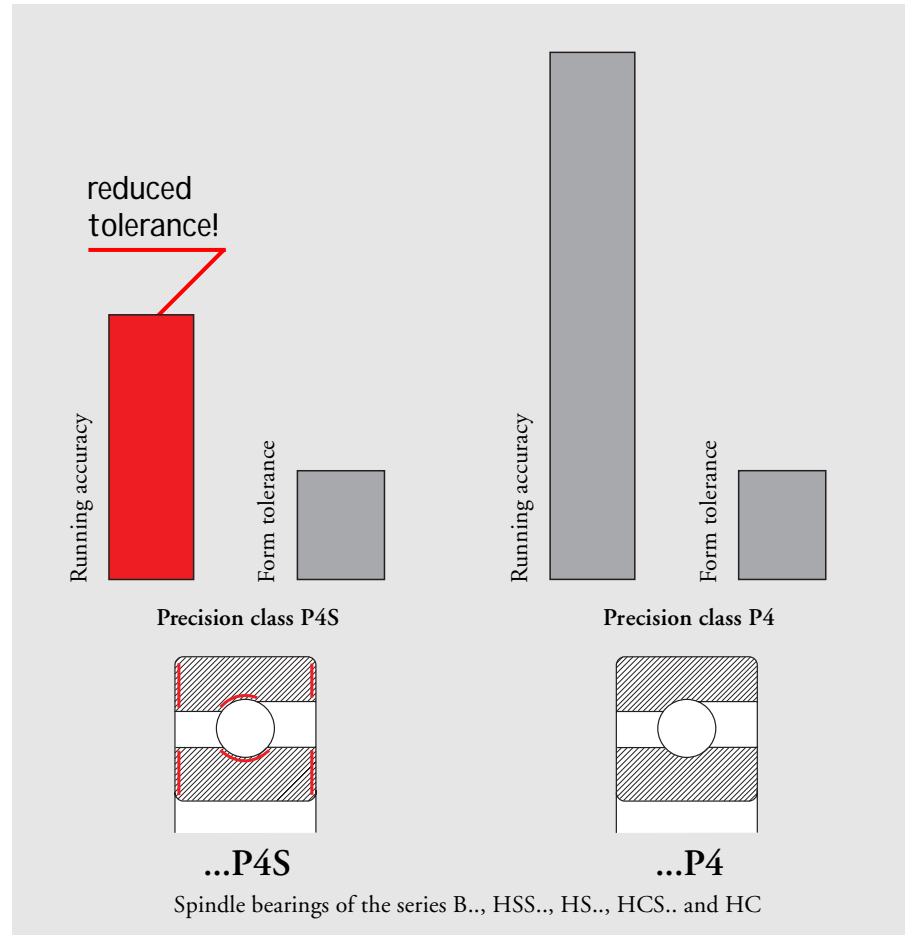

- exchangeable with bearings from the 70 and 719 series.

The large internal space between the rotating parts and stationary seals allows a relatively large amount of grease, acting as a reservoir to provide extended operating life of the bearing.

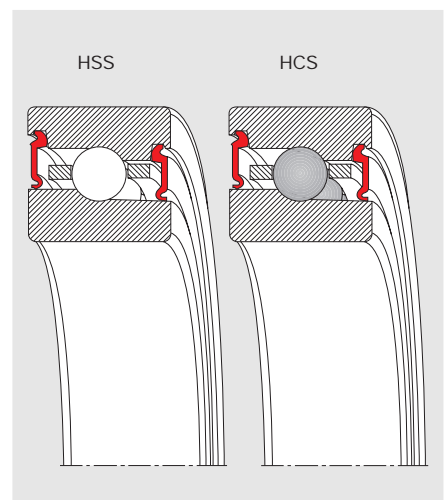

2

Advantages of Hybrid Spindle Bearings

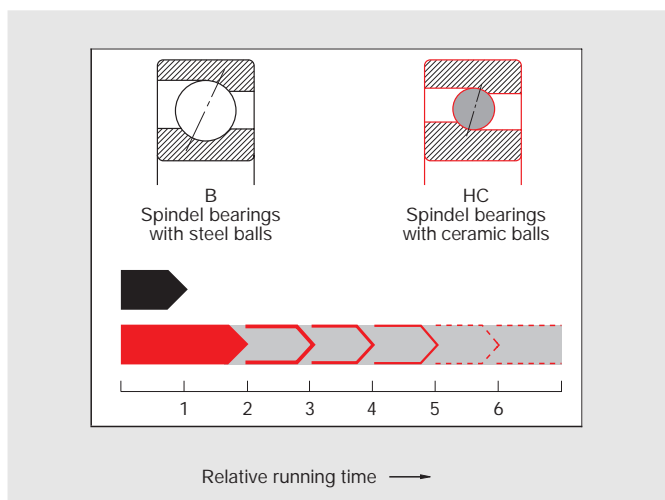

The speed is about 55 percent higher than that of series B bearings and about 15 percent higher than that of the HS high-speed spindle bearings.

The small ball design of the HC bearings and the ceramic ball material being approximately 60% lighter than steel reduces centrifugal force and friction. The resulting excellent running properties are improved further by the advantageous running condition in the rolling contact zone.

This is also true of sealed designs because the seals are non-contacting.

The service life of hybrid spindle bearings both with grease and with oil lubrication is several times that of the life reached by bearings with steel balls. Friction and adhesion between ceramic and steel, and consequently wear, are very low - specially at cold starts.

The high cleanliness standards in the area of rolling element contact is maintained with sealed bearings - preconditioned for a long bearing service life.

The sealing effect towards the inside and the outside retains the grease in the contact area. Contaminants cannot penetrate into the bearing. Additionally damaging air flow through the bearing is reduced.

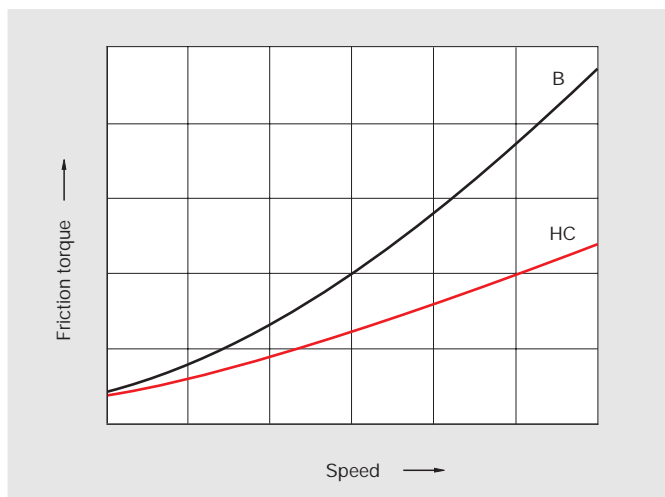
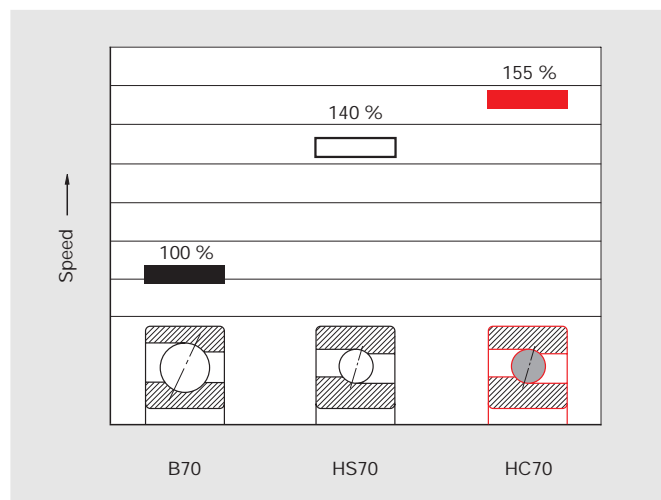

Hybrid bearings are protected against seizure during starved lubrication or dry running conditions by their excellent emergency running properties of low adhesion and friction.

Advantages of Hybrid Spindle Bearings

At the same speed the operating temperature is lower than that of bearings with steel balls.

Temperatures are increased by friction and friction is lower with the ceramic-steel combination.

Due to the low thermal conductivity of ceramic material the ball “keeps cool”. Thermal expansion and changes in preload and thus friction remain small.

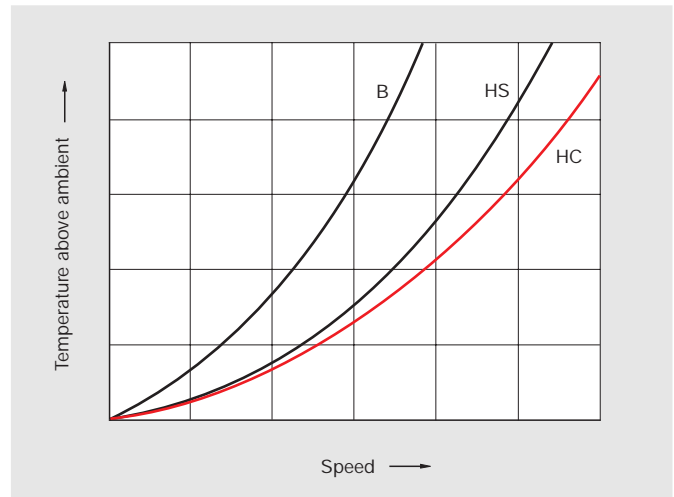

2

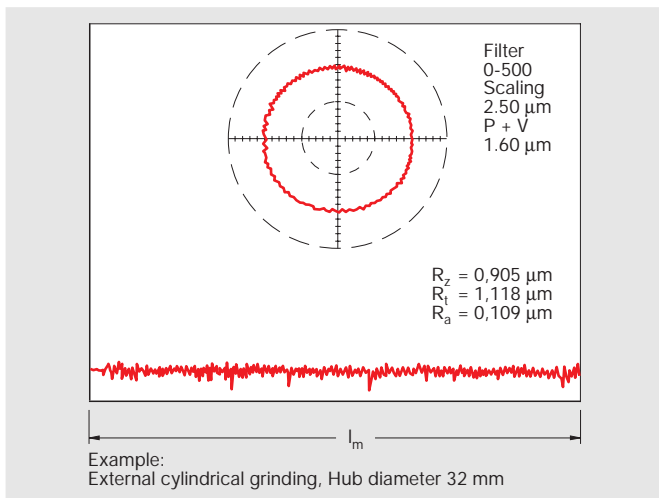

Surface quality and precision of the work-pieces are improved with hybrid bearings. The excellent results obtained with grinding machines confirms this statement. This can be explained by a number of reasons including the high modulus of elasticity of ceramic material and the large number of small balls which make the bearing very rigid.

The advantages of grease lubrication can be maintained up to high-speeds. Thus the high expense of a complex oil lubrication system can be saved.

This is made possible by “cool running” through excellent tribological properties of the ceramic material, and in particular the dissimilar materials in contact.

Experience shows that the working life of the grease is approx. 5 times longer, resulting in extended working life of the hybrid bearing.

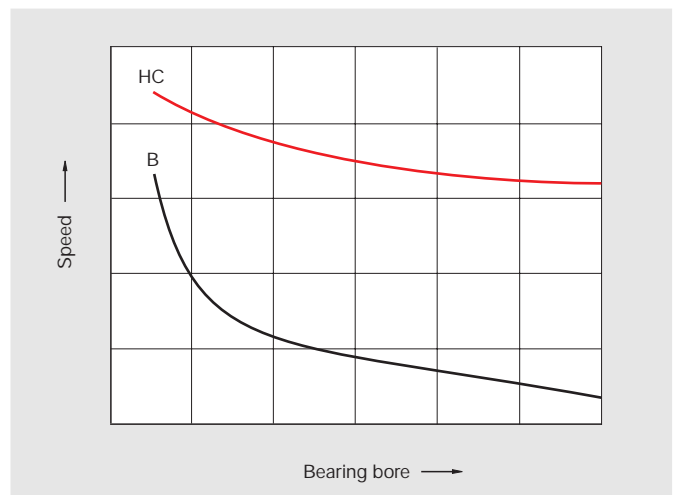

Spindle Bearings



Spindle Bearings

FAG Spindle bearings are single row angular contact ball bearings of the highest precision. Advantages offered by the special design features of the contact angle, cage and internal geometry are

- higher rigidity
- optimum rotational accuracy
- excellent speedability
- low vibration output

In machine tools and textile machine construction and in many other areas of application the tendency is towards ever higher rotational speeds and ever greater precision.

Various types are available to suit a wide range of specific operating conditions.

- FAG spindle bearings from the B719, B70 and B72 series

- FAG high speed spindle bearings from the HS719 and HS70 series
- FAG hybrid spindle bearings from the HC719 and HC70 series.

All spindle bearings have a contact angle of 15° (type C) or 25° (type E) and are available either as a universal bearing or as a bearing set.

The envelope dimensions of high speed (HS) and hybrid spindle bearings (HC) are identical to the B series spindle bearings. The design characteristics allow extreme speeds, low friction and heat build-up, contributing to lower demands on the lubricant and a longer working life.

They are also available as sealed units (HSS or HCS spindle bearings).





All series are produced in high precision P4S quality (running accuracy to precision P2 and envelope dimensions to precision P4).

The relevant selection data and calculation for spindle bearings can be found on pages :

- Life Calculations	Page 56-62
- Lubrication	Page 63-66
- Tolerances	Page 68-69
- Manufacturing Tolerances for Mating Parts	Page 72-80
- Attainable Speeds	Page 84
- Rigidity	Page 85
- Preload	Page 93-96

Spindle Bearings

B7008C.T.P4S.UL

Type		Standard Preloads	
B	Standard OR relieved, IR symmetrical	L	Light
HCB	Standard OR relieved, IR symmetrical Ceramic balls	M	Medium
HS	High speed small ball bearing Double relieved	H	Heavy
HSS	High speed bearing, sealed	Bearing Sets	
HC	High speed ball bearing Ceramic balls	U	Single bearing, Universal
HCS	High speed ball bearing Ceramic balls, sealed	DU	Duplex set, Universal
Series		TU	Triplex set, Universal
719	Light series	QU	Quadruplex set, Universal
70	Medium series	PU	Pentaplex set, Universal
72	Heavy series	DB	Duplex set, Back to back 
Bore Diameter		DF	Duplex set, Face to face 
00	10 mm	DT	Duplex set, Tandem 
01	12 mm	TBT	Triplex set, Tandem, back to back 
02	15 mm	QBC	Quadruplex set, Double tandem, back to back 
03	17 mm	Precision	
04	4 · 5 = 20 mm	P4S	FAG tolerance, better than ISO P4
05	5 · 5 = 25 mm	Cage	
Contact Angle		T	Phenolic, OR riding
C	15°		
E	25°		

IR = Inner Ring
OR = Outer Ring

Spindle Bearings

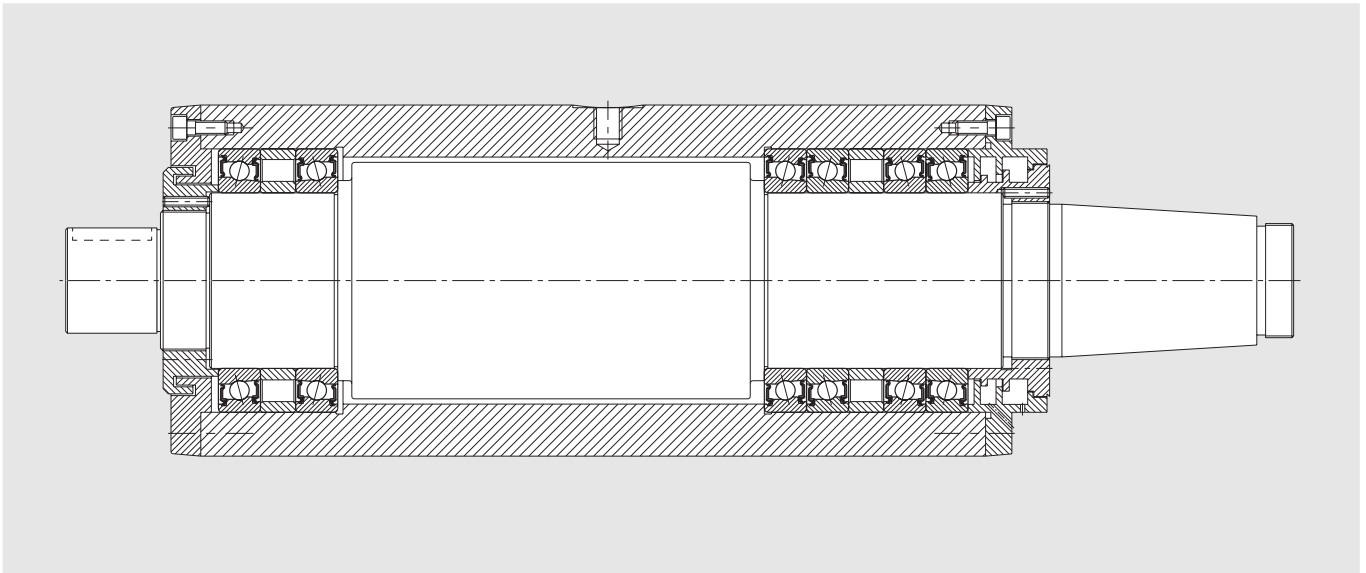

Cylindrical Grinding Spindle

Technical Data

Motor power: 11 kW
Speed: $n = 7500$ rpm

Bearing Selection

Cylindrical grinding demands high cutting efficiency for rough grinding as well as accurate form and surface finish quality for fine finish grinding. Essential criteria for the bearings are high stiffness and rotational accuracy whilst achieving a suitable speedability and good damping.

Working end: 1 spindle bearing set FAG HSS 7020C.T.P4S.QBCL in a double tandem, back to back arrangement, fully clamped.

Drive end: 1 spindle bearing set FAG HSS 7020C.T.P4S.DBL in a back to back arrangement, floating.

Bearing Dimensions

The size of the bearing is determined from the requisite spindle diameter or predetermined outer housing diameter. The contact angle of 15° is favourable

for a high radial rigidity. By means of the 4 bearing arrangement on the work side the damping and rotational accuracy is improved.

Preload

Both bearing sets have a light preload. The two spacers are of identical widths. Their purpose is to reduce the thermal effects through separation.

Lubrication and Sealing.

The sealed FAG HSS spindle bearings are maintenance free and lubricated for life with FAG Arcanol L74 bearing grease.

A labyrinth with defined axial clearance of between $0.3...0.8$ mm serves as an additional seal on the grinding wheel side. A simple labyrinth seal suffices on the drive side.

Spindle Bearing Marking

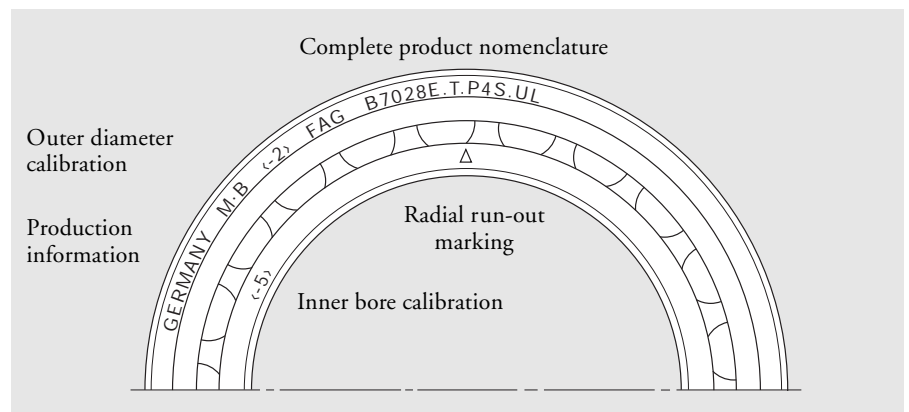

Spindle Bearings

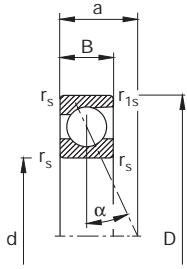

B719C., B70C., B72C.

Contact angle $\alpha = 15^\circ$

B719E., B70E., B72E.

Contact angle $\alpha = 25^\circ$

Bearing Number	Dimensions						Load Rating		Attainable Speed		Weight ≈ kg
	d	D	B	r _{smin}	r _{1smin}	a	dyn. C	stat. C ₀	Grease rpm	Oil minimal	
FAG	mm						≈	kN			
B706C.T.P4S.	6	17	6	0.30	0.30	4	2.36	0.97	95000	160000	0.005
B706E.T.P4S.		17	6	0.30	0.30	4	2.28	0.93	85000	140000	0.005
B707C.T.P4S.	7	19	6	0.30	0.30	5	2.60	1.14	85000	140000	0.008
B707E.T.P4S.		19	6	0.30	0.30	5	2.50	1.10	75000	120000	0.008
B708C.T.P4S.	8	22	7	0.30	0.30	5	3.80	1.73	75000	120000	0.01
B708E.T.P4S.		22	7	0.30	0.30	5	3.75	1.66	67000	100000	0.01
B709C.T.P4S.	9	24	7	0.30	0.30	6	5.20	2.40	67000	100000	0.015
B709E.T.P4S.		24	7	0.30	0.30	6	5.10	2.32	60000	90000	0.015
B71900C.T.P4S.	10	22	6	0.30	0.15	5	3.90	1.80	70000	110000	0.01
B71900E.T.P4S.		22	6	0.30	0.15	7	3.75	1.73	63000	95000	0.01
B7000C.T.P4S.	26	8	0.30	0.30	6	5.30	2.50	60000	90000	0.02	
B7000E.T.P4S.		26	8	0.30	0.30	8	5.10	2.40	56000	85000	0.02
B7200C.T.P4S.	30	9	0.60	0.60	7	6.95	3.35	56000	85000	0.03	
B7200E.T.P4S.		30	9	0.60	0.60	9	6.80	3.25	50000	75000	0.03
B71901C.T.P4S.	12	24	6	0.30	0.15	5	4.50	2.28	60000	90000	0.01
B71901E.T.P4S.		24	6	0.30	0.15	7	4.30	2.20	56000	85000	0.01
B7001C.T.P4S.	28	8	0.30	0.30	7	5.85	2.90	53000	80000	0.02	
B7001E.T.P4S.		28	8	0.30	0.30	9	5.60	2.80	50000	75000	0.02
B7201C.T.P4S.	32	10	0.60	0.60	8	8.00	3.90	50000	75000	0.04	
B7201E.T.P4S.		32	10	0.60	0.60	10	7.65	3.75	45000	67000	0.04
B71902C.T.P4S.	15	28	7	0.30	0.15	6	5.00	2.90	50000	75000	0.02
B71902E.T.P4S.		28	7	0.30	0.15	9	4.80	2.75	45000	67000	0.02
B7002C.T.P4S.	32	9	0.30	0.30	8	6.20	3.40	48000	70000	0.03	
B7002E.T.P4S.		32	9	0.30	0.30	10	6.00	3.25	43000	63000	0.03
B7202C.T.P4S.	35	11	0.60	0.60	9	9.65	5.00	45000	67000	0.04	
B7202E.T.P4S.		35	11	0.60	0.60	11	9.30	4.80	40000	60000	0.04
B71903C.T.P4S.	17	30	7	0.30	0.15	7	5.30	3.15	48000	70000	0.02
B71903E.T.P4S.		30	7	0.30	0.15	9	5.00	3.00	43000	63000	0.02
B7003C.T.P4S.	35	10	0.30	0.30	8	8.65	4.90	43000	63000	0.04	
B7003E.T.P4S.		35	10	0.30	0.30	11	8.30	4.75	38000	56000	0.04
B7203C.T.P4S.	40	12	0.60	0.60	10	10.80	5.85	38000	56000	0.06	
B7203E.T.P4S.		40	12	0.60	0.60	13	10.40	5.60	36000	53000	0.06
B71904C.T.P4S.	20	37	9	0.30	0.15	8	9.15	5.50	38000	56000	0.03
B71904E.T.P4S.		37	9	0.30	0.15	11	8.80	5.30	36000	53000	0.03
B7004C.T.P4S.	42	12	0.60	0.60	10	10.40	6.00	36000	53000	0.07	
B7004E.T.P4S.		42	12	0.60	0.60	13	10.00	5.70	32000	48000	0.07
B7204C.T.P4S.	47	14	1.00	1.00	12	14.60	8.15	32000	48000	0.10	
B7204E.T.P4S.		47	14	1.00	1.00	15	14.00	7.80	30000	45000	0.10
B71905C.T.P4S.	25	42	9	0.30	0.15	9	10.00	6.70	32000	48000	0.04
B71905E.T.P4S.		42	9	0.30	0.15	12	9.50	6.40	30000	45000	0.04
B7005C.T.P4S.	47	12	0.60	0.60	11	14.60	9.15	30000	45000	0.08	
B7005E.T.P4S.		47	12	0.60	0.60	14	13.70	8.65	28000	43000	0.08
B7205C.T.P4S.	52	15	1.00	1.00	13	15.60	9.30	28000	43000	0.12	
B7205E.T.P4S.		52	15	1.00	1.00	16	15.00	9.00	26000	40000	0.12

2

Spindle Bearings

B719C., B70C., B72C.

Contact angle $\alpha = 15^\circ$

B719E., B70E., B72E.

Contact angle $\alpha = 25^\circ$

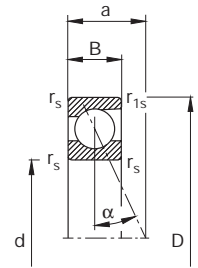

Bearing Number	Dimensions						Load Rating		Attainable Speed		Weight ≈ kg
	d	D	B	r _{smin}	r _{1smin}	a ≈	dyn. C	stat. C ₀	Grease rpm	Oil minimal	
FAG	mm						kN		rpm		
B71906C.T.P4S.	30	47	9	0.30	0.15	10	10.80	7.80	28000	43000	0.05
B71906E.T.P4S.		47	9	0.30	0.15	13	10.20	7.35	26000	40000	0.05
B7006C.T.P4S.		55	13	1.00	1.00	12	15.00	10.20	26000	40000	0.11
B7006E.T.P4S.		55	13	1.00	1.00	17	14.30	9.80	24000	38000	0.11
B7206C.T.P4S.		62	16	1.00	1.00	14	23.20	14.60	24000	38000	0.19
B7206E.T.P4S.		62	16	1.00	1.00	19	22.00	14.00	22000	36000	0.19
B71907C.T.P4S.	35	55	10	0.60	0.30	11	14.30	10.80	24000	38000	0.07
B71907E.T.P4S.		55	10	0.60	0.30	16	13.40	10.40	22000	36000	0.07
B7007C.T.P4S.		62	14	1.00	1.00	13	19.00	13.70	22000	36000	0.15
B7007E.T.P4S.		62	14	1.00	1.00	18	18.30	12.90	20000	34000	0.15
B7207C.T.P4S.		72	17	1.10	1.10	16	30.50	20.00	20000	34000	0.28
B7207E.T.P4S.		72	17	1.10	1.10	21	29.00	19.00	19000	32000	0.28
B71908C.T.P4S.	40	62	12	0.60	0.30	13	17.60	13.70	22000	36000	0.11
B71908E.T.P4S.		62	12	0.60	0.30	18	16.60	13.20	20000	34000	0.11
B7008C.T.P4S.		68	15	1.00	1.00	15	20.40	16.00	20000	34000	0.19
B7008E.T.P4S.		68	15	1.00	1.00	20	19.60	15.00	19000	32000	0.19
B7208C.T.P4S.		80	18	1.10	1.10	17	32.00	22.40	18000	30000	0.37
B7208E.T.P4S.		80	18	1.10	1.10	23	30.50	21.60	17000	28000	0.37
B71909C.T.P4S.	45	68	12	0.60	0.30	14	18.60	15.60	19000	32000	0.13
B71909E.T.P4S.		68	12	0.60	0.30	19	17.60	15.00	18000	30000	0.13
B7009C.T.P4S.		75	16	1.00	1.00	16	27.50	21.20	18000	30000	0.23
B7009E.T.P4S.		75	16	1.00	1.00	22	26.50	20.00	17000	28000	0.23
B7209C.T.P4S.		85	19	1.10	1.10	18	40.50	29.00	17000	28000	0.41
B7209E.T.P4S.		85	19	1.10	1.10	25	39.00	27.50	15000	24000	0.41
B71910C.T.P4S.	50	72	12	0.60	0.30	14	19.00	16.60	18000	30000	0.13
B71910E.T.P4S.		72	12	0.60	0.30	20	18.00	15.60	16000	26000	0.13
B7010C.T.P4S.		80	16	1.00	1.00	17	28.50	22.80	17000	28000	0.25
B7010E.T.P4S.		80	16	1.00	1.00	23	27.00	21.60	15000	24000	0.25
B7210C.T.P4S.		90	20	1.10	1.10	19	43.00	31.50	16000	26000	0.46
B7210E.T.P4S.		90	20	1.10	1.10	26	40.50	30.50	14000	22000	0.46
B71911C.T.P4S.	55	80	13	1.00	0.30	16	22.80	20.40	16000	26000	0.18
B71911E.T.P4S.		80	13	1.00	0.30	22	21.60	19.30	15000	24000	0.18
B7011C.T.P4S.		90	18	1.10	1.10	19	38.00	31.00	15000	24000	0.37
B7011E.T.P4S.		90	18	1.10	1.10	26	36.00	29.00	14000	22000	0.37
B7211C.T.P4S.		100	21	1.50	1.50	21	53.00	40.00	14000	22000	0.61
B7211E.T.P4S.		100	21	1.50	1.50	29	50.00	38.00	13000	20000	0.61
B71912C.T.P4S.	60	85	13	1.00	0.30	16	24.00	22.80	15000	24000	0.19
B71912E.T.P4S.		85	13	1.00	0.30	23	22.80	21.60	14000	22000	0.19
B7012C.T.P4S.		95	18	1.10	1.10	19	39.00	33.50	14000	22000	0.40
B7012E.T.P4S.		95	18	1.10	1.10	27	36.50	31.50	13000	20000	0.40
B7212C.T.P4S.		110	22	1.50	1.50	22	55.00	44.00	13000	20000	0.80
B7212E.T.P4S.		110	22	1.50	1.50	31	52.00	42.50	12000	19000	0.80
B71913C.T.P4S.	65	90	13	1.00	0.30	17	24.50	24.00	14000	22000	0.20
B71913E.T.P4S.		90	13	1.00	0.30	25	22.80	22.40	13000	20000	0.20
B7013C.T.P4S.		100	18	1.10	1.10	20	40.00	35.50	13000	20000	0.42
B7013E.T.P4S.		100	18	1.10	1.10	28	38.00	33.50	12000	19000	0.42

Spindle Bearings

B719C., B70C., B72C.

Contact angle $\alpha = 15^\circ$

B719E., B70E., B72E.

Contact angle $\alpha = 25^\circ$

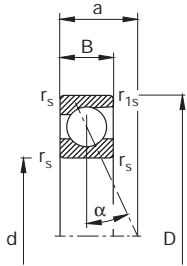

Bearing Number	Dimensions						Load Rating		Attainable Speed		Weight ≈ kg
	d	D	B	r _{smin}	r _{1smin}	a ≈	dyn. C	stat. C ₀	Grease rpm	Oil minimal	
FAG	mm						kN		rpm		
B7213C.T.P4S.		120	23	1.50	1.50	24	67.00	54.00	12000	19000	1.02
B7213E.T.P4S.		120	23	1.50	1.50	33	64.00	52.00	11000	18000	1.02
B71914C.T.P4S.	70	100	16	1.00	0.30	19	33.50	32.50	13000	20000	0.33
B71914E.T.P4S.		100	16	1.00	0.30	28	31.50	31.00	12000	19000	0.33
B7014C.T.P4S.		110	20	1.10	1.10	22	50.00	43.00	12000	19000	0.59
B7014E.T.P4S.		110	20	1.10	1.10	31	46.50	41.50	11000	18000	0.59
B7214C.T.P4S.		125	24	1.50	1.50	25	69.50	58.50	11000	18000	1.12
B7214E.T.P4S.		125	24	1.50	1.50	35	65.50	56.00	10000	17000	1.12
B71915C.T.P4S.	75	105	16	1.00	0.30	20	34.00	34.50	12000	19000	0.35
B71915E.T.P4S.		105	16	1.00	0.30	29	32.00	32.50	11000	18000	0.35
B7015C.T.P4S.		115	20	1.10	1.10	23	51.00	46.50	12000	19000	0.62
B7015E.T.P4S.		115	20	1.10	1.10	32	48.00	44.00	11000	18000	0.62
B7215C.T.P4S.		130	25	1.50	1.50	26	72.00	63.00	11000	18000	1.21
B7215E.T.P4S.		130	25	1.50	1.50	36	68.00	60.00	9500	16000	1.21
B71916C.T.P4S.	80	110	16	1.00	0.30	21	34.50	36.00	12000	19000	0.37
B71916E.T.P4S.		110	16	1.00	0.30	30	32.50	34.00	11000	18000	0.37
B7016C.T.P4S.		125	22	1.10	1.10	25	63.00	58.50	11000	18000	0.84
B7016E.T.P4S.		125	22	1.10	1.10	35	60.00	55.00	9500	16000	0.84
B7216C.T.P4S.		140	26	2.00	2.00	28	93.00	78.00	10000	17000	1.47
B7216E.T.P4S.		140	26	2.00	2.00	39	88.00	73.50	9000	15000	1.47
B71917C.T.P4S.	85	120	18	1.10	0.60	23	45.00	46.50	11000	18000	0.53
B71917E.T.P4S.		120	18	1.10	0.60	33	42.50	44.00	9500	16000	0.53
B7017C.T.P4S.		130	22	1.10	1.10	25	65.50	62.00	10000	17000	0.89
B7017E.T.P4S.		130	22	1.10	1.10	36	62.00	58.50	9000	15000	0.89
B7217C.T.P4S.		150	28	2.00	2.00	30	96.50	85.00	9000	15000	1.85
B7217E.T.P4S.		150	28	2.00	2.00	42	91.50	80.00	8000	13000	1.85
B71918C.T.P4S.	90	125	18	1.10	0.60	23	45.50	49.00	10000	17000	0.55
B71918E.T.P4S.		125	18	1.10	0.60	34	43.00	46.50	9000	15000	0.55
B7018C.T.P4S.		140	24	1.50	1.50	27	76.50	72.00	9500	16000	1.15
B7018E.T.P4S.		140	24	1.50	1.50	39	72.00	68.00	8500	14000	1.15
B7218C.T.P4S.		160	30	2.00	2.00	32	122.00	104.00	8500	14000	2.26
B7218E.T.P4S.		160	30	2.00	2.00	44	116.00	100.00	7500	12000	2.26
B71919C.T.P4S.	95	130	18	1.10	0.60	24	46.50	51.00	9500	16000	0.58
B71919E.T.P4S.		130	18	1.10	0.60	35	44.00	48.00	8500	14000	0.58
B7019C.T.P4S.		145	24	1.50	1.50	28	78.00	76.50	9000	15000	1.20
B7019E.T.P4S.		145	24	1.50	1.50	40	75.00	72.00	8000	13000	1.20
B7219C.T.P4S.		170	32	2.10	2.10	34	127.00	114.00	8000	13000	2.78
B7219E.T.P4S.		170	32	2.10	2.10	47	122.00	108.00	7000	11000	2.78
B71920C.T.P4S.	100	140	20	1.10	0.60	26	58.50	64.00	9000	15000	0.79
B71920E.T.P4S.		140	20	1.10	0.60	38	55.00	60.00	8000	13000	0.79
B7020C.T.P4S.		150	24	1.50	1.50	29	81.50	81.50	8500	14000	1.26
B7020E.T.P4S.		150	24	1.50	1.50	41	76.50	76.50	7500	12000	1.26
B7220C.T.P4S.		180	34	2.10	2.10	36	156.00	137.00	7500	12000	3.32
B7220E.T.P4S.		180	34	2.10	2.10	50	150.00	129.00	6700	10000	3.32
B71921C.T.P4S.	105	145	20	1.10	0.60	27	58.50	64.00	8500	14000	0.82
B71921E.T.P4S.		145	20	1.10	0.60	39	55.00	60.00	7500	12000	0.82

2

Spindle Bearings

B719C., B70C., B72C.

Contact angle $\alpha = 15^\circ$

B719E., B70E., B72E.

Contact angle $\alpha = 25^\circ$

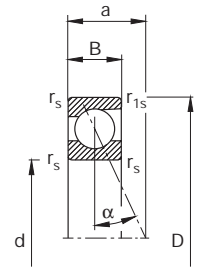

Bearing Number	Dimensions						Load Rating		Attainable Speed		Weight ≈ kg
	d	D	B	r _{smin}	r _{1smin}	a ≈	dyn. C	stat. C ₀	Grease	Oil minimal	
FAG	mm						kN		rpm		
B7021C.T.P4S.		160	26	2.00	2.00	31	106.00	102.00	8000	13000	1.58
B7021E.T.P4S.		160	26	2.00	2.00	44	102.00	98.00	7000	11000	1.58
B7221C.T.P4S.		190	36	2.10	2.10	38	163.00	146.00	7000	11000	3.98
B7221E.T.P4S.		190	36	2.10	2.10	52	156.00	140.00	6300	9500	3.98
B71922C.T.P4S.	110	150	20	1.10	0.60	27	58.50	67.00	8000	13000	0.85
B71922E.T.P4S.		150	20	1.10	0.60	40	56.00	63.00	7500	12000	0.85
B7022C.T.P4S.		170	28	2.00	2.00	33	110.00	110.00	7500	12000	2.00
B7022E.T.P4S.		170	28	2.00	2.00	47	104.00	104.00	6700	10000	2.00
B7222C.T.P4S.		200	38	2.10	2.10	40	163.00	150.00	6700	10000	4.66
B7222E.T.P4S.		200	38	2.10	2.10	55	153.00	143.00	6000	9000	4.66
B71924C.T.P4S.	120	165	22	1.10	0.60	30	73.50	85.00	7000	11000	1.17
B71924E.T.P4S.		165	22	1.10	0.60	44	69.50	80.00	6700	10000	1.17
B7024C.T.P4S.		180	28	2.00	2.00	34	112.00	116.00	6700	10000	2.13
B7024E.T.P4S.		180	28	2.00	2.00	49	106.00	110.00	6300	9500	2.13
B7224C.T.P4S.		215	40	2.10	2.10	42	204.00	196.00	6000	9000	5.49
B7224E.T.P4S.		215	40	2.10	2.10	59	196.00	186.00	5300	8000	5.49
B71926C.T.P4S.	130	180	24	1.50	0.60	33	86.50	100.00	6700	10000	1.54
B71926E.T.P4S.		180	24	1.50	0.60	48	81.50	95.00	6000	9000	1.54
B7026C.T.P4S.		200	33	2.00	2.00	39	143.00	150.00	6000	9000	3.21
B7026E.T.P4S.		200	33	2.00	2.00	55	137.00	143.00	5600	8500	3.21
B7226C.T.P4S.		230	40	3.00	3.00	44	212.00	216.00	5600	8500	6.34
B7226E.T.P4S.		230	40	3.00	3.00	62	204.00	204.00	5000	7500	6.34
B71928C.T.P4S.	140	190	24	1.50	0.60	34	90.00	108.00	6000	9000	1.65
B71928E.T.P4S.		190	24	1.50	0.60	50	85.00	102.00	5600	8500	1.65
B7028C.T.P4S.		210	33	2.00	2.00	40	146.00	160.00	5600	8500	3.40
B7028E.T.P4S.		210	33	2.00	2.00	57	140.00	150.00	5000	7500	3.40
B7228C.T.P4S.		250	42	3.00	3.00	47	220.00	232.00	5000	7500	8.08
B7228E.T.P4S.		250	42	3.00	3.00	66	212.00	224.00	4500	6700	8.08
B71930C.T.P4S.	150	210	28	2.00	1.00	38	122.00	143.00	5600	8500	2.54
B71930E.T.P4S.		210	28	2.00	1.00	56	114.00	134.00	5000	7500	2.54
B7030C.T.P4S.		225	35	2.10	2.10	43	183.00	193.00	5300	8000	4.13
B7030E.T.P4S.		225	35	2.10	2.10	61	173.00	186.00	4800	7000	4.13
B7230C.T.P4S.		270	45	3.00	3.00	51	228.00	255.00	4500	6700	10.30
B7230E.T.P4S.		270	45	3.00	3.00	71	216.00	240.00	4000	6000	10.30
B71932C.T.P4S.	160	220	28	2.00	1.00	39	125.00	150.00	5000	7500	2.68
B71932E.T.P4S.		220	28	2.00	1.00	58	116.00	140.00	4800	7000	2.68
B7032C.T.P4S.		240	38	2.10	2.10	46	190.00	208.00	4800	7000	5.10
B7032E.T.P4S.		240	38	2.10	2.10	66	176.00	196.00	4300	6300	5.10
B7232C.T.P4S.		290	48	3.00	3.00	54	245.00	285.00	4300	6300	13.05
B7232E.T.P4S.		290	48	3.00	3.00	76	232.00	270.00	3800	5600	13.05
B71934C.T.P4S.	170	230	28	2.00	1.50	41	129.00	163.00	4800	7000	2.83
B71934E.T.P4S.		230	28	2.00	1.50	61	122.00	150.00	4300	6300	2.83
B7034C.T.P4S.		260	42	2.10	2.10	50	236.00	270.00	4500	6700	6.73
B7034E.T.P4S.		260	42	2.10	2.10	71	224.00	255.00	4000	6000	6.73
B7234C.T.P4S.		310	52	4.00	4.00	58	300.00	360.00	3800	5600	16.03
B7234E.T.P4S.		310	52	4.00	4.00	82	280.00	345.00	3600	5300	16.03

Spindle Bearings

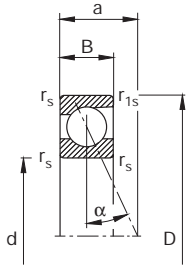

B719C., B70C., B72C.

Contact angle $\alpha = 15^\circ$

B719E., B70E., B72E.

Contact angle $\alpha = 25^\circ$

Bearing Number	Dimensions						Load Rating		Attainable Speed		Weight ≈ kg
	d	D	B	r _{smin}	r _{1smin}	a ≈	dyn. C	stat. C ₀	Grease rpm	Oil minimal	
FAG	mm						kN		rpm		
B71936C.T.P4S.	180	250	33	2.00	1.00	45	163.00	204.00	4500	6700	4.19
B71936E.T.P4S.		250	33	2.00	1.00	67	156.00	193.00	4000	6000	4.19
B7036C.T.P4S.		280	46	2.10	2.10	54	245.00	285.00	4000	6000	8.92
B7036E.T.P4S.		280	46	2.10	2.10	77	232.00	275.00	3800	5600	8.92
B7236C.T.P4S.		320	52	4.00	4.00	59	305.00	390.00	3800	5600	16.76
B7236E.T.P4S.		320	52	4.00	4.00	84	290.00	365.00	3400	5000	16.76
B71938C.T.P4S.	190	260	33	2.00	1.00	47	166.00	212.00	4300	6300	4.37
B71938E.T.P4S.		260	33	2.00	1.00	69	156.00	200.00	3800	5600	4.37
B7038C.T.P4S.		290	46	2.10	2.10	55	250.00	305.00	3800	5600	9.33
B7038E.T.P4S.		290	46	2.10	2.10	79	236.00	290.00	3600	5300	9.33
B7238C.T.P4S.		340	55	4.00	4.00	63	315.00	415.00	3400	5000	20.32
B7238E.T.P4S.		340	55	4.00	4.00	89	300.00	390.00	3200	4800	20.32
B71940C.T.P4S.	200	280	38	2.10	1.10	51	204.00	255.00	3800	5600	6.11
B71940E.T.P4S.		280	38	2.10	1.10	75	193.00	240.00	3600	5300	6.11
B7040C.T.P4S.		310	51	2.10	2.10	60	305.00	390.00	3600	5300	11.96
B7040E.T.P4S.		310	51	2.10	2.10	85	290.00	365.00	3200	4800	11.96
B7240C.T.P4S.		360	58	4.00	4.00	67	325.00	440.00	3200	4800	24.38
B7240E.T.P4S.		360	58	4.00	4.00	94	310.00	415.00	3000	4500	24.38
B71944C.T.P4S.	220	300	38	2.10	1.10	54	216.00	285.00	3600	5300	6.68
B71944E.T.P4S.		300	38	2.10	1.10	80	204.00	270.00	3200	4800	6.68
B7044C.T.P4S.		340	56	3.00	3.00	66	325.00	440.00	3200	4800	15.96
B7044E.T.P4S.		340	56	3.00	3.00	93	310.00	415.00	3000	4500	15.96
B7244C.T.P4S.		400	65	4.00	4.00	74	400.00	560.00	2800	4300	33.64
B7244E.T.P4S.		400	65	4.00	4.00	105	380.00	540.00	2600	4000	33.64
B71948C.T.P4S.	240	320	38	2.10	1.10	57	224.00	310.00	3200	4800	7.18
B71948E.T.P4S.		320	38	2.10	1.10	84	212.00	285.00	3000	4500	7.18
B7048C.T.P4S.		360	56	3.00	3.00	68	335.00	465.00	3000	4500	17.00
B7048E.T.P4S.		360	56	3.00	3.00	98	315.00	440.00	2800	4300	17.00

Spindle Bearings

HSS719C., HSS70C.
HS719C., HS70C.

Contact angle $\alpha = 15^\circ$

HSS719E., HSS70E.
HS719E., HS70E.

Contact angle $\alpha = 25^\circ$

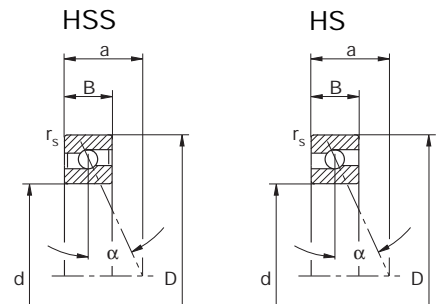

Performance data of unsealed spindle bearings, HS, is the same as for the sealed version, HSS.

Bearing Number	Dimensions					Load Rating		Attainable Speed		Weight ≈ kg
	d	D	B	r _{smin}	a ≈	dyn. C	stat. C ₀	Grease rpm	HS Oil minimal	
FAG	mm					kN		rpm		
HSS71900C.T.P4S.	10	22	6	0.30	5	1.96	1.10	90000	150000	0.01
HSS71900E.T.P4S.		22	6	0.30	7	1.86	1.04	75000	120000	0.01
HSS7000C.T.P4S.		26	8	0.30	6	2.75	1.60	80000	130000	0.02
HSS7000E.T.P4S.		26	8	0.30	8	2.60	1.50	67000	100000	0.02
HSS71901C.T.P4S.	12	24	6	0.30	5	2.04	1.20	80000	130000	0.01
HSS71901E.T.P4S.		24	6	0.30	7	1.93	1.14	67000	100000	0.01
HSS7001C.T.P4S.		28	8	0.30	7	2.70	1.63	70000	110000	0.02
HSS7001E.T.P4S.		28	8	0.30	9	2.55	1.53	60000	90000	0.02
HSS71902C.T.P4S.	15	28	7	0.30	6	2.80	1.76	67000	100000	0.02
HSS71902E.T.P4S.		28	7	0.30	9	2.65	1.66	56000	85000	0.02
HSS7002C.T.P4S.		32	9	0.30	8	3.75	2.45	60000	90000	0.03
HSS7002E.T.P4S.		32	9	0.30	10	3.55	2.32	50000	75000	0.03
HSS71903C.T.P4S.	17	30	7	0.30	7	2.90	1.90	60000	90000	0.02
HSS71903E.T.P4S.		30	7	0.30	9	2.70	1.80	50000	75000	0.02
HSS7003C.T.P4S.		35	10	0.30	8	3.80	2.65	53000	80000	0.04
HSS7003E.T.P4S.		35	10	0.30	11	3.65	2.50	45000	67000	0.04
HSS71904C.T.P4S.	20	37	9	0.30	8	3.90	2.85	50000	75000	0.04
HSS71904E.T.P4S.		37	9	0.30	11	3.75	2.70	43000	63000	0.04
HSS7004C.T.P4S.		42	12	0.60	10	6.20	4.55	45000	67000	0.08
HSS7004E.T.P4S.		42	12	0.60	13	5.85	4.30	38000	56000	0.08
HSS71905C.T.P4S.	25	42	9	0.30	9	4.25	3.35	43000	63000	0.05
HSS71905E.T.P4S.		42	9	0.30	12	4.00	3.15	36000	53000	0.05
HSS7005C.T.P4S.		47	12	0.60	11	6.30	4.90	38000	56000	0.09
HSS7005E.T.P4S.		47	12	0.60	14	6.00	4.65	34000	50000	0.09
HSS71906C.T.P4S.	30	47	9	0.30	10	6.40	5.20	36000	53000	0.05
HSS71906E.T.P4S.		47	9	0.30	13	6.00	4.90	32000	48000	0.05
HSS7006C.T.P4S.		55	13	1.00	12	8.80	7.10	32000	48000	0.13
HSS7006E.T.P4S.		55	13	1.00	16	8.30	6.70	28000	43000	0.13
HSS71907C.T.P4S.	35	55	10	0.60	11	6.95	6.20	32000	48000	0.08
HSS71907E.T.P4S.		55	10	0.60	15	6.55	5.85	26000	40000	0.08
HSS7007C.T.P4S.		62	14	1.00	13	9.30	8.30	28000	43000	0.17
HSS7007E.T.P4S.		62	14	1.00	18	8.80	7.80	24000	38000	0.17
HSS71908C.T.P4S.	40	62	12	0.60	13	7.20	6.95	28000	43000	0.13
HSS71908E.T.P4S.		62	12	0.60	18	6.80	6.40	24000	38000	0.13
HSS7008C.T.P4S.		68	15	1.00	15	10.00	9.30	26000	40000	0.22
HSS7008E.T.P4S.		68	15	1.00	20	9.30	8.65	22000	36000	0.22
HSS71909C.T.P4S.	45	68	12	0.60	14	10.00	9.65	24000	38000	0.14
HSS71909E.T.P4S.		68	12	0.60	19	9.50	9.00	22000	36000	0.14
HSS7009C.T.P4S.		75	16	1.00	16	12.90	12.20	24000	38000	0.27
HSS7009E.T.P4S.		75	16	1.00	22	12.20	11.40	20000	34000	0.27
HSS71910C.T.P4S.	50	72	12	0.60	14	10.40	10.20	22000	36000	0.15
HSS71910E.T.P4S.		72	12	0.60	20	9.80	9.65	20000	34000	0.15
HSS7010C.T.P4S.		80	16	1.00	17	13.40	13.20	22000	36000	0.29
HSS7010E.T.P4S.		80	16	1.00	23	12.50	12.20	18000	30000	0.29

Spindle Bearings

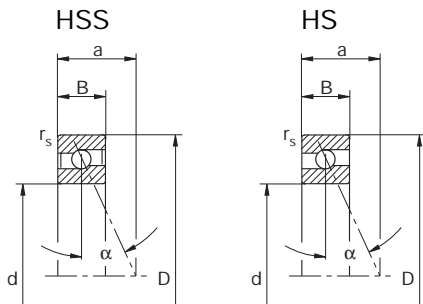

HSS719C., HSS70C.
HS719C., HS70C.

Contact angle $\alpha = 15^\circ$

HSS719E., HSS70E.
HS719E., HS70E.

Contact angle $\alpha = 25^\circ$

Performance data of unsealed spindle bearings, HS, is the same as for the sealed version, HSS.

Bearing Number	Dimensions					Load Rating		Attainable Speed		Weight ≈ kg
	d	D	B	r_{smin}	a ≈	dyn. C	stat. C ₀	Grease rpm	HS Oil minimal	
FAG	mm					kN		rpm		
HSS71911C.T.P4S.	55	80	13	1.00	16	13.40	13.70	20000	34000	0.20
HSS71911E.T.P4S.		80	13	1.00	22	12.70	12.70	18000	30000	0.20
HSS7011C.T.P4S.		90	18	1.10	19	18.60	19.00	19000	32000	0.43
HSS7011E.T.P4S.		90	18	1.10	26	17.60	17.60	17000	28000	0.43
HSS71912C.T.P4S.	60	85	13	1.00	16	14.00	14.60	19000	32000	0.21
HSS71912E.T.P4S.		85	13	1.00	23	13.20	13.40	17000	28000	0.21
HSS7012C.T.P4S.		95	18	1.10	19	19.30	20.00	18000	30000	0.46
HSS7012E.T.P4S.		95	18	1.10	27	18.30	19.00	15000	24000	0.46
HSS71913C.T.P4S.	65	90	13	1.00	17	14.30	15.30	18000	30000	0.23
HSS71913E.T.P4S.		90	13	1.00	25	13.40	14.30	15000	24000	0.23
HSS7013C.T.P4S.		100	18	1.10	20	20.00	21.60	17000	28000	0.48
HSS7013E.T.P4S.		100	18	1.10	28	19.00	20.00	15000	24000	0.48
HSS71914C.T.P4S.	70	100	16	1.00	19	18.30	20.00	16000	26000	0.37
HSS71914E.T.P4S.		100	16	1.00	28	17.30	18.60	14000	22000	0.37
HSS7014C.T.P4S.		110	20	1.10	22	26.00	28.00	16000	26000	0.67
HSS7014E.T.P4S.		110	20	1.10	31	24.50	26.00	13000	20000	0.67
HSS71915C.T.P4S.	75	105	16	1.00	20	19.00	21.20	16000	26000	0.40
HSS71915E.T.P4S.		105	16	1.00	29	17.60	20.00	13000	20000	0.40
HSS7015C.T.P4S.		115	20	1.10	23	26.50	29.00	15000	24000	0.71
HSS7015E.T.P4S.		115	20	1.10	32	25.00	27.00	13000	20000	0.71
HSS71916C.T.P4S.	80	110	16	1.00	21	21.20	24.00	15000	24000	0.41
HSS71916E.T.P4S.		110	16	1.00	30	19.60	22.40	13000	20000	0.41
HSS7016C.T.P4S.		125	22	1.10	25	31.50	34.50	14000	22000	0.96
HSS7016E.T.P4S.		125	22	1.10	35	30.00	32.50	12000	19000	0.96
HSS71917C.T.P4S.	85	120	18	1.10	23	22.00	26.00	14000	22000	0.61
HSS71917E.T.P4S.		120	18	1.10	33	20.40	24.50	12000	19000	0.61
HSS7017C.T.P4S.		130	22	1.10	25	32.00	36.00	13000	20000	0.99
HSS7017E.T.P4S.		130	22	1.10	36	30.00	33.50	11000	18000	0.99
HSS71918C.T.P4S.	90	125	18	1.10	23	23.60	28.50	13000	20000	0.63
HSS71918E.T.P4S.		125	18	1.10	34	22.40	26.50	11000	18000	0.63
HSS7018C.T.P4S.		140	24	1.50	27	37.50	43.00	12000	19000	1.31
HSS7018E.T.P4S.		140	24	1.50	39	35.50	40.00	10000	17000	1.31
HSS71919C.T.P4S.	95	130	18	1.10	24	24.50	30.00	12000	19000	0.66
HSS71919E.T.P4S.		130	18	1.10	35	22.80	28.00	10000	17000	0.66
HSS7019C.T.P4S.		145	24	1.50	28	38.00	44.00	11000	18000	1.34
HSS7019E.T.P4S.		145	24	1.50	40	35.50	41.50	9500	16000	1.34
HSS71920C.T.P4S.	100	140	20	1.10	26	29.00	36.00	11000	18000	0.90
HSS71920E.T.P4S.		140	20	1.10	38	27.50	33.50	9500	16000	0.90
HSS7020C.T.P4S.		150	24	1.50	29	38.00	45.50	11000	18000	1.40
HSS7020E.T.P4S.		150	24	1.50	41	36.00	42.50	9000	15000	1.40
HSS71921C.T.P4S.	105	145	20	1.10	27	30.00	38.00	11000	18000	0.94
HSS71921E.T.P4S.		145	20	1.10	39	28.00	35.50	9000	15000	0.94
HSS7021C.T.P4S.		160	26	2.00	31	49.00	58.50	10000	17000	1.75
HSS7021E.T.P4S.		160	26	2.00	44	46.50	54.00	8500	14000	1.75

Spindle Bearings

HSS719C., HSS70C.
HS719C., HS70C.

Contact angle $\alpha = 15^\circ$

HSS719E., HSS70E.
HS719E., HS70E.

Contact angle $\alpha = 25^\circ$

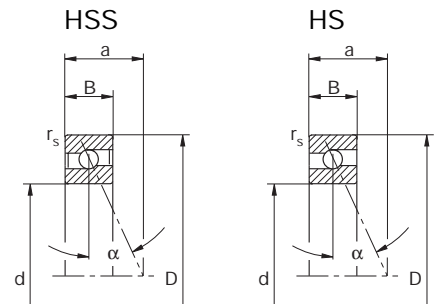

Performance data of unsealed spindle bearings, HS, is the same as for the sealed version, HSS.

Bearing Number	Dimensions					Load Rating		Attainable Speed		Weight ≈ kg
	d	D	B	r_{smin}	a ≈	dyn. C	stat. C_0	Grease rpm	HS Oil minimal	
FAG	mm					kN		rpm		
HSS71922C.T.P4S.	110	150	20	1.10	27	34.50	44.00	10000	17000	0.95
HSS71922E.T.P4S.		150	20	1.10	40	32.50	40.50	8500	14000	0.95
HSS7022C.T.P4S.		170	28	2.00	33	50.00	60.00	9500	16000	2.23
HSS7022E.T.P4S.		170	28	2.00	47	46.50	56.00	8000	13000	2.23
HSS71924C.T.P4S.	120	165	22	1.10	30	36.50	48.00	9000	15000	1.34
HSS71924E.T.P4S.		165	22	1.10	44	34.00	45.00	8000	13000	1.34
HSS7024C.T.P4S.		180	28	2.00	34	51.00	63.00	8500	14000	2.33
HSS7024E.T.P4S.		180	28	2.00	49	48.00	58.50	7500	12000	2.33
HSS71926C.T.P4S.	130	180	24	1.50	33	41.50	56.00	8500	14000	1.77
HSS71926E.T.P4S.		180	24	1.50	48	39.00	52.00	7000	11000	1.77
HSS7026C.T.P4S.		200	33	2.00	39	65.50	83.00	7500	12000	3.67
HSS7026E.T.P4S.		200	33	2.00	55	62.00	78.00	6700	10000	3.67

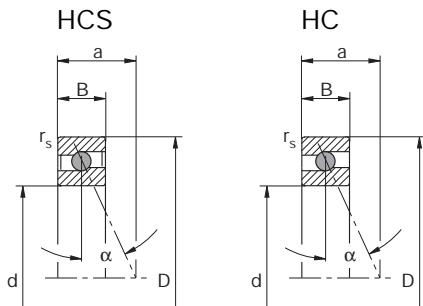

Spindle Bearings

Hybrid - Ceramic Balls

HCS719C., HCS70C.
HC719C., HC70C.

Contact angle $\alpha = 15^\circ$

HCS719E., HCS70E.
HC719E., HC70E.

Contact angle $\alpha = 25^\circ$

Performance data of unsealed spindle bearings, HC, is the same as for the sealed version, HCS.

Bearing Number	Dimensions					Load Rating		Attainable Speed	Weight	
	d	D	B	r_{smin}	a	dyn. C	stat. C ₀	Grease	HC Oil minimal	≈ kg
FAG	mm					kN		rpm		
HCS71900C.T.P4S.	10	22	6	0.30	5	1.37	0.77	100000	170000	0.01
HCS71900E.T.P4S.		22	6	0.30	7	1.29	0.72	85000	140000	0.01
HCS7000C.T.P4S.		26	8	0.30	6	1.90	1.10	90000	150000	0.02
HCS7000E.T.P4S.		26	8	0.30	8	1.80	1.06	75000	120000	0.02
HCS71901C.T.P4S.	12	24	6	0.30	5	1.40	0.83	90000	150000	0.01
HCS71901E.T.P4S.		24	6	0.30	7	1.34	0.80	80000	130000	0.01
HCS7001C.T.P4S.		28	8	0.30	7	1.86	1.12	80000	130000	0.02
HCS7001E.T.P4S.		28	8	0.30	9	1.76	1.08	70000	110000	0.02
HCS71902C.T.P4S.	15	28	7	0.30	6	1.93	1.22	75000	120000	0.02
HCS71902E.T.P4S.		28	7	0.30	9	1.83	1.16	63000	96000	0.02
HCS7002C.T.P4S.		32	9	0.30	8	2.60	1.70	70000	110000	0.03
HCS7002E.T.P4S.		32	9	0.30	10	2.45	1.60	60000	90000	0.03
HCS71903C.T.P4S.	17	30	7	0.30	7	2.00	1.34	70000	110000	0.02
HCS71903E.T.P4S.		30	7	0.30	9	1.90	1.27	60000	90000	0.02
HCS7003C.T.P4S.		35	10	0.30	8	2.65	1.83	63000	95000	0.04
HCS7003E.T.P4S.		35	10	0.30	11	2.50	1.73	53000	80000	0.04
HCS71904C.T.P4S.	20	37	9	0.30	8	2.70	1.96	56000	85000	0.04
HCS71904E.T.P4S.		37	9	0.30	11	2.55	1.86	48000	70000	0.04
HCS7004C.T.P4S.		42	12	0.60	10	4.30	3.20	53000	80000	0.08
HCS7004E.T.P4S.		42	12	0.60	13	4.05	3.00	45000	67000	0.08
HCS71905C.T.P4S.	25	42	9	0.30	9	2.90	2.36	48000	70000	0.05
HCS71905E.T.P4S.		42	9	0.30	12	2.75	2.20	40000	60000	0.05
HCS7005C.T.P4S.		47	12	0.60	11	4.30	3.45	45000	67000	0.09
HCS7005E.T.P4S.		47	12	0.60	14	4.05	3.25	38000	56000	0.09
HCS71906C.T.P4S.	30	47	9	0.30	10	4.40	3.65	43000	63000	0.05
HCS71906E.T.P4S.		47	9	0.30	13	4.15	3.45	36000	53000	0.05
HCS7006C.T.P4S.		55	13	1.00	12	6.00	4.90	38000	56000	0.12
HCS7006E.T.P4S.		55	13	1.00	16	5.70	4.65	32000	48000	0.12
HCS71907C.T.P4S.	35	55	10	0.60	11	4.80	4.40	36000	53000	0.08
HCS71907E.T.P4S.		55	10	0.60	15	4.50	4.05	30000	45000	0.08
HCS7007C.T.P4S.		62	14	1.00	13	6.40	5.85	34000	50000	0.17
HCS7007E.T.P4S.		62	14	1.00	18	6.10	5.40	28000	43000	0.17
HCS71908C.T.P4S.	40	62	12	0.60	13	5.00	4.80	32000	48000	0.12
HCS71908E.T.P4S.		62	12	0.60	18	4.75	4.50	28000	43000	0.12
HCS7008C.T.P4S.		68	15	1.00	15	6.80	6.55	30000	45000	0.2
HCS7008E.T.P4S.		68	15	1.00	20	6.40	6.10	26000	40000	0.2
HCS71909C.T.P4S.	45	68	12	0.60	14	6.95	6.70	28000	43000	0.13
HCS71909E.T.P4S.		68	12	0.60	19	6.55	6.30	24000	38000	0.13
HCS7009C.T.P4S.		75	16	1.00	16	8.80	8.50	26000	40000	0.26
HCS7009E.T.P4S.		75	16	1.00	22	8.30	8.00	24000	38000	0.26
HCS71910C.T.P4S.	50	72	12	0.60	14	7.10	7.20	26000	40000	0.14
HCS71910E.T.P4S.		72	12	0.60	20	6.70	6.70	22000	36000	0.14
HCS7010C.T.P4S.		80	16	1.00	17	9.15	9.15	24000	38000	0.27
HCS7010E.T.P4S.		80	16	1.00	23	8.65	8.50	22000	36000	0.27

Spindle Bearings

Hybrid - Ceramic Balls

HCS719C., HCS70C.
 HC719C., HC70C.

Contact angle $\alpha = 15^\circ$

HCS719E., HCS70E.
 HC719E., HC70E.

Contact angle $\alpha = 25^\circ$

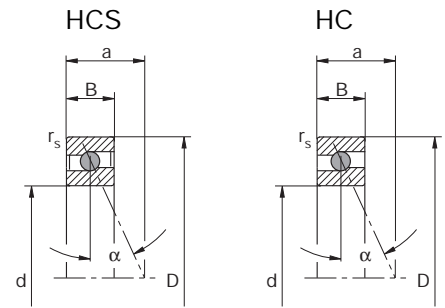

Performance data of unsealed spindle bearings, HC, is the same as for the sealed version, HCS.

Bearing Number	Dimensions					Load Rating		Attainable Speed	HC Oil minimal	Weight \approx kg
	d	D	B	r_{smin}	a \approx	dyn. C	stat. C_0	Grease rpm		
FAG	mm					kN		rpm		
HCS71911C.T.P4S.	55	80	13	1.00	16	9.30	9.50	24000	38000	0.19
HCS71911E.T.P4S.		80	13	1.00	22	8.80	8.80	20000	34000	0.19
HCS7011C.T.P4S.		90	18	1.10	19	12.90	13.20	22000	36000	0.4
HCS7011E.T.P4S.		90	18	1.10	26	12.20	12.20	19000	32000	0.4
HCS71912C.T.P4S.	60	85	13	1.00	16	9.65	10.00	22000	36000	0.19
HCS71912E.T.P4S.		85	13	1.00	23	9.00	9.50	19000	32000	0.19
HCS7012C.T.P4S.		95	18	1.10	19	13.40	14.00	20000	34000	0.43
HCS7012E.T.P4S.		95	18	1.10	27	12.70	13.20	18000	30000	0.43
HCS71913C.T.P4S.	65	90	13	1.00	17	9.80	10.80	20000	34000	0.21
HCS71913E.T.P4S.		90	13	1.00	25	9.30	10.00	18000	30000	0.21
HCS7013C.T.P4S.		100	18	1.10	20	13.70	15.00	20000	34000	0.45
HCS7013E.T.P4S.		100	18	1.10	28	12.90	14.00	17000	28000	0.45
HCS71914C.T.P4S.	70	100	16	1.00	19	12.70	14.00	19000	32000	0.35
HCS71914E.T.P4S.		100	16	1.00	28	12.00	13.20	16000	26000	0.35
HCS7014C.T.P4S.		110	20	1.10	22	18.00	19.60	18000	30000	0.63
HCS7014E.T.P4S.		110	20	1.10	31	17.00	18.30	15000	24000	0.63
HCS71915C.T.P4S.	75	105	16	1.00	20	12.90	15.00	18000	30000	0.37
HCS71915E.T.P4S.		105	16	1.00	29	12.20	13.70	15000	24000	0.37
HCS7015C.T.P4S.		115	20	1.10	23	18.30	20.00	17000	28000	0.66
HCS7015E.T.P4S.		115	20	1.10	32	17.30	18.60	15000	24000	0.66
HCS71916C.T.P4S.	80	110	16	1.00	21	14.60	16.60	17000	28000	0.38
HCS71916E.T.P4S.		110	16	1.00	30	13.70	15.60	15000	24000	0.38
HCS7016C.T.P4S.		125	22	1.10	25	21.60	24.50	16000	26000	0.89
HCS7016E.T.P4S.		125	22	1.10	35	20.40	22.80	13000	20000	0.89
HCS71917C.T.P4S.	85	120	18	1.10	23	15.00	18.00	16000	26000	0.57
HCS71917E.T.P4S.		120	18	1.10	33	14.30	17.00	13000	20000	0.57
HCS7017C.T.P4S.		130	22	1.10	25	22.00	25.00	15000	24000	0.92
HCS7017E.T.P4S.		130	22	1.10	36	20.80	23.20	13000	20000	0.93
HCS71918C.T.P4S.	90	125	18	1.10	23	16.30	19.60	15000	24000	0.58
HCS71918E.T.P4S.		125	18	1.10	34	15.60	18.60	13000	20000	0.58
HCS7018C.T.P4S.		140	24	1.50	27	26.00	30.00	14000	22000	1.22
HCS7018E.T.P4S.		140	24	1.50	39	24.50	28.00	12000	19000	1.22
HCS71919C.T.P4S.	95	130	18	1.10	24	17.00	20.80	14000	22000	0.61
HCS71919E.T.P4S.		130	18	1.10	35	16.00	19.30	12000	19000	0.61
HCS7019C.T.P4S.		145	24	1.50	28	26.00	31.00	13000	20000	1.24
HCS7019E.T.P4S.		145	24	1.50	40	24.50	28.50	11000	18000	1.25
HCS71920C.T.P4S.	100	140	20	1.10	26	20.40	25.00	13000	20000	0.84
HCS71920E.T.P4S.		140	20	1.10	38	19.00	23.60	11000	18000	0.84
HCS7020C.T.P4S.		150	24	1.50	29	26.50	31.50	12000	19000	1.29
HCS7020E.T.P4S.		150	24	1.50	41	25.00	30.00	11000	18000	1.29
HCS71921C.T.P4S.	105	145	20	1.10	27	20.80	26.50	12000	19000	0.87
HCS71921E.T.P4S.		145	20	1.10	39	19.60	24.50	11000	18000	0.87
HCS7021C.T.P4S.		160	26	2.00	31	34.00	40.50	12000	19000	1.61
HCS7021E.T.P4S.		160	26	2.00	44	32.00	38.00	10000	17000	1.62

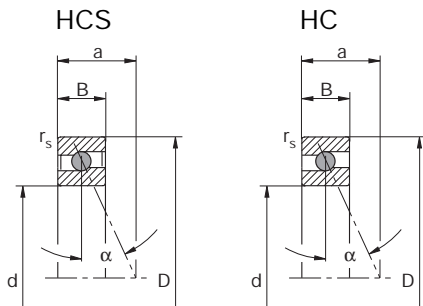

Spindle Bearings

Hybrid - Ceramic Balls

HCS719C., HCS70C.
HC719C., HC70C.

Contact angle $\alpha = 15^\circ$

HCS719E., HCS70E.
HC719E., HC70E.

Contact angle $\alpha = 25^\circ$

Performance data of unsealed spindle bearings, HC, is the same as for the sealed version, HCS.

Bearing Number	Dimensions					Load Rating		Attainable Speed		Weight ≈ kg
	d	D	B	r_{smin}	a ≈	dyn. C	stat. C ₀	Grease rpm	HC Oil minimal	
FAG	mm					kN		rpm		
HCS71922C.T.P4S.	110	150	20	1.10	27	24.00	30.50	12000	19000	0.87
HCS71922E.T.P4S.		150	20	1.10	40	22.80	28.50	10000	17000	0.87
HCS7022C.T.P4S.		170	28	2.00	33	34.50	41.50	11000	18000	2.08
HCS7022E.T.P4S.		170	28	2.00	47	32.50	39.00	9000	15000	2.08
HCS71924C.T.P4S.	120	165	22	1.10	30	25.00	33.50	11000	18000	1.25
HCS71924E.T.P4S.		165	22	1.10	44	23.60	31.00	9000	15000	1.25
HCS7024C.T.P4S.		180	28	2.00	34	35.50	44.00	10000	17000	2.13
HCS7024E.T.P4S.		180	28	2.00	49	33.50	41.50	8500	14000	2.13
HCS71926C.T.P4S.	130	180	24	1.50	33	29.00	39.00	9500	16000	1.65
HCS71926E.T.P4S.		180	24	1.50	48	27.00	36.50	8000	13000	1.65
HCS7026C.T.P4S.		200	33	2.00	39	45.50	58.50	9000	15000	3.45
HCS7026E.T.P4S.		200	33	2.00	55	42.50	54.00	7500	12000	3.45

Ball Screw Support Bearings

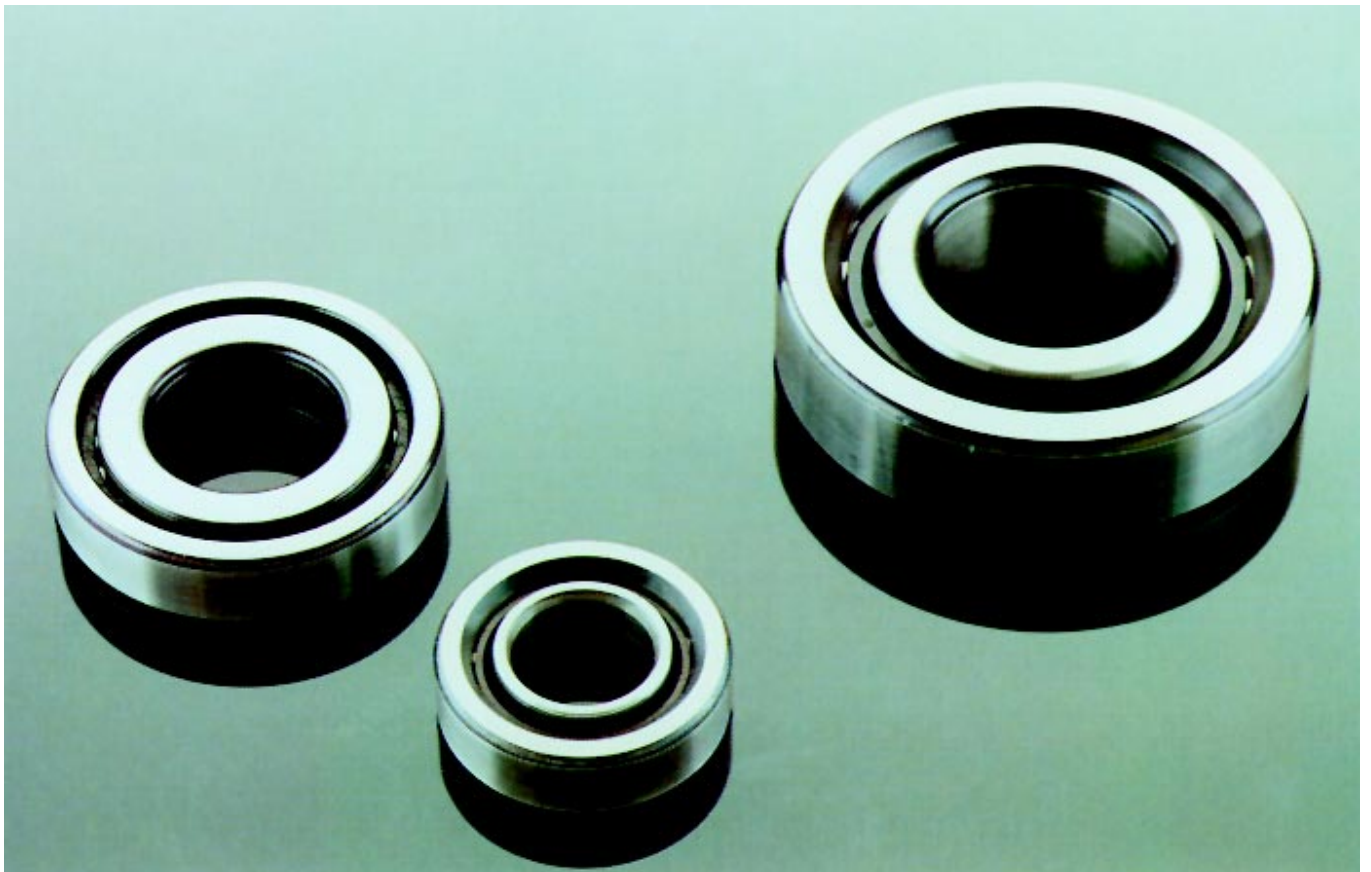

Ball Screw Support Bearings

FAG ball screw support bearings have been developed especially for ball screw spindle support. They fulfil the requirement for

- high accuracy
- greater rigidity
- low friction
- quick positional changes at high speed

FAG ball screw support bearings are manufactured in the 02 (7602), 03 (7603) size series and also the narrower BSB series.

FAG ball screw support bearings for ball screw spindle support are produced in ISO P4 quality.

The tolerance of the diameters is the same as those of the deep groove bearing,

the axial runout corresponds to the tolerance values of the thrust bearings.

In order that the ball screw drives achieve the desired high positional accuracy in machine tools the bearings require a high rigidity.

FAG ball screw support bearings for ball screw drives achieve their rigidity through their internal design and built-in universal preload.

The assembly of many bearings in an DF or DB arrangement increases the preload and stiffness of the bearing.

FAG ball screw support bearings for ball screw drives exhibit low friction. For this reason a lower driving power is required. Torque values are given in the bearing tables.

Lithium soap greases with EP additives, for example FAG bearing grease Arcanol L135V have proved themselves as lubricating greases.

The relevant selection data and calculation for single row ball screw support bearings, high precision series, can be found on pages :

- Life Calculations	Page 56-62
- Lubrication	Page 63-66
- Clamping Force	Page 67
- Tolerances	Page 68-69
- Manufacturing Tolerances for Mating Parts	Page 72-81
- Attainable speeds	Page 84
- Rigidity	Page 86-87

Ball Screw Support Bearings

7602035TVP

Series Type Number

7602 Dimensional series 02
7603 Dimensional series 03

Cage

TVP PA66-GF25

Bore

Actual size in mm

BSB030062T

Series Type Number

BSB Ball screw support bearing

Cage

T PA66-GF25

Bore Diameter

Actual size in mm

Outer Ring Diameter

Actual size in mm

Ball Screw Support Bearings

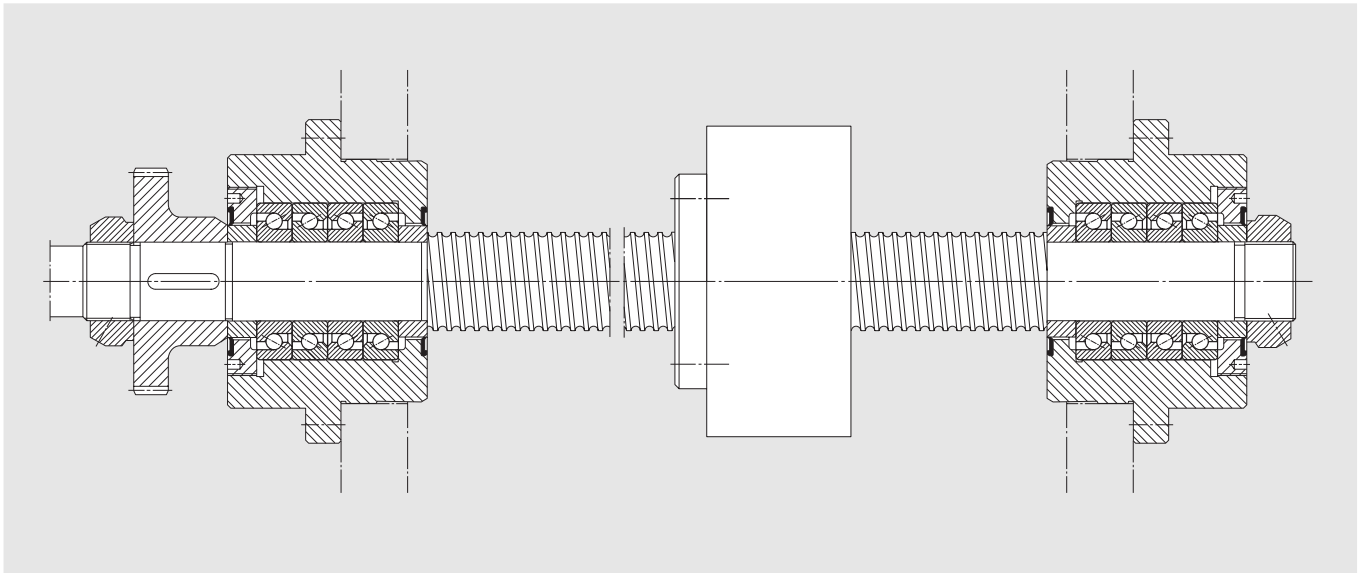

Ball Screw Spindle Support

Bearing Selection

The bearing must support the spindle accurately with great axial rigidity. For many years the FAG ball screw support bearings with 60 degree contact angle and precision class P4 have proven themselves for these requirements.

Each spindle end is supported by 4 bearings FAG 7602025TVP in a Tandem, back to back arrangement.

The spindle is fixed at both ends and is tensioned in its ambient state, so that the operating temperature doesn't cause any additional axial forces on the bearings through thermal expansion.

Bearing Dimensions

The size of the bearing is determined by the application loads and the spindle speed. In most cases ball screw drives are

driven without any lateral force, so that the axial force is the determining factor for the dimensioning of the bearing. Prerequisites for attaining durability are generally favourable operating conditions and high grade grease with EP additives. Individual applications can be confirmed by checking the hertzian contact stress calculating the extended working life. The number of bearings determines the axial rigidity.

Preload, Bearing Clearance

FAG ball screw support bearings from the 76020.., 76030.. and BSB series are available universally preloaded for installation in either DF, DB or Tandem arrangements. The installation in DF or DB arrangements results in a specific preload. The bearings have a preload which achieves the high rigidity required.

Lubrication, Sealing

In the bearing 35 % of the free space is filled with a high grade EP grease, FAG Arcanol L135V, for lifelong lubrication.

Experience has shown that this grease has an average working life of more than 5 years. Sealing achieved by either a labyrinth or NBR seal within the casing is recommended.

Ball Screw Support Bearings

7602, 7603, BSB

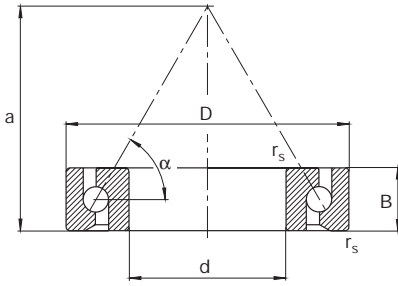
Contact angle $\alpha = 60^\circ$ 

Bearing Number	Dimensions					Load Rating		Max. Axial Load dyn.	Attainable Speed		Pre-load F_V	Friction Torque M_f	Weight \approx
	d	D	B	r_{smin}	$a \approx$	dyn. C	stat. C_0		Grease	Oil			
FAG	mm					kN			rpm		kN	Nmm	kg
7602012TVP	12	32	10	0.6	24	11.6	12.5	5.2	8000	11000	1.4	15	0.042
7602015TVP	15	35	11	0.6	27.5	12.5	15	6.3	6700	9000	1.3	20	0.052
7602017TVP	17	40	12	0.6	31	16.6	20	8.5	6000	8000	1.7	30	0.075
7602020TVP	20	47	14	1	36	19.3	25	10.6	5000	6700	2.3	50	0.13
BSB020047T		47	15	1	36.5	19.3	25	10.6	5000	6700	2.3	50	0.13
7603020TVP		52	15	1.1	39.5	24.5	32	14	4500	6000	2.9	60	0.175
7602025TVP	25	52	15	1	41	22	30.5	13.2	4500	6000	2.5	65	0.16
BSB025062T		62	15	1	46.5	28.5	41.5	18	3800	5000	3.3	85	0.24
7603025TVP		62	17	1.1	47.5	28.5	41.5	18	3800	5000	3.3	85	0.28
BSB030062T	30	62	15	1	47.5	26	39	17	3800	5000	2.9	85	0.225
7602030TVP		62	16	1	48	26	39	17	3800	5000	2.9	85	0.24
7603030TVP		72	19	1.1	55.5	34.5	55	23.6	3200	4300	4.3	130	0.415
BSB035072T	35	72	15	1	54	30	50	21.2	3200	4300	3.3	115	0.3
7602035TVP		72	17	1.1	55	30	50	21.2	3200	4300	3.3	115	0.345
7603035TVP		80	21	1.5	61.5	36.5	61	26.5	3000	4000	4.8	170	0.555
BSB040072T	40	72	15	1	56	28	49	21.2	3000	4000	2.9	115	0.26
7602040TVP		80	18	1.1	62.5	37.5	64	28	2800	3800	4.3	170	0.445
BSB040090T		90	20	1.5	67	50	83	35.5	2600	3600	5.6	225	0.65
7603040TVP		90	23	1.5	68.5	50	83	35.5	2600	3600	5.6	225	0.765
BSB045075T	45	75	15	1	59.5	28.5	52	22.4	2800	3800	3.1	130	0.26
7602045TVP		85	19	1.1	66	38	68	28	2600	3600	4.5	190	0.505
BSB045100T		100	20	1.5	75	58.5	104	45	2200	3200	6.9	300	0.81
7603045TVP		100	25	1.5	77.5	58.5	104	45	2200	3200	7	300	1.02
7602050TVP	50	90	20	1.1	71.5	39	75	31.5	2400	3400	4.9	230	0.575
BSB050100T		100	20	1.5	75	58.5	104	45	2200	3200	7.0	330	0.75
7603050TVP		110	27	2	85.5	69.5	127	53	2000	3000	7.6	360	1.33
BSB055090T	55	90	15	1	70.5	32.5	65.5	28	2400	3400	3.6	190	0.38
7602055TVP		100	21	1.5	77.5	40.5	81.5	33.5	2200	3200	4.6	250	0.75
BSB055120T		120	20	2	86	60	116	50	2000	3000	6.8	360	1.18
7603055TVP		120	29	2	91.5	78	146	63	1900	2800	8.8	460	1.69
7602060TVP	60	110	22	1.5	86	56	112	47.5	2000	3000	6.5	350	0.96
BSB060120T		120	20	1.5	88	61	120	53	1900	2800	7	380	1.11
7603060TVP		130	31	2.1	98	88	166	75	1800	2600	10	540	2.12
7602065TVP	65	120	23	1.5	92.5	57	122	50	1800	2600	7	410	1.2
7603065TVP		140	33	2.1	107.5	100	196	90	1600	2200	12	700	2.6
7602070TVP	70	125	24	1.5	96.5	65.5	137	56	1800	2600	7	440	1.32
7603070TVP		150	35	2.1	113	110	220	95	1600	2200	12	760	3.16
BSB075110T	75	110	15	1.5	87.5	35.5	83	33.5	1900	2800	4.5	290	0.47
7602075TVP		130	25	1.5	102.5	67	150	63	1600	2200	7.6	480	1.45
7603075TVP		160	37	2.1	123	125	255	255	1400	1900	14.5	920	3.79
7602080TVP	80	140	26	2	109	76.5	175	75	1500	2000	8.9	600	1.76
7603080TVP		170	39	2.1	129.5	137	285	132	1400	19000	16	1100	4.5

Ball Screw Support Bearings

7602, 7603, BSB

Contact angle $\alpha = 60^\circ$

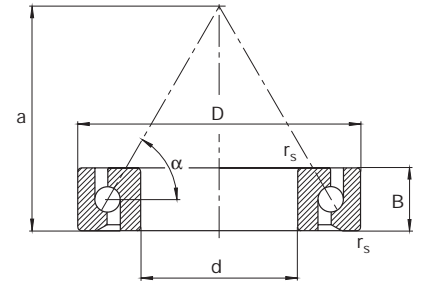

Bearing Number	Dimensions					Load Rating		Max. Axial Load dyn.	Attainable Speed		Pre-load F_V	Friction Torque M_f	Weight \approx
	d	D	B	r_{smin}	a \approx	dyn. C	stat. C_0		Grease	Oil			
FAG	mm					kN			rpm		kN	Nmm	kg
7602085TVP	85	150	28	2	117	86.5	196	85	1400	1900	10.5	760	2.19
7603085TVP		180	41	3	136	160	325	150	1300	1800	17.5	1250	5.29
7602090TVP	90	160	30	2	124	98	224	100	1400	1900	11	790	2.69
7603090TVP		190	43	3	142.5	163	345	160	1200	1700	18	1300	6.17
7602095TVP	95	170	32	2.1	131	110	255	112	1300	1800	12.5	950	3.26
7603095TVP		200	45	3	150	163	360	170	1200	1700	19	1450	7.15
BSB100150T	100	150	22.5	2	119.5	69.5	173	71	1400	1900	7.5	600	1.37
7602100TVP		180	34	2.1	138	122	285	125	1200	1700	14	1100	3.91
7603100TVP		215	47	3	161	193	430	212	1100	1600	21.5	1700	8.73

Double Direction Angular Contact Thrust Ball Bearings



Double Direction Angular Contact Thrust Ball Bearings

Double direction angular contact thrust ball bearings were developed for machine tool spindles and are manufactured solely high precision. In the case of main spindles of machine tools these bearings carry the axial forces. They are matched with the mounting dimensions of the double row cylindrical roller bearing of the NN30 series, (page 48).

External Dimensions

Double direction angular contact thrust ball bearings are mounted next to a double row radial cylindrical roller bearing. The nominal size of the external diameter is the same for both bearings. This simplifies the machining of the

housing bore. The tolerance for the external diameter of the double direction angular contact thrust ball bearing is designed so that the bearings are clear in the housing bore.

Bearing Design

Double direction angular contact thrust ball bearings have a contact angle of 60° and are axially preloaded. They are therefore especially well suited for high speeds. The contact angle and the axial preload ensures good ball control, particularly under the centrifugal forces with fast rotating spindles.

They have solid one piece brass cages which are ball guided.

Speedability

FAG double direction angular contact thrust ball bearings are suitable for high speeds. Speed limit values for grease and oil lubrication are given in the bearing tables.

Lubrication

FAG double direction angular contact thrust ball bearings can be lubricated with grease or oil.

The outer ring O.D. has a lubricating groove in the centre with lubricating holes. The application of the lubricant between the two rows of balls maximises the distribution of lubricant to both raceways.

Double Direction Angular Contact Thrust Ball Bearings

234424M.SP

Series Type Number

- 2344 For assembly on the smaller side of the NN30 taper
- 2347 For assembly on the larger side of the NN30 taper

Bore Size Code

- 10 $10 \cdot 5 = 50$ mm
- 18 $18 \cdot 5 = 90$ mm

Precision

- SP Super precision
- UP Ultra precision

Cage

- M Brass cage

Double Direction Angular Contact Thrust Ball Bearings

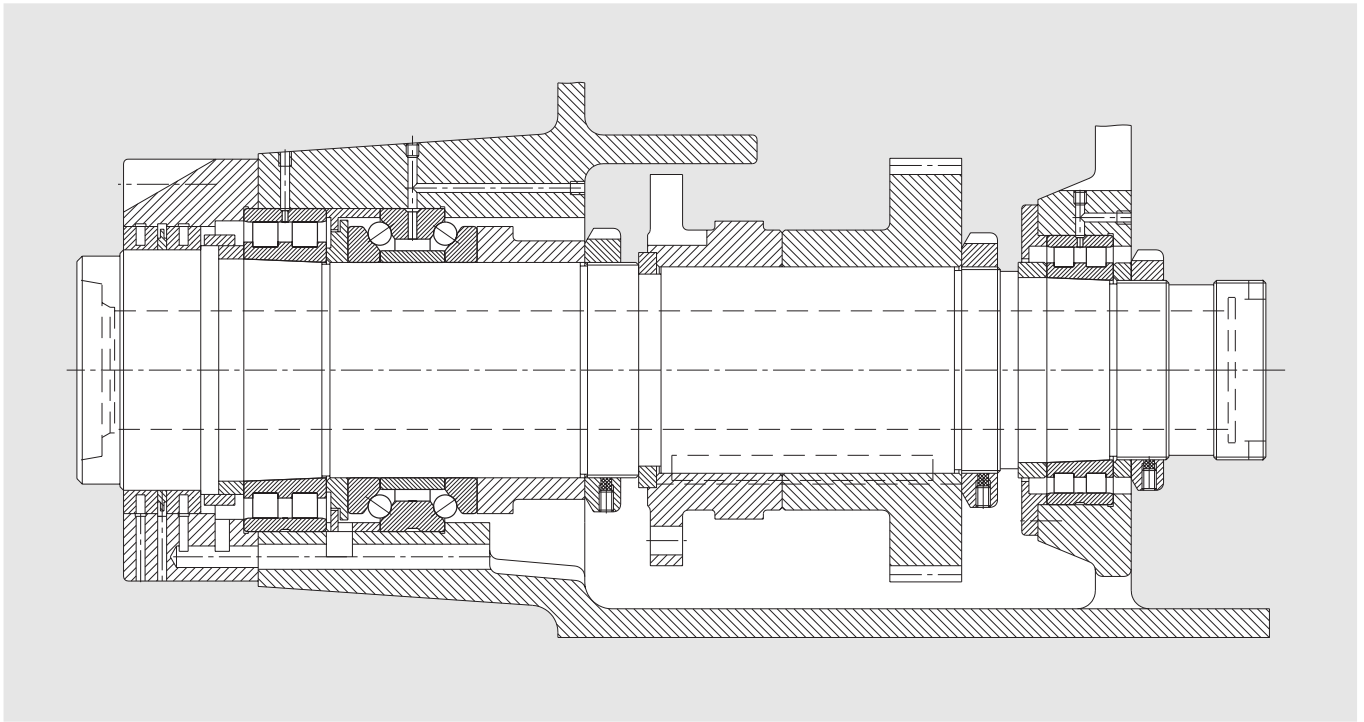

Drill and Milling Spindle

Rigidity

To attain good machining results the bearings for machine tool spindles must exhibit high rigidity as well as high precision; this means that they must run precisely and must allow only slight deflection under load. The double direction angular contact thrust ball bearings gain their rigidity through their internal design and preload.

The relevant selection data and calculation for double direction angular contact thrust ball bearings can be found on pages :

- Life Calculations	Page 56-62
- Lubrication	Page 63-66
- Tolerances	Page 68-69
- Manufacturing Tolerances for Mating Parts	Page 72-82
- Attainable speed	Page 84
- Rigidity	Page 88

Technical Details

Motor power: 20 kW
Rotational speed: 11 ... 2240 rpm

Bearing Selection

The radial and axial forces are supported separately. Double row cylindrical roller bearings are incorporated as radial bearings; on the drive side a FAG NN3024ASK.M.SP and a NN3020ASK.M.SP on the opposite side.

The double direction angular contact thrust ball bearings FAG 234424M.SP locates the spindle axially. This bearing has a set preload making adjustments unnecessary. Due to the external diameters of the radial and axial bearings having the same nominal size machining of the bore for the housing is simplified. The tolerance of the double direction angular

contact thrust ball bearings is such that there is a clearance fit in the housing.

Lubrication, Sealing

Oil re-circulation lubrication. The Labyrinth seal on the work side is made up of ready to assemble components. The inner labyrinth ring retains the lubricating oil, whilst the outer labyrinth ring excludes the cutting fluid.

Double Direction Angular Contact Thrust Ball Bearings

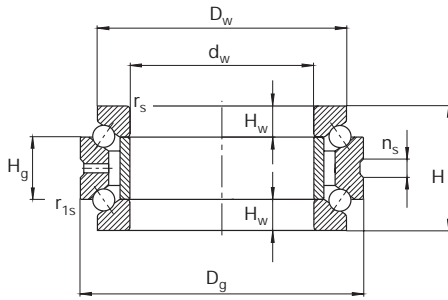

2344, 2347
Contact angle $\alpha = 60^\circ$

Bearing Number	Dimensions									Load Rating dyn. C	stat. C ₀	Attainable Speed		Weight ≈ kg
	d _w	D _g	D _w	H	H _g	H _w	r _{smin}	r _{1smin}	n _s			Grease	Oil	
FAG	mm									kN		rpm		
234406M.SP	30	55	47	32	16	8	1	0.15	4.8	14.3	24	11000	16000	0.293
234706M.SP	32	55	47	32	16	8	1	0.15	4.8	14.3	24	11000	16000	0.27
234407M.SP	35	62	53	34	17	8.5	1	0.15	4.8	17.6	31.5	9500	14000	0.38
234707M.SP	37	62	53	34	17	8.5	1	0.15	4.8	17.6	31.5	9500	14000	0.35
234408M.SP	40	68	58.5	36	18	9	1	0.15	4.8	20.8	38	8500	12000	0.463
234708M.SP	42	68	58.5	36	18	9	1	0.15	4.8	20.8	38	8500	12000	0.429
234409M.SP	45	75	65	38	19	9.5	1	0.15	4.8	23.2	45	7500	10000	0.579
234709M.SP	47	75	65	38	19	9.5	1	0.15	4.8	23.2	45	7500	10000	0.536
234410M.SP	50	80	70	38	19	9.5	1	0.15	4.8	24	49	7000	9500	0.629
234710M.SP	52	80	70	38	19	9.5	1	0.15	4.8	24	49	7000	9500	0.581
234411M.SP	55	90	78	44	22	11	1.1	0.3	6.5	34	67	6300	8500	0.944
234711M.SP	57	90	78	44	22	11	1.1	0.3	6.5	34	67	6300	8500	0.884
234412M.SP	60	95	83	44	22	11	1.1	0.3	6.5	33.5	68	6000	8000	1.01
234712M.SP	62	95	83	44	22	11	1.1	0.3	6.5	33.5	68	6000	8000	0.944
234413M.SP	65	100	88	44	22	11	1.1	0.3	6.5	36	76.5	5600	7500	1.08
234713M.SP	67	100	88	44	22	11	1.1	0.3	6.5	36	76.5	5600	7500	1.01
234414M.SP	70	110	97	48	24	12	1.1	0.3	6.5	42.5	93	5300	7000	1.49
234714M.SP	73	110	97	48	24	12	1.1	0.3	6.5	42.5	93	5300	7000	1.36
234415M.SP	75	115	102	48	24	12	1.1	0.3	6.5	44	100	5000	6700	1.57
234715M.SP	78	115	102	48	24	12	1.1	0.3	6.5	44	100	5000	6700	1.43
234416M.SP	80	125	110	54	27	13.5	1.1	0.3	6.5	52	120	4500	6000	2.16
234716M.SP	83	125	110	54	27	13.5	1.1	0.3	6.5	52	120	4500	6000	1.98
234417M.SP	85	130	115	54	27	13.5	1.1	0.3	9.5	52	125	4500	6000	2.25
234717M.SP	88	130	115	54	27	13.5	1.1	0.3	9.5	52	125	4500	6000	2.07
234418M.SP	90	140	123	60	30	15	1.5	0.3	9.5	61	146	4000	5300	2.92
234718M.SP	93	140	123	60	30	15	1.5	0.3	9.5	61	146	4000	5300	2.71
234419M.SP	95	145	128	60	30	15	1.5	0.3	9.5	61	150	4000	5300	3.04
234719M.SP	98	145	128	60	30	15	1.5	0.3	9.5	61	150	4000	5300	2.83
234420M.SP	100	150	133	60	30	15	1.5	0.3	9.5	62	156	3800	5000	3.17
234720M.SP	103	150	133	60	30	15	1.5	0.3	9.5	62	156	3800	5000	2.95
234421M.SP	105	160	142	66	33	16.5	2	0.6	9.5	69.5	176	3600	4800	4.07
234721M.SP	109	160	142	66	33	16.5	2	0.6	9.5	69.5	176	3600	4800	3.73
234422M.SP	110	170	150	72	36	18	2	0.6	9.5	90	224	3400	4500	5.19

Double Direction Angular Contact Thrust Ball Bearings

2344, 2347

Contact angle $\alpha = 60^\circ$

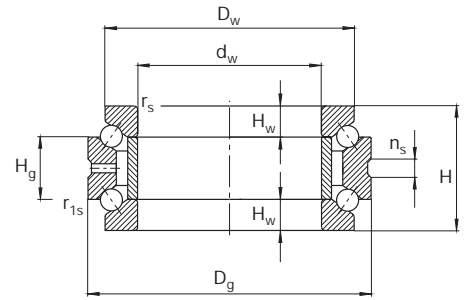

Bearing Number	Dimensions										Load Rating dyn. C	Attainable Speed		Weight ≈ kg
	d_w	D_g	D_w	H	H_g	H_w	r_{smin}	r_{1smin}	n_s	stat. C_0		Grease	Oil	
FAG	mm										kN	rpm		kg
234722M.SP	114	170	150	72	36	18	2	0.6	9.5	90	224	3400	4500	4.79
234424M.SP	120	180	160	72	36	18	2	0.6	9.5	93	240	3200	4300	5.56
234724M.SP	124	180	160	72	36	18	2	0.6	9.5	93	240	3200	4300	5.14
234426M.SP	130	200	177	84	42	21	2	0.6	12.2	118	300	2800	3800	8.28
234726M.SP	135	200	177	84	42	21	2	0.6	12.2	118	300	2800	3800	7.58
234428M.SP	140	210	187	84	42	21	2.1	0.6	12.2	122	320	2600	3600	8.78
234728M.SP	145	210	187	84	42	21	2.1	0.6	12.2	122	320	2600	3600	8.07
234430M.SP	150	225	200	90	45	22.5	2.1	0.6	15	132	355	2600	3600	10.8
234730M.SP	155	225	200	90	45	22.5	2.1	0.6	15	132	355	2600	3600	9.95
234432M.SP	160	240	212	96	48	24	2.1	0.6	15	156	415	2400	3400	12.9
234732M.SP	165	240	212	96	48	24	2.1	0.6	15	156	415	2400	3400	12
234434M.SP	170	260	230	108	54	27	2.1	0.6	15	193	520	2200	3200	17.7
234734M.SP	176	260	230	108	54	27	2.1	0.6	15	193	520	2200	3200	16.3
234436M.SP	180	280	248	120	60	30	2.1	0.6	15	216	585	2000	3000	23.4
234736M.SP	187	280	248	120	60	30	2.1	0.6	15	216	585	2000	3000	21.5
234438M.SP	190	290	258	120	60	30	2.1	0.6	15	224	630	1900	2800	24.7
234738M.SP	197	290	258	120	60	30	2.1	0.6	15	224	630	1900	2800	22.6
234440M.SP	200	310	274	132	66	33	2.1	0.6	15	265	720	1800	2600	31.5
234740M.SP	207	310	274	132	66	33	2.1	0.6	15	265	720	1800	2600	29.2
234444M.SP	220	340	304	144	72	36	3	1.1	15	315	900	1600	2200	41.7
234744M.SP	228	340	304	144	72	36	3	1.1	15	315	900	1600	2200	38.5
234448M.SP	240	360	322	144	72	36	3	1.1	15	325	965	1500	2000	43.8
234748M.SP	248	360	322	144	72	36	3	1.1	15	325	965	1500	2000	40.4
234452M.SP	260	400	354	164	82	41	4	1.5	17.7	380	1180	1400	1900	64.5
234752M.SP	269	400	354	164	82	41	4	1.5	17.7	380	1180	1400	1900	59.7
234456M.SP	280	420	374	164	82	41	4	1.5	17.7	390	1270	1300	1800	69
234756M.SP	289	420	374	164	82	41	4	1.5	17.7	390	1270	1300	1800	63.8
234460M.SP	300	460	406	190	95	47.5	4	1.5	17.7	450	1530	1200	1700	98.4
234760M.SP	310	460	406	190	95	47.5	4	1.5	17.7	450	1530	1200	1700	91.2
234464M.SP	320	480	426	190	95	47.5	4	1.5	17.7	455	1630	1200	1700	102
234764M.SP	330	480	426	190	95	47.5	4	1.5	17.7	455	1630	1200	1700	94.9
234468M.SP	340	520	459	212	106	53	4	1.5	17.7	540	2000	1100	1600	138
234768M.SP	350	520	459	212	106	53	4	1.5	17.7	540	2000	1100	1600	129

Double Direction Angular Contact Thrust Ball Bearings

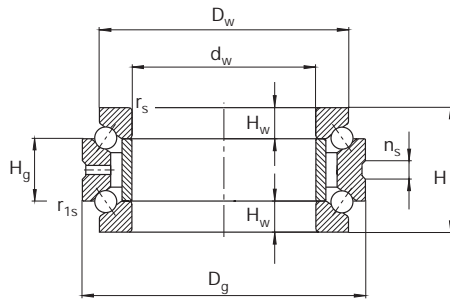

2344, 2347
Contact angle $\alpha = 60^\circ$

Bearing Number	Dimensions									Load Rating dyn. C	stat. C ₀	Attainable Speed		Weight ≈ kg
	d _w	D _g	D _w	H	H _g	H _w	r _{smin}	r _{1smin}	n _s			Grease	Oil	
FAG	mm									kN		rpm		
234472M.SP	360	540	479	212	106	53	4	1.5	17.7	540	2040	1000	1500	144
234772M.SP	370	540	479	212	106	53	4	1.5	17.7	540	2040	1000	1500	135
234476M.SP	380	560	499	212	106	53	4	1.5	17.7	560	2200	1000	1500	154
234776M.SP	390	560	499	212	106	53	4	1.5	17.7	560	2200	1000	1500	144
234480M.SP	400	600	532	236	118	59	5	2	17.7	630	2550	900	1300	198
234780M.SP	410	600	532	236	118	59	5	2	17.7	630	2550	900	1300	187

Cylindrical Roller Bearings



Cylindrical Roller Bearings

FAG produces cylindrical roller bearings of super precision in the series N10 and NN30.

The double row bearings are used in applications where a :

- radially stiff
- high capacity
- high precision support is required.

Any axial load would be taken up by the double direction angular contact thrust bearings of the series 2344 (see page 42).

The single row bearing would be mostly used as the 'loose' bearing in combination with FAG spindle bearings as 'fixed' bearings.

Bearing Design

Double row cylindrical roller bearings have a high load carrying capacity thanks to the high number of cylindrical rollers in each row.

The cage is of robust solid brass construction.

Single row cylindrical roller bearings also have a solid brass cage and are specially designed for the demands of high speed spindles.

The bearing bore is tapered (taper 1:12). The desired radial preload or radial clearance can be set by an axial adjustment on the conical shaft.

Lubrication

FAG cylindrical roller bearings can be lubricated with either grease or oil.

For this purpose the double row bearings have a lubricating groove and lubricating hole in the middle of the outer ring.

Selection data and calculations for super precision cylindrical roller bearings can be found as follows:

- | | |
|---|------------|
| - Life Calculations | Page 56-62 |
| - Lubrication | Page 63-66 |
| - Tolerances | Page 68-70 |
| - Manufacturing Tolerances for Mating Parts | Page 72-83 |
| - Attainable speed | Page 84 |
| - Rigidity | Page 88 |

Cylindrical Roller Bearings

NN3008ASK.M.SP.C2

Type		Radial Play	
N	Single row, shoulders on the IR	C2	Radial per standards
NN	Double row, shoulders on the IR	R40.50	Special radial play
Dimensional Series		Precision	
10	Single row bearings	SP	Super precision
30	Double row bearings	UP	Ultra precision
Bore Size Code		Cage	
06	6 · 5 = 30 mm	M1	Brass cage single row
08	8 · 5 = 40 mm	M	Brass cage double row
/500	500 mm	Tapered Bore	
		K	Tapered bore, single row bearing
		ASK	Tapered bore, lubrication holes in OR double row bearing

IR = Inner Ring
OR = Outer Ring

Radial play of FAG Cylindrical Roller Bearings with tapered bore

Nominal bearing bore	Over to	Dimensions in mm																		
		30	40	50	65	80	100	120	140	160	180	200	225	250	280	315	355	400	450	
Bearing Design		Radial play in µm																		
ASK.M.SP,	min	15	15	17	20	25	35	40	45	50	55	60	60	65	75	80	90	100	110	120
ASK.M.UP, K.M1.SP	max	25	25	30	35	40	55	60	70	75	85	90	95	100	110	120	135	150	170	190
ASK.M.SP.C2,	min	20	20	25	30	35	40	50	55	60	75	85	95	105	115	130	145	165	185	205
ASK.M.UP.C2	max	45	45	55	60	70	75	90	100	110	125	140	155	170	185	205	225	255	285	315

The standard radial clearance of Precision SP and UP is C1NA.

Cylindrical Roller Bearings

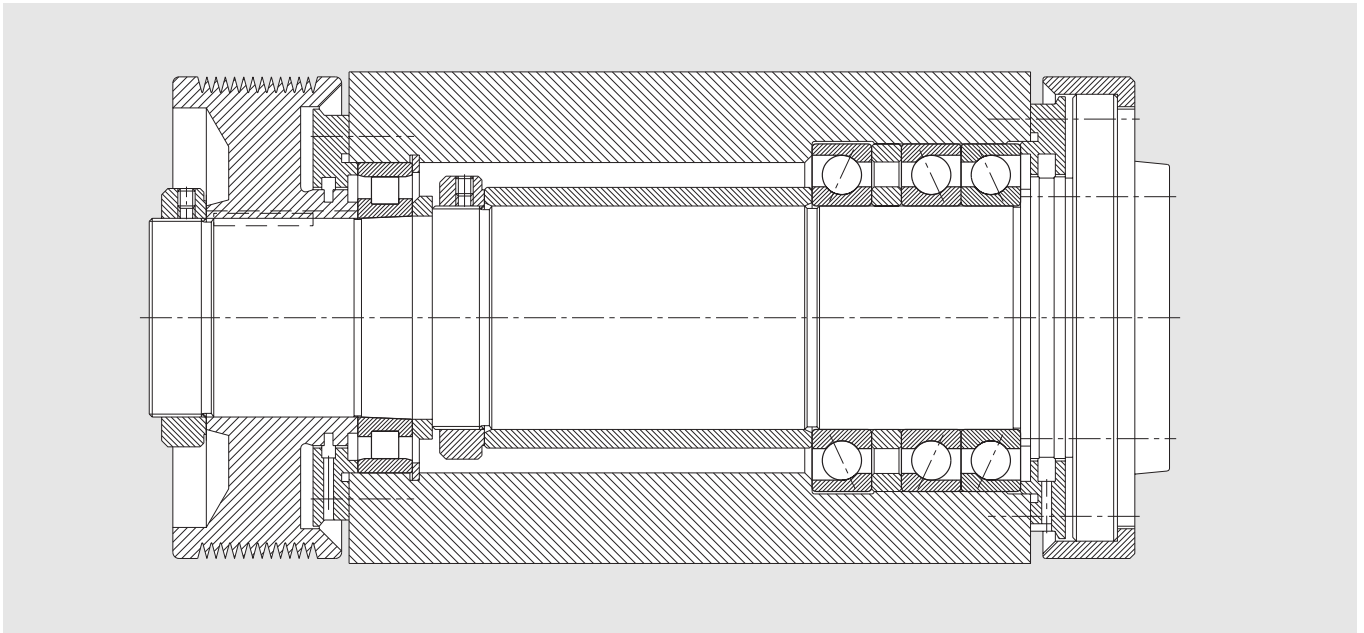

The Main Spindle of a CNC Lathe.

Technical Data

Motor power: 25 kW
Speed: 31.5...5000 rpm

Bearing Selection

The bearings must support the spindle both axially and radially precisely and rigidly. The bearings are preloaded and manufactured to super precision tolerances.

Work side: 1 spindle bearing set FAG B7018E.TP4S.TBTL in a Tandem, back to back arrangement as a fixed bearing.

Diven side: single row cylindrical roller bearings FAG N1016K.M1.SP as a floating bearing. The arrangement is suited to high speeds and high cutting efficiency.

Bearing Dimensions

The bearing size is determined principally by the required spindle rigidity, i.e. the spindle diameter.

The fatigue life of the bearing is taken into consideration during selec-

tion, however, in practice it does not figure greatly. As the grease working life and the Hertzian contact stresses in the rolling bearing are the decisive factors.

Main spindles do not as a rule fail on account of fatigue, but instead because of wear.

Preload, Bearing Clearance

FAG spindle bearings are delivered in sets for different arrangements. They have a set light preload suitable for the application requirement.

The cylindrical roller bearing is set almost without clearance by press fitting the tapered inner ring on to the spindle.

Lubrication, Sealing

The bearings are lubricated for life with FAG bearing grease Arcanol L74V.

The free space in spindle bearings is filled to ca. 35 % and with cylindrical roller bearings to ca. 20 %.

Sealing is accomplished via a labyrinth with discrete narrow radial gaps.

Cylindrical Roller Bearings

N10

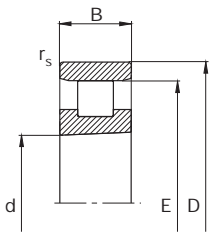

Bearing Number	Dimensions					Load Rating		Attainable Speed		Weight ≈ kg
	d	D	B	r _{smin}	E	dyn. C	stat. C ₀	Grease rpm	Oil minimal	
FAG	mm					kN				
N1006K.M1.SP	30	55	13	0.6	48.5	18.6	18	19000	22000	0.13
N1007K.M1.SP	35	62	14	0.6	55	23.6	24.5	16000	18000	0.172
N1008K.M1.SP	40	68	15	0.6	61	27.5	29	15000	17000	0.216
N1009K.M1.SP	45	75	16	0.6	67.5	32.5	35.5	13000	15000	0.271
N1010K.M1.SP	50	80	16	0.6	72.5	36	41.5	12000	14000	0.297
N1011K.M1.SP	55	90	18	1	80.5	41.5	50	11000	13000	0.439
N1012K.M1.SP	60	95	18	1	85.5	44	55	10000	12000	0.47
N1013K.M1.SP	65	100	18	1	90.5	45	58.5	9500	11000	0.499
N1014K.M1.SP	70	110	20	1	100	64	81	9000	10000	0.691
N1015K.M1.SP	75	115	20	1	105	65.5	85	8500	9500	0.728
N1016K.M1.SP	80	125	22	1	113.5	76.5	98	7500	8500	0.986
N1017K.M1.SP	85	130	22	1	118.5	78	104	7500	8500	1.04
N1018K.M1.SP	90	140	24	1.1	127	93	125	6700	7500	1.34
N1019K.M1.SP	95	145	24	1.1	132	96.5	129	6300	7000	1.4
N1020K.M1.SP	100	150	24	1.1	137	98	134	6000	6700	1.46
N1021K.M1.SP	105	160	26	1.1	145.5	112	153	5600	6300	1.82
N1022K.M1.SP	110	170	28	1.1	155	140	190	5300	6000	2.3
N1024K.M1.SP	120	180	28	1.1	165	150	208	5000	5600	2.47
N1026K.M1.SP	130	200	33	1.1	182	180	250	4300	4800	3.72
N1028K.M1.SP	140	210	33	1.1	192	183	265	4000	4500	3.94
N1030K.M1.SP	150	225	35	1.5	205.5	208	310	3800	4300	4.75
N1032K.M1.SP	160	240	38	1.5	220	245	355	3400	3800	5.79
N1034K.M1.SP	170	260	42	2.1	237	300	430	3200	3600	7.77
N1036K.M1.SP	180	280	46	2.1	255	360	520	3000	3400	10.2
N1038K.M1.SP	190	290	46	2.1	265	365	550	2800	3200	10.6
N1040K.M1.SP	200	310	51	2.1	281	400	600	2600	3000	14
N1044K.M1.SP	220	340	56	3	310	510	765	2400	2800	17.9
N1048K.M1.SP	240	360	56	3	330	540	850	2200	2600	19.3
N1052K.M1.SP	260	400	65	4	364	655	1020	1900	2200	28.6
N1056K.M1.SP	280	420	65	4	384	680	1100	1800	2000	30.9
N1060K.M1.SP	300	460	74	4	420	900	1430	1600	1800	43.7
N1064K.M1.SP	320	480	74	4	440	915	1500	1500	1700	45.1
N1068K.M1.SP	340	520	82	5	475	1120	1830	1400	1600	60.7

Cylindrical Roller Bearings

N10

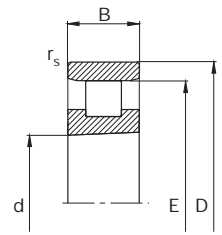

Bearing Number	Dimensions					Load Rating		Attainable Speed		Weight ≈ kg
	d	D	B	r_{smin}	E	dyn. C	stat. C_0	Grease rpm	Oil minimal	
FAG	mm					kN				
N1072K.M1.SP	360	540	82	5	495	1140	1900	1300	1500	64.4
N1076K.M1.SP	380	560	82	5	515	1180	2000	1300	1500	66.6
N1080K.M1.SP	400	600	90	5	550	1370	2320	1200	1400	88.1
N1084K.M1.SP	420	620	90	5	570	1400	2450	1100	1300	90.7
N1088K.M1.SP	440	650	94	6	597	1560	2750	1100	1300	106
N1092K.M1.SP	460	680	100	6	624	1660	3000	1000	1200	120
N1096K.M1.SP	480	700	100	6	644	1700	3100	950	1100	125
N10/500K.M1.SP	500	720	100	6	664	1760	3200	950	1100	130

Cylindrical Roller Bearings

NN30

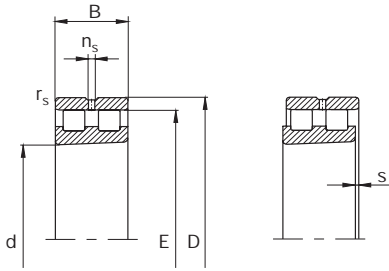

Bearing Number	Dimensions							Load Rating		Attainable Speed		Weight ≈ kg
	d	D	B	r _{smin}	E	n _s	s	dyn. C	stat. C ₀	Grease rpm	Oil minimal	
FAG	mm							kN				
NN3006ASK.M.SP	30	55	19	1	48.5	4.8	1.4	29	34	16000	19000	0.199
NN3007ASK.M.SP	35	62	20	1	55	4.8	1.4	35.5	44	14000	17000	0.259
NN3008ASK.M.SP	40	68	21	1	61	4.8	1.4	45	58.5	12000	15000	0.315
NN3009ASK.M.SP	45	75	23	1	67.5	4.8	1.7	54	72	11000	14000	0.408
NN3010ASK.M.SP	50	80	23	1	72.5	4.8	1.7	57	80	10000	13000	0.41
NN3011ASK.M.SP	55	90	26	1.1	81	4.8	1.9	72	100	9000	11000	0.652
NN3012ASK.M.SP	60	95	26	1.1	86.1	4.8	1.9	75	110	8500	10000	0.672
NN3013ASK.M.SP	65	100	26	1.1	91	4.8	1.9	76.5	116	8000	9500	0.741
NN3014ASK.M.SP	70	110	30	1.1	100	6.5	2.3	98	150	7000	8500	1.07
NN3015ASK.M.SP	75	115	30	1.1	105	6.5	2.3	100	156	6700	8000	1.13
NN3016ASK.M.SP	80	125	34	1.1	113	6.5	2.5	120	186	6300	7500	1.56
NN3017ASK.M.SP	85	130	34	1.1	118	6.5	2.5	125	200	6000	7000	1.64
NN3018ASK.M.SP	90	140	37	1.5	127	6.5	2.5	140	224	5600	6700	2.13
NN3019ASK.M.SP	95	145	37	1.5	132	6.5	2.5	143	236	5300	6300	2.23
NN3020ASK.M.SP	100	150	37	1.5	137	6.5	2.5	146	245	5300	6300	2.32
NN3021ASK.M.SP	105	160	41	2	146	6.5	2.6	190	310	4800	5600	2.96
NN3022ASK.M.SP	110	170	45	2	155	6.5	2.8	220	360	4500	5300	3.76
NN3024ASK.M.SP	120	180	46	2	165	6.5	3.1	232	390	4300	5000	4.1
NN3026ASK.M.SP	130	200	52	2	182	9.5	3.3	290	500	3800	4500	6.04
NN3028ASK.M.SP	140	210	53	2	192	9.5	3.3	300	520	3600	4300	6.48
NN3030ASK.M.SP	150	225	56	2.1	206	9.5	3.7	335	585	3400	4000	7.88
NN3032ASK.M.SP	160	240	60	2.1	219	9.5	4.2	375	670	3200	3800	9.57
NN3034ASK.M.SP	170	260	67	2.1	236	9.5	4.5	450	800	3000	3600	13
NN3036ASK.M.SP	180	280	74	2.1	255	12.2	4.8	570	1000	2800	3400	17
NN3038ASK.M.SP	190	290	75	2.1	265	12.2	4.8	585	1040	2600	3200	18
NN3040ASK.M.SP	200	310	82	2.1	282	12.2	5.3	655	1200	2400	3000	23
NN3044ASK.M.SP	220	340	90	3	310	15	5.5	800	1460	2200	2800	32.9
NN3048ASK.M.SP	240	360	92	3	330	15	6	850	1560	2000	2600	36
NN3052ASK.M.SP	260	400	104	4	364	15	6.5	1060	2000	1900	2400	48
NN3056ASK.M.SP	280	420	106	4	384	15	6.8	1080	2080	1800	2200	51.7
NN3060ASK.M.SP	300	460	118	4	418	17.7	7.4	1270	2400	1600	1900	71.5
NN3064ASK.M.SP	320	480	121	4	438	17.7	7.9	1320	2600	1600	1900	77.2
NN3068ASK.M.SP	340	520	133	5	473	17.7	8.7	1630	3250	1400	1700	103

Cylindrical Roller Bearings

NN30

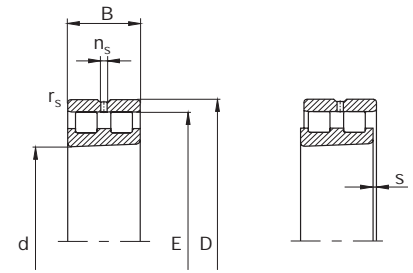

Bearing Number	Dimensions							Load Rating		Attainable Speed		Weight ≈ kg
	d	D	B	r_{smin}	E	n_s	s	dyn. C	stat. C_0	Grease rpm	Oil minimal	
FAG	mm							kN				
NN3072ASK.M.SP	360	540	134	5	493	17.7	8.7	1660	3350	1400	1700	109
NN3076ASK.M.SP	380	560	135	5	513	17.7	9	1700	3450	1300	1600	114
NN3080ASK.M.SP	400	600	148	5	549	17.7	9.5	2160	4500	1200	1500	149
NN3084ASK.M.SP	420	620	150	5	569	17.7	10	2120	4500	1200	1500	156
NN3088ASK.M.SP	440	650	157	6	597	23.5	10.3	2450	5100	1100	1400	179
NN3092ASK.M.SP	460	680	163	6	624	23.5	10.5	2600	5400	1100	1400	204
NN3096ASK.M.SP	480	700	165	6	644	23.5	11	2700	5850	1000	1300	214
NN30/500ASK.M.SP	500	720	167	6	664	23.5	11.5	2650	5850	1000	1300	223

Section 3

Technical Information, Engineering



3

Life Calculation for Super Precision Bearings

Life Calculation for Super Precision Bearings

Super precision bearings must locate shafts with high accuracy and support loads up to very high speeds. They can fulfil this task over an expected life span only, providing no bearing wear occurs. This is dependent upon the generation of a supportive hydrodynamic lubricant film in the rolling contact area. Under these circumstances bearings achieve ultimate life in many application. The bearings are predominantly selected from the points of view of

- accuracy
- rigidity
- running behaviour.

Dynamic Equivalent Load P

The dynamic equivalent load P is that constant load derived from

- combined load (radial and axial)
- temporarily changing loads

to give the same calculated life.

Radial Bearings

For bearings which can accept radial and axial load the equivalent load is calculated according to the following equation

$$P = X \cdot F_r + Y \cdot F_a$$

For cylindrical roller bearings in super precision use

$$P = F_r$$

X and Y Factors

The X, Y factors are derived from the ratio of F_a/F_r in comparison to factor e.

Deep Groove Ball Bearings Spindle Bearings - 15° Contact Angle

$$F_a/F_r \leq e$$

$$X = 1, Y = 0.$$

$$F_a/F_r > e \text{ (Table 1)}$$

Spindle Bearings - 25° Contact Angle

With bearings of 25° contact angle, the contact angle changes very little under axial load and therefore the axial factor Y is taken as constant.

$$F_a/F_r \leq 0.68$$

$$P = F_r$$

$$F_a/F_r > 0.68$$

$$P = 0.41 \cdot F_r + 0.87 \cdot F_a$$

Ball Screw Support Bearings

Ball screw support bearings are not suited for radial load $F_r > 0.47 \cdot F_a$. Small radial load components are not considered when calculating the equivalent radial load

$$P = F_a$$

Calculation of the Equivalent Load with Varying Load and Speed.

For bearing arrangements where load and speed are changing, the equivalent radial load is calculated using single loads and speeds with their corresponding percentage of time,

$$P = \sqrt[3]{P_1^3 \cdot \frac{n_1}{n_m} \cdot \frac{q_1}{100} + P_2^3 \cdot \frac{n_2}{n_m} \cdot \frac{q_2}{100} + \dots} \text{ [kN]}$$

and the mean speed

$$n_m = n_1 \cdot \frac{q_1}{100} + n_2 \cdot \frac{q_2}{100} + \dots \text{ [rpm]}$$

Fatigue Life

$$L_{h10} = \left(\frac{C}{P}\right)^p \cdot \frac{10^6}{60 \cdot n}$$

L_{h10} = Life (hours) for 90 % survival of a typical bearing group

C = Dynamic Capacity [kN]

P = Dynamic equivalent load [kN]

n = Speed [rpm]

p = 3 for ball bearings

p = 10/3 for roller bearings

1: Radial and Axial Factors

$\frac{f_0 \cdot F_a}{i \cdot C_0}$	Deep Groove Bearings									Spindle Bearings		
	Normal			Code 5			Code 6			$\alpha = 15^\circ$		
	e	X	Y	e	X	Y	e	X	Y	e	X	Y
0.3	0.22	0.56	2	0.32	0.46	1.7	0.4	0.44	1.4	0.4	0.44	1.4
0.5	0.24	0.56	1.8	0.35	0.46	1.56	0.43	0.44	1.31	0.43	0.44	1.31
0.9	0.28	0.56	1.58	0.39	0.46	1.41	0.45	0.44	1.23	0.45	0.44	1.23
1.6	0.32	0.56	1.4	0.43	0.46	1.27	0.48	0.44	1.16	0.48	0.44	1.16
3	0.36	0.56	1.2	0.48	0.46	1.14	0.52	0.44	1.08	0.52	0.44	1.08
6	0.43	0.56	1	0.54	0.46	1	0.56	0.44	1	0.56	0.44	1

i = number of bearings supporting the thrust load.

Life Calculation for Super Precision Bearings

2: Factor f_0 for Spindle Bearings with contact angle $\alpha = 15^\circ$

Basic Ref. Number	Factor f_0				
	Bearing Series	B719C	B70C	B72C	HSS719C/ HCS719C
00	14.2	12.6	12.3	15.3	15.5
01	14.7	13.2	12.9	15.7	15.5
02	14.5	14.1	13.6	15.8	15.8
03	14.8	14.3	13.9	16	15.9
04	14.2	14.3	13.8	16.2	16.1
05	14.9	14.9	14.4	16.5	16.2
06	15.4	15.1	14.3	16.4	16.3
07	15.9	15.4	14.6	16.4	16.5
08	15.5	15.7	14.2	16.2	16.5
09	15.8	15.5	14.2	16.3	16.5
10	16	15.7	14.4	16.2	16.5
11	16	15.5	14.5	16.1	16.5
12	16.2	15.6	14.4	16.2	16.4
13	16.4	15.9	14.5	16.1	16.4
14	16.2	15.6	14.6	16.1	16.4
15	16.3	15.8	14.8	16.1	16.3
16	16.4	15.7	14.8	16.1	16.3
17	16.3	15.9	14.9	16	16.3
18	16.4	15.7	14.8	16	16.3
19	16.4	15.9	14.9	15.9	16.3
20	16.5	16	14.5	16	16.2
21	16.4	15.9	14.5	15.9	16.3
22	16.4	15.8	14.5	16	16.2
24	16.4	16	14.9	15.9	16.3
26	16.4	15.9	14.7	15.9	16.2
28	16.4	16	15		
30	16.3	16	15.3		
32	16.4	16.2	15.3		
34	16.5	15.9	15.4		
36	16.4	15.7	15.4		
38	16.4	15.9	15.2		
40	16.2	15.8	15.4		
44	16.4	15.7	15.3		
48	16.5	15.9			

Miniature and Instrument Bearings

Miniature and Instrument bearings do not normally fail due to fatigue. Failure mode is usually related to the limited lubrication either migrating or thickening with wear debris leading to high torque or vibration. The influence of environmental conditions is extremely important, so please consult our application engineering department for a technical application appraisal. It is however important not to overload miniature bearings otherwise such raceway wear failures will be accelerated and, in this context, the fatigue life calculation can be used as an indication of the bearing capability.

This can be achieved using the general life equation

$$L_{h10} = a \cdot \left(\frac{C}{P} \right)^3 \cdot \frac{10^6}{60 \cdot n}$$

a = material factor
 AISI440C: $a = 0.5$
 SAE52100: $a = 1.0$

$$P = X \cdot F_r + Y \cdot F_a$$

or

$$P = F_r$$

whichever is the greater.

It is recommended that the L_{h10} life-time is a minimum of 30,000 hours.

3: X,Y Factors for Miniature and Instrument Bearings

Factor	Radial Play Code			
	2	3	5	6
X	0.56	0.46	0.44	0.43
Y	2.8	2.1	1.55	1.18

Life Calculation for Super Precision Bearings

Modified Life Calculation

FAG has developed an extended life calculation which considers operating and environmental influences to a substantially larger degree than the standard calculation.

$$L_{hna} = a_1 \cdot a_{23} \cdot L_{h10}$$

Factor a_1

Bearing failures due to material fatigue are subject to statistical laws. The failure probability is taken into consideration by the factor a_1 . For the failure probabilities between 1 % and 10 % the factor a_1 should be taken from Table 4.

Factor a_{23}

The factor a_{23} considers the influences of material, bearing type, loading, lubrication and cleanliness. Super precision bearings are dimensionally stable up to 120° C. Up to this value the influence of temperature on the material properties need not be taken into account. For applications of super precision bearings at higher temperatures please consult FAG. For the effects of load the factor

$$f_{s*} = C_0/P_{0*}$$

should be ascertained.

The calculation uses the same dynamic loads as used for the dynamic equivalent load but the static factors X_0 and Y_0 are used.

$$P_{0*} = X_0 \cdot F_r + Y_0 \cdot F_a$$

Factor X_0 and Y_0 for :

Contact angle 15°
 $X_0 = 0.5$ and $Y_0 = 0.46$

Contact angle 25°
 $X_0 = 0.5$ and $Y_0 = 0.38$

4: Factor a_1

Failure - probability %	10	5	4	3	2	1
Fatigue life	L_{10}	L_5	L_4	L_3	L_2	L_1
Factor a_1	1	0.62	0.53	0.44	0.33	0.21

5: Rated viscosity v_1

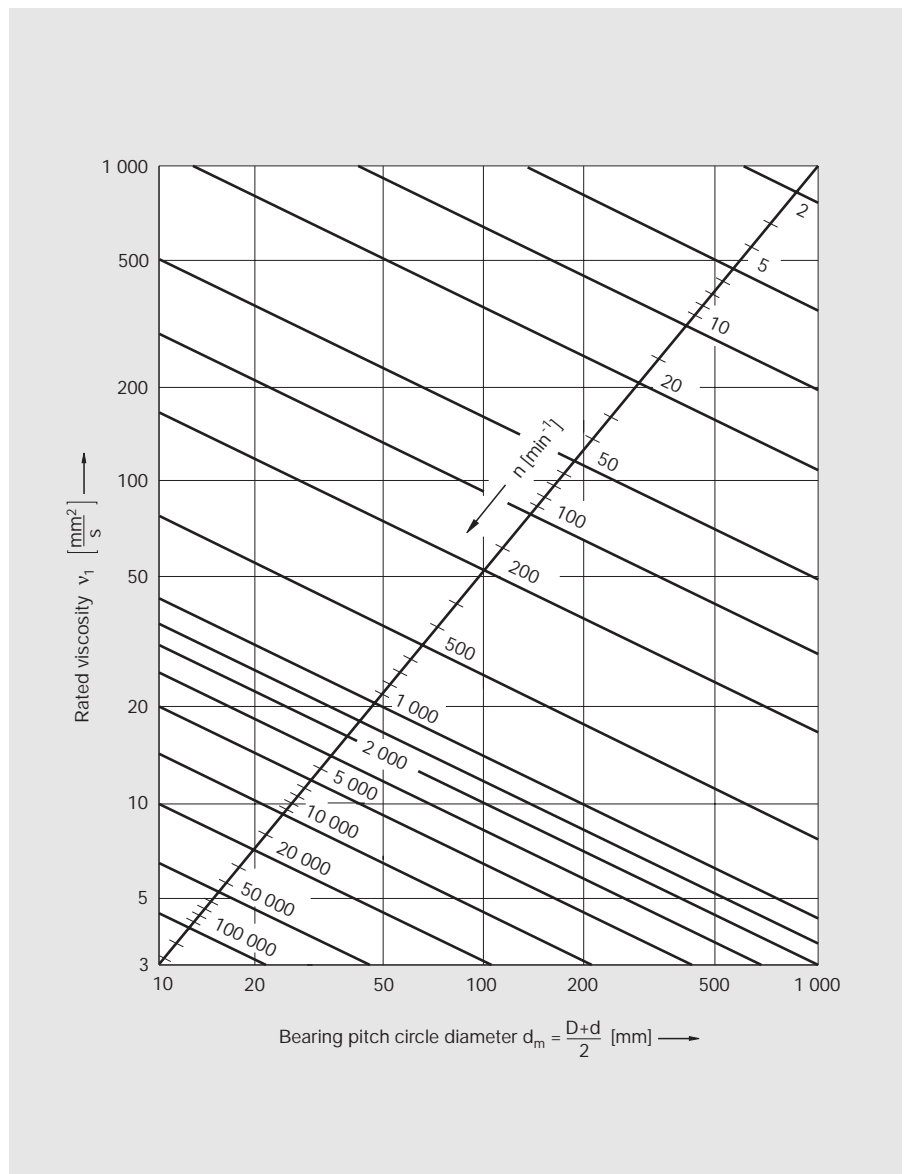

Life Calculation for Super Precision Bearings

Bearing Type

The factor K_1 (graph 7) for the bearing type considers the kinematic properties of different bearing designs, curves a and b.

Lubrication

The condition of the lubricant film is taken into account by the value $\kappa = v/v_1$ as a measure of lubricant film thickness and K_2 as a measure of the effectiveness of additives. The rated viscosity v_1 is a function of bearing size and speed and is established from graph 5. The actual operating viscosity v at working temperature taken from graph 6 is used in a ratio with v_1 . For greases the viscosity of the base oil is used.

When lubricating with the correct quantity of a good suitable grease, the value of K_2 chosen will be the same as a similar oil with suitable additives.

In the absence of sufficient knowledge concerning the suitability of the grease, use the lower limit of area 2 to determine the $a_{23 II}$ value.

Optaining $K = K_1 + K_2$ from diagram 7 and κ , the value $a_{23 II}$ can be established from diagram 8.

6: V-T-Diagram

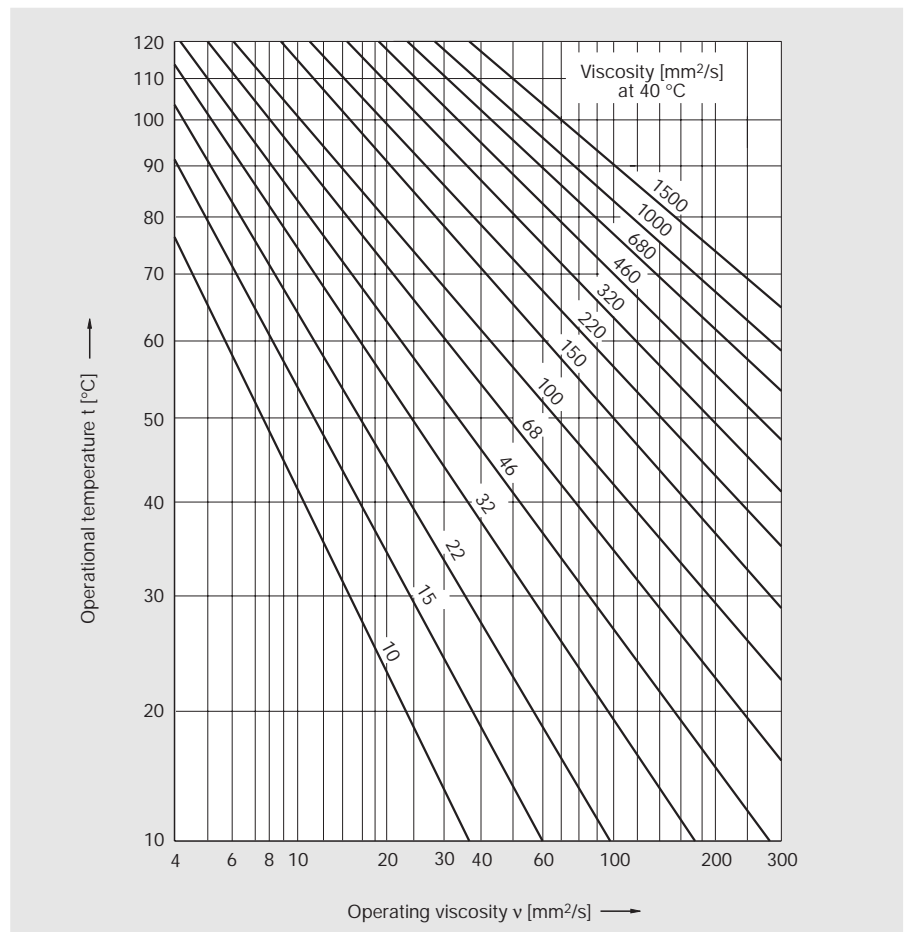

7: K_1 being dependent on the value of f_{s^*} and the bearing design. K_2 is used as the dependent value f_{s^*} for additive and non-additive lubricants, whose effectiveness in the roller bearings has not been tested. $K_2 = 0$ with lubricants with additives, for which corresponding evidence is available.

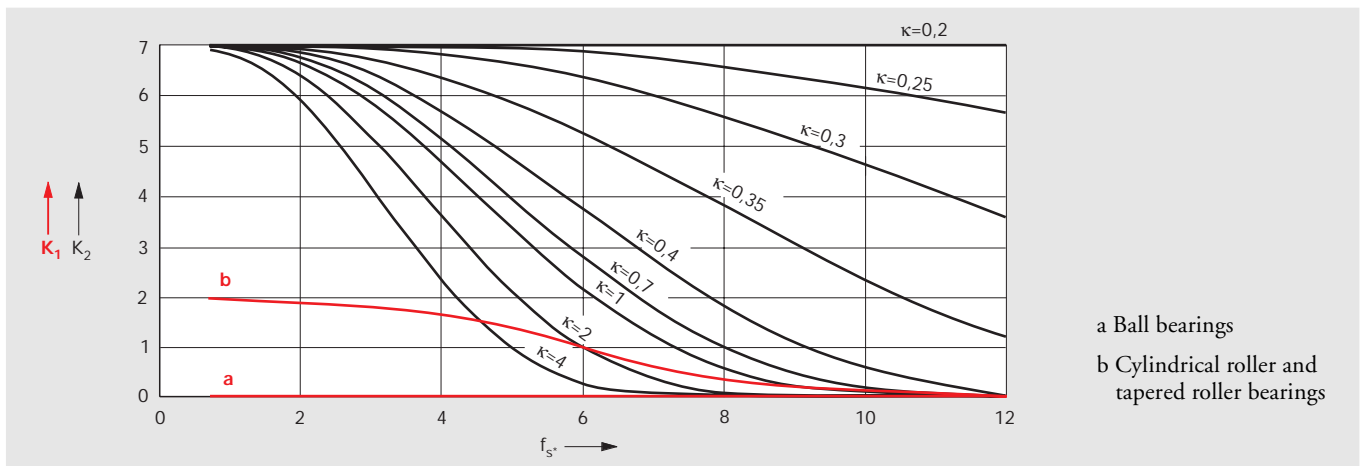

3

Life Calculation for Super Precision Bearings

8: Base value a_{23II} used to calculate the factor a_{23}

v operating viscosity of the lubricant; v_1 rated viscosity

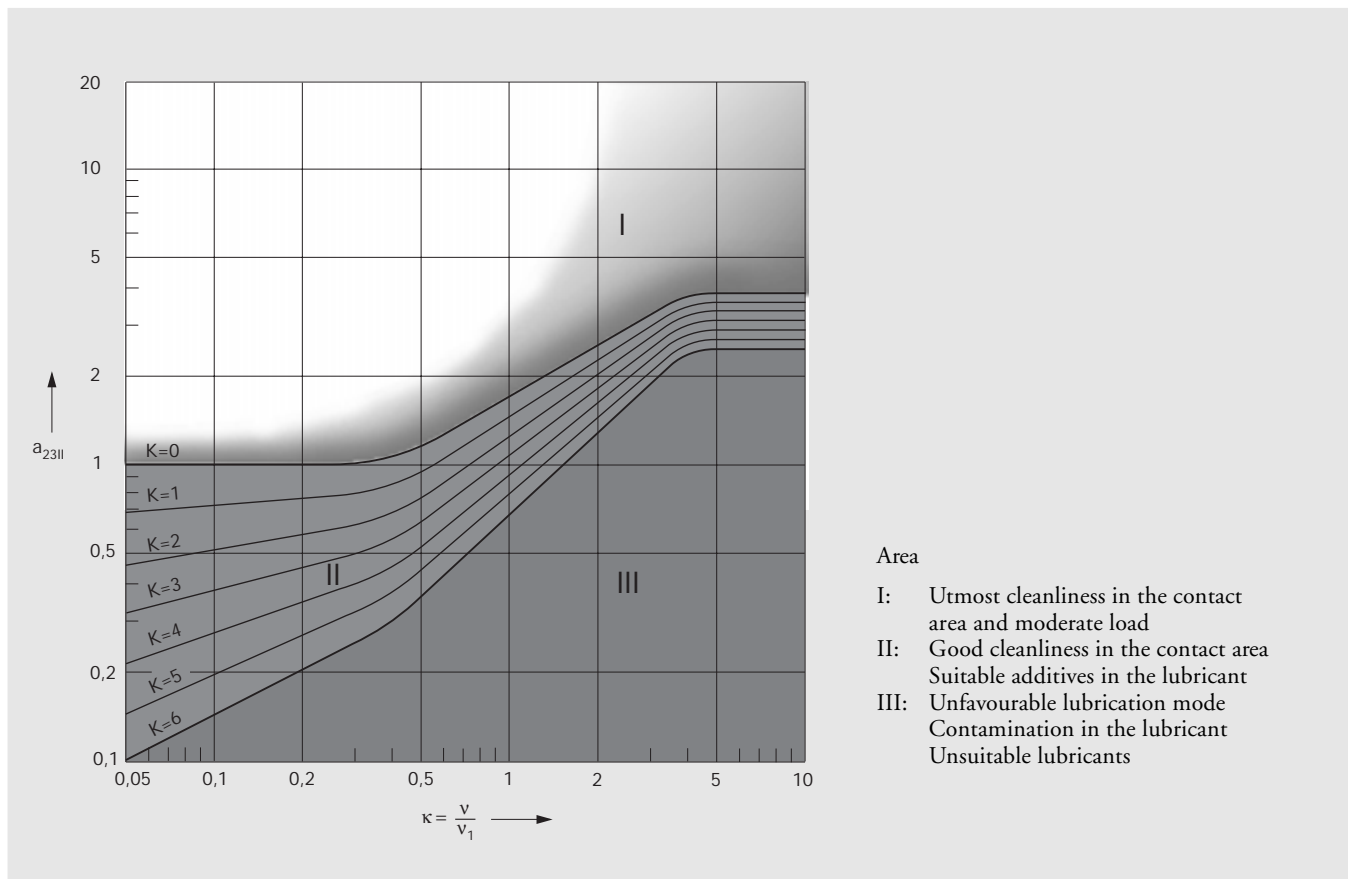

Where $K = 0$ to 6 then a_{23II} lies on a curve in area II.

Where $K > 6$ then only a factor a_{23} in area III can be expected. A smaller value of K , and thereby the defined area II, should be sought after through an improvement in conditions.

Cleanliness

The cleanliness in the contact area plays a very important role with precision bearings, since

- with the generally lightly loaded bearings the relative influence on life is very large
- Contamination greatly promotes wear

It is necessary therefore to specify a cleanliness level whereby the smallest permissible contaminant is less than the factor $V = 1$. Values for factor $V = 1$, adopted from the hydraulic field, are list in table 9 as a guide.

The cleanliness factor s can be obtained from the graph in diagram 10. a_{23} is derived from the equation

$$a_{23} = a_{23II} \cdot s.$$

Life Calculation for Super Precision Bearings

9: Data for the selection of contamination parameter V

(D-d)/2 mm	V 1)	Point Contact			Line Contact		
		Oil cleanliness class per ISO 4406	Filtration ratio per ISO 4572	Maximum size ²⁾ of rolled over particle µm	Oil cleanliness class per ISO 4406	Filtration ratio per ISO 4572	Maximum size ²⁾ of rolled over particle µm
≤ 12.5	0.3	11/8	$\beta_3 \geq 200$	10	12/9	$\beta_3 \geq 200$	20
	0.5	12/9	$\beta_3 \geq 200$		13/10	$\beta_3 \geq 75$	
	1	14/11	$\beta_6 \geq 75$	30	15/12	$\beta_6 \geq 75$	60
	2	15/12	$\beta_6 \geq 75$		16/13	$\beta_{12} \geq 75$	
	3	16/13	$\beta_{12} \geq 75$	100	17/14	$\beta_{25} \geq 75$	150
> 12.5 ... 20	0.3	12/9	$\beta_3 \geq 200$	15	13/10	$\beta_3 \geq 75$	25
	0.5	13/10	$\beta_3 \geq 75$		14/11	$\beta_6 \geq 75$	
	1	15/12	$\beta_6 \geq 75$	45	16/13	$\beta_{12} \geq 75$	75
	2	16/13	$\beta_{12} \geq 75$		17/14	$\beta_{25} \geq 75$	
	3	18/14	$\beta_{25} \geq 75$	150	19/15	$\beta_{25} \geq 75$	250
> 20 ... 35	0.3	13/10	$\beta_3 \geq 75$	25	14/11	$\beta_6 \geq 75$	40
	0.5	14/11	$\beta_6 \geq 75$		15/12	$\beta_6 \geq 75$	
	1	16/13	$\beta_{12} \geq 75$	75	17/14	$\beta_{12} \geq 75$	120
	2	17/14	$\beta_{25} \geq 75$		18/15	$\beta_{25} \geq 75$	
	3	19/15	$\beta_{25} \geq 75$	250	20/16	$\beta_{25} \geq 75$	350
> 35	0.3	14/11	$\beta_6 \geq 75$	40	14/11	$\beta_6 \geq 75$	75
	0.5	15/12	$\beta_6 \geq 75$		15/12	$\beta_{12} \geq 75$	
	1	17/14	$\beta_{12} \geq 75$	120	18/14	$\beta_{25} \geq 75$	200
	2	18/15	$\beta_{25} \geq 75$		19/16	$\beta_{25} \geq 75$	
	3	20/16	$\beta_{25} \geq 75$	250	21/17	$\beta_{25} \geq 75$	350

The oil cleanliness class as a measure for the probability for the rolling over of life diminishing particles in a bearing can be determined by means of sampling e.g. through the filter manufacturers and institutes. The cleanliness class will be achieved if the total oil quantity is circulated through the filter every few minutes. To safely achieve good cleanliness the oil system should be purged before the bearings are rotated.

The filter efficiency rate $\beta_3 \geq 200$ (ISO 4572) means for example that, in a so called Multi-Pass Test, out of 200 particles $\geq 3 \mu\text{m}$ only one particle will pass the filter. Coarser filters than $\beta_{25} \geq 75$ should not be used because of their disadvantageous effects on the other components in the oil circulation system.

^{1, 2)} The contamination parameter V applies when, in the highly loaded contact zone, no particles having a hardness $> 50 \text{ Rc}$ are rolled over.

3

10: Diagram to determine the cleanliness factor s Diagram for increased (V = 0,5) to the highest (V = 0,3) cleanliness

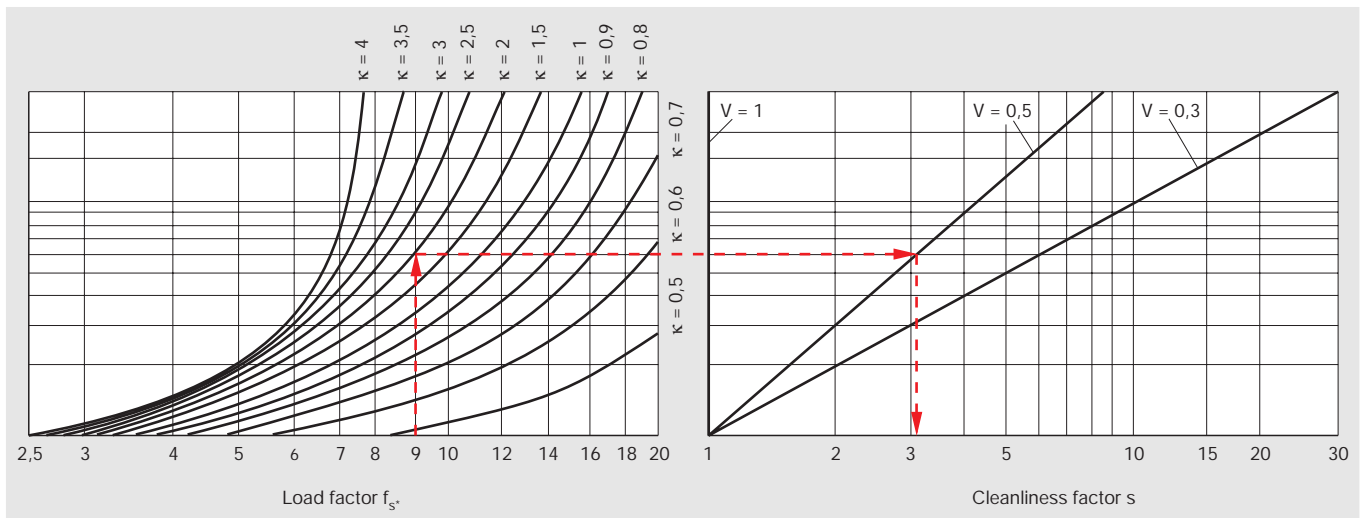

Life Calculation for Super Precision Bearings

Static Load

For super precision bearings the static loading, i.e. loading without ring rotation, is seldom checked. As a measure of the static stress the index f_s is calculated by

$$f_s = C_0 / P_0$$

f_s = static stress index

C_0 = basic static load rating [kN]

P_0 = static equivalent load [kN]

For the modified life calculation the factor f_s is also calculated using the following equations, but using dynamic loading.

Spindle Bearings

Contact angle $\alpha = 15^\circ$

$$P_0 = F_r \quad [\text{kN}]$$

for $F_a/F_r \leq 1.09$

$$P_0 = 0.5 \cdot F_r + 0.46 \cdot F_a \quad [\text{kN}]$$

for $F_a/F_r > 1.09$

Contact angle $\alpha = 25^\circ$

$$P_0 = F_r \quad [\text{kN}]$$

for $F_a/F_r \leq 1.31$

$$P_0 = 0.5 \cdot F_r + 0.38 \cdot F_a \quad [\text{kN}]$$

for $F_a/F_r > 1.31$

For multiple bearings

$$C_0 = i \cdot C_{0 \text{ Single bearing}} \quad [\text{kN}]$$

i = number of single bearings

In order to maintain the bearing accuracy, the static stress index should exceed 3.

Ball Screw Support Bearings

$$P_0 = 3.98 \cdot F_r + F_a$$

The static stress index should exceed 2.5

Double Direction Angular Contact Thrust Bearings

$$P_0 = F_a$$

The static stress index should exceed 2.5

Cylindrical Roller Bearings

$$P_0 = F_r$$

The static stress index should exceed 3.0

Lubrication

An important factor for

- adequate useful bearing life
- wear free running
- low vibration level is a lubrication film which separates the rolling elements in the contact zone.

In order to achieve this

- the presence of a lubricant on all contact areas at all times must be ensured and
- a lubricant selected with the correct properties

Lubricant Viscosity

The rated viscosity of a lubricant (see Life calculation) can be determined from Diagram 5.

For successful operation we recommend a viscosity at operating temperature at least double that of the rated viscosity.

Grease Lubrication

Super precision bearings are predominantly grease lubricated. This provides simply the advantages of

- low torque
- no additional lubrication system (cost, space)
- simple sealing systems.

Suitable greases for super precision bearings are listed in Tables 11 and 17.

Grease quantity

Each bearing type requires a different grease quantity. The recommendations in tables 12 and 13 are based on the undisturbed free volume.

Useful grease life

The useful grease life is the time over which proper bearing function is sustained by the initial grease quantity in the bearing. It is dependant upon - grease quantity

11 : Standard Greases for Spindle Bearings

FAG Grease Arcanol	Consistency Class	Base oil Viscosity 40 °C mm ² /s	Operating Temperature °C	Typical Application
L74V	2	23	-40...+130	High speed, Standard for Spindle bearings
L91V	2	15	-60...+100	Very low friction Low Temperature High Speed
L64V	3 - 4	95	-25...+120	Oscillatory motion Outer ring rotation
L207V	2 - 3	70	-40...+180	High Temperature
L135V	2	85	-40...+150	Large bearings High loads

12 : Grease Quantity for Ball Screw Support Bearings

Basic Bearing No. FAG	Grease Quantity g	Basic Bearing No. FAG	Grease Quantity g
7602012TVP	0.38	BSB055090T	3.8
7602015TVP	0.6	7602055TVP	7.85
7602017TVP	0.8	BSB055120T	7.35
7602020TVP	1.42	7603055TVP	17.9
BSB020047T	1.66	7602060TVP	9.85
7603020TVP	1.68	BSB060120T	7.6
7602025TVP	1.95	7603060TVP	21.1
BSB025062T	2.3	7602065TVP	11.7
7603025TVP	3.1	7603065TVP	25.6
BSB030062T	2.3	7602070TVP	13.3
7602030TVP	2.65	7603070TVP	30.3
7603030TVP	4.55	BSB075110T	4.9
BSB035072T	2.8	7602075TVP	15.5
7602035TVP	3.7	7603075TVP	37.3
7603035TVP	5.95	7602080TVP	17.7
BSB040072T	2.8	7603080TVP	44
7602040TVP	4.45	7602085TVP	22.2
BSB040090T	6.1	7603085TVP	49.8
7603040TVP	8.3	7602090TVP	27.1
BSB045075T	3	7603090TVP	58.2
7602045TVP	5.35	7602095TVP	32.6
BSB045100T	6.25	7603095TVP	67.6
7603045TVP	11.1	BSB100150T	14.9
7602050TVP	6.5	7602100TVP	37.3
BSB050100T	6.25	7603100TVP	79.6
7603050TVP	14.4		

Lubrication

13: Grease Quantity for Super Precision Spindle Bearings

Bore Reference	Grease Quantity							
	Bearing series							
	HS719	HS70	B719	B70	B72	NN30	2344	N10
	HC719	HC70	HCB719	HCB70	HCB72		2347	
	g							
6		0.11		0.04				
7		0.12		0.05				
8		0.15		0.1				
9		0.19		0.09				
00	0.15	0.24	0.08	0.15	0.24			
01	0.16	0.26	0.09	0.19	0.32			
02	0.26	0.42	0.15	0.29	0.44			
03	0.28	0.52	0.15	0.38	0.62			
04	0.52	0.88	0.32	0.68	1			
05	0.62	1.02	0.36	0.78	1.3			
06	0.82	1.54	0.38	1	1.9	1.4	3.5	
07	1.06	1.96	0.58	1.6	2.7	1.6	4.5	
08	1.5	2.4	1.2	2.1	3.4	2	5.5	
09	2	3.3	1.5	2.7	4.1	2.6	7	1.2
10	2.1	3.6	1.6	3	4.9	2.8	7.5	1.4
11	3.1	5.4	2	4.2	5.9	4	11	2
12	3.3	5.8	2.3	4.5	7.2	4.4	11	2.2
13	3.5	6.1	2.4	4.8	8.4	4.6	12	2.3
14	5.2	8.3	3.9	6.4	9.8	6.5	16	3.2
15	5.5	8.8	4.2	6.8	11.6	7	17	3.5
16	6.3	11.5	4.4	8.7	11.1	9.5	23	5
17	7.7	12.1	6.1	9.3	16.5	10	25	5
18	8.5	15.9	6.4	12	17.2	13	35	6.5
19	8.9	16.6	6.7	12.5	23.5	13	35	6.5
20	11.5	17.3	8.8	13.1	24.5	13	40	6.5
21	12	22.1	9.1	13.5	32.7	18	55	9
22	13.2	25.4	9.4	19.7	39.5	24	55	12
24	16.1	27.3	13	21	35	27	60	13
26	22	39	16	33	38	33	95	
28	23	42	17	35	53	36	105	
30	34	51	26	40	73	45	125	
32	36	63	27	52	93	55	155	
34			29	59	108	75	205	
36			43	85	113	100	285	
38			45	89	140	105	280	
40			64	107	169	135	370	
44			62	155	225	180	470	
48			66	167		200	560	
52			106	240		280	750	
56			113	256		310	765	

The series HS and HC are available greased and sealed as HSS or HCS.

- grease type
- bearing type
- speed
- temperature
- condition of installation

In many applications of super precision bearings the useful grease life is the deciding factor over fatigue life when designing the bearing. The useful grease life can be determined from Diagram 14.

Run-in Procedures

The correct initial operation, particularly with grease lubrication determines to a large extent the performance of a bearing arrangement and its useful life. For proper grease distribution a start stop operation is recommended. This prevents high damaging temperatures in the contact area.

In the stop phase temperature equalising takes place in the bearing compo-

nents so damaging preloading conditions do not occur. The grease distribution is completed when a stable bearing temperature is reached.

When using FAG spindle bearing for highest speeds, the run-in procedure should start firstly at half speed before increasing up to the maximum speed. Please consult the AC/SP - technical applications department for further details.

Oil Lubrication

In applications with super precision bearings there are two basic types of oil lubrication systems

- Minimal oil quantity lubrication
- Oil jet lubrication

Minimal Oil Quantity Lubrication

FAG spindle bearings need very little oil, see table 15. A few cm^3/h are suffi-

cient, provided that all rolling and sliding contact areas are wetted with oil. Such minimal oil quantity lubrication keeps friction losses to a minimum. For metering these small quantities of oil various systems can be used and such equipment is available on the market place. Most common systems are oil mist lubrication and oil-air lubrication. Both transport systems carry oil via an airstream to the bearing but using different technology. Minimal oil quantity is employed when the spindle speed is beyond the range of grease lubrication. Speeds attainable with minimal oil quantity lubrication are listed in the dimensional tables. Oils with a nominal viscosity of $60\text{--}80 \text{ mm}^2/\text{s}$ at 40°C containing EP additives have proven a good choice. Recommended oil quantities for minimal oil lubrication are shown in table 15. Specific conditions of flow, under or over pressure can substantially influence the required quantity.

14: Useful Grease life F_{10}

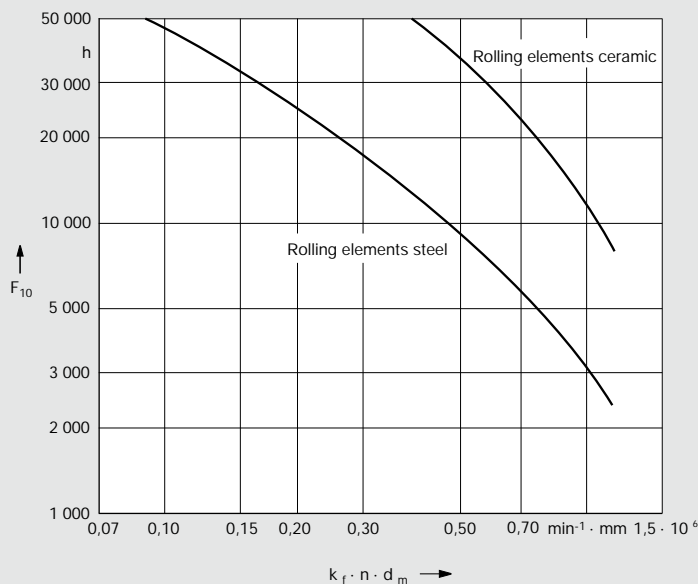

- $k_f = 1$ for N10...K.M1.SP
- $k_f = 0,75$ for contact angle 15° (C)
- $k_f = 0,90$ for contact angle 25° (E)
- $k_f = 2,50$ for 2344...M.SP
- n = Speed
- d_m = Pitch circle diameter

Lubrication

Oil Jet Lubrication

Where spindle speeds exceed those recommended for the minimal quantity lubrication, the need to carry away friction heat arises. With oil jet lubrication considerable oil quantities are directed through the bearing, e.g. by oil injection.

The resistance to rotation increases accordingly. By cooling the circulating oil the operating temperature can be kept at a desired level. With minimal oil quantity lubrication, as well as with oil jet, lubrication oil retention in the area of the bearings must be avoided to prevent an increase in friction through hydraulic losses

Depending upon the oil quantities suitable drain passages must be provided. When using a combination of a cylindrical roller bearing with a double direction angular contact thrust bearing, both bearings must be well sealed from each other, as they need different oil quanti-

ties. If separation is not possible the danger exists of over lubricating the roller bearing resulting in excessive temperature.

15: Required oil quantity for minimal quantity lubrication

Nominal Size of Bearing Bore [mm]	over to	50	120	
		50	120	120
Oil Quantity [cm ³ /h]		0.1...0.2	0.2...0.5	0.5...1.0

16: Required oil quantity for oil jet lubrication

Nominal Size of Bearing Bore [mm]	over to	50	120	
		50	120	120
Oil Quantity [l/min]		0.5...1.5	1.1...4.2	> 2.5

17: Lubricants for Miniature and Instrument Bearings and Deep Groove Bearings

Oil	Designation	Base Oil	Operating Temperature °C	Maximum n · d _m rpm · mm	Typical Application	
O - 34	Dupont Krytox 143AA	Perfluoropolyether	-45 ... +190	700,000	High temperature	
O - 49	ESSO Turbo Oil 2380	Synthetic diester	-54 ... +80	1,500,000	High speed turbines	
OJ - 228	Nyco Lube	Synthetic diester	-55 ... +80	1,500,000	Gyros, Aircraft instruments	
OJ - 234	MOBIL SHC 624	Synthetic hydrocarbon	-54 ... +80	1,500,000	Aerospace, Gyros	
OJ - 201	SHELL Aero fluid 12	Synthetic diester	-50 ... +120	1,500,000	Standard preservation oil	
Grease	Designation	Base Oil	Thickener	Operating Temperature °C	Maximum n · d _m rpm · mm	Typical Application
G - 6	ESSO Andoc C	Mineral	Sodium/calcium	-25 ... +120	1,000,000	Electric motors - outer ring rotation
G - 33	MOBIL 28	Synthetic hydrocarbon	Gel	-60 ... +150	700,000	High temperature
G - 46	KLÜBER Isoflex NBU 15	Ester	Barium complex	-40 ... +130	1,000,000	High speed
G - 68	TEXACO LowTemp EP	Ester	Lithium	-73 ... +110	700,000	Gyroscopes
G J - 264	KLÜBER Asonic GHY72	Ester	Polyurea	-40 ... +180	700,000	High temperature

Clamping Forces for Ball Screw Support Bearings

Clamping of Bearing Outer Rings

The outer rings of the ball screw support bearings are axially clamped during assembly by screwing an end cover onto the housing. Excessive clamping force deforms the outer ring elastically, which results in an increased preload and reduction in working life for bearings in the DF arrangement. The clamping force F_z is reached when the cover screws are tightened with the torque M .

$$M = \frac{F_z}{n} \cdot f \quad [\text{Nmm}]$$

n = number of cover screws

f = conversion factor

Example

Four ball screw support bearings 7602030TVP are assembled in a double DF arrangement and clamped together with six M8 cover screws.

$$F_z = 6 \cdot F_V = 6 \cdot 2\,900 = 17\,400 \quad [\text{N}]$$



$$M = \frac{F_z}{n} \cdot f = \frac{17\,400}{6} \cdot 1.55 = 4\,495 \quad [\text{Nmm}]$$

$$\approx 4.5 \quad [\text{Nm}]$$

The recommended tightening torque for the screws is usually much larger than that of the torque M associated with the clamping force F_z . The cover is therefore to be designed so that the cover flange face is flush with the housing face when the clamping force F_z is reached. This can be achieved by the following method :

- Calculate torque M .
- Tighten cover screws working across to $(2...3) \cdot M$. (This settles the bearings in the housing seat).
- Loosen cover screws.
- Tighten cover screws across to the calculated torque M .

18: Required Clamping Force F_z

Bearing arrangement			
F_z [N]	$3 \cdot F_V$	$4 \cdot F_V$	$6 \cdot F_V$

F_V = Preload, obtained from bearing tables on pages 39 and 40.

19: Conversion factors for various thread sizes.

Thread	M5	M6	M8	M10	M12	M14	M16
Factor f	0.98	1.18	1.55	1.9	2.35	2.7	3.05

- Measure clearance between the cover flange and housing face.
- Regrind cover to compensate for clearance, or take up the gap with a shim.
- Tighten cover using torque values recommended by the screw manufacturer.

Tolerances for Super Precision Bearings

Tolerances for Super Precision Bearings

Tolerances per DIN ISO 1132, DIN 620

Bore diameter

$$\Delta_{dmp} = d_{mp} - d$$

Deviation of the mean bore diameter from nominal dimension

Outside diameter

$$\Delta_{Dmp} = D_{mp} - D$$

Deviation of the mean outside diameter from nominal dimension

Width

$$\Delta_{B_s} = B_s - B, \Delta_{C_s} = C_s - C$$

Deviation of a single inner ring width and outer ring width from nominal dimension

$$\Delta_{H_s} = H_s - H,$$

$$\Delta_{H_{1s}} = H_{1s} - H_1, \Delta_{H_{2s}} = H_{2s} - H_2, \dots$$

Deviation of the overall width of a double direction thrust bearing from nominal dimension

Running accuracy

K_{ia} = Radial runout of the inner ring of a complete bearing

K_{ea} = Radial runout of the outer ring of a complete bearing

S_d = Axial runout of the inner ring face to the bore

S_{ia} = Axial runout of the inner ring face to the raceway of a complete bearing

S_D = Variation in inclination of outside cylindrical surface to outer ring side face (side runout)

S_{ea} = Axial runout of the outer ring face to the raceway of a complete bearing

S_i = Variation of a single inner ring width of a double direction thrust bearing

S_e = Variation of the outer ring width of a double direction thrust bearing

Tolerances for Super Precision Bearings

20: Tolerances for inner rings of FAG Spindle Bearings and Angular Contact Thrust Ball Bearings

Inner Ring		Dimensions in mm										
Nominal Bearing bore diameter	over to	10	10	18	30	50	80	120	150	180	250	315
		10	18	30	50	80	120	150	180	250	315	400
Spindle Bearings all Series (P4S)		Tolerance values in μm										
Δ_{dmp}		-4	-4	-5	-6	-7	-8	-10	-10	-12	-15	-19
Δ_{Bs}		-250	-250	-250	-250	-250	-380	-380	-380	-500	-500	-630
K_{ia}		1.5	1.5	2.5	2.5	2.5	2.5	2.5	5	5	6	7
S_{d}		1.5	1.5	1.5	1.5	1.5	2.5	2.5	4	5	6	7
S_{ia}		1.5	1.5	2.5	2.5	2.5	2.5	2.5	5	5	7	9
Ball Screw Support Bearings (P4)												
Δ_{dmp}				-5	-6	-7	-8					
Δ_{Bs}				-250	-250	-250	-380					
S_{ia}				2	2	3	3					
Double Direction Angular Contact Thrust Ball Bear.												
Δ_{dmp}	SP			-8	-10	-12	-15	-18	-18	-22	-25	-30
	UP			-6	-8	-9	-10	-13	-13	-15	-18	-23
S_{i}	SP			3	3	4	4	5	5	5	7	7
	UP			1.5	1.5	2	2	3	3	3	4	4
Δ_{Hs}	SP and			50	75	100	125	150	150	175	200	250
	UP			-150	-200	-250	-300	-350	-350	-400	-450	-600

21: Tolerances for outer rings of FAG Spindle Bearings and Angular Contact Thrust Ball Bearings

Outer Ring		Dimensions in mm											
Nominal bearing outside diameter	over to	18	18	30	50	80	120	150	180	250	315	400	500
		18	30	50	80	120	150	180	250	315	400	500	630
Spindle Bearings all Series (P4S)		Tolerance values in μm											
Δ_{Dmp}		-4	-5	-6	-7	-8	-9	-10	-11	-13	-15	-18	-22
K_{ea}		1.5	2.5	2.5	4	5	5	5	7	7	8	9	11
S_{D}		1.5	1.5	1.5	1.5	2.5	2.5	2.5	4	5	7	8	9
S_{ea}		1.5	2.5	2.5	4	5	5	5	7	7	8	10	12
Ball Screw Support Bearings (P4)													
Δ_{Dmp}				-6	-7	-8	-9	-10	-11				
S_{ea}				2	3	3	4	4	4				
Double Direction Angular Contact Thrust Ball Bear.													
Δ_{Dmp}	SP and			-24	-28	-33	-33	-37	-41	-46	-50	-55	
	UP			-43	-50	-58	-58	-66	-73	-82	-90	-99	
S_{e}	SP			4	4	5	5	5	7	7	8	9	
	UP			2	2	3	3	3	4	4	4	4	

Tolerances for Super Precision Bearings

22: Tolerances for inner rings of FAG Cylindrical Roller Bearings with tapered bore. The values in brackets apply to single row bearings.

Inner Ring Nominal bearing bore diameter	over to	Dimensions in mm								
		18 30	30 50	50 80	80 120	120 180	180 250	250 315	315 400	400 500
Cylindrical Roller Bear. with Tapered Bore		Tolerance values in μm								
Tolerance Class SP										
Δ_{ds}		+10	+12	+15	+20	+25	+30	+35	+40	+45
Δ_{Bs}		-100	-120	-150	-200	-250	-300	-350	-400	-450
K_{ia}		3	4	4	5	6	8	8	10	10
S_d		8 (3)	8 (3)	8 (4)	9 (4)	10 (5)	11 (6)	13 (6)	15 (7)	17
S_{ia}		8	8	8	9	10	13	15	20	23
Tolerance Class UP										
Δ_{ds}		+6	+7	+8	+10	+12	+14	+15	+17	+19
Δ_{Bs}		-25	-30	-40	-50	-60	-75	-100	-100	-100
K_{ia}		1.5	2	2	3	3	4	4	5	5
S_d		3	3	4	4	5	6	6	7	8
S_{ia}		3	3	3	4	6	7	8	9	10

23: Tolerances for outer rings of FAG Cylindrical Roller Bearings with tapered bore

Outer Ring Nominal bearing outside diameter	over to	Dimensions in mm									
		50 80	80 120	120 150	150 180	180 250	250 315	315 400	400 500	500 630	630 800
Cylindrical Roller Bear. with Tapered Bore		Tolerance values in μm									
Tolerance Class SP											
Δ_{Dmp}		-9	-10	-11	-13	-15	-18	-20	-23	-28	-35
K_{ea}		5	6	7	8	10	11	13	15	17	20
S_D		8	9	10	10	11	13	13	15	18	20
S_{ea}		10	11	13	14	15	18	20	23	25	30
Tolerance Class UP											
Δ_{Dmp}		-6	-7	-8	-9	-10	-12	-14	-17	-20	-25
K_{ea}		3	3	4	4	5	6	7	8	9	11
S_D		2	3	3	3	4	4	5	5	6	7
S_{ea}		4	5	6	7	9	9	12	12	14	17

Tolerances for Super Precision Bearings

24: Tolerances for inner ring of Miniature and Instrument and Deep Groove Bearings.

Inner Ring Nominal bearing bore diameter	Dimensions in mm				
	A7P	Abec7			
	M & I	Deep Groove Ball Bearings			
over		10	18	30	
to		10	18	30	50
Series 30	34-36	37-39			
Tolerance in μm					
Δ_{dmp}	-5	-4	-4	-4	-5
Δ_{Bs}	-25	-40	-80	-120	-120
K_{ia}	2.5	2.5	2.5	2.5	3.8
S_{d}	2.5	2.5	2.5	3.8	3.8
S_{ia}	2.5	2.5	2.5	3.8	3.8

25: Tolerances for outer ring of Miniature and Instrument and Deep Groove Bearings.

Outer Ring Nominal bearing bore diameter	Dimensions in mm				
	A7P	Abec 7			
	M & I	Deep Groove Ball Bearings			
over		18	30	50	80
to		30	50	80	120
Series 30	34-36	37-39			
Tolerance in μm					
Δ_{Dmp}	-5	-5	-5	-5	-5
K_{ea}	2.5	4	5	5	5
S_{D}	-5	4	4	4	-5
S_{ea}	-5	-5	-5	-5	-5

Manufacturing Tolerances for Mating Parts

Manufacturing Tolerances for Mating Parts

To achieve satisfactory performance the manufactured quality of the mating parts must match the precision of the bearing.

The tolerances given in the following tables have proven suitable in many applications of super precision bearings. The generally valid rules of bearing engineering such as

- load direction and action
- rotation of the inner or outer rings
- changes of the fits through temperature or centrifugal force must additionally be observed

For miniature and instrument, and deep groove bearings, the guidelines in Tables 26 and 30 apply, but FAG application engineering should be consulted for optimum fits using calibration where necessary.

Bearing Locations

Tolerance Symbol

- d = Dimension of the bearing bore or the smallest tapered bore diameter
- d_1 = Dimension of the largest tapered bore diameter
 $d_1 = d + 1/12 \cdot L$
- L = length of taper = $0.95 \cdot B$
(Bearing width)
- $t_1 \text{ } \text{⧸}$ = Cylindrical form tolerance (DIN ISO 1101)
- $t_2 \text{ } \text{○}$ = Roundness tolerance (DIN ISO 1101)
- $t_3 \text{ } \text{↗}$ = Total axial runout (DIN ISO 1101)
- AT_D = Taper angle tolerance (DIN 7178)
- R_a = Surface roughness (DIN 4768)

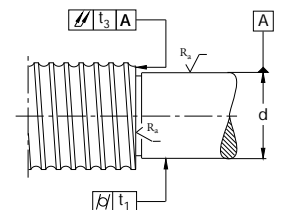
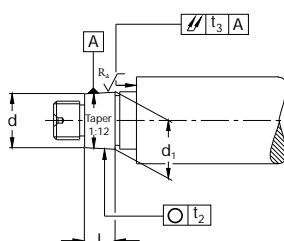
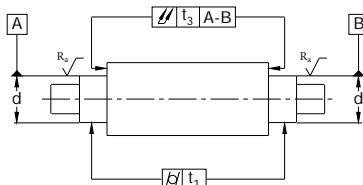

Manufacturing Tolerances for Mating Parts

26: Values for machining of Shafts

Nominal shaft diameter d	over to	Dimensions in mm							
		10	18	30	50	80	120	180	250
M & I, Deep Groove and Spindle Bearings		Tolerance value in μm							
Tolerance of d		+2 -2	+2.5 -2.5	+3 -3	+3.5 -3.5	+4 -4	+5 -5	+6 -6	+7 -7
Cylindrical form	t ₁	0.6	0.8	1	1	1.2	1.5	2	3
Total axial runout	t ₃	1	1.2	1.5	1.5	2	2.5	3.5	4.5
Surface roughness	R _a	0.4	0.4	0.4	0.4	0.4	0.4	0.4	0.4
Ball Screw Support Bearings									
Tolerance of d				0 -9	0 -11	0 -13	0 -15		
Cylindrical form	t ₁			2.5	2.5	3	4		
Total runout	t ₃			2.5	2.5	3	4		
Surface roughness	R _a			0.4	0.4	0.4	0.4		

27: Values for machining of shafts for Double Direction Angular Contact Thrust Ball Bearings

Nominal shaft diameter d	over to	Dimensions in mm							
		30	50	80	120	180	250	315	400
Double Direction Angular Contact Thrust Ball Bearings		Tolerance value in μm							
Tolerance Class SP									
Tolerance of d		0 -6	0 -7	0 -8	0 -10	0 -12	0 -14	0 -16	0 -18
Cylindrical form	t ₁	1	1	1.2	1.5	2	3	4	4.5
Total axial runout	t ₃	1.5	1.5	2	2.5	3.5	4.5	6	7
Surface roughness	R _a	0.4	0.4	0.4	0.4	0.4	0.4	0.8	0.8
Tolerance Class UP									
Tolerance of d		0 -4	0 -4	0 -5	0 -6	0 -8	0 -10	0 -12	0 -13
Cylindrical form	t ₁	0.6	0.6	0.8	1	1.2	2	2.5	3.5
Total axial runout	t ₃	1	1	1.2	1.5	2	3	4	5
Surface roughness	R _a	0.2	0.2	0.2	0.2	0.2	0.2	0.4	0.4

Machining Tolerances for Mating Parts

28: Values for machining of tapered shafts

Nominal shaft diameter d	over to	Dimensions in mm																		
		30	40	50	65	80	100	120	140	160	180	200	225	250	280	315	355	400	450	
Cylindrical Roller Bearing with Tapered Bores		Tolerance value in μm																		
Tolerance Class SP																				
Tolerance of the smallest taper diameter		+73	+91	+108	+135	+159	+193	+225	+266	+298	+328	+370	+405	+445	+498	+548	+615	+685	+767	+847
Roundness t_2		1	1	1	1.2	1.2	1.5	1.5	2	2	2	3	3	3	4	4	5	5	6	6
Total axial runout t_3		1.5	1.5	1.5	2	2	2.5	2.5	3.5	3.5	3.5	4.5	4.5	4.5	6	6	7	7	8	8
Surface roughness R_a		0.2	0.2	0.2	0.2	0.2	0.2	0.2	0.2	0.2	0.2	0.2	0.2	0.2	0.4	0.4	0.4	0.4	0.4	0.4
Tolerance Class UP																				
Tolerance of the smallest taper diameter		+73	+91	+108	+135	+159	+193	+225	+266	+298	+328	+370	+405	+445	+498	+548	+615	+685	+767	+847
Roundness t_2		0.6	0.6	0.6	0.8	0.8	1	1	1.2	1.2	1.2	2	2	2	2.5	2.5	3	3	4	4
Total axial runout t_3		1	1	1	1.2	1.2	1.5	1.5	2	2	2	3	3	3	4	4	5	5	6	6
Surface roughness R_a		0.2	0.2	0.2	0.2	0.2	0.2	0.2	0.2	0.2	0.2	0.2	0.2	0.2	0.4	0.4	0.4	0.4	0.4	0.4

29: Deviation of the taper angle

Nominal length of taper	Dimensions in mm											
	>16...25	>25...40	>40...63	>63...100	>100...160	>160...250						
Deviation of the Taper Angle												
Tolerance Class SP												
AT_D	+2	+3.2	+2.5	+4	+3.2	+5	+4	+6.3	+5	+8	+6.3	+10
Tolerance Class UP												
AT_D	+1.3	+2	+1.6	+2.5	+2	+3.2	+2.5	+4	+3.2	+5	+4	+6.3

Housing Bores

Tolerance Symbol

- D = Nominal diameter of the housing bore
- t_1 H = Cylindrical form tolerance (DIN ISO 1101)
- t_2 A = Axial runout tolerance (DIN ISO 1101)
- t_3 A = Total axial runout tolerance (DIN ISO 1101)
- t_4 A = Coaxiality tolerance (DIN ISO 1101)
- R_a = Surface roughness (DIN 4768)

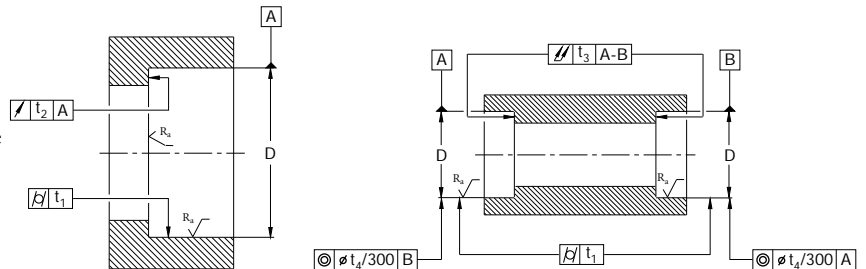

Manufacturing Tolerances for Mating Parts

30: Values for machining of housing bores

Nominal housing bore diameter D	over to	Dimensions in mm										
		10	18	30	50	80	120	180	250	315	400	500
		18	30	50	80	120	180	250	315	400	500	600
Spindle Bearings		Tolerance values in μm										
Tolerance of D	fixed bear.	+3	+4	+4	+5	+6	+8	+10	+12	+13		
	loose bear.	-2	-2	-3	-3	-4	-4	-4	-4	-5		
		+7	+8	+10	+11	+14	+17	+21	+24	+27		
		+2	+2	+3	+3	+4	+5	+7	+8	+9		
Cylindrical form	t_1	1,5	1,5	1,5	2	2,5	3,5	4,5	6	7		
Total axial runout	t_3	2,0	2,5	2,5	3	4	5	7	8	9		
Coaxiality	t_4	10	10	10	10	10	10	10	10	10		
Surface roughness R_a		0,8	0,8	0,8	0,8	0,8	0,8	0,8	1,6	1,6		
Ball Screw Support Bearings												
Tolerance of D				+10	+13	+16	+18	+22				
				-6	-6	-6	-7	-7				
Cylindrical form	t_1			2,5	3	4	5	7				
Axial runout	t_2			4	5	6	8	10				
Surface roughness R_a				0,8	0,8	0,8	0,8	0,8				
Double Direction Angular Contact Thrust Ball Bear.												
Tolerance Class SP												
Tolerance of D				+3	+2	+3	+2	+3	+3	+2	0	
				-10	-13	-15	-18	-20	-22	-25	-30	
Cylindrical form	t_1			2	2,5	3,5	4,5	6	7	8	12	
Total axial runout	t_3			2	2,5	3,5	4,5	6	7	8	12	
Surface roughness R_a				0,8	0,8	0,8	0,8	1,6	1,6	1,6	3,2	
Tolerance Class UP												
Tolerance of D				+1	+1	+1	0	0	+1	0	0	
				-7	-9	-11	-14	-16	-17	-20	-24	
Cylindrical form	t_1			1,2	1,5	2	3	4	5	6	7	
Total axial runout	t_3			1,2	1,5	2	3	4	5	6	7	
Surface roughness R_a				0,4	0,4	0,4	0,4	0,8	0,8	0,8	1,6	
Cylindrical Roller Bearing												
Tolerance Class SP												
Tolerance of D				+3	+2	+3	+2	+3	+3	+2	0	
				-10	-13	-15	-18	-20	-22	-25	-30	
Cylindrical form	t_1			2	2,5	3,5	4,5	6	7	8	12	
Total axial runout	t_3			3	4	5	7	8	9	10	15	
Coaxiality	t_4			10	10	10	10	10	10	10	10	
Surface roughness R_a				0,8	0,8	0,8	0,8	1,6	1,6	1,6	3,2	
Tolerance Class UP												
Tolerance of D				+1	+1	+1	0	0	+1	0	0	
				-7	-9	-11	-14	-16	-17	-20	-24	
Cylindrical form	t_1			1,2	1,5	2	3	4	5	6	7	
Total axial runout	t_3			2	2	3,5	4,5	6	7	8	12	
Coaxiality	t_4			6	6	6	6	6	6	6	6	
Surface roughness R_a				0,4	0,4	0,4	0,4	0,8	0,8	0,8	1,6	

Manufacturing Tolerances for Mating Parts

31: Abutment dimensions for Miniature and Instrument, Deep Groove Bearings - metric

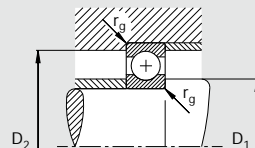

Basic Bearing Number	Shaft D ₁				Housing D ₂				r _g	
	min inch	mm	max inch	mm	min inch	mm	max inch	mm	max inch	mm
S(F)18M1-5SS	0.079	2.01	0.083	2.11	0.135	3.43	0.138	3.50	0.002	0.05
S(F)19M1-5SSY1	0.114	2.90	0.117	2.87	0.165	4.19	0.168	4.26	0.006	0.15
S(F)19M2SS	0.121	3.08	0.126	3.20	0.201	5.11	0.206	5.23	0.006	0.15
S(F)38M2-5SS	0.134	3.41	0.139	3.53	0.208	5.29	0.213	5.41	0.006	0.15
S(F)19M2-5SSY1	0.148	3.76	0.156	3.96	0.220	5.58	0.225	5.71	0.006	0.15
S(F)38M3SS	0.158	4.02	0.163	4.14	0.244	6.20	0.249	6.32	0.006	0.15
S(F)2M3SSY1	0.179	4.55	0.200	5.08	0.320	8.13	0.325	8.25	0.006	0.15
S(F)38M4SS	0.179	4.55	0.200	5.08	0.320	8.13	0.325	8.25	0.006	0.15
S2M4SS	0.244	6.20	0.252	6.40	0.430	10.92	0.446	11.32	0.007	0.18
S19M5SSY1	0.256	6.50	0.310	7.87	0.436	11.07	0.454	11.53	0.006	0.15
S19M6SSY1	0.264	7.22	0.310	7.87	0.436	11.07	0.527	13.40	0.006	0.15
S18M7WY2	0.334	8.48	0.362	9.19	0.480	12.20	0.492	12.50	0.006	0.15

Manufacturing Tolerances for Mating Parts

32: Abutment dimensions for Miniature and Instrument, Deep Groove Bearings - inch

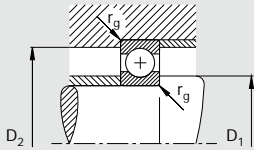

Basic Bearing Number	Shaft				Housing					
	D_1 min inch	mm	max inch	mm	D_2 min inch	mm	max inch	mm	r_g max inch	mm
Barden										
S(F)ROSS	0.071	1.80	0.077	1.95	0.128	3.25	0.132	3.35	0.003	0.08
S(F)1SS	0.079	2.01	0.093	2.36	0.149	3.79	0.164	4.16	0.003	0.08
S(F)R1-4SS	0.102	2.59	0.156	3.96	0.211	5.36	0.226	5.74	0.003	0.08
S(F)R133SS	0.114	2.90	0.117	2.97	0.161	4.09	0.168	4.26	0.003	0.08
S(F)R1-5SS	0.122	3.10	0.165	4.19	0.246	6.25	0.284	7.21	0.005	0.13
SR144SSWX3	0.148	3.76	0.156	3.96	0.217	5.51	0.226	5.74	0.003	0.08
S(F)R144SS	0.148	3.76	0.156	3.96	0.217	5.51	0.226	5.74	0.003	0.08
SR2-5SX2	0.153	3.89	0.165	4.19	0.277	7.04	0.284	7.21	0.003	0.08
SR154SSX1	0.153	3.89	0.156	3.96	0.217	5.51	0.284	7.21	0.003	0.08
S(F)R2-5SS	0.153	3.89	0.165	4.19	0.277	7.04	0.284	7.21	0.003	0.08
SR64SSWX3	0.148	3.76	0.156	3.96	0.217	5.51	0.347	8.81	0.003	0.08
SR2SSX52	0.153	3.89	0.198	5.02	0.304	7.72	0.325	8.25	0.006	0.15
S(F)R2-6SS	0.153	3.89	0.200	5.08	0.326	8.28	0.347	8.81	0.005	0.13
S(F)R2SS	0.179	4.55	0.200	5.08	0.320	8.13	0.325	8.25	0.012	0.30
SR174SSWX5	0.148	3.76	0.156	3.96	0.227	5.77	0.341	8.66	0.003	0.08
SR174SSX2	0.179	4.55	0.198	5.02	0.304	7.72	0.375	9.52	0.003	0.08
SR184SSX2	0.148	3.76	0.156	3.96	0.217	5.51	0.446	11.32	0.003	0.08
SR2ASS	0.179	4.55	0.182	4.62	0.320	8.13	0.446	11.32	0.012	0.30
SR1204SSWX1	0.216	5.49	0.235	5.96	0.341	8.66	0.347	8.81	0.003	0.08
S(F)R155SS	0.180	4.57	0.222	5.63	0.286	7.26	0.288	7.31	0.003	0.08
S(F)R156SS	0.210	5.34	0.222	5.63	0.286	7.26	0.288	7.31	0.003	0.08
S(F)R166SS	0.216	5.49	0.235	5.96	0.341	8.66	0.347	8.81	0.003	0.08
SR186SSWX3	0.216	5.49	0.235	5.96	0.341	8.66	0.446	11.32	0.003	0.08
SR186SSX2	0.216	5.49	0.235	5.96	0.341	8.66	0.446	11.32	0.005	0.13
S(F)R3SS	0.244	6.20	0.252	6.40	0.430	10.92	0.446	11.32	0.012	0.30
SR3SSX8	0.244	6.20	0.252	6.40	0.430	10.92	0.678	17.22	0.012	0.30
SR3SSX25	0.244	6.20	0.252	6.40	0.430	10.92	0.799	20.29	0.012	0.30
S(F)R168SS	0.272	6.91	0.284	7.21	0.349	8.86	0.352	8.94	0.003	0.08
S(F)R188SS	0.284	7.22	0.310	7.87	0.436	11.07	0.466	11.83	0.005	0.13
S(F)R4SS	0.310	7.88	0.322	8.17	0.547	13.90	0.565	14.35	0.012	0.30
SR4ASS	0.322	8.18	0.342	8.68	0.646	16.41	0.678	17.22	0.016	0.40
SR4SSX35	0.310	7.88	0.322	8.17	0.547	13.90	0.980	24.89	0.012	0.30
S(F)R1810SSW	0.347	8.82	0.361	9.16	0.465	11.81	0.466	11.83	0.005	0.13
S(F)R6SS	0.451	11.46	0.427	11.98	0.784	19.92	0.799	20.29	0.016	0.40
SR8SS	0.625	15.88	0.682	17.32	1.013	25.73	1.025	26.03	0.016	0.40
SR10SS	0.750	19.05	0.835	21.20	1.215	30.86	1.250	31.75	0.031	0.78

Manufacturing Tolerances for Mating Parts

33: Abutment dimensions for Miniature and Instrument Bearings - separable and non separable - metric and inch

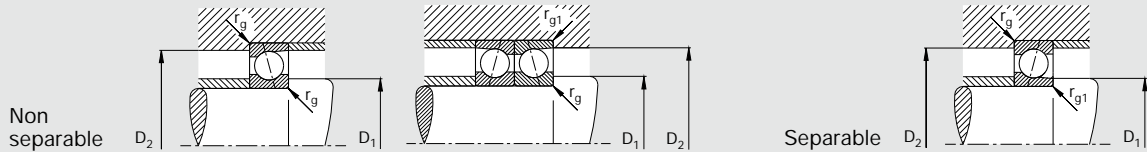

Basic Bearing Number	Shaft D ₁				Housing D ₂				r _g		r _{g1}	
	min inch	mm	max inch	mm	min inch	mm	max inch	mm	max inch	mm	max inch	mm
Separable												
(S)(F)R1-5B	0.122	3.10	0.156	3.96	0.246	6.25	0.284	7.21	0.008	0.2	0.006	0.15
S2M3BY3	0.174	4.42	0.200	5.08	0.292	7.42	0.325	8.25	0.010	0.25	0.006	0.15
(S)(F)R2-5B	0.153	3.89	0.176	4.47	0.261	6.63	0.284	7.21	0.003	0.08	0.003	0.08
(S)(F)R2B	0.179	4.55	0.200	5.08	0.292	7.42	0.325	8.25	0.012	0.3	0.006	0.15
(S)34BX4	0.222	5.64	0.300	7.62	0.492	12.50	0.556	14.12	0.012	0.30	0.005	0.13
(S)(F)R3B	0.244	6.20	0.276	7.01	0.412	10.47	0.446	11.32	0.012	0.30	0.005	0.13
S19M5BY1	0.256	6.50	0.329	8.37	0.420	10.67	0.470	11.95	0.006	0.15	0.003	0.08
(S)34-5B	0.222	5.64	0.300	7.62	0.492	12.50	0.556	14.12	0.012	0.30	0.005	0.13
S19M6BY1	0.300	7.62	0.345	8.78	0.480	12.20	0.528	13.40	0.008	0.20	0.003	0.08
36BX1	0.300	7.62	0.383	9.72	0.596	15.14	0.674	17.12	0.012	0.30	0.005	0.13
(S)(F)R4B	0.310	7.88	0.365	9.27	0.503	12.78	0.565	14.35	0.012	0.30	0.010	0.25
38BX2	0.379	9.63	0.463	11.76	0.692	17.58	0.792	20.11	0.012	0.30	0.005	0.13
Non Separable												
R1-5H	0.122	3.10	0.161	4.08	0.246	6.25	0.284	7.21	0.003	0.08	0.003	0.08
(S)(F)R2-5H	0.153	3.89	0.176	4.47	0.261	6.63	0.284	7.21	0.003	0.08	0.003	0.08
(S)(F)R2-6H	0.153	3.89	0.200	5.08	0.300	7.62	0.347	8.81	0.006	0.15	0.003	0.08
(S)R2H	0.179	4.55	0.200	5.08	0.300	7.62	0.325	8.25	0.012	0.30	0.006	0.15
34H	0.222	5.64	0.295	7.49	0.492	12.50	0.556	14.12	0.012	0.30	0.010	0.25
(S)R3H	0.244	6.20	0.276	7.01	0.412	10.47	0.446	11.32	0.012	0.30	0.005	0.13
34-5H	0.222	5.64	0.295	7.49	0.492	12.50	0.556	14.12	0.012	0.30	0.010	0.25
36H	0.300	7.62	0.383	9.72	0.596	15.14	0.674	17.12	0.012	0.30	0.010	0.25
(S)R4H	0.310	7.88	0.365	9.27	0.503	12.78	0.565	14.35	0.012	0.30	0.010	0.25
(S)38H	0.379	9.63	0.463	11.76	0.692	17.58	0.792	20.11	0.012	0.30	0.010	0.25

Manufacturing Tolerances for Mating Parts

34: Abutment dimensions for Deep Groove Bearings

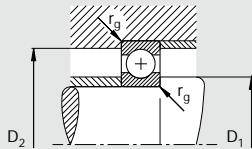

Basic Bearing Number	Shaft		Housing		r_g max
	D_1 min	max	D_2 min	max	
Barden	mm				
(S)34SS	5.64	6.50	13.90	14.12	0.30
(S)34-5SS	5.64	6.50	13.90	14.12	0.30
(S)35SS	6.63	8.68	16.41	17.12	0.30
(S)36SS	7.62	8.68	16.41	17.12	0.30
(S)37SS*	8.64	10.54	18.90	20.11	0.30
37SSTX2*	8.64	10.54	18.90	20.11	0.30
(S)38SS*	9.63	10.54	18.90	20.11	0.30
38SSTX2*	9.63	10.54	18.90	20.11	0.30
38SSTX6*	9.63	10.54	18.90	22.10	0.30
39SS*	11.53	13.89	22.68	23.46	0.30
100SS*	11.81	13.89	22.68	23.46	0.30
100SSTX1*	11.81	13.89	22.68	23.46	0.30
200SS*	13.16	15.14	25.76	26.84	0.63
101(T)	13.80	17.01	23.47	26.18	0.30
101SSTX1*	13.80	16.00	24.90	26.18	0.30
201SS*	15.30	17.14	27.94	28.70	0.63
9201FFT	15.30	17.14	27.94	28.70	0.63
201SSTX1*	16.31	17.14	27.94	28.70	0.63
102T	16.82	20.26	26.75	30.20	0.30
202(T)	18.45	19.17	31.07	31.57	0.63
202SSTX1*	18.45	19.17	31.07	31.57	0.63
103SS*	16.80	21.20	30.86	33.19	0.30
203SS*	20.58	22.60	34.85	36.39	0.63
9203FFT	20.58	22.60	34.85	36.39	0.63
104SST*	22.81	24.91	37.04	39.19	0.63
204SST*	24.82	26.92	40.90	42.18	1.00
9204SST*	24.82	26.92	40.90	42.18	1.00
105SST*	27.82	29.87	42.04	44.19	0.63
205SST*	29.82	31.62	45.72	47.19	1.00
9205FFT	29.82	31.62	45.72	47.19	1.00
106SST*	33.81	36.85	49.51	51.18	1.00
206SST*	35.36	38.10	55.88	56.64	1.00
9206FFT	35.36	38.10	55.88	56.64	1.00
107SS*	39.02	41.14	55.63	57.98	1.00
207SS*	40.92	45.13	64.08	66.06	1.00
208T	46.21	54.10	67.14	73.81	1.00
209T	51.21	58.14	72.39	78.79	1.00
110SST	54.41	56.84	73.87	75.59	1.00

* also applies for Flexeal

Machining Tolerances for Mating Parts

35: Abutment dimensions for Spindle Bearings

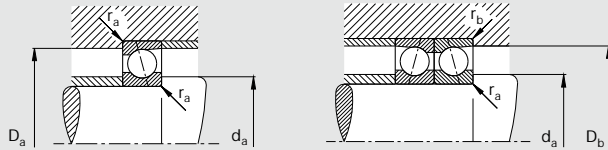

Bore Reference Number	Shaft	Bearing Series B719C/E HSS719C/E HCS719C/E				Bearing Series B70C/E HSS70C/E HCS70C/E				Bearing Series B72C/E			
		d_a	D_a/D_b	r_a	r_b	d_a	D_a/D_b	r_a	r_b	d_a	D_a/D_b	r_a	r_b
		h12	H12	max	max	h12	H12	max	max	h12	H12	max	max
	mm												
6	6					8.5	14.5	0.3	0.1				
7	7					10	16	0.3	0.1				
8	8					11	19	0.3	0.1				
9	9					12	21	0.3	0.1				
00	10	12	19.5	0.3	0.1	12.5	23.5	0.3	0.1	14.5	25.5	0.6	0.6
01	12	14	21.5	0.3	0.1	14.5	25.5	0.3	0.1	16.5	27.5	0.6	0.6
02	15	17	25.5	0.3	0.1	17.5	29	0.3	0.1	19.5	30.5	0.6	0.6
03	17	19	27.5	0.3	0.1	20	32	0.3	0.1	22.5	34.5	0.6	0.6
04	20	22	33.5	0.3	0.1	25	37	0.6	0.3	26.5	40.5	1	1
05	25	27	38.5	0.3	0.1	30	42	0.6	0.3	31.5	45.5	1	1
06	30	32	43.5	0.3	0.1	36	49	1	0.3	37.5	54.5	1	1
07	35	40	50.5	0.6	0.1	41	56	1	0.3	44	63	1	1
08	40	45	57.5	0.6	0.1	46	62	1	0.3	48	72	1	1
09	45	50	63.5	0.6	0.1	51	69	1	0.3	52.5	78	1	1
10	50	55	67.5	0.6	0.1	56	74	1	0.3	57	83	1	1
11	55	60	75.5	0.6	0.3	62	83	1	0.6	63	92	1.5	1.5
12	60	65	80.5	0.6	0.3	67	88	1	0.6	69.5	101.5	1.5	1.5
13	65	70	85.5	0.6	0.3	72	93	1	0.6	75.5	109.5	1.5	1.5
14	70	76	94.5	0.6	0.3	77	102	1	0.6	80	115	1.5	1.5
15	75	81	99.5	0.6	0.3	82	107	1	0.6	85	120	1.5	1.5
16	80	86	104	0.6	0.3	88	117	1	0.6	91	129	2	2
17	85	92	114	0.6	0.6	93	122	1	0.6	98	138	2	2
18	90	97	119	0.6	0.6	100	131	1.5	0.6	104	147	2	2
19	95	102	124	0.6	0.6	105	136	1.5	0.6	110.5	154	2	2
20	100	107	133	0.6	0.6	110	141	1.5	0.6	114.5	165.5	2.1	2.1
21	105	112	138	0.6	0.6	116	150	2	1	120.5	174.5	2.1	2.1
22	110	117	143	0.6	0.6	121	159	2	1	126.5	183.5	2.1	2.1
24	120	128	157	0.6	0.6	131	169	2	1	140	195	2.1	2.1
26	130	139	171	0.6	0.6	142	189	2	1	148	211.5	2.5	2.5
28	140	149	181	0.6	0.6	152	199	2	1	163	226.5	2.5	2.5
30	150	160	199	1	1	163	213	2.1	1	178	241.5	2.5	2.5
32	160	170	209	1	1	174	228	2	1	191	259	2.5	2.5
34	170	180	219	1	1	185	246	2	1	205	275	3	3
36	180	192	238	1	1	196	264	2	1	213.5	286.5	3	3
38	190	202	247	1	1	206	274	2	1	223.5	306.5	3	3
40	200	214	266	1	1	217	293	2	1	238.5	321.5	3	3
44	220	234	286	1	1	239	321	2.5	1	264	356	3	3
48	240	254	307	1	1	260	341	2.5	1				

Machining Tolerances for Mating Parts

36: Abutment dimensions for Ball Screw Support Bearings

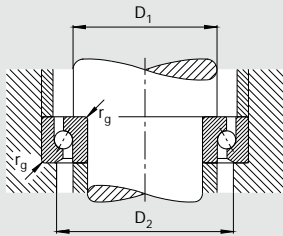

Bore	Shaft	Bearing Series 7602			Bearing Series 7603			Bearing Number	Bearing Series BSB		
		D ₁ min	D ₂ min	r _g max	D ₁ min	D ₂ min	r _g max		D ₁ min	D ₂ min	r _g max
mm											
12	12	17	27	0.6				BSB020047T	27.5	39.5	1
15	15	20.5	30	0.6				BSB025062T	38	52	1.1
17	17	23	34.5	0.6				BSB030062T	39.5	52.5	1
20	20	27.5	39.5	1	30.5	43.5	1	BSB035072T	46.5	60.5	1.1
25	25	32	45	1	38	52	1	BSB040072T	49	62.5	1.1
30	30	39.5	52.5	1	45	61	1	BSB040090T	56.5	75.5	1.5
35	35	46.5	60.5	1	51	67	1.5	BSB045075T	52	68	1.1
40	40	53.5	69.5	1	56.5	75.5	1.5	BSB045100T	64.5	85.5	1.5
45	45	57	73	1	64.5	85.5	1.5	BSB050100T	64.5	85.5	1.5
50	50	63	79	1	72	94	2	BSB055090T	65	80	1.1
55	55	69.5	85.5	1.5	77	101	2	BSB055120T	77	97.5	2
60	60	77	96	1.5	82.5	107.5	2.1	BSB060120T	79.5	100.5	1.5
65	65	84	103	1.5	91.5	118.5	2.1	BSB075110T	85	99.5	1.5
70	70	87	108	1.5	95.5	124.5	2.1	BSB100150T	114.5	135	2
75	75	93.5	114.5	1.5	105.5	135.5	2.1				
80	80	100	122	2	111	143	2.1				
85	85	107	131	2	116	151	2.5				
90	90	113.5	138.5	2	122.5	157.5	2.5				
95	95	119.5	146.5	2.1	130	165	2.5				
100	100	125.5	154.5	2.1	140	178	2.5				

Machining Tolerances for Mating Parts

37: Abutment dimensions for Double Direction Angular Contact Thrust Ball Bearings

Bore Reference Number	Shaft		Bearing Series			
	2344	2347	2344 2347 D ₁	D ₂	r _g max	r _{g1} max
mm						
06	30	32	40.5	50.5	1	0.15
07	35	37	46.5	57	1	0.15
08	40	42	51.5	63.5	1	0.15
09	45	47	57.5	70	1	0.15
10	50	52	62.5	75	1	0.15
11	55	57	69	84.5	1	0.3
12	60	62	74	89.5	1	0.3
13	65	67	79	94.5	1	0.3
14	70	73	86.5	103.5	1	0.3
15	75	78	91.5	108.5	1	0.3
16	80	83	98.5	117	1	0.3
17	85	88	103.5	122	1	0.3
18	90	93	110.5	130.5	1.5	0.3
19	95	98	115.5	135.5	1.5	0.3
20	100	103	120.5	140.5	1.5	0.3
21	105	109	128	150	2	0.6
22	110	114	134.5	160	2	0.6
24	120	124	144.5	170	2	0.6
26	130	135	159	188	2	0.6
28	140	145	169	198	2.1	0.6
30	150	155	181	211.5	2.1	0.6
32	160	165	192.5	226	2.1	0.6
34	170	176	206.5	245	2.1	0.6
36	180	187	221	263	2.1	0.6
38	190	197	231	273	2.1	0.6
40	200	207	245	291.5	2.1	0.6
44	220	228	269	318	2.5	1
48	240	248	289	338	2.5	1
52	260	269	317.5	374.5	3	1.5
56	280	289	337.5	394.5	3	1.5
60	300	310	366	428.5	3	1.5
64	320	330	386	448.5	3	1.5
68	340	350	413	485.5	3	1.5
72	360	370	433	505.5	3	1.5
76	380	390	453	525.5	3	1.5
80	400	410	480.5	561.5	3	1.5

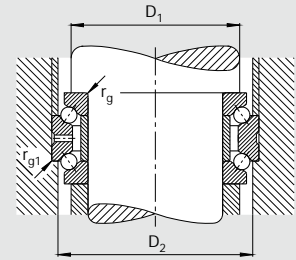

Machining Tolerances for Mating Parts

38: Abutment dimensions for Cylindrical Roller Bearings

Bore Reference Number	Shaft mm	Bearing Series N10K			Bearing Series NN30ASK			
		D ₁ min	D ₅ min	r _{g1} max	D ₁ min	D ₅ min	D ₅ max	r _g max
06	30	33.5	49	0.6	35	49	50	1
07	35	38.5	56	0.6	40	56	57	1
08	40	43.5	62	0.6	45	62	63	1
09	45	48.5	69	0.6	50	69	70	1
10	50	53.5	74	0.6	55	74	75	1
11	55	61	82	1	61	82	84	1
12	60	66	87	1	66	87	89	1
13	65	71	92	1	71	92	94	1
14	70	76	102	1	76	102	104	1
15	75	81	107	1	81	107	109	1
16	80	86	115	1	86	115	119	1
17	85	91	120	1	91	120	124	1
18	90	97	129	1	97	129	133	1.5
19	95	102	134	1	102	134	138	1.5
20	100	107	139	1	107	139	143	1.5
21	105	114	148	1	114	148	151	2
22	110	118	157	1	119	157	161	2
24	120	129	167	1	129	167	171	2
26	130	139	184	1	139	184	191	2
28	140	149	194	1	149	194	201	2
30	150	160.5	208	1.5	160	208	215	2.1
32	160	170.5	222	1.5	170	222	230	2.1
34	170	180.5	239	2.1	180	239	250	2.1
36	180	190.5	258	2.1	190	258	270	2.1
38	190	200.5	268	2.1	200	268	280	2.1
40	200	210.5	285	2.1	210	285	300	2.1
44	220	232.5	313	2.5	232	313	328	2.5
48	240	252.5	334	2.5	252	334	348	2.5
52	260	275	368	3	275	368	385	3
56	280	295	388	3	295	388	405	3
60	300	315	422	3	315	422	445	3
64	320	335	442	3	335	442	465	3
68	340	358	477	4	358	477	502	4
72	360	378	497	4	378	497	522	4
76	380	398	517	4	398	517	542	4
80	400	418	553	4	418	553	582	4
84	420	438	573	4	438	573	602	4
88	440	463	601	5	463	601	627	5
92	460	483	628	5	483	628	657	5
96	480	503	648	5	503	648	677	5
/500	500	523	668	5	523	668	697	5

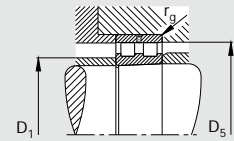
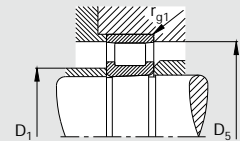

Attainable Speeds

Attainable Speeds

The speed attained with a bearing arrangement is dependant upon the total energy balance in the system. The deciding factors are, the number of bearings, their arrangement, internal loads (play or preload), external loads and lubrication on the one hand, and heat removal on the other. The values listed in the dimensional tables are a guide which may, depending upon the above mentioned conditions, be corrected up or down.

Spindle Bearings

The attainable speeds listed in the dimensional tables serve as a guide to the speedability of elastically (spring) preloaded single bearings. When solidly preloaded bearings, pairs or sets are installed, these speeds cannot be achieved. The speed reduction factors are shown in table 39.











Ball Screw Support Bearings of the Series 7602.., 7603.. and BSB..

The attainable speeds for grease lubricated bearings are shown in the dimensional tables. The values listed apply for both DB and DF arrangement. For other arrangements, use the reduction factors listed in table 40.





Cylindrical Roller Bearings

For cylindrical roller bearings the attainable speed is determined by the adjusted radial play. Approximate values are given in table 41.

39: Speed reduction ($n^* \cdot f_r$) for Spindle Bearing and Deep Groove Bearing sets

Bearing Arrangement		Factor f_r Bearing Preload		
		L	M	H
		0.85	0.75	0.5
		0.8	0.7	0.5
		0.75	0.6	0.35
		0.65	0.5	0.3
		0.65	0.5	0.3

40: Speed reduction for Ball Screw Support Bearing sets

Bearing Arrangement	Attainable Speed
	$1.0 \cdot n^*$
	$0.70 \cdot n^*$
	$0.85 \cdot n^*$
	$0.65 \cdot n^*$

41: Speed n for Cylindrical Roller Bearings

Operating Clearance/Preload	Attainable Speed
0...5	$1...1.1 \cdot n^*$
-5...0	$0.8...1 \cdot n^*$

* Speed from dimensional bearing tables.

Deflection and Rigidity

Deflection and Rigidity

A higher running accuracy, particularly under variable loading, is achieved with bearing arrangements having no free play. Depending upon loading and rigidity requirements the bearings should be suitably preloaded. The rigidity can be increased by the use of sets.

Spindle Bearings

The values of axial rigidity listed in tables 47-50 apply for pairs of bearings assembled DB or DF.





The approximate radial rigidity can be calculated using a factored value of axial rigidity.

$$S_r \approx 6 \cdot S_a \text{ for } \alpha = 15^\circ$$



$$S_r \approx 2 \cdot S_a \text{ for } \alpha = 25^\circ$$

For sets of more than two bearings the rigidity values will be increased. Table 42 shows the calculation of axial rigidity for centrally acting axial loads. Table 43 shows the calculation of radial rigidity with the radial load acting mid set.

42: Axial rigidity S_a' of a bearing set under a centrally acting axial load.

Bearing Arrangement	Set Nomenclature	S_a' N/ μ m	K_{aE} $\alpha = 15^\circ$ and $\alpha = 25^\circ$ N
	DB	$S_a^{1)}$	$3 \cdot F_V$
	TBT	$1.64 \cdot S_a$	$6 \cdot F_V$
	QBC	$2 \cdot S_a$	$6 \cdot F_V$
	QBT	$2.24 \cdot S_a$	$9 \cdot F_V$
K_{ae} = unloading force		F_V = Preload value	¹⁾ Tables 47-50

43: Radial Rigidity S_r of a bearing set; the radial load acting mid-set





Bearing Arrangement	Set Nomenclature	S_r' N/ μ m
	DB	S_r
	QBC	$2 \cdot S_r$
	TBT	$1.36 \cdot S_r$

Deflection and Rigidity

Ball Screw Support Bearings of the Series 7602, 7603 and BSB

The Axial rigidity values of popular bearing arrangements for ball screw support both DF and DB as shown in Table 44.

44: Axial rigidity S_a and unloading force K_{aE} for Ball Screw Support Bearings

Basic Bearing Number	Bearing Arrangement									
										
FAG	S_a kN/ μ m	K_{aE} kN	S_a kN/ μ m	K_{aE} kN	S_a kN/ μ m	K_{aE} kN	S_a kN/ μ m	K_{aE} kN	S_a kN/ μ m	K_{aE} kN
7602012TVP	0.5	4	1	8	1.45	12	1.95	16		
7602015TVP	0.55	3.5	1.05	7.5	1.55	11	2.1	15		
7602017TVP	0.6	5	1.2	10	1.8	15	2.4	20		
7602020TVP	0.75	6.5	1.45	13	2.15	19.5	2.85	26.5		
7602025TVP	0.8	7	1.55	14.5	2.35	21.5	3.1	29		
7602030TVP	0.9	8	1.8	16.5	2.7	25	3.6	33.5		
7602035TVP	1.05	9.5	2.05	19	3.1	28.5	4.1	38.5		
7602040TVP	1.2	12.5	2.4	25	3.6	37	4.8	49.5		
7602045TVP	1.25	13	2.5	26	3.75	39	5	52		
7602050TVP	1.4	14	2.75	28.5	4.1	42.5	5.45	57		
7602055TVP	1.4	13	2.8	26	4.2	39.5	5.6	52.5		
7602060TVP	1.65	18.5	3.25	37	4.9	56	6.5	74.5		
7602065TVP	1.8	20	3.55	40	5.3	60.5	7.05	80.5		
7602070TVP	1.8	20	3.55	40	5.3	60.5	7.05	80.5		
7602075TVP	1.9	21.5	3.8	43.5	5.7	65	7.6	87		
7602080TVP	2.05	25.5	4.1	51.5	6.15	77	8.2	103		
7602085TVP	2.25	30	4.45	60	6.65	90.5	8.85	120.5		
7602090TVP	2.3	31	4.55	62	6.85	93	9.1	124		
7602095TVP	2.45	35.5	4.9	71.5	7.35	107	9.75	143		
7602100TVP	2.6	40.5	5.2	81.5	7.8	122.5	10.4	163		
7602110TVP	2.85	47	5.65	94.5	8.5	142	11.3	189.5		
7602120TVP	3.15	59	6.3	118	9.45	177.5	12.6	236.5		
7602130TVP	3.3	59	6.6	118.5	9.9	178	13.15	237.5		
7603020TVP	0.8	8	1.6	16.5	2.4	24.5	3.15	33		
7603025TVP	0.95	9.5	1.85	19	2.75	28.5	3.7	38		
7603030TVP	1.1	12	2.15	24.5	3.25	37	4.3	49.5		
7603035TVP	1.2	13.5	2.4	27.5	3.6	41	4.8	55		
7603040TVP	1.3	16	2.6	32.5	3.9	48.5	5.2	65		
7603045TVP	1.5	20	2.95	40	4.45	60	5.9	80		
7603050TVP	1.65	21.5	3.25	43.5	4.85	65.5	6.45	87		
7603055TVP	1.75	25	3.45	50.5	5.2	76	6.9	101		
7603060TVP	1.85	28.5	3.7	57.5	5.55	86.5	7.4	115.5		
7603065TVP	2.1	34	4.15	68.5	6.2	103	8.25	137.5		
7603070TVP	2.15	35	4.25	70.5	6.35	106	8.45	141.5		
7603075TVP	2.35	41.5	4.7	83	7.05	125	9.35	166.5		
7603080TVP	2.5	46.5	4.95	93	7.4	139.5	9.9	186		
7603085TVP	2.55	50.5	5.1	101	7.65	151.5	10.2	202.5		
7603090TVP	2.7	52.5	5.35	105.5	8	158.5	10.65	211.5		

Deflection and Rigidity

44: Continued

Basic Bearing Number	Bearing Arrangement							
FAG	S_a kN/ μ m	K_{aE} kN	S_a kN/ μ m	K_{aE} kN	S_a kN/ μ m	K_{aE} kN	S_a kN/ μ m	K_{aE} kN
7603095TVP	2.8	55	5.55	110.5	8.35	165.5	11.1	220.5
7603100TVP	3	62	5.95	124	8.9	186.5	11.9	248.5
7603110TVP	3.4	84.5	6.75	169	10.1	253.5	13.5	338
7603130TVP	3.85	97	7.65	194	11.45	291.5	15.25	388.5
BSB045075T	1.1	9	2.15	18	3.25	27	4.3	36
BSB055090T	1.25	10.5	2.5	20.5	3.75	31	5	41.5
BSB100150T	2.1	21.5	4.15	43	6.2	64.5	8.25	86
BSB020047T	0.75	65	1.45	13	2.15	19.5	2.85	26.5
BSB030062T	0.9	8	1.8	16.5	2.7	25	3.6	33.5
BSB035072T	1.05	9.5	2.05	19	3.1	28.5	4.1	38.5
BSB025062T	0.95	9.5	1.85	19	2.75	28.5	3.7	38
BSB040090T	1.3	16	2.6	32.5	3.9	48.5	5.2	65
BSB045100T	1.5	20	2.95	40	4.45	60	5.9	80
BSB055120T	1.6	19.5	3.15	39	4.7	58.5	6.25	78
BSB040072T	1.05	8	2.05	16.5	3.05	25	4.1	33
BSB050100T	1.5	20	2.95	40	4.45	60	5.9	80
BSB060120T	1.65	20	3.25	40.5	4.9	61	6.5	81.5
BSB075110T	1.55	12.5	3.1	25.5	4.65	38.5	6.15	51.5

Deflection and Rigidity

Double Direction Angular Contact Thrust Ball Bearings of series 2344..

$$\delta_a = F_{ax}/S_a$$

δ_a = axial deflection [μm]

F_a = axial load [N]

S_a = axial rigidity [N/ μm]

These values apply up to an axial load equivalent to 2.2 % of the dynamic capacity C.

45: Axial rigidity S_a of Double Direction Angular Contact Thrust Ball Bearings

Bore Ref. Number	S_a N/ μm	Bore Ref. Number	S_a N/ μm
05	245	28	1050
06	275	30	1100
07	315	32	1150
08	355	34	1250
09	385	36	1300
10	410	38	1400
11	455	40	1450
12	455	44	1600
13	500	48	1700
14	550	52	1800
15	590	56	1900
16	640	60	2000
17	640	64	2150
18	710	68	2250
19	720	72	2300
20	740	76	2450
21	770	80	2550
22	850		
24	900		
26	970		

Cylindrical Roller Bearings

$$\delta_r = F_r/C_s$$

δ_r = radial deflection [μm]

F_r = radial load [N]

C_s = radial rigidity [N/ μm]

46: Radial rigidity of Cylindrical Roller Bearings

Bore Ref. Number	C_s N10.. N/ μm	C_s NN30..	Bore Ref. Number	C_s N10.. N/ μm	C_s NN30..
05		570	28	1480	3090
06	330	680	30	1630	3300
07	410	790	32	1680	3510
08	440	950	34	1860	3770
09	500	1080	36	1960	4040
10	580	1180	38	2040	4190
11	650	1300	40	2130	4410
12	710	1410	44	2360	4770
13	740	1470	48	2560	5140
14	820	1660	52	2710	5630
15	850	1730	56	2930	5890
16	900	1850	60	3200	5930
17	940	1990	64	3330	6440
18	1030	2020	68	3610	7170
19	1070	2100	72	3750	7430
20	1110	2170	76	3900	7690
21	1160	2320	80	4090	8660
22	1240	2500			
24	1340	2700			
26	1420	2980			

Deflection and Rigidity

47: Axial rigidity S_a for Spindle Bearings in DF or DB arrangement of series B719C, B70C, B72C

Bore Reference Number	Axial Rigidity S_a								
	Series B719C			B70C			B72C		
	Standard preloads			L	M	H	L	M	H
	L	M	H						
N/ μ m									
6				8.6	16.4	25.5			
7				9.3	18.4	28.4			
8				12.0	22.9	34.9			
9				14.4	26.5	39.6			
00	12.5	23.3	35.4	14.1	25.3	37.5	17.4	31.5	47.0
01	14.8	27.3	41.6	15.5	28.1	41.5	18.9	34.1	50.8
02	17.0	31.4	47.4	16.9	30.2	44.6	22.4	40.4	60.2
03	18.1	33.5	50.4	21.3	37.8	55.4	23.7	42.9	63.7
04	24.1	44.0	65.8	22.8	40.0	58.8	27.8	49.4	73.1
05	27.2	49.2	73.3	29.7	51.8	75.7	30.2	53.5	79.0
06	29.7	54.3	80.7	32.7	57.8	85.1	42.1	75.5	112.3
07	36.3	65.1	96.2	38.7	67.8	99.5	46.5	81.3	119.1
08	41.1	72.9	107.4	43.5	76.9	113.2	49.6	86.5	126.5
09	44.4	78.7	116.0	50.2	87.8	128.6	56.4	97.9	142.8
10	46.0	81.4	119.7	52.7	92.0	134.7	60.4	104.4	152.5
11	51.2	90.0	131.9	61.9	107.2	156.5	67.7	116.6	170.0
12	55.0	96.5	141.2	64.5	111.7	162.8	71.4	122.8	178.8
13	56.5	99.4	145.6	67.1	116.1	169.1	79.5	136.2	197.6
14	66.5	115.5	168.2	73.9	127.3	185.1	83.8	143.2	207.6
15	68.5	118.8	172.7	76.8	131.9	191.7	87.8	150.1	217.4
16	70.3	122.0	177.2	86.3	147.5	213.5	94.8	161.2	233.8
17	80.3	138.0	200.0	90.3	154.3	223.1	99.8	169.5	245.6
18	82.3	141.6	204.9	95.8	163.5	236.2	109.7	185.7	267.8
19	84.9	145.9	211.1	99.4	169.3	244.3	115.7	195.6	281.8
20	94.6	161.7	233.7	104.1	177.2	255.8	124.9	211.0	303.8
21	94.6	161.7	233.7	114.3	193.4	278.6	132.0	222.4	320.4
22	96.5	164.8	237.9	119.6	202.1	290.9	132.0	222.4	320.3
24	109.5	186.0	267.5	123.7	208.9	300.3	140.0	233.9	335.7
26	117.5	199.0	285.6	137.9	231.8	332.6	147.9	246.8	353.2
28	124.7	210.9	301.9	142.9	240.1	343.9	155.8	259.6	370.7
30	141.4	237.8	340.6	157.2	263.0	377.6	163.8	272.4	388.5
32	146.1	245.5	351.4	164.1	274.5	393.5	179.9	298.6	425.1
34	154.3	258.7	369.9	171.7	285.2	406.4	190.3	314.3	446.1
36	168.9	282.3	402.7	179.9	298.6	425.1	198.0	326.4	462.3
38	167.2	283.7	407.1	181.9	304.8	435.1	202.3	336.4	477.6
40	180.4	304.6	436.2	193.5	322.1	457.8	211.0	350.6	497.4
44	196.9	331.8	474.0	211.0	350.6	497.4	225.4	371.1	525.7
48	207.8	349.8	499.1	219.7	364.8	517.2			

Deflection and Rigidity

48: Axial rigidity S_a for Spindle Bearings in DF or DB arrangement of series, B719E, B70E, B72E

Bore Reference Number	Axial Rigidity S_a								
	Series B719E			B70E			B72E		
	Standard preloads			L	M	H	L	M	H
	L	M	H						
N/ μm									
6				20.9	36.5	51.4			
7				23.2	40.4	57.1			
8				26.4	47.9	68.6			
9				32.4	56.3	79.0			
00	26.4	47.9	68.5	31.3	54.0	75.3	38.8	66.9	93.6
01	31.3	56.9	81.1	34.4	59.7	83.1	42.1	71.5	99.7
02	35.0	65.2	92.8	37.4	64.8	90.3	50.2	85.3	118.6
03	37.4	69.2	98.1	47.9	81.3	112.6	53.9	90.7	126.0
04	53.6	93.1	130.2	51.7	86.7	119.3	63.0	105.0	145.2
05	59.7	103.9	145.3	67.6	111.9	153.4	68.8	114.2	157.7
06	65.2	114.6	160.3	74.1	124.1	171.3	94.8	157.3	217.9
07	80.1	137.6	191.3	88.4	146.9	202.1	107.0	173.7	237.6
08	91.7	155.3	215.0	99.2	165.8	228.5	114.2	185.5	253.8
09	99.2	168.8	233.6	115.5	190.0	260.6	131.3	211.8	289.1
10	103.1	175.1	242.3	120.4	198.1	271.5	139.2	224.3	306.1
11	115.5	194.2	267.4	142.4	231.6	316.4	156.8	251.4	341.5
12	124.4	209.2	287.9	147.9	240.4	328.4	165.9	265.8	360.8
13	127.1	214.0	294.5	155.1	252.3	344.4	186.1	296.4	402.5
14	151.6	250.6	342.8	170.1	274.3	373.5	194.9	310.5	421.0
15	156.2	258.3	353.3	177.7	286.7	389.8	204.9	326.6	442.6
16	160.9	266.0	363.7	201.7	323.3	437.9	222.2	351.3	475.0
17	185.3	301.8	411.4	210.6	337.5	457.1	234.3	370.6	500.9
18	190.3	310.5	422.9	223.6	356.6	482.2	258.6	406.9	549.2
19	196.4	320.5	436.5	234.4	373.7	505.1	274.2	431.5	582.0
20	219.8	355.1	481.6	243.1	387.4	523.6	297.0	465.0	626.1
21	219.8	355.1	481.6	270.9	428.4	578.2	313.5	490.7	660.3
22	226.3	365.8	496.2	281.3	444.8	600.0	311.0	486.8	654.6
24	256.2	411.5	555.9	291.7	461.2	621.8	335.4	522.0	699.7
26	275.6	439.7	593.2	327.9	515.3	692.2	355.2	552.6	740.1
28	293.3	467.9	630.8	340.3	534.9	718.2	374.8	582.4	780.4
30	332.6	525.8	707.9	373.2	583.4	782.8	391.6	607.6	814.2
32	342.8	541.8	729.2	386.8	604.6	810.7	430.4	668.0	894.5
34	365.5	577.8	777.2	411.2	637.9	854.5	454.6	702.4	936.0
36	403.5	633.6	849.1	430.4	668.0	894.5	477.2	737.1	981.7
38	390.1	630.2	851.6	430.9	680.6	915.2	484.1	759.4	1016.1
40	424.3	679.6	916.6	462.5	725.5	971.1	505.7	793.3	1061.0
44	463.3	741.8	999.9	505.7	793.3	1061.0	542.6	843.8	1127.0
48	489.6	784.5	1057.1	523.7	821.7	1098.4			

Deflection and Rigidity

49: Axial rigidity S_a for Spindle Bearings in DF or DB arrangement of series HSS719C/E, HSS70C/E

Bore Reference Number	Axial Rigidity S_a											
	Series HSS719C			HSS70C			HSS719E			HSS70E		
	Standard preloads			L	M	H	L	M	H	L	M	H
	L	M	H									
N/ μ m												
00	8.9	14.3	19.8	10.7	17.3	24.2	22.0	32.6	42.9	27.2	40.1	52.9
01	9.3	15.2	21.0	10.7	17.3	24.1	23.1	34.5	45.4	27.2	40.2	52.3
02	11.2	18.2	25.4	13.8	22.0	30.4	27.8	42.4	55.7	33.7	50.9	66.7
03	12.1	19.2	26.6	14.3	22.6	31.5	29.7	44.5	58.5	35.7	53.0	69.5
04	14.8	23.6	32.8	19.8	31.5	43.7	37.1	55.3	72.7	49.1	73.6	96.3
05	16.8	26.6	36.8	20.5	32.9	45.3	41.9	62.9	82.4	51.4	76.7	100.3
06	21.1	33.7	46.8	24.2	38.7	53.4	53.1	79.4	103.6	60.8	90.6	118.3
07	24.8	38.9	53.6	27.4	43.1	59.5	61.4	91.7	119.6	67.8	101.5	132.7
08	27.0	42.3	57.7	30.3	47.5	65.2	66.9	99.9	130.0	75.1	112.0	146.4
09	31.0	48.8	67.1	34.3	54.2	74.9	77.5	115.4	150.5	85.7	128.1	167.4
10	32.8	51.4	70.2	36.7	57.7	79.4	82.4	122.5	159.7	91.2	136.2	178.0
11	37.5	59.4	81.8	42.6	67.2	92.4	93.9	140.1	183.1	106.6	159.2	207.9
12	39.8	62.8	86.2	45.4	71.4	98.2	99.7	148.7	193.8	112.7	168.1	219.3
13	41.6	65.6	90.0	48.0	75.5	103.8	104.6	155.7	203.1	119.7	178.3	232.5
14	47.6	75.0	102.6	52.5	82.6	113.5	119.0	176.9	230.7	131.9	196.4	256.2
15	49.8	78.3	107.0	54.0	85.0	116.7	124.8	185.4	241.4	135.8	201.9	263.2
16	52.9	82.6	113.1	59.1	93.2	127.9	131.8	196.3	255.6	147.9	220.0	287.0
17	56.4	88.3	120.7	60.5	95.1	130.2	141.7	210.4	273.8	151.9	226.4	294.9
18	58.2	91.0	124.5	66.1	103.5	141.6	145.7	216.0	281.2	164.4	244.9	318.6
19	60.8	94.8	129.4	67.4	105.5	144.1	152.8	226.9	295.0	169.3	251.8	327.5
20	65.5	102.4	139.7	69.5	108.9	149.0	165.5	245.4	319.2	173.9	258.6	336.2
21	68.3	106.4	144.9	75.9	118.7	162.4	172.2	255.3	331.8	190.6	283.4	368.9
22	71.5	111.7	152.3	78.2	122.3	167.3	180.2	267.6	347.7	195.8	290.9	378.4
24	77.6	121.2	164.9	82.1	128.0	175.0	196.3	291.4	378.6	205.8	305.6	397.2
26	82.1	128.1	174.1	92.9	144.9	197.6	208.3	308.9	400.9	233.4	346.6	450.6
28	85.8	133.3	181.2	97.0	151.2	205.7	216.2	320.5	415.6	244.5	362.4	470.9
30	97.5	151.6	206.1	103.3	161.4	219.8	246.4	365.3	474.2	259.3	384.6	499.7
32	101.5	157.6	213.9	108.7	169.6	231.0	256.6	380.2	493.5	274.2	406.8	528.0

Deflection and Rigidity

50: Axial rigidity S_a for Spindle Bearings in DF or DB arrangement of series HCS719C/E, HCS70C/E

Bore Reference Number	Axial Rigidity S_a											
	Series HCS719C			HCS70C			HCS719E			HCS70E		
	Standard preloads			L	M	H	L	M	H	L	M	H
	L	M	H									
N/ μ m												
00	8.8	13.5	18.4	10.3	16.5	22.5	20.8	31.9	41.6	26.3	39.7	51.7
01	9.3	14.1	19.4	10.3	16.5	22.5	23.0	34.0	44.4	26.3	39.2	51.2
02	10.8	17.3	23.4	13.5	20.9	28.3	28.5	42.0	54.1	33.9	50.2	65.1
03	11.9	18.3	24.8	14.1	21.4	29.4	29.7	43.8	56.7	35.3	52.3	68.0
04	14.6	22.5	31.0	19.7	30.3	40.9	37.6	54.7	71.4	48.8	72.6	94.2
05	16.7	25.4	34.4	20.3	31.3	42.1	42.6	62.0	80.1	51.3	75.5	98.1
06	21.0	32.6	43.9	23.8	36.9	50.0	53.0	78.3	101.5	60.5	89.6	115.9
07	24.0	37.1	50.1	26.9	41.3	55.7	60.5	90.4	117.1	68.5	100.6	130.2
08	26.4	40.5	54.5	29.6	45.6	61.2	67.0	98.7	127.8	75.1	110.9	143.1
09	30.8	46.9	63.1	33.4	52.1	70.2	77.0	114.4	147.8	85.5	126.1	163.3
10	31.8	49.1	66.2	36.0	55.4	74.7	81.5	120.3	155.8	91.3	134.6	174.3
11	36.8	56.8	76.7	42.1	64.7	87.1	93.6	138.5	179.3	106.7	157.8	203.9
12	39.4	60.5	81.1	44.2	68.5	92.4	98.7	146.0	188.8	113.2	167.1	216.1
13	41.1	63.3	84.9	46.6	72.0	96.7	104.4	154.4	199.1	119.2	176.0	227.1
14	46.9	71.5	96.3	52.0	79.8	107.4	118.8	175.4	226.7	131.8	194.9	251.5
15	48.8	74.9	100.3	53.2	81.4	109.5	125.0	184.1	237.4	134.9	199.2	257.0
16	51.7	79.3	106.3	57.7	88.7	119.3	132.0	194.7	251.1	148.4	219.2	282.8
17	55.8	85.2	114.0	59.6	91.5	122.9	140.9	208.0	268.3	151.8	224.1	288.9
18	56.9	87.1	116.7	64.7	99.3	133.3	145.3	214.5	276.5	165.7	244.0	314.9
19	59.7	91.4	122.5	65.9	101.3	135.7	153.1	225.5	290.4	169.3	249.1	321.4
20	64.4	98.3	131.5	67.8	104.0	139.4	165.4	243.6	314.1	173.8	255.7	329.8
21	66.7	102.3	137.0	74.8	114.6	153.8	171.9	253.8	327.1	191.0	281.3	362.9
22	70.2	107.4	143.6	76.2	116.8	156.6	180.2	265.2	341.3	195.2	287.3	370.4
24	76.7	116.7	155.7	80.5	123.2	164.9	196.6	288.6	371.6	205.8	303.1	390.8
26	80.9	123.3	164.6	91.8	140.1	187.3	207.5	305.2	392.7	234.1	345.0	444.5
28	84.1	128.0	170.6	95.6	145.8	194.8	215.8	316.9	407.8	244.5	360.0	463.8
30	96.4	146.9	196.3	101.4	154.8	206.7	246.4	362.7	466.8	259.4	381.8	491.3
32	100.1	152.5	203.4	106.7	162.9	217.5	256.1	376.9	484.9	273.4	402.6	518.0

51: Axial preload in unmounted Spindle Bearing pairs of series B719C, B70C, B72C.

Bore Reference Number	Preload F_v								
	Series B719C			B70C			B72C		
	Standard Preloads			L	M	H	L	M	H
	L	M	H						
6				9	34	77			
7				9	38	85			
8				15	59	129			
9				23	85	181			
00	16	61	132	24	88	186	32	114	241
01	18	69	151	26	97	205	38	133	281
02	20	77	167	28	102	216	47	165	347
03	21	81	176	41	146	308	53	186	391
04	41	151	323	52	179	377	74	252	527
05	45	164	350	74	254	533	79	269	562
06	47	176	376	75	260	545	122	412	856
07	67	239	507	97	333	697	169	558	1150
08	85	300	633	102	353	743	176	584	1204
09	89	315	667	145	490	1019	228	747	1537
10	90	321	679	150	507	1054	242	792	1631
11	112	391	825	207	687	1424	305	986	2027
12	117	410	866	211	704	1459	315	1022	2100
13	118	417	883	216	720	1495	390	1256	2570
14	172	588	1230	278	915	1888	404	1301	2664
15	174	596	1246	283	931	1923	416	1346	2757
16	175	603	1262	357	1163	2391	553	1761	3602
17	239	804	1672	370	1209	2484	573	1825	3734
18	240	811	1688	440	1427	2925	738	2332	4746
19	245	827	1724	447	1452	2980	768	2426	4937
20	318	1059	2194	467	1516	3112	955	3008	6106
21	318	1059	2194	625	1999	4083	997	3140	6377
22	316	1056	2191	648	2072	4235	997	3139	6376
24	408	1344	2773	657	2107	4308	1269	3957	8038
26	489	1600	3291	857	2720	5545	1316	4108	8347
28	506	1661	3412	873	2775	5657	1363	4259	8634
30	710	2286	4680	1111	3503	7142	1411	4410	8942
32	727	2341	4793	1152	3635	7412	1513	4734	9601
34	747	2410	4941	1458	4562	9252	1878	5842	11825
36	966	3086	6300	1513	4733	9600	1906	5935	12015
38	894	2996	6210	1445	4671	9575	1860	5955	12166
40	1133	3734	7704	1805	5771	11787	1916	6138	12545
44	1191	3942	8140	1916	6138	12545	2406	7621	15567
48	1230	4079	8432	1971	6321	12923			

Preload

52: Axial preload in unmounted Spindle Bearing pairs of series B719E, B70E, B72E.

Bore Reference Number	Preload F _v								
	Series B719E			B70E			B72E		
	Standard Preloads			L	M	H	L	M	H
	L	M	H						
6				14	60	132			
7				16	65	145			
8				19	90	207			
9				31	131	292			
00	19	90	207	31	132	294	43	178	391
01	21	102	235	34	145	322	51	203	443
02	22	112	259	36	154	344	65	256	555
03	23	116	268	54	221	487	75	289	626
04	54	231	509	71	277	598	105	393	843
05	57	245	545	101	384	828	113	420	901
06	59	260	581	102	397	861	175	637	1357
07	84	352	780	136	518	1116	248	871	1834
08	112	450	984	142	547	1180	259	912	1925
09	116	473	1038	209	768	1638	344	1190	2493
10	118	482	1059	211	779	1663	355	1230	2583
11	149	592	1287	298	1066	2257	451	1542	3211
12	156	622	1353	299	1075	2281	467	1599	3333
13	153	617	1348	310	1118	2372	591	1989	4143
14	234	890	1917	398	1397	2945	600	2030	4233
15	236	901	1943	408	1439	3027	619	2103	4389
16	238	911	1969	529	1830	3825	839	2783	5750
17	336	1232	2631	545	1888	3949	869	2889	5972
18	337	1243	2655	649	2217	4623	1136	3717	7651
19	343	1269	2713	675	2308	4813	1193	3906	8042
20	453	1626	3437	685	2347	4902	1502	4853	9948
21	453	1626	3437	960	3206	6639	1558	5040	10337
22	458	1651	3495	975	3262	6760	1525	4939	10131
24	591	2087	4388	989	3317	6881	2003	6418	13107
26	714	2477	5193	1322	4358	8972	2079	6671	13628
28	740	2576	5405	1345	4446	9159	2154	6923	14150
30	1046	3541	7369	1705	5555	11417	2186	7023	14400
32	1061	3597	7491	1728	5642	11602	2339	7529	15450
34	1111	3777	7870	2263	7276	14926	2879	9183	18737
36	1478	4921	10164	2339	7529	15449	2977	9503	19395
38	1259	4576	9707	2141	7290	15228	2816	9424	19525
40	1643	5803	12213	2730	9122	18891	2901	9725	20159
44	1714	6084	12867	2901	9725	20159	3670	12081	24979
48	1768	6303	13347	2933	9860	20455			

53: Axial preload in unmounted Spindle Bearing pairs of series HSS719C/E, HSS70C/E.

Bore Reference Number	Preload F _v											
	Series HSS719C			HSS70C			HSS719E			HSS70E		
	Standard Preloads			L	M	H	L	M	H	L	M	H
	L	M	H	L	M	H	L	M	H	L	M	H
00	7	20	39	9	27	55	11	32	64	15	44	89
01	7	21	41	9	27	54	11	33	66	15	44	87
02	9	28	56	13	38	75	15	46	92	20	61	122
03	10	29	58	13	38	76	16	47	94	21	62	124
04	13	39	78	21	62	125	21	63	127	34	101	202
05	14	42	84	21	64	127	23	69	138	35	104	207
06	21	64	129	29	88	176	35	105	209	48	143	285
07	24	71	142	32	95	190	38	115	230	51	154	308
08	25	74	147	34	101	201	40	120	239	54	163	327
09	34	103	205	44	131	263	55	166	331	71	214	428
10	35	105	209	46	137	273	58	173	345	74	222	444
11	46	139	279	64	192	383	75	225	451	105	315	630
12	48	145	289	67	201	402	78	235	469	107	322	644
13	49	147	295	70	209	418	80	239	478	112	336	672
14	64	192	383	89	268	536	103	308	616	146	437	874
15	65	196	391	91	273	547	105	315	630	148	444	888
16	73	218	437	109	328	657	117	352	704	175	524	1049
17	76	228	456	109	328	657	123	368	736	178	534	1067
18	83	249	498	130	389	777	133	398	796	207	621	1242
19	85	255	509	130	389	777	138	414	828	211	633	1265
20	102	306	611	134	402	804	166	497	994	215	644	1288
21	104	311	622	170	509	1018	169	506	1012	276	828	1656
22	121	362	724	174	523	1045	196	587	1173	280	840	1679
24	127	382	764	179	536	1072	207	621	1242	288	863	1725
26	145	436	871	228	683	1367	238	713	1426	368	1104	2208
28	150	449	898	232	697	1394	242	725	1449	376	1127	2254
30	214	643	1286	281	844	1688	349	1047	2093	449	1346	2691
32	219	657	1313	310	931	1863	357	1070	2139	502	1507	3013

Preload

54: Axial preload in unmounted Spindle Bearing pairs of series HCS719C/E, HCS70C/E.

Bore Reference Number	Preload F_v											
	Series HCS719C			HCS70C			HCS719E			HCS70E		
	Standard preloads			L	M	H	L	M	H	L	M	H
	L	M	H									
00	5	14	27	6	19	38	7	22	44	10	31	62
01	5	14	28	6	19	38	8	23	46	10	30	61
02	6	19	38	9	26	52	11	32	63	14	42	84
03	7	20	40	9	26	53	11	32	64	14	43	86
04	9	27	55	15	44	87	15	44	89	23	70	140
05	10	29	58	15	44	87	16	47	94	24	71	143
06	15	45	90	20	61	122	24	72	145	33	99	198
07	16	49	98	22	66	131	26	79	159	36	107	214
08	17	51	102	23	70	139	28	83	166	38	113	225
09	24	71	142	30	91	182	38	115	230	49	147	294
10	24	72	145	32	95	190	39	117	235	51	154	308
11	32	96	193	45	134	268	52	156	313	73	219	437
12	34	101	201	46	139	279	53	160	320	75	225	451
13	34	103	205	47	142	284	55	166	331	77	230	460
14	44	131	263	63	188	375	71	214	428	101	304	607
15	45	134	268	63	188	375	73	219	437	101	304	607
16	50	150	300	74	222	445	81	244	488	123	368	736
17	53	158	316	76	228	456	84	253	506	123	368	736
18	57	170	340	89	268	536	92	276	552	146	437	874
19	59	177	354	89	268	536	96	288	575	146	437	874
20	70	209	418	91	273	547	115	345	690	148	444	888
21	71	214	429	118	355	710	117	352	704	192	575	1150
22	83	249	498	118	355	710	135	405	810	192	575	1150
24	88	263	525	123	369	737	143	428	856	199	598	1196
26	100	300	600	159	476	951	163	488	975	257	771	1541
28	102	306	611	161	482	965	166	497	994	261	782	1564
30	150	449	898	192	576	1152	242	725	1449	311	932	1863
32	152	456	911	212	637	1273	245	736	1472	345	1035	2070

55: Axial preload for Miniature and Instrument Bearings.

Basic Bearing	Preload F_v			Basic Bearing	Preload F_v
	Deep Groove	Angular Contact "B" type	Angular Contact "H" type		Deep Groove Standard preload N
Barden				Barden	
R1-4	4.4	—	—	R133	2.2
R1-5	8.9	4.4	4.4	R144	4.4
R2-5	8.9	8.9	8.9	R155	4.4
R2-6	8.9	—	—	R156	4.4
R2	8.9	8.9	8.9	R166	8.9
R2A	8.9	—	—	R168	4.4
R3	8.9	8.9	8.9	R188	8.9
R4	8.9	8.9	8.9	R1810	8.9
R4A	22.2	—	—		
R6	22.2	8.9	22.2		
R8	44.5	—	35.6		
R10	66.7	—	—		
34	26.7	26.7	26.7		
34-5	26.7	26.7	26.7		
35	26.7	—	26.7		
36	26.7	26.7	26.7		
37	53.4	—	53.4		
38	53.4	53.4	53.4		
39	66.7	—	66.7		

56: Axial preload for Deep Groove Bearings.

Bore Reference Number	Preload F_v			Bore Reference Number	Preload F_v		
	Series 100 Standard preload				Series 200 Standard preload		
	L	M	H	L	M	H	
	N			N			
00	22.2	44.5	89	00	22.2	53.4	97.9
01	26.7	57.8	111.2	01	26.7	62.3	120.1
02	26.7	57.8	111.2	02	31.1	75.6	133.4
03	35.6	80.1	133.4	03	40	97.9	177.9
04	35.6	89	177.9	04	57.8	133.4	244.6
05	44.5	111.2	200.2	05	66.7	155.7	289.1
06	62.3	155.7	289.1	06	97.9	222.4	444.8
07	89	177.9	355.8	07	133.4	311.4	578.2
08	133.4	200.2	400.3				

Spindle Bearings - Sets

Nomenclature for Bearing Sets.

The nomenclature consist of two or three letters.

First Letter

Number of bearings in set

- D 2 bearings (Duplex)
- T 3 Bearings (Triplex)
- Q 4 bearings (Quadruplex)
- P 5 bearings (Pentaplex)
- S 6 bearings (Sestuplex)

Second and Third Letters

Arrangement of the bearings in a set

- U Universal
- B Back to back
- F Face to face
- T Tandem
- BT Back to back arrangement against a tandem set with 2,3 or 4 bearings
- FT Face to face arrangement against a tandem set with 2,3 or 4 bearings
- BC Back to back arrangement; tandem pair against a tandem set with 2,3 or 4 bearings
- FC Face to face arrangement; tandem pair against a tandem set with 2,3 or 4 bearings

Fourth Letter

Preload

- L Light
- M Medium
- H Heavy

Examples of Nomenclature

FAG HS7015C.T.P4S.DUL
2 bearings universally preloaded in one package (can be assembled in any configuration).

In universal bearing sets the bore and OD tolerances are matched.

FAG B7015E.T.P4S.TBTL
3 bearings in tandem back to back arrangement.

Bearing sets with different contact angles, larger sets or special preloads on enquiry.

57: Bearing Set Arrangements

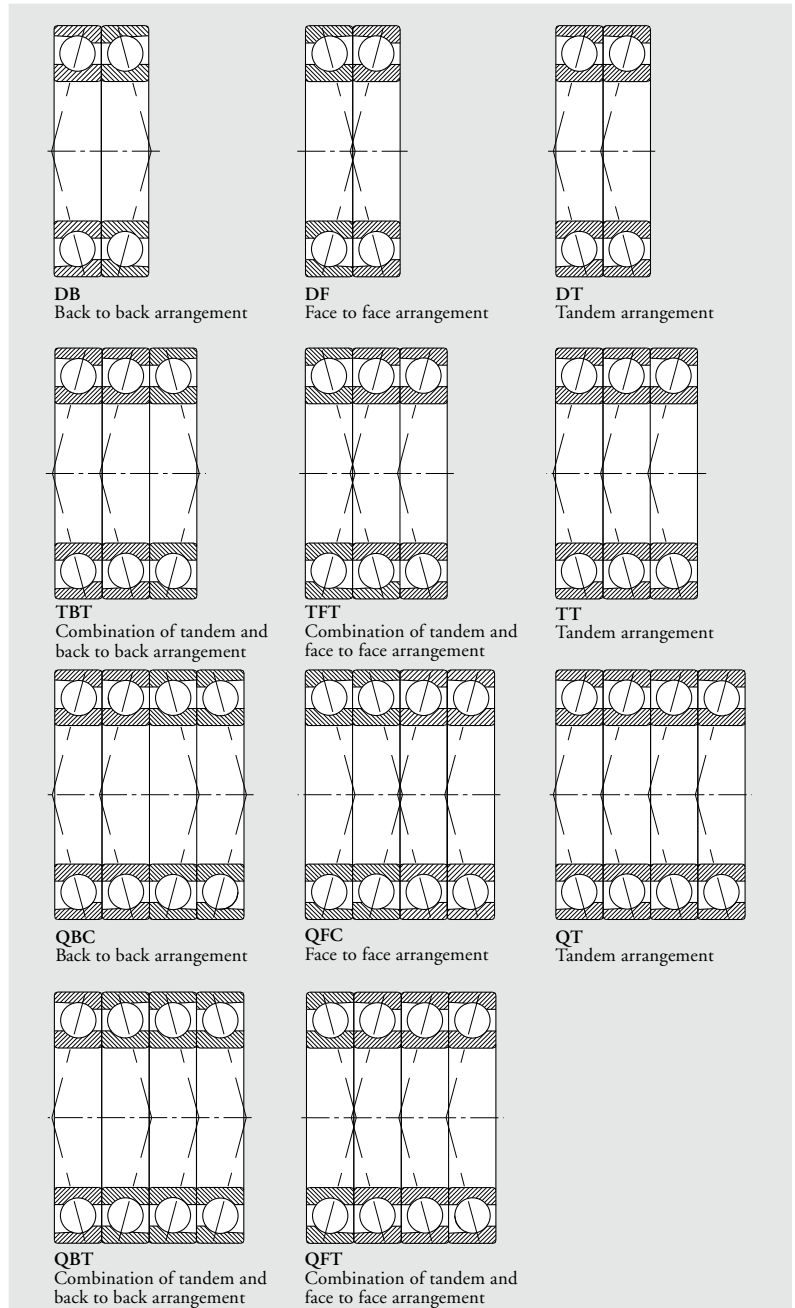

Cages for Miniature and Instrument and Deep Groove Bearings

Most bearing assemblies include a cage or separator to maintain uniform ball spacing, reduce torque and lessen heat build-up. Additionally, in separable bearings the cage is designed to retain the balls so the rings can be handled separately.

Cage loading is normally light but various acceleration and centrifugal forces may also develop and impose cage loading. Also it may be important for the cage to accommodate varying ball speeds that occur in certain applications.

Cages are piloted (guided) by the balls or one of the rings. Typically, low to moderate speed cages are ball piloted. Most high speed cages have machined surfaces and are piloted by the land of either the inner or outer ring.

Barden deep groove and angular contact bearings are available with several different types of cages to suit a variety of applications. Many factors enter into cage design and cage selection including :

- Low coefficient of friction with ball and race materials
- Low tendency to gall or wear
- Ability to absorb lubricant
- Dimensional stability
- Thermal stability
- Suitable density
- Adequate tensile strength
- Creep resistance
- Cost

This list can be expanded to match the complexity of any bearing application. As a general guide, Table 58 may be used by the designer for cage selection. It presents basic data in a tabulated format for review and comparison.

When a standard cage does not meet the end use requirements specialised cages have been developed and manufactured for unusual applications. Some examples of conditions which merit engineering review are ultra high speed operation, a need for extra oil absorption, extreme environments and critical low torque situations. Materials as diverse as silver plated steel, bronze alloys and porous plastics have been used to create custom cage specifications for such conditions.







Deep Groove Bearing Cages

The principle cage designs for deep groove bearings are snap-in types Q, TA, TMT, and TB; Symmetrical types P, W and T. Type W is a low torque cage developed by Barden, available in many miniature and instrument sizes. This two piece ribbon cage is loosely clinched to prevent cage windup (a torque-increasing drawback of some cage designs) in sensitive low torque applications.

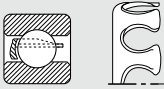
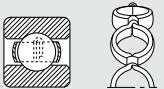
Ribbon cages P and W are used at moderate speeds and are particularly suited for bearings with grease lubrication and seals or shields. For higher speeds, Barden offer the one piece phenolic snap-in type TA cage in smaller bearing sizes and the two piece riveted phenolic, aluminium T cage for larger sizes. The aluminium reinforcement, provides additional strength and permits the use of this high-speed cage in most standard width sealed or shielded bearings.

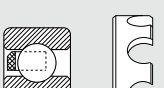
Cages for Miniature and Instrument and Deep Groove Bearings

58: Barden Cages for Deep Groove Bearings

Typ	Illustration	Material	Construction	Maximum Velocity		Cage Material Operating Temperature Range °C	Applications Comments
				Oil $n \cdot d_m$	Lubrication Grease		
Q* Snap-in		Stainless steel AISI 410	One-piece, stamped, with coined ball pockets and polished surfaces	400,000	400,000	Normal to 315	General purpose. Not available for balls larger than 3/32" dia.
P* Two-piece ribbon, full clinch		Stainless steel AISI 430 AISI 305	Two-piece, stamped ribbons to form ball pockets, with fully clinched ears	400,000	400,000	Normal to 480	General purpose. Not available for bearings with bore smaller than 5mm
W Two-piece ribbon, loose clinch		Stainless steel AISI 430 AISI 305	Two-piece, stamped ribbons to form ball pockets, with loosely clinched ears	400,000	400,000	Normal to 480	Low torque instrument applications
TA Snap-in		Phenolic	One-piece, machined from fiber-reinforced phenolic; side-assembled snap-in type	1,000,000	1,000,000	Normal to 150	High speed, general purpose
T Two-piece riveted		Phenolic, aluminium reinforced	Two-piece, machined phenolic reinforced with aluminium side plates, secured with rivets	1,500,000	1,000,000	Normal to 150	High speed, general purpose use. Do not allow contact with chlorinated solvents
ZA Tube type ball separator		Teflon®	Hollow cylinders of Teflon	7,000	7,000	Cryogenic to 230	Low speed, low torque applications. If used without lubricant, bearing material should be stainless steel
TB Snap-in		BarTemp®	One-piece, machined, side-assembled snap-in type	Normally used dry. Max. $n \cdot d_m$ 100,000		Cryogenic to 275	Provides dry film lubricant for bearing operation in gaseous atmospheres, vacuum, etc. Moderate speeds, light loads only. Requires one shield. Moisture sensitive
TMT Snap-in		Filled nylon 6/6	One-piece, moulded, side assembled snap-in type	500,000	500,000	Normal to 150	Moderate speed, general purpose use

* Symbol for standard cage not used in nomenclature. Cages for Miniature and Instrument and Deep Groove Bearings

Cages for Miniature and Instrument and Deep Groove Bearings

59: Barden Cages for Angular Contact Ball Bearings

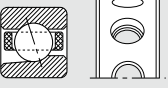
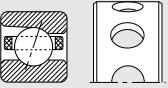
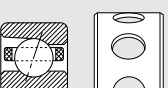
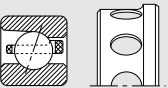
Typ	Illustration	Material	Construction	Maximum Velocity		Cage Material Operating Temperature Range °C	Applications Comments
				Oil $n \cdot d_m$	Lubrication Grease		
B** One-piece, for bearings with separable inner rings		Phenolic	One-piece, machined from fibre-reinforced phenolic, ball pockets are designed to retain balls with outer rings	1,500,000	1,000,000	Normal to 150	High speed, general purpose use
H** One-piece, for bearings with nonseparable outer rings		Phenolic	One-piece, machined from fiber-reinforced phenolic with cylindrical ball pockets	1,500,000	1,000,000	Normal to 150	High speed, general purpose use
JB One-piece, for bearings with nonseparable outer rings		Bronze (80-10-10)	One-piece, machined cylindrical ball pockets	2,200,000	Not recommended	Normal to 330	High speed, high temperature applications. Continuous or repetitive lubrication required. Stains with synthetic oil.
JH One-piece, for bearings with nonseparable outer rings		Bronze (80-10-10)	One-piece, machined cylindrical ball pockets	2,200,000	Not recommended	Normal to 330	High speed, high temperature applications. Continuous or repetitive lubrication required. Stains with synthetic oil.

** Symbol for bearing type. No symbol is used in nomenclature for standard cages.

Bearing Closures Miniature and Instrument and Deep Groove Ball Bearings

The two basic types of bearing closures are shields and seals, both of which may be ordered as integral components of deep groove bearings. (The angular contact bearing design is not easily adaptable to integral closures.)

All closures serve the same purposes with varying effectiveness. They exclude contamination, retain lubricants and protect the bearing from internal damage during handling.

Closures are attached to the to the outer ring. If they clear the inner ring they are shields. Seals and shields in Barden bearings are designed so that the stringent precision tolerances are not affected by the closures. They are available in large precision spindle and turbine bearings as well as in Barden miniature and instrument bearings.

Selection of Closures

Determining the proper closure for an application involves a trade off, usually balancing sealing efficiency against speed capability and bearing torque.

Shields do not raise bearing torque or limit speed, but they have low sealing efficiency. Seals are more efficient, but they may restrict operating speed and increase torque and temperature.

Another consideration in closure selection is air flow through the bearing, which is detrimental because it carries contamination into the bearing and dries out the lubricant. Seals should be used if air flow is present.

Shields are precision-stamped of stainless steel in a dished shape to provide rigidity, resistance to resonant vibration and maximum lubricant space within the bearing. Inner ring notches are provided where space permits, to present a difficult entry path for contaminants. Where the face width is insufficient for notching, the shield extends nearly to the inner ring, maintaining a closely controlled clearance above the inner ring land.

60: Shields

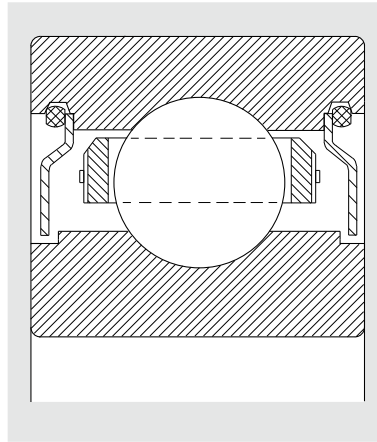

Flexeal is a Barden-developed seal with a layer of fibre bonded to a precision aluminium stamping. The fibre is prelubricated to produce extremely low friction at the ground sealing sealing notch. This low friction allows Flexeal-equipped bearings to operate at speeds up to 1,200,000 $n \cdot d_m$ (PCD in mm x rpm). Maximum temperature is 150 °C continually, 180 °C intermittently. Flexeal seals are recommended for applications where contamination is generated near the bearing (e.g. commutators or

61: Flexeal

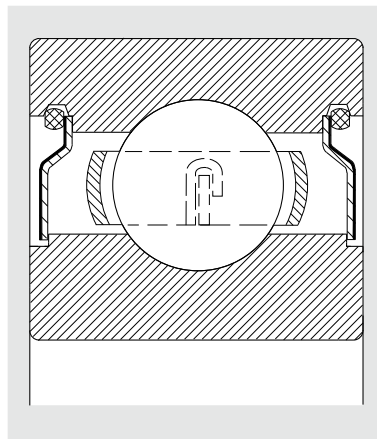

62: Barseal

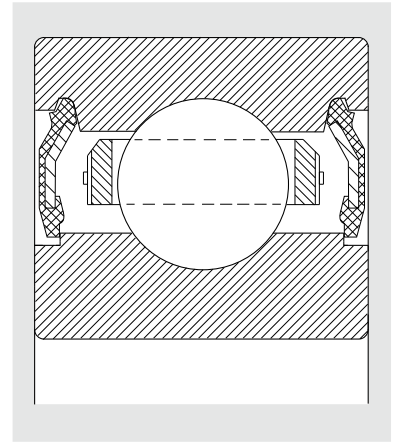

similar mechanisms which produce minute dirt particles) or in instruments which must operate in a contaminated environment.

Barseal is a composite seal consisting of moulded rubber with a metal stiffener. It offers optimum sealing and is designed to contact the inner ring intimately under all loading conditions. The inner ring seal riding surfaces are ground for better sealing, lower torque and longer life. Maximum $n \cdot d_m$ with Barseals is 320,000; temperature range is 0 °C to 110 °C. Barseal seals are recommended where applications require the most positive type of integral contacting sealing. They are also best suited for situations with air flow problems because external air pressure increases the seal/ring contact pressure. Barseal running torque is slightly higher than that of flexeal seals.

Notes

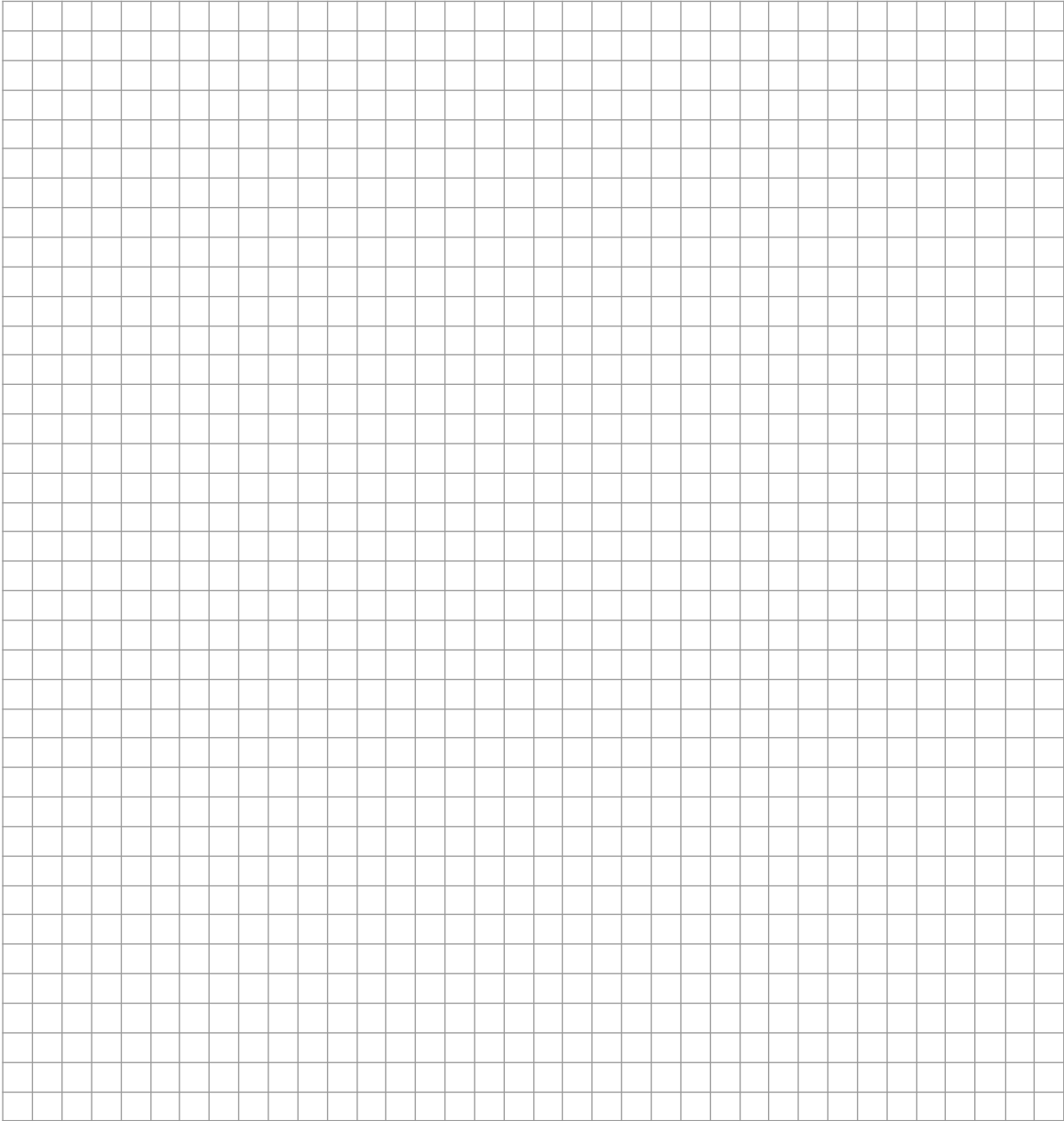

3

Every care has been taken to ensure the correctness of the information contained in this publication. No liability can be accepted for any errors or omissions. We reserve the right to make changes in the interest of technical progress.

Highest Reliability of FAG High Precision Bearings in Extreme Operating Conditions



Flag flown on Pratt & Whitney's first mission STS-70, July 13, 1995

SPACE FLIGHT AWARENESS *Award of* EXCELLENCE

Presented to

*F.A.G. Aircraft/Super Precision
Bearings GmbH*

for dedication and support of the
Pratt & Whitney Alternate Turbopump Program

John L. Price
SSME-AT Program Manager

J. P. Mitchell
Manager, Liquid Rocket Engineering

Production Facilities for Super Precision Bearings of the
FAG Aerospace and Super Precision Bearings Division:

FAG Aircraft/Super Precision Bearings GmbH

Georg-Schäfer-Str. 30 · D-97421 Schweinfurt
Phone 49-(0) 97 21-91 33 72 · Fax 49-(0) 97 21-91 36 66

The Barden Corporation

P.O. Box 2449 · 200 Park Avenue
Danbury, Connecticut 06813-2449
Phone 203-744-2211 · Fax 203-744-3756

The Barden Corporation (UK)

Plymbridge Road · Estover
Plymouth PL6 7LH · Devon
Phone 44-(0) 17 52-73 55 55 · Fax 44-(0) 17 52-73 34 81

