

## ROLLING BEARINGS FOR THE PAPER INDUSTRY

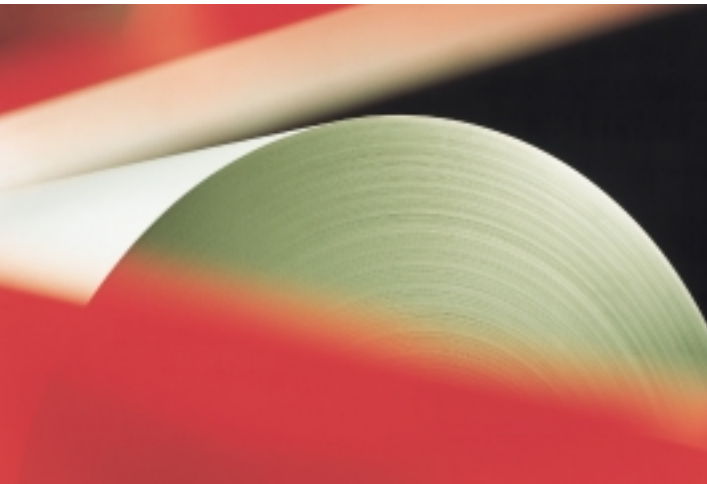
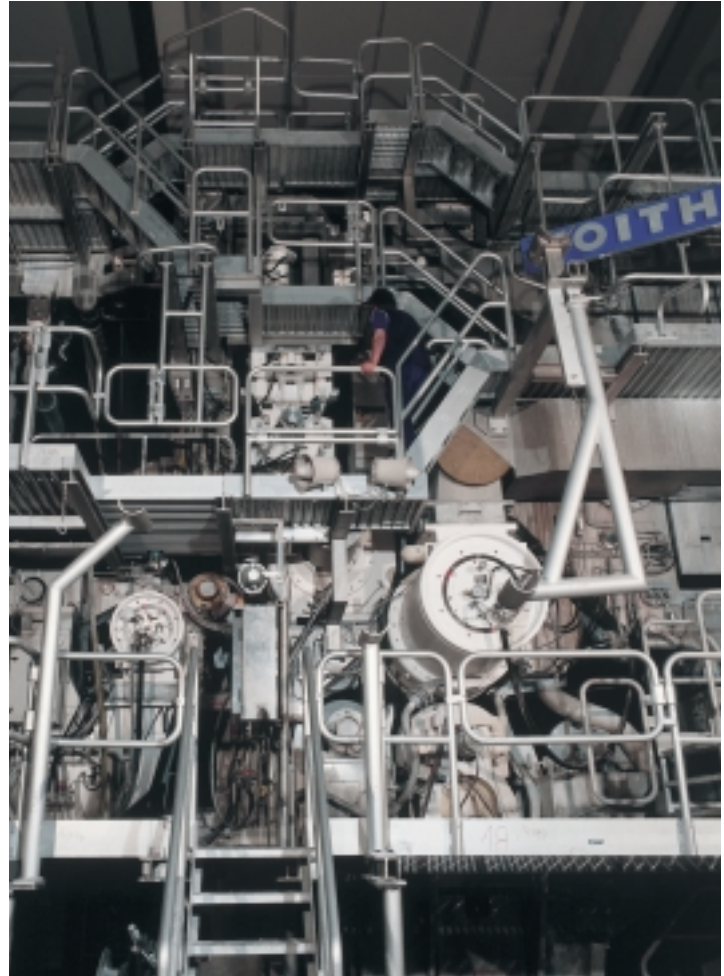

Products · Service · Design · Dimensioning

---

## Preface

The OEM und Handel company of the FAG Kugelfischer Georg Schäfer AG Group supplies rolling bearings, necessary accessories, and services to original equipment customers in machinery and plant construction as well as to customers in the distribution and spare parts business. Comprehensive rolling bearing know-how, competent consultation on applications, and extensive customer service for more operational reliability make FAG an indispensable partner to its customers. Research and development of our products is based on the requirements of

operation in the field. An ideal outline of requirements is best achieved through cooperation of our application engineers with the manufacturers and operators of equipment for the paper industry. It forms the basis for successful solutions both technically and economically speaking.

Production locations are found in Germany, Italy, Portugal, South Korea, the USA and India. Sales are conducted by sub-sidiaries and distribution partners in almost every country in the world.



## A Partnership in Paper

FAG offers a complete Paper Mill Program that complements our Distributor Network.

FAG is committed to the Pulp & Paper Industry to assure a total Quality Process from start to finish.

Our total 10-point concept from Order Entry to Proactive Maintenance brings cost savings on a continual basis.

1. Innovation and Quality assured
2. Global Resources and Support
3. Products
4. Inventory Review
5. Stock Management
6. Training Program
7. Technical Service
8. Proactive Maintenance
9. Communication
10. Documented Savings

---

# **Rolling Bearings for the Paper Industry**

Products · Service · Design · Dimensioning

**Publ. No. WL 13 103/2 EA**

## **FAG OEM und Handel AG**

A company of the FAG Kugelfischer Group

Postfach 12 60 · D-97419 Schweinfurt

Tel. +49-9721 / 91-3689 · Fax +49-9721 / 91-4908

E-mail: [pulp+paper@fag.de](mailto:pulp+paper@fag.de)

[www.fag.de](http://www.fag.de)

---

# Contents

<b>1</b>	<b>FAG products and services for the paper industry (outline)</b>	<b>3</b>
1.1	Standard rolling bearings	4
1.2	Special products	5
1.3	Service range	5
1.4	Suffixes, technical specifications	6
<b>2</b>	<b>Requirements on paper machine bearings</b>	<b>7</b>
<b>3</b>	<b>Examples of bearing arrangements for paper machines</b>	<b>8</b>
3.1	Wet end section	8
3.1.1	Forming roll	9
3.1.2	Suction roll	10
3.1.3	Center press roll	12
3.1.4	Anti-deflection roll	13
3.2	Dryer section	14
3.2.1	Guide roll	14
3.2.2	Dryer roll	16
3.3	Calender and finishing group	18
3.3.1	Calender thermo roll	18
3.3.2	Spreader roll	20
<b>4</b>	<b>FAG service for more operational reliability</b>	<b>21</b>
4.1	Storage of rolling bearings	21
4.2	Preparations for mounting and dismounting	21
4.3	Mounting and dismounting with cylindrical and tapered mating surfaces	21
4.4	Fits and tolerances	23
4.5	Monitoring and analysing bearings	26
4.6	PC programs for calculating and designing rolling bearings	28
4.7	FAG mounting service	28
4.8	FAG training courses	28
4.9	Selection of publications	29
<b>5</b>	<b>Dimensioning and lubricating rolling bearings</b>	<b>30</b>
5.1	Dimensioning	30
5.2	Lubrication	32
5.2.1	Grease lubrication	32
5.2.2	Oil lubrication	34
<b>6</b>	<b>Tables</b>	<b>38</b>
6.1	Conversion	38
6.2	Radial clearance, radial clearance reduction	39

## 1 FAG products and services for the paper industry

FAG has an extensive programme of products and services for the paper industry.

The rolling bearing demand in this field focusses on standard rolling bearings, that is rolling bearings with standardised main dimensions.

In pulp preparation, these are, for example, spherical roller bearings and cylindrical roller bearings. The spherical roller bearing dominates in paper making. Deep groove ball bearings, angular contact ball bearings, and tapered roller bearings are found in accessory units of papermaking machines (motors, gears, fans, pumps). Spherical roller bearings, angular contact ball bearings and cylindrical roller bearings are typical standard rolling bearings in the field of finishing and converting. FAG also supplies accessories and housings suitable for standard rolling bearings.

Spherical roller bearings with an outside diameter of > 320 mm, which are particularly popular, are compiled in FAG Paper Scope. It should improve product availability especially for the spare parts demand of paper mills. FAG Paper Scope exclusively contains products which are important in the paper industry but which are not required on a regular basis and have widely varying usage levels. They are spherical roller bearings of the popular series 230, 231, 232 and 239 with design variety and combinations typical to the paper industry, e.g.

- cylindrical and tapered bore
- increased radial clearance (C3 or C4)
- increased running accuracy (T52BW) with a speed index of  $n \cdot d_m > 250\,000 \text{ min}^{-1} \cdot \text{mm}$
- lubricating holes in inner ring (H140)
- case-hardened inner rings (W209B) for dryer rolls and calender rolls

The industrial trend is towards the designs C3/C4, H140, T52BW and W209B for modern machines.

FAG has also drawn up a special programme with which more complex technical bearing tasks can be handled reliably and economically. It includes self-aligning cylindrical roller bearings, split spherical roller bearings, triple ring bearings and special housings.

The FAG offer is completed with products for mounting, maintenance, and diagnosis, mounting and dismounting service, technical consultation for applications, training courses and means, PC calculation programs and technical publications.

You will find an outline of the FAG products and FAG service for the paper industry in the tables on pages 4 and 5.

The table on page 6 contains the relevant suffixes and technical specifications.

Spherical roller bearings for the paper industry



Self-aligning double row cylindrical roller bearing



Condition monitoring of rolling bearings with the FAG Bearing Analyser



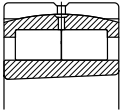
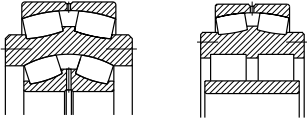
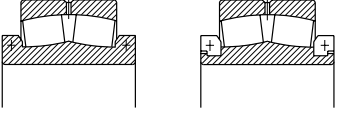
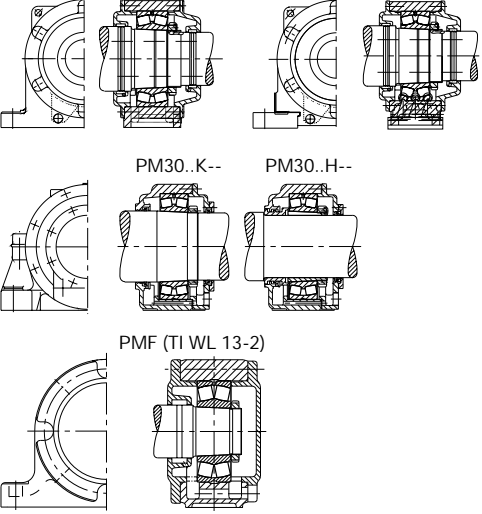

## 1.2 Special products

Bearing type	Bearing series/design/size	Application
<b>Self-aligning cylindrical roller bearings</b> (Publ. No. WL 13 111) 	FAG 5.....K.C5 (.W209B) (d 150...300) FAG 5.....K.C5 (.W209B) (d 320...710)	dryer rolls M.G. cylinders
<b>Triple ring bearings (TI WL 43-1192)</b> 	FAG 5..... (d 180...420) FAG 5..... (d 100...400)	driven anti-deflection rolls in press sections and calenders
<b>Split spherical roller bearings (Publ. No. WL 43 165)</b> 	222SM..MA (d 55...200) FAG 5..... (d 170...400) with separate clamping rings	transmissions, pulpers, agitators/mixers, fans dryer roll conversions
<b>Housings</b> 	PMD31.. (d 180...300) PMDR31.. (d 180...300) PM30..K-- (d 130...710) PM30..H-- (d 130...710) SUC30../31.. (d 130...710) PMF 23/22/32.. (d 75...180)	dryer rolls as plummer block or rocker block housing dryer rolls M. G. cylinders (only for conversions) individual product as plummer block or rocker block housing guide rolls (dryer section)

## 1.3 Service range

- Mounting and diagnosis
- Equipment for mounting, maintenance and diagnosis
- Technical consultation for applications
- FAG training courses

- basic course on rolling bearings
- individual courses for maintenance personnel
- software for learning alone at the PC (W.L.S.)
- videos
- FAG publications and Technical Information sheets

- PC programs for calculating and designing bearings
  - FAG product catalogue on CD-ROM
  - Special calculating programs for bearings and mating parts
- Arcanol rolling bearing greases

# Products and services for the paper industry

## Suffixes and technical specifications for rolling bearings in the paper industry

### 1.4 Suffixes and technical specifications for rolling bearings in the paper industry

Suffix	Description
C2	radial clearance smaller than normal
C3	radial clearance larger than normal
C4	radial clearance larger than C3
C5	radial clearance larger than C4
E, ED	modified internal construction
H40	no lubricating grooves or holes in outer ring
H40AB	spherical roller bearing with 6 lubricating holes in inner ring
H40AC	spherical roller bearing with 6 lubricating holes and lubricating groove in inner ring
H40CA	bearing with 6 lubricating holes and lubricating groove in outer ring
H44S	lubricating holes in outer ring closed with aluminium plugs
H44SA	3 aluminium plugs for closing lubricating holes in outer ring
H44SB	6 aluminium plugs for closing lubricating holes in inner ring (only in combination with H40AC)
H88	running accuracy P5 for inner ring, P4 for outer ring + J26C + M15NZ + restricted width tolerance for outer ring
H140	combination of H40AC, H44SA, H44SB and T52BW
H157	combination of H40 and H40AC + oil injection nozzles
J26A	point of max. radial runout marked on inner ring or sleeve
J26B	point of max. radial runout marked on outer ring
J26C	point of max. radial runout marked on inner ring and outer ring
M	machined brass cage, guided by rolling elements
MB	two-piece machined brass cage, guided by inner ring
MB1	one-piece machined brass cage, guided by inner ring
MB2	modified two-piece machined brass cage, guided by inner ring
M15NZ	measuring report with Talyrond graph, series number
M17D	crack inspection for inner ring
T27	cylindrical rollers with crowned outside diameter
T50H	restricted tolerance of outside diameter (towards minus-minus)
T52BW	P5 running accuracy for inner ring and outer ring (+ J26C)
W10A	isotemp heat treatment for outer ring
W10D	isotemp heat treatment for outer ring and inner ring
W209B	inner ring made of case-hardening steel

#### Popular combinations:

C3.H40AB.T52BW  
C3.H40AC.T52BW  
C3.H140  
C3.T52BW  
C5.M17D.T27.W10A.W209B  
C5.M17D.T27.W10D  
H40AB.T52BW  
H40AC.T52BW  
H44S.T52BW



## 2 Requirements on paper machine bearings

The machines used today for the production of endless paper and cardboard webs are very large reaching up to 200 m in length at times. With a web width of 10 m, 1,800 m of paper can be produced per minute. The paper web runs over numerous rolls which are supported by rolling bearings.

As shown in the diagram below, paper machines are essentially made up of the same components: wet end section consisting of forming section and press section; dryer section; finishing group with calender and paper reeling.

The typical requirements placed on bearing arrangements in paper machines are:

- utmost operational reliability
- easy mounting
- compensation for misalignment
- avoidance of corrosion in the wet section

- suitability for high temperatures in dryer section
- high speed suitability
- high bearing quality and precision

A paper machine should operate if possible without any interruption and should only have to be shut down for scheduled maintenance and repair work. As a result, the demand for utmost operational safety and reliability must be given top priority when designing all bearing arrangements and selecting the bearings themselves. Lubrication and maintenance play just as important a role as correct bearing selection whereby maintenance includes diagnosing rolling bearings during operation.

Mounting and dismounting should be facilitated in order to save time and money when bearing changes are required.

Due to the dimensions of paper machines and the distances between bearings as a result, the bearings must be able to accommodate misalignment and length variations.

There is a high degree of moisture in the environment of the wet end section. Sealing must be designed so that water cannot penetrate and corrosion can be avoided. Moisture can severely impair lubrication and thus affect the bearing's life considerably.

In addition, high operating temperatures and bearing temperatures in the dryer section make requirements on the lubrication and bearing design even greater.

Finally, speeds arising due to the high paper speed must be taken into consideration when arranging and selecting the bearings.

Paper machines are stand-alone plants which are tailored to customers' specific requirements. They are not produced in series, which is quite common in other fields. Experience with similar components and operating conditions can nevertheless be useful when designing bearing arrangements.

### A modern paper machine

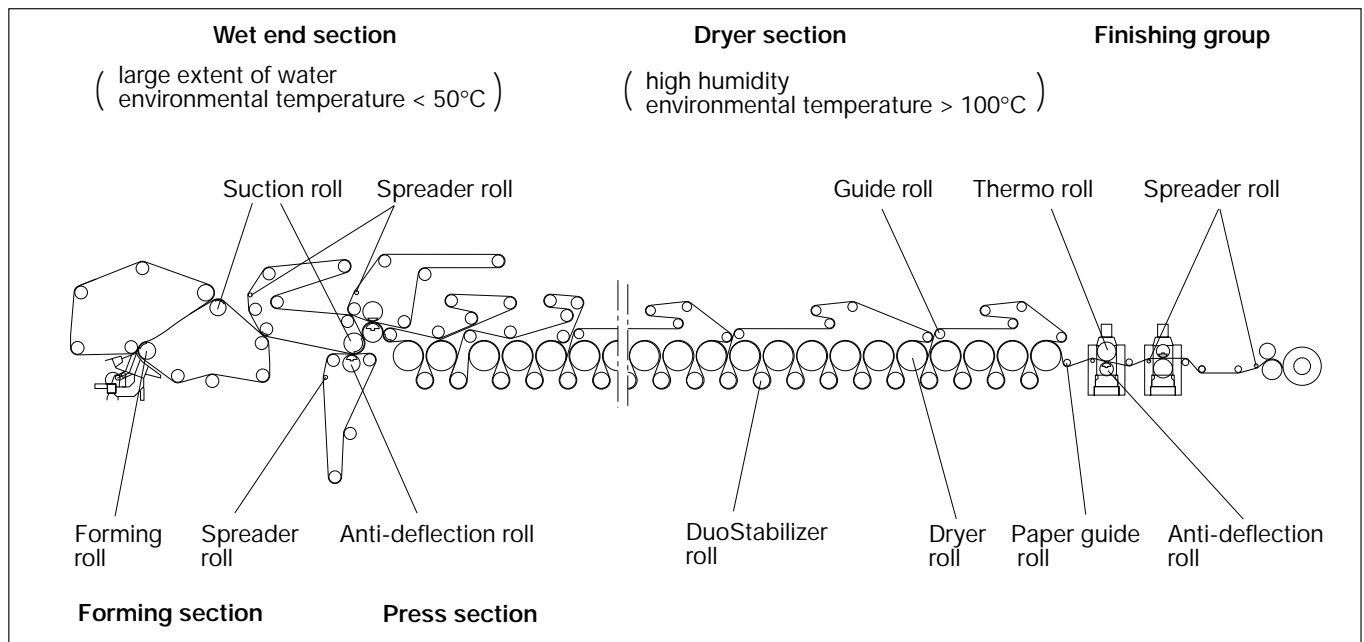

# Requirements on paper machine bearings

## Examples of bearing arrangements for paper machines

Today the spherical roller bearing is the dominating bearing type particularly among medium-sized and large-sized bearings. Larger cylindrical roller bearings are frequently adapted to special operating conditions and roll designs.

Other bearing types are found in auxiliary equipment in paper plants (motors, gears, fans, debarking drums, grinders, chippers, refiners, agitators/mixers, coating machines, rewinders and cutting equipment). See lists on pages 4 and 5.

In the paper industry bearings are designed for a far longer life than in other industrial equipment, see section 5.1.

Lubrication considerably influences the life of the bearings. All roll bearings in modern paper machines are connected to an oil circulation system for operational reliability and maintenance reasons. Grease lubrication is found in the wet end section (with lower environmental temperatures) of older paper machines.

In the dryer section, bearings for rope sheaves, spreader rolls and sometimes guide rolls are lubricated with grease, see section 5.2.

A high degree of cleanliness in the bearings during the entire operation period is also decisive for a long service life. This requires utmost sealing reliability, especially against moisture, and diverse designs depending on the type of roll in question, see examples in section 3.

### 3 Examples of bearing arrangements for paper machines

#### 3.1 Wet end section



## 3.1.1 Forming roll

In modern high-speed paper machines the forming roll is the first roll over which the paper, still pulp, is guided. It diverts a large amount of water and shapes the remaining paper mass into form. The forming roll consists of a non-corroding special steel cylinder up to 10 m in length. The water is removed through small holes located around the surface of the cylinder. It first gathers in a latticework like a honeycomb at the outer side of the roll and is thrown into a tub after about half a rotation. The paper fibre from which more water has been removed between two synthetic wire belts, is conveyed to the press section via the suction rolls.

### Technical data

Roll length 7,120 mm; roll diameter 1,150 mm; rotation  $276 \text{ min}^{-1}$  (speed 1,000 m/min); roll weight 200 kN; wire tension 5 kN/m.

### Bearing selection, dimensioning

The suction box diameter is decisive for the size of the main bearing at the operator's end. We recommend bearings with a dynamic load rating as low as possible in order to reduce the danger of slippage (cf. example 3.1.2). Self-aligning bearings are necessary as misalignment could arise.

Roll weight, wire tension and rotation are the main criteria for dimensioning the bearings.

FAG spherical roller bearings are mounted: 22326ED.C3 as support bearing for the suction box, as main bearing (operator's end) 23996K.MB and as main bearing (drive end) 23068K.MB. The main bearings mounted on the tapered shaft seats can be hydraulically mounted and dismantled.

The locating bearing (drive end) provides axial guidance for the rolls while the floating bearing compensates for any length variations by outer ring displacement in the housing bore.

### Machining tolerances

Main bearing: circumferential load demands a tight fit for the inner rings; roundness tolerance IT5/2 (DIN ISO 1101); taper angle tolerance AT7 (DIN 7178). Housing bore according to G7, due to point load at the outer ring.

Suction box bearing: housing bore according to N7 (circumferential load at the outer ring), shaft according to f6 (point load for inner ring).

### Lubrication

Circulation lubrication with a mineral oil with sufficient viscosity and EP additives as well as additives with good anti-corrosive properties and water separation ability. Minimum oil quantity, see section 5.2.2.

### Sealing

Main bearing: A multiple labyrinth protects against water penetration from outside particularly at the roll side.

Suction box bearing: Labyrinth as protection against penetration of water (suction box side).

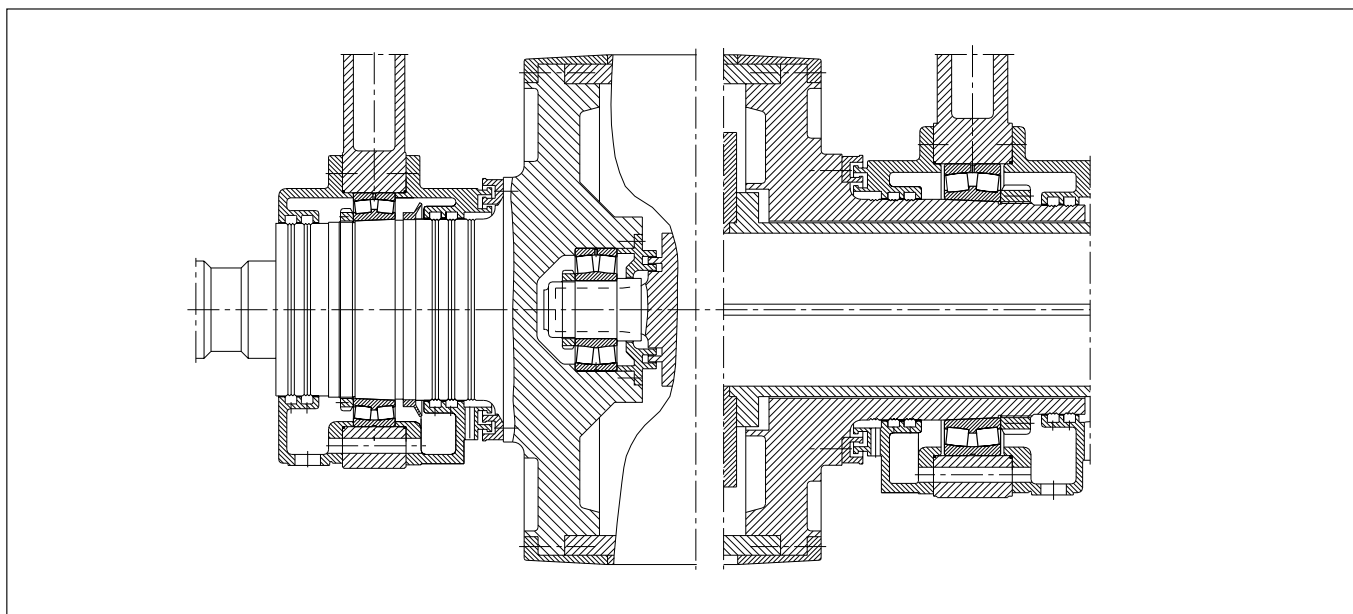

# Examples of bearing arrangements for paper machines

## Wet end section

### 3.1.2 Suction roll

Suction rolls are found in the wire or press section of a paper machine. They are hollow cylinders up to 10 m in length which have several small holes all around their circumference. Some water content is removed from the web due to the rotating roll shell and the vacuum inside the roll. The suction box, as interior axle, is stationary. The roll shell is driven by planet wheels in modern paper machines.

#### Technical data

Roll length 7,800 mm; roll diameter 1,600 mm; rotation  $278 \text{ min}^{-1}$  (speed 1,400 m/min); roll weight 270 kN; wire tension 5 kN/m.

#### Bearing selection, dimensioning

The diameter of the suction box is decisive for the size of the bearing. We recommend bearings with a dynamic load rating as low as possible; the higher specific bearing load reduces the danger of slippage (too low a load and starved lubrication can cause the rolling elements to slide on the raceway).

Self-aligning bearings are necessary as misalignment could arise.

Roll weight, wire tension and rotation are the main criteria for dimensioning the bearings.

FAG spherical roller bearings FAG 239/850K.MB.C3 with tapered bore (K 1:12) and increased radial clearance are used. The bearings are mounted directly on the tapered shaft seats for running accuracy reasons. The hydraulic method is applied to facilitate mounting.

The locating bearing provides axial guidance for the rolls while the floating bearing compensates for any length variations by displacement of the outer ring in the housing bore.

The nominal life for both bearings is  $L_h > 100\,000 \text{ h}$ . The adjusted rating life calculation reaches over 200 000 h when the operating temperature is  $60 \text{ }^\circ\text{C}$  and the oil ISO VG 68 (viscosity ratio  $\kappa > 2$ ; factor  $a_{23} = 2.2$ ).

#### Machining tolerances

The inner ring has circumferential load and is attached to the tapered bearing seat of the shaft.

Roundness tolerance IT5/2 (DIN ISO 1101); taper angle tolerance AT7 (DIN 7178).

Housing bores according to G7 due to point load at the outer ring.

#### Lubrication

The spherical roller bearings are supplied by circulation lubrication with a minimum oil quantity of 8 l/min. A mineral oil with sufficient viscosity and EP additives is selected. Additives with good anti-corrosive properties and water separation ability are also required. An effective lubrication is achieved with an oil supply to the centre of the bearing.

#### Sealing

Any oil which escapes is thrown off via splash grooves into oil collecting chambers and directed back. At the roll side a baffle plate and multiple grease-filled labyrinth with integrated V ring prevent water penetrating from the outside.

Courtesy of Valmet



# Examples of bearing arrangements for paper machines

Wet end section

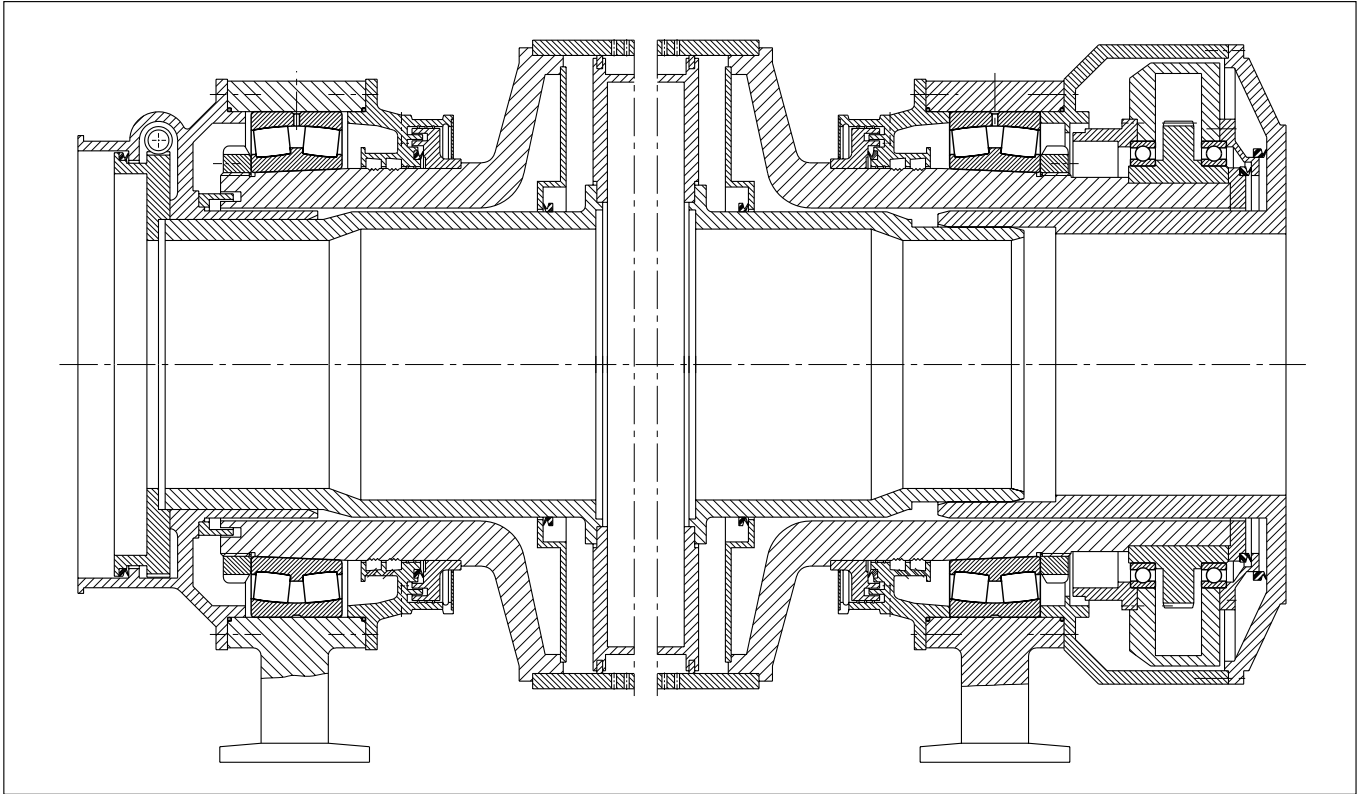

# Examples of bearing arrangements for paper machines

## Wet end section

### 3.1.3 Center press roll

The paper web runs through the press rolls on a felted cloth and a large amount of water is pressed out of it. One or more (suction) press rolls are pressed against the center press roll in modern press sections. The center press roll is solid, made of granite/steel or steel with a protective cover.

#### Technical data

Roll length 8,800 mm; roll diameter 1,500 mm; speed 1,450 m/min; roll weight 750 kN. Pressure by 3 rolls at 30°, 180° and 210°; bearing temperature about 60 °C. Direct drive.

#### Bearing selection, dimensioning

Self-aligning spherical roller bearings of the series 231 or 232 with a very high load carrying capacity are chosen due to the high radial load and the misalignment which is possible between the bearing locations.

A low bearing height is also important for these bearings since the height of the housing is restricted by the roll diameter.

The roll weight and the load components of the pressure rolls yield a resulting bearing load  $F_r = 300$  kN.

A spherical roller bearing FAG 231/600K.MB.C3 is mounted at both sides. The bearings with tapered bore (taper 1:12) are pressed directly onto the tapered shaft seat by means of the hydraulic method.

The floating bearing arrangement at the operator's end permits temperature-dependent length variations of the roll by shifting the outer ring in the housing. The locating bearing is at the drive end.

The nominal life calculated is  $L_h > 100,000$  h with a rotation of  $308 \text{ min}^{-1}$ . With good lubrication (viscosity ratio  $\kappa \approx 3$ , basic factor  $a_{23II} = 3$ ) and improved cleanliness (contamination factor  $V = 0.5$ ) in the lubricating gap  $L_{hna} \gg 100,000$  h according to the adjusted rating life calculation.

#### Machining tolerances

The inner ring has circumferential load and is attached to the tapered bear-

ing seat. Roundness tolerance IT5/2 (DIN ISO 1101); taper angle tolerance AT7 (DIN 7178).

Housing bores according to G7 since there is point load at the outer ring.

#### Lubrication

Circulation lubrication (minimum oil quantity 7 l/min) with a mineral oil (ISO VG 100), which contains EP additives and additives with good anti-corrosive properties and water separation ability.

An effective lubrication is achieved with an oil supply to the centre of the bearing. Oil return on both sides of bearing via oil collecting pockets and connecting holes.

#### Sealing

Oil splash grooves in the roll journal prevents oil escaping at the cover passage. Non-rubbing and maintenance free gap-type sealing protect the bearings from environmental influences.

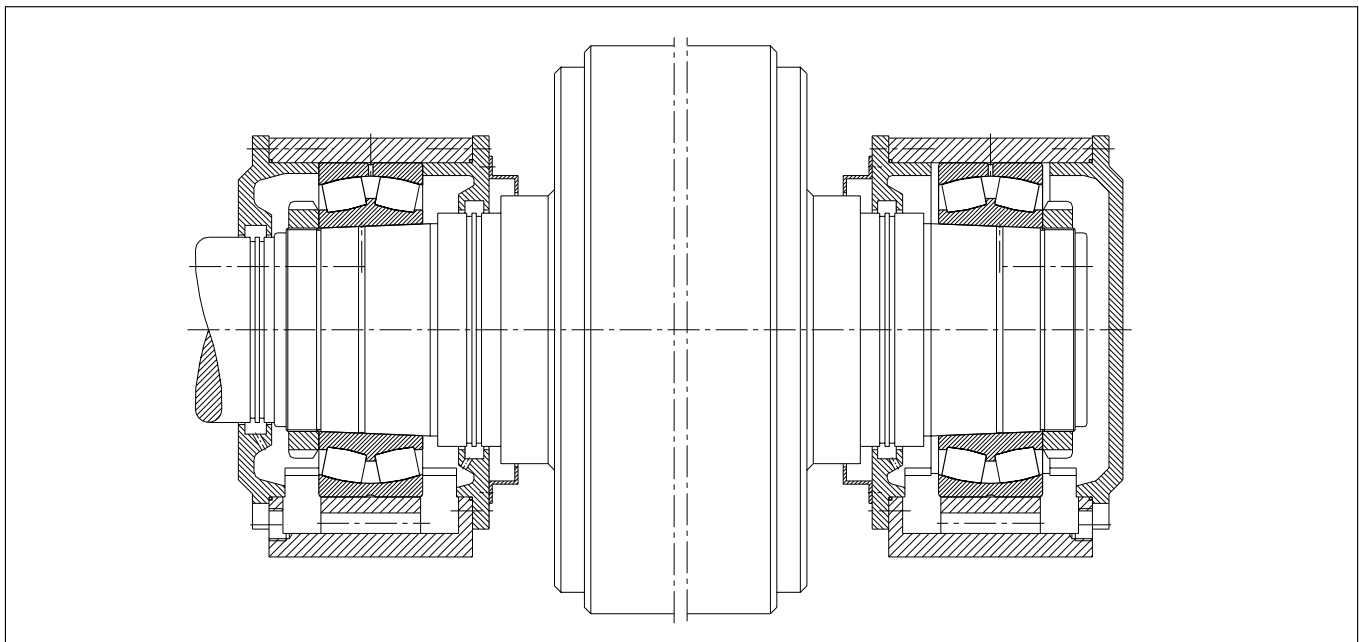

### 3.1.4 Anti-deflection roll

In the press sections and calenders, anti-deflection rolls provide for an even paper thickness across the web and a consistently high paper surface quality. The drive is found at the locating bearing end. Its power is transmitted via gearing and the curved teeth coupling to the roll shell.

The adjustment roll is pressed against the mating roll (calender roll) under very high pressure. As a result the mating roll is bent and the form of the roll shell changed. The shell of the adjustment roll must adjust to this form.

The anti-deflection roll consists of a stationary axle and a rotating roll shell. Control elements which can be pressure-balanced separately are provided on the axle. They support the roll shell hydrostatically and effect its adjustment. The roll shell is formed like the bent mating roll by the changing pressure giving the paper an even thickness.

#### Technical data

Roll length 9,300 mm; roll diameter 1,025 mm; roll weight 610 kN; shell

weight 210 kN; pressure 700 kN; circumferential velocity 1,500 m/min ( $n = 470 \text{ min}^{-1}$ ); bearing temperature 55 °C.

#### Bearing selection, dimensioning

Spherical roller bearings FAG 23096MB.H140 (dynamic load rating  $C = 3,800 \text{ kN}$ ) are used. Required life:  $> 100,000 \text{ h}$ . The bearing only has a guidance function when in operation (with pressure and closed gap).

Due to the danger of slippage bearings of the series 239 with a low load rating should be selected.

The bearings have a reduced radial runout (specification T52BW as part of H140), since running inaccuracy of the rotating roll shell influences the quality of the paper web.

#### Machining tolerances

Bearing seats on the axle according to f6 due to point load for the inner rings.

Tight fit (housing bore according to P6) due to circumferential load for the outer rings. The outer ring lubrication holes are closed because of hydraulic dismounting.

#### Lubrication

When dynamic misalignment and/or slippage may occur, a very good lubricant must always provide a load-carrying lubricating film. The bearings are lubricated with the lubricating oil used for the hydraulic system (ISO VG 150 with EP additives).

In new designs and particularly with heated rolls, the oil is fed via lubricating holes in the inner ring into the bearings directly at the contact areas.

Separate oil circuit for the deep groove ball bearings in the transmission.

#### Sealing

The bearings are sealed to the outside with a shaft seal. To the inside a baffle plate provides for an oil reservoir in the bearing area.

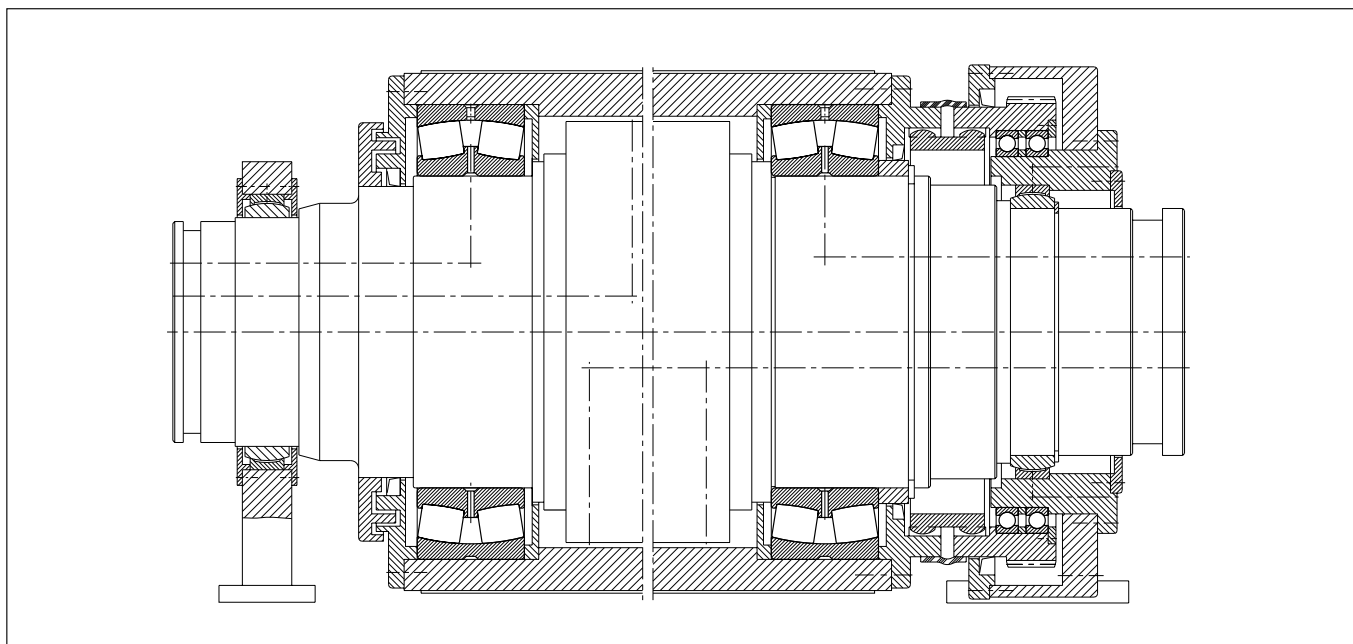

# Examples of bearing arrangements for paper machines

## Dryer section

### 3.2 Dryer section

#### 3.2.1 Guide roll

Guide rolls guide, as the name indicates, and turn the wire and felt cloth in the wet end and dryer sections of a paper machine. The same bearings are used for the guide rolls in both areas. Lubrication and sealing differ, however, depending on the place of application.

In old machines the wet end section is usually lubricated with grease, and the dryer section with oil.

In new machines both areas have oil circulation lubrication. Due to different operating conditions separate oil circuits are necessary for the wet end and dryer section.

The larger the machine the more often it is found to be faster. For this reason the

bearing inner rings are mounted with a tapered bore directly on the tapered roll journal.

#### Wet end section

Depending on the positions of the bearings in the machine they are subject to a small or large degree of moisture. Water must not penetrate the housing, particularly when machines are being high-pressure cleaned.

#### Dryer section

Environmental temperatures of about 95 °C lead to great changes in length and place high demands on lubrication. The operating temperature of the bearings can be up to 115 °C.

#### Technical data

Working width 8,800 mm; roll diameter 700 mm; paper speed 1,650 m/min ( $n = 750 \text{ min}^{-1}$ ); roll weight  $F_G \approx 80 \text{ kN}$ ; web tension 1 kNm (tensile strength  $F_z \approx 9 \text{ kN}$ ); wrap angle 180°; bearing temperature approx. 105 °C.

#### Bearing selection, dimensioning

The bearings must be able to accommodate loads and compensate for misalignment at the same time (misalignment, deflection). An increased radial clearance according to C3 is necessary due to temperature differences.

Spherical roller bearings FAG 22330EDK.C3 are mounted.

Courtesy of Beloit





Bearing load:

$$P = (F_G + F_z)/2 = (80 + 9)/2 = 44.5 \text{ kN}$$

The diameter of the roll journal is determined by the roll rigidity required. As a result there is a high index of dynamic stressing  $f_L$  corresponding to a nominal life  $L_h$  of well over 200,000 hours. The attainable life is even higher for the given lubrication conditions.

The housings can be in standing or suspended position or can be laterally screwed on. They are designed for oil circulation lubrication.

### Machining tolerances

The inner rings have circumferential load and are directly fitted to the tapered roll journal. The roll journals have oil

grooves so the bearings can be mounted and dismantled with the hydraulic method.

Roundness tolerance IT5/2 (DIN ISO 1101); taper angle tolerance AT7 (DIN 7178).

Bearing seats in the housing bore according to G7.

### Lubrication

In the dryer section: see example 3.2.2 (dryer roll) since the bearings are connected to the oil circuit of the dryer rolls. Minimum flow rate 0.9 l/min.

In the wet end section: see examples 3.1.2 (suction roll) and 3.1.3 (center press roll), since the bearings are connected to the oil circuit of the wet end section rolls. Minimum flow rate 0.5 l/min.

### Sealing

Gap-type seals, which are non-rubbing and maintenance-free, prevent oil from escaping through the cover passages bores in the dryer section.

The bearings in the wet end section must have refillable labyrinth seals to prevent water from penetrating. Remaining oil is thrown off via splash grooves into collecting chambers and directed back. Cover sealings (O-rings) make the housing oilproof.

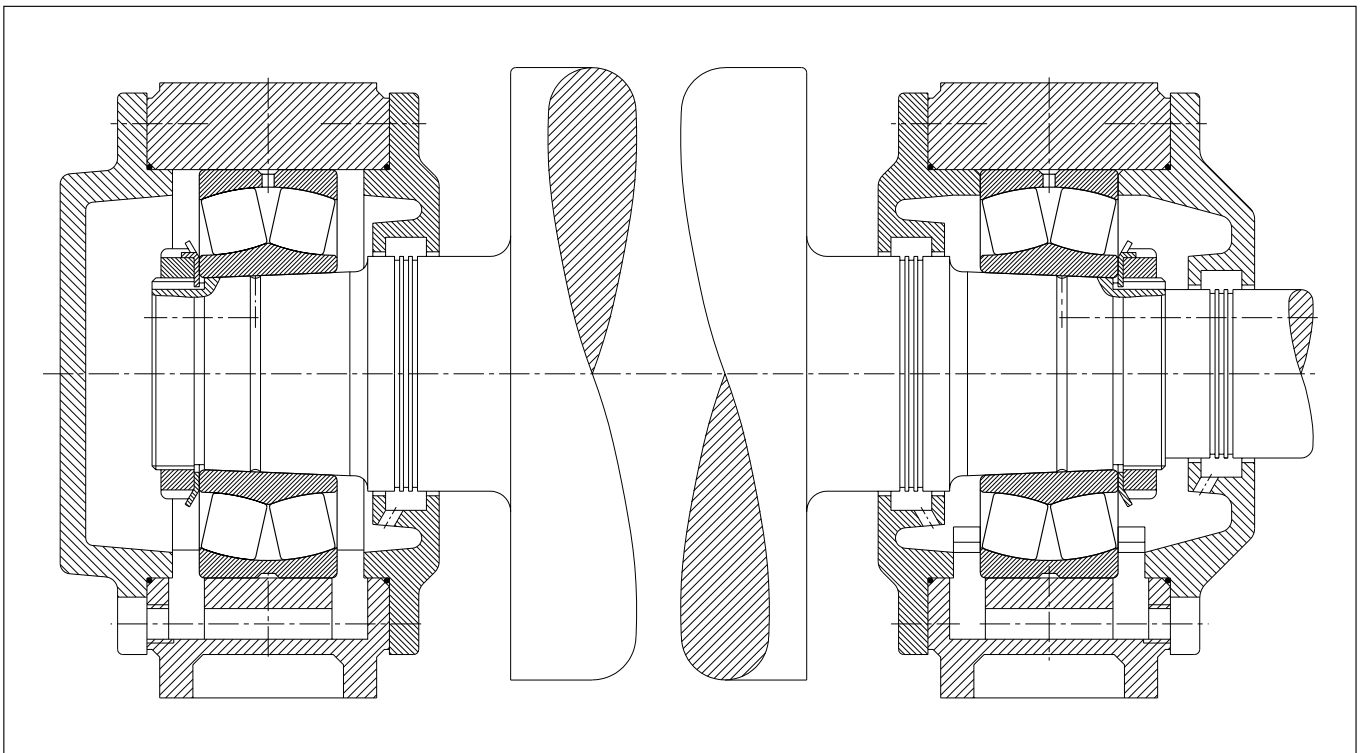

# Examples of bearing arrangements for paper machines

## Dryer section

### 3.2.2 Dryer roll

The remaining water is evaporated in the dryer section. The paper runs over numerous heated dryer rolls guided by endless dryer wires (formerly dryer felts). The dryer rolls are steam heated (temperature depends on the type of paper, its thickness and speed, and on the number of dryer rolls). The high temperatures of the heating steam transfer to the bearing seats stressing the rolling bearings accordingly. Today, the journal through which the steam flows is insulated in order to keep the bearing temperatures low.

#### Technical data

Working width 5,700 mm; roll diameter 1,800 mm; paper speed 1,400 m/min (rotation 248 min<sup>-1</sup>); heating temperature 165 °C (7 bar); roll weight 90 kN.

Felt pull 4.5 kN/m; wrap angle 180°; environmental temperature below the dryer section hood approx. 95 °C; insulated journal bores.

#### Bearing selection

The bearing load is calculated from the roll weight, felt pull and temporary water fill. The floating bearing is loaded with 75 kN, the locating bearing with 83 kN taking into account the drive force. Heating the dryer roll leads to heat expansion which in turn leads to considerably great changes in length with such long rolls. Self-aligning rolling bearings are necessary due to the misalignment arising between both bearing locations.

A double-row cylindrical roller bearing of the dimension series 31 is provided

as floating bearing at the operator's end. It easily compensates for length variations in the bearing between the rollers and the inner ring raceway. With its spherical sliding surface a plain spherical bearing's seating ring accommodates any alignment inaccuracy of the journal. A double-row self-aligning cylindrical roller bearing FAG 566487K.C5 with the dimensions 200x340x112 mm is mounted.

A spherical roller bearing FAG 23140BK.MB.C4 is mounted as locating bearing on the drive end.

Both bearings have about the same operating clearance in order to avoid any detrimental preload during the heating-up stage which may lead to a maximum temperature difference of 50 °C. The spherical roller bearing has an increased radial clearance according to C4 (260...340 μm), the cylindrical roller bearing an increased radial clearance according to C5 (275...330 μm).

Both bearings have a tapered bore (K 1:12) and are mounted by the hydraulic method directly onto the tapered journals.

Since the cylindrical roller bearing and the spherical roller bearing have the same dimensions unsplit PMD plummer block housings (FAG PMD3140AF or BF) are applied both at the drive end and at the operator's end.

Due to increased operating temperature, both bearings are given special heat treatment (isotemp) and are thus dimensionally stable up to 200 °C.

#### Bearing dimensioning

An attainable life  $L_{hna} \geq 250\,000$  hours is requested for dryer roll bearings.

Lubrication decisively influences the adjusted rating life.

Under an average operating temperature of 100 °C the operating viscosity  $v \approx 16$  mm<sup>2</sup>/s for a mineral oil with a nominal viscosity of 220 mm<sup>2</sup>/s (ISO VG 220).

The rated viscosity is determined from the speed and the mean bearing diameter  $d_m = (200 + 340)/2 = 270$  mm to  $v_1 = 25$  mm<sup>2</sup>/s.

The viscosity ratio is then:  
 $\kappa = v/v_1 = 16/25 = 0.64$ .

With the value  $K = 1$  a basic factor  $a_{23II} = 1.1$  is obtained for the spherical roller bearing.

The values  $K = 0$  and  $a_{23II} = 1.4$  apply to the cylindrical roller bearing.

With normal cleanliness (cleanliness factor  $s = 1$ ) the factor  $a_{23} = a_{23II} \cdot s$  is 1.1 for the spherical roller bearing and 1.4 for the cylindrical roller bearing.

The attainable life  $L_{hna} = a_1 \cdot a_{23} \cdot L_h$  is therefore well over 250,000 h for both bearings.

#### Machining tolerances

The inner rings have circumferential load and have a tight fit on the tapered roll journal. The journals have oil grooves so the bearings can be mounted and dismounted by means of the hydraulic method. Roundness tolerance IT5/2 (DIN ISO 1101), taper angle tolerance AT7 (DIN 7178). Bearing seats in the housing bore according to G7.

## Lubrication

The bearing housings are connected to a central oil circulation lubrication system so that heat is constantly withdrawn from the bearing. High-grade mineral oils ISO VG 220 or 320 are used which must have a high operating viscosity, thermal stability, good protection against wear, good water separation ability and a high degree of cleanliness. A minimum oil quantity of 1.6 l/min is

guided directly to the centre of the bearing via a lubricating groove and lubricating holes in the outer ring.

The oil can be carried off at both sides of the bearing due to the center feed oil supply. The danger of oil retention and leakage thus is minimized considerably. Any contaminants or wear particles which might penetrate the bearing are immediately washed out of it with this method of lubrication.

## Sealing

Gap-type seals, which are non-rubbing and maintenance-free, are provided as sealing for the journal passages. The oil is thrown off via splash grooves and oil collecting chambers and flows back through return holes to the two oil cavities on the housing floor. Cover seals (O-rings) make the housing of the paper machine oilproof.

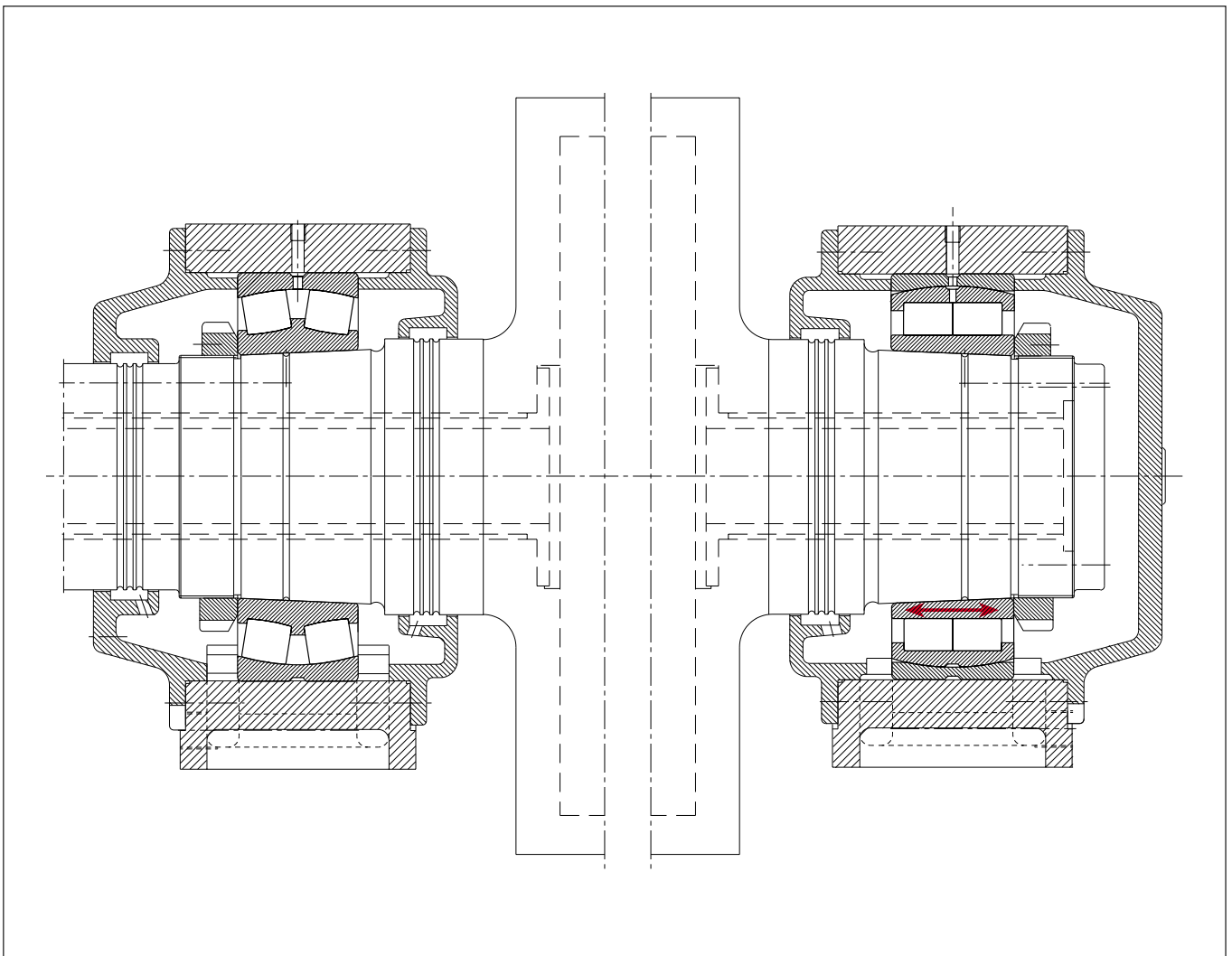

# Examples of bearing arrangements for paper machines

## Calender and finishing group

### 3.3 Calender and finishing group

Courtesy of Valmet



#### 3.3.1 Calender thermo roll

The paper passes through the so-called calender stack after leaving the dryer section. Soft calenders smooth the surface of the paper thus improving its printability. The calender consists of two pairs of rolls. One calender roll (steel) lies above a counter roll, another below one. The counter roll is the so-called anti-deflection roll (elastic material). Soft calender rolls can be heated by water, steam, or oil. The gap or the "nip" pressure depends on the type of paper.

#### Technical data

Working width approx. 7 m; rotation  $350 \text{ min}^{-1}$  (speed 1,100 m/min); heated by oil at 200...250 °C; insulated roll journal; operating temperature at bearing inner ring 130 °C.

#### Bearing selection, dimensioning

The radial bearing load depends on the application of the calender roll as lower or upper roll, on the weight  $F_G$  and the variable pressure load with percentage of time.

$$\begin{aligned} P_1 &= F_G + F_{\text{nip min}} &&= 600 \text{ kN} \\ P_2 &= F_G + F_{\text{nip med}} &&= 990 \text{ kN} \\ P_3 &= F_G + F_{\text{nip max}} &&= 1260 \text{ kN} \\ P_4 &= F_G - F_{\text{nip min}} &&= 60 \text{ kN} \\ P_5 &= F_G - F_{\text{nip med}} &&= 390 \text{ kN} \\ P_6 &= F_G - F_{\text{nip max}} &&= 720 \text{ kN} \end{aligned}$$

Percentages of time:  $P_1, P_4$  : 10% each  
 $P_2, P_3, P_5, P_6$  : 20% each

The sum of the roll weight and the nip load acts for the application as bottom roll whereas only their difference acts decisive for the application as top roll.

Taking the maximum load for design- ing the bearing would lead to overdimen-

sioning (equivalent dynamic load  $P < 0.02 \cdot \text{dynamic load rating } C$ ) in the case of application in the top roll. Slippage may occur with such a low load which in turn can lead to bearing damage when lubrication is inadequate. In order to avoid this problem, smaller bearings with a smaller dynamic load rating  $C$  should be selected so that  $P/C > 0.02$ . The risk of breaking through the lubricating film drops with the smaller rolling element mass. In critical cases it is recommended to use bearings with coated rollers.

Requirements with respect to load carrying capacity and self-alignment are met by spherical roller bearings.

The construction height of the bearing is limited by the diameter of the roll journal and roll outside shell. The relatively wide spherical roller bearings FAG 231/560AK.MB.C4.T52BW are mounted.

The nominal life  $L_h = 83,000 \text{ h}$  with given loads and percentages of time.

With a lubricating oil ISO VG 220 the viscosity ratio is  $\kappa = 0.71$  at an operating temperature of 130 °C. An attainable life  $L_{hma} > 100,000 \text{ h}$  is obtained with the adjusted rating life calculation (where  $f_{s^*} > 12$ ;  $a_{23II} = 1.2$ ;  $V = 0.5$ ;  $s = 1.6$ ).

The increased radial clearance C4 is required due to the danger of detrimental radial preload in the bearing during the heating up phase when the temperature difference is great. With a speed index  $n \cdot d_m = 224,000 \text{ min}^{-1} \cdot \text{mm}$  we recommend bearings with increased running accuracy according to specification T52BW.

#### Machining tolerances

The inner rings have circumferential load and are directly fitted on the tapered roll journal. The roll journals have oil grooves so that the hydraulic method can be applied for mounting and dismounting the bearings.

# Examples of bearing arrangements for paper machines

Calender and finishing group

Roundness tolerance  
IT5/2 (DIN ISO 1101),

taper angle tolerance  
AT7 (DIN 7178).

Bearing seats in the housing bore  
according to F7.

## Lubrication

Oil circulation lubrication with a synthetic oil ISO VG 220, suitable in quality, which has stood dynamic testing on the FAG test rig FE8.

By supplying a large amount of oil to the centre of the bearing (minimum oil flow rate 12 l/min) heat dissipation is achieved as well as a low thermal stress of the oil. Any contaminants or wear particles are washed out of the bearing. Oil returns to both sides of the bearing via oil collecting pockets and connecting holes.

## Sealing

Angle rings at the roll side prevent direct oil escape at the cover holes. Remaining oil is thrown off via splash grooves into collecting chambers and directed back. Cover sealings (O-rings) make the housing oilproof.

Courtesy of Voith

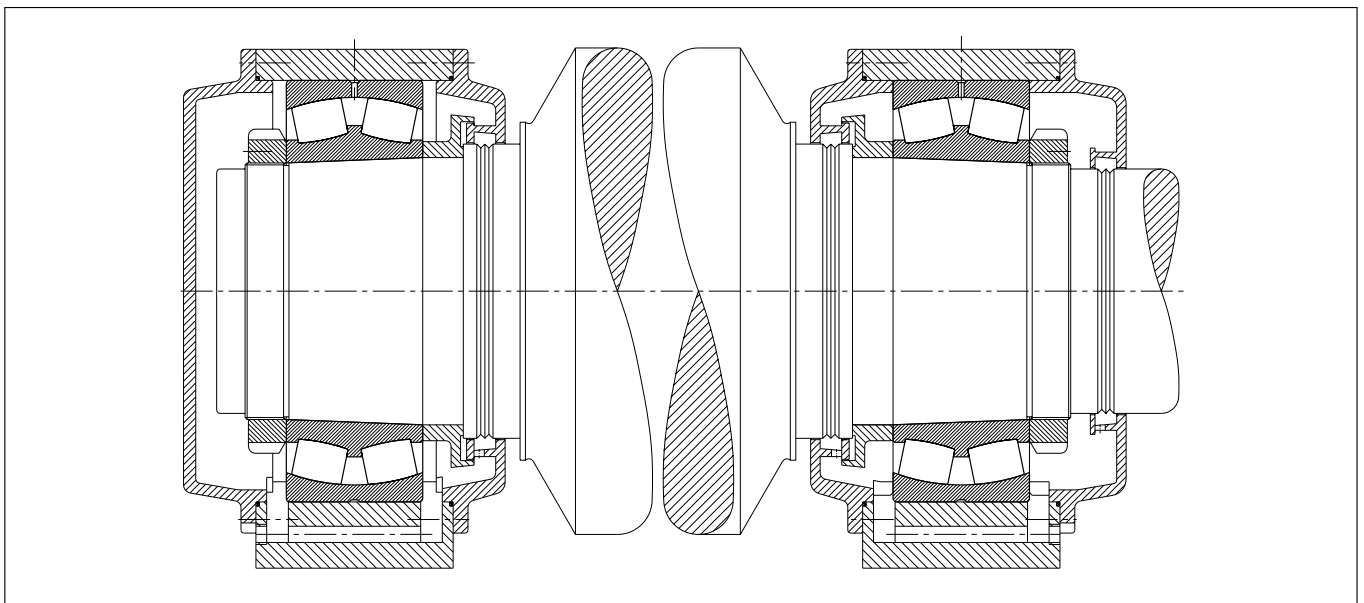

# Examples of bearing arrangements for paper machines

## Calender and finishing group

### 3.3.2 Spreader roll

Paper webs which are transported in lengthwise direction tend to develop creases. Spreader rolls stretch or expand in cross direction the webs running over them. They flatten creases and any middle or end parts of the web. Spreader rolls consist of a stationary axle which is bent symmetric to its longitudinal axis, and around which the roll shell rotates. Tube-shaped sections make up the roll shell and are arranged to rotate freely and have angular freedom. The sections adjust to one another in such a way that the bending form of the axle is reflected on the shell surface. Depending on the case of application – wet end section, dryer section, or finishing/converters – the sections are made of stainless steel or provided with a flexible cover (e. g. rubber).

#### Technical data

Roll length 8,300 mm, consisting of 22 sections; weight/section plus wire or paper web tension at 30° wrap angle 2 kN; a radial load of just 0.5 kN per bearing results therefrom. Rotation of roll shell 1,160 min<sup>-1</sup>.

Operating temperature in the wet end section 40 °C; in the dryer section and in

finishing with infrared drying temperatures can reach up to 120 °C.

#### Bearing selection, dimensioning

With rotating outer ring, extremely smooth running is required from the bearings since the sections in the wet end section and in the dryer section or finishing/converters are only driven by the wire tension and the paper web respectively.

High operational reliability is also necessary since the failure of one bearing alone means that the whole spreader roll has to be dismantled.

FAG 61936.C3 deep groove ball bearings are mounted. For new high-speed applications ( $n \cdot d_m$  values 0.6 to 1 · 10<sup>6</sup> min<sup>-1</sup> · mm) deep groove ball bearings with ceramic balls (hybrid bearings) are selected. The increased radial clearance C3 permits easy alignment of the sections. With the low load, the bearings have a nominal life  $L_h$  of well over 100,000 hours.

#### Machining tolerances

As the outer ring of the bearing rotates with the roll shell it is given a tight fit

with M6 tolerance and is secured axially by a snap ring.

The inner ring has point load and is fitted to the shaft sleeve with h6. Due to the bent roll axle and for assembly reasons the sleeve is loosely fitted and axially positioned with a bolt.

#### Lubrication

The bearings are greased for life, i. e. no relubrication is provided for. The selection and filling quantity of lubricating grease is determined by the demand for smooth running as well as a service life of up to five years (8,000 operating hours per year). Low-friction greases (e.g. FAG grease Arcanol L75) are advantageous with high speeds and low loads.

#### Sealing

Non-rubbing dust shields are used for sealing due to the smooth running required. They are stuck to the bearing outer ring on both sides so the base oil centrifuged from the lubricating grease cannot escape. O-rings also provide for oil tightness.

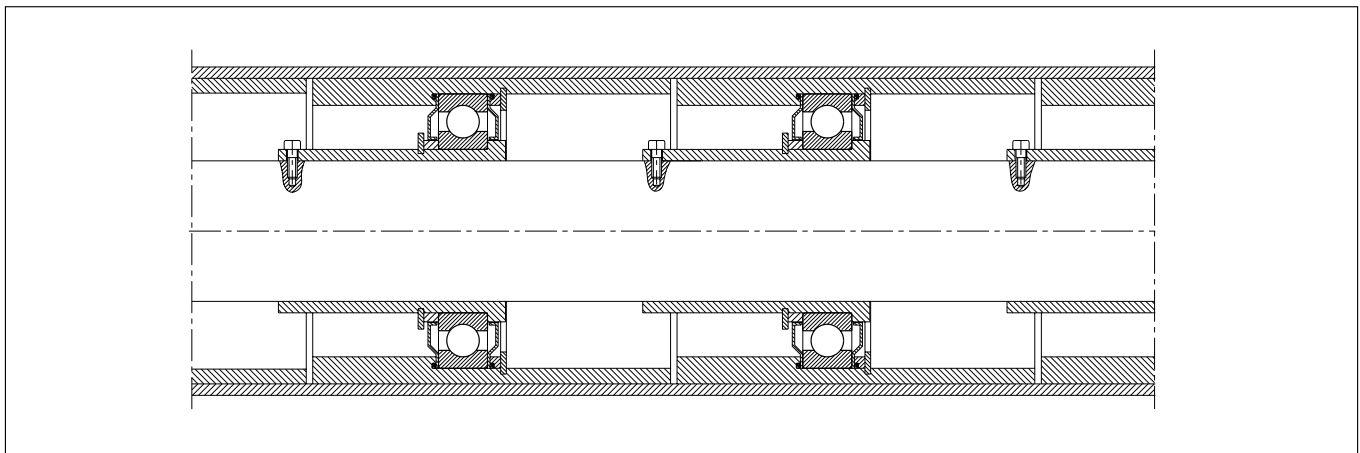

## 4 FAG service for more operational reliability

FAG has a complete package of service equipment and services. Working with bearings is facilitated by FAG measuring and mounting devices such as the diagnosis device which monitors the condition of the bearings plus the FAG mounting and diagnosis service on site when mounting and monitoring jobs prove difficult.

Application engineering at FAG provides advice and training in relation to all aspects of rolling bearing technology.

### 4.1 Storage of rolling bearings

Rolling bearings should be left in their original packaging until directly before mounting so as to prevent contamination and rust. Large bearings such as those found in paper machines are stored in a separate dry room in horizontal position with a support around the entire circumference.

Rolling bearing packing including the anti-corrosion agent are such that the bearing's properties can be preserved for a long period. It is ensured that the anti-corrosion agent is compatible with the lubricants popular in the paper industry and it is not required to be washed out prior to mounting.

During storage, bearings must not be subject to any aggressive media such as gases, mist, or aerosols of acids, caustic solutions and salts. Direct sunlight must also be avoided as large fluctuations in temperature may arise in the packaging.

Under standard preservation conditions the permissible storage period is up to 5 years. FAG provides upon request information on special preservation and the usability of older bearings.

Please refer to the catalogue WL 41 520 "FAG Rolling Bearings" for more detailed information on the storage of FAG rolling bearings and greases.

### 4.2 Preparations for mounting and dismounting

The necessary preparation for mounting and dismounting rolling bearings is presented in detail in the FAG publica-

tion WL 80 100 "Mounting and Dismounting of Rolling Bearings".

Prior to unpacking the bearings all mating parts required should be checked for their dimensional and form accuracy.

An outside micrometer is generally used to check the shaft seats of larger bearings.

An inside micrometer or bore measuring devices are used to check the housing bores.

### Checking a housing bore with an inside micrometer

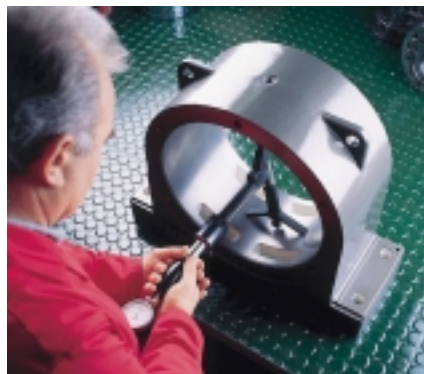

### 4.3 Mounting and dismounting with cylindrical and tapered mating surfaces

General information on mounting and dismounting rolling bearings is provided in the FAG publication WL 80 100 "Mounting and Dismounting of Rolling Bearings".

Thermal and hydraulic methods are usually used for mounting bearings in the paper industry.

#### 4.3.1 Mounting and dismounting with cylindrical mating surfaces

**Mounting:** Bearings which require a tight fit on a cylindrical shaft are heated up and then shrunk on. For the most common fits (cf. section 4.4) a temperature of 80 to 100 °C suffices for heating up. The permissible maximum mounting temperature of 120 °C must not be exceeded in order to avoid changes in dimensions and a reduction in hardness.

**Induction heating devices** allow speedy, clean and safe heating. The FAG heating device AWG 3,5 (compare also TI No. WL 80-47) is suitable for rolling bearings with 20 mm bore or more and weighing up to 40 kg.

### FAG induction heating device AWG 3,5



Rolling bearings of all sizes and types can also be heated in oil baths. Disadvantage: accident hazard, pollution of the environment by oil vapours, inflammability of hot oil, danger of bearing contamination, expensive disposal of used oil. The heated bearing parts are moved to the stop quickly and without tilting. After pushed on, the inner ring is clamped on and held until cold.

Large bearings are usually transported by crane. The bearing is then suspended in a mounting tongs.

**Dismounting:** Mechanical extractors or hydraulic presses are suitable for withdrawing smaller bearings.

During dismounting, inner rings should only be heated up with the **ring burner** in emergency cases when there are no oil grooves and holes for the hydraulic method. Utmost care must be given as the rings are sensitive to non-uniform heating and local overheating.

Bearings can also be pressed off cylindrical seats by means of the **hydraulic method** (see section 4.3.2).

# FAG service for more operational reliability

## Mounting and dismounting

### 4.3.2 Mounting and dismounting with tapered mating surfaces

**Mounting:** Rolling bearings in paper machines are nowadays mostly mounted directly on tapered journals. Large and wide machines with a high paper speed require high running accuracy. The direct seat is advantageous since there are only two mating surfaces.

When running accuracy requirements are not so high adapter or withdrawal sleeves are used whereby four mating surfaces are involved.

The required tight fit is achieved by pressing on the inner ring or pressing in the withdrawal sleeve between inner ring and shaft. The reduction in radial clearance due to expansion of the inner ring indicates whether a suitable tight fit has been reached.

The radial clearance is first measured prior to mounting. While pressing on, the clearance is checked constantly until the required value is achieved. It is also possible to measure axial displacement in place of measuring the reduction in radial clearance.

Feeler gauges are used to measure the radial clearance. It must be ensured that the radial clearance is measured over both rows of rollers at the same time in the case of spherical roller bearings. Only when the clearance values at both rows are the same can it be certain that the inner ring is not laterally displaced in relation to the outer ring.

#### Measuring the radial clearance of large spherical roller bearings

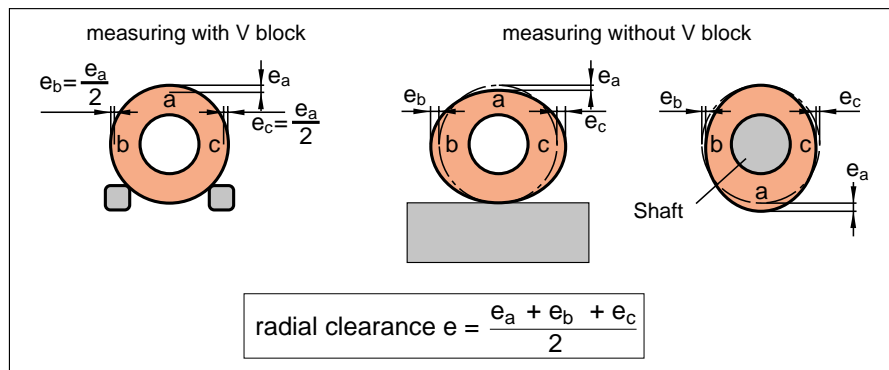

The radial clearance of large spherical roller bearings ( $d > 500$  mm) is measured at three points because of the ring deformation, see scheme.

**Hydraulic nuts** are used for pressing large-size bearings onto the tapered seat or for pressing in the withdrawal sleeves. Please see also publ. no. WL 80 103 "FAG Hydraulic Nuts". The nut is screwed onto the shaft thread or sleeve thread. While pressing in oil, the annular piston presses the bearing onto the tapered seat or sleeve between bearing bore and shaft.

If the radial clearance cannot be measured with feeler gauges, the FAG displacement measuring instrument RKP.MG can be used. It is screwed to the face of the hydraulic nut.

#### Hydraulic nuts



The **hydraulic method** greatly facilitates the mounting and particularly the dismounting of bearings with a bore of about 160 mm or more. Oil grooves and holes as well as connection threads for pressure generators must, however, be provided. Please refer to FAG publ. no. WL 80 102 "How to Mount and Dismount Rolling Bearings Hydraulically" for more information.

Oil with a viscosity of  $\approx 75$  mm<sup>2</sup>/s at 20 °C (nominal viscosity 32 mm<sup>2</sup>/s at 40 °C) is recommended for **mounting**. Only a little oil is required when the bearing seat is directly on the tapered journal. Simple oil injectors with low volume suffice.

Large-size adapter or withdrawal sleeves (designs HG or H, see catalogue WL 41 520) have oil inlet holes and oil grooves for the hydraulic method. The oil loss arising at the edges of the mating surfaces make a greater oil supply necessary and a pump must be used.

The hydraulic method is particularly advantageous when **dismounting** large-size bearings. As soon as a continuous oil film has formed between the mating surfaces the bearing ring is released abruptly from the shaft due to the resulting axial force. An axial stop should be provided in order to prevent accidents.

Simple oil injectors with low volume suffice for dismounting bearings which are directly on the tapered journal whereas a pump is required when the sleeves are fastened on.

Oil with a viscosity of  $\approx 150$  mm<sup>2</sup>/s at 20 °C (nominal viscosity 46 mm<sup>2</sup>/s at 40 °C) is recommended for dismounting. If the mating surfaces are damaged a gear oil with high viscosity with  $\approx 1,150$  mm<sup>2</sup>/s at 20 °C (nominal viscosity 320 mm<sup>2</sup>/s at 40 °C) can be used. Fretting corrosion can be dissolved by adding rust-removing additives to the oil.



### 4.4 Fits and tolerances

General guidelines on selecting the correct fit can be found in the FAG Catalogue WL 41 520.

The G7 tolerance is commonly used for the housing bore; paper machine housings of the series PM30, PMD, PMDR and PMF are machined according to G7, for example.

In the case of tapered journals the taper diameter must be determined so that the bearing is at the right spot on the shaft once pressed on. When determining the taper diameter – the reference dimension is the small diameter – the expansion necessary to obtain a tight inner ring fit must be taken into consideration. This radial expansion of the inner ring decreases the radial clearance of the bearing. It must be borne in mind that even with solid steel shafts, the radial clearance is not reduced by the entire amount of interference of the tapered seat. Even smaller amounts of expansion result with hollow shafts and shafts made of cast iron. In such cases the taper diameter must be accordingly larger. The dimensional tolerances of the bearings and the machining tolerances of the shaft must also be taken into account. The axial displacement is appropriately based on the changes in distance between the face of the taper at the small diameter and the inner ring. The following tables indicate the recommended dimensional and form tolerances.

### Tolerances of tapered shaft seats

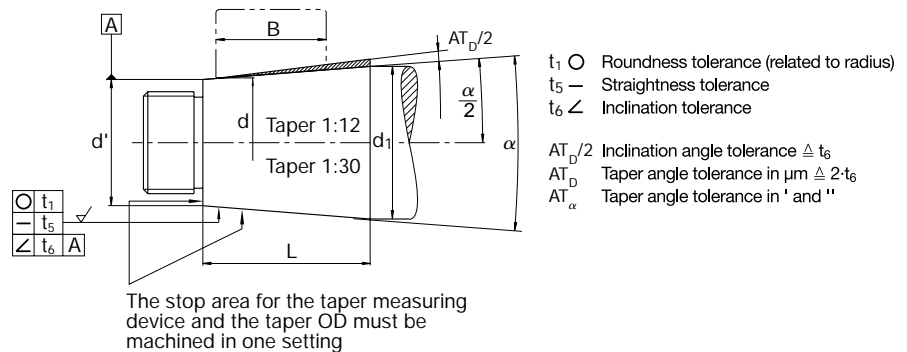

Nominal dimension of shaft		Dia tolerance k6		Roundness tolerance (IT5)/2 DIN ISO 1101	Straightness tolerance IT3
over mm	to	min $\mu\text{m}$	max	$\mu\text{m}$	$\mu\text{m}$
<b>80</b>	<b>120</b>	+3	+25	7.5	6
<b>120</b>	<b>180</b>	+3	+28	9	8
<b>180</b>	<b>250</b>	+4	+33	10	10
<b>250</b>	<b>315</b>	+4	+36	11.5	12
<b>315</b>	<b>400</b>	+4	+40	12.5	13
<b>400</b>	<b>500</b>	+5	+45	13.5	15
<b>500</b>	<b>630</b>	0	+44	14.5	(17)
<b>630</b>	<b>800</b>	0	+50	16	(19)
<b>800</b>	<b>1000</b>	0	+56	18	(21)

(values in brackets according to FAG)

### Tolerances of taper angle

Nominal dimension of bearing width B		Taper angle tolerance acc. AT7 (DIN 7178)	
over mm	to	$AT_\alpha$ angular seconds	$AT_D$ $\mu\text{m}$
<b>40</b>	<b>63</b>	+65	0/+12.5...0/+20
<b>63</b>	<b>100</b>	+52	0/+16...0/+25
<b>100</b>	<b>160</b>	+41	0/+20...0/+32
<b>160</b>	<b>250</b>	+33	0/+25...0/+40
<b>250</b>	<b>400</b>	+26	0/+32...0/+50

# FAG service for more operational reliability

## Fits and tolerances

### Calculation of small taper diameter with roll journals

$$d' = d + \Delta R \cdot 1/(d_m/h) \cdot 1/f_i \cdot w + G' + \Delta_{dmp}/2 + L \cdot 1/k \text{ [mm]}$$

- d' Small taper diameter of journal [mm]
- d Nominal bearing bore diameter [mm]
- $\Delta R$  Mean value of radial clearance reduction (table 1) [mm]
- $d_m/h$  Wall thickness ratio of inner ring (table 2)
- $1/f_i$  Correction factor for steel hollow journals (diagram 3)  
= 1 for solid shafts
- w Correction factor for different journal materials  
(diagram 4)
- G' Smoothing value in relation to diameter =  $2 \cdot 0.6 \cdot R_z$  (table 5) [mm]
- $\Delta_{dmp}$  Tolerance of nominal bearing bore diameter (table 6) [mm]
- L Distance between face of mounted bearing and of journal [mm]  
(standard case: face of mounted bearing abuts with face of journal,  
e. g. L = 0)
- $1/k$  Taper ratio (= 0.0833 for taper 1:12/ = 0.0333 for taper 1:30)

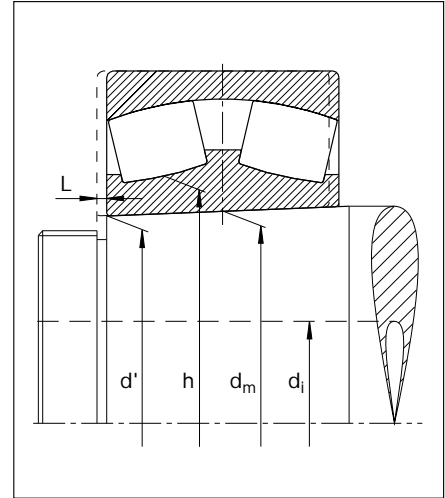

**Table 1: Radial clearance reduction  $\Delta R$**

Nominal bore diameter		Radial clearance reduction			
d	to	spherical roller bearings		cylindrical roller bearings	
over	mm	min	max	min	max
mm		mm		mm	
50	65	0.03	0.04	0.03	0.035
65	80	0.04	0.05	0.035	0.04
80	100	0.045	0.06	0.04	0.045
100	120	0.05	0.07	0.045	0.055
120	140	0.065	0.09	0.055	0.065
140	160	0.075	0.1	0.06	0.075
160	180	0.08	0.11	0.065	0.085
180	200	0.09	0.13	0.075	0.095
200	225	0.1	0.14	0.085	0.105
225	250	0.11	0.15	0.095	0.115
250	280	0.12	0.17	0.105	0.125
280	315	0.13	0.19	0.115	0.14
315	355	0.15	0.21	0.13	0.16
355	400	0.17	0.23	0.14	0.17
400	450	0.2	0.26	0.15	0.185
450	500	0.21	0.28	0.16	0.195
500	560	0.24	0.32	0.17	0.215
560	630	0.26	0.35	0.185	0.24
630	710	0.3	0.4	0.2	0.26
710	800	0.34	0.45	0.22	0.28
800	900	0.37	0.5	0.24	0.31
900	1000	0.41	0.55	0.26	0.34

**Table 2: Wall thickness ratio for inner rings where  $d > 50$  mm**

Bearing series	$d_m/h$
<b>Spherical roller bearings</b>	
239	0.91
230	0.88
231	0.85
232	0.83
240	0.88
241	0.87
222	0.84
223	0.78
<b>Cylindrical roller bearings</b>	
NU10	0.87
NU2	0.85
NU3	0.78
NU4	0.73
NU30	0.89

**Diagram 3: Correction factor  $1/f_i$  for hollow journals (steel)**

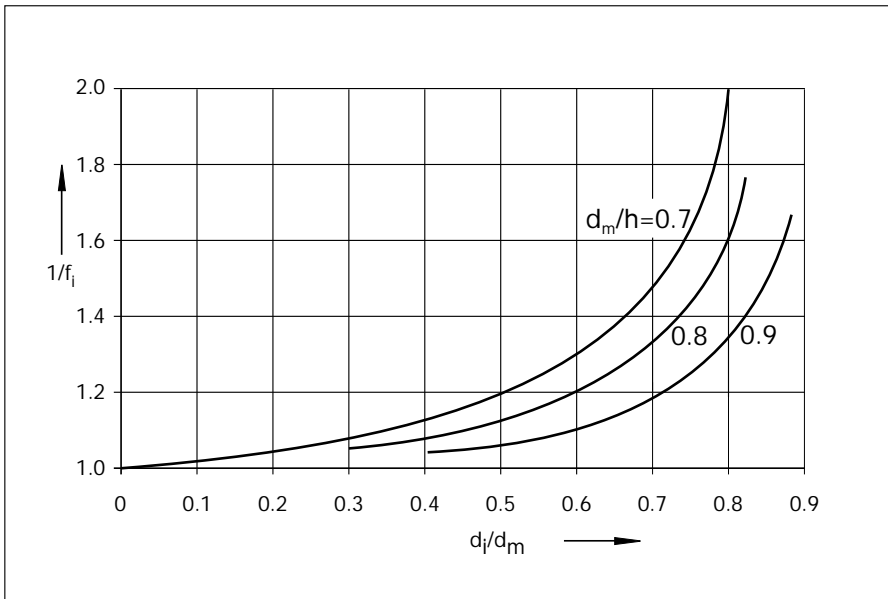
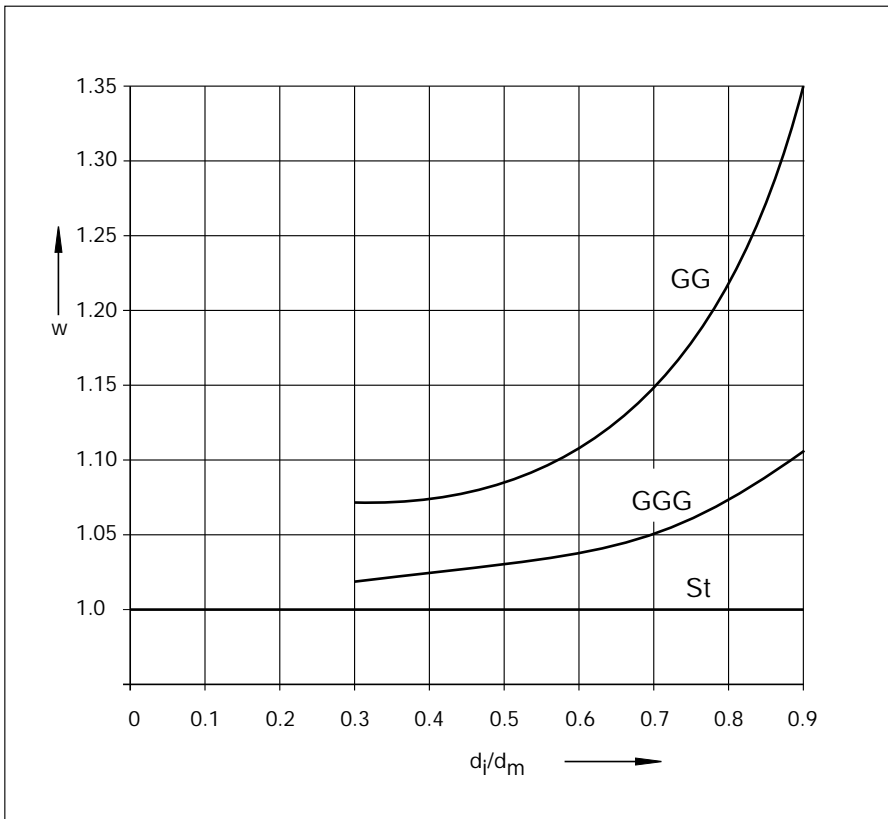

**Table 5: Smoothing value  $G'$  in relation to diameter**

Machining	Smoothing $G'$ mm
polished	0
very finely ground	0.001
ground	0.0025
very finely turned	0.005
finely turned	0.007

**Diagram 4: Correction factor  $w$  for different materials**

GG = grey cast iron; GGG = spheroidal graphite cast iron; St = steel



**Table 6: Tolerance  $\Delta_{dmp}$  of bearing bore**

Nominal bore diameter over to mm	Tolerance $\mu\text{m}$
50 80	0/+30
80 120	0/+35
120 180	0/+40
180 250	0/+46
250 315	0/+52
315 400	0/+57
400 500	0/+63
500 630	0/+70
630 800	0/+80
800 1000	0/+90

# FAG service for more operational reliability

## Monitoring and analysing bearings

### 4.5 Monitoring and analysing bearings

Rolling bearings in paper machines must be monitored in order to avoid high repair costs and lost production. The service life of the bearings and the availability of the machine can be optimally used only when the bearings are maintained in relation to their condition. This presupposes, however, recognition of bearing damage on time, evaluation of the extent of damage and development of the progress in damage. Condition-related maintenance means that the bearing can be replaced during a scheduled stop of the machine, thus avoiding unnecessary downtime.

#### 4.5.1 FAG Detector 2000

The FAG Detector is mainly of interest for bearings in the peripherals of paper machines where hardly any disturbing influences by other machine parts are expected.

The handy, cost-effective measuring device, is easy to use with just eight keys. First the acceleration sensor is attached to the bearing location to be monitored.

First, the acceleration sensor has to be attached to the bearing location to be monitored. After a round of taking measurements, the measured values that are used to evaluate the condition of machine or component are transferred to a com-

puter where they are interpreted, analysed and displayed graphically by the software "FAG 2000".

For every measuring point the software compares the newly measured values with the alarm-triggering limiting values specified for this measuring point. If one of these threshold values is exceeded this is indicated by the software.

Newly added values can be displayed graphically versus the measuring time.

Trend analyses help users to assess when an alarm is likely to be triggered.

More detailed information on the Detector 2000 will be provided on request.

#### 4.5.2 FAG Bearing Analyser 2000

An efficient damage diagnosis system based on envelope detection has been one of the numerous FAG services for many years. Operators have the opportunity of purchasing the Bearing Analyser diagnosis device from FAG with which they can permanently monitor the condition of their plants themselves.

The first hint of bearing damage is generally given by changes in vibration. They are registered and evaluated by the FAG Bearing Analyser. The handy and user-friendly vibration analyser functions according to the long-proven envelope

detection method. It diagnoses all damage which causes noise, e.g. cracks, pittings, indentations or dirt. The acceleration sensor connected to the portable device measures vibrations up to 20 kHz.

Once current speed and bearing data have been entered, the expert system evaluates them and displays to the user with a high degree of reliability whether or not the bearing is damaged. The higher the progress of damage, which can be determined by means of trend measurements, the more frequent the monitoring before bearing exchange is a must.

More detailed information on the "FAG Bearing Analyser" will be provided on request.

#### 4.5.3 VibroCheck system

FAG's online monitoring system "VibroCheck" allows a large number of measuring locations to be monitored continuously with the PC. Vibration sensors at the bearing location conduct signals to monitoring modules (VC modules). The signals are transferred via PC to the control station of a paper mill or per modem to an FAG service station if required. When a warning limit has been reached, an expert system makes an automatic diagnosis with the same degree of reliability as the analyser (section 4.5.2).

#### FAG Detector 2000



#### FAG Bearing Analyser 2000



#### FAG VibroCheck

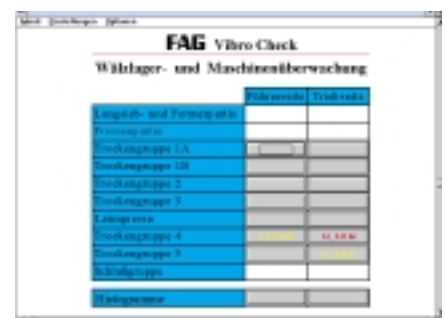

## 4.5.4 Bearing analysis

The cause of damage and the possibility of avoiding more failures in the future must be clarified when a damaged bearing is dismantled from a machine. The bearing must be sent for inspection to

FAG if the cause of failure cannot be determined by either the operator of the paper machine or an FAG representative on the spot.

The following data must be provided when returning damaged bearings:

1. Company Name, Address, Dept.
2. Application
- 2.1 Machine
- 2.2 Exact mounting location (e.g. guide roll, dryer section, locating or floating bearing)
- 2.3 Machine manufacturer
- 2.4 Service period
- 2.5 Machine data (product, length, width)
- 2.6 Number of previous bearing failures at this location/section
3. Operating conditions
  - roll diameter
  - paper speed
  - roll length
  - rotation
  - radial (axial) load
  - daily running period
  - lubrication (type, oil type, grease type, quantity, relubrication interval)
  - drawing of bearing location (fits, sealing etc.)
4. Bearing
  - code (with all suffixes)
  - life until failure (mounted when?)
  - mounted by whom?
  - appearance of damaged bearing (inner ring, outer ring, rollers, cage)
  - photos and sketches if available
  - how was the damage recognised?

Detailed information on failure analysis and inspection of used bearings can be found in FAG publ. no. WL 82 102 "Rolling Bearing Damage"

**Pressure polished raceway and first stages of wear in the outer ring of a spherical roller bearing; mounted at the operator's end of a dryer roll. Cause: amount of water in lubricating oil too high.**

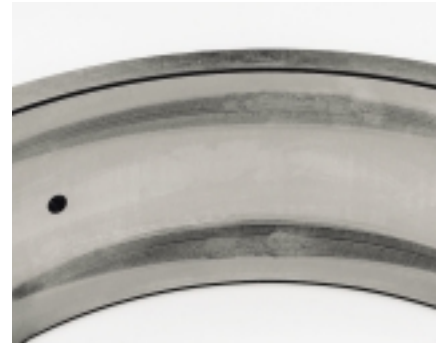

**Slippage damage on a barrel roller of a spherical roller bearing; mounted in a suction roll. Cause: too low load and unsuitable lubricating grease**



**Static corrosion in the outer ring raceway of a spherical roller bearing. Cause: amount of water in lubricating grease too high**



# FAG service for more operational reliability

PC programs · Mounting service · Training

## 4.6 PC programs for calculating and designing rolling bearings

The strive towards more operational reliability commences long before bearings are mounted. The selection of the correct bearing is always the first step.

The **FAG catalogue on CD ROM** is a far more efficient means of selecting and calculating rolling bearings than the actual printed book itself. The user has a complete consulting system which leads him or her – with Windows user guidance – to the list of FAG standard bearings ready for order. Both the nominal life and the adjusted life can be calculated as well as permissible speed, cycling frequencies (important for bearing diagnosis), heat balance and required oil volume.

With the version 2.0 of the catalogue on CD ROM a DXF file of the selected bearing can be generated and imported into CAD drafting programs. Complete pages with bearing tables can be printed, also the performance data, the dimension plan and the abutment dimensions of single bearings.

FAG also supplies numerous special **calculation programs**. The following can be calculated for example:

- changes in bearing clearance
- bearing elasticity and rigidity
- shaft bending.

Please refer to TI no. WL 49-41 for more information on these PC programs.

## 4.7 FAG mounting service

Upon request, FAG fitters/Service Engineers mount all bearings in the paper industry, check mating parts (roll journals, housings), search for faults when bearings are not running perfectly, dismount bearings, train maintenance staff

and provide advice on rationalisation measures for mounting procedures. Fitters/Service Engineers also assist when selecting suitable tools and show users the equipment and processes involved.

## 4.8 FAG training courses

A good standard of technical knowledge helps to increase the service life of bearings and to avoid failures.

For years now, FAG has provided practical training, courses and seminars on the theme of rolling bearings. They are held at FAG, at FAG distributing partners', and directly in the paper mills. Seminars on the spot are advantageous in that the participants save both travelling expenses and the time getting there and back.

Training modules for paper mills are:

- Basic bearing seminars
- Mounting and dismounting training
- Lubrication guidelines
- Damage analysis seminars
- Tailor-made in-house seminars

## FAG training



FAG developed the Software **W.L.S.** with interactive program guidance for learning alone at the computer. This learning program conveys solid basic knowledge on the properties of the diverse bearing types, the system of coding, on mounting bearings and avoiding bearing damage. The dialogue-oriented learning program takes more and more individual training and further training in companies into consideration. The complete software package is suitable for all those involved with rolling bearings whether in Purchasing or Materials Management, Designing and Development or in Maintenance.

## FAG rolling bearing learning system W.L.S.



Several **FAG video films** are available for training, instruction, and service, such as:

- mounting and dismounting rolling bearings
- hydraulic method for mounting and dismounting large rolling bearings
- induction heating device for mounting large rolling bearings
- bearing replacement with FAG split spherical roller bearings 222SM.

Please see TI no. WL 00-11 for more films.

## 4.9 A selection of other FAG publications

### Catalogue

WL 41520 FAG Rolling Bearings

### Publ. No.

WL 13 111 Self-aligning Cylindrical Roller Bearings for Dryer Rolls/M.G. Cylinders and Guide Rolls of Paper Machines  
WL 13 112 A Partnership in Paper  
WL 13 501 Bearing arrangement of an M.G. cylinder of a papermaking machine  
WL 13 502 FAG Spherical Roller Bearings in a Wood Grinder  
WL 13 503 FAG E spherical roller bearings in felt guide rolls in the dryer section of papermaking machines  
WL 13 504 Increased capacity of a Finnish papermaking machine  
WL 13 505 Refiner Bearings Arrangement with FAG Cylindrical Roller Bearings  
WL 13 506 Creeping cylinder bearings in a tissue paper making machine  
WL 13 507 Increasing the Output of Papermaking Machines by Converting the Dryer Section to FAG Rolling Bearings  
WL 13 508 FAG split spherical roller bearings in dryer rollers of papermaking machines reduce downtimes for bearing replacement  
  
WL 13 509 FAG deep groove ball bearings for spreader rolls in papermaking machines  
WL 13 510 Considerable energy reduction by conversion of dryer rolls in papermaking machines from sliding bearings to rolling bearings  
  
WL 13 511 Dryer Roll Bearings have worked reliably in a Finnish Cardboard Mill for more than 10 years  
WL 13 512 FAG Split Spherical Roller Bearings in Paper Mill Agitators Reduce Downtime  
WL 13 513 FAG Hybrid Bearings for Spreader Rolls  
WL 13 514 FAG Self-Aligning Ball Bearings for Fly Rolls in Calenders  
WL 43 165 FAG Split Spherical Roller Bearings  
WL 80 100 Mounting and Dismounting of Rolling Bearings  
WL 80 102 How to Mount and Dismount Rolling Bearings Hydraulically  
WL 80 103 FAG Hydraulic Nuts  
WL 80 137 Rolling bearing diagnosis with the FAG bearing detector  
WL 80 141 Rolling bearing diagnosis with the FAG bearing analyser  
WL 80 151 Repair service for large rolling bearings  
WL 81 115 Rolling Bearing Lubrication  
WL 82 102 Rolling Bearing Damage  
  
TI No.  
WL 13-1 Housings for Dryer Rolls in Paper-Making Machines  
WL 13-2 PMF Housings for Guide Rolls in Paper Machines  
WL 43-1192 FAG Triple Ring Bearings for the Paper-Making Industry  
WL 49-41 PC Calculation Programmes  
WL 62-1 "Doping" for the Surface  
WL 80-14 Mounting and Dismounting of Spherical Roller Bearings with Tapered Bore  
WL 80-46 FAG Hand Pump Sets  
WL 80-47 FAG Induction Heating Devices  
WL 80-48 FAG Mechanical Extractors

# Dimensioning and lubricating rolling bearings

## Dimensioning

### 5 Dimensioning and lubricating rolling bearings

#### 5.1 Dimensioning

Rolling bearings are checked for meeting demands on life and cost-efficiency by means of the dimensioning calculation. Bearings in paper machines are dynamically stressed as a rule. The rings of such bearings rotate relative to one another.

The calculation of the nominal life  $L_h$  for dynamically stressed bearings is provided in detail in the catalogue WL 41 520 "FAG Rolling Bearings". Of the operating conditions only the load and the speed are taken into account with this process. The attainable life really depends, however, on a number of other influences.

Based on the adjusted life calculation according to DIN ISO 281, FAG developed a refined process to determine the attainable life  $L_{hna}$  with which the operating conditions, particularly the cleanliness effect in the lubricating gap, can be expressed in figures. The process for calculating the attainable life is described in the catalogue WL 41 520.

#### Recommended values for dimensioning

Recommended values for the attainable life  $L_{hna}$  are indicated in the following table for the various mounting locations in machines and equipment used in the production of paper. The  $L_h$  life values reached so far are also provided for reasons of comparison. They largely correspond to the recommendations made by TAPPI (Technical Association of the Pulp and Paper Industry, USA). As an example a recommended value for  $L_h$  of 285,000 hours is indicated for dryer rolls. For old non-insulated journal bearing arrangements an attainable life  $L_{hna}$  of about 100,000 hours results where factor  $a_{23} = 0.35$ . In modern machines with standard journal insulation an  $L_{hna}$  value

of more than 250,000 hours is expected, an unusually high service life.

In contrast, the service life expectation for bearings in the wet end section is well below 15 years as changes and modernizations are common within this time.

Enormous differences in operating speeds as in the case of dryer rolls for example, play an important role when designing. They are less than 800 m/min for board machines and up to 1,800 m/min for dryer rolls for newspaper machines.

We recommend determining first  $L_h$  for the roll with the highest load taking the design speed ( $n_D$ ) into consideration and the equivalent dynamic load  $P$  (see page 31).

The real operating speed and thus the lowest viscosity ratio  $\kappa$  should be taken into consideration for calculating the  $L_{hna}$  value.

Please see reference values in diagram on the page 31 for the operating temperature of dryer roll bearings (inner ring).

#### Recommended values for dimensioning rolling bearings found in paper production

Application	Attainable life $L_{hna}$ *) h	years**)
<b>Wet section</b>		
forming rolls, suction rolls, guide rolls, press rolls	> 100 000	> 12
<b>Dryer section (basic demand: <math>L_h &gt; 100\ 000</math> h)</b>		
guide rolls	> 120 000	> 15
dryer rolls	> 250 000	> 30
M.G. Yankee cylinders	> 350 000	> 45
<b>Other parts</b>		
calenders, glazing rolls, reel spool bearings	> 80 000	> 10
anti-deflection rolls	> 80 000	> 10
refiners, pulpers	> 80 000	> 10

\*) calculated with  $a_{23} = a_{23II}$ , i.e.  $s = 1$  for normal cleanliness

\*\*\*) at 8,000 operating hours per year



## Equivalent dynamic load P of bearings in paper machines

G weight of roll/cylinder [kN]

$F_z$  felt pull/wire pull [kN]  
at 180° wrap angle

$f_1 = 1.055$  for temporary filling of dryer and M.G./Yankee cylinders with condensation water

$f_2 = 1.1$  for axial forces acting on locating bearing (drive, pull of oblique felt or wire), when values are not available

### Dryer / M.G./Yankee cylinder, operator's end:

$P = (G/2 + F_z) \cdot f_1$   
additionally: axial displacement force with spherical roller bearing as floating bearing and force from steam joint, with M.G./Yankee cylinder relief by means of pressure rolls

### Dryer / M.G./Yankee cylinder, drive end:

$P = (G/2 + F_z) \cdot f_1 \cdot f_2$   
additionally: radial force from drive and force from steam joint and axial displacement force of floating bearing

### Guide roll

$P = (G/2 + F_z) \cdot f_2$

### Suction roll:

$P = (G/2 + F_z) \cdot f_2$   
additionally: force direction as well as relief or load due to negative pressure in suction box

### Press roll/pressure roll:

$P = (G/2 + F_z) \cdot f_2$   
additionally: force direction as well as relief or load due to other rolls/cylinders

### Calender roll:

$P = G/2 + F_{Nip}/2$   
additionally: position of application, time and load shares (cf. also section 3.3.1)

Reference values for the temperature of bearings in dryer rolls, valid for popular spherical roller bearing sizes lubricated with minimum oil flow rates (section 5.2.2), depending on steam temperature and insulation (correlation steam temperature/steam pressure see 6.1.3 and 6.1.4)

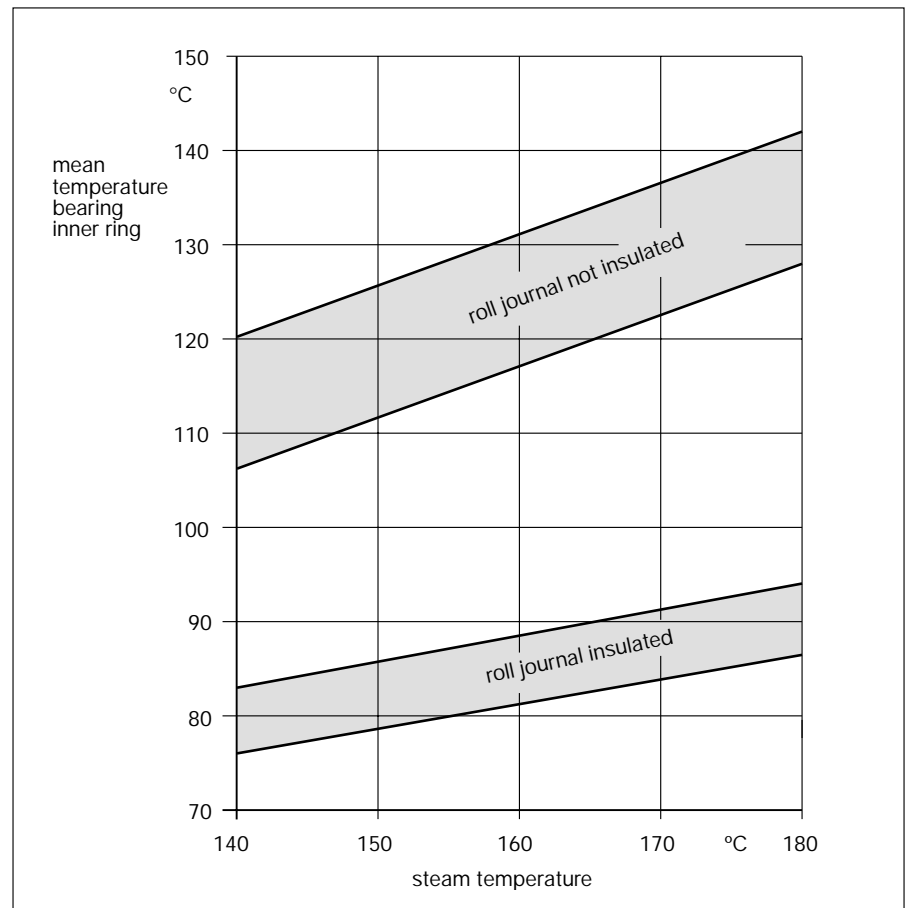

### Correction factor $f_H$ for consideration of operating temperature effect on the load rating of bearings made of chromium steel

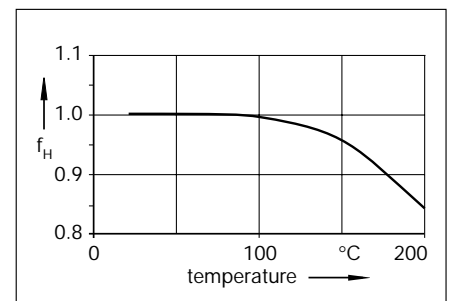

### Correction factor for reduction in hardness

Under operating temperatures > 100 °C the dynamic load rating C must be multiplied by  $f_H$  for bearings in paper machines which are heat-treated to S1 in accordance with standard.

# Dimensioning and lubricating rolling bearings

## Lubrication

### 5.2 Lubrication of rolling bearings

The operating conditions and the consequent demands on lubrication can differ greatly from one bearing location to another in paper machines. For this reason lubrication is dealt with in section 3 under bearing examples. Here, just general views on the lubrication of rolling bearings in paper machines are presented. Rolling bearing lubrication is presented in detail in the FAG publication WL 81 115 "Rolling Bearing Lubrication".

Load, speed and operating temperature of the bearing as well as environmental conditions and operational reliability are decisive for the choice of lubrication system. As a result oil circulation lubrication is generally selected for bearings in modern paper machines whereas grease lubrication is seldom considered.

Heat balance calculations are sometimes of use in order to calculate the loss in bearing efficiency (see publ. no. WL 81 115). How correct such a calculation is depends on previous knowledge of operating data and corresponding values for heat flow conditions.

#### 5.2.1 Grease lubrication

Grease lubrication is possible for small and middle-size bearings if speed and temperatures are not too high. Grease lubrication is advantageous in that the construction is not complex and the grease also provides for sealing. Maintenance is also simple. The remaining service life can be longer when there is a breakdown in lubricant supply. In the case of bearings in paper machines grease lubrication is mainly used for those in the wet end section as temperatures are low and sealing against water and contamination must be kept in mind.

Grease-lubricated bearings in the dryer section where temperatures are high and bearing locations are under great stress are an exception.

### Selection of grease

You will find criteria for selecting grease in the FAG publication number WL 81 115, for example.

Along with the data on grease properties provided by the grease manufacturer, experience in the field of grease applica-

tion are of particular importance. As a result, FAG drew up an outline of requirements and specifications for the dryer section and the wet end section separately. You can receive upon request an updated list of greases recommended by FAG for the wet end section and the dryer section.

### General recommendations for the grease lubrication of bearings in paper machines (wet end section and dryer section)

- Greases according to FAG's outline of requirements (see pg. 33)
- Direct grease supply (for example with spherical roller bearings via lubricating groove and holes in the outer or inner ring)
- Weekly – monthly relubrication depending on environmental effects
- Relubrication quantity according to FAG publ. no. WL 81115/4, pg. 38
$$m_1 = 0.002 \cdot D \cdot B \text{ [g] with manual grease supply}$$
$$m_2 = 1 \cdot [\pi/4 \cdot B \cdot (D^2 - d^2) \cdot 10^{-9} - G/7800] \text{ [kg/h] with automatic grease supply systems}$$

with		
D	bearing outside diameter	[mm]
B	bearing width	[mm]
d	bearing bore	[mm]
G	bearing weight	[kg]
- Grease removal at both sides
- Plenty of relubrication prior to and following downtime
- Avoid mixing different greases if possible, even if compatibility is indicated
- Install short supply pipes
- Protect supply pipes from heat

**Requirements on greases for bearings in the wet end section:**

- very good water resistance
- good sealing effect
- very good anti-corrosive properties
- good lubricating film formation properties
- good compatibility with elastomers and plastics
- multi-metal compatibility
- good oxidation stability
- excellent lubricity also in bearings with complex kinematics by means of a selected thickener and EP additives which are effective in the most diverse bearing types
- high degree of cleanliness
- good conveyance in central lubricating systems (no separation of oil and thickener under pressure, good decompression characteristics, good pumpability behaviour in storage containers)

**Requirements on greases for bearings in the dryer section:**

- excellent oxidation stability
- very good suitability to high temperatures
- no development of residues/deposits in bearings and housings
- very good anti-corrosive properties
- multi-metal compatibility
- good lubricating film formation properties
- excellent lubricity also in bearings with complex kinematics by means of an efficient thickener and effective additives in bearings at most diverse temperatures
- good sealing effect
- good compatibility with elastomers and plastics
- high degree of cleanliness
- easy conveyance in central lubricating systems (no separation of oil and thickener under pressure, good decompression characteristics, good flowing behaviour in storage containers, no coking in pipes)
- good grease escape from the housing
- very long service life

**Grease supply**

The appropriate grease quantity, relubrication intervals based on grease service life, correct designing of bearing lubrication and the suitable mode of lubrication are decisive for an adequate lubricant supply. The fundamental aspects are dealt with in detail in the publication no. WL 81 115.

The diagram with lubrication intervals  $t_f$  shown there is only valid for favourable environmental conditions and standard lithium soap base greases. The effect of temperature and the environment is of particular importance in the case of paper machines.

The reduced lubrication interval  $t_{fq}$  with the overall reduction factor  $q$  (see table, below left) is derived from

$$t_{fq} = q \cdot t_f$$

which takes into account all adverse operational and environmental conditions.

The relubrication interval of 0.5 to  $0.7 \cdot t_{fq}$  should be taken. Experience has shown that relubrication intervals of  $\leq 2$  weeks and of about 4 weeks suffice for bearings in the wet end section (extremely wet locations) and for grease-lubricated bearings in the dryer section respectively.

In the case of spherical roller bearings the fresh grease should always be supplied via the lubricating groove and the lubricating holes in the outer ring to expell the used grease and ensure optimal grease exchange. A completely even distribution on both roller rows is achieved whereby the used grease is expelled from the bearing. This is of particular importance for bearings in danger of corroding in the wet end section. It is not possible to replenish bearings during operation with a rotating outer ring.

Therefore bearings with lubricating holes in the inner ring should be used here in order to supply grease directly to the centre of the bearing. Bearing designs with lubricating groove and holes are recommended; with this design a circumferential lubricating groove on the bearing journal is not necessary.

**Overall reduction factors q**

Bearing location	Overall reduction factor q
<b>Wet end section</b> partially very moist environment	0.1 – 0.3
<b>Dryer section</b> where grease lubricated (e.g. dryer felt guide rolls)	0.3 – 0.4

# Dimensioning and lubricating rolling bearings

## Lubrication

The effect of such measures is frequently underestimated. As experience has shown, the most damage arises in the grease-lubricated bearings of the wet end section due to poor lubricant supply or dilution of the lubricant with water (reduced lubricating effect) and direct corrosion at the functional areas.

Since corrosion can occur during bearing downtime also (due to penetration of water during cleaning or development of condensation) it is advantageous to replenish the bearings thoroughly directly before shutting down the machine or when rolls are put in reserve.

A mixture of different greases should be avoided if possible. Greases with different soap bases should not be mixed. Thorough cleaning with flushing is a must if a different grease type is to be applied.

When a new bearing has been mounted relubrication should be undertaken relatively soon in order to eliminate mounting contamination and running-in wear.

### 5.2.2 Oil lubrication

Oil lubrication is necessary when bearings are expected to heat up very high due to load and speed and/or due to their environment.

**Oil circulation lubrication** preferably used in new paper machinery has the following advantages:

Contaminants do not compile when the oil supply drainage is correctly designed; they are transported to the corresponding oil maintenance equipment (filters, separators, sedimentation pit etc.)

and removed from circulation. Oil stress is reduced with a large total oil volume. Besides, heat dissipates with oil cooling and the bearing temperature drops.

In the case of highly doped mineral oils and synthetic oils compatibility with sealing and cage materials should be kept in mind.

### General recommendations for the lubrication of bearings in paper machines with circulating oils:

- Oils according to the outline of FAG requirements
  - Direct oil supply, via lubricating groove and lubricating holes in the rings of spherical roller bearings and self-aligning cylindrical roller bearings
  - Oil exit on both sides with sufficiently dimensioned drain pipes cross section
  - Avoidance of residual oil sump
  - Minimum flow rates according to FAG recommendations
  - Lubrication monitoring of each individual bearing location
  - Protection of supply pipes from heat
  - Oil supply temperature of max. 50 – 60 °C by means of oil cooling for the dryer section
  - Separate oil supply systems for the different sections of paper machines
  - Effective journal insulation in the case of dryer rolls and thermo rolls
- Note: With the insulation of hollow journals and an adequate oil flow rate as well as recooling, a low bearing temperature can be achieved today and thus sufficient operating viscosity of the lubricating oil. A viscosity ratio  $\kappa < 0.4$  can be anticipated with non-insulated journal bores and low speed and therefore a life factor  $a_{23}$  of 0.35 at a max.
- Settle-down zones and air release facilities in the tank
  - Oil maintenance measures:
    - Rinsing and fine-mesh filtering prior to starting up, after big repair work, bearing damage or complete oil exchange
    - Filtering in main stream with 12  $\mu\text{m}$ , better 6  $\mu\text{m}$ , with a filtration ratio of  $\beta_x \geq 75$ . Additional by-pass filtering with 6  $\mu\text{m}$  and  $\beta_x \geq 75$  increases effectivity with high flow rates considerably.
    - Oil cleanliness class 15/12 according to ISO 4406
    - Water content < 0.03 % weight (300 ppm)
    - Exchange oil on time depending on oil condition (responsibility of the oil supplier)

## Oil selection

Mineral oils and synthetic oils are suitable for lubricating rolling bearings. The selection of the oil depends on the operating conditions present at the bearing location.

FAG specifies the oil requirement in two separate lists for paper machines – one for the wet end section and one for the dryer section.

Requirements on circulating oils for bearings in the **wet end section**:

- high oxidation stability
- good demulsifying ability
- good anti-corrosive properties
- multi-metal compatibility
- hydrolysis stability
- high viscosity index
- high pressure-viscosity coefficient
- effective boundary layer forming additives in rolling bearing
- good compatibility with elastomers and plastics
- keep clean performance
- good filterability
- good compatibility with preservatives
- particularly good long-term suitability

Requirements on circulating oils for bearings in the **dryer section**:

- best oxidation stability
- good demulsifying ability
- good anti-corrosive properties
- multi-metal compatibility
- hydrolysis stability
- high viscosity index
- high pressure-viscosity coefficient
- effective boundary layer forming additives in rolling bearing
- good compatibility with elastomers and plastics

- keep clean performance
- good filterability
- anti-foam properties
- no residue/deposit development and cloudiness of the oil
- particularly good long-term suitability.

You can receive upon request an updated FAG recommendation list of oils for both sections.

## Oil supply

The volume of oil to be supplied in each case depends essentially on the conditions regarding heat elimination and heat supply. With a high speed index ( $n \cdot d_m > 300,000 \text{ min}^{-1} \cdot \text{mm}$ , e.g. with suction rolls) heat balance calculations as in accordance with FAG publ. no. WL 81 115/4 are recommended.

Only a very small oil volume is actually required to lubricate the bearing itself but far greater volumes are selected for safety reasons and to insure that all contact areas have sufficient oil. The volume increases even more if heat dissipation is required.

The advantage of direct lubricant supply via lubricating groove and holes in the rings should be availed of for oil-lubricated bearings as well.

Rolling bearings must be lubricated before going into operation. With circulating oil lubrication, this is achieved by starting the oil pump before the machine is put into operation. Please refer to the diagrams on pages 36 and 37 for oil flow rates recommended by FAG for each of the bearing locations in a paper machine.

## Pressure drop with oil circulation lubrication

As already described, the oil should reach the bearing as directly as possible. As a result the cool oil, with no previous heating, is directed to the contact areas to be lubricated where it heats up and carries off heat. The oil has a higher viscosity due to the low temperature and a better load-carrying lubricating film can build up.

Due to the lubricating grooves in the FAG spherical roller bearings and double row cylindrical roller bearings there is a drop in pressure when the oil volume is large. With a large number of bearings as is the case in paper machines, this must be taken into consideration by providing more pumping capacity when designing the circulation system. The dimensions of the lubricating grooves are decisive for the drop in pressure. The lubricating holes have a negligible effect. By approximation the pressure drop is calculated with the formula

$$\Delta p = 44 \cdot 10^{-5} \frac{H^2 \cdot D}{[(H - t) \cdot t]^3} \cdot Q \cdot v \text{ [bar]}$$

where

Q	oil flow rate	[l/min]
v	oil viscosity	[mm <sup>2</sup> /s]
H	groove width	[mm]
t	groove depth	[mm]
D	bearing outside diameter	[mm]

It is advisable to provide a circumferential groove in the housing in order to reduce the drop in pressure with a large volume of oil. This is also recommended for floating bearings with big axial displacement distances to ensure oil supply.

# Dimensioning and lubricating rolling bearings

## Lubrication

### Minimum oil flow rates for circulation lubrication

for bearings in guide rolls

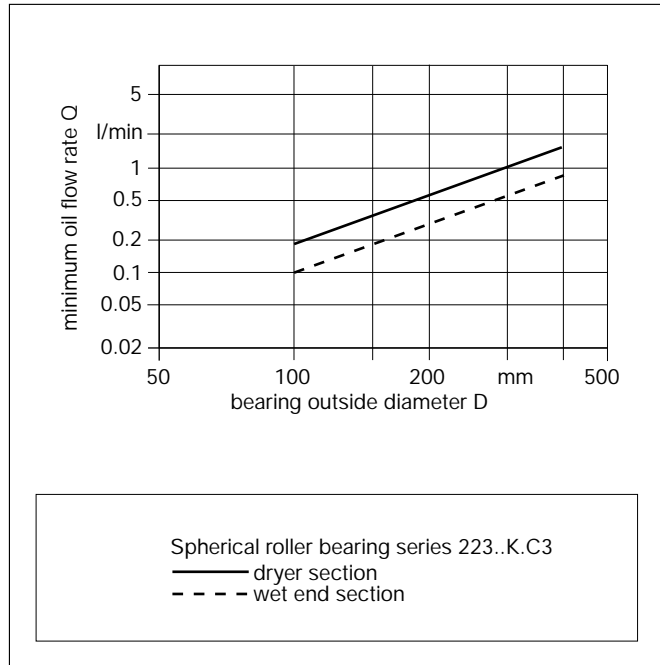

for bearings in dryer rolls and M.G./Yankee cylinders

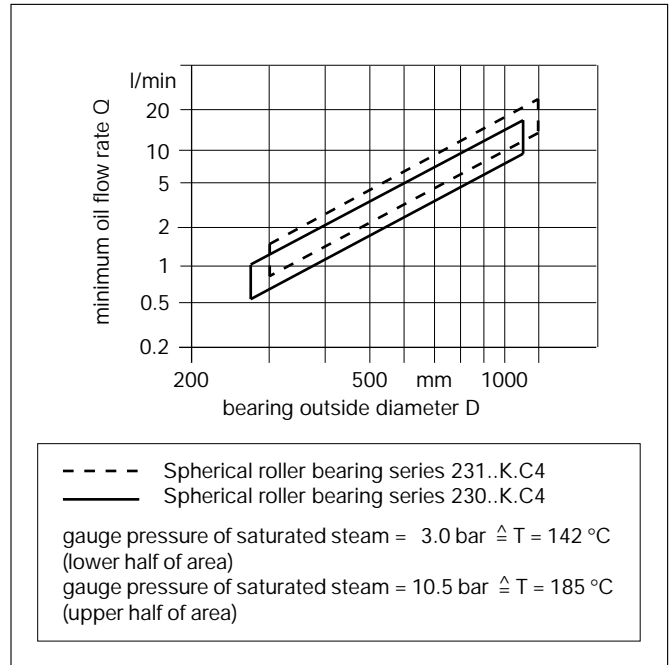

for bearings in wet presses

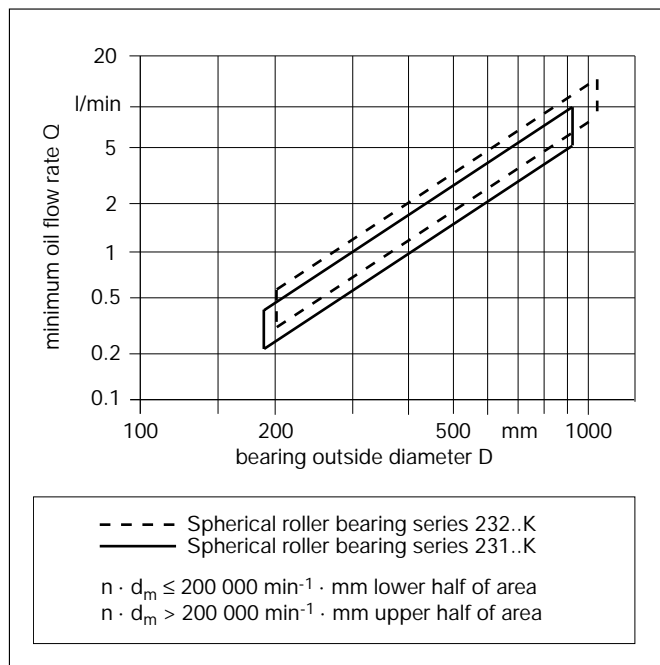

for bearings in suction rolls

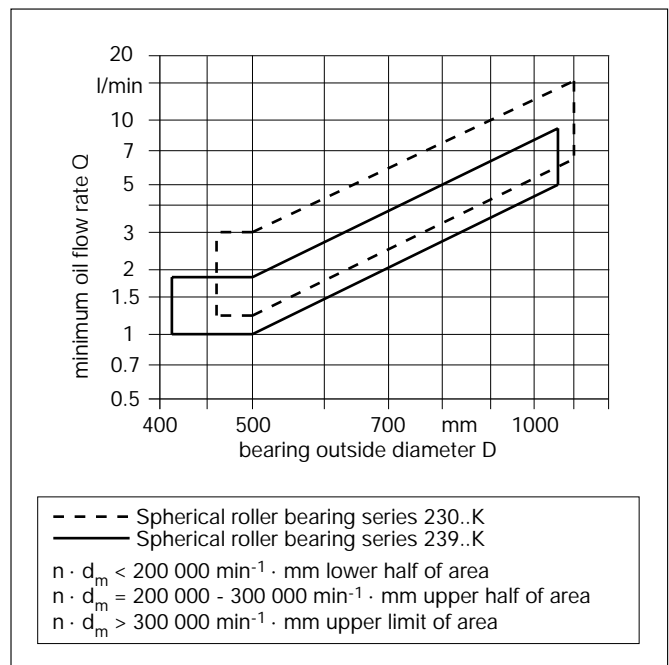

## Minimum oil flow rates for circulation lubrication

for bearings in soft calenders

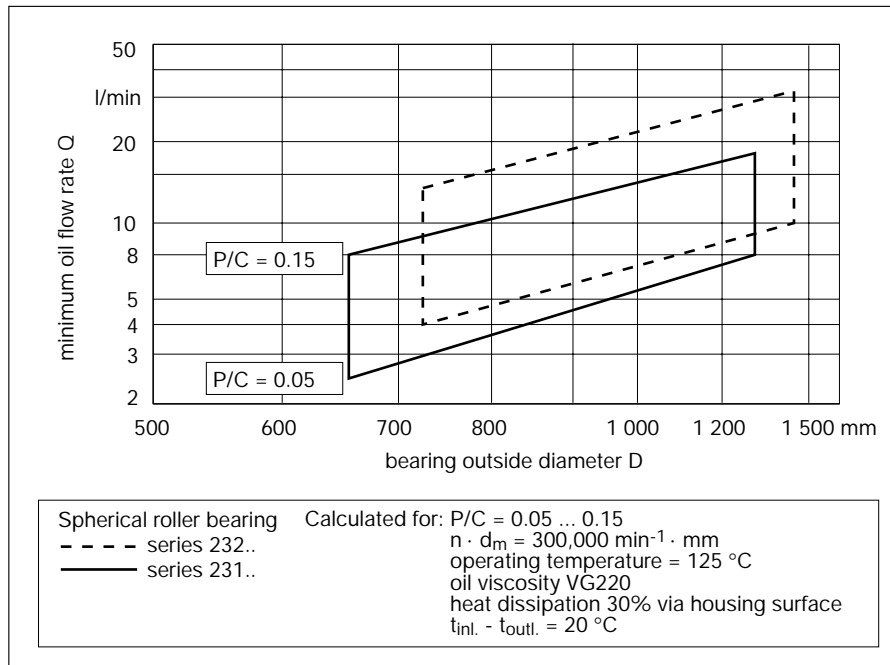

## Oil removal

The design of the oil drainage system is of particular importance in the case of relatively high oil flow rates and reduced bearing temperatures as a result of insulation and cooling.

Oil drains which are not adequately dimensioned and high-viscosity oils can cause an oil leak at the housing especially when the paper machine starts in a cold condition.

In addition to large drain cross sections on both sides of the bearing with adequately dimensioned levelling holes at the lowest point of the housing, the

drainage pipes should be provided with the largest possible slope.

It is also important that the junction where drain pipes later meet is continued with a correspondingly large diameter in order to avoid jamming. The formula

$$d_a = 11.7 \cdot \sqrt[4]{Q \cdot v / G} \text{ [mm]}$$

where

$d_a$	diameter of drain pipe	[mm]
$Q$	oil flow rate	[l/min]
$v$	oil viscosity	[mm <sup>2</sup> /s]
$G$	slope	[%]

is used for more accurate dimensioning in the slope area of the drain pipes from 1 to 5 %.

# Tables

## Conversion

### 6 Tables

#### 6.1 Conversion

##### 6.1.1 Flow rate

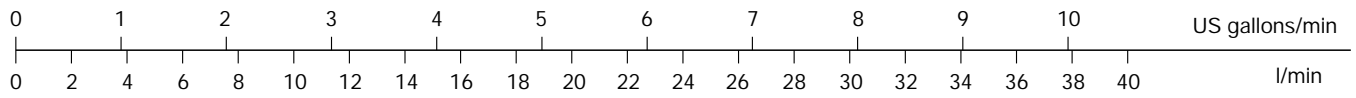

$$1 \text{ US Gallon} = 3.7854 \text{ l}$$

##### 6.1.2 Speed

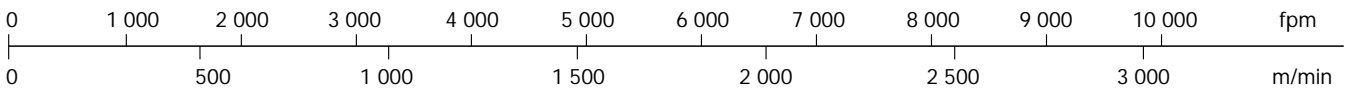

$$1 \text{ fpm} = 0.3048 \text{ m/min}$$

##### 6.1.3 Temperature

$$x \text{ } ^\circ\text{C} = (x \cdot \frac{9}{5} + 32) \text{ } ^\circ\text{F}$$

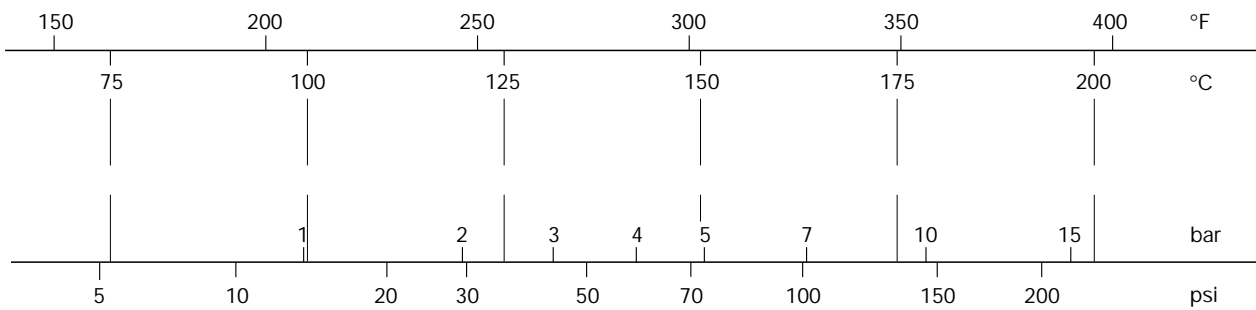

##### 6.1.4 Saturated steam pressure

$$1 \text{ psi} = 0.0689 \text{ bar}$$



### 6.2 Radial clearance

#### 6.2.1 Radial clearance of FAG cylindrical roller bearings

Dimensions in mm

Nominal bore diameter	over to	50 65	65 80	80 100	100 120	120 140	140 160	160 180	180 200	200 225	225 250	250 280	280 315	315 355	355 400	400 450	450 500	500 560	560 630	630 710
-----------------------	---------	----------	----------	-----------	------------	------------	------------	------------	------------	------------	------------	------------	------------	------------	------------	------------	------------	------------	------------	------------

#### with cylindrical bore

Bearing clearance in  $\mu\text{m}$

Clearance group	min max	40 70	40 75	50 85	50 90	60 105	70 120	75 125	90 145	105 165	110 175	125 195	130 205	145 225	190 280	210 310	220 330	240 360	260 380	285 425
Clearance group CN (normal)																				
Clearance group C3		60 90	65 100	75 110	85 125	100 145	115 165	120 170	140 195	160 220	170 235	190 260	200 275	225 305	280 370	310 410	330 440	360 480	380 500	425 565
Clearance group C4		80 110	90 125	105 140	125 165	145 190	165 215	170 220	195 250	220 280	235 300	260 330	275 350	305 385	370 460	410 510	440 550	480 600	500 620	565 705
Clearance group C5		110 140	130 165	155 190	180 220	200 245	225 275	250 300	275 330	305 365	330 395	370 440	410 485	455 535	510 600	565 665	625 735	600 720	620 740	705 845

#### with tapered bore

Bearing clearance in  $\mu\text{m}$

Clearance group	min max	50 80	60 95	70 105	90 130	100 145	110 160	125 175	140 195	155 215	170 235	185 255	205 280	225 305	255 345	285 385	315 425	350 470	380 500	435 575
Clearance group CN (normal)																				
Clearance group C3		70 100	85 120	95 130	115 155	130 175	145 195	160 210	180 235	200 260	220 285	240 310	265 340	290 370	330 420	370 470	410 520	455 575	500 620	565 705
Clearance group C4		90 120	110 145	120 155	140 180	160 205	180 230	195 245	220 275	245 305	270 335	295 365	325 400	355 435	405 495	455 555	505 615	560 680	620 740	695 835
Clearance group C5		120 150	145 180	155 190	180 220	205 250	230 280	245 295	275 330	305 365	335 400	365 435	400 475	435 515	495 585	555 655	615 725	680 800	740 860	835 975

#### 6.2.2 Radial clearance reduction for FAG cylindrical roller bearings with tapered bore

Nominal bore dia	Reduction of radial clearance <sup>1)</sup>		Drive up <sup>1)</sup> on taper 1:12 <sup>2)</sup>				Check value of smallest radial clearance after mounting				
	d over mm	to mm	min mm	max mm	shaft min mm	sleeve max mm	CN min mm	C3 min	C4 min	C5 min	
50	65	0.03	0.035	0.45	0.55	0.5	0.65	0.02	0.035	0.05	0.085
65	80	0.035	0.04	0.55	0.6	0.65	0.7	0.025	0.04	0.07	0.105
80	100	0.04	0.045	0.6	0.7	0.65	0.8	0.03	0.05	0.075	0.11
100	120	0.045	0.055	0.7	0.85	0.8	0.95	0.045	0.065	0.085	0.125
120	140	0.055	0.065	0.85	1	0.95	1.1	0.045	0.07	0.095	0.14
140	160	0.06	0.075	0.9	1.2	1	1.3	0.05	0.075	0.105	0.155
160	180	0.065	0.085	1	1.3	1.1	1.5	0.06	0.08	0.11	0.16
180	200	0.075	0.095	1.2	1.5	1.3	1.7	0.065	0.09	0.125	0.18
200	225	0.085	0.105	1.3	1.6	1.4	1.8	0.07	0.1	0.14	0.2
225	250	0.095	0.115	1.5	1.8	1.6	2	0.075	0.105	0.155	0.22
250	280	0.105	0.125	1.6	2	1.7	2.3	0.08	0.125	0.17	0.24
280	315	0.115	0.14	1.8	2.2	1.9	2.4	0.09	0.13	0.185	0.26
315	355	0.13	0.16	2	2.5	2.2	2.7	0.095	0.14	0.195	0.275
355	400	0.14	0.17	2.2	2.6	2.5	2.9	0.115	0.165	0.235	0.325
400	450	0.15	0.185	2.3	2.8	2.6	3.1	0.135	0.19	0.27	0.37
450	500	0.16	0.195	2.5	3	2.8	3.4	0.155	0.215	0.31	0.42
500	560	0.17	0.215	2.7	3.4	3.1	3.8	0.18	0.24	0.345	0.465
560	630	0.185	0.24	2.9	3.7	3.5	4.2	0.195	0.26	0.38	0.5
630	710	0.2	0.26	3.1	4.1	3.6	4.7	0.235	0.305	0.435	0.575

<sup>1)</sup> Please observe deviating values when using the displacement measuring instrument RKP.MG.

<sup>1)</sup> The following applies: Bearings, whose radial clearance is in the upper half of the tolerance range prior to mounting, are mounted with the larger value of the radial clearance reduction or of the axial drive up, bearings in the lower half of the tolerance range with the smaller value of the radial clearance reduction or of the axial drive up.

<sup>2)</sup> Applies only to solid steel shafts and hollow shafts, whose bore is not larger than half the shaft diameter. The drive-up values have to be multiplied for journals with  $d/d_m > 0.5$  by  $1/f_1$  for steel journals (see diagram 3, page 25) and in case of grey cast iron or spheroidal graphite cast iron additionally with the factor  $w$  (see diagram 4, page 25).

# Tables

## Radial clearance

### 6.2.3 Radial clearance of FAG spherical roller bearings

Dimensions in mm

Nominal bore diameter	over to	50 65	65 80	80 100	100 120	120 140	140 160	160 180	180 200	200 225	225 250	250 280	280 315	315 355	355 400	400 450	450 500	500 560	560 630	630 710	710 800	800 900	900 1000
-----------------------	---------	----------	----------	-----------	------------	------------	------------	------------	------------	------------	------------	------------	------------	------------	------------	------------	------------	------------	------------	------------	------------	------------	-------------

#### with cylindrical bore

Bearing clearance in  $\mu\text{m}$

Clearance group	min max	40 65	50 80	60 100	75 120	95 145	110 170	120 180	130 200	140 220	150 240	170 260	190 280	200 310	220 340	240 370	260 410	280 440	310 480	350 530	390 580	430 650	480 710
Clearance group CN (normal)	min max	40 65	50 80	60 100	75 120	95 145	110 170	120 180	130 200	140 220	150 240	170 260	190 280	200 310	220 340	240 370	260 410	280 440	310 480	350 530	390 580	430 650	480 710
Clearance group C3	min max	65 90	80 110	100 135	120 160	145 190	170 220	180 240	200 290	220 320	240 350	260 370	280 410	310 410	340 450	370 500	410 550	440 600	480 650	530 700	580 770	650 860	710 930
Clearance group C4	min max	90 120	110 145	135 180	160 210	190 240	220 280	240 310	260 340	290 380	320 420	350 460	370 500	410 550	450 600	500 660	550 720	600 780	650 850	700 920	770 1010	860 1120	930 1220
Clearance group C5	min max	120 150	145 150	180 225	210 260	240 300	280 350	310 390	340 430	380 470	420 520	460 570	500 630	550 690	600 750	660 820	720 900	780 1000	850 1100	925 1190	1010 1300	1120 1440	1220 1570

#### with tapered bore

Bearing clearance in  $\mu\text{m}$

Clearance group	min max	55 75	70 95	80 110	100 135	120 160	130 180	140 200	160 220	180 250	200 270	220 300	240 330	270 360	300 400	330 440	370 490	410 540	460 600	510 670	570 750	640 840	710 930
Clearance group CN (normal)	min max	55 75	70 95	80 110	100 135	120 160	130 180	140 200	160 220	180 250	200 270	220 300	240 330	270 360	300 400	330 440	370 490	410 540	460 600	510 670	570 750	640 840	710 930
Clearance group C3	min max	75 95	95 120	110 140	135 170	160 200	180 230	200 260	220 290	250 320	270 350	300 390	330 430	360 470	400 520	440 570	490 630	540 680	600 760	670 850	750 960	840 1070	930 1190
Clearance group C4	min max	95 120	120 150	140 180	170 220	200 260	230 300	260 340	290 370	320 410	350 450	390 490	430 540	470 590	520 650	570 720	630 790	680 870	760 980	850 1090	960 1220	1070 1370	1190 1520
Clearance group C5	min max	120 160	150 200	180 230	220 280	260 330	300 380	340 430	370 470	410 520	450 570	490 620	540 680	590 740	650 820	720 910	790 1000	870 1100	980 1230	1090 1360	1220 1500	1370 1690	1520 1860

### 6.2.4 Radial clearance reduction for FAG spherical roller bearings with tapered bore

Nominal bore diameter	Reduction of radial clearance <sup>1)</sup>		Drive up <sup>1)</sup> on taper 1:12 <sup>2)</sup>				Drive up <sup>1)</sup> on taper 1:30 <sup>2)</sup>				Check value of smallest radial clearance after mounting				
	d over mm	to mm	min mm	max mm	shaft min mm	sleeve max mm	shaft min mm	sleeve max mm	shaft min mm	sleeve max mm	CN min mm	C3 min mm	C4 min mm	C5 min mm	
50	65	0.03	0.04	0.45	0.6	0.5	0.7	-	-	-	-	0.025	0.035	0.055	0.08
65	80	0.04	0.05	0.6	0.75	0.7	0.85	-	-	-	-	0.025	0.04	0.07	0.1
80	100	0.045	0.06	0.7	0.9	0.75	1	1.7	2.2	1.8	2.4	0.035	0.05	0.08	0.12
100	120	0.05	0.07	0.7	1.1	0.8	1.2	1.9	2.7	2	2.8	0.05	0.065	0.1	0.15
120	140	0.065	0.09	1.1	1.4	1.2	1.5	2.7	3.5	2.8	3.6	0.055	0.08	0.11	0.17
140	160	0.075	0.1	1.2	1.6	1.3	1.7	3	4	3.1	4.2	0.055	0.09	0.13	0.2
160	180	0.08	0.11	1.3	1.7	1.4	1.9	3.2	4.2	3.3	4.6	0.06	0.1	0.15	0.23
180	200	0.09	0.13	1.4	2	1.5	2.2	3.5	4.5	3.6	5	0.07	0.1	0.16	0.24
200	225	0.1	0.14	1.6	2.2	1.7	2.4	4	5.5	4.2	5.7	0.08	0.12	0.18	0.27
225	250	0.11	0.15	1.7	2.4	1.8	2.6	4.2	6	4.6	6.2	0.09	0.13	0.2	0.3
250	280	0.12	0.17	1.9	2.6	2	2.9	4.7	6.7	4.8	6.9	0.1	0.14	0.22	0.32
280	315	0.13	0.19	2	3	2.2	3.2	5	7.5	5.2	7.7	0.11	0.15	0.24	0.35
315	355	0.15	0.21	2.4	3.4	2.6	3.6	6	8.2	6.2	8.4	0.12	0.17	0.26	0.38
355	400	0.17	0.23	2.6	3.6	2.9	3.9	6.5	9	6.8	9.2	0.13	0.19	0.29	0.42
400	450	0.2	0.26	3.1	4.1	3.4	4.4	7.7	10	8	10.4	0.13	0.2	0.31	0.46
450	500	0.21	0.28	3.3	4.4	3.6	4.8	8.2	11	8.4	11.2	0.16	0.23	0.35	0.51
500	560	0.24	0.32	3.7	5	4.1	5.4	9.2	12.5	9.6	12.8	0.17	0.25	0.36	0.55
560	630	0.26	0.35	4	5.4	4.4	5.9	10	13.5	10.4	14	0.2	0.29	0.41	0.63
630	710	0.3	0.4	4.6	6.2	5.1	6.8	11.5	15.5	12	16	0.21	0.31	0.45	0.69
710	800	0.34	0.45	5.3	7	5.8	7.6	13.3	17.5	13.6	18	0.23	0.35	0.51	0.77
800	900	0.37	0.5	5.7	7.8	6.3	8.5	14.3	19.5	14.8	20	0.27	0.39	0.57	0.87
900	1000	0.41	0.55	6.3	8.5	7	9.4	15.8	21	16.4	22	0.3	0.43	0.64	0.97

<sup>1)</sup> Please observe deviating values when using the displacement measuring instrument RKP.MG.

<sup>1)</sup> The following applies: Bearings, whose radial clearance is in the upper half of the tolerance range prior to mounting, are mounted with the larger value of the radial clearance reduction or of the axial drive up, bearings in the lower half of the tolerance range with the smaller value of the radial clearance reduction or of the axial drive up.

<sup>2)</sup> Applies only to solid steel shafts and hollow shafts, whose bore is not larger than half the shaft diameter. The drive-up values have to be multiplied for journals with  $d/d_m > 0.5$  by  $1/f_1$  for steel journals (see diagram 3, page 25) and in case of grey cast iron or spheroidal graphite cast iron additionally with the factor  $w$  (see diagram 4, page 25).

## FAG OEM und Handel Aktiengesellschaft

Postfach 1260  
D-97419 Schweinfurt  
Georg-Schäfer-Strasse 30  
D-97421 Schweinfurt  
Tel. +49-97 21 / 91-36 89  
Fax +49-97 21 / 91-49 08  
E-mail: [pulp+paper@fag.de](mailto:pulp+paper@fag.de)  
[www.fag.de](http://www.fag.de)

Every care has been taken to ensure the correctness of the information contained in this publication but no liability can be accepted for any errors or omissions. We reserve the right to make changes in the interest of technical progress.  
© by FAG 2000. This publication or parts thereof may not be reproduced without our permission.