



Emerson Bearing

Service. Inventory. Solutions.



Nomenclature Guide To Common Bearing Types

www.emersonbearing.com

1-800-225-4587

Nomenclature Guide

Table of Contents

Page 1.	6xxx	Single Row Deep Groove Ball Bearings
Page 2.	7xxx	Angular Contact Ball Bearings (ABEC 1 & 3)
Page 3.	1xxx	Double Row Self Aligning Ball Bearings
	2xxx	Double Row Self Aligning Ball Bearings
	3xxx	Double Row Ball Bearings
	5xxx	Double Row Ball Bearings
Page 4.	7xxx	Super Precision Angular Contact Ball Bearing
Page 5.	5xxxx	Ball Thrust Bearing
Page 6.		Cylindrical Bearing Types Compared
Page 7.	Nxxx	Cylindrical Roller Bearings
Page 8.	NN3xxx	Super Precision Cylindrical Roller Bearings
Page 9.	2xxxx	Spherical Roller Bearings
Page 10.	29xxx	Spherical Roller Thrust Bearings
Page 11.	H,LM	Tapered Roller Bearings-Inch
Page 12.	3xxxx	Tapered Roller Bearings-Metric
Page 13.	HJ, IR	Needle Roller Bearings-Inch
Page 14.	K	Needle Roller Bearings-Metric
Page 15.	NA,NAO	Needle Roller Bearings with Inner Rings-Metric
Page 16.	NK, RNA	Needle Roller Bearings without Inner Rings-Metric
Page 17.		Basic Bearing Life
Page 18.		Basic Bearing Life - Applications



Nomenclature — Single Row Deep Groove Ball Bearings

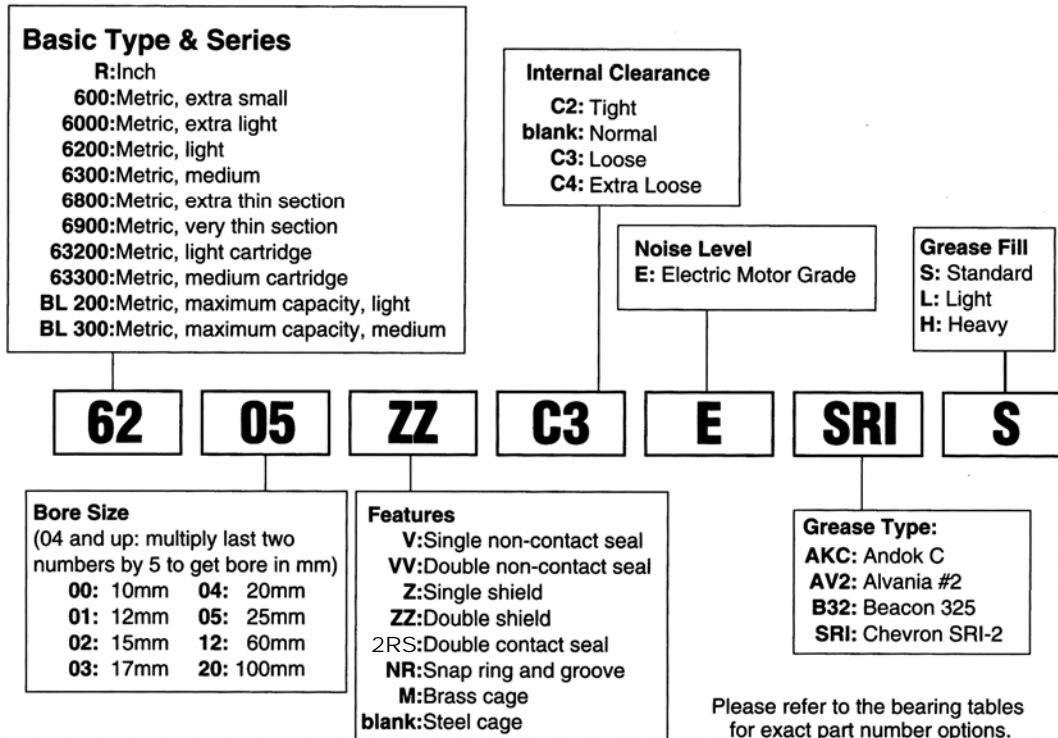

Interchange — Single Row Deep Groove Ball Bearings

DESCRIPTION		INTERCHANGE				
		NSK	SKF	TORR/FAF	FAG	MRC
Part Number	INCH	Rxx	Rxx	Sxx	Rxx	Rxx
	EXTRA SMALL	6xx	6xx	3x	6xx	3x
	EXTRA LIGHT	60xx	60xx	91xxK	60xx	1xxK
	LIGHT	62xx	62xx	2xx	62xx	2xxS
	MEDIUM	63xx	63xx	3xx	63xx	3xxS
	EXTRA THIN SECTION	68xx	618xx	--	618xx	--
	VERY THIN SECTION	69xx	619xx	93xxK	619xx	--
	THIN SECTION	16xxx	16xxx	--	16xxx	--
	MAXIMUM CAPACITY, LIGHT	BL2xx	2xx	2xxW	2xx	2xxM
	MAXIMUM CAPACITY, MEDIUM	BL3xx	3xx	3xxW	3xx	3xxM
Part Number Suffix	TWO SEALS	VV	2RS	PP	2RSR	ZZ
	ONE SEAL	V	RS	P	RSR	Z
	TWO SHIELDS	ZZ	2Z	DD	2ZR	FF
	ONE SHIELD	Z	Z	D	ZR	F
	SNAP RING	NR	NR	G	NR	G
	STEEL CAGE	BLANK	J	BLANK	BLANK	BLANK
	BRASS CAGE	M	M	MBR	M	BRZ
	HEAT STABILIZED 200C	X28	S1	--	S1	--
	TIGHT CLEARANCE	C2	C2	H	C2	Tight
	NORMAL CLEARANCE	BLANK	BLANK	R	BLANK	Normal
	LOOSE CLEARANCE	C3	EM(C3)	P	C3	Loose
	EXTRA LOOSE CLEARANCE	C4	C4	J	C4	Extra Loose
ELECTRIC MOTOR GRADE	E	QE6	--	--	--	

Nomenclature — Angular Contact Ball Bearings (ABEC 1&3)

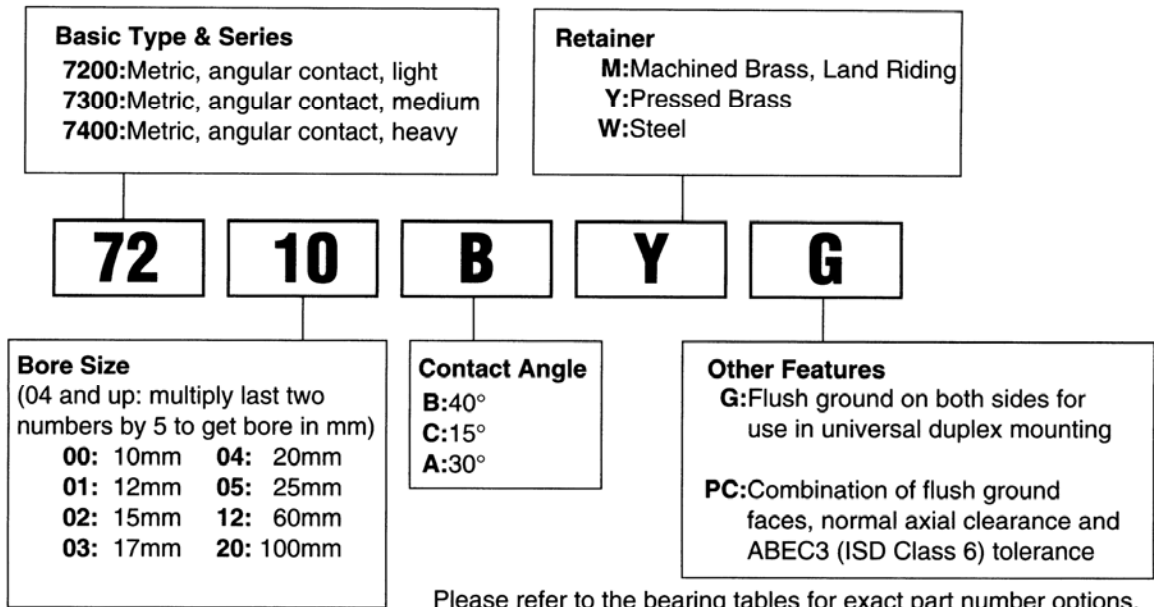

Interchange — Angular Contact Ball Bearings (ABEC 1&3)

DESCRIPTION		INTERCHANGE				
		NSK	SKF	TORR/FAF	FAG	MRC
Part No.	LIGHT	72xx	72xx	72xx	72xx	72xx
	MEDIUM	73xx	73xx	73xx	73xx	73xx
	HEAVY	74xx	74xx	74xx	74xx	74xx
Part No. Suffix	40 deg. CONTACT	B	B	WN	B	PJ
	30 deg. CONTACT	A	--	--	--	BLANK
	25 deg. CONTACT	A5	ACD	--	E	--
	15 deg. CONTACT	C	CD	--	C	R
	MACHINED BRASS CAGE	M	M	MBR	MP	BRZ
	PRESSED BRASS CAGE	Y	Y	BLANK	YP	--
	POLYAMIDE CAGE	TY	P	PRC	TVP	BKE
	STEEL CAGE	W	J	--	JP	BLANK
	FLUSH GROUND FACES	G	G	BLANK	UO,UA	DU
	PETROCHEMICAL	BMPC	BECPM	--	--	PUMPPAC*

Nomenclature — Double Row Ball Bearings

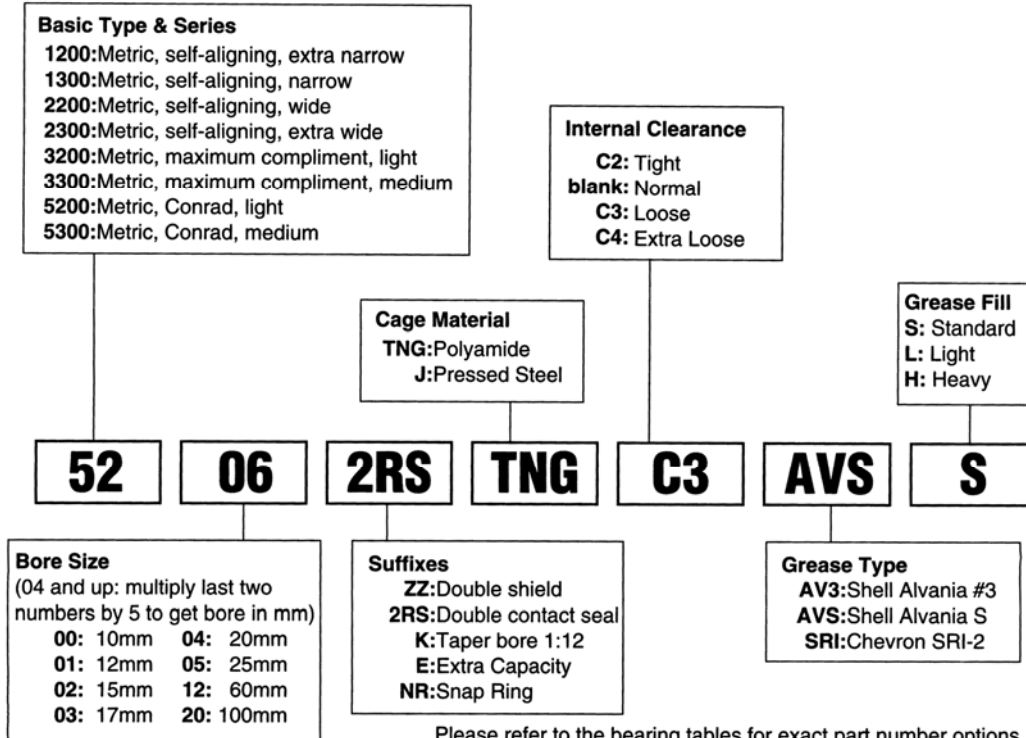

Interchange — Double Row Ball Bearings

DESCRIPTION		INTERCHANGE			
		NSK	SKF	TORR/FAF	MRC
Part Number	SELF-ALIGNING, EXTRA NARROW	12xx	12xx	--	--
	SELF-ALIGNING, NARROW	13xx	13xx	--	--
	SELF-ALIGNING, WIDE	22xx	22xx	--	--
	SELF-ALIGNING, EXTRA WIDE	23xx	23xx	--	--
	DOUBLE ROW, MAXIMUM COMPLIMENT, LIGHT	32xx	52xxE	52xxW	52xxM (K)
	DOUBLE ROW, MAXIMUM COMPLIMENT, MEDIUM	33xx	53xxE	53xxW	53xxM (K)
	DOUBLE ROW, CONRAD, LIGHT	52xx	52xxA	52xxK	52xxC (SBK)
	DOUBLE ROW, CONRAD, MEDIUM	53xx	53xxA	53xxK	53xxC (SB)
Part Number Suffix	TWO SEALS	2RS	2RS1	--	--
	TWO SHIELDS	ZZ	ZZ	--	FF
	SNAP RING	NR	NR	G	G
	POLYAMIDE CAGE	TNG	TN9	PRB	--
	STEEL CAGE	J	BLANK	BLANK	BLANK
	TAPERED BORE	K	K	--	--
	EXTRA CAPACITY	E	E	--	--
	TIGHT CLEARANCE	C2	C2	H	C2
	NORMAL CLEARANCE	BLANK	BLANK	R	BLANK
	LOOSE CLEARANCE	C3	C3	P	C3
	EXTRA LOOSE CLEARANCE	C4	C4	J	C4

Nomenclature — Super Precision Angular Contact

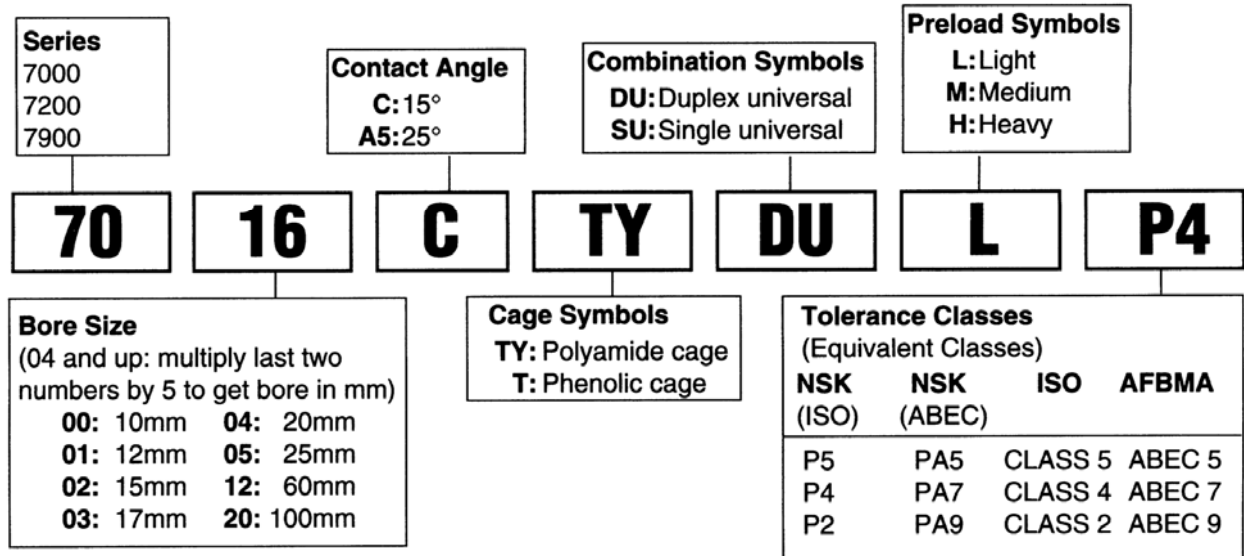

Please refer to the bearing tables for exact part number options.

Interchange — Super Precision Angular Contact

DESCRIPTION		INTERCHANGE				
		NSK	SKF	TORR/FAF	MRC	NTN
Part Number	EXTRA LIGHT SERIES	70xx	70xx	MM91xxWI	1xx	70xx
	LIGHT SERIES	72xx	72xx	MM2xxWI	2xx	72xx
	ULTRA LIGHT SERIES	79xx	79xx	MM93xxWI	19xx	79xx
	25° CONTACT ANGLE	A5	ACD	*3	*7	--
	15° CONTACT ANGLE	C	CD	*2	R	C
Suffix	POLYAMIDE CAGE	TY	BLANK	BLANK	--	T2
	PHENOLIC CAGE	T	--	CR	BKE	T1
	DUPLEX UNIVERSAL	DU	DG	DU	DU	GD2
	SINGLE UNIVERSAL	SU	G	SU	DS	G
	LIGHT PRELOAD	L	A	L	L	GL
	MEDIUM PRELOAD	M	B	M	M	GM
	HEAVY PRELOAD	H	C	H	H	GH
	ABEC 7 PRECISION	P4, PA7	P4,PA7	MM	#7	P4
	ABEC 5 PRECISION	P5, PA5	P5,PA5	V	#5	P5
ABEC 9 PRECISION	P2, PA9	P2,PA9	MMX	#9	P2	

*Prefix

Nomenclature — Ball Thrust Bearings

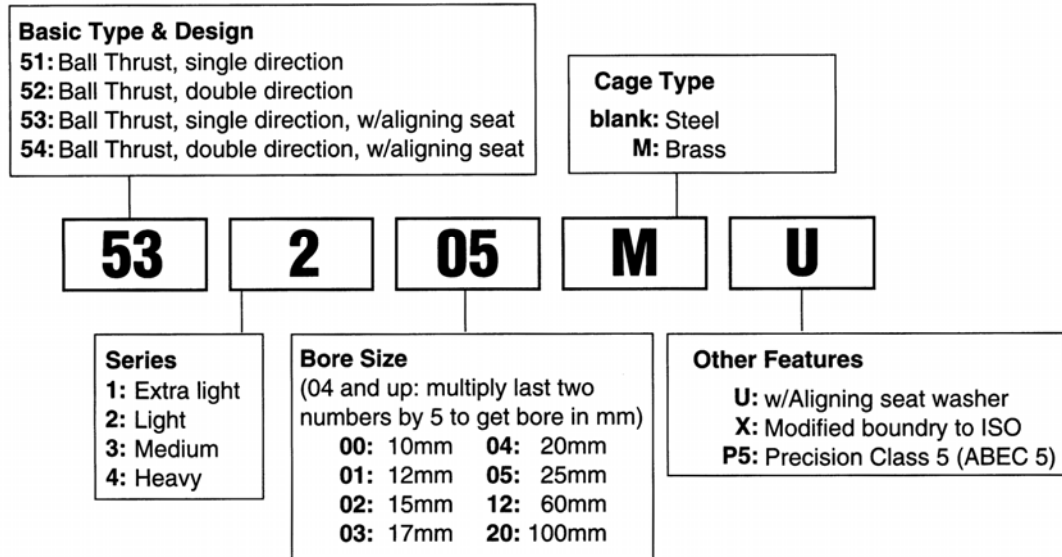

Please refer to the bearing tables for exact part number options.

Interchange — Ball Thrust Bearings

DESCRIPTION		INTERCHANGE		
		NSK	SKF	FAG
Part Number	SINGLE DIRECTION	511xx	511xx	511xx
	SINGLE DIRECTION	512xx	512xx	512xx
	SINGLE DIRECTION	513xx	513xx	513xx
	SINGLE DIRECTION	514xx	514xx	514xx
	SINGLE DIRECTION WITH ALIGNING SEAT	532xx	532xx	532xx
	SINGLE DIRECTION WITH ALIGNING SEAT	533xx	533xx	533xx
	SINGLE DIRECTION WITH ALIGNING SEAT	534xx	534xx	534xx
	DOUBLE DIRECTION	522xx	522xx	522xx
	DOUBLE DIRECTION	523xx	523xx	523xx
	DOUBLE DIRECTION	524xx	524xx	524xx
	DOUBLE DIRECTION WITH ALIGNING SEAT	542xx	542xx	542xx
	DOUBLE DIRECTION WITH ALIGNING SEAT	543xx	543xx	543xx
	DOUBLE DIRECTION WITH ALIGNING SEAT	544xx	544xx	544xx
Suffix	STEEL CAGE	BLANK	J	FP
	BRASS CAGE	M	M	MP
	BOUNDARY DIMENSIONS ADOPTED TO ISO	X	--	X
	WITH SELF-ALIGNING SEAT WASHER	U	U	U
	ABEC 5 PRECISION CLASS	P5	P5	P5



Cylindrical Roller Bearing Types

- NU style single row
- N style single row
- NJ style single row
- NF style single row
- NH style single row
- NUP style single row
- Double row styles (NN, NNU)

Cylindrical roller bearings are designed to carry heavy radial loads and are suitable for high speed applications. Their rolling elements are ground to provide maximum contact with the raceway and are precisely crowned to avoid edge loading due to shaft misalignment.

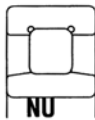

NU style bearings have two machined flanges on the outer ring and no flanges on the inner ring. The rollers and cages are assembled in the outer ring. Because there are no flanges in the inner ring, this bearing cannot carry a thrust load.

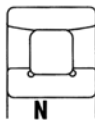

N style bearings have two machined flanges on the inner ring and no flanges on the outer ring, with rollers and cage on the inner ring. Like the **NU** style, the **N** has no thrust load carrying capability.

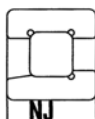

NJ style bearings have two machined flanges on the outer ring and a machined flange on one side of the inner ring. The roller and cage assembly is in the outer ring. The integral flange on the inner ring allows this bearing to carry an axial load.

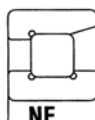

NF style bearings have two machined flanges on the inner ring and one flange on the outer ring, with roller and cage on the inner ring. Like the **NJ** bearing, these bearings have some thrust load capability.

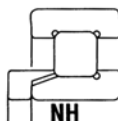

NH style bearings have two machined flanges on the outer ring and a machined flange on one side of the inner ring. A special-design inner ring allows use of a stabilizing ring on the non-flange side. As a result, these bearings can carry axial loads in both directions. The roller and cage assembly is mounted in the outer ring.

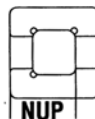

NUP style bearings are similar to the **NJ** style and come with a special ring often called a thrust collar. Mounted on the non-flange side of the inner ring, the thrust collar allows the bearing to carry an axial load in both directions. The thrust collar extends out of the bearing on one side, so the dimension across the inner ring is slightly greater than that of the outer ring.

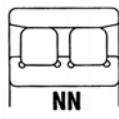

Double Row cylindrical roller bearings are denoted by two N's within the part number (e.g., **NN** or **NNU**). The dimensions for these can be found in the Super Precision section of this catalog and can be ordered with standard precision.

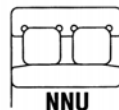

Nomenclature — Cylindrical Roller Bearings

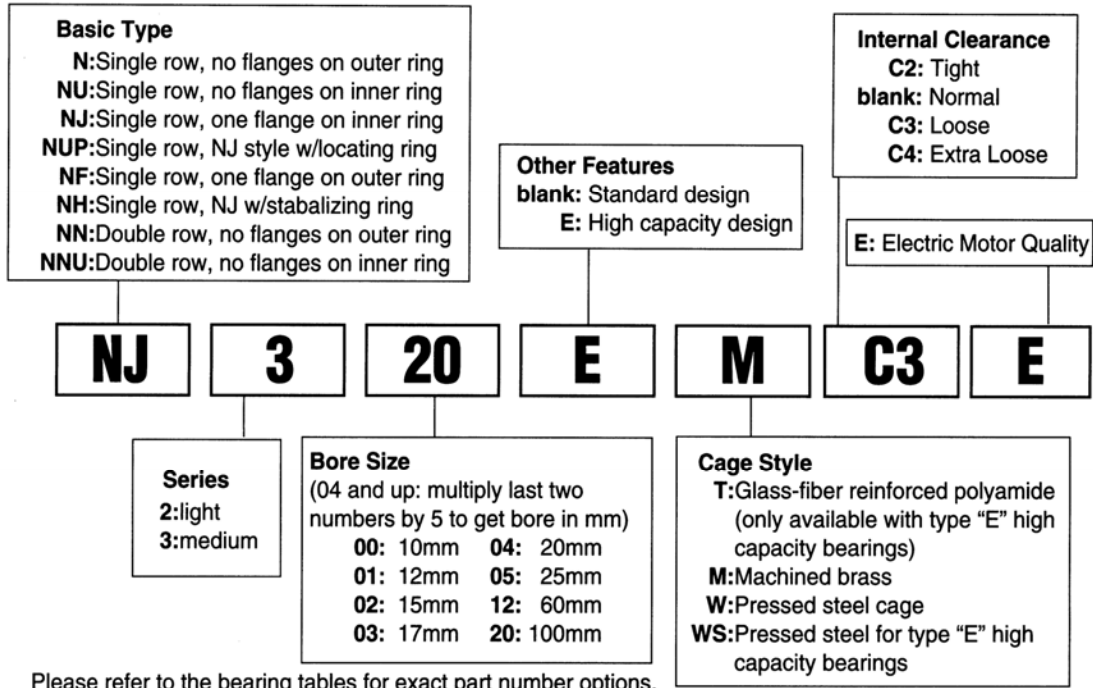

Interchange — Cylindrical Roller Bearings

DESCRIPTION		INTERCHANGE		
		NSK	SKF	FAG
Part Number Prefix	SINGLE ROW, NO FLANGES ON OUTER RING	N	N	N
	SINGLE ROW, NO FLANGES ON INNER RING	NU	NU	NU
	SINGLE ROW, 1 FLANGE INNER	NJ	NJ	NJ
	SINGLE ROW, 1 FLANGE OUTER	NF	NF	--
	SINGLE ROW, 1 FLANGE INNER, WITH RETAINING RING	NUP	NUP	NUP
	SINGLE ROW, 1 FLANGE INNER w/STABILIZING RING	NH	NH	NH
	STABILIZING RING	HJ	HJ	HJ
	DOUBLE ROW, FLANGES OUTER/FANGES INNER	NNU/NN	NNU/NN	NNU/NN
	Part Number	LIGHT	2xx	2xx
MEDIUM		3xx	3xx	3xx
HEAVY		4xx	4xx	4xx
EXTRA LIGHT		10xx	10xx	10xx
LIGHT, WIDE		22xx	22xx	22xx
MEDIUM, WIDE		23xx	23xx	23xx
Part Number Suffix	POLYAMIDE CAGE	T	P	TVP2
	COMPOSITE HIGH TEMP (200F) CAGE	T7	--	--
	MACHINED BRASS CAGE	M	M	M, M1
	PRESSED STEEL CAGE	W,WS	J	JP1
	HIGH CAPACITY DESIGN	E	EC	E
	FULL COMPLEMENT (NO CAGE)	V	V	V
	TIGHT CLEARANCE	C2	C2	C2
	NORMAL CLEARANCE	BLANK	BLANK	BLANK
	LOOSE CLEARANCE	C3	C3	C3
	EXTRA LOOSE CLEARANCE	C4	C4	C4

Nomenclature — Super Precision Cylindrical Roller Bearings

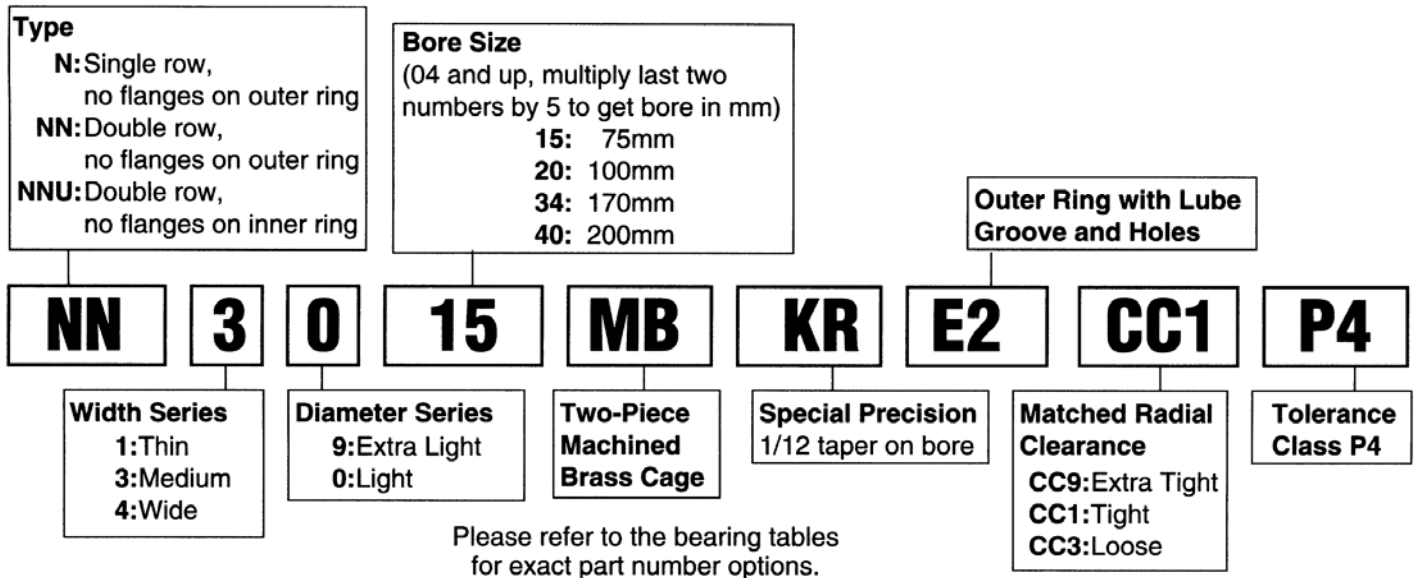

Interchange — Super Precision Cylindrical Roller Bearings

DESCRIPTION		INTERCHANGE			
		NSK	SKF	FAG	NTN
Part Number	DOUBLE ROW, NO FLANGES OUTER RING	NN30xx	NN30xx	NN30xx	NN30xx
	DOUBLE ROW, NO FLANGES OUTER RING	NN39xx	--	--	--
	DOUBLE ROW, NO FLANGES INNER RING	NNU49xx	NNU49xxB	NNU49xx	NNU49xx
	SINGLE ROW, NO FLANGES OUTER RING	N10xx	N10xx	N10xx	N10xx
Suffix	BRASS, MACHINED TWO PIECE, ROLLER GUIDED	MB	--	M	G1
	BRASS, MACHINED ONE PIECE, INNER RING GUIDED	BLANK	M	--	--
	NYLON, MOLDED, ROLLER GUIDED	T	TN	--	--
	SPECIAL PRECISION 1:12 TAPER BORE	KR	UPK	K	K
	LUBE GROOVE WITH HOLES, OUTER RING ONLY	E2	W33	S	--
	PLAIN O.D.	BLANK	W	--	BLANK
	MATCHED CLEARANCE, RINGS NOT TO BE MIXED	CCx	Cx	Cx	CxNA
TOLERANCE CLASS P4	P4	SP	SP	P4	



Action Bearing



Emerson Bearing

Nomenclature — Spherical Roller Bearings

Basic Type
22200:Spherical roller, medium
22300:Spherical roller, heavy
23000:Spherical roller, very light
23100:Spherical roller, light
23200:Spherical roller, medium, wide
23900:Spherical roller, extra light
24000:Spherical roller, very light, wide
24100:Spherical roller, light, wide

Lubrication Features
E3: Holes only, outer
E4: Groove & holes, outer
E7: Groove & holes, outer; Holes only, inner
blank: No relubrication feature

Other Features
P52: Outer ring accuracy
P53: Inner ring accuracy
P55: Both ring accuracy
U22: Special inspection measure
S11: Inner ring stabilized to 200°C

Bore Type
blank: Cylindrical bore
K: 1:12 Tapered bore
K30: 1:30 Tapered bore

231 **72** **CAM** **K** **E4** **C3** **P53S11**

Bore Size (multiply last two numbers by 5 to get bore in mm)
20: 100mm **48:** 240mm
32: 160mm **96:** 480mm
 500 millimeters and larger written as :
/500: 500mm **/710:** 710mm
/630: 630mm **/1000:** 1000mm

Cage Options
CAM: One piece brass cage, guide ring
C,CD: Two piece steel cage guide ring
H: Two piece polyamide cage
M: Two piece brass cage, integral guide flange

Internal Clearance
C2: Tight
blank: Normal
C3: Loose
C4: Extra Loose

Please refer to the bearing tables for exact part number options.

Interchange — Spherical Roller Bearings

DESCRIPTION		INTERCHANGE			
		NSK	SKF	TORR/FAF	FAG
Part Number	VERY LIGHT	239xx	239xx	239xx	239xx
	LIGHT	230xx	230xx	230xx	230xx
	LIGHT, WIDE	240xx	240xx	240xx	240xx
	MEDIUM	231xx	231xx	231xx	231xx
	MEDIUM, WIDE	241xx	241xx	241xx	241xx
	HEAVY	222xx	222xx	222xx	222xx
	HEAVY, WIDE	232xx	232xx	232xx	232xx
	EXTRA HEAVY	213xx	213xx	213xx	213xx
	EXTRA HEAVY, WIDE	223xx	223xx	223xx	223xx
	Part Number Suffix	BRONZE CAGE, ONE PIECE, GUIDE RING	CAM,AM	CA,CACM	YM
BRONZE CAGE, TWO PIECE, GUIDE FLANGE		M	MC	BR	MB
STEEL CAGE, TWO PIECE, GUIDE RING		C,CD	CJ,CC	CJ,VJ	BLANK
POLYAMIDE CAGE, TWO PIECE		H	--	VCF	TVPB
TAPERED BORE 1:12		K	K	K	K
TAPERED BORE 1:30		K30	K30	K	K30
CARBURIZED STEEL, COMPLETE BEARING		g	ECD	W40	W209
CARBURIZED STEEL, INNER RING ONLY		g3	ECB	W40I	W209B
LUBE GROOVE & HOLES OUTER RING		E4	W33	W33	S
LUBE GROOVE & HOLES OUTER RING, HOLES INNER RING		E7	W513	W33W94	SH40AB
HOLES ONLY OUTER RING		E3	W20	W20	SY
HOLES ONLY INNER RING		E5	W26	W94	H40AB
NO RELUBE FEATURES		BLANK	BLANK	BLANK	--
PLUGS PROVIDED FOR OUTER RING HOLES		E42	W77	W84	H40
COMBINATION W33, W4, W31		E4P53	W507	W33W4W31	--
COMBINATION W33, W31		E4U22	W506	W33W31	--
COMBINATION W33, W26, W31		E7U22	W509	W33W94W31	SH40A
OUTER RING WITH EXTRA CLOSE RUNNING ACCURACY		P52	C04	C04	T52BN
INNER RING WITH EXTRA CLOSE RUNNING ACCURACY		P53	C02	C02	T52BE
INNER AND OUTER RING W/EXTRA CLOSE RUNNING ACCURACY		P55	C08	C08	T52BW
SPECIAL INSPECTION MEASURES		U22	W31	W31	--
INNER RING AND OUTER RING HEAT STABILIZED TO 200°C		S11	S1	--	--
TIGHT CLEARANCE		C2	C2	C2	C2
NORMAL CLEARANCE		BLANK	BLANK	BLANK	BLANK
LOOSE CLEARANCE	C3	C3	C3	C3	
EXTRA LOOSE CLEARANCE	C4	C4	C4	C4	

Nomenclature — Spherical Thrust Bearings

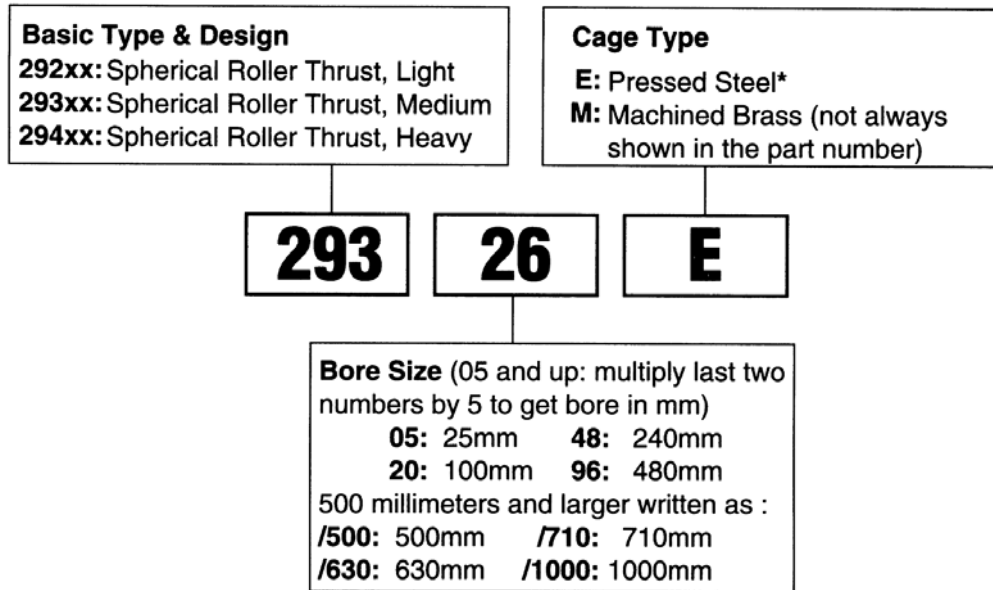

Please refer to the bearing tables for exact part number options.

Interchange — Spherical Thrust Bearings

DESCRIPTION		INTERCHANGE			
		NSK	SKF	FAG	Torrington
Part Number	LIGHT	292xx	292xx	292xx	292xx
	MEDIUM	293xx	293xx	293xx	293xx
	HEAVY	294xx	294xx	294xx	294xx
Suffix	STEEL CAGE	H	EJ	E	EJ
	BRASS CAGE	M	M	EMB	EM

*The “E” designation has replaced the “H.” This is nomenclature change only, **not** a design change.

Nomenclature — Inch Tapered Roller Bearings

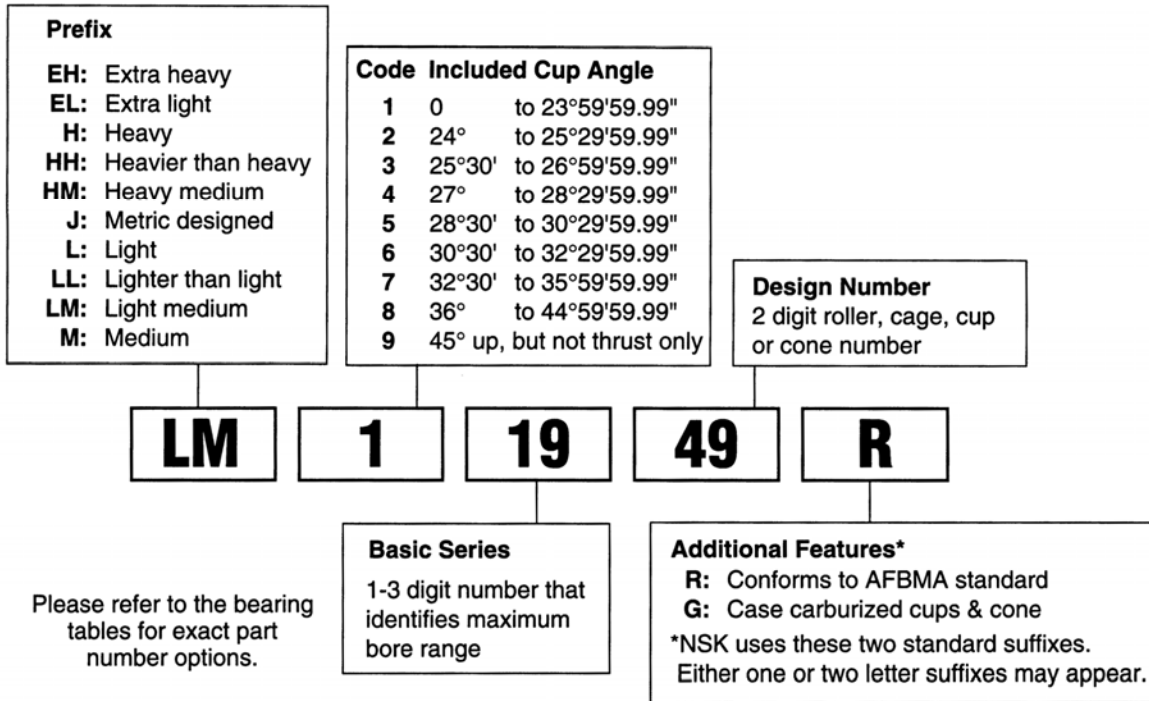

Interchange — Inch Tapered Roller Bearings

DESCRIPTION		INTERCHANGE			
		NSK	SKF	Timken	FAG
Prefix	EXTRA HEAVY	EH	EH	EH	KEH
	HEAVIER THAN HEAVY	HH	HH	HH	KHH
	HEAVY	H	H	H	KH
	HEAVY MEDIUM	HM	HM	HM	KHM
	MEDIUM	M	M	M	KM
	LIGHT MEDIUM	LM	LM	LM	KLM
	LIGHT	L	L	L	KL
	LIGHTER THAN LIGHT	LL	LL	LL	KLL
	EXTRA LIGHT	EL	EL	EL	KEL
Cup Angle	0° TO 23°59'59.99	1xxxx	1xxxx	1xxxx	1xxxx
	24° TO 25°29'59.99	2xxxx	2xxxx	2xxxx	2xxxx
	25°30' TO 26°59'59.99	3xxxx	3xxxx	3xxxx	3xxxx
	27° TO 28°29'59.99	4xxxx	4xxxx	4xxxx	4xxxx
	28°30' TO 30°29'59.99	5xxxx	5xxxx	5xxxx	5xxxx
	30°30' TO 32°29'59.99	6xxxx	6xxxx	6xxxx	6xxxx
	32°30' TO 35°59'59.99	7xxxx	7xxxx	7xxxx	7xxxx
	36° TO 44°59'59.99	8xxxx	8xxxx	8xxxx	8xxxx
	45° UP, BUT NOT THRUST ONLY CONFORMS TO AFBMA STANDARD CASE CARBURIZED CUP & CONE	9xxxx R G	9xxxx	9xxxx	9xxxx

Nomenclature — Metric Tapered Roller Bearings

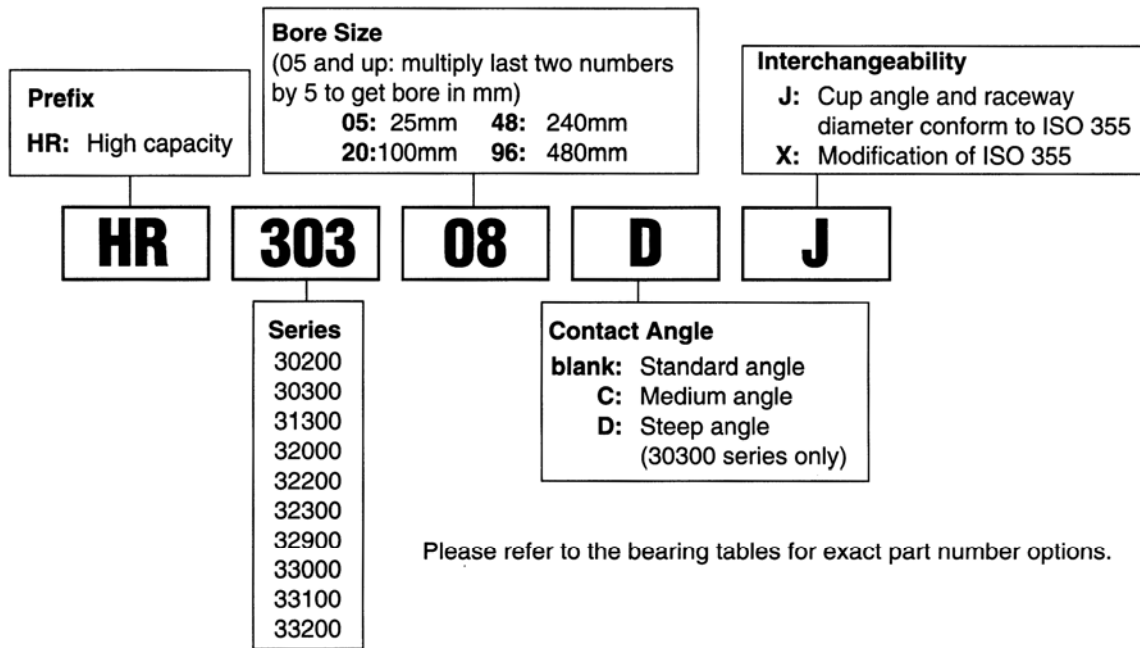

Interchange — Metric Tapered Roller Bearings

DESCRIPTION		INTERCHANGE			
		NSK	SKF	Timken	FAG
Part Number	HIGH CAPACITY DESIGN	HR	--	--	--
	LIGHT	HR302xx	302xx	302xx	302xx
	MEDIUM	HR303xx	303xx	303xx	303xx
	MEDIUM, STEEP ANGLE	HR303xxD	313xx	313xx	313xx
	EXTRA LIGHT, WIDE	HR329xx	329xx	329xx	329xx
	VERY LIGHT, WIDE	HR320xx	320xx	320xx	320xx
	LIGHT, WIDE	HR322xx	322xx	322xx	322xx
	MEDIUM, WIDE	HR323xx	323xx	323xx	323xx
	VERY LIGHT, EXTRA WIDE	HR330xx	330xx	330xx	330xx
	LIGHT, EXTRA WIDE	HR331xx	331xx	331xx	331xx
MEDIUM, EXTRA WIDE	HR332xx	332xx	332xx	332xx	
Suffix	MEDIUM CONTACT ANGLE	C	B	B	B
	STEEP CONTACT ANGLE	D	--	--	--
	MODIFIED INTERNAL DESIGN	X	X	X	X
	CONFORMS TO ISO 355	J	--	--	A

Needle Roller Bearings – Inch Nominal Dimensions

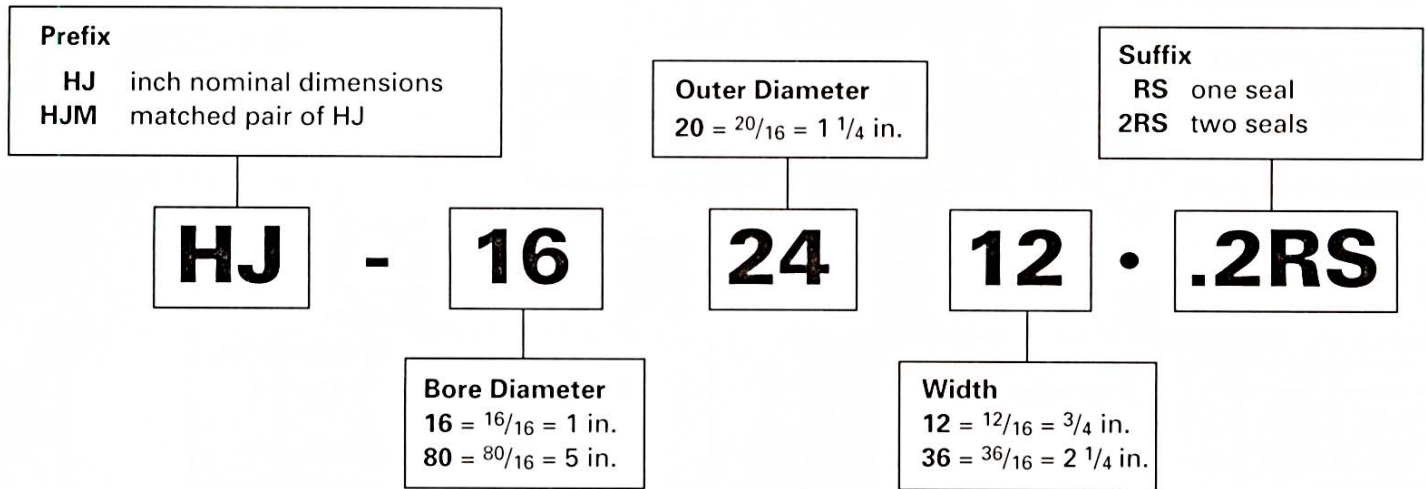

Inner Rings (six-digit number) – Inch Nominal Dimensions

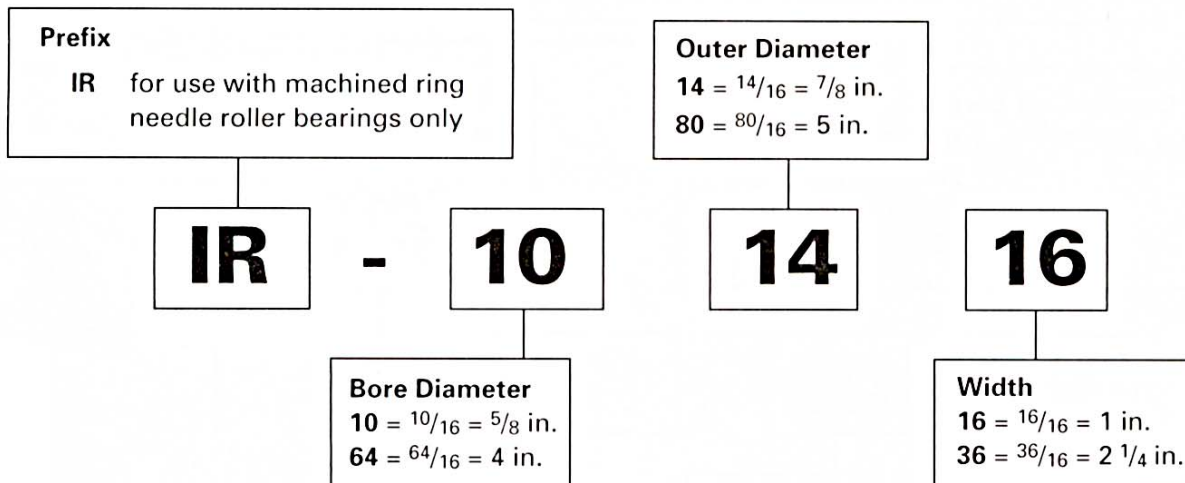

Radial Needle Roller and Cage Assemblies Metric Nominal Dimensions

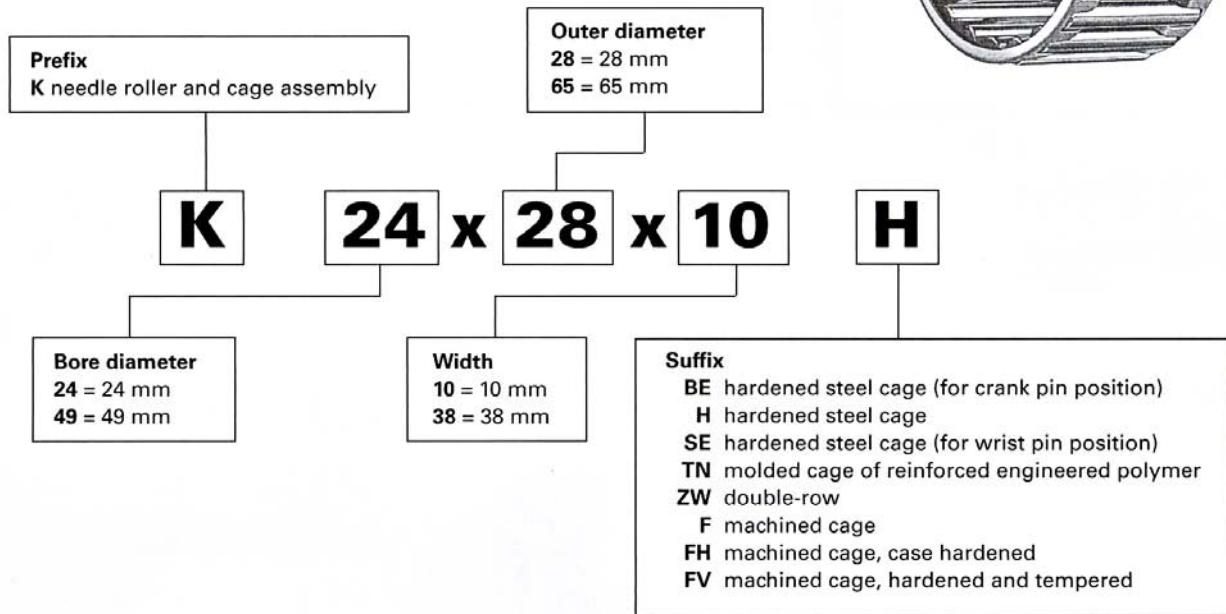

Radial Needle Roller and Cage Assemblies Inch Nominal Dimensions

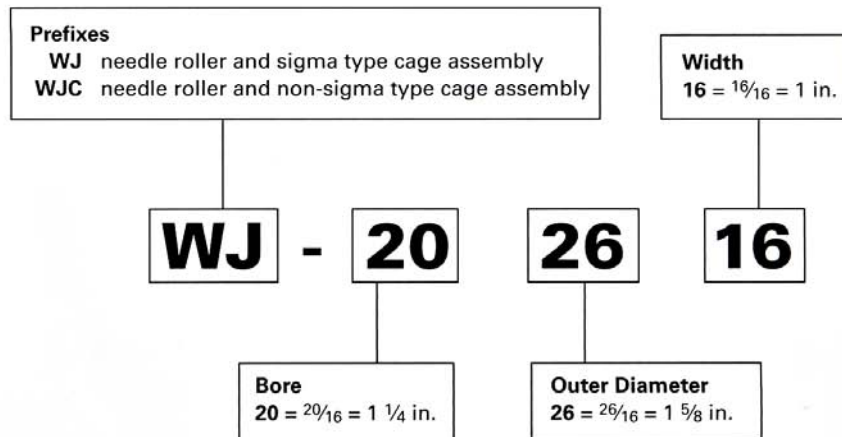

Needle Roller Bearings with Inner Rings - Metric Nominal Dimensions

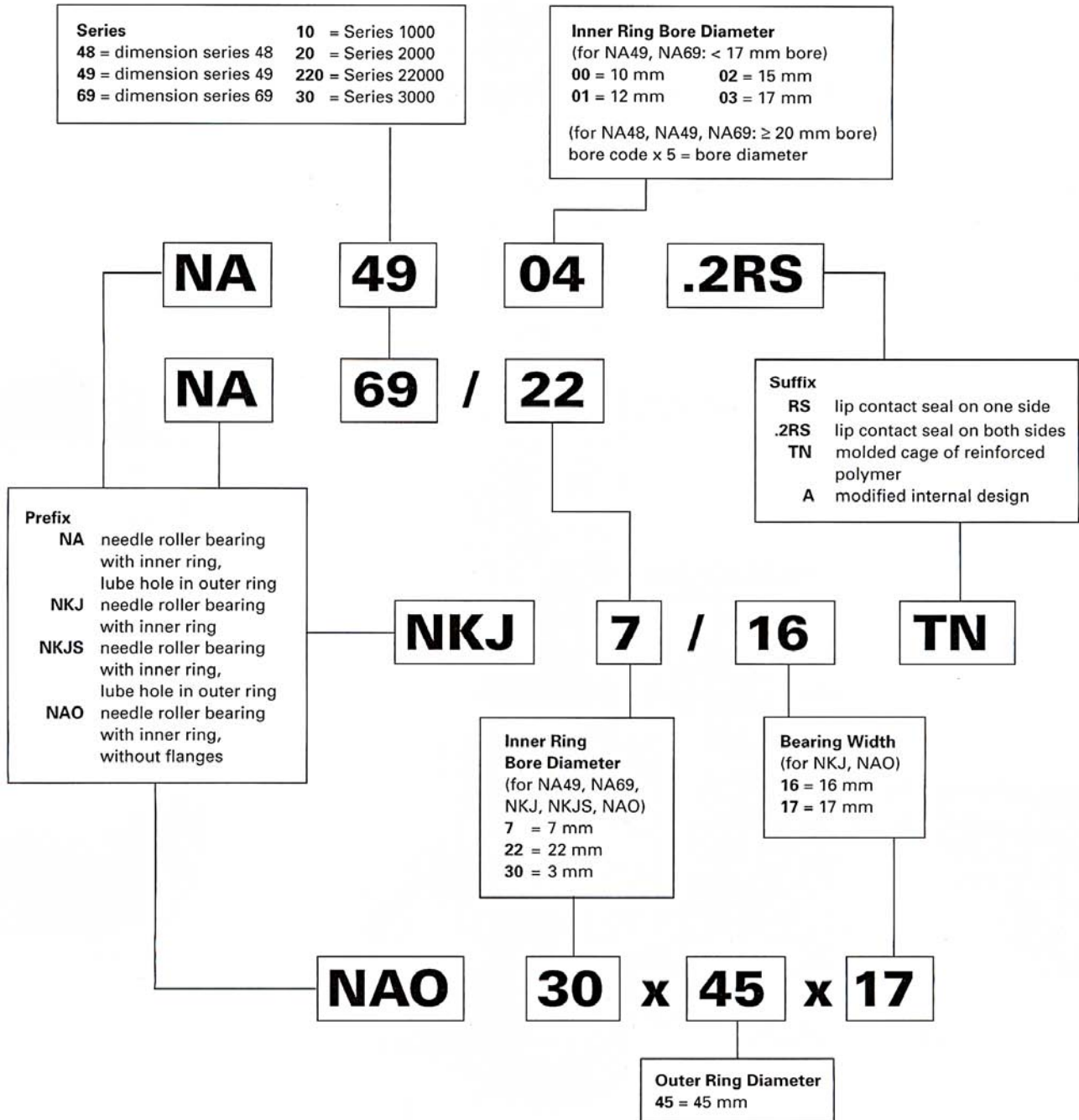

Needle Roller Bearings without Inner Rings - Metric Nominal Dimensions

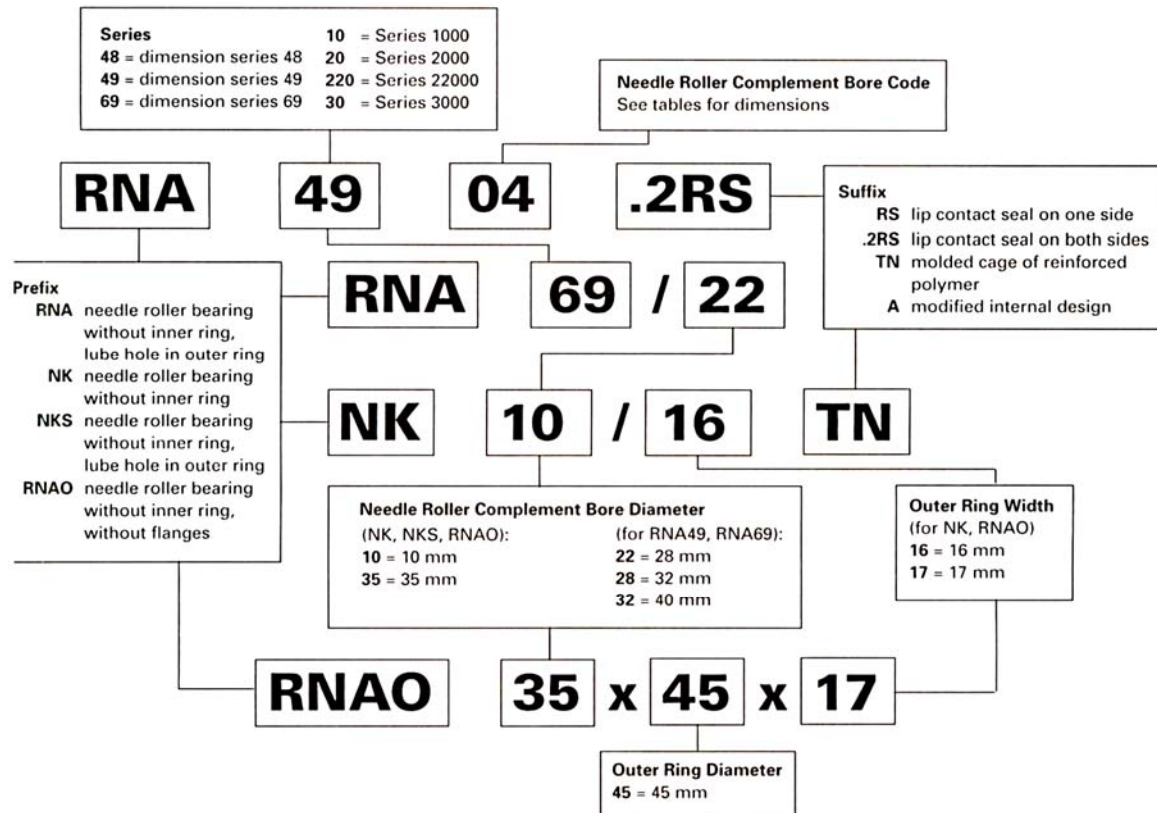

Inner Rings for Needle Roller Bearings—Metric Nominal Dimensions

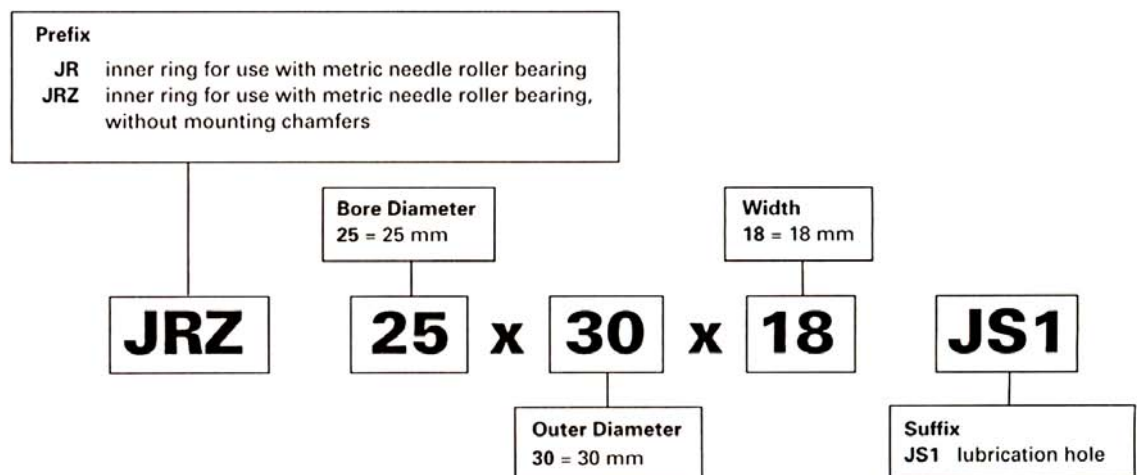

Basic Bearing Life - Introduction

2.1.2 Required Basic Life

With the aid of the life equations according to section 2.1.1, the correct bearing size can be selected, if the required life is known from the conditions of the machine operation and the requirements on the operating reliability. If data concerning the required life is not available, approximate values can be obtained from figure 1.

2.1.3 Service Life

The service life is the life actually reached by a roller bearing, which can deviate from the calculated life. For instance, misalignment between shaft and housing, contamination of the bearings, too high operating temperatures or insufficient lubrication may cause premature failure due to wear or fatigue.

Unfavorable operating conditions such as oscillating bearing motion with very small angles of oscillation, or vibrations of the bearings while not rotating, may also cause premature bearing failure due to brinelling.

Considering the multitude of applications and operating conditions, the service life of bearings cannot be exactly determined. The safest way to estimate the service life, now as before, is by comparison with similar applications.

2.2 Static Load Carrying Capacity

The static load carrying capacity is limited by the permanent deformation of the rolling elements and raceways, which is still considered permissible with the regard to to the noise level during subsequent bearing operation. This definition of permissible permanent deformation leads to the term static load rating. The measure of static load rating is defined by the static load safety factor.

2.2.1 Static Load Safety Factor

The static load safety factor indicates the safety against the permissible permanent deformation in the bearing and is defined as follows:

$$S_0 = C_0 / F_0 \quad (4)$$

S_0 —
static load safety factor

C_0 lbf
basic static load rating. In radial bearings, C_0 is the load in the radial direction and in thrust bearings the concentrically acting axial load, for which the Hertzian pressure between the rolling elements and the raceways at the most highly loaded position in the bearing reaches the value 580,000 psi (4000 N/mm²). This load causes, under normal contact conditions, a permanent total deformation of 1/10,000 of the rolling element diameter.

F_0 lbf
maximum load of the radial or thrust bearings

2.2.2 Required Static Load Safety Factor

The guideline values shown in table 1 are recommended for the static load safety factor.

Table 1 • Recommended static load safety factor

Application	S_0
Quiet, vibration free operation with low demands for smooth running; bearings with only slight rotational movement.	≥ 1
Normal operation with higher demands for smoother running	≥ 2
Operation with distinct shock loads	≥ 3
Bearing arrangements with high demands for accuracy and smooth running	≥ 4

For shell bearings, the value $S_0 \geq 3$ should be used.

2.3 Influences on the Load Carrying Capacity

The basic load ratings shown in this catalog are valid for a hardness of 670 to 840 HV (RC 58 to 65) for raceways and rolling elements with a fine grain material structure which is characteristic for rolling bearing components.

Basic Bearing Life - Applications

a_1 —
factor for reliability other than 90%

a_2 —
material factor

a_3 —
factor for operating conditions, especially for lubrication conditions.

Under normal conditions $a_1 = a_2 = a_3 = 1$, so equation (3) is identical to equation (1).

For determination of the adjustment factors, it is necessary that all operating conditions (individual loading conditions, influence of misalignment, bearing temperature, etc.) are exactly known. If this is the case, the adjustment factors can be determined, based on special guidelines, by the INA Engineering Department and then substituted into equation (3).

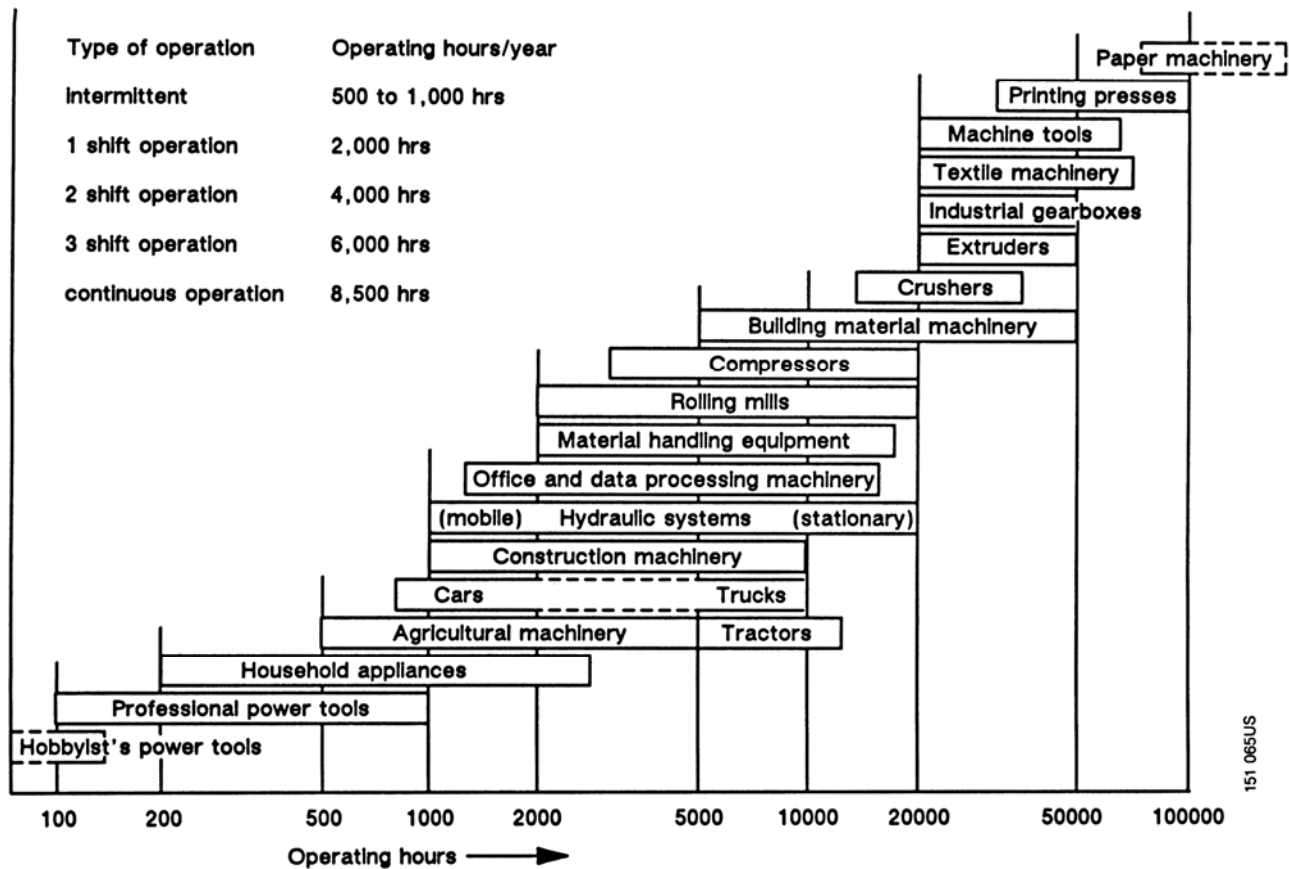

Figure 1 • Approximate values for the basic life of rolling bearings

	DECIMALS	MILLIMETERS
	$\frac{1}{64}$.015625 — 0.397
$\frac{1}{32}$	$\frac{2}{64}$.03125 — 0.794
	$\frac{3}{64}$.046875 — 1.191
$\frac{1}{16}$	$\frac{4}{64}$.0625 — 1.588
	$\frac{5}{64}$.078125 — 1.984
$\frac{3}{32}$	$\frac{6}{64}$.09375 — 2.381
	$\frac{7}{64}$.109375 — 2.778
$\frac{1}{8}$	$\frac{8}{64}$.1250 — 3.175
	$\frac{9}{64}$.140625 — 3.572
$\frac{5}{32}$	$\frac{10}{64}$.15625 — 3.969
	$\frac{11}{64}$.171875 — 4.366
$\frac{3}{16}$	$\frac{12}{64}$.1875 — 4.763
	$\frac{13}{64}$.203125 — 5.159
$\frac{7}{32}$	$\frac{14}{64}$.21875 — 5.556
	$\frac{15}{64}$.234375 — 5.953
$\frac{1}{4}$	$\frac{16}{64}$.2500 — 6.350
	$\frac{17}{64}$.265625 — 6.747
$\frac{9}{32}$	$\frac{18}{64}$.28125 — 7.144
	$\frac{19}{64}$.296875 — 7.541
$\frac{5}{16}$	$\frac{20}{64}$.3125 — 7.938
	$\frac{21}{64}$.328125 — 8.334
$\frac{11}{32}$	$\frac{22}{64}$.34375 — 8.731
	$\frac{23}{64}$.359375 — 9.128
$\frac{3}{8}$	$\frac{24}{64}$.3750 — 9.525
	$\frac{25}{64}$.390625 — 9.922
$\frac{13}{32}$	$\frac{26}{64}$.40625 — 10.319
	$\frac{27}{64}$.421875 — 10.716
$\frac{7}{16}$	$\frac{28}{64}$.4375 — 11.113
	$\frac{29}{64}$.453125 — 11.509
$\frac{15}{32}$	$\frac{30}{64}$.46875 — 11.906
	$\frac{31}{64}$.484375 — 12.303
$\frac{1}{2}$	$\frac{32}{64}$.5000 — 12.700

	DECIMALS	MILLIMETERS
	$\frac{33}{64}$.515625 — 13.097
$\frac{17}{32}$	$\frac{34}{64}$.53125 — 13.494
	$\frac{35}{64}$.546875 — 13.891
$\frac{9}{16}$	$\frac{36}{64}$.5625 — 14.288
	$\frac{37}{64}$.578125 — 14.684
$\frac{19}{32}$	$\frac{38}{64}$.59375 — 15.081
	$\frac{39}{64}$.609375 — 15.478
$\frac{5}{8}$	$\frac{40}{64}$.6250 — 15.875
	$\frac{41}{64}$.640625 — 16.272
$\frac{21}{32}$	$\frac{42}{64}$.65625 — 16.669
	$\frac{43}{64}$.671875 — 17.066
$\frac{11}{16}$	$\frac{44}{64}$.6875 — 17.463
	$\frac{45}{64}$.703125 — 17.859
$\frac{23}{32}$	$\frac{46}{64}$.71875 — 18.256
	$\frac{47}{64}$.734375 — 18.653
$\frac{3}{4}$	$\frac{48}{64}$.7500 — 19.050
	$\frac{49}{64}$.765625 — 19.447
$\frac{25}{32}$	$\frac{50}{64}$.78125 — 19.844
	$\frac{51}{64}$.796875 — 20.241
$\frac{13}{16}$	$\frac{52}{64}$.8125 — 20.638
	$\frac{53}{64}$.828125 — 21.034
$\frac{27}{32}$	$\frac{54}{64}$.84375 — 21.431
	$\frac{55}{64}$.859375 — 21.828
$\frac{7}{8}$	$\frac{56}{64}$.8750 — 22.225
	$\frac{57}{64}$.890625 — 22.622
$\frac{29}{32}$	$\frac{58}{64}$.90625 — 23.019
	$\frac{59}{64}$.921875 — 23.416
$\frac{15}{16}$	$\frac{60}{64}$.9375 — 23.813
	$\frac{61}{64}$.953125 — 24.209
$\frac{31}{32}$	$\frac{62}{64}$.96875 — 24.606
	$\frac{63}{64}$.984375 — 25.003
$\frac{1}{1}$	$\frac{64}{64}$	1.000 — 25.400

MM	INCHES	MM	INCHES
1	— 0.039370	51	— 2.007874
2	— 0.078740	52	— 2.047244
3	— 0.118110	53	— 2.086614
4	— 0.157480	54	— 2.125984
5	— 0.196850	55	— 2.165354
6	— 0.236220	56	— 2.204724
7	— 0.275591	57	— 2.244094
8	— 0.314961	58	— 2.283465
9	— 0.354331	59	— 2.322835
10	— 0.393701	60	— 2.362205
11	— 0.433071	61	— 2.401575
12	— 0.472441	62	— 2.440945
13	— 0.511811	63	— 2.480315
14	— 0.551181	64	— 2.519685
15	— 0.590551	65	— 2.559055
16	— 0.629921	66	— 2.598425
17	— 0.669291	67	— 2.637795
18	— 0.708661	68	— 2.677165
19	— 0.748031	69	— 2.716535
20	— 0.787402	70	— 2.755906
21	— 0.826772	71	— 2.795276
22	— 0.866142	72	— 2.834646
23	— 0.905512	73	— 2.874016
24	— 0.944882	74	— 2.913386
25	— 0.984252	75	— 2.952756
26	— 1.023622	76	— 2.992126
27	— 1.062992	77	— 3.031496
28	— 1.102362	78	— 3.070866
29	— 1.141732	79	— 3.110236
30	— 1.181102	80	— 3.149606
31	— 1.220472	81	— 3.188976
32	— 1.259843	82	— 3.228346
33	— 1.299213	83	— 3.267717
34	— 1.338583	84	— 3.307087
35	— 1.377953	85	— 3.346457
36	— 1.417323	86	— 3.385827
37	— 1.456693	87	— 3.425197
38	— 1.496063	88	— 3.464567
39	— 1.535433	89	— 3.503937
40	— 1.574803	90	— 3.543307
41	— 1.614173	91	— 3.582677
42	— 1.653543	92	— 3.622047
43	— 1.692913	93	— 3.661417
44	— 1.732283	94	— 3.700787
45	— 1.771654	95	— 3.740157
46	— 1.811024	96	— 3.779528
47	— 1.850394	97	— 3.818898
48	— 1.889764	98	— 3.858268
49	— 1.929134	99	— 3.897638
50	— 1.968504	100	— 3.937008

Emerson Bearing
201 Brighton Avenue
Boston, MA 02134
Tel: 617.782.1400
800.225.4587
Fax: 617.782.0535
info@emersonbearing.com
www.emersonbearing.com