

Industrial shaft seals





SKF is a registered trademark of the SKF Group.

© SKF 2006

The contents of this publication are the copyright of the publisher and may not be reproduced (even extracts) unless permission is granted. Every care has been taken to ensure the accuracy of the information contained in this publication but no liability can be accepted for any loss or damage whether direct, indirect or consequential arising out of the use of the information contained herein.

Publication 5300 EN · January 2006

This publication supersedes publication 4006.

Printed in Germany on environmentally friendly paper.

Industrial shaft seals

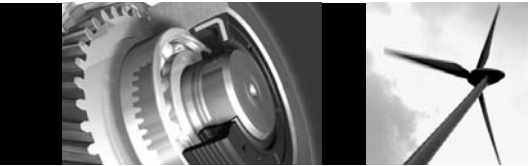

HMSA 10 RG



HDS7



Welcome

The business of the SKF Group consists of the design, manufacture and marketing of the world's leading brand of rolling bearings, with a global leadership position in complementary products such as seals for rotating machine components and hydraulic seals. SKF also holds an increasingly important position in the market for linear motion products, high precision aerospace bearings, machine tool spindles, plant maintenance services, and is an established producer of high-quality bearing steel.

The SKF Group maintains specialized business operations to meet the needs of the global marketplace. SKF supports specific market segments with ongoing research and development efforts that have led to a growing number of innovations, new standards and new products.

The SKF brand now stands for more than ever before, and means more to you as a valued customer. While SKF maintains its leadership as the hallmark of quality bearings throughout the world, new dimensions in technical advances, product support and services have evolved SKF into a truly solutions-oriented supplier, creating greater value for customers. These solutions encompass ways to bring greater productivity to customers, not only with breakthrough application-specific products, but also through leading edge design simulation tools and consultancy services,

plant asset efficiency maintenance programs, and the industry's most advanced supply management techniques.

The SKF brand still stands for the very best in rolling bearings, but it now stands for much more:

SKF – the knowledge engineering company

The Group has a global ISO 14001 environmental certification. Individual divisions have been approved for quality certification in accordance with either ISO 9000 or QS 9000. Some 80 manufacturing sites worldwide and sales companies in 70 countries make SKF a truly international corporation.

In addition, our 7000 distributors and dealer partners around the world, the e-business marketplace and global distributions system, put SKF close to customers for the supply of both products and services. In essence, SKF solutions are available wherever and whenever our customers need them.

Overall, the SKF brand now stands for more than ever before. It stands for the knowledge engineering company ready to serve you with world-class product competencies, intellectual resources, and the vision to help you succeed.

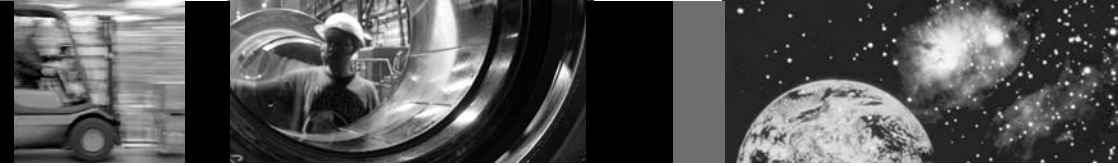

Seals and sealing technology are essential parts of the capabilities of SKF. Seals from SKF stand for excellence and leadership. The SKF brand symbolize consistent endeavor to achieve total quality in all processes and imply three main benefits for our customers:

Reliability – thanks to modern, efficient products, based on worldwide application know-how, optimized materials, forward-looking designs and the most advanced production techniques.

Market lead – an advantage of our products and services. Our customers increase operating time, reduce down-time, improve output and product quality.

Cost effectiveness – resulting from the favorable ratio between our product quality plus service facilities, and the purchase price of the product.

Bearing arrangements of all types do not only consist of bearings but include the associated components, such as shafts and housings, as well as seals. The performance of the seal is of decisive importance where lubricant cleanliness is concerned and this cleanliness has considerable influence on bearing life, as can be seen, for example, when the SKF Life Theory is applied.

For the designer, this means that bearings and seals must be considered as constituting a system. When designing the sealing arrangement and selecting the seal, the bearing arrangement and the requisite bearing life must not be neglected. For SKF, this means that even greater attention is now being paid to the question of how bearings and bearing arrangements should be sealed, as well as to the question of sealing in general. This catalogue contains information and recommendations regarding the selection and application of seals. Obviously, it is not possible to cover all the aspects sufficiently in detail to deal with all eventualities so that reference is made in many places to the SKF application engineering service.

Welcome with your inquiry to SKF – the knowledge engineering company.

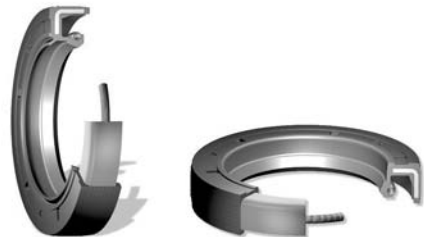

Industrial seals product structure

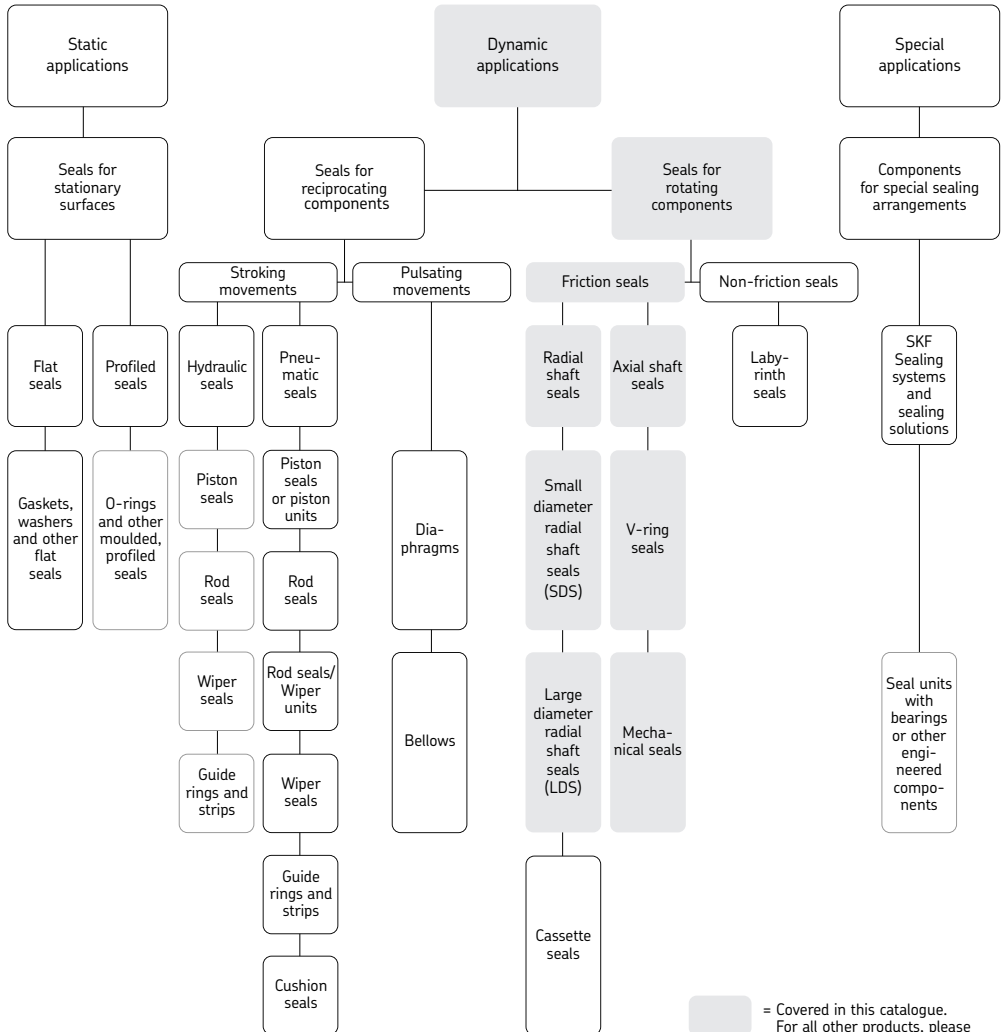

 = Covered in this catalogue. For all other products, please contact your SKF representative for further information.

Industrial shaft seals

7	Product data - General
49	Radial shaft seals
279	Wear sleeves
315	Mechanical seals
321	V-ring seals
365	Axial clamp seals



Product data – General

Contents

- 9 Industrial shaft seal designs**
- 10 Industrial shaft seals, profile overview**
- 13 Selection of seal design**
 - 14 Grease retention
 - 15 Oil retention
 - 16 Contaminant exclusion
 - 17 Retention and exclusion
 - 18 Separation of two liquids
 - 19 Circumferential and rotational speed
 - 20 Pressure
 - 21 Available space
 - 22 Installation restrictions
 - 23 Arrangement
 - 24 Counterface design
 - 25 Axial movement
- 26 Seal materials**
 - 26 Shells
 - 26 Garter springs
 - 26 Bore-Tite®
 - 26 Adhesives
 - 27 Sealing lip material
 - 28 Nitrile rubber (NBR)
 - 28 Duralip® (X-NBR)
 - 28 Duratemp® (HNBR)
 - 28 Polyacrylate elastomer (ACM)
 - 28 Silicone rubber (MVQ)
 - 29 Fluoro rubber (FPM)
 - 29 Polytetrafluoro-ethylene (PTFE)
 - 30 Wear resistance
 - 31 Operating temperatures
 - 32 Chemical resistance
- 44 Storage and handling of seals**
 - 44 General
 - 44 Store
 - 45 Storage and handling
 - 45 Cleaning and maintenance
- 46 Questionnaire form**

Industrial shaft seal designs

The seals shown in this catalogue are intended for the sealing of openings between a rotating and a stationary component or between two components in relative motion. The tasks of the seals are

- to retain lubricant,
- to exclude contaminants,
- to separate fluids or gases, and
- to withstand differences in pressure.

The seals should also perform adequately with a minimum of friction and wear even in critical applications or under unfavourable operating conditions.

In order to meet these different requirements, SKF shaft seals for rotating machine components are produced in many designs, materials and executions. Each of these designs and their material combinations has specific properties which make it more, or less, suitable for a particular application. The main groups are:

Radial shaft seals

- Small diameter seals (SDS, for shaft diameters up to 200 mm/8 inch),
- Large diameter seals (LDS, for shaft diameters over 200 mm/8 inch),
- Radial shaft seals, PTFE material.

Axial shaft seals

- Mechanical seals,
- V-ring seals,
- Axial clamp seals.

Wear sleeves are also manufactured as special accessories.

The inclusion of a single design to the SKF range of seals is not an indication of its availability; this should always be checked before ordering. The products shown in the size listing tables in this catalogue are the more popular metric and inch sizes. Information about the complete range will be found in our standard range stock list, which can be supplied on request.

Industrial shaft seals, profile overview

Radial shaft seals

Small diameter seals, standard program



Large diameter seals, standard program

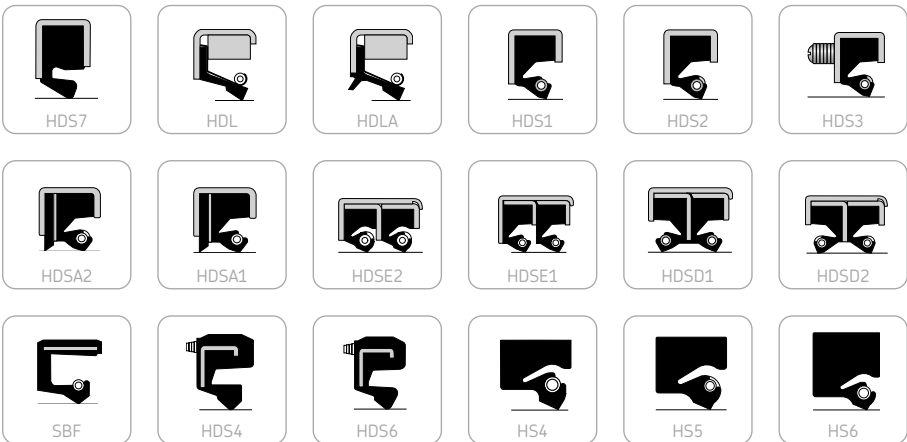

Large diameter seals, standard program

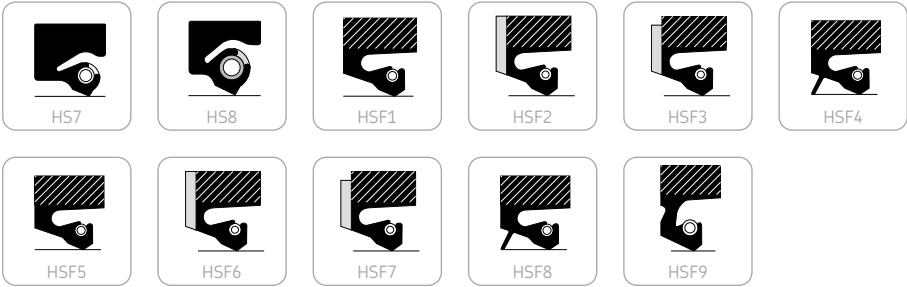

Radial shaft seals, PTFE materials

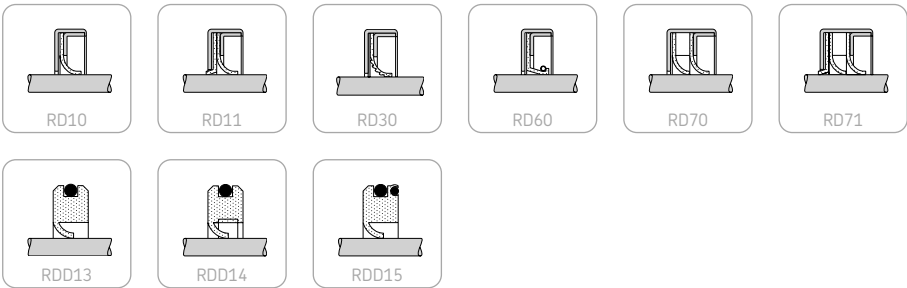

Industrial shaft seals, profile overview

Axial shaft seals

Mechanical seals



V-ring seals



Axial clamp seals



Selection of seal design and material

The choice of an appropriate seal design and material is depending on the applications' predominant operating conditions, such as

- type of lubrication,
- sliding velocity at the sealing surface (counterface),
- vertical or horizontal mounting,
- misalignment or deviation from coaxiality of the shaft.

The seal environment must also be taken into account, for example, whether

- chemical or mechanical factors and/or
- thermal conditions

can influence seal performance. The available space, requirements regarding sealing efficiency and finally the viable cost must be considered.

Depending on the application one or other of the influences will dominate so that universally valid rules for the selection of the appropriate type or design of seal cannot be given. The following comments regarding the properties of the different seals should, however, give some guidance.

The selection matrix with permissible operating conditions for small diameter radial shaft seals (SDS) on **pages 98 and 99**, for large diameter radial shaft seals (LDS) on **pages 100 to 103** provides an overview of the seals, their design features and their suitability for various operating conditions.

It has not been possible to include all design variants in the matrix; rather a representative selection has been chosen. Detailed information on the variants as well as the seals shown in the matrix will be found in the introductory texts preceding each table section. Since only a limited number of symbols have been used in the matrix for reasons of clarity and space, it has not been possible to exactly differentiate between the various seal types.

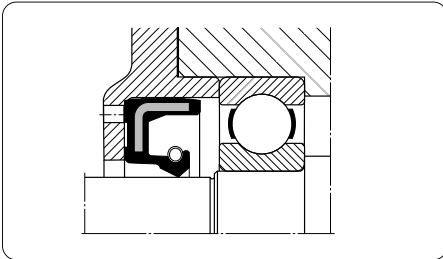

Fig 1. HMS5 seal

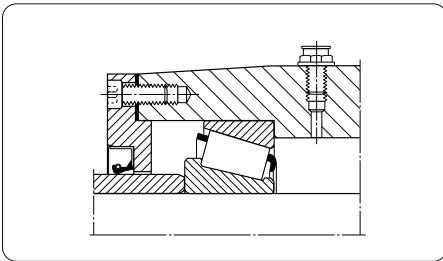

Fig 2. CRW1 seal

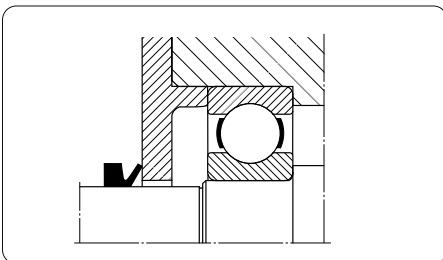

Fig 3. V-ring seal

Grease retention

Greases have a relatively high viscosity and are thus relatively easy to retain in the bearing arrangement. This means that the demands on the seal are moderate, so that almost any type of seal will suffice.

Spring-loaded radial shaft seals, e.g. the HMS5 or the CRW1 (**fig 1 and fig 2**) design, are suitable for retaining greases. When frequent relubrication is required, the lip of at least one of the seals should be arranged to point away from the grease so that excess grease can escape via this seal lip. In this way a build-up of grease, and consequently of heat, can be avoided. When the lubrication of a seal lip cannot be guaranteed, the use of seals having an additional, secondary lip, where the space between the primary and secondary lips is filled with grease, is recommended. Because of the unfavourable heat transfer conditions with grease lubrication it is recommended that the permissible circumferential speeds quoted for oil lubrication should be halved.

In addition to radial shaft seals, with or without garter spring, V-ring seals (**fig 3**) or felt seals are also suitable for grease retention.

Oil retention

Lubricating oils, particularly relatively low-viscosity oils, are much more difficult to retain in a bearing arrangement than greases. Therefore, spring-loaded radial shaft seals are used almost exclusively, e.g. SKF seals of the CRW1 (fig 4), HMS5 (fig 5) or HDS3 designs.

For very arduous conditions where circumferential (peripheral) speeds are relatively low the HDDF (fig 6) mechanical seals are also suitable for oil retention.

Normally, CRW1 radial shaft seals with the hydrodynamically formed Waveseal lip are adequate. The Waveseal lip has a sinusoidally formed lip edge which produces a pumping action to the inside as well as the outside, irrespective of the direction of rotation of the shaft (or the housing). When it is desired to protect the sealing position against dust or fine solid contaminants, it is recommended to use a radial shaft seal with a secondary (dust) lip, e.g. of the CRWA1 design.

V-ring seals (fig 7) may also be used to retain oil. In this case they should be arranged on the oil side and should be axially supported on the shaft.

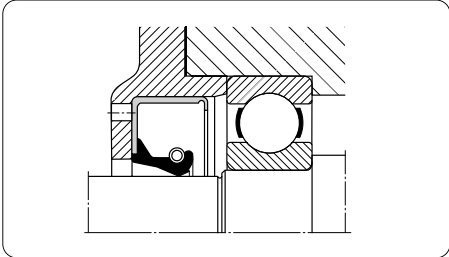

Fig 4. CRW1 seal

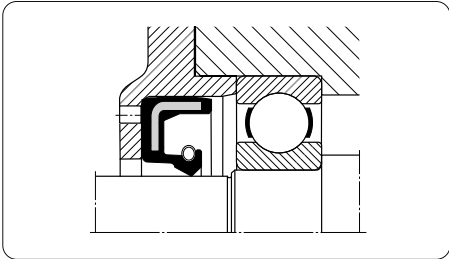

Fig 5. HMS5 seal

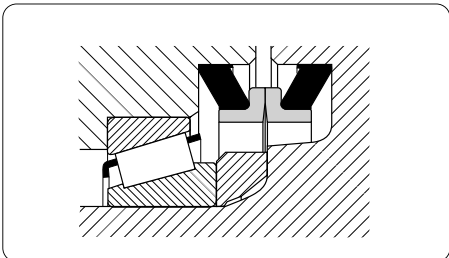

Fig 6. HDDF mechanical seal

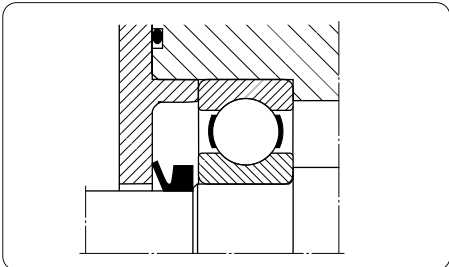

Fig 7. V-ring seal

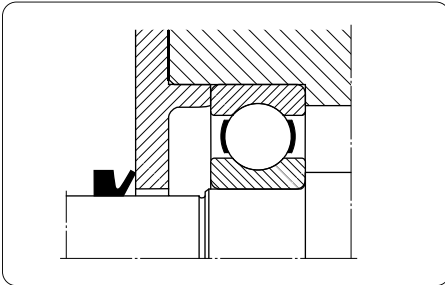

Fig 8. V-ring seal

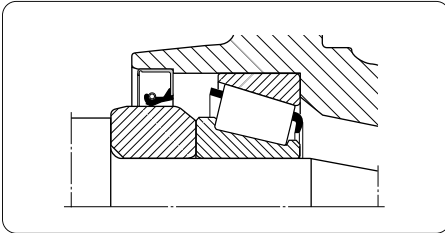

Fig 9. CRW1 seal

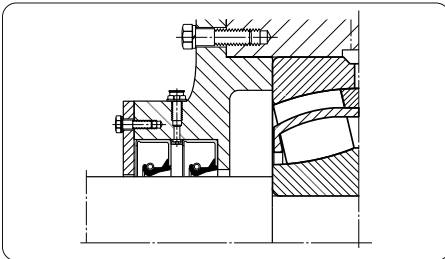

Fig 10. CRW1 seals in tandem

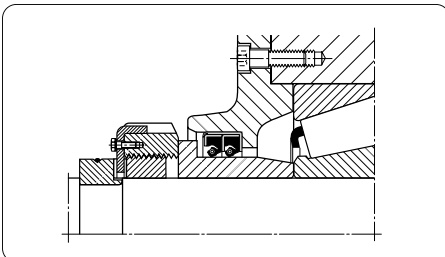

Fig 11. HDSE2 seal

Contaminant exclusion

V-ring seals (**fig 8**) are eminently suitable for excluding contaminants. They rotate with the shaft, act as flingers and seal against a surface which is at right angles to the shaft.

Radial shaft seals which are primarily intended to exclude contaminants should be mounted with the lip pointing outwards. For low-speed applications and normal operating conditions, any radial shaft seal may be used.

For difficult conditions, the use of SKF Waveseal designs, e.g. the CRW1 (**fig 9**) or CRWH1 designs, which have hydrodynamic sealing aids, is recommended, or alternatively the heavy-duty HDS seals. To reinforce sealing efficiency two seals may be arranged in tandem (**fig 10**), or a double-lip seal with its two lips in tandem, e.g. of the HDSE (**fig 11**) design, may be used.

A V-ring or axial clamp seal (CT) can also protect the primary seal from coarse contaminants. The side of the housing or the shell of a radial shaft seal can serve as the counterface for the lips of the V-ring and CT seals.

Retention and exclusion

In many applications, the exclusion of contaminants is just as important as lubricant retention. The use of a seal with a secondary (dust) lip in addition to the primary lip, such as in the CRWHA1 (fig 12) will often suffice.

Another way of mastering the problem of simultaneous retention and exclusion is to use two seals arranged in opposite directions, e.g. two CRW1 (fig 13) or two HDS2 (fig 14) radial shaft seals.

Highly efficient double action seals are also obtained by using two opposing V-ring seals (fig 15) with a thrust washer machined on both sides situated in between the seals.

Under extremely difficult conditions the use of the HDDF mechanical seals, (fig 6), is recommended, providing that the sliding velocity of the mating surfaces lies within the permissible range.

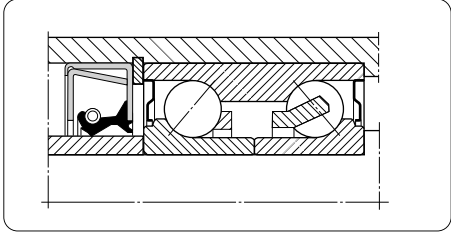

Fig 12. CRWHA1 seal

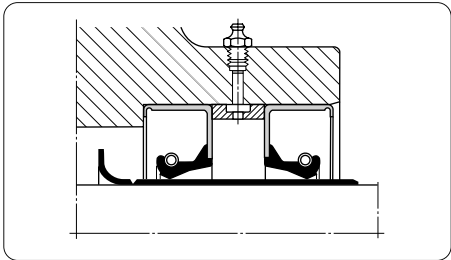

Fig 13. CRW1 seal

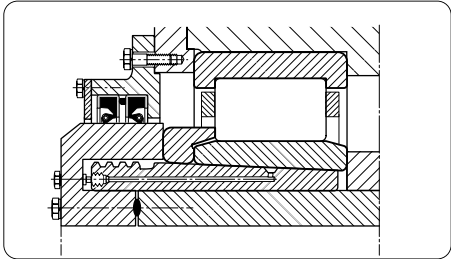

Fig 14. HDS seals

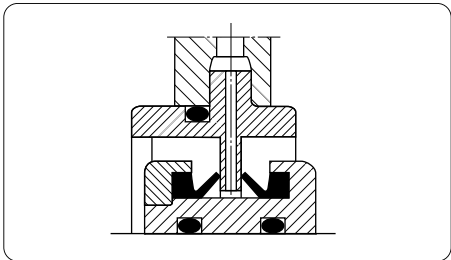

Fig 15. V-ring seals

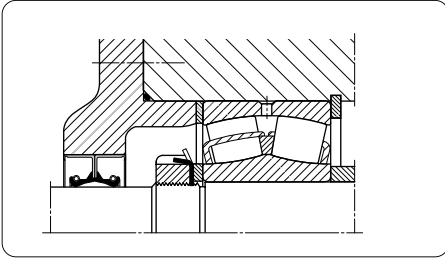

Fig 16. CRW1 seals

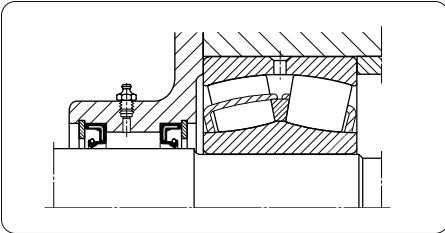

Fig 17. HMS5 seals

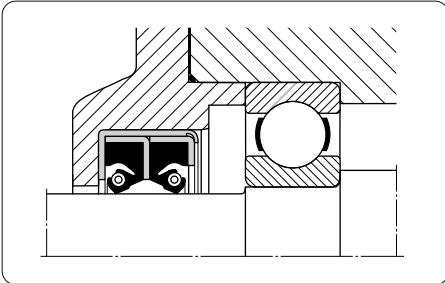

Fig 18. HDSD1 seal

Separation of two liquids

In cases where two liquids have to be kept separate there are two alternatives, depending on the available space and the required efficiency.

Either two separate seals (**fig 16, fig 17**) may be used with their lips facing in opposite directions, or double lip seals of the HDSD1 (**fig 18**) design can be used. Again, the lips point in opposite directions.

In both alternatives, the lips must be spring loaded. In case one or other of the lips occasionally runs dry, i.e. one of the liquids is temporarily absent, it is recommended that grease be applied in the space between the two lips during installation, so that adequate lubrication of the lips is always assured.

Circumferential and rotational speed

The permissible rotational speeds are determined by the diameter of the sealing surface and the permissible circumferential speeds at the sealing position.

The permissible circumferential speeds depend mainly on the design and material of the sealing lip which govern the heat generation at the seal contact. They also depend on the material and condition of the counterface. The lubrication of the lip as well as the type and characteristics of the medium being sealed also have an influence, as the medium may be able to transport heat away from the lip contact.

Diagram 1 shows a comparison of the permissible circumferential speeds for various seal designs assuming normal seal operation, e.g. grease or oil retention and no pressure differential across the seal.

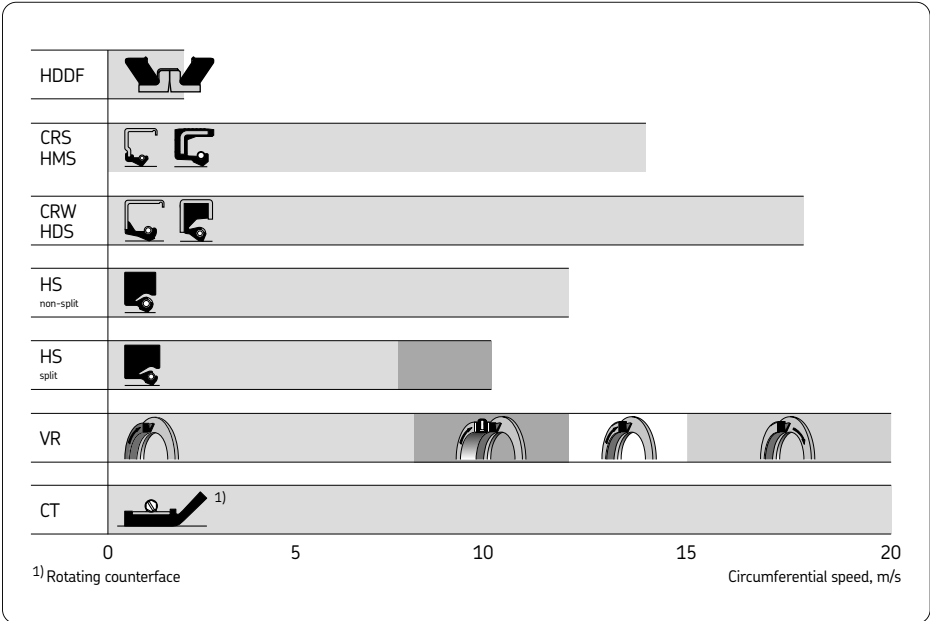

Diagram 1

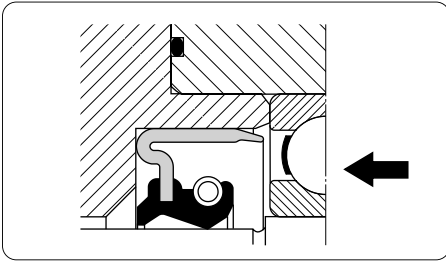

Fig 19. CRWA5 seal

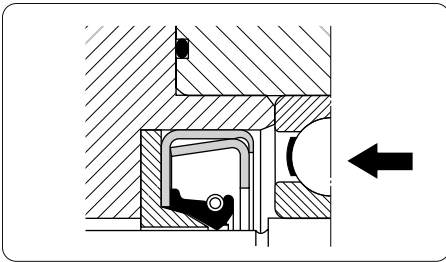

Fig 20. CRWH1 seal + support ring

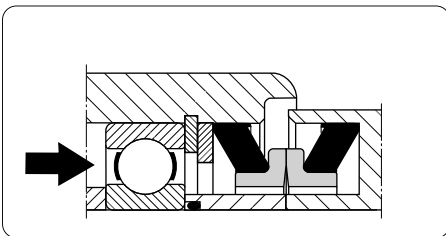

Fig 21. HDDF mechanical seal

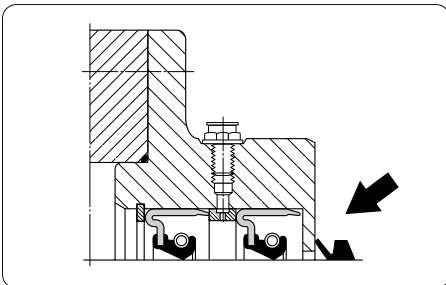

Fig 22. CRW5 seals + V-ring seal

Pressure

A difference in pressure from one side of the sealing position to the other usually means that radial shaft seals of a particular design with garter spring have to be used, as other standard seal types can normally only withstand a pressure differential of the order of 0,07 MPa at relatively slow speeds.

Generally, for positions where a pressure differential exists, CRW5 or CRWA5 (**fig 19**) seals are recommended as these can withstand pressures of up to 0,63 MPa at speeds of up to 5 m/s.

When subjected to pressure, the lip of the seal will be pressed harder against its counterface causing more friction and a rise in underlip temperature. When speeds are high this will lead to accelerated wear and will appreciably shorten the service life of the seal and its counterface. Where there is a pressure differential, the pressure and circumferential speed should be carefully matched.

Temporary pressure differentials may make it necessary to use a second seal, for example, an additional radial shaft seal with the lip pointing towards the higher pressure or a V-ring seal (**fig 22**) with its lip directed towards the lower pressure.

When subjected to pressure, shaft seals should be axially located at the low pressure side (**fig 20** and **fig 21**) to prevent them from being pressed out of the housing. In the case of standard radial shaft seals, additional radial support for the seal may be beneficial as this will prevent excessive distortion of the seal under pressure and excessive lip pressure on the counterface.

Available space

In many cases, the space available for the seal is insufficient to allow the use of standard radial shaft seals having dimensions to ISO 6194 or DIN 3670. Special designs of radial shaft seals must then be used (**fig 23, fig 24**), or V-ring seals (**fig 25**), which can be positioned outside the actual sealing position, are also suitable.

Where V-ring seals (**fig 25**) can be used, exceptionally economic sealing arrangements can be produced, and additionally, the V-rings are extremely easy to install. The V-ring seals axially and the lip exerts a light pressure against the counterface which may be a stationary or rotating machine component.

Where space is limited radially or axially, and where shafts have large diameters, seals of the HS8 design may be used (**fig 26**).

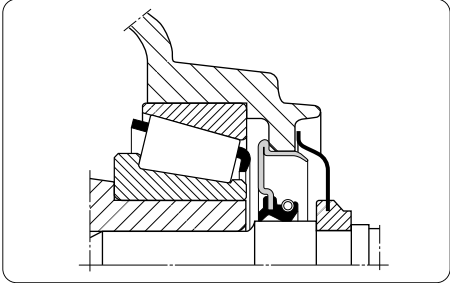

Fig 23. CRW special seal

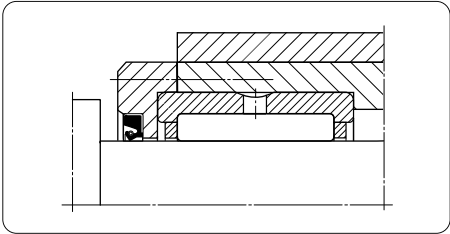

Fig 24. HMS special seal

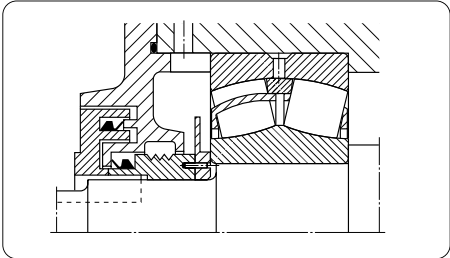

Fig 25. V-ring seals

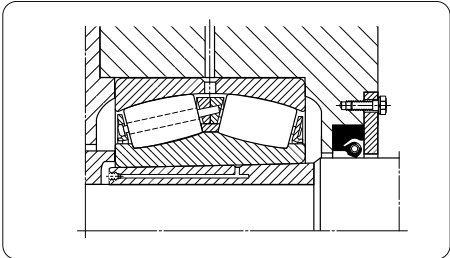

Fig 26. HS8 seal

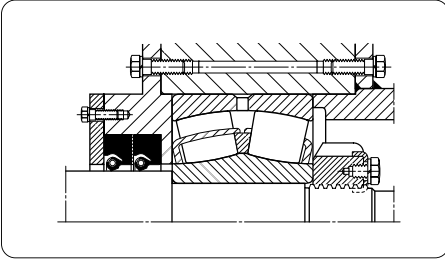

Fig 27. HS8 seals

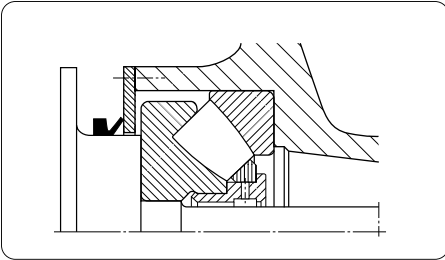

Fig 28. V-ring seal

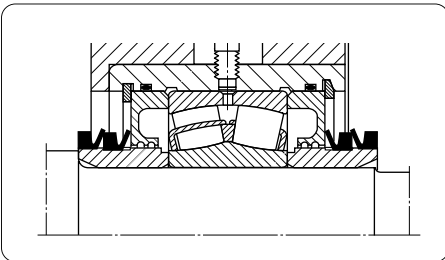

Fig 29. V-ring seals

Installation restrictions

For applications where the design is such that the seal cannot be installed via the shaft end, or where it is only possible with difficulty, the elastic V-ring seals may be suitable, or any of the split radial shaft seals of the HS6, HS7 and HS8 (**fig 26, fig 27**) designs may be used.

These radial shaft seals are made of elastomer only without any reinforcement. They are therefore particularly simple to install. After positioning on the shaft, they are held together by the garter spring which is joined either by a threaded or control wire connector or by a hook and eye. They should be retained axially in the housing bore by an end cover, which may be either in one piece or split.

Split HS radial shaft seals are suitable for circumferential speeds at the sealing lip of up to 7,5 or 10 m/s. They are available for shaft diameters from approximately 170 to approximately 4.570 mm.

V-ring seals are elastic and can be stretched. They can therefore be installed by passing them over other components (**fig 28**). However, should V-ring replacement require the time consuming removal of several components, it is more advantageous to mount one or two replacement V-rings on the shaft, when making the first installation (**fig 29**). When the time comes to replace a worn V-ring, it can easily be cut through and removed and the replacement ring can be simply and quickly moved to the correct position.

Arrangement

Generally speaking, all the seals listed in the product tables are suitable for use on horizontal as well as vertical shafts. However, the axial clamp CT seals should only be used as secondary (auxiliary) seals on horizontal shafts.

Seals on vertical shafts are usually more exposed to the surrounding media, e.g. rain water from the outside or lubricating oil from the bearing side, than seals on horizontal shafts.

V-ring seals (**fig 30, fig 31**) have an interference fit on the shaft and rotate with it. They have a flinger action and are therefore particularly suitable as primary or secondary seals on vertical shafts.

At relatively low speeds, the HDDF mechanical seals (**fig 32**) can efficiently retain grease and prevent the ingress of contaminants at vertical sealing positions.

Highly efficient sealing arrangements, e.g. for submersible pumps, can be achieved using radial shaft seals in tandem with a V-ring seal (**fig 33**) for added protection.

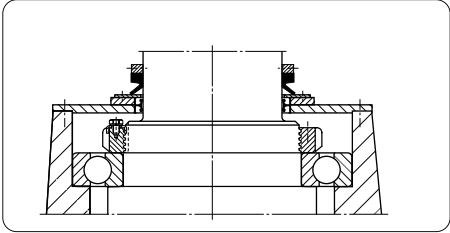

Fig 30. V-ring seal

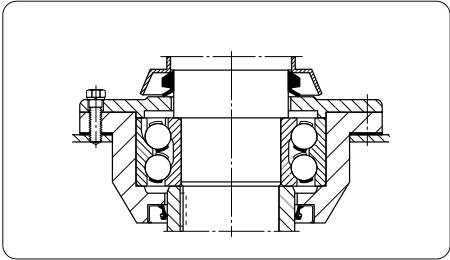

Fig 31. V-ring seal

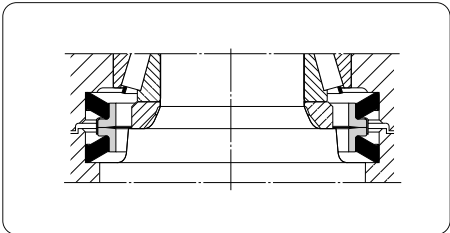

Fig 32. HDDF mechanical seal

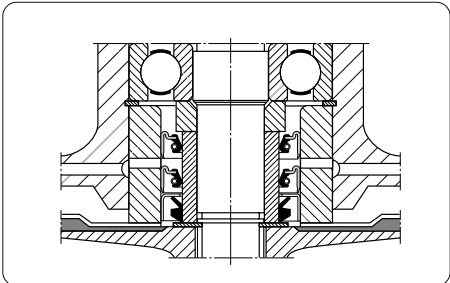

Fig 33. CRW5 seals + V-ring seal

Counterface design

The sealing efficiency and life of a seal are largely influenced by the

- surface finish and tolerance grade as well as the
- material and hardness

of the surface on which the sealing lip is to run, and also by the

- coaxiality deviation and
- runout of the shaft.

Too smooth a surface can lead to lubricant starvation at the lip/counterface contact and too rough a surface will wear the lip. Also, the surface should be without machine lead (directionality, grooves running diagonally towards or away from the seal lip) as this would cause leakage, depending on the direction of rotation.

Deviations from true coaxiality as well as misalignment of the shaft with respect to the housing bore result in uneven stressing of the lip of radial shaft seals. Part of the circumference of the lip will be unloaded thus reducing its pressure against the shaft whilst the remainder of the lip circumference will be more heavily loaded and the width of the path traced by the lip on the shaft will increase.

The runout of the shaft should be kept within narrow limits, particularly at high speeds, as there is a risk otherwise that the lip will not be able to follow the shaft in spite of the flexibility of the lip. The result will be gap formation between lip and shaft and a loss of sealing efficiency.

In contrast to radial shaft seals, V-ring seals and axial clamp seals are not affected by normal coaxiality deviations or runout.

Axial movement

Axial movement of the shaft relative to the housing bore will not detract from the sealing power of radial shaft seals (**fig 34**), provided that the total surface in contact with the lip has the same quality with respect to hardness and surface finish.

The amount of axial movement that can be accommodated by V-ring seals and axial clamp seals is limited by the permissible displacement of the seal relative to its counterface (see product tables).

Fig 34. Axial movement

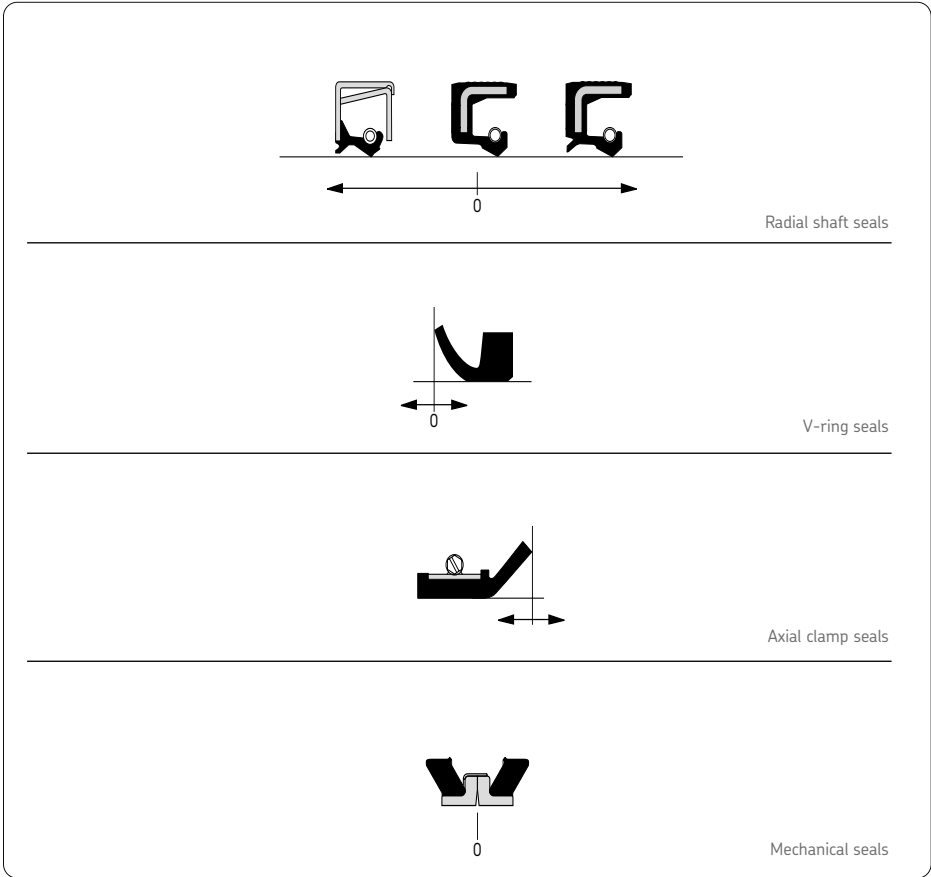

Seal materials

Shells

The outer and inner shells (case and reinforcement) of SKF radial shaft seals are made from deep-drawn carbon steel sheet as standard. The free surfaces are treated to protect them from corrosion during normal handling and storage.

SKF radial shaft seals which are to be used in corrosive environments can be equipped instead with stainless steel shells to special order and subject to factory approval.

Garter springs

The garter spring of SKF radial shaft seals is made of hard-drawn steel wire as standard. The exceptions are the large radial shaft seals of the HDS and HS designs where the standard garter spring is made of stainless steel.

In the product tables, those seals which have a garter steel, different from the standard one, are indicated under the heading “Notes”.

Bore-Tite®

Bore-Tite is a water-based polyacrylate sealant and is used as a coating on the outside diameter of some of the SKF radial shaft seals as standard. This non-hardening pliable sealant helps to fill small imperfections in the housing bore. BoreTite can be used at temperatures up to +200 °C and is resistant to most oils, greases, aqueous acids and alkalis, alcohols and glycols. It is not compatible with aromatics ketones and esters, although splashes of these substances that can be wiped off quickly have little or no effect. The Bore-Tite layer has a thickness of between approximately 0,03 to 0,07 mm.

Adhesives

In its endeavour to make its production processes as environmentally friendly as possible, SKF uses adhesives and bonding agents which are almost exclusively water-based. When used in the presence of fluids containing water, e.g. cutting fluids or cooling emulsions, and when operating temperatures are in the region of +65 °C or above, the nitrile rubber component of a seal may loosen from the carbon or stainless steel shell, although the nitrile rubber itself will not be affected.

Sealing lip materials

The sealing lips of SKF seals are generally made of elastomer materials. However, thermoplastic materials such as PTFE are gaining in importance. Thermoplastics are mainly used for special seals intended for particular applications where there are demands for high thermal or chemical resistance.

SKF seals are generally produced from the materials listed in **Table 1**. These materials have characteristic properties making them particularly suitable for specific applications; these characteristics are briefly described in the following. By changing the actual formulation and blending it is possible to modify the following properties:

- resistance to swelling,
- elasticity,
- chemical resistance,
- thermal resistance,
- behaviour in the cold, and/or
- gas permeability

of the elastomers to suit individual requirements. Details regarding the chemical resistance of the sealing lip materials to the various media encountered in operation will be found in the section "Chemical resistance".

A code is used to identify the material of the sealing lip of SKF seals, see **Table 1**. The codes also appear in the designations of the metric radial shaft seals. For seals where a combination of materials is used, a combination of the code letters is used, e.g. RD.

Table 1. SKF Sealing lip materials

Composition of basic material	Designation according to SKF	ISO1629 ISO1043.1, DIN 7728 Part 1	ASTM ¹⁾ D1418 ASTM D1600
Acrylonitrile-butadiene rubber (nitrile rubber)	R	NBR	NBR
Hydrogenated acrylonitrile-butadiene rubber (Duratemp®)	H	WNBR	NEM
Carboxylated nitrile rubber (Duratip®)	D	X-NBR	X-NBR
Polyacrylate elastomer	P	ACM	ACM
Silicone rubber	S	MVQ	VMQ
Fluoro rubber	V	FPM	FKM
Polytetrafluoro-ethylene	T	PTFE	PTFE
Leather	L	-	-
Felt	F	-	-

¹⁾ American Society for Testing and Materials

Nitrile rubber

The term nitrile rubber is used in this catalogue for acrylonitrile butadiene rubber. This material has very good engineering properties and is the “universal” seal material. It is a copolymer produced from acrylonitrile and butadiene. It shows good resistance to the following media:

- most mineral oils and greases with a mineral oil base,
- normal fuels: petrol, diesel and light heating oils,
- animal and vegetable oils and fats, and
- hot water.

It also tolerates short-term dry running of the sealing lip. The permissible operating temperature range is -50 to $+100$ °C; for brief periods temperatures of up to $+120$ °C can be tolerated.

Duralip®

Duralip is a carboxylated nitrile rubber developed by SKF which combines the good technical properties of nitrile rubber with a particularly high resistance to wear. It is mainly used for large seals having a bore diameter of 200 mm or more. Seals of this material should be chosen when abrasive substances such as sand, soil, scale etc. can reach the surface on which the sealing lip runs.

Duratemp®

Duratemp is a hydrogenated nitrile rubber which has appreciably improved wear resistance compared with nitrile rubber so that seals made of Duratemp have long life. Duratemp is also more resistant to heat, ageing and hardening in hot oil or ozone. Mixtures of oil in air may have a negative effect. The upper operating temperature limit is $+150$ °C, which is appreciably higher than that of ordinary nitrile rubber.

Duratemp is mainly used for large radial shaft seals.

Polyacrylate elastomer

Polyacrylate elastomer is more heat resistant than nitrile rubber or Duralip. The operating temperature range lies between -40 and $+150$ °C and in some fluids the upper limit may be extended to $+175$ °C. Seals of polyacrylate are resistant to ageing and ozone and are also suitable for use with lubricants containing EP additives. They should not be used to seal against water, acids or alkalis etc. Dry running should also be avoided.

Silicone rubber

Silicone rubber is characterised by high thermal resistance and can be used at temperatures between -70 and $+160$ °C. Another interesting property of silicone rubber is that it absorbs lubricant and thus reduces friction and wear to a minimum. SKF silicone rubber seals are particularly suitable for service at very low or very high temperatures and for low-friction sealing of bearing arrangements. They are not very resistant to oxidised oils or to certain EP additives, however, and they should be protected against abrasive substances. The lip should not be allowed to run dry.

Fluoro rubbers (LongLife®)

Fluoro rubbers are characterised by their high thermal and chemical resistance. Their resistance to ageing and ozone is also very good and their gas permeability is very slight.

SKF fluoro rubber seals have exceptionally good properties even under harsh environmental conditions and can withstand operating temperatures of up to $+200$ °C. The seals are also resistant to oils and hydraulic fluids, fuels and lubricants, mineral acids and aliphatics as well as aromatic hydrocarbons which would cause seals made of other materials to fail. They will also tolerate dry running of the lip for short periods. The seals should not be used in the presence of esters, ethers, ketones, certain amines and hot anhydrous hydrofluorides.

Because of their useful properties, SKF produces fluoro rubber seals for all common shaft diameters from 3 to 1.575 mm.

At temperatures above 300 °C, fluoro rubber gives off dangerous fumes. This can occur, for example, if a welding torch is used when dismantling a bearing. Although the fumes are only produced at high temperatures, once heated the seals will be dangerous to handle even when they have cooled down. If it is necessary to handle fluoro rubber seals which have been subjected to excessive temperatures, the following should be observed:

- protective goggles and gloves should always be worn,
- the remains of seals should be put in an airtight plastic container which should be marked with a suitable symbol for "material will etch",
- respect the information given on the appropriate safety data sheet.

If there is unintentional contact, hands should be washed with soap and plenty of water and water should also be used as an eye bath. A doctor should always be consulted. This also applies if, during heating of the seals, the vapours have been inhaled. SKF takes no responsibility for the improper handling of fluoro rubber seals nor for any injury resulting therefrom. The user is responsible for the correct use of the product during its service life and its proper disposal.

Polytetrafluoro-ethylene

Polytetrafluoro-ethylene, PTFE, is a thermoplastic polymer, the chemical resistance of which is far superior to that of any of the materials so far described. The operating temperature range extends from -70 to +200 °C and may go up to +260 °C. The effects of overheating are as described under fluoro rubber.

PTFE has a smooth dirt-resistant surface and a very low coefficient of friction. The seals will tolerate dry running and also provide insulation against the passage of electric current.

SKF seals of PTFE, or with PTFE sealing lips, are made to special order and represent tailored solutions to specific problems.

Wear resistance

The wear resistance of seals is largely determined by the material from which the sealing lip is made and is also influenced by the surface finish of the counterface, the type of lubrication, the circumferential speed, the temperature and the pressure differential.

A comparison of the wear resistance of the various materials used by SKF for the sealing lips is shown in **Diagram 2**. It is valid for seals of the same size operating under identical conditions. Although the use of SKF seals made of the wear resistant LongLife materials fluoro rubber or PTFE is initially more expensive than if nitrile rubber seals are used, the total costs may be lower because of reduced maintenance and less downtime.

More detailed information on the material properties will be found in the section “Materials”.

Diagram 2

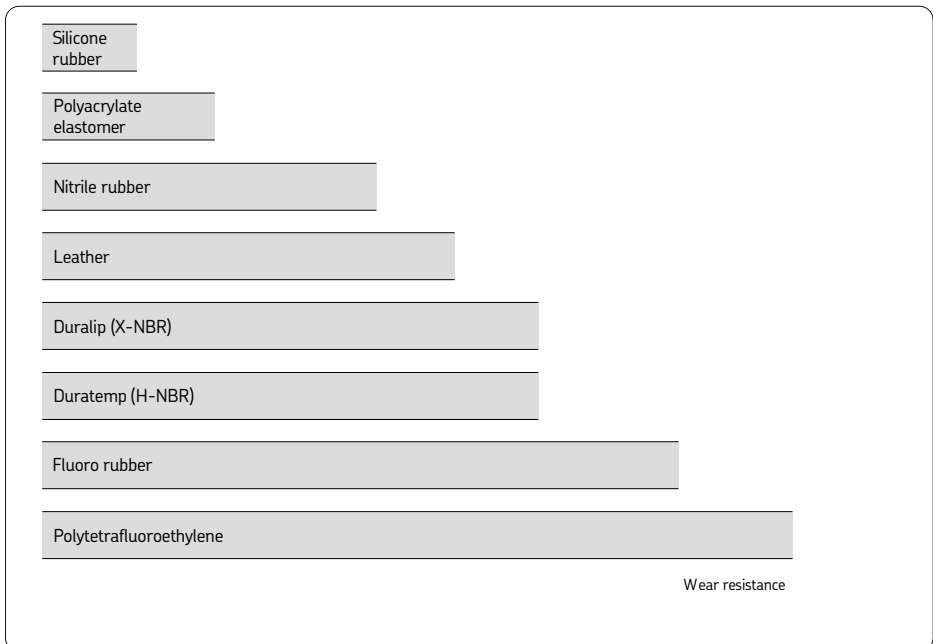

Operating temperatures

Low as well as high temperatures influence the effectiveness of seals. At low temperatures, the sealing lip will lose its elasticity and become hard and brittle. Sealing efficiency will decrease and the seal will become more susceptible to mechanical damage. The static seal between the seal outside diameter and the housing bore may also be affected if the materials are different and shrink at different rates. To avoid such problems when aluminium alloy housings are used, for example, radial shaft seals with an elastomeric outside diameter are recommended.

Friction, the circumferential speed of the seal lip, temperature, the viscosity of the medium being sealed as well as the specific heat transfer along the shaft all influence the temperature at the sealing position and the temperature between the lip and lubricant film on the counterface. High temperatures generally lead to a breakdown of the lubricant film. Lack of lubrication is one of the most common causes of premature seal failure. For applications where temperatures are continuously high, special high-temperature lip materials should be used, e.g. SKF LongLife seals of fluoro rubber (FPM) or polytetrafluoro-ethylene (PTFE).

To illustrate the thermal resistance of the various materials normally used by SKF, the permissible operating temperature ranges are shown in **Diagram 3**.

Diagram 3

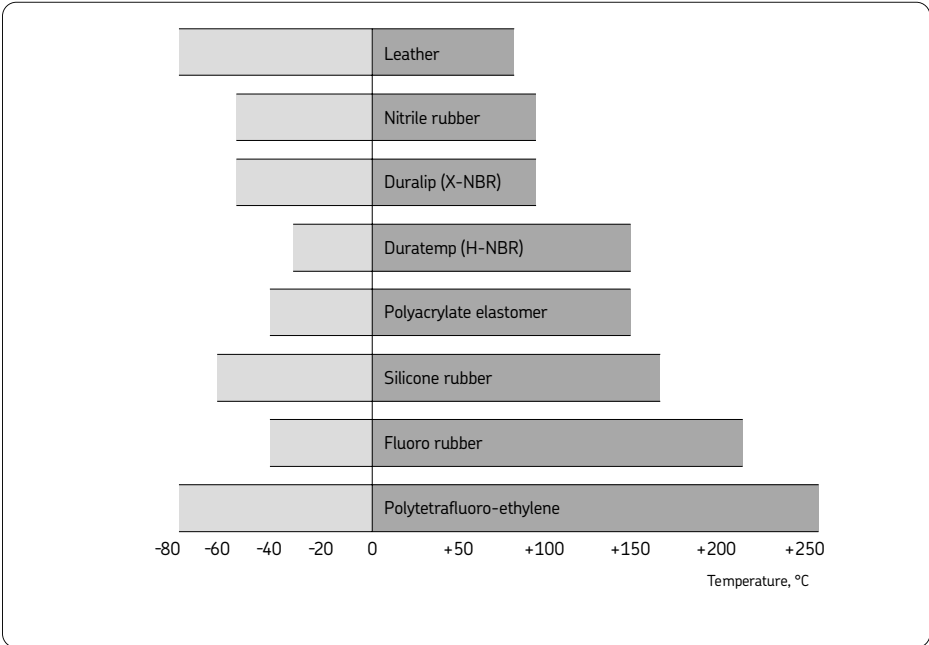

Chemical resistance

In the table “Chemical resistance” (from page 33 to page 43) information will be found about the chemical resistance of SKF seal materials to most of the substances encountered in industrial applications. The information is based on in-house testing and the experience of users, as well as information from the suppliers of the various materials. Unless otherwise stated, the information is valid for media of commercial purity and quality.

The chemical resistance of seals is also influenced by temperature as well as pressure and the amount of media present. Other factors which are important when selecting a suitable seal material include:

- the type of service, static or dynamic,
- the circumferential speed of the sealing lip,
- the shaft and housing materials,
- the surface finish of the counterface.

Therefore, the information contained in the table “Chemical resistance” can only be considered as a rough guide. In case of doubt, particularly if previous experience is lacking, or where well-proven seals are to be used under different operating conditions, it is advisable to contact SKF for advice.

Explanation

RT = room temperature

1 = minor effect

2 = moderate effect

3 = static only

4 = not recommended

5 = insufficient data, test before use

Chemical resistance

Medium	Temperature °C	Lip material			
		R D H	V	P	S
A					
Acetaldehyde	RT	4	4	4	2
Acetamide	RT	1	2	4	2
Acetic acid, 100% (glacial)	60	3	3	4	2
Acetic acid, 30%	RT	2	2	4	1
Acetic acid, 3% (vinegar)	RT	2	1	4	1
Acetic anhydride	RT / 80	3	4	4	3
Acetone	RT	4	4	4	3
Acetophenone	RT	4	4	4	4
Acetylene	60	1	1	5	2
Acrylonitrile	RT / 60	4	3	4	4
Adipic acid (aq)	RT	1	1	5	5
Alum (aq)	100	1	1	4	1
Aluminium acetate (aq)	RT	2	4	4	4
Aluminium chloride (aq)	RT	1	1	1	2
Aluminium fluoride (aq)	RT	1	1	5	2
Aluminium nitrate (aq)	RT	1	1	5	2
Aluminium phosphate (aq)	RT	1	1	5	1
Aluminium sulphate (aq)	RT / 60	1	1	4	1
Ammonia (anhydrous)	RT	2	4	4	3
Ammonia gas	RT	1	4	4	2
Ammonia gas	80 / 100	4	4	4	1
Ammonium carbonate (aq)	RT / 60	2	5	4	5
Ammonium chloride (aq)	RT / 60	1	1	5	5
Ammonium chloride (dry) (sal ammoniac)	RT	1	1	1	2
Ammonium nitrate (aq)	RT	1	5	2	5
Ammonium persulphate (aq)	RT	4	5	4	5
Ammonium phosphate (aq)	RT / 60	1	5	5	1
Ammonium sulphate (aq)	100	1	4	4	5
Amyl acetate	RT	4	4	4	4
Amyl alcohol	60	2	2	4	4
Aniline	60 / 100	4	3	4	4
Aniline dyes	RT	4	2	4	3
Aniline hydrochloride	RT	2	2	4	4
Aniline hydrochloride	100	4	5	5	5
Animal fats	80	1	1	1	2
Aqua Regia	RT	4	5	4	4
Arsenic acid	RT / 60	1	1	3	1
Arsenic trichloride (aq)	RT	1	5	5	5
Asphalt (liquid)	100	2	2	4	4
B					
Barium chloride (aq)	RT / 60	1	1	1	1
Barium hydroxide (aq)	RT / 60	1	1	4	1
Barium sulphate	RT / 60	1	1	4	1
Barium sulphide (aq)	RT / 60	1	1	4	1

Chemical resistance

Medium	Temperature °C	Lip material			
		R D H	V	P	S
Beer	RT	1	1	4	1
Benzaldehyde	RT / 60	4	4	4	4
Benzene	RT	4	1	4	4
Benzene sulphonic acid	RT	4	1	4	4
Benzoic acid	RT / 60	4	1	4	4
Benzoyl chloride	RT	4	1	4	5
Benzyl alcohol	RT / 60	4	1	1	2
Benzyl benzoate	50 / 60	4	1	4	5
Benzyl chloride	RT	4	1	4	4
Blast furnace gas	100	4	1	4	1
Borax (aq)	RT / 60	2	1	5	2
Bordeaux mixture	RT	2	1	4	2
Boric acid	60 / 100	1	1	4	1
Brake fluid, ATE	80	4	4	4	1
Brake fluid, glycol ether	80	4	5	4	1
Brine (sodium chloride, aq)	RT / 50	1	1	4	1
Bromine, anhydrous (liquid/gaseous)	RT	4	1	4	4
Bromine trifluoride	RT	4	4	4	4
Bromine water	RT	4	1	4	4
Bromobenzene	RT	4	1	4	4
Bunker oil	60	1	1	1	2
Butadiene (gaseous or liquified)	RT	4	1	4	4
Butane (gaseous or liquified)	RT	1	1	1	4
Butter (animal fat)	RT / 80	1	1	1	2
Butyl acetate	RT	4	4	4	4
Butyl acrylate	RT	4	4	4	5
Butyl alcohol	RT	2	1	4	2
Butyl amines	RT	3	4	4	4
Butylene	RT	2	1	4	4
Butyl stearate	50	2	1	5	5
Butyraldehyde	RT	4	4	4	4
C					
Calcium acetate (aq)	RT	2	4	4	4
Calcium bisulphite (aq)	RT	1	1	4	1
Calcium chloride (aq)	60	1	1	1	1
Calcium hydroxide (aq)	RT	1	1	4	1
Calcium hypochlorite (aq)	RT / 60	2	1	4	2
Calcium nitrate (aq)	RT / 40	1	1	1	2
Cane sugar liquors	RT / 60	1	1	4	1
Carbon dioxide	RT	1	1	5	2
Carbon disulphide	RT	3	1	3	4
Carbonic acid	RT	2	1	1	1
Carbon monoxide	60	1	1	5	1
Carbon tetrachloride	RT / 60	3	1	4	4
Castor oil	RT	1	1	1	1

Chemical resistance

Medium	Temperature °C	Lip material			
		R D H	V	P	S
Cellosolve (ethyl glycol)	RT	4	3	4	4
Cellosolve acetate (ethyl glycol acetate)	RT	4	4	4	4
Chlorine (dry)	RT	4	1	4	4
Chlorine (wet)	RT	4	1	4	4
Chlorine dioxide	RT	4	1	4	5
Chlorine trifluoride	RT	4	4	4	4
Chloroacetic acid	60	4	4	4	5
Chloroacetone	RT	4	4	4	4
Chlorobenzene	RT	4	1	4	4
Chlorobromomethane	RT	4	1	4	4
Chlorobutadiene	RT	4	1	4	4
Chloroform	RT	4	1	4	4
Chlorosulphonic acid	RT	4	4	4	4
Chlorotoluene	RT	4	1	4	4
Chromic acid	60	4	1	4	3
Citric acid	60 / 70	1	1	5	1
Cobalt chloride (aq)	RT	1	1	4	2
Coconut oil	50 / 80	1	1	1	1
Cod liver oil	RT	1	1	1	2
Coke oven gas	80	4	1	4	2
Copper acetate (aq)	RT	2	4	4	4
Copper chloride (aq)	RT	1	1	1	1
Copper sulphate (aq)	60	1	1	4	1
Corn oil	RT / 60	1	1	1	1
Cottonseed oil	RT / 70	1	1	1	1
Cresol	50 / 70	4	1	4	4
Cumene (isopropylbenzene)	RT	4	1	4	4
Cyclohexane	RT	1	1	1	4
Cyclohexanol	RT	3	1	5	4
Cyclohexanone	RT	4	4	4	4
p-Cymene	RT	4	1	4	4
D					
Decahydronaphthalene (decalin)	RT / 60	4	1	5	4
Detergent	RT	1	1	4	1
Developing fluids (photography)	RT	1	1	5	1
Diacetone alcohol	RT	4	4	4	2
Dibenzyl ether	RT	4	4	5	5
Dibutyl amine	RT	4	4	4	3
Dibutyl ether	RT	4	3	3	4
Dibutyl phthalate	RT / 60	4	3	4	2
Dibutyl sebacate	RT / 60	4	2	4	2
o-Dichlorobenzene	RT	4	1	4	4
Dicyclohexylamine	RT	3	4	4	5
Diethyl amine	RT	2	4	4	2
Diethyl benzene	RT	4	1	5	4

Chemical resistance

Medium	Temperature °C	Lip material			
		R D H	V	P	S
Diethyl ether	RT	4	4	3	4
Diethyl sebacate	RT	2	2	4	2
Diisopropyl benzene	RT	4	1	5	5
Dimethyl aniline (Xylidine)	RT	3	4	4	4
Dimethyl ether	RT	1	2	4	1
Dimethyl formamide	RT / 60	2	4	4	2
Dimethyl phthalate	RT	4	2	4	5
Diocetyl phthalate	RT / 60	3	2	4	3
Diocetyl sebacate	RT / 60	4	2	4	3
Dioxane	RT / 60	4	4	4	4
Dioxolane	RT	4	4	4	4
Dipentene	RT	2	1	4	4
Diphenyl oxide	RT	4	1	4	3
Dowtherm oils	100	4	1	4	3
Dry cleaning fluids	40	3	1	4	4
E					
Epichlorohydrin	RT	4	4	4	4
Ethane	RT	1	1	1	4
Ethanol (denatured alcohol)	RT	1	1	4	1
Ethanolamine (monoethanolamine)	RT	2	4	4	2
Ethanolamine (di- and triethanolamine)	50	5	4	4	2
Ethyl acetate	RT	4	4	4	2
Ethyl acrylate	RT	4	4	4	2
Ethyl benzene	RT	4	1	4	4
Ethyl benzoate	RT	4	1	4	4
Ethyl chloride	RT	1	1	4	4
Ethylene	RT	1	1	5	5
Ethylene chloride	RT	4	2	4	4
Ethylene chlorohydrin	RT	4	1	4	3
Ethylene diamine	RT	1	4	4	1
Ethylene glycol	RT	1	1	2	1/2
Ethylene glycol	100	1	1	3	1/2
Ethylene oxide	RT	4	4	4	4
Ethylene trichloride	RT	4	1	4	4
Ethyl ether	RT	3	4	4	4
Ethyl formate	RT	4	1	5	5
Ethyl glycol (Cellosolve)	RT	4	3	4	4
Ethyl glycol acetate (Cellosolve acetate)	RT	4	4	4	4
Ethyl silicate	RT	1	1	5	5
F					
Fatty acids	100	2	1	5	3
Ferric chloride (aq)	RT	1	1	1	2
Ferric nitrate (aq)	RT	1	1	1	3
Ferric sulphate (aq)	RT	1	1	1	2

Chemical resistance

Medium	Temperature °C	Lip material			
		R D H	V	P	S
Fish oil	RT	1	1	5	1
Fluorine (liquified)	RT	4	2	4	4
Fluorobenzene	RT	4	1	4	4
Fluorosilic acid	60	1	1	5	4
Formaldehyde	RT	3	1	4	2
Formaldehyde, 37 %	below 100	2	1	4	2
Formic acid	RT / 60	2	3	5	2
Fuels					
– Aero engine fuels JP:					
– JP3 (MIL-J-5624 G)	RT	1	1	2	4
– JP4 (MIL-J-5624 G)	RT	1	1	2	4
– JP5 (MIL-J-5624 G)	RT	1	1	2	4
– JP6 (MIL-F-25656 B)	RT / 60	1	1	5	4
– ASTM reference fuels:					
– ASTM-A (MIL-S-3136 B Typ 1)	RT / 60	1	1	2	4
– ASTM-B (MIL-S-3136 B Typ 111)	RT / 60	1	1	5	4
– ASTM-C	RT / 60	2	1	4	4
– Diesel fuel	60	1	1	2	2
– Fuel oil	60	1	1	1	4
– Gasohol (10 % ethanol or methanol)	RT	2	3	4	4
– Kerosene	RT	1	1	1	4
– Mineral oil	100	1	1	1	2
– Petrol	RT	1	1	4	4
Fumaric acid	RT	1	1	4	2
Furan	RT	4	5	4	5
Furfural	RT	4	4	4	4
Furfuran	RT	4	5	4	5
G					
Gelatine (aq)	40	1	1	4	1
Glucose	RT	1	1	5	1
Glue	RT	1	1	5	1
Glycerin	100	1	1	3	1
Glycols	100	1	1	4	1/2
H					
n-Hexaldehyde	RT	4	4	5	2
Hexane	RT / 60	1	1	1	4
1-Hexene	RT	2	1	1	4
Hexyl alcohol	RT	1	1	4	2
Hydraulic fluids					
– Hydraulic oils (acc. to DIN 51524)	80	1	1	1	3
– Hydraulic fluids (acc to DIN 51502):					
– HFA (oil in water emulsion)	55	1	1	5	5
– HFB (water in oil emulsion)	60	1	1	5	5

Chemical resistance

Medium	Temperature °C	Lip material			
		R D H	V	P	S
– HFC (aqueous Polymer solutions)	60	1	1	5	1
– HFD (phosphoric esters)	80	4	2/4	4	4
– Skydrol 500	80	4	4	4	3
– Skydrol 7000	80	4	2	4	3
Hydrazine	RT	2	4	5	3
Hydrobromic acid	RT / 60	4	1	4	4
Hydrochloric acid (conc.)	RT	3	1	4	3
Hydrochloric acid (conc.)	80	4	2	4	4
Hydrocyanic acid (Prussic acid)	RT	2	1	4	3
Hydrofluoric acid (conc.)	RT	4	1	4	4
Hydrofluoric acid (conc.)	100	4	3	4	4
Hydrofluoric acid (anhydrous)	100	4	4	4	4
Hydrogen gas	RT	1	1	2	3
Hydrogen peroxide (90 %)	RT	4	2	4	2
Hydrogen sulphide (wet)	RT / 100	4	4	4	3
Hydroquinone	RT	4	2	4	5
Hypochlorous acid	RT	4	1	4	5
I					
Iodine pentafluoride	RT	4	4	4	4
Isobutyl alcohol	RT	2	1	4	1
Isooctane	RT	1	1	1	4
Isophorone	RT	4	4	4	4
Isopropyl acetate	RT / 80	4	4	4	4
Isopropyl alcohol	RT / 60	2	1	4	1
Isopropyl chloride	RT	4	1	4	4
Isopropyl ether	RT/60	2	4	3	4
L					
Lactic acid	RT	1	1	4	1
Lactic acid	100	4	1	4	2
Lard	80	1	1	1	2
Lavender oil	RT	2	1	2	4
Lead acetate (aq)	RT / 60	2	2	4	4
Lead nitrate (aq)	RT	1	5	5	2
Linoleic acid	RT	2	2	5	2
Linseed oil	RT / 60	1	1	1	1
Lubricants					
– ASTM oil No. 1	100	1	1	1	3
– ASTM oil No. 2	100	1	1	1	3
– ASTM oil No. 3	100	1	1	1	3
– ATF oils, type A	100	1	1	1	4
– ATF oils, type I	100	1	1	1	4
– ATF oils, type II	100	1	1	1	4
– ATF oils, type F	100	1	1	1	4
– ATF oils, type Mercon	100	1	1	1	4

Chemical resistance

Medium	Temperature °C	Lip material			
		R D H	V	P	S
– EP lubes	100	2	1	1	4
– Fluorolube	100	1	2	5	1
– Grease MIL-G-7118 A	80	1	1	3	3
– Grease MIL-G-7711 A	80	1	1	1	3
– Lubricating oils (petroleum)	100	1	1	1	4
– Red oil (MIL-H-5606)	100	1	1	1	4
– RJ-1 (MIL-F-25558 B)	100	1	1	1	4
– RP-1 (MIL-F-25576 C)	100	1	1	1	4
– Motor oil SAE 30	100	1	1	1	1
– Transmission oil SAE 90	100	1	1	1	4
– Transmission oil MIL-L-23699 A	100	1	1	3	3
– Silicone greases	120	1	1	1	3
– Silicone oils	120	1	1	1	3
– Transformer oil (Pyranol)	60	4	1	5	4
– Transformer oil	60	1	1	2	2
– Transmission fluid type A	RT	1	1	1	2
– Turbine oil	100	2	1	1	4
M					
Magnesium chloride (aq)	100	1	1	5	1
Magnesium hydroxide (aq)	100	2	1	4	5
Magnesium sulphate (aq)	100	1	1	4	1
Maleic acid	100	4	1	4	5
Maleic anhydride	60	4	4	4	5
Malic acid	RT	1	1	4	2
Mercury	RT / 60	1	1	5	5
Mercury chloride (aq)	RT / 60	1	1	5	5
Mesityl oxide	RT	4	4	4	4
Methane	RT	1	2	1	4
Methanol (methyl alcohol)	60	1	4	4	1
Methyl acetate	RT	4	4	4	4
Methyl acrylate	RT	4	4	4	4
Methyl aniline	RT	4	2	4	5
Methyl bromide	RT	2	1	3	5
Methyl cellosolve (methyl glycol)	RT	3	4	4	4
Methyl chloride	RT	4	2	4	4
Methyl cyclopentane	RT	4	2	4	4
Methylene chloride	RT	4	2	4	4
Methyl ethyl ketone	RT	4	4	4	4
Methyl formate	RT	4	5	5	5
Methyl glycol (Cellosolve)	RT	3	4	4	4
Methyl isobutyl ketone	RT	4	4	4	4
Methyl methacrylate	RT	4	4	4	4
Methyl salicylate	RT	4	5	5	5
Milk	RT	1	1	4	1
Mustard gas	RT	5	5	5	1

Chemical resistance

Medium	Temperature °C	Lip material			
		R D H	V	P	S
N					
Naphtha	RT	2	1	2	4
Naphthalene	60	4	1	5	4
Naphthalenic acid	RT	2	1	5	4
Natural gas	RT	1	1	2	1
Neat-s-foot oil	RT / 60	1	1	1	2
Nickel acetate (aq)	RT	2	4	4	4
Nickel chloride	RT	1	1	4	1
Nickel sulphate (aq)	RT / 60	1	1	4	1
Nitric acid (conc.)	RT	4	3	4	4
Nitric acid (fuming)	RT	4	4	4	4
Nitric acid (dilute)	RT	4	1	4	2
Nitrobenzene	50	4	2	4	4
Nitroethane	RT	4	4	4	4
Nitrogen	20	1	1	1	1
Nitrogen tetroxide	RT	4	4	4	4
Nitromethane	RT	4	4	4	4
O					
Octadecane	RT / 50	1	1	2	4
n-Octane	RT	2	1	4	4
Octyl alcohol	RT	2	1	4	2
Oleic acid	70	1	2	2	4
Olive oil	60	1	1	1	3
Oxalic acid	70	2	1	5	4
Oxygen	RT	2	1	2	1
Oxygen	above 100	4	2	4	2
Ozone	RT	4	1	2	1
P					
Palmitic acid	60	1	1	4	4
Peanut oil	RT / 50	1	1	1	1
Perchloric acid	RT	4	1	4	4
Perchloroethylene	RT / 60	2	1	4	4
Petroleum	below 120	1	1	2	2
Petroleum	above 120	4	2	4	4
Petroleum ether	RT / 60	1	1	1	4
Petroleum gas (liquified)	RT	1	1	3	3
Phenol	60 / 100	4	1	4	4
Phenyl ethyl ether	RT	4	4	4	4
Phenyl hydrazine	RT / 60	4	1	4	5
Phoron (diisopropylidene acetone)	60	4	4	4	4
Phosphoric acid, 20 %	50 / 60	2	1	5	2
Phosphoric acid, 45 %	50 / 60	4	1	5	3
Phosphorus trichloride	RT	4	1	5	5
Pickling solution	RT	4	2	4	4

Chemical resistance

Medium	Temperature °C	Lip material			
		R D H	V	P	S
Picric acid	RT	4	1	5	4
Pinene	RT	2	1	4	4
Pine oil	RT	4	1	5	4
Piperidine	RT	4	4	4	4
Potassium acetate (aq)	RT	2	4	4	4
Potassium chloride (aq)	RT / 60	1	1	1	1
Potassium cyanide (aq)	RT / 50	1	1	1	1
Potassium dichromate (aq)	RT	1	1	1	1
Potassium hydroxide (aq)	60	2	4	4	4
Potassium nitrate (aq)	RT / 60	1	1	1	1
Potassium sulfate (aq)	RT / 60	1	1	4	1
Propane	RT	1	1	1	4
Propyl acetate	RT	4	4	4	4
Propyl alcohol	RT / 60	1	1	4	1
Propylene	RT	4	1	4	4
Propylene oxide	RT	4	4	4	4
Prussic acid (hydrocyanic acid)	RT	2	1	4	3
Pyridine	RT	4	4	4	4
Pyroligneous acid	RT	4	4	4	5
Pyrrole	RT	4	4	4	2
R					
Rapeseed oil	RT	2	1	2	4
Refrigerants (acc. to DIN 8962)					
– R 11	RT	2	1	5	4
– R 12	RT	1	2	1	4
– R 13	RT	1	1	5	4
– R 13 B1	RT	1	1	5	4
– R 14	RT	1	1	5	4
– R 21	RT	4	4	5	4
– R 22	RT	4	4	2	4
– R 31	RT	4	4	5	5
– R 32	RT	1	4	5	5
– R 112	RT	3	1	5	4
– R 113	RT	1	2	5	4
– R 114	RT	1	2	5	4
– R 114 B2	RT	2	2	5	4
– R 115	RT	1	2	5	5
– R C 318	RT	1	2	5	5
S					
Salicylic acid	RT	2	1	5	5
Sea water	RT	1	1	4	1
Silver nitrate (aq)	RT	2	1	1	1
Soap solution	RT	1	1	4	1
Sodium acetate (aq)	RT	2	4	4	4

Chemical resistance

Medium	Temperature °C	Lip material			
		R D H	V	P	S
Sodium bicarbonate (aq)	60	1	1	5	1
Sodium bisulphite (aq)	100	1	1	4	1
Sodium carbonate (soda)	RT / 60	1	1	5	1
Sodium chloride (aq)	RT / 100	1	1	5	1
Sodium cyanide (aq)	RT	1	1	5	1
Sodium hydroxide (aq)	RT	2	2	3	2
Sodium hypochlorite (aq)	RT / 50	2	1	4	5
Sodium metaphosphate	RT / 60	1	1	5	2
Sodium nitrate (aq)	RT / 60	2	5	5	4
Sodium phosphate (aq)	RT / 60	1	1	4	4
Sodium silicate (aq)	RT / 60	1	1	5	5
Sodium sulphate (aq) (Glauber's salt)	RT / 60	1	1	4	1
Sodium thiosulphate (aq)	RT / 50	2	1	4	1
Soyabean oil	RT	1	1	1	1
Stannic chloride (aq)	RT / 80	1	1	5	2
Stannous chloride (aq)	RT / 80	1	1	5	2
Steam	below 150	4	4	4	3
Steam	above 150	4	4	4	4
Stearic acid	60	2	2	4	2
Stoddard solvent	RT	1	1	1	4
Styrene	RT	4	2	4	4
Sucrose solution	RT / 60	1	1	4	1
Sulphur	RT / 60	4	1	4	3
Sulphur chloride (aq)	RT	3	1	4	3
Sulphur dioxide (dry)	RT / 60	4	1	4	2
Sulphur dioxide (liquified)	RT / 60	4	1	4	2
Sulphur dioxide (wet)	RT / 60	4	1	4	2
Sulphur hexafluoride	RT	2	1	4	2
Sulphuric acid (conc.)	RT / 50	4	1	4	4
Sulphuric acid (20 %) (battery acid)	60	4	1	4	4
Sulphuric acid (dilute)	RT	3	1	2	4
Sulphurous acid	RT / 60	4	1	4	4
Sulphur trioxide	RT	4	1	4	2
T					
Tannic acid	RT / 60	1	1	4	2
Tar, bituminous	RT	2	1	4	2
Tartaric acid	60	1	1	5	1
Tepineol	RT	2	1	5	5
Tetrabromoethane	RT	4	1	4	4
Tetrabromomethane	RT	4	1	5	4
Tetrabutyl titanate	RT	2	1	5	5
Tetrachloroethylene	60	4	2	4	4
Tetraethyl lead	RT	2	1	5	5
Tetrahydrofuran	RT	4	4	4	4
Tetrahydronaphthalene (Tetralin)	RT	4	1	5	4

Chemical resistance

Medium	Temperature °C	Lip material			
		R D H	V	P	S
Thionyl chloride	RT	4	2	4	5
Titanium tetrachloride	RT	2	1	4	4
Toluene	RT	4	1	4	4
Toluene diisocyanate	RT	4	4	4	4
Triacetin	RT	2	1	4	5
Tributoxy ethyl phosphate	RT	4	1	4	5
Tributyl phosphate	RT / 60	4	4	4	4
Trichloroacetic acid	60	5	4	4	4
Trichloroethane	RT	4	1	4	4
Trichloroethylene	RT	4	1	4	4
Tricresyl phosphate	RT / 60	4	1	4	3
Triethanol amine	RT	2	4	4	5
Triethyl aluminium	RT	4	2	4	5
Triethyl borane	RT	4	1	4	5
Trinitrotoluene	RT	4	2	4	5
Trioctyl phosphate	RT/60	4	2	4	3
Tung oil (China wood oil)	RT	1	1	1	4
Turpentine	RT	1	1	2	4
V					
Varnish	RT	2	1	4	4
Vegetable oil	60	1	1	1	2
Vinyl acetylene	RT	1	1	5	2
Vinyl chloride	RT	4	1	5	5
W					
Water	100	1	1	4	1
Whisky	RT	1	1	4	1
White oil	RT / 80	1	1	1	4
Wine	RT	1	1	4	1
Wood oil	RT	1	1	1	4
X					
Xylene	RT	4	1	4	4
Xylidine (di-methyl aniline)	RT	3	4	4	4
Z					
Zeolites	RT	1	1	5	5
Zinc acetate (aq)	RT	1	1	4	4
Zinc chloride (aq)	RT	1	1	4	1
Zinc sulphate (aq)	RT	1	1	4	1

Storage and handling of seals

General

The following guidelines for the storage and cleaning of seals are valid for natural and/or synthetic rubber elastomer materials and correspond to those standardised in ISO 2230 – 1973 and DIN 7716. DIN 9088 – Aerospace: guidelines for the permissible storage times of elastomer products – should also be observed.

The following stipulations to DIN 7716 in respect of storage facilities and actual storage are valid for long-term storage. For shorter periods (up to 6 months), e.g. in production or delivery stores with a continuous flow of materials, these recommendations can be applied, except for those relating to the storage facilities and temperature; there should, however, be no detrimental change to the appearance or function of the products.

Under unfavourable storage conditions or through improper handling most products of natural or synthetic rubber will change their physical properties. This can lead to a shortening of life, or the products may be rendered unusable, for example, as a result of hardening or softening, permanent deformation, peeling, cracks or other surface damage. These changes can be brought about by the influence of oxygen, ozone, heat, light, moisture, solvents etc. or by storing the products under stress or load. Properly stored elastomer products, on the other hand, generally retain their properties virtually unchanged for several years.

Store

The actual store should be cool, dry, moderately ventilated and there should be little dust. Outdoor storage without protection is not permitted.

The appropriate storage temperature depends on the elastomer concerned. The most favourable storage temperature for synthetic rubber seals is in the range +15 to +25 °C. Higher temperatures must be avoided as well as lower temperatures.

Elastomer products which have been subjected to low temperatures during transport or storage may have become stiff. They should, therefore, be allowed to warm up and be kept at a temperature of at least +20 °C before being used. Preferably, this should be done before they are unpacked to avoid condensation on the products themselves.

In heated storage rooms the products should be shielded from the heat source. There should be at least 1 m between the packages and the source of heat. Where a heater with fan is used, the distance should be greater. Storage in damp rooms should be avoided because of the risk of condensation. A relative humidity of under 65 % is best.

The seals should be protected from light, particularly from direct sunlight or artificial light with a high proportion of UV radiation. Any windows in the store should, therefore, be covered with a red or orange coating (never blue). Ordinary light bulbs are to be preferred for illumination.

The seals should be wrapped or stored in airtight containers or otherwise be protected against atmospheric changes and particularly against draught. This is especially important for products which have a surface that is large in relation to the volume.

As ozone is particularly damaging, steps should be taken to see that no ozone is produced in the store e.g. as a result of using electric motors or other equipment which can produce sparks or other electric discharges. Combustion fumes and vapours which can produce ozone as a result of photochemical processes should be exhausted. For this reason solvents, fuels, lubricants, chemicals, acids, disinfectants etc. should not be stored in the same room as the seals.

It should be observed that elastomer products should not be subjected to tension, compression or other forms of loading in storage, as these can produce permanent deformations and cracks. Seals should therefore not be hung on hooks during storage. Certain metals, especially copper and manganese, damage elastomer products. Contact with these metals should thus be avoided and the seals should be covered with layers of paper or polyethylene to prevent such contact.

In case it is necessary to repack the seals, packaging and covering materials should not contain substances which are damaging the seals, e.g. copper or alloys containing copper, petroleum, oil etc. The packaging materials should not contain softeners.

If the products are powdered, then the powder must not contain damaging substances. Suitable powders are talcum, chalk, finely divided glimmer and rice starch.

Seals which are made of different materials should not be in contact with each other. This is particularly important where the seals have different colours.

Seals should be stored for as short a period as possible. Where long-term storage is involved, care should be taken to see that newly arrived products are kept separate from those already in storage.

Cleaning and maintenance

Elastomer products should be cleaned, if necessary, using warm soapy water (not above 30 °C) and allowed to dry off at room temperature.

Solvents such as trichloroethylene, carbon tetrachloride or hydrocarbons should not be used, nor should sharp-edged objects, wire brushes, emery cloth or sandpaper.

Elastomer/metal combinations can be cleaned using a 1:10 mixture of glycerine in alcohol.

Questionnaire form

From			
Company:			
Address:			
Name:		Department:	
Telephone:		Telefax:	
Date:			
To			
1. Application			
Where is the seal to be used (machine, equipment etc.)			
<input type="checkbox"/> New design		<input type="checkbox"/> Design modification	
<input type="checkbox"/> Drawing/sketch enclosed			
2. Lubricant			
2.1 Type:		Designation	
2.2 Normal lubricant temperature:	°C	min: °C	max: °C
2.3 Temperature cycle:			
2.4 Lubricant volume (oil level):			
2.5 Internal pressure:		MPa	
2.6 Pressure cycle:			
3. Deviations of position and form			
3.1 Deviation of coaxiality of shaft/housing bore:			
3.2 Shaft runout:			
4. External conditions			
4.1 External pressure:		MPa	
4.2 Ambient temperature:	°C	min: °C	max: °C
4.3 Medium to be excluded (e.g. dust, mud, water etc.):			

5. Shaft						
5.1	Diameter (d_1):	min:	mm	max:	mm	
5.2	Material:					
5.3	Type of surface:	Hardness:				
5.4	Surface roughness:	R_a	μm	R_z	μm	R_{max} μm
5.5	Chamfer/transition:					
5.6	Shaft rotation (where applicable):	Speed:	r/min	min:	r/min	max:
	Direction of rotation:	<input type="checkbox"/> clockwise <input type="checkbox"/> anti-clockwise <input type="checkbox"/> alternating				
	Oscillation:	Angle of oscillation	degrees	Frequency	r/min	
6. Housing						
6.1	Bore diameter (d_2):	min:	mm	max:	mm	
6.2	Depth of bore (width):	min:	mm	max:	mm	
6.3	Material:					
6.4	Surface roughness:	R_a	μm	R_z	μm	R_{max} μm
6.5	Chamfer/transition:					
6.6	Housing rotation (where applicable):	Speed:	r/min	min:	r/min	max:
	Direction of rotation:	<input type="checkbox"/> clockwise <input type="checkbox"/> anti-clockwise <input type="checkbox"/> alternating				
	Oscillation:	Angle of oscillation	degrees	Frequency	r/min	
7. Seal						
7.1	Design/type:					
7.2	Material:	Shell/outside diameter:		Seal lip:		
7.3	Additional requirements:	<input type="checkbox"/> Bore-Tite		<input type="checkbox"/> Shaft wear sleeve		
8. Quantity						
8.1	Once only:	<input type="checkbox"/> Number of seals:				
8.2	Continuous:	<input type="checkbox"/> Number of seals per annum:				
8.3	Supply date:					
8.4	Other information:	_____ _____ _____ _____				

Radial shaft seals

- Small diameter seals (SDS)
- Large diameter seals (LDS)

Contents

52 General

- 54 Terminology
- 55 International standards
- 56 Outside diameter design
- 57 Garter springs
- 57 Bore-Tite coating
- 57 Dimensions
- 57 Tolerances
- 59 Sealing lips design
- 60 Secondary (dust) lips
- 61 Coaxiality
- 63 Runout
- 65 Axial movement
- 65 Permissible speed
- 67 Lubrication
- 68 Friction
- 69 Chemical and thermal resistance
- 71 Seals under pressure

72 Shaft requirements, small diameter seals (SDS)

- 72 General
- 72 Tolerances
- 72 Surface roughness
- 73 Surface finish
- 74 Hardness and surface treatment
- 74 Lead-in chamfers

76 Shaft requirements, large diameter seals (LDS)

- 76 General
- 76 Tolerances
- 77 Surface roughness
- 77 Surface finish
- 78 Hardness and surface treatment
- 79 Lead-in chamfers

80 Housing bore requirements, small diameter seals (SDS)

- 80 General
- 80 Tolerances
- 80 Surface finish
- 80 Housing bores for seals with steel shells

82 Housing bore requirements, large diameter seals (LDS)

- 82 General
- 82 Housing bores for seals with steel shells
- 82 Housing bores and end covers for HS and HSF seals of elastomers
- 84 Tolerances
- 84 Surface finish

85 Mounting, small diameter seals

- 85 General

87 Mounting, large diameter seals

- 87 General
- 88 Different ways of mounting HS seals
- 88 Multiple seal installation
- 89 Mounting split HS seals
- 91 Paired mounting
- 93 Cover plates
- 94 Protecting the counter surface
- 94 Removal

95 Replacement

96 Designation system

- 96 Metric radial shaft seals
- 96 Inch-size radial shaft seals

98 Seal selection chart – Radial shaft seals, small diameter seal range (SDS)

100 Seal selection chart – Radial shaft seals, large diameter seal range (LDS)

104 Product descriptions and size listings**Small diameter seals range**

- 104 Series HMS5 and HMSA10
- 106 Size listing, HMS5 and HMSA10
- 114 Series CRW1
- 115 Size listing, CRW1, metric sizes
- 130 Size listing, CRW1, inch sizes
- 173 Series CRW5
- 174 Size listing, CRW5
- 176 Series HMS4 and HMSA7
- 177 Size listing, HMS4 and HMSA7, metric sizes
- 178 Size listing, HMS4 and HMSA7, inch sizes
- 184 Series CRS
- 185 Size listing, CRS, metric sizes
- 189 Size listing, CRS, inch sizes

194 Radial shaft seals of PTFE

- 194 Series RD
- 194 Series RDD
- 195 Materials
- 196 Size listing, RD and RDD

198 Product descriptions**Large diameter seals range**

- 198 General
- 198 Special design features for large diameter seals
- 198 Spacer lugs
- 199 Spring-Lock
- 199 Spring-Kover
- 199 Bore-Tite
- 200 Metal clad seals
- 200 Type HDS7
- 201 HDL Seals
- 201 Series HDS
- 204 Rubber covered seals
- 205 Series SBF
- 205 Series HDS4 and HDS6
- 206 Series HSF
- 207 Series HS, solid seal types
- 208 Series HS, split seal types
- 209 Spring connections for split seal types
- 210 HS seals selection chart

211 Size listing, large diameter seal series

- 211 Size options
- 214 Size listing, HDL, metric sizes
- 216 Size listing, HDL, inch sizes
- 244 Size listing, SBF, metric sizes
- 245 Size listing, SBF, inch sizes
- 246 Size listing, HSF1, HSF5, metric sizes
- 260 Size listing, HSF1, HSF5, inch sizes
- 265 Size listing, HSF2, HSF6, metric sizes
- 266 Size listing, HSF2, HSF6, inch sizes
- 267 Size listing, HSF3, HSF7, metric sizes
- 273 Size listing, HSF3, HSF7, inch sizes
- 274 Size listing, HSF4, HSF8, metric sizes
- 275 Size listing, HSF4, HSF8, inch sizes
- 276 Size listing, HSF9, metric sizes
- 277 Size listing, HSF9, inch sizes

Radial shaft seals

General

Radial shaft seals are used between rotating and non-rotating machine components (**fig 35**).

They are made up of

- a cylindrical outer covering of sheet steel (shell) or elastomer which seals statically against the housing bore and enables the requisite interference fit of the seal in the housing bore to be obtained as well as facilitating proper installation,
- the sealing lip of elastomer which provides dynamic and static sealing against the shaft. The lip has a sealing edge, which is formed by pressing, cutting or grinding and is normally pressed against the counter-surface on the shaft with a defined radial force by a garter spring. The edge of the sealing lip and the shaft counter surface form the most important functional area of a radial shaft seal. The sealing effect of the lip can be enhanced by providing the contact area of the lip with hydrodynamic aids which may be designed for single direction operation, or for alternating directions of shaft rotation.

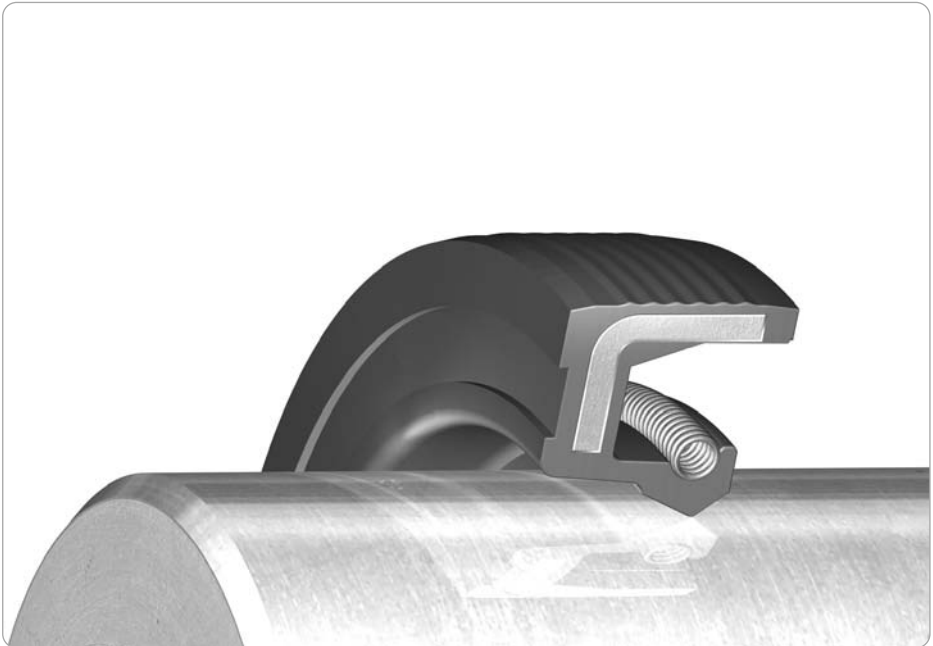

Fig 35

An additional sealing lip may also be provided to protect the sealing contact proper from dust and other fine solid contaminants. A suitable lubricant in the space between the primary sealing lip and the secondary lip can reduce wear and delay corrosion. Where hydrodynamic aids have been provided it should be remembered that a pressure deficit can be produced in the space between primary and secondary lips which will increase the radial force. This situation can be avoided by providing breathing holes in the secondary lip. It should also be remembered that contaminants which have penetrated past the secondary lip will eventually cause damage in the counter surface region.

A build-up of heat can also occur between the two lips which promotes premature wear. Radial shaft seals are used throughout industry in a multitude of applications. Because of the importance of radial shaft seals for the operational reliability and service life of machines and equipment, both seal manufacturers and users are equally interested in some degree of standardization. This has led to the establishment of the national and international standards and recommendations listed in (Table 2, page 55). These cover boundary dimensions, tolerances, material specifications and test methods and the terminology shown in (fig 37) and (fig 38) as well as the six most common radial shaft seal forms as shown in (fig 36).

It should be noted that the terminology found in SKF publications and used here differs in some instances from the ISO standard. The terms used by SKF and in this catalogue which differ from ISO are given in bold type after the relevant ISO term in fig 36 and 37.

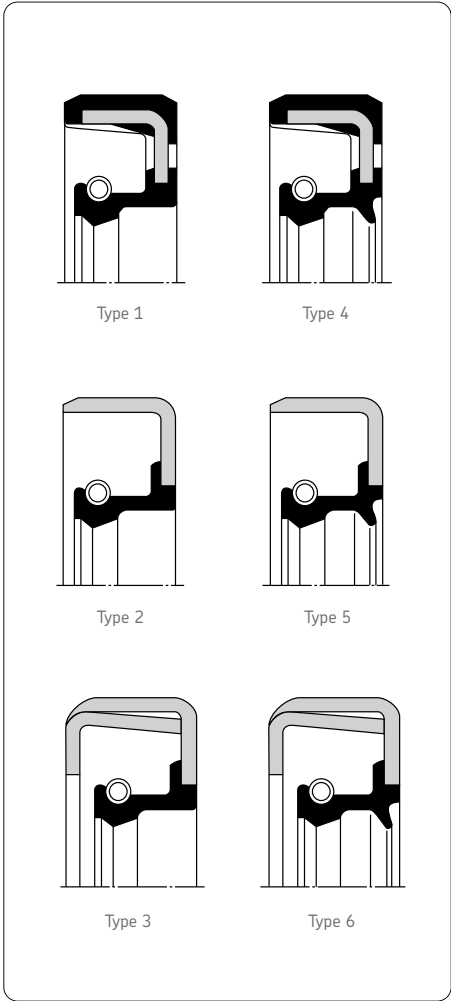

Fig 36

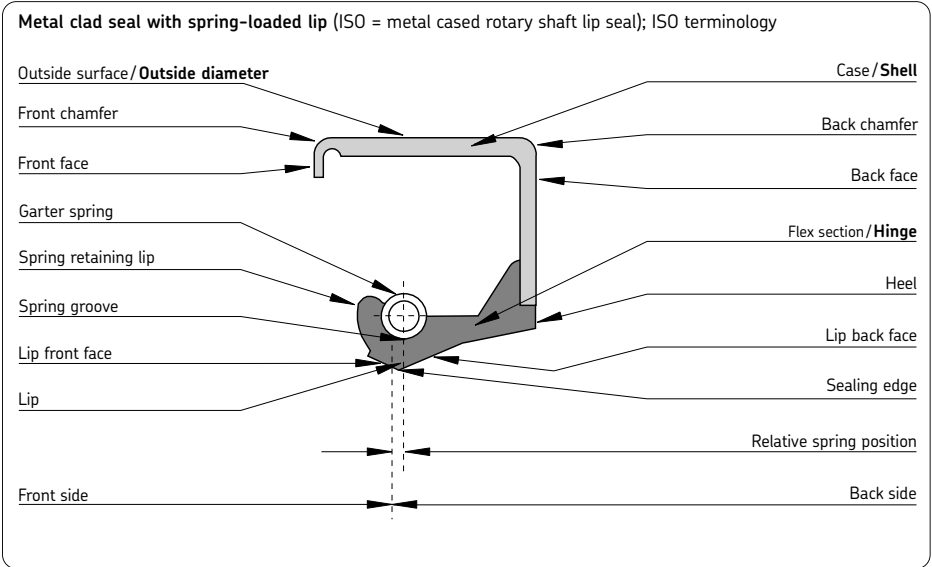

Fig 37

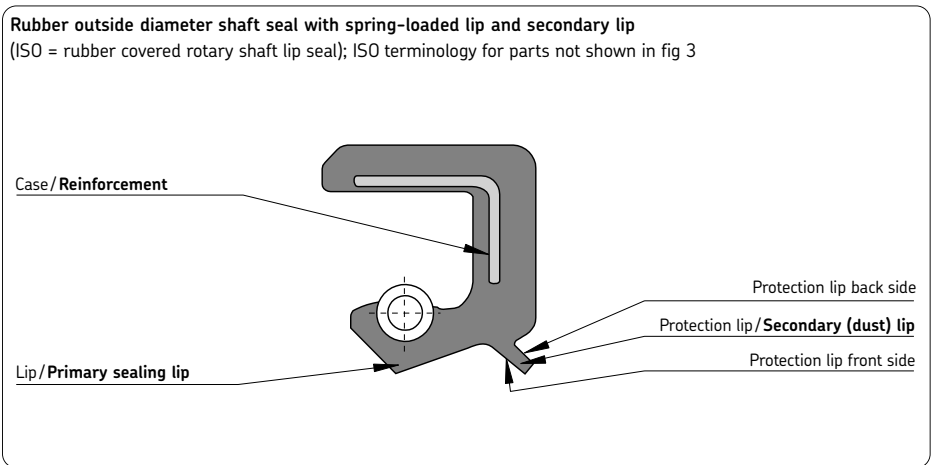

Fig 38

Table 2. Standards and other documents relating to radial shaft seals

Document ¹⁾	Title
ISO 6194/1-1982	Rotary shaft lip type seals – Nominal dimensions and tolerances
ISO 6194/2-1991	Rotary shaft lip type seals – Vocabulary
ISO 6194/21-1988	Rotary shaft lip type seals – Storage, handling and installation
ISO 6194/4-1988	Rotary shaft lip type seals – Performance test procedures
ISO 6194/5-1990	Rotary shaft lip type seals – Identification of visual imperfections
SAE J946-1980	Application guide to radial lip seals
RMA OS-4,1984	Application guide for radial lip type shaft seals
RMA OS-7,1982	Storage and handling guide for radial lip type shaft seals
RMA OS-8,1977	Visual variations guide for rotating shaft seals
DIN 3760	Radial-Wellendichtringe (Radial shaft seals)
DIN 3761	Radial-Wellendichtringe für Kraftfahrzeuge (Radial shaft seals for motor vehicles), Parts 1 to 15. This standard covers all aspects including vocabulary, material requirements and test methods.

¹⁾ RMA = Rubber Manufacturers Association

SAE = Society of Automotive Engineers

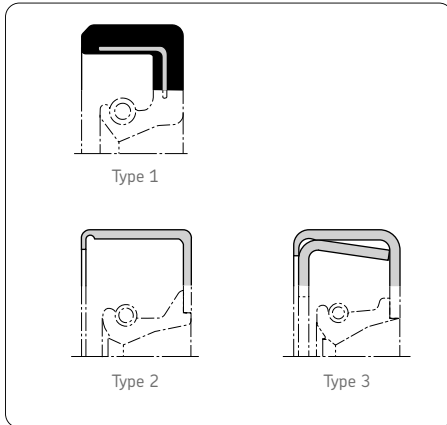

Fig 39

SKF radial shaft seals are produced in different designs, variants and sizes. The designs differ in the form and execution of the outside diameter and the sealing lip.

Outside diameter design

The standard range of small radial shaft seals produced by SKF covers five different outside diameter executions. These are Types 1, 2 and 3 to ISO 6194/1 (Forms A, B and C to DIN 3760 and DIN 3761, Part 2) (**fig 39**).

Radial shaft seals with an elastomeric outside diameter, Type 1 and Type 4 (Forms A and AS) have a particularly wide range of application. They allow a tight fit in the housing bore when the housing material has a higher coefficient of thermal expansion than steel and/or when the housing is split. They are also recommended in all cases where the requisite tolerances for the housing bore, e.g. for the surface roughness, cannot be achieved.

Radial shaft seals with metallic outside diameter (shell), Type 2 (Form B), are multipurpose seals which can be used for most applications. They are relatively easy to install and, provided housing bore meets the accuracy requirements, they will fit tightly and centrically in the bore.

The radial shaft seals with metallic shell and secondary reinforcement in the side face, Type 3 (Form C), offer advantages where operating conditions are difficult and/or rough. They have higher radial stiffness than Type 2 and are available for shaft diameters of approximately 50 mm and above.

As the static sealing effect between the metallic shell and the housing bore is somewhat limited, particularly against thin fluids and media which can “creep”, most SKF seals with metallic shell are coated with “Bore-Tite”, a water-based paint-like sealant, see **page 26**.

Besides the three standardized designs already described, SKF also produces large seals, where the outside diameter is specially designed to meet the requirements for large diameter applications. See **page 198**.

Garter springs

SKF radial shaft seals have garter springs made of drawn carbon steel or stainless steel (X 3 CrNiN 17 8; Material No. 1.4319; SAE 30302) spring wire.

The carbon steel springs are standard. In cases where a seal has a non-standard garter spring, this is noted in the product tables.

Bore-Tite coating

Bore-Tite is a water-based polyacrylate material and is used as a coating on the seal steel outside diameter of part of the CR radial shaft seal range. Bore-Tite is green in colour, does not harden and serves to fill slight irregularities in the housing bore. For further details see **page 26**.

Dimensions

SKF radial shaft seals are produced in a very wide range of dimensional variants for shaft sizes in the range 5 to 4.600 mm (1/4 to 180 inch). The range also includes standard sizes according to ISO 6194/1:1982 and DIN 3760:1996 (shaft diameter range 6 to 500 mm incl.)

In the diameter range 1/2 to 6 inch the inch size radial shaft seals conform to recommendations laid down in SAE J946. The dimensions of the larger seals are not covered by any ISO, DIN or SAE standards. However, the dimensions of the large seals shown are generally accepted.

Tolerances

SKF radial shaft seals are manufactured with the outside diameter tolerances given in **Table 3** for metric seals and **Table 4, page 58** for inch-size seals. These correspond, where standardised, to the values given in ISO 6194/1:1982 and DIN 3760:1996 and SAE J946.

The width tolerances correspond to ISO 6194/1:1982 and SAE J946.

Metric sizes:

Seal width	Tolerance
$b \leq 10 \text{ mm}$	$\pm 0,3 \text{ mm}$
$b > 10 \text{ mm}$	$\pm 0,4 \text{ mm}$

Inch sizes:

Seal width	Tolerance
$b \leq 0,400 \text{ inch}$	$\pm 0,015 \text{ inch}$
$b > 0,400 \text{ inch}$	$\pm 0,020 \text{ inch}$

Symbols:

d_2	nominal outside diameter
Δd_{2m}	mean outside diameter deviation: arithmetical difference between the mean outside diameter and the nominal
Vd_{2s}	outside diameter variation (roundness tolerance): arithmetical difference between the largest and smallest single outside diameters measured at three or more points equally spaced around the circumference

Table 3. Outside diameter tolerances for metric seals

Outside diameter		Seals with outside diameter of steel elastomer					
d ₂ over	incl.	Δ _{d2m} high	low	V _{d2s} max	Δ _{d2m} high	low	V _{d2s} max
mm		mm			mm		
	50	+0,20	+0,08	0,18	+0,30	+0,15	0,25
50	80	+0,23	+0,09	0,25	+0,35	+0,20	0,35
80	120	+0,25	+0,10	0,30	+0,35	+0,20	0,50
120	180	+0,28	+0,12	0,40	+0,45	+0,25	0,65
180	300	+0,35	+0,15	0,0025 d ₂	+0,45	+0,25	0,80
300	500	+0,45	+0,20	0,0025 d ₂	+0,55	+0,30	1
500	630	+0,50	+0,22	0,0025 d ₂	–	–	–
630	800	+0,50	+0,24	0,0025 d ₂	–	–	–
800	1.000	+0,55	+0,25	0,0025 d ₂	–	–	–
1.000	1.250	+0,60	+0,27	0,0025 d ₂	–	–	–
1.250	1.600	+0,65	+0,30	0,0025 d ₂	–	–	–

Table 4. Outside diameter tolerances for inch size seals

Outside diameter		Seals with outside diameter of steel elastomer					
d ₂ over	incl.	Δ _{d2m} high	low	V _{d2s} max	Δ _{d2m} high	low	V _{d2s} max
in		in			in		
	2	+0,007	+0,003	0,005	+0,011	+0,005	0,010
2	3	+0,008	+0,003	0,006	+0,013	+0,007	0,014
3	5	+0,009	+0,003	0,007	+0,013	+0,007	0,020
5	7	+0,010	+0,004	0,012	+0,016	+0,008	0,025
7	12	+0,012	+0,005	0,015	+0,016	+0,008	0,025
12	20	+0,016	+0,006	0,002 d ₂	–	–	–
20	40	+0,016	+0,006	0 002 d ₂	–	–	–
40	60	+0,018	+0,006	0,002 d ₂	–	–	–

Sealing lip design

The form and design of the sealing lips are based on knowledge gained through research and development activities as well as very wide practical experience obtained by SKF in close cooperation with users. The distance between the lip and the seal back face, the strength of the flex section, the angle of the lip (**fig 37, page 54**) and the tension in the spring are chosen so that the pressure distribution in the sealing lip/counter surface contact required for satisfactory sealing can be established.

The sealing lips of SKF radial shaft seals are produced in several materials and two different designs. The various materials are described on page 27. The two designs differ in the execution of the seal lip edge. The “conventional” sealing lip (**fig 40**), has a straight edge whereas the edge of the SKF Waveseal design (**fig 41**), has a special hydrodynamic form so that the lip describes a sinusoidal path on its counter surface.

The Waveseal design from SKF represents one of the most important developments in radial shaft seals. The sealing lip is pressed and its special form produces a relative movement of the sealing lip on the counterface, imparting hydrodynamic properties. Waveseals are suitable for both directions of rotation; they pump the lubricant back into the bearing arrangement and expel contaminants. The sinusoidal form of the sealing lip considerably extends the path (**fig 41**) on the counter surface and at the same time reduces the specific surface pressure in the sealing lip/counter surface contact.

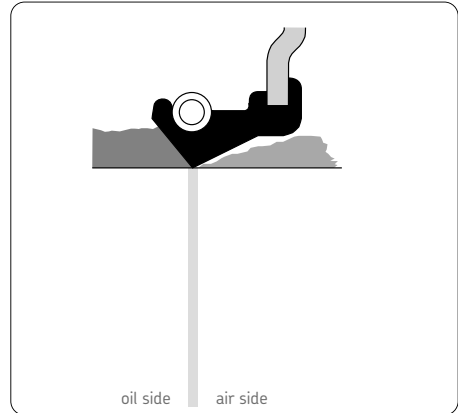

Fig 40. Conventional sealing lip with straight edge

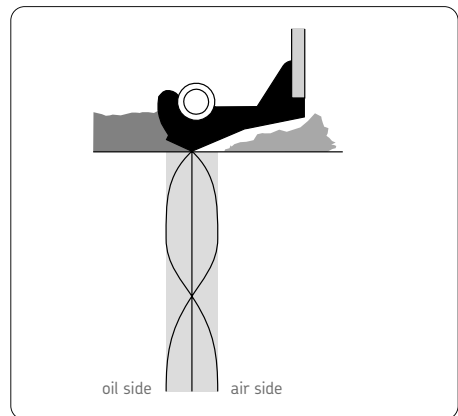
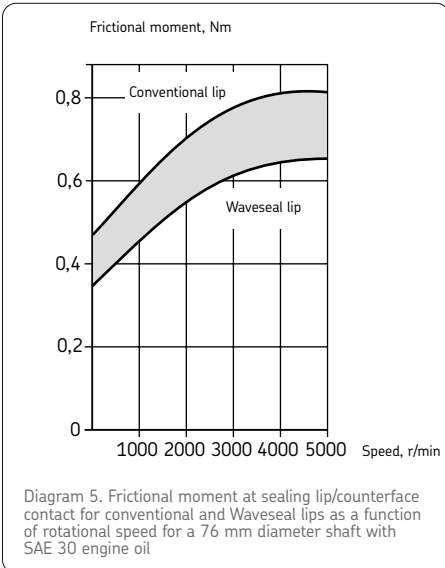
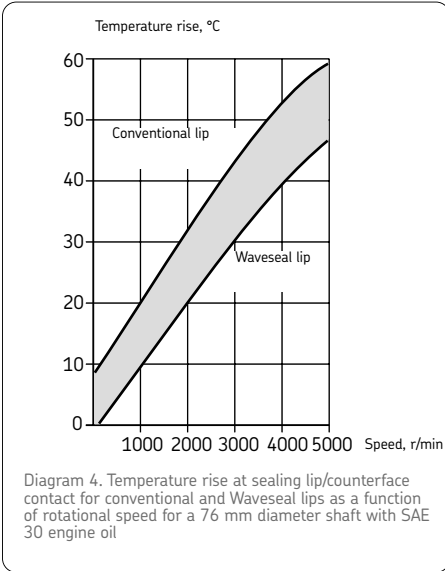

Fig 41. SKF Waveseal lip with sinusoidal edge



As a consequence, Waveseals produce up to 20% less friction and up to 30% lower temperatures than conventional seals; see also **Diagram 4** and **Diagram 5**. These advantages prevent the formation of deep tracks in the counter surface and provide much longer service lives.

Waveseals are available for shaft diameters of 6 to 310 mm. Their use is specially recommended where demands for operational reliability and long service life for machines and equipment are high.

SKF seals with conventional spring-loaded lip meet normal demands and provide efficient sealing even under unfavorable operating conditions.

To strengthen the sealing effect, some SKF radial shaft seals are provided with hydrodynamic aids on the contact surface of the sealing lip. These have either a right-hand twist for a clockwise direction of rotation of the shaft, or a left-hand twist for anti-clockwise shaft rotation, seen from the lip contact. The degree of improvement depends not only on the form of the spiral flutes but also on the circumferential speed, the pressure conditions and the media being sealed.

Secondary (dust) lips

SKF radial shaft seals with conventional and Waveseal lips can also be supplied as standard with an additional lip as shown in **fig 38, page 54**. On Waveseals, the secondary lip forms a narrow gap to the counter surface and there is practically no contact. Because of this, the seals can be operated at the same speeds as single-lip radial shaft seals without causing higher temperatures; they provide enhanced sealing.

Coaxiality and runout

The deviation from coaxiality and the runout of the shaft are two of many operating parameters which affect seal performance and life. They should therefore be kept within narrow limits, particularly at sealing positions where there is a pressure differential across the seal. The total deviation should never exceed 1,3 times the value of the permissible deviation from coaxiality.

Coaxiality

Deviations from coaxiality, i.e. the difference between the center lines of the shaft and housing bore, cause force to be irregularly distributed on the sealing lip (fig 42). This means that one section of the sealing lip will be subjected to more force, causing an enlargement of the contact between lip and counter surface, whereas the opposite section will be correspondingly unloaded and its sealing effect reduced. Guideline values for the permissible coaxiality deviations for SKF seals can be obtained from **Diagram 6, page 62**.

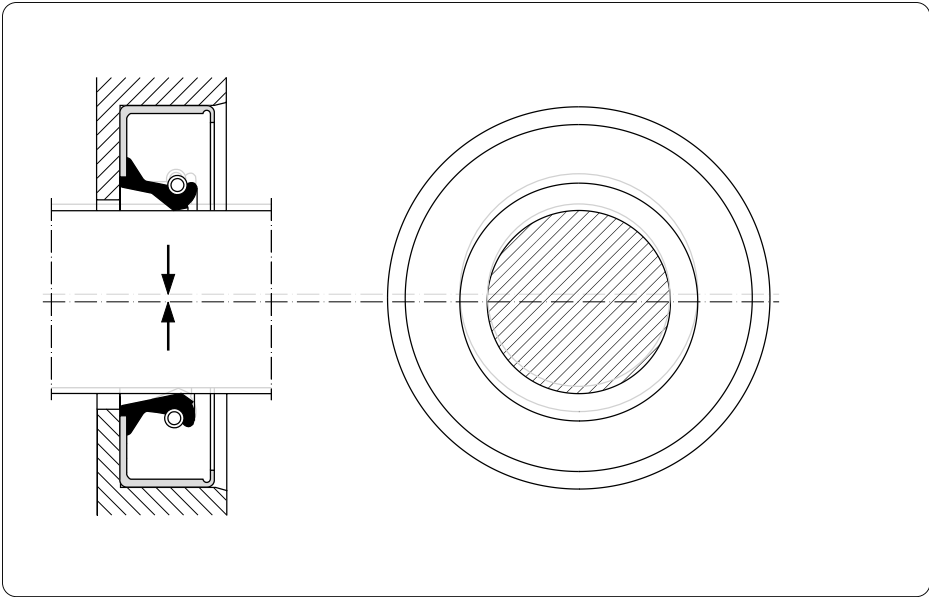

Fig 42. Coaxiality

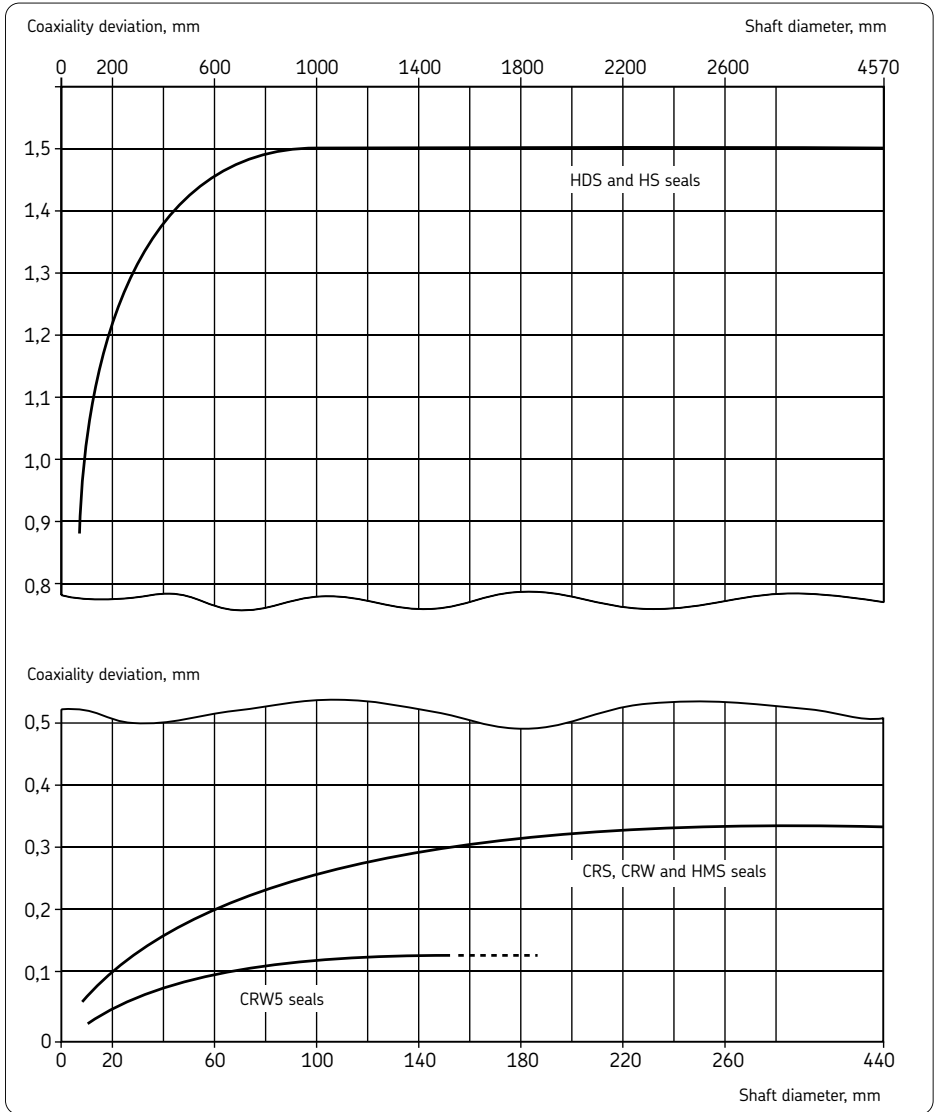

Diagram 6. Maximum permissible deviation from coaxiality as a function of shaft diameter

Runout

Runout describes the dynamic eccentricity of the shaft. Particularly at high speeds, there is a danger that the sealing lip, because of its inertia, will not be able to follow the shaft counter surface (**fig 43**). If the eccentricity is such that the distance between sealing lip and shaft becomes larger than that required to maintain a hydrodynamic lubricant film, the medium being sealed will escape through the gap. It is therefore advisable to arrange the seal in close proximity to the bearing and to keep bearing play at a minimum. Permissible runout values can be obtained from **Diagram 7, page 64**. These values are reduced for narrow seals but may be increased by choosing suitable elastomers and appropriate design measures.

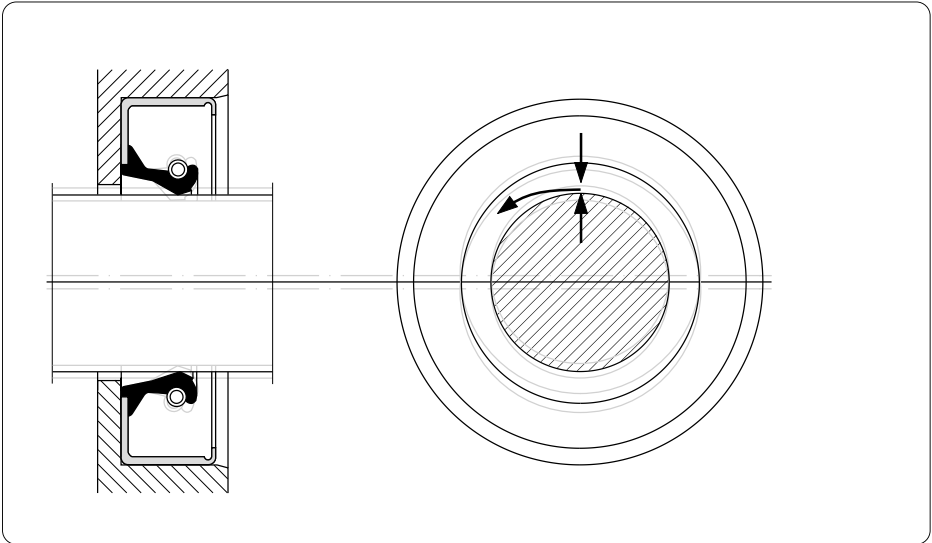

Fig 43. Runout

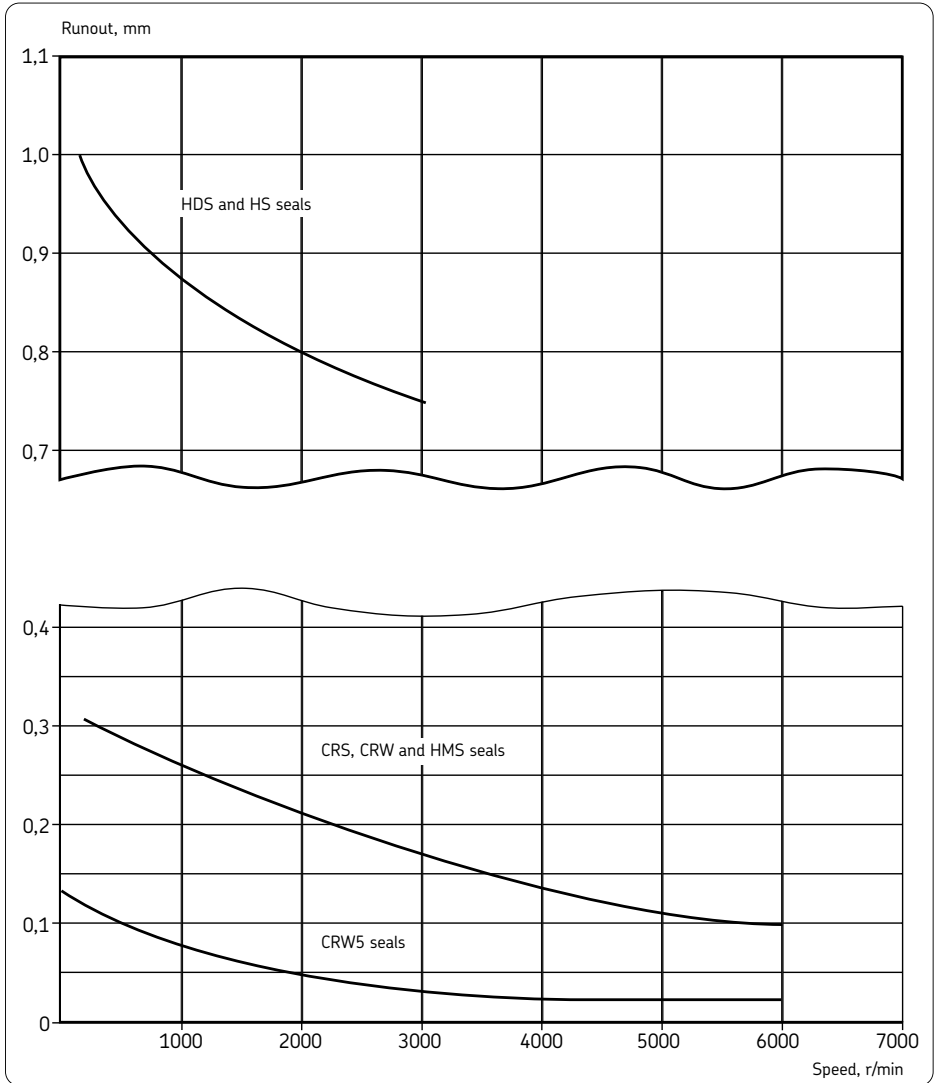

Diagram 7. Maximum permissible runout as a function of rotational speed

Axial movement

Small movements of the shaft with respect to the housing in the axial direction do not affect seal performance, provided that the total counter surface meets the same demands in respect of hardness, accuracy and surface finish.

Permissible speed

Guideline values for the permissible rotational and circumferential speeds for the different seal designs will be found in the section "Overview of SKF radial shaft seals". If the circumferential speeds given in the overview are not sufficient for a particular sealing position, **Diagram 8** on **page 66** may be used. The diagram gives circumferential and rotational speeds related to the material of the sealing lip. The values are valid for spring-loaded lips which are well lubricated by a mineral oil, where adequate lubricant supply ensures that heat does not build up and where the pressure is the same on both sides of the seal (pressure differential = 0). In case of doubt, e.g. when the circumferential speed of the sealing lip is relatively high and there is no experience available in house, it is advisable to consult SKF.

It will be seen from **Diagram 8** that higher circumferential speeds are permitted for large-diameter shafts than for shafts with smaller diameters. This is because the cross section of the shaft does not increase linearly with the increase in diameter but by the square of the increase in diameter, so that the heat removal capacity of a large shaft is much better than that of a small shaft.

Generally, SKF Waveseals can be operated at higher circumferential speeds than those obtained from **Diagram 8** because of the hydrodynamic form of the lip.

The values obtained from **Diagram 8** should be reduced if

- radial shaft seals with a secondary, contacting lip are used,
- lubrication is poor or grease lubrication is used, i.e. when there is little cooling of the sealing lip and poor heat transfer,
- the counterface does not meet the demands in respect of surface finish or running accuracy,
- there is a pressure differential across the seal.

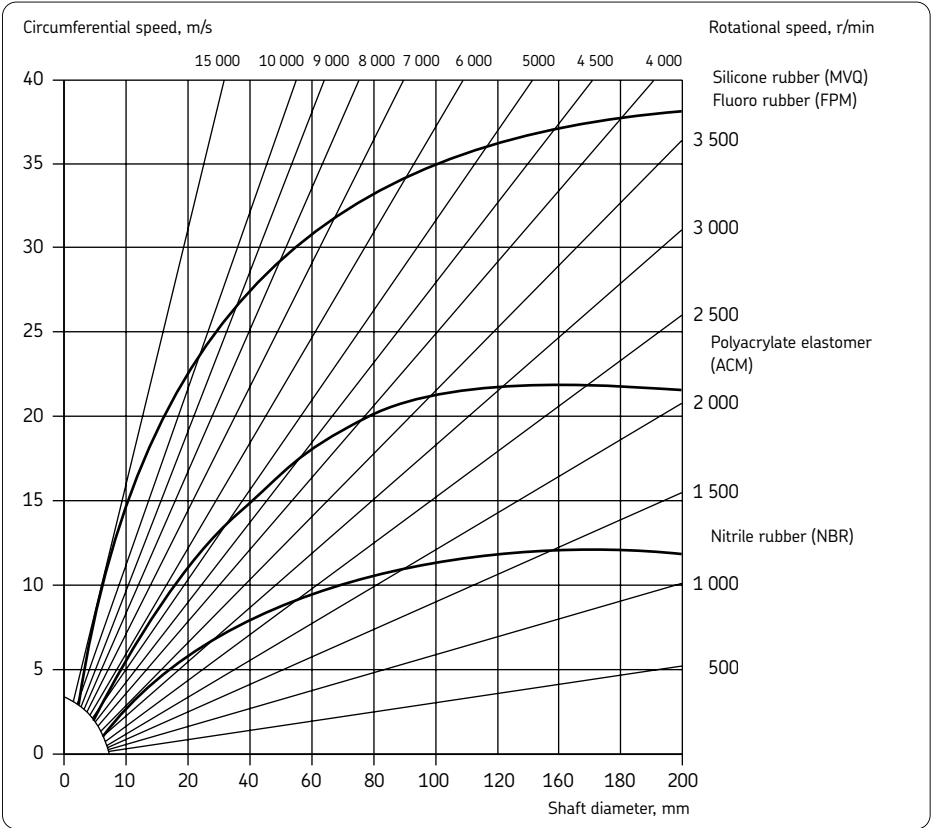

Diagram 8. Permissible speeds for spring-loaded seal lips where no pressure differential exists across seal in operation. For permissible speeds for large diameter seals (shaft diameter > 200 mm/8 inch) see seal selection chart starting on page 100.

Lubrication

In order for a radial shaft seal to be able to seal efficiently over a long period it is necessary to lubricate the sealing lip. This prevents actual lip counter surface contact and reduces friction as well as wear to the lip and counter surface. Dry running of sealing lips made of standard materials should be avoided at all costs. Because of this, the counter surface should be coated with a suitable lubricant when the seal is being installed, so that the sealing lip is lubricated right from the beginning.

The medium being sealed is not only intended to lubricate the seal but also transport the heat generated by friction in the lip/counter surface contact. Thus, the medium must be able to reach the sealing lip in sufficient quantities from the very beginning.

In applications where the seal has to retain oil or grease, lip lubrication is not normally a problem. Some rolling bearings, e.g. angular contact ball bearings, taper roller bearings and spherical roller thrust bearings, as well as gears, have a pumping action by virtue of their design. This means that the sealing lip can either be starved of lubricant or be subjected to excessive quantities of lubricant. In both cases steps need to be taken at the design stage in order to ensure that lubricant actually reaches the contact, or that excess quantities are removed.

Where lubricant starvation has to be prevented, lubrication ducts can be provided. Where there is too much lubricant, a flinger can be installed between bearing and seal.

When lubricants are not being sealed, grease or oil must be supplied separately so that the lip can be lubricated. In exceptional cases and where seals with a secondary (dust) lip or two sealing lips are used it may be sufficient to provide an initial fill of grease between the two lips.

Lubrication of paired arrangements

If two radial shaft seals are to be mounted in a common housing bore either in tandem or in a back-to-back arrangement, care must be taken to see that neither of the sealing lips can run dry at any time. To eliminate any risk of dry running, the free space between the seals or sealing lips should be filled with a suitable lubricating grease.

To guarantee lubricant supply to the sealing lips in operation and to prevent dry running, the use of a spacer ring between the two seals is recommended. This ring should be provided with lubrication holes or an annular groove and lubrication holes (fig 44), so that grease can be supplied to the space between the sealing lips, e.g. via a grease nipple.

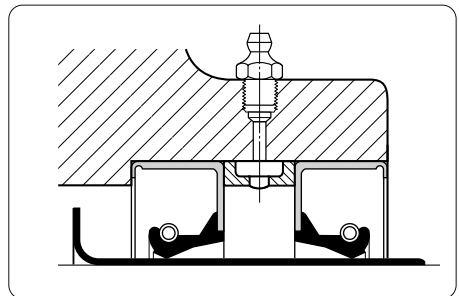

Fig 44

Friction

The lip of a radial shaft seal must always exert a certain pressure on the counterface if efficient sealing is to be obtained. The friction resulting from this lip pressure is only part of the total friction in the contact and thus of the total power loss at the sealing position. The other contributing factors include

- the type of medium being sealed,
- the pressure differential across the seal,
- the circumferential speed,
- the surrounding temperature,
- the lubrication and
- the condition of the counterface.

Diagram 9 gives an indication of the frictional losses which may be expected when a radial shaft seal with conventional sealing lip is properly installed and fully lubricated.

During the running-in phase for the sealing lip, which lasts a few hours, the frictional losses are somewhat higher.

For the seals intended for high pressure differentials, the losses are generally higher than shown in the diagram. For Waveseal designs, on the other hand, the losses are generally lower than indicated.

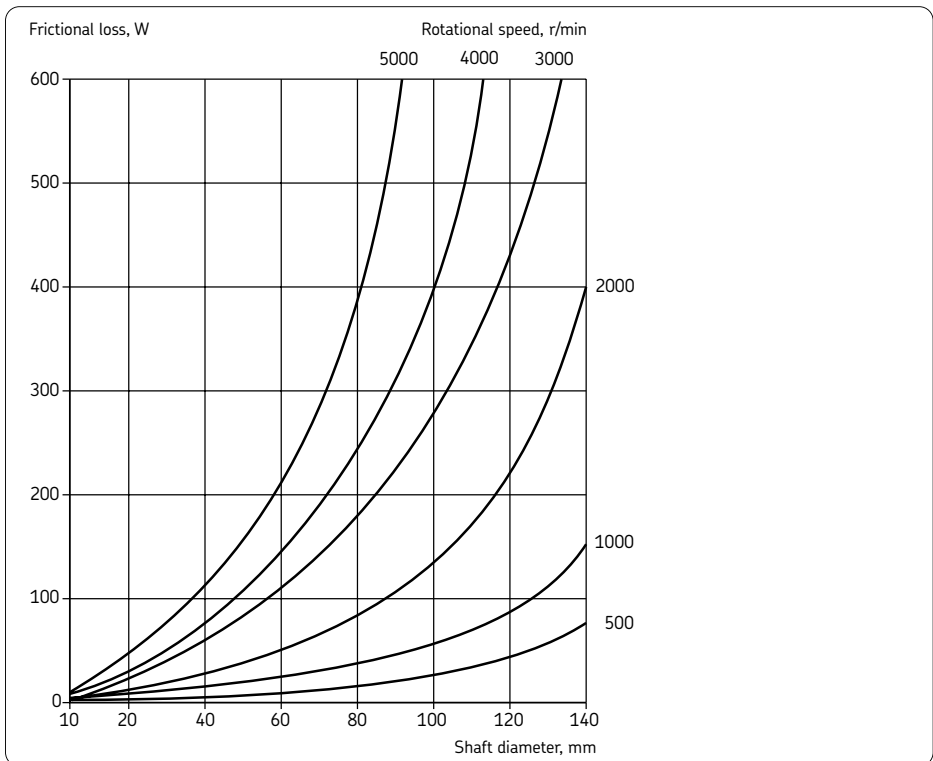

Diagram 9. Frictional losses of radial shaft seals as a function of rotational speed and shaft diameter

Chemical and thermal resistance

The most important factor when selecting the appropriate elastomer for a radial shaft seal is its chemical resistance to the medium to be sealed or excluded. The operating temperature is another important factor. Heat accelerates ageing of the elastomer and increases the reactivity and aggressiveness of the sealed medium.

As radial shaft seals are mainly used to seal

- lubricating oils and greases,
- hydraulic fluids (including non-flammable fluids)

as well as a few other media, guideline values are given in **Table 5, page 70** for the permissible operating temperatures, i.e. temperatures at which the SKF seals are still chemically resistant. The temperature range quoted for a group of media means that the sealing material is resistant when continuously operated within this particular range.

The □ means that, within the group of media, there are some which are compatible with the elastomer, but also some which have a detrimental effect on the elastomer.

The ■ means that the seal material is not resistant to media belonging to this group.

At the lower temperature limit quoted the basic material will not be destroyed and will be fully operational when the temperature is increased again.

For the resistance of seal materials to media not given in **Table 5**, reference should be made to the section "Chemical resistance" or information will be supplied on request.

Table 5. Chemical and thermal resistance, radial shaft seals lip materials

Medium to be sealed	Permissible operating temperatures (continuous) for SKF radial shaft seal lip materials ¹⁾				
	R (NBR)	P (ACM)	S ²⁾ (MVQ)	V (FPM)	
–	°C				
Mineral oil based lubricants					
Motor oils	100	130	150	170	
Gear oils	80	120	130	150	
Hypoid gear oils	80	120	■	150	
Automatic transmission fluids (ATF oils)	100	130	□	170	
Greases	90	□	□	□	
Hydraulic fluids					
	90	120	□	150	
Fire resistant hydraulic fluids					
Oil in water emulsions and aqueous polymer solutions	70	■	60	□	
Anhydrous fluids	■	■	■	150	
Other media					
Fuel oils EL and L	90	□	■	□	
Water	90	■	■	100	
Alkaline washing solutions	90	■	■	1.100	
Permissible temperature range					
for seal lip	min: max:	–30 +100	–40 +150	–60 +160	–40 +200

- 1) R = nitrile rubber
- P = polyacrylate elastomer
- S = silicone rubber
- V = fluoro rubber

2) Silicone rubber seals can only be used when oxygen can reach the sealing position

- Lip material not resistant
- Lip material not resistant to some media in this group

Seals under pressure

Where a pressure is exerted on the seal, the lip will be pressed harder against the counter surface and the actual contact will be enlarged, so that friction and temperature in the contact will increase.

Therefore, the guideline values for speeds obtained from Diagram 5 do not apply.

Guideline values for seals under pressure can be obtained from **Table 6**. The values are for solid shafts, good heat removal via the medium being retained, and where the counterface meets the demands regarding surface finish and running accuracy.

SKF radial shaft seals of the CRW5 and CRWA5 designs can withstand differential pressures of 0,6 MPa (**fig 46**).

Where there is a pressure differential across the seal, a shoulder, spacer ring or retaining ring should be used at the low pressure side of the seal to prevent it from being pressed out of the housing bore (**fig 45**).

An additional steel shell (**fig 47**) which supports the sealing lip makes it possible to use other radial shaft seals under pressure. This solution is rather expensive but can be appropriate where there is no suitable pressure seal available, or where quantities are not sufficient for cost effective production.

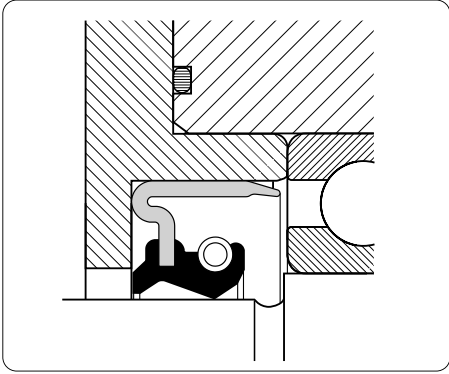

Fig 45

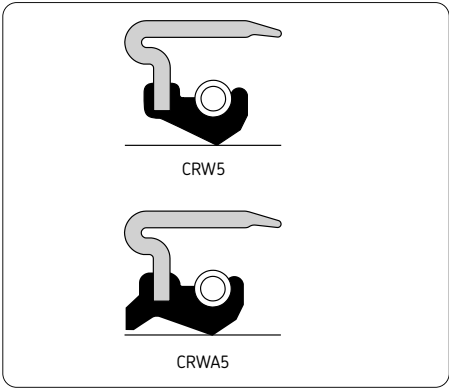

Fig 46

Table 6. Permissible speeds for seals under pressure		
Pressure differential	Shaft speed	Circumferential speed
max	permissible	max
MPa	r/min	m/s
0,02	3.000	5,6
0,035	2.000	3,2
0,05	1.000	2,8

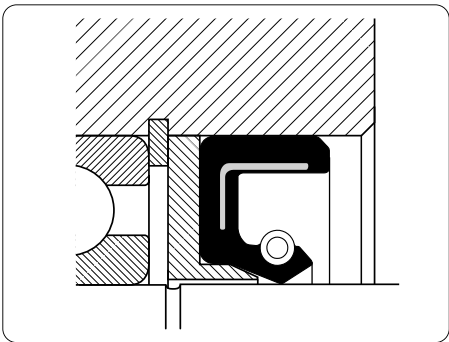
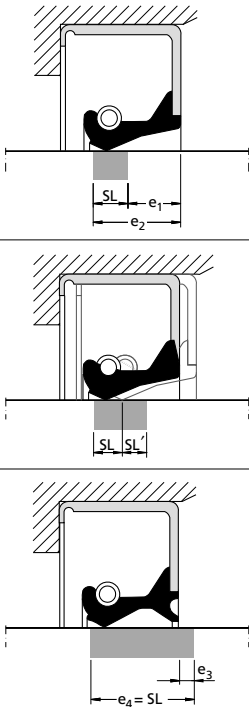

Fig 47

Shaft requirements – small diameter seals (SDS)

Table 7. Counterface for small diameter radial shaft seals



Seal width b	Counterface ¹⁾			
	e ₁	e ₂ min	e ₃	e ₄ min
mm	mm			
7–7,938	3,5	6,1	1,5	7,6
8	3,5	6,8	1,5	8,3
9,525–10	4,5	8,5	2	10,5
11,112–12	5	10	2	2
12,7	5	11	2	13
14,288–15	6	12	3	15
20	9	16,5	3	19,5

¹⁾ SL'- washer width

General

To achieve reliable sealing and sufficiently long service life, the counterface for small radial shaft seals on the shaft should meet the requirements outlined in the following. The counterface is considered to be the extent of the surface of a shaft, or sleeve mounted on a shaft, over which the edge of the sealing lip can run, taking into account all permissible deviations and movements – surface SL, see **Table 7**, as well as an additional surface SL' which may be required in the case of repairs or inspection.

Tolerances

The diameter of the shaft d₁ at the counterface should be machined to the tolerances given in **Table 8** for metric seals and in **Table 9** for inch size seals.

If components which are to be mounted with an interference fit are to be passed over the counterface the shaft diameter should be reduced by 0,2 mm. The seal which was originally chosen can still be used without its sealing properties being impaired.

Surface roughness

The surface roughness to ISO 4288–1985 of the counterface for radial shaft seals should be kept within the following limits:

R _a	0,2 to 0,63 μm
R _z	0,8 to 2,5 μm
R _{max}	6,3 μm

The lower values for R_a and R_z are minimum values as otherwise lubricant supply to the sealing lip will be affected. The temperature rise caused by inadequate lubrication, particularly at high circumferential speeds, would lead to hardening and cracking of the lip and thus to premature seal failure. If the surfaces are too rough there will be excessive seal lip wear and seal life will be shortened. If the value R_{max} is exceeded leakage may occur.

Table 8. Counterface tolerances for metric seals

Shaft diameter Nominal d_1		Diameter tolerance (h 11) Deviation		Circularity tolerance (IT 8) Deviation
over	incl.	high	low	max
mm		μm		μm
6	10	0	- 90	22
10	18	0	-110	27
18	30	0	-130	33
30	50	0	-160	39
50	80	0	-190	46
80	120	0	-220	54
120	180	0	-250	63
180	250	0	-290	72

Table 9. Counterface tolerances for inch size seals

Shaft diameter Nominal d_1		Diameter tolerance Deviation		Circularity tolerance
over	incl.	high	low	max
in		in		in
	4	+0,003	-0,003	0,002
4	6	+0,004	-0,004	0,002
6	10	+0,005	-0,005	0,003

Surface finish

It is also important that the machining operation does not leave any directionality behind on the counter surface, as this could lead to leakage by pumping action, depending on the direction of rotation. A suitable surface can be achieved by plunge grinding; whole number ratios of the grinding wheel speed to the work piece speed should be avoided. The grinding wheel should be dressed using a cluster head dressing tool and the smallest possible lateral feed, or a profile dressing roll without lateral feed. The negative influence of

directionality in any particular case can only be ascertained by test running under conditions of alternating rotation.

The counter surface should be free of any damage such as bruises, scratches, cracks, rust or raised sections. It is therefore important that it not only be carefully machined but also that it be properly protected until final mounting takes place. Such protection can, for instance, be provided by threading a cardboard tube over the counter surface, or preferably over the whole shaft.

Hardness and surface treatment

The surface hardness of the counter surface should normally be at least 55 HRC to EN 10109-1 (1995) or 600 HV and the hardened depth should be at least 0,3 mm. Under certain conditions, e.g. where speeds are low, lubrication good and contamination absent, counter surfaces having a lower hardness than 55 HRC may be suitable. Surfaces which are nitrided, phosphated or have a galvanised layer may also be suitable in special cases, but this must be determined for each specific case.

In case the counter surface cannot meet the demands outlined above, the use of a Speedi-Sleeve is recommended. These wear sleeves are made of stainless steel, have a surface hardness of 95 HRB and a surface roughness of 0,25 to 0,5 R_a μm . Because they are extremely thin walled, the seal chosen for the nominal shaft diameter can still be used. Detailed information on the Speedi-Sleeve will be found in the section "Wear sleeves".

Lead-in chamfers

In order to be able to install radial shaft seals without damaging the seal lip it is recommended that the shaft ends or shoulders should be chamfered or rounded, see **Table 10**.

If the direction of installation is according to Z the values given in **Table 10** should be kept to. If the direction of installation is Y then the shaft end may be either rounded or chamfered.

If seals are to be installed over shaft shoulders or ends which have not been rounded or chamfered it is recommended that a mounting sleeve be used; see section "Mounting".

Table 10. Lead-in chamfers and radii

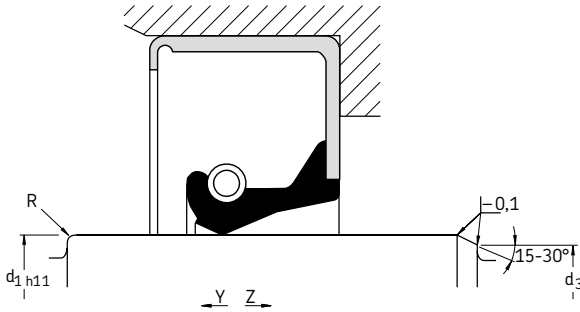

Shaft diameter		Diameter Difference 1)	Radii	
Deviation			Seal without	Seal with
Nominal		$d_1 - d_3$ min	dust lip	dust lip
d_1			R min	R min
over	incl.			
mm		mm	mm	
10	10	1,5	0,6	1
20	20	2	0,6	1
30	30	2,5	0,6	1
40	40	3	0,6	1
50	50	3,5	0,6	1
70	70	4	0,6	1
95	95	4,5	0,6	1
130	130	5,5	1	2
	240	7	1	2

1) If the corner is blended rather than chamfered, the blended section should not be smaller than the difference in diameters $d_1 - d_3$

Shaft requirements, large diameter seals (LDS)

General

To achieve reliable sealing and sufficiently long service life, the counterface for large size radial shaft seals on the shaft should meet the requirements outlined in the following. The counterface is considered to be the extent of the surface of a shaft, or sleeve mounted on a shaft, over which the edge of the sealing lip can run, taking into account all permissible deviations and movements – surface SL, (Table 11), as well as an additional surface SL' which may be required in the case of repairs or inspection.

Tolerances

The diameter of the shaft d_1 at the counterface should be machined to the tolerances given in Table 12 and Table 13, page 78.

If components, which are to be mounted with an interference fit, are to be passed over the counterface the shaft diameter should be reduced by 0,2 mm. The seal which was originally chosen can still be used without its sealing properties being impaired.

Table 11.

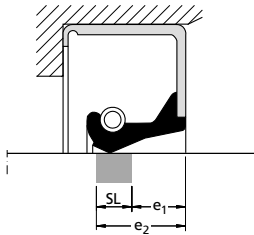

Seal width b		Counterface ¹⁾			
from	incl.	e ₁	e ₂ min	e ₃	e ₄ min
mm		mm			
7	7,938	3,5	6,1	1,5	7,6
–	8	3,5	6,8	1,5	8,3
9,525	10	4,5	8,5	2	10,5
11,112	12	5	10	2	12
–	12,7	5	11	2	13
14,288	15	6	12	3	15
20	–	9	16,5	3	19,5

¹⁾ SL'- washer width

Surface roughness

The surface roughness to ISO 4288 (DIN 4768) of the counterface for radial shaft seals should be kept within the following limits:

R_a 0,2 to 0,8 μm
 R_z 1 to 4 μm
 R_{max} 6,3 μm

The lower values for R_a and R_z are minimum values as otherwise lubricant supply to the sealing lip will be affected. The temperature rise caused by inadequate lubrication,

particularly at high circumferential speeds, would lead to hardening and cracking of the lip and thus to premature seal failure. If the surfaces are too rough there will be excessive seal lip wear and seal life will be shortened. If the value R_{max} is exceeded leakage may occur.

Surface finish

It is also important that the machining operation does not leave any directionality behind on the counterface, as this could lead to leakage by pumping action, depending on the direction of rotation. A suitable surface can

Table 12. Counterface tolerances for large diameter radial shaft seals, metric sizes

Shaft diameter Nominal d_1		Diameter tolerance (h11) Deviation		Circularity tolerance (IT8) Deviation
over	incl.	high	low	max
mm		μm		μm
180	250	0	-290	72
250	315	0	-320	81
315	400	0	-360	89
400	500	0	-400	97
500	630	0	-440	110
630	800	0	-500	125
800	1000	0	-560	140
1000	1250	0	-660	165
1250	1600	0	-780	195
1600	2000	0	-920	230
2000	2500	0	-1100	280
2500	3150	0	-1350	330
3150	4000	0	-1650	410

be achieved by plunge grinding; whole number ratios of the grinding wheel speed to the workpiece speed should be avoided. The grinding wheel should be dressed using a cluster head dressing tool and the smallest possible lateral feed, or a profile dressing roll without lateral feed. The negative influence of directionality in any particular case can only be ascertained by test running under conditions of alternating rotation.

The counterface should be free of any damage such as bruises, scratches, cracks, rust or raised sections. It is therefore important that it be properly protected until final mounting takes place. Such protection can, for instance, be provided by threading a cardboard tube over the counterface, or preferably over the whole shaft.

Hardness and surface treatment

The surface hardness of the counterface should normally be at least 55 HRC or 600 HV and the hardened depth should be at least 0,3 mm. Under certain conditions, e.g. where speeds are low, lubrication good and contamination absent, counterfaces having a lower hardness than 55 HRC may be suitable. Surfaces which are nitrided, phosphated or have a galvanised layer may also be suitable in special cases, but this must be determined for each specific case.

Table 13. Counterface tolerances for inch size seals

Shaft diameter Nominal d_1 over		Diameter tolerance (h11) Deviation		Circularity tolerance (IT8) Deviation
	incl.	high	low	max
in		in		in
-	4	+0.003	-0.003	0.002
4	6	+0.004	-0.004	0.002
6	10	+0.005	-0.005	0.003

Lead-in chamfers

In order to be able to install radial shaft seals without damaging the seal lip it is recommended that the shaft ends or shoulders should be chamfered or rounded (**Table 14**). If the direction of installation is according to Z the values given in **Table 14** should be kept to. If the direction of installation is Y then the shaft end may be either rounded or chamfered.

If seals are to be installed over shaft shoulders or ends which have not been rounded or chamfered it is recommended that a mounting sleeve be used. For further information, please contact our technical department.

Table 14. Lead-in chamfers and radii

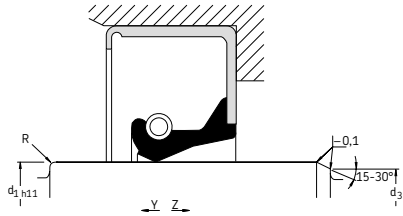

Shaft diameter Nominal d_1 over		Diameter difference ¹⁾ $d_1 - d_3$		Radii seal without dust lip R min		seal with dust lip R min	
incl.		mm	mm				
	240	7		1		2	
240	500	11		2		3	
500		13		5		5	

¹⁾ If the corner is blended rather than chamfered, the blended section should not be smaller than the difference in diameters $d_1 - d_3$

Housing bore requirements, small diameter seals (SDS)

General

The following requirements are designed to guarantee the requisite interference fit for the seal, the necessary static sealing and proper installation.

Tolerances

The bore diameter d_2 in the housing should be machined to tolerance H8, see **Table 15**. The circularity (out-of-round) should be 1 to 2 tolerance grades better than H8, depending on the conditions.

Surface finish

The surface roughness (to ISO 4288–1985 or DIN 4768–1990) of the housing bore should be kept within the limits specified below. These limits apply for radial shaft seals with an elastomeric outside diameter, or a metal case coated with Bore-Tite, as well as the HS seals made of elastomer.

R_a	1,6 to 6,3 μm
R_z	10 to 25 μm
R_{max}	25 μm

For seals with a steel shell without Bore-Tite or similar coating, the limits are

R_a	0,8 to 3,2 μm
R_z	6,3 to 10 μm
R_{max}	10 μm

Housing bores for seals with steel shells

To ensure that the seal can be installed without damaging it, the housing bore should have a 5 to 10° lead-in chamfers. The transition should be free from burrs and the transition R between the seal seating and the shoulder should be in accordance with the recommendations in **Table 15**. The depth of the housing bore t_2 should be at least 0,3 mm greater than the seal width. The cylindrical section of the bore should have a width t_1 which is at least 0,85 b.

Recesses in the housing shoulder, which must be considered at the design stage, considerably facilitate removal of a seal from the housing bore, see fig a in **Table 15**.

Table 15. Housing bore tolerances

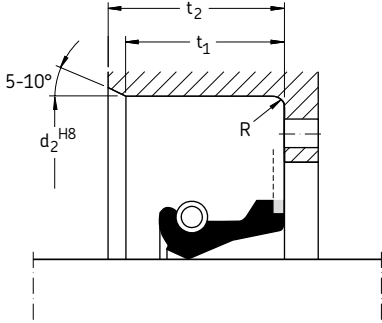

Housing bore for metric seals

Nominal diameter d_2	Housing bore (ISO tolerance H8)		Fillet radii R max	
	Deviation high	low		
over incl. mm	μm		mm	
10	18	+27	0	0,3
18	30	+33	0	0,3
30	50	+39	0	0,3
50	80	+46	0	0,4
80	120	+54	0	0,8
120	180	+63	0	0,8
180	250	+72	0	0,8

Housing bore for inch size seals

Nominal diameter d_2	Housing bore (ISO tolerance H8)		Chamfer R max	
	Deviation high	low		
over incl. in	in		in	
	3	+0,001	-0,001	1/32
3	6	+0,0015	-0,0015	1/32
6	10	+0,002	-0,002	1/32
10	20	+0,002	-0,004	1/32

Housing bore requirements, large diameter seals (LDS)

General

The following requirements are designed to guarantee the requisite interference fit for the seal, the necessary static sealing and proper installation.

Housing bores for seals with steel shells

To ensure that the seal can be installed without damaging it, the housing bore should have a 5 to 10° lead-in chamfer. The transition should be free from burrs and the transition between the seal seating and the shoulder should have a radius not exceeding 0,8 mm.

The depth of the housing bore (t_2) should be at least 0,3 mm greater than the nominal seal width b . The cylindrical section (t_1) of the bore should have a width of at least 0,85 b , (**fig 48**).

Recesses in the housing shoulder, which must be considered at the design stage, considerably facilitate removal of a seal from the housing bore, (**fig 49**).

Housing bores and end covers for HS and HSF seals of elastomers

To ease installation and prevent damage to the seals during mounting, the housing bore should have a lead-in chamfer of 5 to 10°, **fig 49**. The transition should be free of burrs and the transition between seal seating and housing shoulder should have a radius which does not exceed $R = 0,8$ mm.

In contrast to the other radial shaft seals the non-split and split HS and HSF seals must be axially clamped in the housing bore. This is usually achieved by an end cover screwed to the housing wall. The real width of the seal is between 0,4 and 0,8 mm larger than the nominal width of the seal housing groove (t_2). The axial clamping so achieved gives the HS and HSF seal the requisite firm fit in the housing and the correct form for efficient sealing.

The actual seal outside diameter is approximately 0,5 % to 2 % larger than the seal housing bore.

The end cover should be sufficiently thick-walled, depending on diameter and the axial clamping distance, wall thicknesses of between 6 and 12 mm have been found appropriate. The cover should be screwed to the machined housing wall following the recommendations given in **fig 49**. To provide additional protection to the sealing lip against coarse contaminants the inside diameter of the cover should be some 6 to 8 mm larger than the shaft diameter d_1 . There are no limits regarding the outside diameter of the cover. To ease mounting and any subsequent seal replacement, it is recommended that the cover be made in two halves and an even number of screws used.

The end face should be made plane parallel and the machined housing wall should be at right angles to the housing bore.

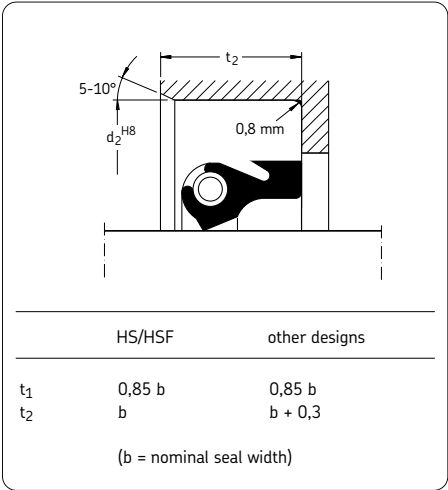

Fig 48. Recommended dimensions for HS seals

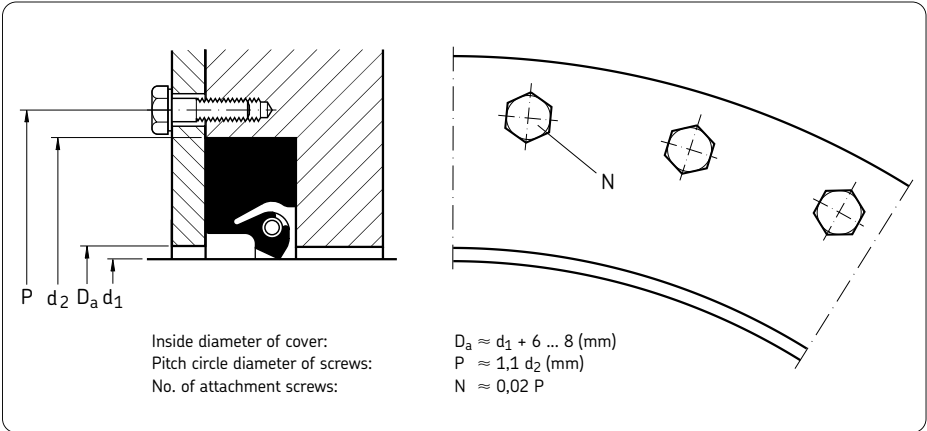

Fig 49. Cover plate recommendations

Tolerances

The bore diameter d_2 in the housing should be machined to tolerance H8 (**Table 16**). The circularity (out-of-round) should be 1 to 2 tolerance grades better than H8, depending on the conditions.

R_a 1,6 to 6,3 μm
 R_z 10 to 25 μm
 R_{max} 25 μm

For seals with a steel shell without Bore-Tite or similar coating, the limits are

Surface finish

The surface roughness (to ISO 4288 or DIN 4768) of the housing bore should be kept within the limits specified to the right. These limits apply for radial shaft seals with an elastomeric outside diameter, or a metal case coated with Bore-Tite, as well as the HS seals made of elastomer.

R_a 0,8 to 3,2 μm
 R_z 6,3 to 10 μm
 R_{max} 10 μm

Table 16. Housing bore tolerances for large diameter seals

Housing bore for metric size seals					Housing bore for inch size seals				
Nominal diameter d_2		Housing bore (ISO tolerance H8)		Chamfer	Nominal diameter d_2		Housing bore		Chamfer
over	incl.	high	low	R max	over	incl.	high	low	R max
mm		μm		mm	in		in		in
180	250	+72	0	0,8	6	10	+0.002	-0.002	1/32
250	315	+81	0	0,8	10	20	+0.002	-0.004	1/32
315	400	+89	0	0,8	20	40	+0.002	-0.006	1/32
400	500	+97	0	0,8	40	60	+0.002	-0.010	1/32
500	630	+110	0	0,8					
630	800	+125	0	0,8					
800	1000	+140	0	0,8					
1000	1250	+165	0	0,8					
1250	1600	+195	0	0,8					
1600	2000	+230	0	0,8					
2000	2500	+280	0	0,8					
2500	3150	+330	0	0,8					
3150	4000	+410	0	0,8					
4000	5000	+500	0	0,8					

Mounting, small diameter seals

General

If radial shaft seals are to perform well in service they must be properly installed. This calls for experience, suitable tools and also cleanliness. The shaft counter surface and housing bore should meet the demands specified under "Shaft requirements" and "Housing bore requirements" and they should be clean.

To ease the installation of the seal in the housing bore and to guarantee initial lubrication it is recommended that the seal be immersed in a suitable lubricant, which is generally that which is to be retained by the seal. If this is not the case then the sealing lip and outside diameter of the seal should be lightly greased.

Seals which have a secondary lip should also be filled with grease between the primary and secondary lips. Silicone rubber seals and seals with hydrodynamic aids should not be treated in this way.

Generally, a mechanical or hydraulic press should be used with suitable tools to install the seal in its housing bore. It should be remembered that the pressure should be applied as close as possible to the outside diameter of the seal.

When pressing seals up against a shoulder or retaining ring it is advisable to use tools of the type shown in **fig 50 and 51**. The necessary ring dimensions will be supplied on request.

When the seal is to be flush with the wall of the housing bore, this must be at right angles to the housing bore axis and the outside diameter of the tool should be larger than the housing bore diameter (**fig 52**).

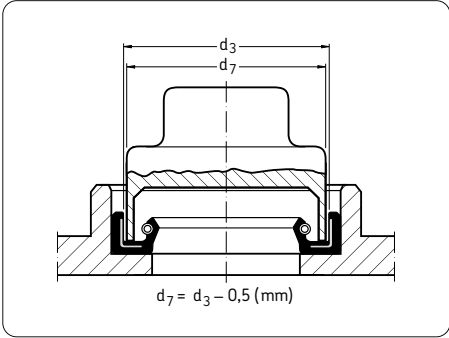

Fig 50

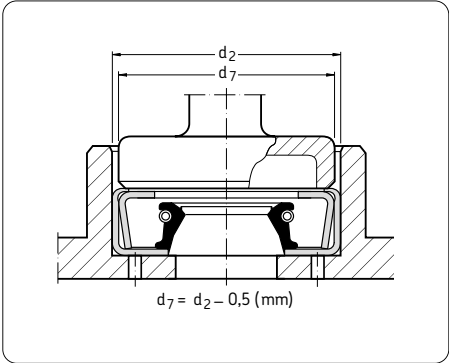

Fig 51

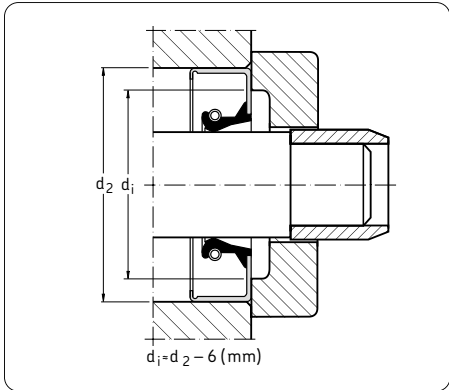

Fig 52

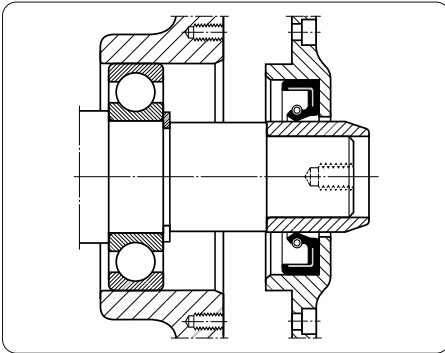

Fig 53

When installing seals on stepped shafts where the shoulders do not have the recommended chamfer or rounded transition, a mounting sleeve as shown in **fig 53** must be used. If the sealing lip has to pass over grooves, threads or gearing, thin-walled mounting sleeves of the type shown in **fig 54** can be used to prevent the lip from being damaged. The outside surface of the sleeve should be coated with the same lubricant as the seal and counter surface.

Radial shaft seals made of silicone rubber should always be installed using a mounting sleeve.

When a seal is to be mounted at a certain distance in a cylindrical opening in a housing, the tools should be according to **fig 55** and **fig 56**. The dimensions needed for designing the tools can be supplied on request.

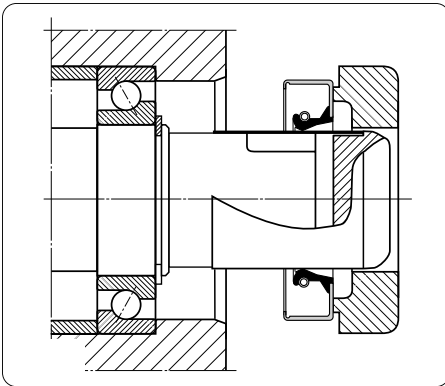

Fig 54

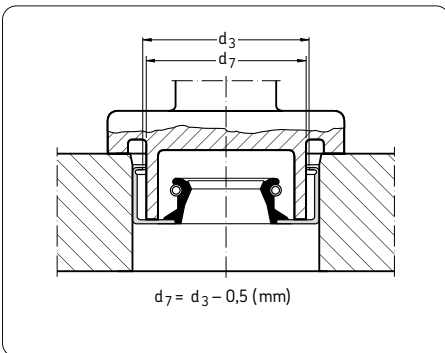

Fig 55

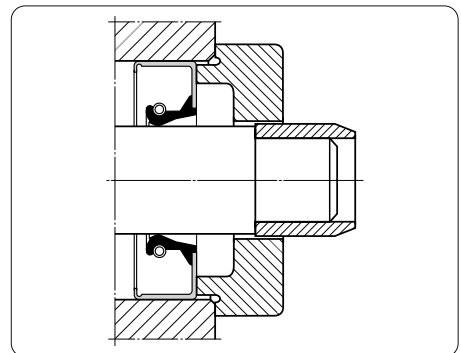

Fig 56

Mounting, large diameter seals

General

For the installation of large diameter metal or rubber-covered seals such as the HDS designs, first check the bore for proper specification and condition. Second, coat both the seal and bore lightly with lubricant (preferably the same lubricant as that to be retained by the seal). With large diameter seals the production of a special mounting tool may not be practical. In such cases, direct impacts on the seal case or elements must be avoided when mounting as this could damage the case or make the sealing lip unserviceable. Therefore, if no suitable press tool is available, the use of a wooden block, long enough to span the seal outer diameter, is recommended. It is important, when using this method, that hammer blows are applied evenly and sequentially to the wood piece around the seal circumference, to prevent the seal from tilting or skewing. SKF also recommends the use of a dead blow hammer for full energy transfer with less shock (**fig 57**).

In some applications, the hardware is designed for two seals in tandem, or a seal might have to be recessed further into the bore depth. In those cases the seal is first set flush with the housing using the method above. Then a shorter piece of wood should be used to drive it deeper into the bore utilizing a sequential pattern (**fig 58**).

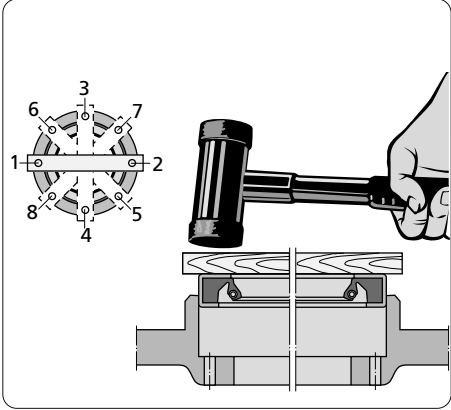

Fig 57

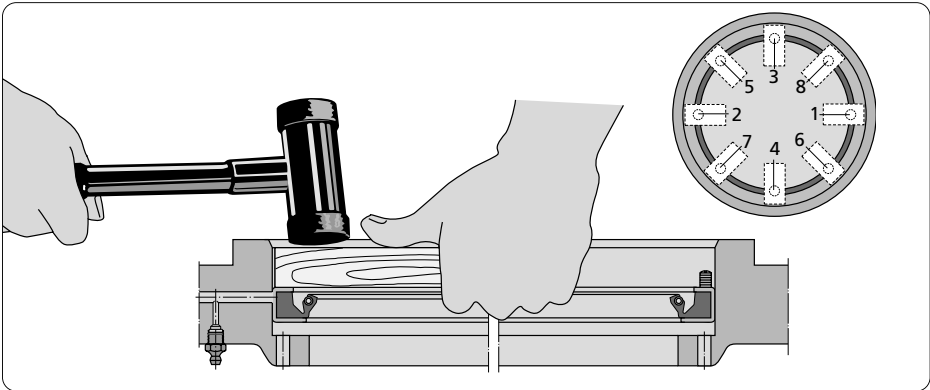

Fig 58

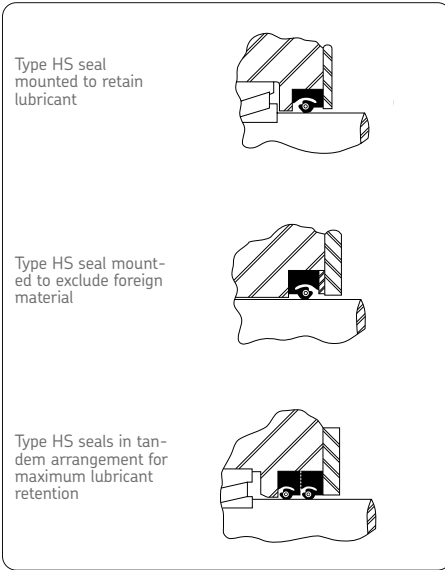

Fig 59. Ways of mounting HS seals

Different ways of mounting HS seals

HS seals are mounted in different ways depending on which purpose they are supposed to fulfil. The can e.g. either be mounted to retain lubricants or to exclude foreign materials (**fig 59**).

Mounting split HS seals

Coat the HS seal and shaft counterface with a lubricant, preferably the same as that to be retained by the seal (**A**, fig 60, page 90).

Where appropriate, insert the spring in the Spring-Lock groove and position the spring connection, so that it is displaced with regard to the seal joint (**B**).

Put the HS seal in the correct position on the shaft. If necessary and if portable vulcanisation equipment is available, use this to join the ends of the HS seal, making sure that the ends are accurately aligned (**C**).

Join the ends of the garter spring in two different ways depending on the type of spring connector (**D**):

Threaded spring connector

Turn the spring ends through approximately three turns, one in the opposite direction to the other. Insert the one end into the other and, because they have already been turned, the ends will screw into position. Further tightening is possible if required, although the connection will hold even if the thin section is not completely screwed into the other end.

Hook-and-eye spring connector

Draw the ends of the spring together and insert the hook into the eye, taking care not to over-stretch the spring in the process, as this might impair seal performance. Springs with control wire connector: draw the ends of the seal together and insert the control wire into the other end of the spring.

Position the seal joint on the shaft so that it is in the 12 o'clock position and push the joint into the housing bore (**E**).

Starting at the 3 and 9 o'clock positions, push the rest of the seal into position (**E**), finishing simultaneously at the 6 and 12 o'clock positions. For shaft diameters of 1 200 mm (4.7 in) and above it may be preferable to fix the seal in the 12, 3, 6 and 9 o'clock positions before pushing home the remaining sections of the seal.

The seal in the housing bore is pushed until it contacts the housing shoulder, e.g. using a small block of wood.

Check the seal condition, particularly at the joint.

Put the end cover in position on the housing wall using the screws. Tighten the screws in turns, tightening opposite screws together, until the end cover abuts the housing wall (**F** and **G**).

Multiple seal installation

When mounting two split seals in one cavity, the locations of the split joints should be staggered 30° to 60°. This will minimize the risk of leakage through the joint. The splits should be located towards the top of the bore. Grease the cavity between the seals to provide lip lubrication for the outer seal.

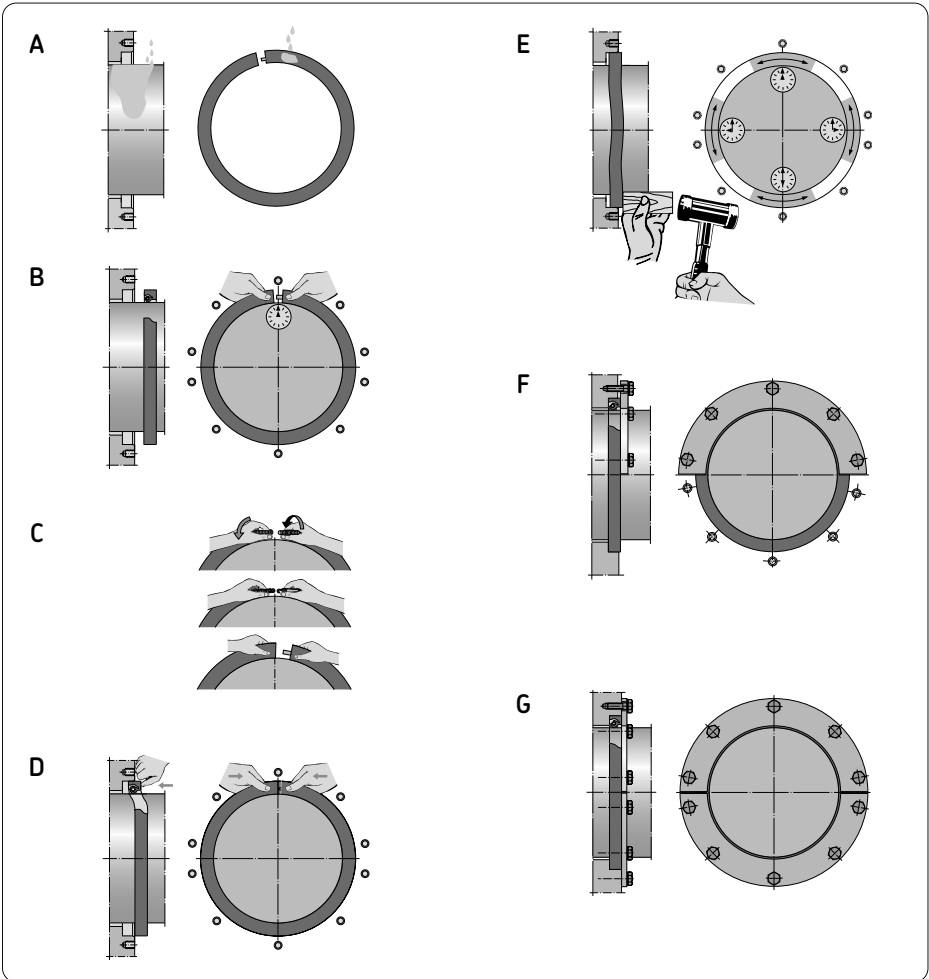

Fig 60

Paired mounting

If two radial shaft seals are to be mounted in a common housing bore either in tandem or in a back-to-back arrangement, care must be taken to see that neither of the sealing lips can run dry at any time. To eliminate any risk of dry running, the free space between the seals or sealing lips should be filled with a suitable lubricating grease.

To guarantee lubricant supply to the sealing lips in operation and to prevent dry running, the use of a spacing ring between the two seals is recommended. This ring should be provided with lubrication holes (fig 61), so that grease can be supplied to the space between the sealing lips, e.g. via a grease nipple. No spacer ring is required when using HDS3 seals as these have spacer lugs built into the large side face (fig 62).

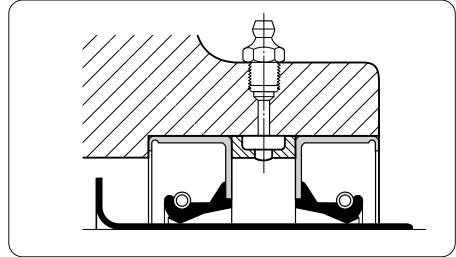

Fig 61. Spacing ring

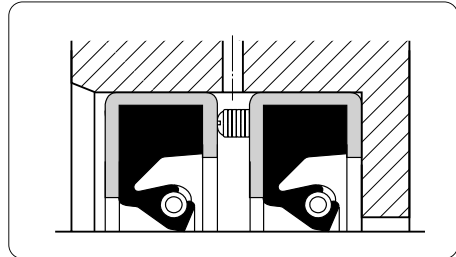

Fig 62. Spacer lugs

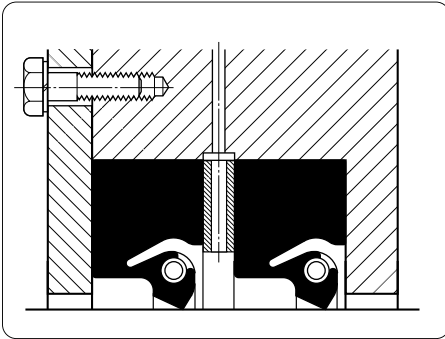

Fig 63. Spacing washer

Where two HS seals made of elastomer are to be mounted in the same housing bore it has been found advantageous to mount a spacing washer between the two seals (**fig 63 and 64**). Suitable washer dimensions can be determined based on the inside and outside diameters of the seal, d_1 and d_2 respectively:

$$\begin{aligned} &\text{washer inside diameter} \\ &= d_1 + 6 \text{ to } 10 \text{ mm} \end{aligned}$$

$$\begin{aligned} &\text{washer outside diameter} \\ &= d_2 - 0,5 \text{ to } 1,5 \text{ mm} \end{aligned}$$

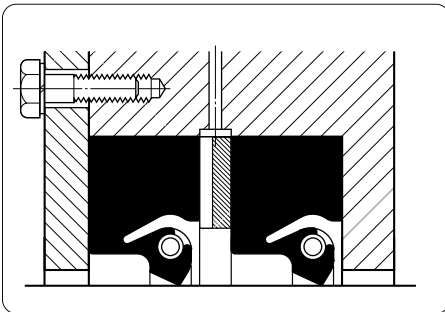

Fig 64. Spacing washer

The washer width must be determined with reference to the conditions but should always be such that lubrication holes can be provided in the circumference, or lubrication grooves in one side face (**fig 65**) to permit grease to be supplied from outside to the sealing lips, e.g. via a grease nipple. When determining washer width and the depth of the housing bore it is also necessary to take into consideration the axial displacement required when clamping the seals.

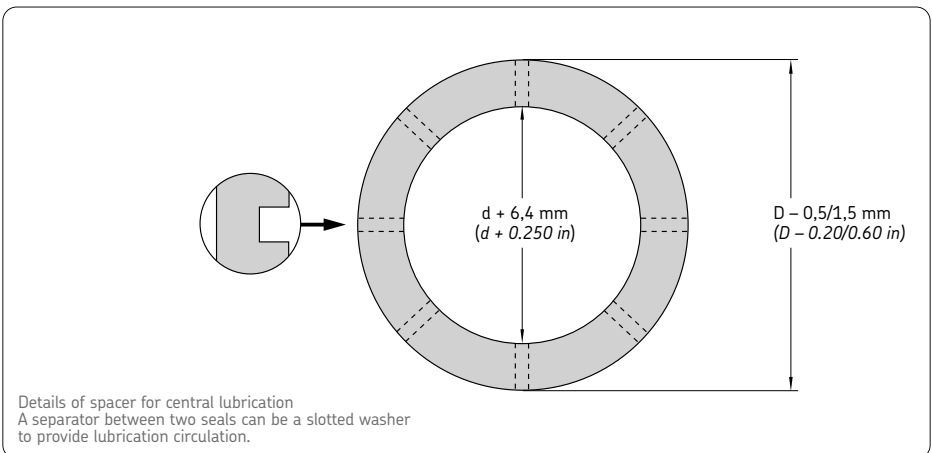

Fig 65. Details of spacer for central lubrication

Cover plates

All HS type seals, split and solid are 0,4 to 0,8 mm (0.016 to 0.031 in) wider than the bore depth and have outside diameters that are 2% to 5% larger than the seal housing bore. The end user is required to fabricate and use a cover plate for proper fit. The cover plate provides axial compression and supplements radial press fit to ensure maximum seal performance. It should be thick enough not to bend or distort. Generally, a thickness of 6,35 to 12,7 mm (0.250 to 0.500 in) is sufficient.

The plate should be secured with bolts, no more than 150 mm (6 in) apart, on a bolt circle located as close to the seal housing bore as practical. The cover plate should be flat and the housing bore depth uniform. Splitting the cover plate at 180° will make seal replacement easier, particularly in confined areas.

To block surges of lubricant towards the seal from the inside and to protect the seal from damage from the outside, it is recommended that the cover plate inner diameter be as close as practical to the shaft. Generally, 6,35 mm (0.250 in) over shaft diameter is sufficient in the presence of shaft misalignment and run out.

Sometimes, supplementary sealing needs to be added. It is impractical to machine the original housing to provide the seal cavity required. In such instances, the seal cavity may be incorporated into a new plate, which is bolted into place as illustrated (**fig 66**).

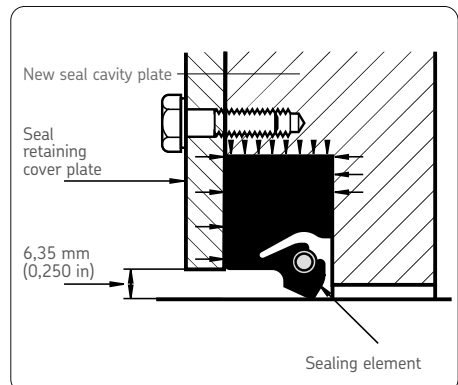

Fig 66

Protecting the counter surface against corrosion

Under normal storage conditions the seal counter surface should be protected against corrosion until the machine is to be used by coating it with a rust inhibiting medium.

The rust inhibition should last for a year with or without packaging.

The protective coating should be soluble in the medium which is to be sealed. Laquers or tars should not separate out as these might impair the sealing.

Where machines are to be transported for long periods (overseas) or stored in unfavorable conditions (e.g. outdoors), or where they are not in use for long periods, special corrosion inhibitors should be used which form tough, pliable and wax-like films that can be removed using neutral solvents. The solvents should leave an oily residue.

Removal

As radial shaft seals should never be re-used, their removal is seldom a problem as there is no need to be careful not to damage the seal. However, before beginning, it may be advisable to note the direction in which the seal is mounted so that the lip of the replacement seal can be mounted in the same direction. Small seals can generally be removed using a screwdriver. The dismounting of large-size seals is made easier if recesses have been provided in the housing shoulder, see picture in **table 15, page 81**, allowing access for a drift.

Replacement

Once a radial shaft seal has been removed during maintenance work, it should never be re-used. The lip of the replacement seal should not be allowed to run on the same path as the lip of the old seal. There are several ways to achieve this:

- rework the counterface (this entails removing the shaft),
- replace a ring which has served as a counter surface,
- use a Speedi-Sleeve,
- mount a spacer ring in the housing bore between the housing shoulder and the seal (**fig 67**),
- press in the new seal to a different depth in a cylindrical opening in the housing.

When necessary, the counter surface should always be displaced towards the side of the medium to be sealed.

When choosing replacement seals care should be taken to see that the design and material correspond to the original. In case of doubt, a higher quality seal should be used to ensure that it can withstand the operating conditions, e.g. with respect to pressure, temperature etc., and that it is compatible with the medium to be sealed.

Seals made of a different material should only be used if absolutely necessary. In such cases the recommendations given in **Table 17** may be followed. The order in which the materials are listed gives an indication of their suitability. Other choices can be made, but these may lead to a considerably shortened seal life.

If a seal of the same design is not available in the same width as the original, then a somewhat narrower seal can be used, or if the depth of the housing bore allows, a somewhat wider seal can be chosen as the replacement.

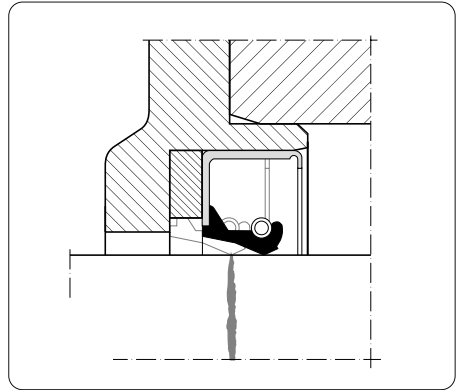

Fig 67

Table 17. Replacement scaling lip materials

Original	Replacement
Felt	Nitrile rubber Polyacrylate elastomer Fluoro rubber
Leather	Nitrile rubber Fluoro rubber
Nitrile rubber	Polyacrylate elastomer Fluoro rubber Silicone rubber
Polyacrylate elastomer	Fluoro rubber Silicone rubber
Silicone rubber	Fluoro rubber

Designation system

Metric radial shaft seals

The designations of all metric radial shaft seals from SKF are prefixed by the letter CR, followed by the size in millimeters (uncoded) and the suffixes for the type and design of the seal and the material of the lip, see **page 97**.

Inch-size radial shaft seals

Inch-size SKF radial shaft seals are identified by their drawing number which consists of from four to seven figures. The drawing number gives an indication of seal size, but not of type or material.

Four-figure numbers are used for radial shaft seals for

shaft diameters ≤ 1 in, e.g.

CR 3680: $d_1 = 0,375$ in

Five-figure numbers are used for radial shaft seals for

shaft diameters $\geq 1 \leq 10$ in, e.g.

CR 41287: $d_1 = 4,125$ in

CR 97545: $d_1 = 9,750$ in

Six and seven-figure numbers are used for radial shaft seals for

shaft diameters ≥ 10 in, e.g.





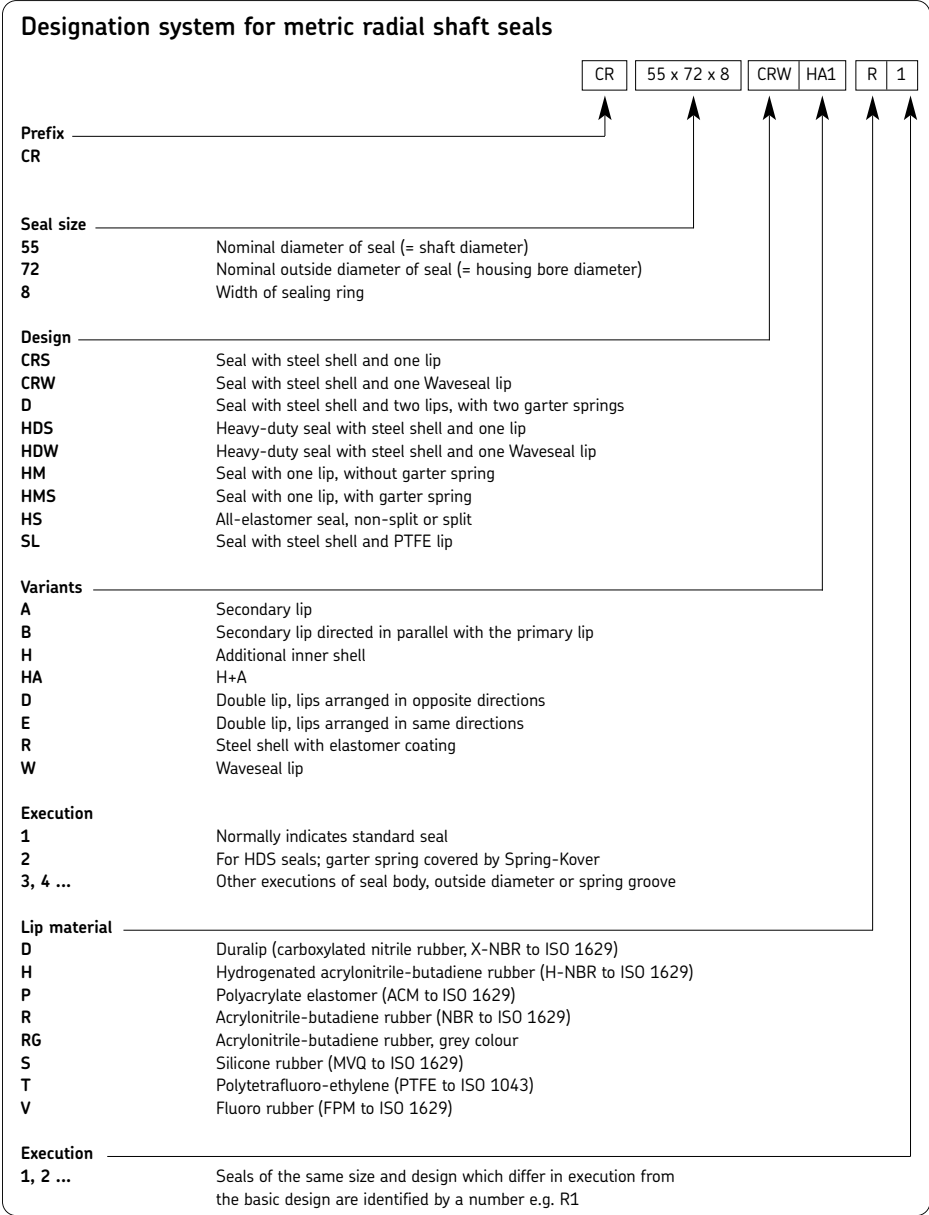

















CR 120061: $d_1 = 12$ in

CR 1375242: $d_1 = 13,75$ in



Seal selection chart

Radial shaft seals, small diameter seal range (SDS)

<p>This matrix can only provide a rough guide and the final seal selection should only be made after a more detailed examination of sealing properties with respect to the actual operating conditions and environment. If several seal designs and materials are shown together then the ratings apply to the specified design/material.</p> <p>Signs and symbols: +++ Very well suited (very good) R Nitrile rubber ++ Well suited (good) V Fluoro rubber + Suitable (normal) - Less suitable (satisfactory) -- Unsuitable (poor)</p>				Design					
				Shell (outside diameter)		Sealing lip		Secondary lip	
Seals types				Steel	Elastomer (Plastomer)	Design	Material	A = rubbing B = non-rubbing	
HMS5 	HMSA10 	-	R,V	normal	R,V	B (HMSA10)			
HMS4 	HMSA7 	-	R,V	normal	R,V	A (HMSA7)			
CRW1 	CRWH1 	+ Bore-Tite	-	Wave-seal	R,V	-			
CRWA1 	CRWHA1 	+ Bore-Tite	-	Wave-seal	R,V	-			
CRW5 	CRWA5 	+ Bore-Tite	-	Wave-seal	R,V	B (CRWA5)			
CRS1 	CRSH1 	+	-	normal	R,V	-			
CRSA1 	CRSHA1 	+	-	normal	R,V	A			
RD10 	RD30 	RD60 	+	-	special	PTFE	-		
RD11 	RD70 	RD71 	+	-	special	PTFE	B (RD11, RD71)		
RDD13 	RDD14 	RDD15 	-	PTFE	special	PTFE	-		



















Suitability

Sealing conditions					Pressure differential		Operating conditions					Media					
Tight fit	Rough surface	Thermal expansion	Split housing bore	Ease of installation	Housing bore/ outside diameter	Sealing lip/ counterface	Sliding speeds < 14 m/s (< 2756 ft/min)	Sliding speeds > 14 m/s (> 2756 ft/min)	Temperatures < 100°C (< 212°F)	Temperatures > 100°C (> 212°F)	Runout	Coaxiality deviation	Grease	Oil	Moderate particulate contamination	Heavy particulate contamination	Aggressive media
+++	+++	+++	+++	++	++	+	+	-	+	V	+	+	+++	+++	+++ HMSA10	+++	++ (V)
++	++	++	++	+	++	+	+	-	+	V	+	+	++	+++	++ HMSA7	+	++ (V)
+++ CRWH	+	-	--	+	++	+++	++	+	+	V	+	+	++	+++	+	+	++ (V)
+++ CRWHA	+	-	--	+	++	+++	++	+	+	V	+	+	++	+++	++	+	++ (V)
++	+	-	--	+	++	+++	++	+	+	V	+	+	++	+++	+	+	++ (V)
+++ CRSH	-	-	--	+	+	-	+	-	+	V	+	+	+	++	+	+	++ (V)
+++ CRSHA	-	-	--	+	+	-	+	-	+	V	+	+	+	++	++	+	++ (V)
++	-	-	-	+	++	+++	+++	+++	+++	+++	+	+	+++	+++	-	+++	+++
++	-	-	-	+	++	+++	+++	+++	+++	+++	+	+	+++	+++	RD11 RD71	+++	+++
++ 1)	++ 1)	++ 1)	-	-	++	+++	+++	+++	+++	+++	+	+	+++	+++	-	+++	+++





















1) together with a separate static seal

Seal selection chart

Radial shaft seals, large diameter seal range (LDS)

Standard design (preferred design)	Other basic line designs		Material code	Operating temperature range		Pressure difference
				°C	°F	
 HDS7			R D H	-40 to +121 -55 to +105 -40 to +149	-40 to +250 -65 to +225 -40 to +300	0,1 (15)
			R H V	-40 to +120 -40 to +150 -40 to +200	-40 to +250 -40 to +300 -40 to +400	0,1 (15)
			R V	-40 to +121 -40 to +204	-40 to +250 -40 to +400	0,1 (15)
			R D H V	-40 to +120 -54 to +105 -40 to +150 -40 to +205	-40 to +250 -65 to +225 -40 to +300 -40 to +400	0,1 (15)
			R D H V	-40 to +120 -55 to +105 -40 to +150 -40 to +205	-40 to +250 -65 to +225 -40 to +300 -40 to +400	0,1 (15)
						
						
			R D H V	-40 to +121 -54 to +107 -40 to +149 -40 to +204	-40 to +250 -65 to +225 -40 to +300 -40 to +400	0,1 (15)
						

Shaft To Bore Misalignment (STBM)	Runout (Dynamic eccentricity of shaft)	Maximum shaft surface speed	Ease of installation	Ability to seal low viscosity lubricants and exclude water
mm (in)	mm (in)	m/s (ft/min)		
1,6 (0.062)	2,4 (0.093)	25 (>5 000) depending on the operating conditions	Excellent	Highly effective exclusion of water and particle contamination and excellent retention of grease
2,5 (0,1)	2,4 (0.093)	24 (>5 000) 25 (>5 000) 35 (>7 000)	Good	Excellent, including retention of light oils at high surface speeds and misalignment
1,5 (0.06)	2,4 (0.093)	25	Excellent	Excellent for oil or grease retention.
1,6 (0.062)	2,4 (0.093)	25 (>5 000)	HDS2, HDS3: Excellent HDS1: Good	Excellent for oil or grease retention.
1,6 (0.062)	2,4 (0.093)	25 (>5 000)	Excellent to good, varies with equipment design.	HDSA/B: Excellent for oil or grease retention with exclusion of light to moderate contamination. HDSC: Good grease retention, increased protection against contamination
1,6 (0.062)	2,4 (0.093)	25 (>5 000)	HDSD/SE2 Excellent HDSD/SE1: Good	HDSD: Excellent for oil or grease retention with exclusion of light to moderate contamination or separation of two media. HDSE: Good grease retention, increased protection against contamination

Standard design (preferred design)	Other basic line designs			Material code	Operating temperature range		Pressure tolerance
					°C	°F	
 HS solid				R	-40 to +120	-40 to +250	HS4: 0,07 (11) HS5: 0,07 (11) for
			D	-55 to +105	-65 to +225		
			H	-40 to +150	-40 to +300		
			V	-40 to +205	-40 to +400		
				R	-40 to +120	-40 to +250	0
HS split			D	-55 to +105	-65 to +225		
			H	-40 to +150	-40 to +300		
			V	-40 to +205	-40 to +400		
							
HS6							
							
HS7	HS8						
				R	-40 to +120	-40 to +250	0,03 (5)
HSF Solid	HSF5	HSF6	HSF7	V	-40 to +205	-40 to +400	
							
		HSF8	HSF9				
				R	-40 to +120	-40 to +250	0
HSF split		HSF2	HSF3	V	-40 to +205	-40 to +400	
							
HSF1		HSF4					

Shaft To Bore Misalignment (STBM)	Runout (Dynamic eccentricity of shaft)	Maximum shaft surface speed	Ease of installation	Ability to seal low viscosity lubricants and exclude water
mm (in)	mm (in)	m/s (ft/min)		
1,6 (0.062)	2,4 (0.093)	HS4: 15 (3 000) HS5: 13 (2 500)	HS4: Good HS5: Good	HS4: Good HS4: Good
1,6 (0.062)	2,4 (0.093)	HS6: 10,2 (2 000) HS7: 7,5 (1 500) HS8: 10 (2 000)	HS6: Fair HS7: Excellent HS8: Good	HS6, HS8: Good to excellent for oil or grease HS7: Good (grease only)
1,5 (0.06)	2,4 (0.093)	15 (>3 000) depending on the operating conditions	Good to excellent	Excellent
1,5 (0.06)	2,4 (0.093)	15,2 (>3 000) depending on the operating conditions	Fair to good depending on the available space for mounting	Good to excellent

Small diameter radial shaft seals (SDS), standard designs

Series HMS5 and HMSA10



Main features

New metric line of rubber outside diameter radial shaft seals, series HMS5 and HMSA10, designed in accordance with ISO 6194 and DIN 3760 for use in a wide range of applications within all industrial areas, e.g. gearboxes. The available size range of HMS5 and HMSA10 includes a full coverage of the ISO 6194 and DIN 3760 dimensions up to 250 mm shaft sizes. Main features are:

- New optimised seal material compound
- Spring loaded and trimmed sealing lip
- Balanced sealing lip and flex section
- Beaded outside diameter
- Secondary (dust) lip of type HMSA10

Design

The rubber outside diameter, provides optimised sealing ability in the housing, also at considerable surface roughness or a split housing.

The spring loaded sealing lip contributes to a quick response to handle dynamic runout and to maintain the sealing ability also at excessive wear. The lip is trimmed to achieve a sharp sealing edge.

Sealing lip and flex section are balanced to achieve good followability to withstand high dynamic runout and shaft to bore mis-alignment.

A beaded outside diameter provides an improved sealing ability and a secure retention in the bore. It also prevents spring back at assembly.

The secondary sealing lip is designed with zero lip/shaft interference in order not to create additional friction resulting in heat generation and energy losses.

Material

Metal insert: Mild steel
 Spring: Spring steel
 Sealing lips and outside diameter: Acrylonitrile-butadiene rubber, hardness 75° Shore A, SKF material code NBR 3243. The compound has the designation suffix RG.

This new nitrile rubber compound SKF 3243 is the result of long experience and the latest findings from the SKF seal material developments. Main advantages are:

- Good resistance to ageing
- Very good compatibility to synthetic oils
- Very good pumping ability
- Good wear resistance

The pumping ability is defined by the time it takes for the seal to return a certain amount of oil from the airside to the oil side. The shorter the time the more effective is the seal. The microstructure of the SKF 3243 compound is resulting in that the seal will instantly pump back the oil.

The complete range of HMS5 and HMSA10 is also available in a fluoro rubber compound with the garter spring in stainless steel. This compound has the designation suffix V and is used in applications with temperatures beyond the limits of nitrile rubber.

Applications and operating conditions

Series HMS5 and HMSA10 are designed for optimum use in bearing applications lubricated with oil or grease in temperatures from -40 to $+100^{\circ}\text{C}$ (104 to 212°F), short-term up to 120°C (248°F), for synthetic lubricants maximum $+80^{\circ}\text{C}$ (176°F). The series is also appropriate for sealing lubricants with low viscosity or gaseous media.

Surface speed: up to 14 m/s ($2\,755\text{ ft/min}$)
 Operating pressure: max $0,03\text{ MPa}$ (5 psi)

These values are the maximum value for each service condition and should not occur together. Consideration must be taken to how the service conditions affect each other.

Machining directions

Recommendations according to ISO standard:

Shaft

Tolerance: h11
 Surface roughness: $R_a\ 0,2$ to $0,63\ \mu\text{m}$
 $R_z\ 0,8$ to $2,5\ \mu\text{m}$
 Surface finishing: non-oriented, preferably by plunge-grinding

Housing bore

Tolerance: H8
 Surface roughness: $R_a\ 3,2\ \mu\text{m}$
 $R_z\ 12,5\ \mu\text{m}$

Recommendations according to DIN standard

Shaft

Tolerance: h11
 Surface roughness: $R_a\ 0,2$ to $0,8\ \mu\text{m}$
 $R_z\ 1$ to $5\ \mu\text{m}$
 Hardness: min. 45 HRC
 Surface finishing: non-oriented, preferably by plunge-grinding

Housing bore

Tolerance: H8
 Surface roughness: $R_a\ 1,6$ to $6,3\ \mu\text{m}$
 $R_z\ 10$ to $20\ \mu\text{m}$

Installation

Careful fitting according to ISO 6194 or DIN 3760 is a prerequisite for proper functioning of the seal.

We recommend to use seals of type HMSA10 with a secondary lip in applications with increased demand on protection of the primary lip. Please note, that during installation, the cavity between the primary and secondary lip should be lubricated with a grease compatible with the oil/grease used in the application.

Series HMS5 and HMSA10

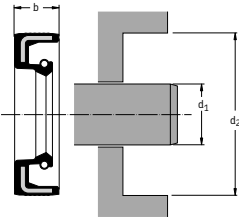

* To be followed by the design and material codes, indicating one of the four variants available for each dimension:

- HMS5 RG** without secondary lip, nitrile rubber
 - HMS5 V** without secondary lip, fluoro rubber
 - HMSA10 RG** with secondary lip, nitrile rubber
 - HMSA10 V** with secondary lip, fluoro rubber
- Example: CR 6x16x5 HMSA10 RG

** Design execution differs from the basic design and is indicated by a number, see also page 97.

Dimensions			SKF Designation	ISO/DIN	Dimensions			SKF Designation	ISO/DIN																																																																		
shaft d ₁	bore d ₂	seal width b			shaft d ₁	bore d ₂	seal width b																																																																				
mm			mm																																																																								
6	16	5	CR 6×16×5*		15	24	7	CR 15×24×7**																																																																			
	16	7	CR 6×16×7*	•		25	5	CR 15×25×5*																																																																			
	22	7	CR 6×22×7*	•		25	6	CR 15×25×6*																																																																			
7	16	7	CR 7×16×7**		26	7	CR 15×26×7*	•																																																																			
		7	CR 7×22×7*	•	30	7	CR 15×30×7*	•																																																																			
		7	CR 7×22×7*	•	32	7	CR 15×32×7*																																																																				
8	18	5	CR 8×18×5*		16	28	7	CR 15×35×7*	•																																																																		
		7	CR 8×18×7*																																																																								
		7	CR 8×22×7*	•																																																																							
		7	CR 8×24×7*	•																																																																							
9	22	7	CR 9×22×7*	•	30	7	CR 16×30×7*	•																																																																			
									7	CR 16×32×7*																																																																	
10	22	7	CR 9×22×7*	•	32	7	CR 16×32×7*	•																																																																			
									24	7	CR 10×19×7**		35	7	CR 16×35×7*	•																																																											
																	20	6	CR 10×20×6*		40	7	CR 17×40×7*																																																				
																									20	7	CR 10×20×7*		40	10	CR 17×40×10*																																												
																																	22	7	CR 10×22×7*	•	40	10	CR 17×40×10*																																				
																																									24	7	CR 10×24×7*		40	10	CR 17×40×10*																												
																																																	25	7	CR 10×25×7*	•	40	10	CR 17×40×10*																				
26	7	CR 10×26×7*	•	40	10	CR 17×40×10*																																																																					
								12	19	5	CR 12×19×5**		18	28	7	CR 18×28×7*																																																											
																	22	5	CR 12×22×5**		30	6	CR 18×30×6*																																																				
																									22	6	CR 12×22×6*		30	7	CR 18×30×7*	•																																											
																																	22	7	CR 12×22×7*	•	32	7	CR 18×32×7*	•																																			
																																									24	7	CR 12×24×7*	•	35	7	CR 18×35×7*	•																											
																																																	25	7	CR 12×25×7*	•	40	7	CR 18×40×7*																				
28	7	CR 12×28×7*		40	7	CR 18×40×7*																																																																					
																																																										30	7	CR 12×30×7*	•	19	30	7	CR 19×30×7*										
																																																																			32	7	CR 12×32×7*		30	8	CR 19×30×8*		
																																																																											32
								13	26	7	CR 13×26×7*		19	30	7	CR 19×30×7*																																																											
																	14	24	7	CR 14×24×7*	•	30	8	CR 19×30×8*																																																			
																									25	5	CR 14×25×5*		32	7	CR 19×32×7*																																												
																																	28	7	CR 14×28×7*		32	7	CR 19×32×7*																																				
								30	7	CR 14×30×7*	•	32	7	CR 19×32×7*																																																													

Series HMS5 and HMSA10

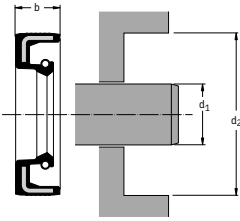

Dimensions			SKF Designation	ISO/DIN	Dimensions			SKF Designation	ISO/DIN					
shaft	bore	seal width			shaft	bore	seal width							
d_1	d_2	b		d_1	d_2	b								
mm				mm										
20	30	5	CR 20×30×5*		25	35	6	CR 25×35×6*						
	30	7	CR 20×30×7*	•		35	7	CR 25×35×7*	•					
	32	7	CR 20×32×7*			37	5	CR 25×37×5*						
	34	7	CR 20×34×7*			37	6	CR 25×37×6*						
20	35	6	CR 20×35×6*		25	37	7	CR 25×37×7*						
	35	7	CR 20×35×7*	•		38	7	CR 25×38×7*						
	35	8	CR 20×35×8*			40	5	CR 25×40×5*						
	35	10	CR 20×35×10*			40	7	CR 25×40×7*	•					
	36	7	CR 20×36×7*			40	8	CR 25×40×8*						
	38	7	CR 20×38×7*			40	10	CR 25×40×10*						
	40	7	CR 20×40×7*	•		42	6	CR 25×42×6*						
	40	10	CR 20×40×10*			42	7	CR 25×42×7*						
	42	7	CR 20×42×7*			42	10	CR 25×42×10*						
	42	10	CR 20×42×10*			45	7	CR 25×45×7*						
	47	7	CR 20×47×7*			45	8	CR 25×45×8*						
	47	10	CR 20×47×10*			45	10	CR 25×45×10*						
	52	7	CR 20×52×7*			46	7	CR 25×46×7*						
	52	10	CR 20×52×10*			47	7	CR 25×47×7*	•					
21	35	7	CR 21×35×7*			47	10	CR 25×47×10*						
						50	10	CR 25×50×10*						
22	32	7	CR 22×32×7*	•		52	7	CR 25×52×7*	•					
						52	8	CR 25×52×8*						
						62	10	CR 25×52×10*						
						62	7	CR 25×62×7*						
						62	8	CR 25×62×8*						
						62	10	CR 25×62×10*						
						42	10	CR 22×42×10*		26	37	7	CR 26×37×7*	
						47	7	CR 22×47×7*	•		38	5	CR 26×38×5*	
23	40	10	CR 23×40×10*			38	7	CR 26×38×7*						
						42	7	CR 26×42×7*						
						47	7	CR 26×47×7*						
						24	35	7	CR 24×35×7*			27	37	7
42	10	CR 27×42×10*												
40	7	CR 24×40×7*												
42	8	CR 24×42×8*												
47	7	CR 24×47×7*												
							43	7	CR 27×43×7*					
							47	10	CR 27×47×10*					

Series HMS5 and HMSA10

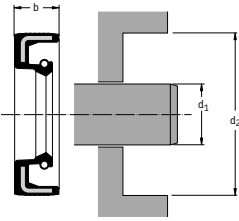

* To be followed by the design and material codes, indicating one of the four variants available for each dimension:

- HMS5 RG** without secondary lip, nitrile rubber
 - HMS5 V** without secondary lip, fluoro rubber
 - HMSA10 RG** with secondary lip, nitrile rubber
 - HMSA10 V** with secondary lip, fluoro rubber
- Example: CR 6x16x5 HMSA10 RG

** Design execution differs from the basic design and is indicated by a number, see also page 97.

Dimensions			SKF Designation	ISO/DIN	Dimensions			SKF Designation	ISO/DIN
shaft d ₁	bore d ₂	seal width b			shaft d ₁	bore d ₂	seal width b		
mm			mm						
28	38	7	CR 28x38x7*	•	32	42	7	CR 32x42x7*	
	38	8	CR 28x38x8*		32	43	7	CR 32x43x7*	
40	7	CR 28x40x7*	32		44	7	CR 32x44x7*		
40	8	CR 28x40x8*	32		45	7	CR 32x45x7*		
42	7	CR 28x42x7*	32		45	8	CR 32x45x8*		
28	42	8	CR 28x42x8*		32	47	6	CR 32x47x6*	
	44	6	CR 28x44x6*		32	47	7	CR 32x47x7*	
	45	8	CR 28x45x8*		32	47	8	CR 32x47x8*	
	47	7	CR 28x47x7*		32	47	10	CR 32x47x10*	
	47	10	CR 28x47x10*		32	48	8	CR 32x48x8*	
	52	7	CR 28x52x7*	32	50	8	CR 32x50x8*		
	52	10	CR 28x52x10*	32	50	10	CR 32x50x10*		
30	40	7	CR 30x40x7*	•	32	52	7	CR 32x52x7*	
	42	6	CR 30x42x6*	•	32	52	8	CR 32x52x8*	
	42	7	CR 30x42x7*	•	32	55	10	CR 32x55x10*	
	42	8	CR 30x42x8*	•	32	62	10	CR 32x62x10*	
	44	7	CR 30x44x7*	•	32	72	7	CR 32x72x7*	
	45	7	CR 30x45x7*	•	33	45	7	CR 33x45x7*	
	45	8	CR 30x45x8*	•	33	50	6	CR 33x50x6*	
	46	7	CR 30x46x7*	•	34	44	8	CR 34x44x8*	
	47	6	CR 30x47x6*	•		48	8	CR 34x48x8*	
	47	7	CR 30x47x7*	•		52	8	CR 34x52x8*	
	47	8	CR 30x47x8*	•		62	10	CR 34x62x10*	
	47	10	CR 30x47x10*	•	35	45	7	CR 35x45x7*	
	48	8	CR 30x48x8*	•		47	6	CR 35x47x6*	
	50	7	CR 30x50x7*	•		47	7	CR 35x47x7*	
	50	8	CR 30x50x8*	•		47	8	CR 35x47x8*	
	50	10	CR 30x50x10*	•		48	8	CR 35x48x8*	
	52	7	CR 30x52x7*	•		49	6	CR 35x49x6*	
	52	8	CR 30x52x8*	•		50	7	CR 35x50x7*	
	52	10	CR 30x52x10*	•		50	8	CR 35x50x8*	
	55	7	CR 30x55x7*	•		50	10	CR 35x50x10*	
55	10	CR 30x55x10*	•	52		7	CR 35x52x7*		
62	7	CR 30x62x7*	•	52	8	CR 35x52x8*			
62	10	CR 30x62x10*	•	52	10	CR 35x52x10*			
72	10	CR 30x72x10*	•						

Series HMS5 and HMSA10

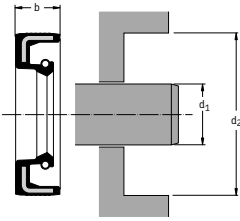

Dimensions			SKF Designation	ISO/DIN	Dimensions			SKF Designation	ISO/DIN
shaft	bore	seal width			shaft	bore	seal width		
d_1	d_2	b		d_1	d_2	b			
mm				mm					
35	55	7	CR 35×55×7*	•	40	50	8	CR 40×50×8*	
	55	8	CR 35×55×8*	•		52	6	CR 40×52×6*	
	55	10	CR 35×55×10*			52	7	CR 40×52×7*	•
	56	10	CR 35×56×10*			52	8	CR 40×52×8*	•
	58	10	CR 35×58×10*			55	7	CR 40×55×7*	•
	60	10	CR 35×60×10*			55	8	CR 40×55×8*	•
	62	7	CR 35×62×7*			56	8	CR 40×56×8*	
	62	8	CR 35×62×8*			58	7	CR 40×58×7*	
	62	10	CR 35×62×10*			58	8	CR 40×58×8*	
	72	10	CR 35×72×10*			58	10	CR 40×58×10*	
	72	12	CR 35×72×12*			60	10	CR 40×60×10*	
	80	12	CR 35×80×12*			62	6	CR 40×62×6*	
						62	7	CR 40×62×7*	•
						62	8	CR 40×62×8*	•
36	47	7	CR 36×47×7*		62	10	CR 40×62×10*		
	50	7	CR 36×50×7*		65	10	CR 40×65×10*		
	52	7	CR 36×52×7*		65	12	CR 40×65×12*		
	58	10	CR 36×58×10*		68	8	CR 40×68×8*		
	62	7	CR 36×62×7*		68	10	CR 40×68×10*		
					72	7	CR 40×72×7*		
37	50	6	CR 37×50×6*		72	10	CR 40×72×10*		
38	50	7	CR 38×50×7*		80	10	CR 40×80×10*		
	52	7	CR 38×52×7*		80	12	CR 40×80×12*		
	52	8	CR 38×52×8*						
	54	10	CR 38×54×10*		41	56	7	CR 41×56×7*	
	55	7	CR 38×55×7*	•					
	55	8	CR 38×55×8*	•	42	55	7	CR 42×55×7*	
	55	10	CR 38×55×10*			55	8	CR 42×55×8*	•
	58	8	CR 38×58×8*	•	56	7	CR 42×56×7*		
	58	10	CR 38×58×10*		60	7	CR 42×60×7*		
	60	10	CR 38×60×10*		62	7	CR 42×62×7*		
62	7	CR 38×62×7*	•	62	8	CR 42×62×8*	•		
62	8	CR 38×62×8*	•	62	10	CR 42×62×10*			
62	10	CR 38×62×10*		65	10	CR 42×65×10*			
72	10	CR 38×72×10*		65	12	CR 42×65×12*			
38,5	58	7	CR 38.5×58×7*		66	10	CR 42×66×10*		
					67	10	CR 42×67×10*		
					72	8	CR 42×72×8*		
					72	10	CR 42×72×10*		

Series HMS5 and HMSA10

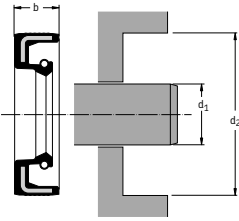

* To be followed by the design and material codes, indicating one of the four variants available for each dimension:

- HMS5 RG** without secondary lip, nitrile rubber
 - HMS5 V** without secondary lip, fluoro rubber
 - HMSA10 RG** with secondary lip, nitrile rubber
 - HMSA10 V** with secondary lip, fluoro rubber
- Example: CR 6x16x5 HMSA10 RG

** Design execution differs from the basic design and is indicated by a number, see also page 97.

Dimensions			SKF Designation	ISO/DIN	Dimensions			SKF Designation	ISO/DIN		
shaft	bore	seal width			shaft	bore	seal width				
d ₁	d ₂	b		d ₁	d ₂	b					
mm				mm							
43	62	8	CR 43×62×8*		48	62	8	CR 48×62×8*	•		
						65	10	CR 48×65×10*			
44	60	10	CR 44×60×10*		48	68	10	CR 48×68×10*			
	62	10	CR 44×62×10*			70	10	CR 48×70×10*			
	65	10	CR 44×65×10*			72	7	CR 48×72×7*			
						72	8	CR 48×72×8*			
45	55	7	CR 45×55×7*		50	72	10	CR 48×72×10*			
	58	7	CR 45×58×7*			62	7	CR 50×62×7*			
	60	7	CR 45×60×7*				64	6		CR 50×64×6*	
	60	8	CR 45×60×8*			•	65	8		CR 50×65×8*	•
	60	10	CR 45×60×10*			65	10	CR 50×65×10*		•	
	62	7	CR 45×62×7*				68	7			CR 50×68×7*
	62	8	CR 45×62×8*			•	68	8		CR 50×68×8*	•
	62	10	CR 45×62×10*			68	10	CR 50×68×10*		•	
	65	8	CR 45×65×8*				•	68			10
	65	10	CR 45×65×10*			70	10	CR 50×70×10*		•	
	68	7	CR 45×68×7*			72	8	CR 50×72×8*			
	68	10	CR 45×68×10*			72	10	CR 50×72×10*		•	
	68	12	CR 45×68×12*			72	12	CR 50×72×12*			
	72	8	CR 45×72×8*			•	75	10		CR 50×75×10*	•
	72	10	CR 45×72×10*			80	8	CR 50×80×8*			
	75	8	CR 45×75×8*			•	80	10		CR 50×80×10*	•
	75	10	CR 45×75×10*			85	10	CR 50×85×10*			
	80	10	CR 45×80×10*			•	90	10		CR 50×90×10*	•
85	10	CR 45×85×10*	52	63	8	CR 52×63×8*					
46	59	12	CR 46×59×12*		52	65	8	CR 52×65×8*			
		65	10			CR 46×65×10*	68	8		CR 52×68×8*	
	72	8	CR 46×72×8*			72	8	CR 52×72×8*			
47	65	10	CR 47×65×10*		52	72	10	CR 52×72×10*			
		70	10			CR 47×70×10*	80	10		CR 52×80×10*	
	70	10	CR 47×70×10*			85	10	CR 52×85×10*			
						85	10	CR 52×85×10*			

Series HMS5 and HMSA10

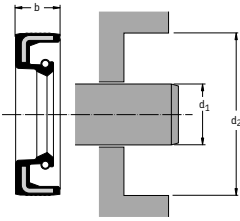

Dimensions			SKF Designation	ISO/DIN	Dimensions			SKF Designation	ISO/DIN
shaft d ₁	bore d ₂	seal width b			shaft d ₁	bore d ₂	seal width b		
mm			mm						
55	68	8	CR 55×68×8*		62	80	10	CR 62×80×10*	
	70	8	CR 55×70×8*	•		85	10	CR 62×85×10*	
	70	10	CR 55×70×10*			90	10	CR 62×90×10*	
	72	8	CR 55×72×8*	•	63	85	10	CR 63×85×10*	
	72	10	CR 55×72×10*			90	10	CR 63×90×10*	
	75	10	CR 55×75×10*			64	80	8	CR 64×80×8*
	78	10	CR 55×78×10*				65	80	8
	78	12	CR 55×78×12*		85	10		CR 65×85×10*	•
	80	8	CR 55×80×8*	•	85	12		CR 65×85×12*	
	80	10	CR 55×80×10*		88	12		CR 65×88×12*	
	85	8	CR 55×85×8*		90	10		CR 65×90×10*	•
	85	10	CR 55×85×10*		95	10		CR 65×95×10*	
	90	10	CR 55×90×10*		65	100	10	CR 65×100×10*	
	100	12	CR 55×100×12*			68	90	10	CR 68×90×10*
56	72	8	CR 56×72×8*		70		85	8	CR 70×85×8*
57	67	7	CR 57×67×7*			90	10	CR 70×90×10*	•
	58	72	8	CR 58×72×8*			90	12	CR 70×90×12*
		80	8	CR 58×80×8*			92	12	CR 70×92×12*
		80	10	CR 58×80×10*			95	10	CR 70×95×10*
60	80	12	CR 58×80×12*		70	100	10	CR 70×100×10*	
	72	8	CR 60×72×8*			72	110	10	CR 70×110×10*
	75	8	CR 60×75×8*	•			90	10	CR 72×90×10*
	80	8	CR 60×80×8*	•	95			10	CR 72×95×10*
	80	10	CR 60×80×10*				100	10	CR 72×100×10*
	82	12	CR 60×82×12*		90	8		CR 60×90×8*	
	85	8	CR 60×85×8*	•		10	10	CR 60×90×10*	
	85	10	CR 60×85×10*				10	10	CR 60×95×10*
	90	8	CR 60×90×8*			8		8	CR 60×110×8*
	90	10	CR 60×90×10*						
	95	10	CR 60×95×10*						
110	8	CR 60×110×8*							

Series HMS5 and HMSA10

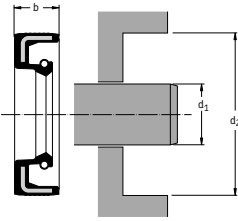

* To be followed by the design and material codes, indicating one of the four variants available for each dimension:

- HMS5 RG** without secondary lip, nitrile rubber
 - HMS5 V** without secondary lip, fluoro rubber
 - HMSA10 RG** with secondary lip, nitrile rubber
 - HMSA10 V** with secondary lip, fluoro rubber
- Example: CR 6x16x5 HMSA10 RG

** Design execution differs from the basic design and is indicated by a number, see also page 97.

Dimensions			SKF Designation	ISO/DIN	Dimensions			SKF Designation	ISO/DIN	
shaft d ₁	bore d ₂	seal width b			shaft d ₁	bore d ₂	seal width b			
mm			mm							
75	90	10	CR 75×90×10*		100	120	10	CR 100×120×10*		
	95	10	CR 75×95×10*	•		120	12	CR 100×120×12*	•	
	95	12	CR 75×95×12*			125	12	CR 100×125×12*	•	
	100	10	CR 75×100×10*	•		130	12	CR 100×130×12*	•	
	100	12	CR 75×100×12*			140	12	CR 100×140×12*	•	
	105	10	CR 75×105×10*			150	12	CR 100×150×12*		
	110	12	CR 75×110×12*							
	120	12	CR 75×120×12*		105	130	12	CR 105×130×12*	•	
78	100	10	CR 78×100×10*			130	12	CR 110×130×12*	•	
					140	12	CR 110×140×12*	•		
					150	12	CR 110×150×12*			
80	95	10	CR 80×95×10*		115	140	12	CR 115×140×12*	•	
	100	10	CR 80×100×10*	•						
	100	12	CR 80×100×12*			120	140	12	CR 120×140×12*	
	105	10	CR 80×105×10*				150	12	CR 120×150×12	
	110	10	CR 80×110×10*	•			160	12	CR 120×160×12*	
	110	12	CR 80×110×12*		125	150	12	CR 125×150×12*	•	
85	100	10	CR 85×100×10*			160	12	CR 130×160×12*	•	
	105	12	CR 85×105×12*			160	15	CR 130×160×15*		
	110	12	CR 85×110×12*	•		130	160	12	CR 130×160×12*	•
	115	12	CR 85×115×12*				160	15	CR 130×160×15*	
85	120	12	CR 85×120×12*	•	135	170	12	CR 135×170×12*	•	
	130	12	CR 85×130×12*							
90	110	10	CR 90×110×10*		140	160	12	CR 140×160×12*		
	110	12	CR 90×110×12*	•		170	12	CR 140×170×12*	•	
	115	12	CR 90×115×12*			140	15	CR 140×170×15*		
	120	12	CR 90×120×12*	•		180	12	CR 140×180×12*		
95	115	12	CR 95×115×12*		145	175	15	CR 145×175×15*	•	
	120	12	CR 95×120×12*	•		148	170	15	CR 148×170×15*	
	125	12	CR 95×125×12*	•			150	180	12	CR 150×180×12*
				180	15	CR 150×180×15*		•		

Series HMS5 and HMSA10

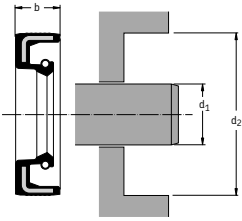

Dimensions			SKF Designation	ISO/DIN	Dimensions			SKF Designation	ISO/DIN	
shaft	bore	seal width			shaft	bore	seal width			
d_1	d_2	b				d_1	d_2	b		
mm					mm					
155	180	15	CR 155×180×15*							
160	185	15	CR 160×185×15*							
	190	15	CR 160×190×15* •							
165	190	15	CR 165×190×15*							
170	200	15	CR 170×200×15* •							
180	210	15	CR 180×210×15* •							
190	220	15	CR 190×220×15* •							
	225	15	CR 190×225×15*							
200	230	15	CR 200×230×15* •							
210	240	15	CR 210×240×15* •							
220	250	15	CR 220×250×15* •							
230	260	15	CR 230×260×15* •							
240	270	15	CR 240×270×15* •							
250	280	15	CR 250×280×15* •							
	285	15	CR 250×285×15*							

Series CRW1

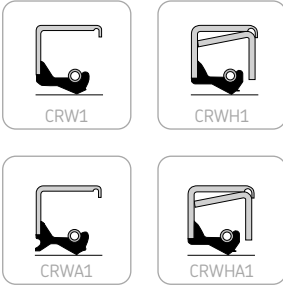

Features

SKF CRW1 radial shaft seals are low friction seals with Waveseal lip design for reduced heat generation and steel shell for easy installation and a firm and accurate seating in the housing bore. CRW1 seals are coated on the outside diameter with Bore-Tite, a non-hardening, water-based polyacrylate sealant, which helps to fill out small imperfections in the housing bore.

Primarily for lubricant retention but seals of CRWA1 and CRWHA1 designs are also suitable for exclusion of dust and light contamination.

CRW1: Seal with single steel shell, Bore-Tite coated outside diameter, hydrodynamically formed Waveseal lip and carbon steel garter spring.

CRWH1: Seal with double steel shell, Bore-Tite coated outside diameter, hydrodynamically formed Waveseal lip and carbon steel garter spring.

CRWA1: Seal with single steel shell, Bore-Tite coated outside diameter, hydrodynamically formed Waveseal lip, carbon steel garter spring and non-rubbing secondary lip.

CRWHA1: Seal with double steel shell, Bore-Tite coated outside diameter, hydrodynamically formed Waveseal lip, carbon steel garter spring and non-rubbing secondary lip.

Further information about material, application and operating conditions for SKF CRW1 seals is shown in the seal selection chart on **page 98**.

Series CRW1 – Metric sizes

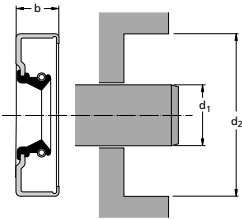

Dimensions			Design and lip material	SKF Designation		
shaft d_1	bore d_2	seal width b				
mm						
12	22	7	CRW1 V	CR 12×22×7 CRW1 V		
	22	7	CRW1 R	CR 12×22×7 CRW1 R		
	25	7	CRW1 R	CR 12×25×7 CRW1 R	Bore-Tite	
	26	7	CRW1 R	CR 12×26×7 CRW1 R	Bore-Tite	
	28	7	CRW1 R	CR 12×28×7 CRW1 R	Bore-Tite	
	28	7	CRW1 P	CR 12×28×7 CRW1 P	Bore-Tite	
	30	7	CRW1 R	CR 12×30×7 CRW1 R	Bore-Tite	
	32	7	CRW1 R	CR 12×32×7 CRW1 R	Bore-Tite	
	32	7	CRW1 V	CR 12×32×7 CRW1 V	Bore-Tite	
	35	7	CRW1 R	CR 12×35×7 CRW1 R	Bore-Tite	
	14	26	7	CRW1 V	CR 14×26×7 CRW1 V	Bore-Tite
		26	7	CRW1 R	CR 14×26×7 CRW1 R	Bore-Tite
27		6,5	CRW1 R	CR 14×27×6,5 CRW1 R	Bore-Tite	
28		7	CRW1 R	CR 14×28×7 CRW1 R	Bore-Tite	
30		7	CRW1 R	CR 14×30×7 CRW1 R	Bore-Tite	
32		7	CRW1 R	CR 14×32×7 CRW1 R	Bore-Tite	
35		7	CRW1 R	CR 14×35×7 CRW1 R	Bore-Tite	
15	24	7	CRW1 R	CR 15×24×7 CRW1 R	Bore-Tite	
	25	7	CRW1 P	CR 15×25×7 CRW1 P	Bore-Tite	
	26	7	CRW1 R	CR 15×26×7 CRW1 R	Bore-Tite	
	26	7	CRW1 V	CR 15×26×7 CRW1 V	Bore-Tite	
	28	7	CRW1 R	CR 15×28×7 CRW1 R	Bore-Tite	
	30	7	CRW1 R	CR 15×30×7 CRW1 R	Bore-Tite	
	32	7	CRW1 R	CR 15×32×7 CRW1 R	Bore-Tite	
	32	7	CRW1 V	CR 15×32×7 CRW1 V	Bore-Tite	
	35	7	CRW1 R	CR 15×35×7 CRW1 R	Bore-Tite	
	35	7	CRW1 P	CR 15×35×7 CRW1 P	Bore-Tite	
	40	7	CRW1 R	CR 15×40×7 CRW1 R	Bore-Tite	
16	28	7	CRW1 R	CR 16×28×7 CRW1 R	Bore-Tite	
	30	7	CRW1 R	CR 16×30×7 CRW1 R	Bore-Tite	
	30	7	CRW1 V	CR 16×30×7 CRW1 V	Bore-Tite	
	32	7	CRW1 R	CR 16×32×7 CRW1 R	Bore-Tite	
	35	7	CRW1 R	CR 16×35×7 CRW1 R	Bore-Tite	
	40	7	CRW1 R	CR 16×40×7 CRW1 R	Bore-Tite	
	40	7	CRWA1 R	CR 16×40×7 CRWA1 R	Bore-Tite	

Series CRW1 – Metric sizes

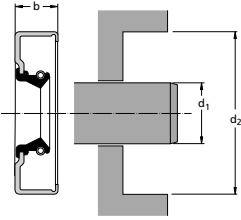

Dimensions			Design and lip material	SKF Designation	
shaft	bore	seal width			
d_1	d_2	b			
mm					
17	27	6,35	CRW1 R	CR 17×27×6,35 CRW1 R	Bore-Tite
	28	7	CRW1 R	CR 17×28×7 CRW1 R	
	28	7	CRW1 V	CR 17×28×7 CRW1 V	Bore-Tite
	30	7	CRW1 R	CR 17×30×7 CRW1 R	Bore-Tite
	32	7	CRW1 R	CR 17×32×7 CRW1 R	Bore-Tite
	35	7	CRW1 R	CR 17×35×7 CRW1 R	Bore-Tite
	35	7	CRW1 V	CR 17×35×7 CRW1 V	Bore-Tite
	40	7	CRW1 R	CR 17×40×7 CRW1 R	Bore-Tite
	47	7	CRW1 R	CR 17×47×7 CRW1 R	Bore-Tite
18	30	7	CRW1 R	CR 18×30×7 CRW1 R	Bore-Tite
	30	7	CRW1 V	CR 18×30×7 CRW1 V	Bore-Tite
	32	7	CRW1 R	CR 18×32×7 CRW1 R	Bore-Tite
	32	7	CRW1 V	CR 18×32×7 CRW1 V	Bore-Tite
	35	7	CRW1 R	CR 18×35×7 CRW1 R	Bore-Tite
	40	7	CRW1 R	CR 18×40×7 CRW1 R	Bore-Tite
19	32	6,35	CRW1 R	CR 19×32×6,35 CRW1 R	Bore-Tite
	35	7	CRW1 R	CR 19×35×7 CRW1 R	Bore-Tite
	38	7	CRW1 R	CR 19×38×7 CRW1 R	Bore-Tite
	40	6,35	CRW1 R	CR 19×40×6,35 CRW1 R	Bore-Tite
	52	7	CRWA1 R	CR 19×52×7 CRWA1 R	Bore-Tite
20	30	7	CRW1 R	CR 20×30×7 CRW1 R	Bore-Tite
	31	7	CRW1 R	CR 20×31×7 CRW1 R	Bore-Tite
	32	7	CRW1 R	CR 20×32×7 CRW1 R	Bore-Tite
	35	7	CRW1 R	CR 20×35×7 CRW1 R	Bore-Tite
	35	7	CRW1 V	CR 20×35×7 CRW1 V	Bore-Tite
	36	7	CRW1 R	CR 20×36×7 CRW1 R	Bore-Tite
	36	7	CRW1 V	CR 20×36×7 CRW1 V	Bore-Tite
	37	7	CRW1 R	CR 20×37×7 CRW1 R	Bore-Tite
	38	7	CRW1 R	CR 20×38×7 CRW1 R	Bore-Tite
	40	7	CRW1 R	CR 20×40×7 CRW1 R	Bore-Tite
	40	7	CRW1 V	CR 20×40×7 CRW1 V	Bore-Tite
	42	7	CRW1 R	CR 20×42×7 CRW1 R	Bore-Tite
	47	7	CRW1 R	CR 20×47×7 CRW1 R	Bore-Tite
	52	7	CRW1 R	CR 20×52×7 CRW1 R	Bore-Tite
	52	7	CRW1 P	CR 20×52×7 CRW1 P	Bore-Tite

Series CRW1 – Metric sizes

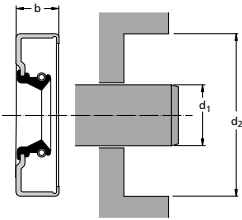

Dimensions			Design and lip material	SKF Designation	
shaft d_1	bore d_2	seal width b			
mm					
21	35	7	CRW1 R	CR 21×35×7 CRW1 R	Bore-Tite
	35	7	CRW1 V	CR 21×35×7 CRW1 V	Bore-Tite
	40	8	CRW1 R	CR 21×40×8 CRW1 R	Bore-Tite
22	31	7	CRW1 P	CR 22×31×7 CRW1 P	Bore-Tite
	32	7	CRW1 R	CR 22×32×7 CRW1 R	Bore-Tite
	35	7	CRW1 R	CR 22×35×7 CRW1 R	Bore-Tite
	35	7	CRW1 V	CR 22×35×7 CRW1 V	Bore-Tite
	38	7	CRW1 R	CR 22×38×7 CRW1 R	Bore-Tite
	38	7	CRW1 V	CR 22×38×7 CRW1 V	Bore-Tite
	40	6,35	CRW1 R	CR 22×40×6,35 CRW1 R	Bore-Tite
	40	6,35	CRW1 V	CR 22×40×6,35 CRW1 V	Bore-Tite
	42	7	CRW1 R	CR 22×42×7 CRW1 R	Bore-Tite
	45	8	CRW1 R	CR 22×45×8 CRW1 R	Bore-Tite
	45	8	CRW1 V	CR 22×45×8 CRW1 V	Bore-Tite
	47	8	CRW1 R	CR 22×47×8 CRW1 R	Bore-Tite
	50	8	CRW1 R	CR 22×50×8 CRW1 R	Bore-Tite
24	36	7	CRW1 V	CR 24×36×7 CRW1 V	Bore-Tite
	38	7	CRW1 V	CR 24×38×7 CRW1 V	Bore-Tite
	40	8	CRW1 R	CR 24×40×8 CRW1 R	
	47	8	CRW1 R	CR 24×47×8 CRW1 R	Bore-Tite
	25	35	7	CRW1 R	CR 25×35×7 CRW1 R
35		7	CRW1 V	CR 25×35×7 CRW1 V	Bore-Tite
36		7	CRW1 R	CR 25×36×7 CRW1 R	Bore-Tite
37		7	CRW1 R	CR 25×37×7 CRW1 R	Bore-Tite
37		7	CRW1 V	CR 25×37×7 CRW1 V	Bore-Tite
38		7	CRW1 R	CR 25×38×7 CRW1 R	Bore-Tite
38		7	CRW1 V	CR 25×38×7 CRW1 V	Bore-Tite
40		7	CRW1 R	CR 25×40×7 CRW1 R	Bore-Tite
40		7	CRW1 R	CR 25×40×7 CRW1 R	
40		7	CRW1 V	CR 25×40×7 CRW1 V	Bore-Tite
42		8	CRW1 V	CR 25×42×8 CRW1 V	Bore-Tite
42		8	CRW1 R	CR 25×42×8 CRW1 R	Bore-Tite
45		7	CRW1 R	CR 25×45×7 CRW1 R	Bore-Tite
47		6,35	CRW1 R	CR 25×47×6,35 CRW1 R	Bore-Tite
48		8	CRW1 R	CR 25×48×8 CRW1 R	Bore-Tite
48		8	CRW1 V	CR 25×48×8 CRW1 V	Bore-Tite
50		8	CRW1 R	CR 25×50×8 CRW1 R	Bore-Tite
52	8	CRW1 R	CR 25×52×8 CRW1 R	Bore-Tite	

Series CRW1 – Metric sizes

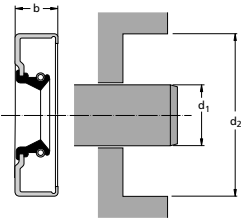

Dimensions			Design and lip material	SKF Designation	
shaft d_1	bore d_2	seal width b			
mm					
25	52	8	CRW1 V	CR 25×52×8 CRW1 V	Bore-Tite
	62	7	CRW1 R	CR 25×62×7 CRW1 R	Bore-Tite
	62	7	CRW1 V	CR 25×62×7 CRW1 V	Bore-Tite
27	42	7	CRW1 R	CR 27×42×7 CRW1 R	Bore-Tite
	42	7	CRW1 V	CR 27×42×7 CRW1 V	Bore-Tite
	43	8	CRW1 V	CR 27×43×8 CRW1 V	Bore-Tite
	45	8	CRW1 R	CR 27×45×8 CRW1 R	Bore-Tite
	45	8	CRW1 V	CR 27×45×8 CRW1 V	Bore-Tite
	52	8	CRW1 R	CR 27×52×8 CRW1 R	Bore-Tite
28	40	7	CRW1 R	CR 28×40×7 CRW1 R	Bore-Tite
	40	7	CRW1 V	CR 28×40×7 CRW1 V	Bore-Tite
	42	7	CRW1 R	CR 28×42×7 CRW1 R	Bore-Tite
	42	7	CRW1 V	CR 28×42×7 CRW1 V	Bore-Tite
	45	7	CRW1 R	CR 28×45×7 CRW1 R	Bore-Tite
	45	7	CRW1 V	CR 28×45×7 CRW1 V	Bore-Tite
	47	7	CRW1 V	CR 28×47×7 CRW1 V	Bore-Tite
	47	8	CRW1 R	CR 28×47×8 CRW1 R	Bore-Tite
	52	8	CRW1 R	CR 28×52×8 CRW1 R	Bore-Tite
	30	40	7	CRW1 R	CR 30×40×7 CRW1 R
40		7	CRW1 V	CR 30×40×7 CRW1 V	Bore-Tite
42		7	CRW1 R	CR 30×42×7 CRW1 R	Bore-Tite
42		7	CRW1 V	CR 30×42×7 CRW1 V	Bore-Tite
45		8	CRW1 R	CR 30×45×8 CRW1 R	Bore-Tite
45		8	CRW1 P	CR 30×45×8 CRW1 P	Bore-Tite
47		7	CRW1 R	CR 30×47×7 CRW1 R	Bore-Tite
47		8	CRW1 V	CR 30×47×8 CRW1 V	Bore-Tite
48		8	CRW1 R	CR 30×48×8 CRW1 R	Bore-Tite
50		8	CRW1 R	CR 30×50×8 CRW1 R	Bore-Tite
50		8	CRW1 V	CR 30×50×8 CRW1 V	Bore-Tite
52		8	CRW1 R	CR 30×52×8 CRW1 R	Bore-Tite
55		7	CRW1 R	CR 30×55×7 CRW1 R	Bore-Tite
55		7	CRW1 V	CR 30×55×7 CRW1 V	Bore-Tite
56		8	CRW1 R	CR 30×56×8 CRW1 R	Bore-Tite
58		8	CRWA1 R	CR 30×58×8 CRWA1 R	Bore-Tite
60		8	CRW1 R	CR 30×60×8 CRW1 R	Bore-Tite
62		7	CRW1 R	CR 30×62×7 CRW1 R	Bore-Tite
62	7	CRW1 V	CR 30×62×7 CRW1 V	Bore-Tite	
72	8	CRW1 R	CR 30×72×8 CRW1 R	Bore-Tite	
72	12	CRWA1 V	CR 30×72×12 CRWA1 V	Bore-Tite	

Series CRW1 – Metric sizes

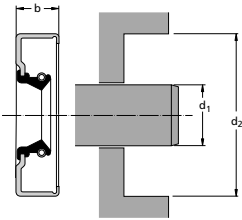

Dimensions			Design and lip material	SKF Designation	
shaft	bore	seal width			
d_1	d_2	b			
mm					
32	42	7	CRW1 R	CR 32×42×7 CRW1 R	Bore-Tite
	42	7	CRW1 V	CR 32×42×7 CRW1 V	Bore-Tite
	45	8	CRW1 R	CR 32×45×8 CRW1 R	Bore-Tite
	47	8	CRW1 R	CR 32×47×8 CRW1 R	Bore-Tite
	47	8	CRW1 V	CR 32×47×8 CRW1 V	Bore-Tite
	48	8	CRW1 R	CR 32×48×8 CRW1 R	Bore-Tite
	48	8	CRW1 V	CR 32×48×8 CRW1 V	Bore-Tite
	50	8	CRW1 R	CR 32×50×8 CRW1 R	Bore-Tite
	50	8	CRW1 V	CR 32×50×8 CRW1 V	Bore-Tite
	52	8	CRW1 R	CR 32×52×8 CRW1 R	Bore-Tite
	52	8	CRW1 V	CR 32×52×8 CRW1 V	Bore-Tite
	56	8	CRW1 R	CR 32×56×8 CRW1 R	Bore-Tite
	62	6,35	CRW1 R	CR 32×62×6,35 CRW1 R	Bore-Tite
	34	48	8	CRW1 R	CR 34×48×8 CRW1 R
48		8	CRW1 V	CR 34×48×8 CRW1 V	Bore-Tite
55		8	CRW1 R	CR 34×55×8 CRW1 R	Bore-Tite
56		8	CRW1 R	CR 34×56×8 CRW1 R	Bore-Tite
56		8	CRW1 V	CR 34×56×8 CRW1 V	Bore-Tite
62		8	CRW1 R	CR 34×62×8 CRW1 R	Bore-Tite
35	47	7	CRW1 R	CR 35×47×7 CRW1 R	Bore-Tite
	47	7	CRW1 V	CR 35×47×7 CRW1 V	
	48	8	CRW1 R	CR 35×48×8 CRW1 R	Bore-Tite
	48	8	CRW1 V	CR 35×48×8 CRW1 V	Bore-Tite
	50	8	CRW1 R	CR 35×50×8 CRW1 R	Bore-Tite
	50	8	CRW1 V	CR 35×50×8 CRW1 V	Bore-Tite
	52	8	CRWA1 P	CR 35×52×8 CRWA1 P	Bore-Tite
	52	8	CRW1 R	CR 35×52×8 CRW1 R	Bore-Tite
	52	8	CRWA1 R	CR 35×52×8 CRWA1 R	Bore-Tite
	54	7	CRW1 R	CR 35×54×7 CRW1 R	Bore-Tite
	54	8	CRW1 V	CR 35×54×8 CRW1 V	Bore-Tite
	55	8	CRW1 R	CR 35×55×8 CRW1 R	Bore-Tite
	55	8	CRW1 V	CR 35×55×8 CRW1 V	
	56	8	CRW1 R	CR 35×56×8 CRW1 R	Bore-Tite
	56	8	CRW1 V	CR 35×56×8 CRW1 V	Bore-Tite
	58	10	CRW1 R	CR 35×58×10 CRW1 R	Bore-Tite
	62	8	CRW1 V	CR 35×62×8 CRW1 V	Bore-Tite
	62	8	CRW1 R	CR 35×62×8 CRW1 R	Bore-Tite
64	8	CRW1 R	CR 35×64×8 CRW1 R	Bore-Tite	
65	8	CRW1 R	CR 35×65×8 CRW1 R	Bore-Tite	

Series CRW1 – Metric sizes

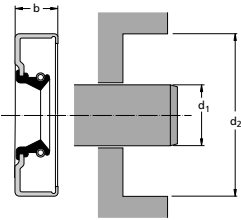

Dimensions			Design and lip material	SKF Designation	
shaft d_1	bore d_2	seal width b			
mm					
35	65	8	CRW1 V	CR 35×65×8 CRW1 V	Bore-Tite
	68	8	CRW1 R	CR 35×68×8 CRW1 R	Bore-Tite
	68	8	CRW1 V	CR 35×68×8 CRW1 V	Bore-Tite
	69	8	CRW1 R	CR 35×69×8 CRW1 R	Bore-Tite
	72	8	CRW1 V	CR 35×72×8 CRW1 V	Bore-Tite
	72	8	CRW1 R	CR 35×72×8 CRW1 R	Bore-Tite
	72	8	CRWA1 R	CR 35×72×8 CRWA1 R	Bore-Tite
	78	8	CRW1 R	CR 35×78×8 CRW1 R	Bore-Tite
	80	8	CRW1 R	CR 35×80×8 CRW1 R	Bore-Tite
	36	50	7	CRW1 R	CR 36×50×7 CRW1 R
50		8	CRW1 R	CR 36×50×8 CRW1 R	Bore-Tite
52		8	CRW1 R	CR 36×52×8 CRW1 R	Bore-Tite
52		8	CRW1 V	CR 36×52×8 CRW1 V	Bore-Tite
54		8	CRW1 R	CR 36×54×8 CRW1 R	Bore-Tite
54		8	CRW1 V	CR 36×54×8 CRW1 V	Bore-Tite
58		8	CRW1 R	CR 36×58×8 CRW1 R	Bore-Tite
60		8	CRW1 R	CR 36×60×8 CRW1 R	Bore-Tite
60		8	CRW1 V	CR 36×60×8 CRW1 V	Bore-Tite
62		8	CRW1 R	CR 36×62×8 CRW1 R	Bore-Tite
65		8	CRW1 R	CR 36×65×8 CRW1 R	Bore-Tite
68		8	CRW1 R	CR 36×68×8 CRW1 R	Bore-Tite
72		8	CRWA1 R	CR 36×72×8 CRWA1 R	Bore-Tite
38		50	7	CRW1 R	CR 38×50×7 CRW1 R
	50	7	CRW1 V	CR 38×50×7 CRW1 V	Bore-Tite
	52	8	CRW1 R	CR 38×52×8 CRW1 R	Bore-Tite
	52	8	CRWA1 R	CR 38×52×8 CRWA1 R	Bore-Tite
	52	8	CRW1 V	CR 38×52×8 CRW1 V	Bore-Tite
	53	8	CRW1 R	CR 38×53×8 CRW1 R	Bore-Tite
	54	7	CRW1 P	CR 38×54×7 CRW1 P	
	55	8	CRW1 R	CR 38×55×8 CRW1 R	Bore-Tite
	55	8	CRW1 V	CR 38×55×8 CRW1 V	Bore-Tite
	56	8	CRW1 V	CR 38×56×8 CRW1 V	Bore-Tite
	56	8	CRW1 R	CR 38×56×8 CRW1 R	Bore-Tite
	58	8	CRW1 R	CR 38×58×8 CRW1 R	Bore-Tite
	58	8	CRW1 V	CR 38×58×8 CRW1 V	Bore-Tite
	60	8	CRW1 R	CR 38×60×8 CRW1 R	Bore-Tite
	60	8	CRW1 V	CR 38×60×8 CRW1 V	Bore-Tite
	62	8	CRW1 R	CR 38×62×8 CRW1 R	Bore-Tite
	62	8	CRWA1 R	CR 38×62×8 CRWA1 R	Bore-Tite

Series CRW1 – Metric sizes

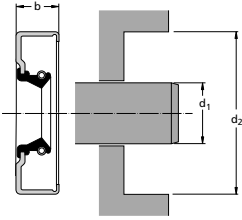

Dimensions			Design and lip material	SKF Designation	
shaft	bore	seal width			
d_1	d_2	b			
mm					
38	62	8	CRW1 V	CR 38×62×8 CRW1 V	Bore-Tite
	65	8	CRW1 R	CR 38×65×8 CRW1 R	Bore-Tite
	68	8	CRW1 R	CR 38×68×8 CRW1 R	Bore-Tite
	70	8	CRW1 R	CR 38×70×8 CRW1 R	Bore-Tite
	72	8	CRW1 R	CR 38×72×8 CRW1 R	Bore-Tite
	73	8	CRW1 R	CR 38×73×8 CRW1 R	Bore-Tite
	74	11	CRWA1 R	CR 38×74×11 CRWA1 R	Bore-Tite
	74	11	CRW1 V	CR 38×74×11 CRW1 V	Bore-Tite
	80	8	CRW1 R	CR 38×80×8 CRW1 R	Bore-Tite
	90	8	CRWA1 R	CR 38×90×8 CRWA1 R	Bore-Tite
	40	52	7	CRW1 V	CR 40×52×7 CRW1 V
52		7	CRW1 R	CR 40×52×7 CRW1 R	Bore-Tite
54		7	CRW1 R	CR 40×54×7 CRW1 R	Bore-Tite
55		8	CRW1 R	CR 40×55×8 CRW1 R	Bore-Tite
55		8	CRW1 V	CR 40×55×8 CRW1 V	Bore-Tite
56		7	CRW1 V	CR 40×56×7 CRW1 V	Bore-Tite
56		8	CRW1 R	CR 40×56×8 CRW1 R	Bore-Tite
57		8	CRW1 R	CR 40×57×8 CRW1 R	Bore-Tite
58		8	CRW1 R	CR 40×58×8 CRW1 R	Bore-Tite
58		8	CRW1 V	CR 40×58×8 CRW1 V	Bore-Tite
60		8	CRW1 R	CR 40×60×8 CRW1 R	Bore-Tite
60		8	CRW1 V	CR 40×60×8 CRW1 V	Bore-Tite
62		8	CRW1 R	CR 40×62×8 CRW1 R	Bore-Tite
62		8	CRW1 V	CR 40×62×8 CRW1 V	Bore-Tite
65		8	CRW1 R	CR 40×65×8 CRW1 R	Bore-Tite
68		8	CRW1 R	CR 40×68×8 CRW1 R	Bore-Tite
70		8	CRW1 R	CR 40×70×8 CRW1 R	Bore-Tite
72		8	CRW1 R	CR 40×72×8 CRW1 R	Bore-Tite
74		8	CRW1 R	CR 40×74×8 CRW1 R	Bore-Tite
75		8	CRW1 V	CR 40×75×8 CRW1 V	Bore-Tite
75	8	CRW1 R	CR 40×75×8 CRW1 R	Bore-Tite	
80	8	CRW1 R	CR 40×80×8 CRW1 R	Bore-Tite	
80	8	CRW1 V	CR 40×80×8 CRW1 V		
90	8	CRW1 R	CR 40×90×8 CRW1 R	Bore-Tite	
41	53	7	CRW1 R	CR 41×53×7 CRW1 R	Bore-Tite
	55	8	CRW1 R	CR 41×55×8 CRW1 R	Bore-Tite
	62	8	CRW1 R	CR 41×62×8 CRW1 R	Bore-Tite

Series CRW1 – Metric sizes

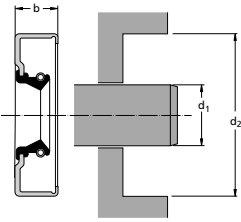

Dimensions			Design and lip material	SKF Designation	
shaft	bore	seal width			
d_1	d_2	b			
mm					
42	55	8	CRW1 R	CR 42×55×8 CRW1 R	Bore-Tite
	55	8	CRW1 V	CR 42×55×8 CRW1 V	Bore-Tite
	56	7	CRW1 V	CR 42×56×7 CRW1 V	Bore-Tite
	56	8	CRW1 R	CR 42×56×8 CRW1 R	Bore-Tite
	58	8	CRW1 R	CR 42×58×8 CRW1 R	Bore-Tite
	58	8	CRW1 V	CR 42×58×8 CRW1 V	Bore-Tite
	60	8	CRW1 R	CR 42×60×8 CRW1 R	Bore-Tite
	60	8	CRW1 V	CR 42×60×8 CRW1 V	Bore-Tite
	62	8	CRW1 R	CR 42×62×8 CRW1 R	Bore-Tite
	62	8	CRW1 V	CR 42×62×8 CRW1 V	Bore-Tite
	65	8	CRW1 R	CR 42×65×8 CRW1 R	Bore-Tite
	65	8	CRW1 V	CR 42×65×8 CRW1 V	Bore-Tite
	72	8	CRW1 V	CR 42×72×8 CRW1 V	Bore-Tite
	72	8	CRW1 R	CR 42×72×8 CRW1 R	Bore-Tite
43	57	8	CRW1 R	CR 43×57×8 CRW1 R	Bore-Tite
	60	8	CRW1 R	CR 43×60×8 CRW1 R	Bore-Tite
	69	8	CRW1 R	CR 43×69×8 CRW1 R	Bore-Tite
	73	8	CRW1 R	CR 43×73×8 CRW1 R	Bore-Tite
44	60	8	CRW1 R	CR 44×60×8 CRW1 R	Bore-Tite
	60	8	CRW1 V	CR 44×60×8 CRW1 V	
	62	8	CRW1 R	CR 44×62×8 CRW1 R	Bore-Tite
	65	8	CRW1 R	CR 44×65×8 CRW1 R	Bore-Tite
	68	8	CRW1 V	CR 44×68×8 CRW1 V	Bore-Tite
	70	8	CRW1 R	CR 44×70×8 CRW1 R	Bore-Tite
	72	8	CRW1 R	CR 44×72×8 CRW1 R	Bore-Tite
45	60	8	CRW1 R	CR 45×60×8 CRW1 R	Bore-Tite
	60	8	CRW1 V	CR 45×60×8 CRW1 V	Bore-Tite
	62	8	CRWA1 V	CR 45×62×8 CRWA1 V	Bore-Tite
	62	8	CRW1 R	CR 45×62×8 CRW1 R	Bore-Tite
	65	8	CRW1 R	CR 45×65×8 CRW1 R	Bore-Tite
	65	8	CRW1 V	CR 45×65×8 CRW1 V	Bore-Tite
	68	8	CRW1 R	CR 45×68×8 CRW1 R	Bore-Tite
	68	8	CRW1 V	CR 45×68×8 CRW1 V	Bore-Tite
	68	8	CRWA1 R	CR 45×68×8 CRWA1 R	Bore-Tite
	70	8	CRW1 R	CR 45×70×8 CRW1 R	Bore-Tite
	72	8	CRW1 V	CR 45×72×8 CRW1 V	Bore-Tite
	72	8	CRW1 R	CR 45×72×8 CRW1 R	Bore-Tite
	75	8	CRW1 R	CR 45×75×8 CRW1 R	Bore-Tite

Series CRW1 – Metric sizes

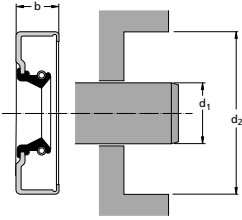

Dimensions shaft	bore	seal width	Design and lip material	SKF Designation	
d_1	d_2	b			
mm					
45	75	8	CRW1 V	CR 45×75×8 CRW1 V	Bore-Tite
	80	8	CRW1 R	CR 45×80×8 CRW1 R	Bore-Tite
	85	8	CRW1 R	CR 45×85×8 CRW1 R	Bore-Tite
46	60	8	CRW1 R	CR 46×60×8 CRW1 R	Bore-Tite
	65	8	CRW1 R	CR 46×65×8 CRW1 R	Bore-Tite
	68	8	CRW1 R	CR 46×68×8 CRW1 R	Bore-Tite
	72	8	CRW1 R	CR 46×72×8 CRW1 R	Bore-Tite
	73	8	CRW1 R	CR 46×73×8 CRW1 R	Bore-Tite
47	60	7	CRW1 R	CR 47×60×7 CRW1 R	Bore-Tite
	62	8	CRW1 R	CR 47×62×8 CRW1 R	Bore-Tite
	72	8	CRW1 R	CR 47×72×8 CRW1 R	Bore-Tite
48	62	8	CRW1 R	CR 48×62×8 CRW1 R	Bore-Tite
	62	8	CRW1 P	CR 48×62×8 CRW1 P	Bore-Tite
	65	8	CRW1 R	CR 48×65×8 CRW1 R	Bore-Tite
	65	8	CRW1 V	CR 48×65×8 CRW1 V	Bore-Tite
	68	8	CRW1 R	CR 48×68×8 CRW1 R	Bore-Tite
	68	8	CRW1 V	CR 48×68×8 CRW1 V	Bore-Tite
	70	8	CRW1 R	CR 48×70×8 CRW1 R	Bore-Tite
	70	8	CRW1 V	CR 48×70×8 CRW1 V	Bore-Tite
	72	8	CRW1 R	CR 48×72×8 CRW1 R	Bore-Tite
	72	8	CRW1 V	CR 48×72×8 CRW1 V	Bore-Tite
	80	8	CRW1 R	CR 48×80×8 CRW1 R	Bore-Tite
	82	8	CRWA1 R	CR 48×82×8 CRWA1 R	Bore-Tite
	90	8	CRW1 R	CR 48×90×8 CRW1 R	Bore-Tite
50	65	8	CRW1 R	CR 50×65×8 CRW1 R	Bore-Tite
	65	8	CRW1 V	CR 50×65×8 CRW1 V	Bore-Tite
	68	8	CRW1 R	CR 50×68×8 CRW1 R	Bore-Tite
	68	8	CRW1 V	CR 50×68×8 CRW1 V	Bore-Tite
	70	8	CRW1 R	CR 50×70×8 CRW1 R	Bore-Tite
	70	8	CRW1 V	CR 50×70×8 CRW1 V	Bore-Tite
	72	8	CRW1 R	CR 50×72×8 CRW1 R	Bore-Tite
	72	8	CRW1 V	CR 50×72×8 CRW1 V	Bore-Tite
	75	8	CRWA1 R	CR 50×75×8 CRWA1 R	Bore-Tite
	80	8	CRW1 R	CR 50×80×8 CRW1 R	Bore-Tite
	80	8	CRW1 V	CR 50×80×8 CRW1 V	Bore-Tite
	82	8	CRWA1 R	CR 50×82×8 CRWA1 R	Bore-Tite
	85	8	CRW1 R	CR 50×85×8 CRW1 R	Bore-Tite
	90	8	CRW1 R	CR 50×90×8 CRW1 R	Bore-Tite
	90	8	CRW1 V	CR 50×90×8 CRW1 V	Bore-Tite

Series CRW1 – Metric sizes

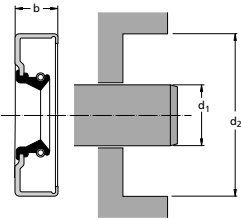

Dimensions			Design and lip material	SKF Designation	
shaft	bore	seal width			
d_1	d_2	b			
mm					
51	65	7	CRWA1 R	CR 51×65×7 CRWA1 R	Bore-Tite
	73	8	CRW1 R	CR 51×73×8 CRW1 R	Bore-Tite
	73	8	CRWA1 R	CR 51×73×8 CRWA1 R	Bore-Tite
	80	9,53	CRW1 R	CR 51×80×9,53 CRW1 R	Bore-Tite
	81	9,53	CRWH1 R	CR 51×81×9,53 CRWH1 R	Bore-Tite
	81	9,53	CRWHA1 R	CR 51×81×9,53 CRWHA1 R	Bore-Tite
	90	11,13	CRWH1 R	CR 51×90×11,13 CRWH1 R	Bore-Tite
	92	11,13	CRWH1 R	CR 51×92×11,13 CRWH1 R	Bore-Tite
	52	68	8	CRW1 R	CR 52×68×8 CRW1 R
68		8	CRW1 V	CR 52×68×8 CRW1 V	Bore-Tite
70		8	CRW1 R	CR 52×70×8 CRW1 R	Bore-Tite
72		8	CRWA1 V	CR 52×72×8 CRWA1 V	Bore-Tite
72		8	CRW1 R	CR 52×72×8 CRW1 R	Bore-Tite
72		8	CRW1 V	CR 52×72×8 CRW1 V	Bore-Tite
85		8	CRW1 R	CR 52×85×8 CRW1 R	Bore-Tite
53		68	8	CRW1 V	CR 53×68×8 CRW1 V
54	65	8	CRW1 R	CR 54×65×8 CRW1 R	Bore-Tite
	65	8	CRW1 V	CR 54×65×8 CRW1 V	Bore-Tite
	68	8	CRW1 V	CR 54×68×8 CRW1 V	Bore-Tite
	73	11,13	CRW1 R	CR 54×73×11,13 CRW1 R	Bore-Tite
	73	11,13	CRWA1 R	CR 54×73×11,13 CRWA1 R	Bore-Tite
	81	9,53	CRWA1 R	CR 54×81×9,53 CRWA1 R	Bore-Tite
55	70	8	CRW1 R	CR 55×70×8 CRW1 R	Bore-Tite
	70	8	CRW1 V	CR 55×70×8 CRW1 V	Bore-Tite
	72	8	CRW1 R	CR 55×72×8 CRW1 R	Bore-Tite
	72	8	CRW1 V	CR 55×72×8 CRW1 V	Bore-Tite
	73	8	CRW1 V	CR 55×73×8 CRW1 V	Bore-Tite
	75	8	CRW1 R	CR 55×75×8 CRW1 R	Bore-Tite
	75	8	CRW1 V	CR 55×75×8 CRW1 V	Bore-Tite
	80	8	CRW1 R	CR 55×80×8 CRW1 R	Bore-Tite
	80	8	CRW1 V	CR 55×80×8 CRW1 V	Bore-Tite
	85	8	CRW1 R	CR 55×85×8 CRW1 R	Bore-Tite
	90	8	CRW1 R	CR 55×90×8 CRW1 R	Bore-Tite
	100	8	CRW1 R	CR 55×100×8 CRW1 R	Bore-Tite
	56	75	8	CRW1 R	CR 56×75×8 CRW1 R

Series CRW1 – Metric sizes

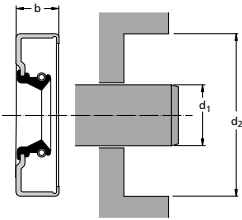

Dimensions			Design and lip material	SKF Designation	
shaft	bore	seal width			
d_1	d_2	b			
mm					
57	81	11	CRW1 R	CR 57×81×11 CRW1 R	Bore-Tite
	81	11	CRWA1 P	CR 57×81×11 CRWA1 P	Bore-Tite
	92	11	CRWH1 R	CR 57×92×11 CRWH1 R	Bore-Tite
	92	11	CRWHA1 R	CR 57×92×11 CRWHA1 R	Bore-Tite
	110	9,5	CRW1 R	CR 57×110×9,5 CRW1 R	Bore-Tite
58	72	8	CRW1 R	CR 58×72×8 CRW1 R	Bore-Tite
	72	8	CRW1 S	CR 58×72×8 CRW1 S	Bore-Tite
	75	8	CRW1 R	CR 58×75×8 CRW1 R	Bore-Tite
	80	8	CRW1 R	CR 58×80×8 CRW1 R	Bore-Tite
	80	8	CRW1 V	CR 58×80×8 CRW1 V	Bore-Tite
	85	8	CRW1 R	CR 58×85×8 CRW1 R	Bore-Tite
	90	8	CRW1 R	CR 58×90×8 CRW1 R	Bore-Tite
60	75	8	CRW1 R	CR 60×75×8 CRW1 R	Bore-Tite
	75	8	CRW1 V	CR 60×75×8 CRW1 V	Bore-Tite
	80	8	CRW1 R	CR 60×80×8 CRW1 R	Bore-Tite
	80	8	CRW1 V	CR 60×80×8 CRW1 V	Bore-Tite
	82	8	CRWA1 R	CR 60×82×8 CRWA1 R	Bore-Tite
	85	8	CRW1 V	CR 60×85×8 CRW1 V	Bore-Tite
	85	8	CRW1 R	CR 60×85×8 CRW1 R	Bore-Tite
	90	8	CRW1 R	CR 60×90×8 CRW1 R	Bore-Tite
	95	10	CRW1 R	CR 60×95×10 CRW1 R	Bore-Tite
	105	8	CRW1 R	CR 60×105×8 CRW1 R	Bore-Tite
	110	8	CRW1 R	CR 60×110×8 CRW1 R	Bore-Tite
62	80	8	CRW1 R	CR 62×80×8 CRW1 R	Bore-Tite
	80	8	CRW1 V	CR 62×80×8 CRW1 V	Bore-Tite
	85	8	CRW1 R	CR 62×85×8 CRW1 R	Bore-Tite
	90	8	CRW1 R	CR 62×90×8 CRW1 R	Bore-Tite
	90	11,13	CRWH1 R	CR 62×90×11,13 CRWH1 R	Bore-Tite
63	78	8	CRW1 R	CR 63×78×8 CRW1 R	Bore-Tite
	80	8	CRW1 R	CR 63×80×8 CRW1 R	Bore-Tite
	85	8	CRW1 R	CR 63×85×8 CRW1 R	Bore-Tite
	88	8	CRW1 R	CR 63×88×8 CRW1 R	Bore-Tite
	90	8	CRW1 R	CR 63×90×8 CRW1 R	Bore-Tite
65	80	8	CRW1 R	CR 65×80×8 CRW1 R	Bore-Tite
	80	8	CRW1 V	CR 65×80×8 CRW1 V	Bore-Tite
	85	8	CRW1 R	CR 65×85×8 CRW1 R	Bore-Tite
	85	8	CRW1 V	CR 65×85×8 CRW1 V	Bore-Tite

Series CRW1 – Metric sizes

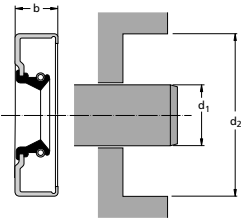

Dimensions			Design and lip material	SKF Designation		
shaft d_1	bore d_2	seal width b				
mm						
65	88	8	CRW1 R	CR 65×88×8 CRW1 R	Bore-Tite	
	90	8	CRW1 R	CR 65×90×8 CRW1 R	Bore-Tite	
	90	8	CRW1 V	CR 65×90×8 CRW1 V	Bore-Tite	
	92	11,13	CRWH1 R	CR 65×92×11,13 CRWH1 R	Bore-Tite	
	95	10	CRW1 R	CR 65×95×10 CRW1 R	Bore-Tite	
	100	8	CRW1 R	CR 65×100×8 CRW1 R	Bore-Tite	
	100	8	CRW1 V	CR 65×100×8 CRW1 V	Bore-Tite	
	110	10	CRW1 R	CR 65×110×10 CRW1 R	Bore-Tite	
	120	8	CRW1 R	CR 65×120×8 CRW1 R	Bore-Tite	
	68	85	8	CRW1 R	CR 68×85×8 CRW1 R	Bore-Tite
		88	8	CRW1 R	CR 68×88×8 CRW1 R	Bore-Tite
90		8	CRW1 R	CR 68×90×8 CRW1 R	Bore-Tite	
90		8	CRW1 V	CR 68×90×8 CRW1 V	Bore-Tite	
95		10	CRW1 R	CR 68×95×10 CRW1 R	Bore-Tite	
95		10	CRW1 V	CR 68×95×10 CRW1 V	Bore-Tite	
100		10	CRW1 R	CR 68×100×10 CRW1 R	Bore-Tite	
70		85	8	CRW1 R	CR 70×85×8 CRW1 R	Bore-Tite
	88	8	CRW1 R	CR 70×88×8 CRW1 R	Bore-Tite	
	88	8	CRW1 V	CR 70×88×8 CRW1 V	Bore-Tite	
	90	8	CRW1 R	CR 70×90×8 CRW1 R	Bore-Tite	
	90	10	CRW1 V	CR 70×90×10 CRW1 V	Bore-Tite	
	90	10	CRWHA1 P	CR 70×90×10 CRWHA1 P	Bore-Tite	
	92	11	CRWH1 R	CR 70×92×11 CRWH1 R	Bore-Tite	
	92	11	CRWH1 V	CR 70×92×11 CRWH1 V	Bore-Tite	
	95	10	CRW1 R	CR 70×95×10 CRW1 R	Bore-Tite	
	100	10	CRW1 R	CR 70×100×10 CRW1 R	Bore-Tite	
	105	10	CRW1 R	CR 70×105×10 CRW1 R	Bore-Tite	
	110	10	CRW1 R	CR 70×110×10 CRW1 R	Bore-Tite	
	110	12,7	CRWHA1 R	CR 70×110×12,7 CRWHA1 R	Bore-Tite	
72	88	8	CRW1 R	CR 72×88×8 CRW1 R	Bore-Tite	
73	92	11,13	CRWH1 R	CR 73×92×11,13 CRWH1 R	Bore-Tite	
	110	11,13	CRWA1 P	CR 73×110×11,13 CRWA1 P	Bore-Tite	
75	90	8	CRW1 R	CR 75×90×8 CRW1 R	Bore-Tite	
	95	10	CRW1 R	CR 75×95×10 CRW1 R	Bore-Tite	
	95	10	CRW1 V	CR 75×95×10 CRW1 V	Bore-Tite	
	100	10	CRW1 R	CR 75×100×10 CRW1 R	Bore-Tite	
	100	10	CRW1 V	CR 75×100×10 CRW1 V	Bore-Tite	

Series CRW1 – Metric sizes

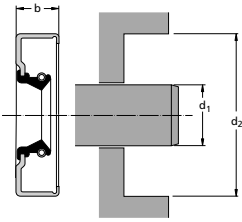

Dimensions			Design and lip material	SKF Designation	
shaft	bore	seal width			
d_1	d_2	b			
mm					
75	105	10	CRW1 R	CR 75×105×10 CRW1 R	Bore-Tite
	110	10	CRW1 R	CR 75×110×10 CRW1 R	Bore-Tite
	115	12	CRW1 R	CR 75×115×12 CRW1 R	Bore-Tite
80	100	10	CRW1 R	CR 80×100×10 CRW1 R	Bore-Tite
	100	10	CRW1 V	CR 80×100×10 CRW1 V	Bore-Tite
	105	10	CRW1 R	CR 80×105×10 CRW1 R	Bore-Tite
	105	10	CRW1 V	CR 80×105×10 CRW1 V	Bore-Tite
	110	10	CRW1 R	CR 80×110×10 CRW1 R	Bore-Tite
	120	10	CRW1 R	CR 80×120×10 CRW1 R	Bore-Tite
	125	10	CRW1 R	CR 80×125×10 CRW1 R	Bore-Tite
	125	10	CRW1 V	CR 80×125×10 CRW1 V	Bore-Tite
	130	12	CRWA1 R	CR 80×130×12 CRWA1 R	Bore-Tite
	140	12	CRW1 R	CR 80×140×12 CRW1 R	Bore-Tite
84	127	11	CRWH1 R	CR 84×127×11 CRWH1 R	Bore-Tite
85	105	10	CRW1 R	CR 85×105×10 CRW1 R	Bore-Tite
	105	10	CRW1 V	CR 85×105×10 CRW1 V	Bore-Tite
	110	10	CRW1 R	CR 85×110×10 CRW1 R	Bore-Tite
	110	10	CRWA1 V	CR 85×110×10 CRWA1 V	Bore-Tite
	120	12	CRW1 R	CR 85×120×12 CRW1 R	Bore-Tite
	125	12	CRW1 R	CR 85×125×12 CRW1 R	Bore-Tite
	130	12	CRW1 R	CR 85×130×12 CRW1 R	Bore-Tite
89	127	11,13	CRWH1 R	CR 89×127×11,13 CRWH1 R	Bore-Tite
89	127	11,13	CRWHA1 P	CR 89×127×11,13 CRWHA1 P	Bore-Tite
90	110	12	CRW1 R	CR 90×110×12 CRW1 R	Bore-Tite
	110	12	CRW1 V	CR 90×110×12 CRW1 V	Bore-Tite
	115	12	CRWA1 R	CR 90×115×12 CRWA1 R	Bore-Tite
	120	12	CRW1 R	CR 90×120×12 CRW1 R	Bore-Tite
	120	12	CRW1 V	CR 90×120×12 CRW1 V	Bore-Tite
	125	12	CRW1 R	CR 90×125×12 CRW1 R	Bore-Tite
	125	12	CRW1 V	CR 90×125×12 CRW1 V	Bore-Tite
	130	12	CRW1 R	CR 90×130×12 CRW1 R	Bore-Tite
	140	12	CRWA1 R	CR 90×140×12 CRWA1 R	Bore-Tite
92	127	11	CRWHA1 R	CR 92×127×11 CRWHA1 R	Bore-Tite
	127	11,13	CRWH1 R	CR 92×127×11,13 CRWH1 R	Bore-Tite

Series CRW1 – Metric sizes

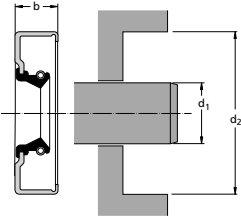

Dimensions			Design and lip material	SKF Designation	
shaft d_1	bore d_2	seal width b			
mm					
95	110	10	CRW1 R	CR 95×110×10 CRW1 R	Bore-Tite
	115	12	CRW1 R	CR 95×115×12 CRW1 R	Bore-Tite
	115	12	CRW1 V	CR 95×115×12 CRW1 V	Bore-Tite
	120	12	CRW1 R	CR 95×120×12 CRW1 R	Bore-Tite
	120	12	CRW1 V	CR 95×120×12 CRW1 V	Bore-Tite
	120	12	CRWA1 V	CR 95×120×12 CRWA1 V	Bore-Tite
	125	12	CRW1 R	CR 95×125×12 CRW1 R	Bore-Tite
	130	12	CRW1 R	CR 95×130×12 CRW1 R	Bore-Tite
	130	12	CRW1 V	CR 95×130×12 CRW1 V	Bore-Tite
	120	12	CRW1 V	CR 98×120×12 CRW1 V	Bore-Tite
	124	9,53	CRW1 R	CR 99×124×9,53 CRW1 R	Bore-Tite
	100	120	12	CRW1 R	CR 100×120×12 CRW1 R
120		12	CRW1 V	CR 100×120×12 CRW1 V	Bore-Tite
125		12	CRW1 R	CR 100×125×12 CRW1 R	Bore-Tite
125		12	CRW1 V	CR 100×125×12 CRW1 V	Bore-Tite
127		11,13	CRWH1 R	CR 100×127×11,13 CRWH1 R	Bore-Tite
130		12	CRW1 R	CR 100×130×12 CRW1 R	Bore-Tite
135		12	CRWA1 R	CR 100×135×12 CRWA1 R	Bore-Tite
140		12	CRWA1 R	CR 100×140×12 CRWA1 R	Bore-Tite
102	130	11	CRWH1 R	CR 102×130×11 CRWH1 R	Bore-Tite
105	127	11,13	CRWH1 R	CR 105×127×11,13 CRWH1 R	Bore-Tite
	130	12	CRW1 R	CR 105×130×12 CRW1 R	Bore-Tite
	130	12	CRW1 V	CR 105×130×12 CRW1 V	Bore-Tite
	135	12	CRWA1 R	CR 105×135×12 CRWA1 R	Bore-Tite
	140	12	CRWA1 R	CR 105×140×12 CRWA1 R	Bore-Tite
	160	12	CRW1 R	CR 105×160×12 CRW1 R	Bore-Tite
110	130	12	CRW1 R	CR 110×130×12 CRW1 R	Bore-Tite
	130	12	CRW1 V	CR 110×130×12 CRW1 V	Bore-Tite
	135	12	CRW1 V	CR 110×135×12 CRW1 V	Bore-Tite
	140	12	CRW1 V	CR 110×140×12 CRW1 V	Bore-Tite
	140	12	CRW1 R	CR 110×140×12 CRW1 R	Bore-Tite
	145	12	CRW1 R	CR 110×145×12 CRW1 R	Bore-Tite
	160	12	CRWH1 R	CR 110×160×12 CRWH1 R	Bore-Tite

Series CRW1 – Metric sizes

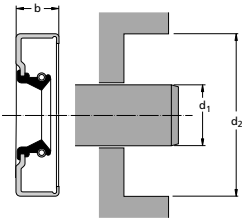

Dimensions			Design and lip material	SKF Designation	
shaft	bore	seal width			
d_1	d_2	b			
mm					
115	135	12	CRW1 R	CR 115×135×12 CRW1 R	Bore-Tite
	140	12	CRW1 R	CR 115×140×12 CRW1 R	Bore-Tite
	140	12	CRW1 R	CR 115×140×12 CRW1 R	
	140	12	CRW1 V	CR 115×140×12 CRW1 V	Bore-Tite
	145	12	CRW1 R	CR 115×145×12 CRW1 R	Bore-Tite
	150	12	CRW1 R	CR 115×150×12 CRW1 R	Bore-Tite
	160	12	CRW1 R	CR 115×160×12 CRW1 R	Bore-Tite
120	140	12	CRWA1 R	CR 120×140×12 CRWA1 R	Bore-Tite
	145	12	CRW1 R	CR 120×145×12 CRW1 R	Bore-Tite
	150	12	CRW1 R	CR 120×150×12 CRW1 R	Bore-Tite
	150	12	CRW1 V	CR 120×150×12 CRW1 V	Bore-Tite
	160	12	CRWH1 R	CR 120×160×12 CRWH1 R	Bore-Tite
125	150	12	CRW1 R	CR 125×150×12 CRW1 R	Bore-Tite
	150	12	CRW1 V	CR 125×150×12 CRW1 V	Bore-Tite
	160	12	CRW1 R	CR 125×160×12 CRW1 R	Bore-Tite
130	160	12	CRW1 R	CR 130×160×12 CRW1 R	Bore-Tite
	160	12	CRW1 V	CR 130×160×12 CRW1 V	Bore-Tite
	170	12	CRW1 R	CR 130×170×12 CRW1 R	Bore-Tite
140	160	12	CRW1 R	CR 140×160×12 CRW1 R	Bore-Tite
	170	12	CRW1 R	CR 140×170×12 CRW1 R	Bore-Tite
	170	12	CRW1 V	CR 140×170×12 CRW1 V	
143	181	12,7	CRWHA1 R	CR 143×181×12,7 CRWHA1 R	Bore-Tite
160	190	15	CRW1 V	CR 160×190×15 CRW1 V	Bore-Tite
162	200	14,3	CRWHA1 R	CR 162×200×14,3 CRWHA1 R	Bore-Tite
	200	15,88	CRWH1 R	CR 162×200×15,88 CRWH1 R	Bore-Tite
188	215	16	CRWH1 R	CR 188×215×16 CRWH1 R	Bore-Tite
203	254	15,88	CRWH1 R	CR 203×254×15,88 CRWH1 R	Bore-Tite
	254	15,88	CRWHA1 R	CR 203×254×15,88 CRWHA1 R	
216	254	15,88	CRWH1 R	CR 216×254×15,88 CRWH1 R	Bore-Tite
220	250	16	CRWH1 R	CR 220×250×16 CRWH1 R	Bore-Tite
280	320	20	CRWA1 R	CR 280×320×20 CRWA1 R	Bore-Tite
	320	20	CRWA1 V	CR 280×320×20 CRWA1 V	Bore-Tite

Series CRW1 – Inch sizes

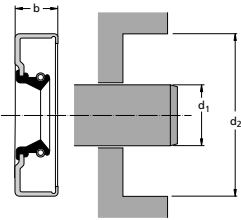

Dimensions		seal width b	Design and lip material	SKF Designation	
shaft d ₁	bore d ₂				
in					
.250	.749	.250	CRW1 V	CR 2513	
	.749	.250	CRW1 R	CR 2514	Bore-Tite
.375	.749	.250	CRW1 R	CR 3687	
	.749	.250	CRW1 V	CR 3688	Bore-Tite
	.750	.250	CRWA1 R	CR 3680	Bore-Tite
	.836	.188	CRW1 P	CR 3719	Bore-Tite
	.875	.250	CRW1 R	CR 3725	Bore-Tite
	.999	.250	CRW1 R	CR 3751	
	.999	.250	CRW1 V	CR 3752	Bore-Tite
	1.124	.250	CRW1 R	CR 3806	
.438	.875	.250	CRW1 P	CR 4249	Bore-Tite
	.875	.250	CRW1 R	CR 4251	
	.875	.375	CRWA1 R	CR 4261	
	.875	.375	CRWA1 V	CR 4262	Bore-Tite
	.999	.250	CRW1 V	CR 4356	Bore-Tite
	.999	.375	CRW1 P	CR 4353	Bore-Tite
	.999	.375	CRW1 R	CR 4355	Bore-Tite
	1.124	.250	CRW1 R	CR 4390	Bore-Tite
	.500	.875	.250	CRW1 R	CR 4931
.875		.250	CRW1 V	CR 4932	Bore-Tite
.875		.250	CRWA1 V	CR 4933	Bore-Tite
.875		.250	CRWA1 V	CR 4935	Bore-Tite
.875		.250	CRW1 D	CR 4936	Bore-Tite
.875		.313	CRWA1 R	CR 4939	Bore-Tite
.987		.250	CRW1 R	CR 4943	Bore-Tite
.999		.250	CRW1 V	CR 4980	Bore-Tite
.999		.250	CRW1 R	CR 4984	Bore-Tite
.999		.250	CRWA1 R	CR 4985	Bore-Tite
1.124		.250	CRW1 P	CR 5045	Bore-Tite
1.124		.250	CRWA1 R	CR 5062	Bore-Tite
1.124		.250	CRW1 V	CR 5066	Bore-Tite
1.124		.250	CRWA1 V	CR 5067	Bore-Tite
1.124		.250	CRW1 R	CR 5068	Bore-Tite
1.124		.313	CRW1 P	CR 5046	Bore-Tite
1.250		.250	CRW1 R	CR 5133	Bore-Tite
1.375	.250	CRW1 R	CR 5150	Bore-Tite	
1.375	.250	CRW1 V	CR 5151	Bore-Tite	

Series CRW1 – Inch sizes

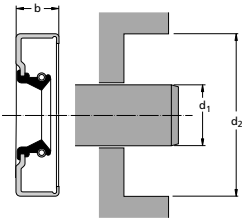

Dimensions		seal width b	Design and lip material	SKF Designation	
shaft d ₁	bore d ₂				
in					
.531	.999	.250	CRWA1 S	CR 5321	Bore-Tite
.546	.875	.250	CRW1 P	CR 5385	
.554	.999	.250	CRW1 R	CR 5605	Bore-Tite
.563	.875	.188	CRW1 D	CR 5523	Bore-Tite
	.999	.250	CRW1 R	CR 5541	Bore-Tite
	.999	.250	CRW1 V	CR 5542	Bore-Tite
	.999	.250	CRW1 R	CR 5543	Bore-Tite
	.999	.250	CRWA1 R	CR 5606	Bore-Tite
	1.124	.250	CRW1 V	CR 5650	Bore-Tite
	1.124	.250	CRW1 R	CR 5652	Bore-Tite
	1.124	.250	CRWA1 R	CR 5662	Bore-Tite
	1.250	.250	CRW1 R	CR 5707	Bore-Tite
	1.375	.250	CRW1 R	CR 5756	Bore-Tite
.594	1.124	.313	CRW1 R	CR 5926	Bore-Tite
	1.124	.313	CRW1 V	CR 5927	Bore-Tite
.625	.987	.250	CRW1 R	CR 6134	Bore-Tite
	.999	.250	CRWA1 V	CR 6139	Bore-Tite
	.999	.250	CRWA1 R	CR 6141	Bore-Tite
	.999	.250	CRW1 R	CR 6143	Bore-Tite
	1.063	.250	CRW1 R	CR 6157	Bore-Tite
	1.124	.250	CRW1 R	CR 6203	Bore-Tite
	1.124	.250	CRWA1 R	CR 6204	Bore-Tite
	1.124	.250	CRW1 V	CR 6213	Bore-Tite
	1.124	.250	CRWA1 V	CR 6215	Bore-Tite
	1.181	.250	CRWA1 R	CR 6247	Bore-Tite
	1.181	.256	CRWA1 V	CR 6248	Bore-Tite
	1.250	.250	CRW1 V	CR 6309	Bore-Tite
	1.250	.250	CRW1 R	CR 6315	Bore-Tite
	1.250	.250	CRWA1 R	CR 6316	Bore-Tite
	1.375	.250	CRW1 R	CR 6372	Bore-Tite
	1.375	.250	CRWA1 R	CR 6373	Bore-Tite
	1.375	.250	CRW1 V	CR 6379	Bore-Tite
	1.375	.250	CRWA1 V	CR 6383	Bore-Tite
	1.377	.250	CRWHA1 R	CR 6391	Bore-Tite
	1.499	.250	CRW1 R	CR 6386	Bore-Tite

Series CRW1 – Inch sizes

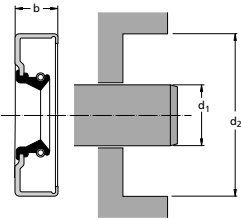

Dimensions					
shaft	bore	seal width	Design and	SKF Designation	
d_1	d_2	b	lip material		
in					
.656	1.124	.313	CRW1 R	CR 6521	Bore-Tite
	1.250	.250	CRW1 R	CR 6541	Bore-Tite
	1.375	.313	CRW1 R	CR 6556	Bore-Tite
	1.575	.250	CRW1 R	CR 6580	Bore-Tite
.669	.999	.188	CRW1 R	CR 6595	Bore-Tite
	1.064	.250	CRW1 R	CR 6728	Bore-Tite
	1.064	.250	CRW1 R	CR 6729	Bore-Tite
	1.573	.281	CRW1 V	CR 6597	
.688	1.124	.190	CRW1 R	CR 6738	Bore-Tite
	1.124	.250	CRW1 R	CR 6741	Bore-Tite
	1.124	.250	CRW1 R	CR 6743	Bore-Tite
	1.124	.250	CRW1 V	CR 6745	Bore-Tite
	1.187	.188	CRW1 V	CR 6770	Bore-Tite
	1.188	.188	CRW1 R	CR 6763	Bore-Tite
	1.250	.250	CRWA1 R	CR 6765	Bore-Tite
	1.250	.256	CRWHA1 V	CR 6751	Bore-Tite
	1.250	.313	CRW1 R	CR 6767	Bore-Tite
	1.250	.313	CRW1 V	CR 6768	Bore-Tite
	1.252	.220	CRWH1 V	CR 6769	Bore-Tite
	1.375	.250	CRWA1 R	CR 6814	Bore-Tite
	1.375	.313	CRW1 R	CR 6816	Bore-Tite
	1.375	.313	CRW1 V	CR 6817	Bore-Tite
	1.499	.250	CRW1 R	CR 6935	Bore-Tite
1.624	.250	CRWA1 R	CR 6990	Bore-Tite	
.750	1.124	.188	CRW1 R	CR 7414	Bore-Tite
	1.124	.188	CRW1 V	CR 7417	Bore-Tite
	1.249	.188	CRW1 V	CR 7467	
	1.250	.188	CRW1 R	CR 7439	Bore-Tite
	1.250	.188	CRW1 R	CR 7478	
	1.250	.250	CRW1 R	CR 7438	Bore-Tite
	1.250	.250	CRW1 R	CR 7440	Bore-Tite
	1.250	.250	CRWA1 R	CR 7443	Bore-Tite
	1.250	.250	CRW1 V	CR 7450	Bore-Tite
	1.250	.250	CRWA1 V	CR 7453	Bore-Tite
	1.250	.250	CRWA1 V	CR 7455	Bore-Tite
	1.252	.188	CRW1 R	CR 7469	Bore-Tite
	1.260	.250	CRW1 R	CR 7473	Bore-Tite
	1.312	.250	CRW1 R	CR 7474	Bore-Tite

Series CRW1 – Inch sizes

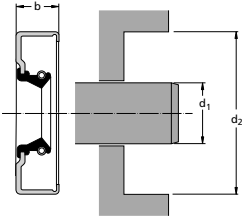

Dimensions		seal width b	Design and lip material	SKF Designation	
shaft d ₁	bore d ₂				
in					
.750	1.312	.250	CRWA1 R	CR 7475	Bore-Tite
	1.375	.250	CRW1 R	CR 7512	Bore-Tite
	1.375	.250	CRWA1 R	CR 7513	Bore-Tite
	1.375	.250	CRW1 V	CR 7515	Bore-Tite
	1.375	.250	CRWA1 V	CR 7517	Bore-Tite
	1.375	.250	CRWA1 P	CR 7533	Bore-Tite
	1.499	.250	CRW1 V	CR 7567	Bore-Tite
	1.499	.250	CRW1 R	CR 7572	
	1.499	.250	CRWA1 R	CR 7573	Bore-Tite
	1.575	.250	CRW1 R	CR 7591	Bore-Tite
	1.624	.250	CRW1 V	CR 7623	Bore-Tite
	1.624	.250	CRWA1 V	CR 7624	Bore-Tite
	1.624	.250	CRW1 R	CR 7627	Bore-Tite
	1.624	.250	CRWA1 R	CR 7628	Bore-Tite
	1.752	.250	CRW1 R	CR 7636	Bore-Tite
	1.752	.250	CRWA1 V	CR 7638	Bore-Tite
	1.828	.250	CRW1 R	CR 7661	Bore-Tite
	1.874	.250	CRW1 R	CR 7690	Bore-Tite
	2.047	.313	CRW1 R	CR 7693	Bore-Tite
	.781	1.375	.313	CRW1 V	CR 7824
1.375		.313	CRW1 R	CR 7829	
1.499		.313	CRW1 R	CR 7849	Bore-Tite
1.624		.313	CRW1 R	CR 7872	Bore-Tite
1.828		.250	CRW1 P	CR 7889	Bore-Tite
.787	1.124	.188	CRW1 R	CR 7740	Bore-Tite
.813	1.187	.313	CRWA1 V	CR 8013	Bore-Tite
	1.250	.188	CRW1 R	CR 8017	
	1.250	.188	CRW1 P	CR 8018	Bore-Tite
	1.312	.250	CRW1 R	CR 8027	Bore-Tite
	1.375	.375	CRW1 V	CR 8053	Bore-Tite
	1.375	.375	CRW1 R	CR 8060	Bore-Tite
	1.499	.250	CRW1 R	CR 8088	
	1.624	.250	CRW1 V	CR 8178	Bore-Tite
	1.752	.375	CRW1 R	CR 8215	Bore-Tite
.875	1.250	.188	CRW1 R	CR 8624	Bore-Tite
	1.250	.250	CRW1 V	CR 8621	Bore-Tite
	1.308	.250	CRW1 V	CR 8649	Bore-Tite

Series CRW1 – Inch sizes

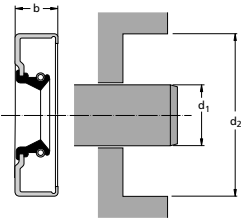

Dimensions		seal width b	Design and lip material	SKF Designation	
shaft d ₁	bore d ₂				
in					
.875	1.375	.250	CRW1 V	CR 8646	Bore-Tite
	1.375	.250	CRW1 R	CR 8648	Bore-Tite
	1.437	.250	CRW1 R	CR 8691	Bore-Tite
	1.499	.250	CRW1 R	CR 8700	Bore-Tite
	1.499	.250	CRWA1 R	CR 8702	Bore-Tite
	1.499	.250	CRW1 V	CR 8704	Bore-Tite
	1.499	.250	CRWA1 V	CR 8707	Bore-Tite
	1.499	.313	CRW1 R	CR 8703	
	1.502	.313	CRWA1 R	CR 8748	Bore-Tite
	1.575	.250	CRW1 R	CR 8763	Bore-Tite
	1.624	.250	CRWA1 R	CR 8782	Bore-Tite
	1.624	.250	CRW1 V	CR 8795	Bore-Tite
	1.624	.250	CRW1 R	CR 8796	Bore-Tite
	1.752	.250	CRW1 R	CR 8821	Bore-Tite
	1.828	.250	CRW1 R	CR 8842	Bore-Tite
	1.874	.250	CRW1 R	CR 8860	Bore-Tite
	2.000	.250	CRW1 R	CR 8870	Bore-Tite
	2.050	.375	CRWH1 V	CR 8871	Bore-Tite
.882	2.088	.313	CRWHA1 R	CR 9000	Bore-Tite
.938	1.375	.250	CRWA1 R	CR 9244	Bore-Tite
	1.500	.250	CRW1 R	CR 9303	Bore-Tite
	1.500	.250	CRW1 V	CR 9304	Bore-Tite
	1.624	.250	CRW1 R	CR 9307	Bore-Tite
	1.624	.250	CRW1 V	CR 9308	Bore-Tite
	1.752	.250	CRW1 R	CR 9347	Bore-Tite
	1.828	.250	CRW1 R	CR 9409	Bore-Tite
.950	1.358	.275	CRW1 P	CR 9520	Bore-Tite
.969	1.406	.250	CRWA1 P	CR 9604	Bore-Tite
	1.499	.313	CRW1 V	CR 9611	Bore-Tite
	1.499	.313	CRW1 R	CR 9613	
	1.624	.250	CRW1 R	CR 9646	Bore-Tite
	1.624	.250	CRW1 V	CR 9647	Bore-Tite
	1.686	.313	CRWA1 R	CR 9663	Bore-Tite
	1.686	.313	CRW1 R	CR 9664	Bore-Tite
	1.752	.250	CRW1 R	CR 9667	Bore-Tite
	1.828	.313	CRW1 R	CR 9681	Bore-Tite

Series CRW1 – Inch sizes

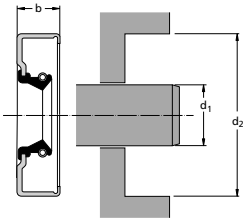

Dimensions		seal width b	Design and lip material	SKF Designation	
shaft d ₁	bore d ₂				
in					
.981	1.376	.313	CRW1 V	CR 9888	
.984	1.499	.250	CRW1 V	CR 9686	Bore-Tite
	1.749	.375	CRWA1 V	CR 9803	
1.000	1.367	.313	CRW1 R	CR 9822	Bore-Tite
	1.375	.250	CRW1 P	CR 9826	
	1.375	.250	CRW1 V	CR 9831	Bore-Tite
	1.437	.250	CRW1 V	CR 9833	Bore-Tite
	1.437	.250	CRW1 R	CR 9837	Bore-Tite
	1.437	.250	CRWA1 R	CR 9838	Bore-Tite
	1.437	.250	CRWA1 V	CR 9847	Bore-Tite
	1.496	.390	CRW1 R	CR 9850	Bore-Tite
	1.499	.250	CRW1 R	CR 9852	Bore-Tite
	1.499	.250	CRW1 V	CR 9854	Bore-Tite
	1.499	.250	CRW1 R	CR 9876	Bore-Tite
	1.499	.250	CRWA1 R	CR 9878	Bore-Tite
	1.499	.250	CRWA1 V	CR 9879	Bore-Tite
	1.499	.315	CRWA1 V	CR 9862	Bore-Tite
	1.499	.315	CRW1 V	CR 9892	Bore-Tite
	1.561	.250	CRW1 R	CR 9894	Bore-Tite
	1.575	.313	CRWA1 R	CR 9907	Bore-Tite
	1.624	.250	CRW1 R	CR 9934	Bore-Tite
	1.624	.250	CRWA1 R	CR 9935	Bore-Tite
	1.624	.250	CRW1 V	CR 9937	Bore-Tite
	1.624	.250	CRWA1 V	CR 9939	Bore-Tite
	1.686	.250	CRW1 R	CR 9960	Bore-Tite
	1.752	.250	CRW1 V	CR 9982	Bore-Tite
	1.752	.250	CRWA1 V	CR 9983	Bore-Tite
	1.752	.250	CRW1 R	CR 9997	Bore-Tite
	1.752	.250	CRWA1 R	CR 9998	Bore-Tite
	1.828	.250	CRW1 V	CR 10046	Bore-Tite
	1.828	.250	CRW1 P	CR 10047	Bore-Tite
	1.828	.250	CRW1 R	CR 10049	Bore-Tite
	1.828	.250	CRWA1 R	CR 10050	Bore-Tite
	1.851	.250	CRW1 R	CR 10071	Bore-Tite
1.874	.250	CRW1 R	CR 10075	Bore-Tite	
1.938	.250	CRW1 R	CR 10104	Bore-Tite	
1.983	.250	CRWA1 V	CR 10111	Bore-Tite	
1.983	.313	CRWA1 R	CR 10114	Bore-Tite	
2.000	.250	CRW1 R	CR 10123	Bore-Tite	

Series CRW1 – Inch sizes

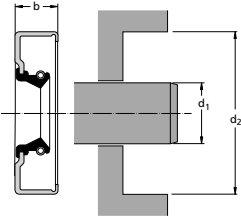

Dimensions		seal width b	Design and lip material	SKF Designation	
shaft d ₁	bore d ₂				
in					
1.000	2.000	.250	CRWA1 R	CR 10124	Bore-Tite
	2.000	.250	CRWA1 R	CR 10127	Bore-Tite
	2.000	.250	CRW1 V	CR 10128	Bore-Tite
	2.000	.250	CRWA1 V	CR 10129	Bore-Tite
	2.047	.250	CRWA1 R	CR 10157	Bore-Tite
	2.062	.250	CRW1 R	CR 10158	Bore-Tite
	2.250	.250	CRW1 R	CR 10169	Bore-Tite
1.063	1.499	.250	CRW1 R	CR 10515	Bore-Tite
	1.499	.250	CRW1 V	CR 10518	Bore-Tite
	1.512	.256	CRW1 P	CR 532866	Bore-Tite
	1.561	.250	CRW1 R	CR 10581	Bore-Tite
	1.577	.250	CRW1 R	CR 10583	Bore-Tite
	1.624	.250	CRW1 R	CR 10598	Bore-Tite
	1.686	.250	CRW1 R	CR 10632	Bore-Tite
	1.752	.250	CRW1 R	CR 10653	Bore-Tite
	1.828	.250	CRW1 R	CR 10681	Bore-Tite
	1.828	.250	CRW1 V	CR 10682	Bore-Tite
	1.874	.250	CRW1 R	CR 10700	Bore-Tite
	1.979	.250	CRW1 R	CR 10728	Bore-Tite
	1.983	.250	CRW1 R	CR 10733	Bore-Tite
	2.000	.250	CRW1 R	CR 10740	Bore-Tite
2.062	.250	CRW1 R	CR 10766	Bore-Tite	
1.125	1.499	.188	CRW1 V	CR 11059	
	1.499	.188	CRW1 R	CR 11061	
	1.561	.250	CRW1 P	CR 11066	Bore-Tite
	1.561	.250	CRW1 R	CR 11067	Bore-Tite
	1.561	.250	CRW1 V	CR 11071	Bore-Tite
	1.565	.250	CRW1 R	CR 11082	Bore-Tite
	1.624	.250	CRW1 P	CR 11111	Bore-Tite
	1.624	.250	CRW1 R	CR 11123	Bore-Tite
	1.624	.250	CRWA1 R	CR 11124	Bore-Tite
	1.624	.250	CRW1 V	CR 11133	Bore-Tite
	1.624	.250	CRWA1 V	CR 11134	Bore-Tite
	1.733	.375	CRW1 R	CR 11137	Bore-Tite
	1.752	.250	CRW1 R	CR 11138	Bore-Tite
	1.752	.250	CRW1 V	CR 11144	Bore-Tite
	1.828	.250	CRW1 R	CR 11170	Bore-Tite
	1.828	.250	CRWA1 R	CR 11171	Bore-Tite
	1.828	.250	CRW1 V	CR 11172	Bore-Tite

Series CRW1 – Inch sizes

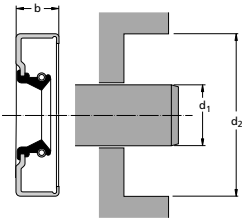

Dimensions		seal width b	Design and lip material	SKF Designation	
shaft d_1	bore d_2				
in					
1.125	1.828	.250	CRWA1 V	CR 11175	Bore-Tite
	1.852	.313	CRWH1 R	CR 11197	Bore-Tite
	1.852	.313	CRWHA1 R	CR 11200	Bore-Tite
	1.874	.250	CRW1 V	CR 11207	Bore-Tite
	1.874	.250	CRWA1 V	CR 11208	Bore-Tite
	1.874	.250	CRW1 R	CR 11209	Bore-Tite
	1.874	.250	CRWA1 R	CR 11223	Bore-Tite
	1.983	.250	CRW1 R	CR 11299	Bore-Tite
	2.000	.250	CRW1 R	CR 11340	Bore-Tite
	2.000	.250	CRW1 V	CR 11344	Bore-Tite
	2.000	.374	CRWA1 V	CR 12138	Bore-Tite
	2.000	.375	CRWA1 R	CR 11343	Bore-Tite
	2.047	.313	CRWA1 R	CR 11353	Bore-Tite
	2.062	.250	CRWA1 V	CR 11368	Bore-Tite
	2.062	.313	CRW1 R	CR 11366	Bore-Tite
	2.125	.313	CRW1 R	CR 11372	Bore-Tite
	2.125	.313	CRW1 V	CR 11373	Bore-Tite
2.250	.250	CRW1 R	CR 11378	Bore-Tite	
2.441	.250	CRW1 R	CR 11392	Bore-Tite	
1.126	1.575	.236	CRWA1 R	CR 11086	Bore-Tite
1.156	1.686	.250	CRWA1 R	CR 11518	Bore-Tite
	1.752	.250	CRWA1 R	CR 11514	Bore-Tite
	1.874	.250	CRW1 R	CR 11524	Bore-Tite
	1.875	.375	CRWA1 R	CR 11536	
	2.000	.250	CRW1 R	CR 11544	Bore-Tite
	2.000	.250	CRWA1 R	CR 11545	Bore-Tite
	2.000	.250	CRW1 V	CR 11550	Bore-Tite
2.062	.313	CRW1 R	CR 11557	Bore-Tite	
1.175	2.031	.500	CRW1 R	CR 11553	Bore-Tite
1.178	2.073	.335	CRW1 S	CR 11650	Bore-Tite
1.188	1.561	.313	CRW1 V	CR 11710	
	1.686	.250	CRW1 P	CR 11728	Bore-Tite
	1.687	.250	CRW1 R	CR 11730	Bore-Tite
	1.752	.250	CRW1 R	CR 11734	Bore-Tite
	1.752	.250	CRW1 V	CR 11736	Bore-Tite
1.828	.375	CRW1 R	CR 11740	Bore-Tite	

Series CRW1 – Inch sizes

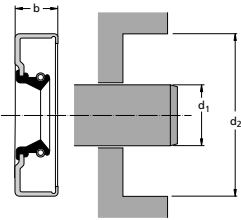

Dimensions			Design and lip material	SKF Designation	
shaft	bore	seal width			
d ₁	d ₂	b			
in					
1.188	1.875	.250	CRW1 P	CR 11763	Bore-Tite
	1.875	.375	CRW1 R	CR 11585	Bore-Tite
	1.983	.250	CRW1 R	CR 11776	Bore-Tite
	1.983	.250	CRWA1 R	CR 11777	Bore-Tite
	2.000	.250	CRW1 R	CR 11800	Bore-Tite
	2.000	.250	CRWA1 R	CR 11801	Bore-Tite
	2.000	.250	CRW1 V	CR 11806	Bore-Tite
	2.062	.250	CRW1 R	CR 11878	Bore-Tite
	2.062	.250	CRW1 P	CR 11879	Bore-Tite
	2.125	.313	CRW1 R	CR 11907	Bore-Tite
	2.165	.250	CRW1 R	CR 11911	Bore-Tite
	2.250	.250	CRW1 R	CR 11914	Bore-Tite
	2.437	.250	CRW1 R	CR 11923	Bore-Tite
	2.441	.250	CRW1 R	CR 11930	Bore-Tite
1.190	2.125	.313	CRWA1 R	CR 11908	Bore-Tite
1.234	2.250	.250	CRW1 R	CR 12590	Bore-Tite
1.250	1.625	.188	CRW1 R	CR 12329	Bore-Tite
	1.687	.250	CRW1 V	CR 12335	Bore-Tite
	1.687	.250	CRW1 R	CR 12336	Bore-Tite
	1.687	.250	CRWA1 V	CR 12337	Bore-Tite
	1.687	.313	CRWA1 R	CR 12350	Bore-Tite
	1.752	.250	CRW1 V	CR 12340	Bore-Tite
	1.752	.250	CRWA1 V	CR 12343	Bore-Tite
	1.752	.250	CRW1 R	CR 12363	Bore-Tite
	1.752	.250	CRWA1 R	CR 12364	Bore-Tite
	1.874	.250	CRW1 P	CR 12382	Bore-Tite
	1.874	.250	CRWA1 V	CR 12383	Bore-Tite
	1.874	.250	CRW1 R	CR 12384	Bore-Tite
	1.874	.250	CRWA1 R	CR 12386	Bore-Tite
	1.938	.250	CRW1 R	CR 12391	Bore-Tite
	1.955	.250	CRWA1 R	CR 12396	Bore-Tite
	1.983	.250	CRW1 R	CR 12427	Bore-Tite
	1.983	.250	CRWA1 R	CR 12428	Bore-Tite
	1.983	.250	CRW1 V	CR 12432	Bore-Tite
	2.000	.250	CRW1 V	CR 12445	Bore-Tite
	2.000	.250	CRWA1 V	CR 12446	Bore-Tite
2.000	.250	CRW1 R	CR 12456	Bore-Tite	
2.000	.250	CRWA1 R	CR 12458	Bore-Tite	

Series CRW1 – Inch sizes

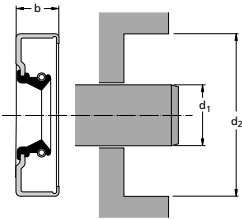

Dimensions		seal width b	Design and lip material	SKF Designation	
shaft d ₁	bore d ₂				
in					
1.250	2.000	.438	CRW1 P	CR 12483	Bore-Tite
	2.062	.250	CRWA1 V	CR 12531	Bore-Tite
	2.062	.433	CRWHA1 V	CR 12533	Bore-Tite
	2.062	.438	CRWH1 R	CR 12530	Bore-Tite
	2.125	.250	CRW1 V	CR 12544	Bore-Tite
	2.125	.250	CRW1 R	CR 12545	Bore-Tite
	2.125	.250	CRWA1 R	CR 12551	Bore-Tite
	2.250	.250	CRW1 R	CR 12577	Bore-Tite
	2.327	.500	CRW1 R	CR 12610	Bore-Tite
	2.374	.313	CRW1 R	CR 12613	Bore-Tite
	2.374	.313	CRWA1 R	CR 12614	Bore-Tite
	2.374	.315	CRW1 V	CR 12612	Bore-Tite
	2.437	.250	CRW1 R	CR 12621	Bore-Tite
	2.441	.250	CRW1 R	CR 12631	Bore-Tite
	2.500	.310	CRW1 V	CR 12638	Bore-Tite
	2.502	.313	CRW1 R	CR 12637	Bore-Tite
1.301	2.046	.492	CRWA1 R	CR 12907	Bore-Tite
1.313	1.828	.375	CRW1 P	CR 13021	Bore-Tite
	2.062	.313	CRW1 R	CR 13050	Bore-Tite
	2.062	.313	CRWA1 R	CR 13052	Bore-Tite
	2.062	.313	CRW1 V	CR 13054	Bore-Tite
	2.125	.313	CRW1 R	CR 13092	Bore-Tite
	2.250	.313	CRW1 R	CR 13112	Bore-Tite
	2.282	.250	CRWA1 R	CR 13157	Bore-Tite
1.328	2.031	.313	CRW1 R	CR 13415	
	2.061	.313	CRW1 R	CR 13350	Bore-Tite
	2.227	.313	CRW1 R	CR 13418	Bore-Tite
1.344	2.106	.313	CRW1 R	CR 13421	Bore-Tite
	2.125	.313	CRW1 R	CR 13437	Bore-Tite
1.365	1.956	.438	CRW1 R	CR 13985	Bore-Tite
	2.081	.313	CRW1 R	CR 13598	Bore-Tite
	2.261	.313	CRW1 R	CR 13700	Bore-Tite
1.375	1.750	.250	CRW1 R	CR 13514	Bore-Tite
	1.828	.250	CRWA1 V	CR 13510	Bore-Tite
	1.828	.313	CRW1 R	CR 13537	Bore-Tite

Series CRW1 – Inch sizes

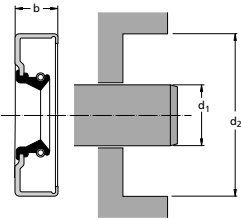

Dimensions		seal width b	Design and lip material	SKF Designation	
shaft d ₁	bore d ₂				
in					
1.375	1.835	.250	CRW1 R	CR 13536	Bore-Tite
	1.873	.313	CRW1 V	CR 13511	Bore-Tite
	1.874	.250	CRW1 P	CR 13512	Bore-Tite
	1.874	.250	CRW1 R	CR 13534	Bore-Tite
	1.874	.250	CRW1 V	CR 13538	Bore-Tite
	1.874	.313	CRWA1 R	CR 13535	Bore-Tite
	1.938	.250	CRWA1 R	CR 13552	Bore-Tite
	1.955	.433	CRWA1 P	CR 13527	Bore-Tite
	1.983	.313	CRW1 P	CR 13557	Bore-Tite
	2.000	.313	CRWA1 P	CR 13562	Bore-Tite
	2.000	.313	CRW1 R	CR 13568	Bore-Tite
	2.000	.313	CRWA1 R	CR 13569	Bore-Tite
	2.000	.313	CRWH1 R	CR 13571	Bore-Tite
	2.000	.313	CRW1 V	CR 13579	Bore-Tite
	2.000	.313	CRWA1 V	CR 13581	Bore-Tite
	2.062	.313	CRW1 V	CR 13582	Bore-Tite
	2.062	.313	CRW1 R	CR 13585	
	2.062	.313	CRWA1 P	CR 13588	Bore-Tite
	2.062	.315	CRWA1 V	CR 13607	Bore-Tite
	2.106	.313	CRWA1 R	CR 13602	
	2.106	.313	CRW1 P	CR 13614	Bore-Tite
	2.125	.313	CRW1 R	CR 13649	Bore-Tite
	2.125	.313	CRWA1 R	CR 13650	Bore-Tite
	2.125	.313	CRWA1 V	CR 13661	Bore-Tite
	2.125	.313	CRW1 V	CR 13663	Bore-Tite
	2.250	.250	CRWA1 R	CR 13698	Bore-Tite
	2.250	.313	CRW1 R	CR 13671	Bore-Tite
	2.250	.313	CRWA1 R	CR 13676	Bore-Tite
	2.250	.313	CRW1 V	CR 13688	Bore-Tite
	2.250	.313	CRWA1 V	CR 13691	Bore-Tite
	2.250	.313	CRW1 P	CR 13869	Bore-Tite
	2.374	.313	CRW1 V	CR 13734	Bore-Tite
	2.374	.313	CRW1 R	CR 13738	Bore-Tite
	2.374	.313	CRWA1 R	CR 13739	Bore-Tite
	2.437	.250	CRW1 R	CR 13797	Bore-Tite
	2.441	.313	CRW1 R	CR 13810	Bore-Tite
	2.441	.313	CRWA1 R	CR 13812	Bore-Tite
	2.502	.313	CRW1 R	CR 13865	Bore-Tite
	2.502	.313	CRW1 V	CR 13867	Bore-Tite
	2.502	.374	CRWA1 V	CR 13856	Bore-Tite
2.562	.375	CRW1 R	CR 13875	Bore-Tite	

Series CRW1 – Inch sizes

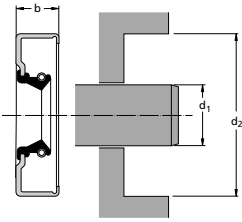

Dimensions		seal width b	Design and lip material	SKF Designation	
shaft d_1	bore d_2				
in					
1.375	2.562	.375	CRWA1 R	CR 13876	Bore-Tite
	2.562	.375	CRWA1 V	CR 13878	Bore-Tite
	2.623	.313	CRWA1 V	CR 13882	Bore-Tite
	2.686	.500	CRW1 R	CR 13892	Bore-Tite
	2.716	.313	CRW1 R	CR 13900	Bore-Tite
	2.812	.375	CRWHA1 R	CR 13912	Bore-Tite
	2.835	.313	CRWA1 R	CR 13918	Bore-Tite
	2.835	.313	CRW1 R	CR 13920	Bore-Tite
	2.835	.313	CRWA1 P	CR 13925	Bore-Tite
	2.875	.313	CRWA1 P	CR 13929	Bore-Tite
1.378	2.835	.313	CRWA1 V	CR 13926	Bore-Tite
1.417	2.616	.313	CRW1 R	CR 14092	Bore-Tite
1.438	2.062	.313	CRW1 V	CR 14212	
	2.062	.313	CRWA1 R	CR 14214	Bore-Tite
	2.125	.313	CRW1 R	CR 14223	Bore-Tite
	2.125	.313	CRWA1 V	CR 14225	Bore-Tite
	2.250	.313	CRWA1 R	CR 14247	Bore-Tite
	2.250	.313	CRWA1 V	CR 14259	Bore-Tite
	2.250	.313	CRW1 V	CR 14260	Bore-Tite
	2.250	.313	CRW1 R	CR 14262	Bore-Tite
	2.374	.313	CRW1 R	CR 14282	Bore-Tite
	2.374	.313	CRWA1 R	CR 14283	Bore-Tite
	2.437	.313	CRW1 R	CR 14363	Bore-Tite
	2.502	.313	CRW1 R	CR 14383	Bore-Tite
	2.623	.313	CRW1 R	CR 14404	Bore-Tite
	2.686	.313	CRW1 R	CR 14423	Bore-Tite
2.750	.313	CRW1 R	CR 14458	Bore-Tite	
1.484	2.254	.313	CRW1 R	CR 14907	Bore-Tite
1.494	2.060	.270	CRW1 R	CR 14789	Bore-Tite
1.496	2.165	.315	CRWA1 R	CR 550250	Bore-Tite
1.500	1.874	.250	CRW1 R	CR 14807	
	1.918	.250	CRW1 V	CR 14809	
	1.983	.250	CRW1 V	CR 14821	Bore-Tite
	1.983	.250	CRWA1 R	CR 14824	Bore-Tite

Series CRW1 – Inch sizes

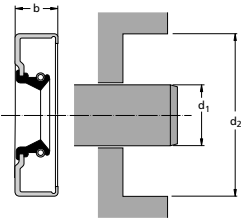

Dimensions		seal width b	Design and lip material	SKF Designation	
shaft d ₁	bore d ₂				
in					
1.500	1.983	.313	CRW1 R	CR 14832	Bore-Tite
	2.000	.313	CRWA1 R	CR 14846	Bore-Tite
	2.000	.313	CRW1 R	CR 14855	Bore-Tite
	2.000	.313	CRW1 V	CR 14861	Bore-Tite
	2.048	.313	CRWA1 R	CR 14858	Bore-Tite
	2.062	.313	CRW1 R	CR 14864	Bore-Tite
	2.062	.313	CRW1 V	CR 14867	Bore-Tite
	2.125	.313	CRW1 R	CR 14875	Bore-Tite
	2.125	.313	CRWA1 R	CR 14876	Bore-Tite
	2.125	.313	CRW1 V	CR 14886	Bore-Tite
	2.125	.313	CRWA1 V	CR 14887	Bore-Tite
	2.222	.313	CRW1 R	CR 14903	Bore-Tite
	2.250	.313	CRW1 S	CR 14935	Bore-Tite
	2.250	.313	CRW1 R	CR 14938	Bore-Tite
	2.250	.313	CRWA1 R	CR 14939	Bore-Tite
	2.250	.313	CRW1 V	CR 14940	Bore-Tite
	2.250	.313	CRWA1 V	CR 14942	Bore-Tite
	2.260	.406	CRW1 R	CR 14968	Bore-Tite
	2.374	.313	CRW1 V	CR 14992	Bore-Tite
	2.374	.313	CRWA1 V	CR 14994	Bore-Tite
	2.374	.313	CRW1 R	CR 15004	Bore-Tite
	2.374	.313	CRWA1 R	CR 15005	Bore-Tite
	2.374	.500	CRWH1 R	CR 15039	Bore-Tite
	2.377	.453	CRWA1 R	CR 15041	Bore-Tite
	2.437	.313	CRW1 R	CR 15076	Bore-Tite
	2.441	.313	CRW1 R	CR 15092	
	2.441	.313	CRWA1 R	CR 15093	Bore-Tite
	2.441	.313	CRW1 V	CR 15097	Bore-Tite
	2.502	.313	CRW1 V	CR 15138	Bore-Tite
	2.502	.313	CRW1 R	CR 15141	Bore-Tite
	2.502	.313	CRWA1 R	CR 15142	Bore-Tite
	2.561	.313	CRW1 R	CR 15176	Bore-Tite
	2.623	.313	CRW1 R	CR 15194	Bore-Tite
2.686	.500	CRW1 R	CR 15207	Bore-Tite	
2.716	.438	CRW1 R	CR 15204	Bore-Tite	
2.750	.313	CRW1 R	CR 15214	Bore-Tite	
2.758	.313	CRW1 R	CR 15230	Bore-Tite	
2.835	.313	CRW1 R	CR 15234	Bore-Tite	
2.875	.313	CRW1 R	CR 15235	Bore-Tite	

Series CRW1 – Inch sizes

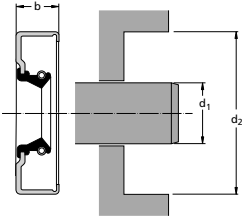

Dimensions		seal width b	Design and lip material	SKF Designation	
shaft d ₁	bore d ₂				
in					
1.552	2.502	.500	CRWA1 R	CR 15450	Bore-Tite
	2.686	.500	CRW1 R	CR 15460	Bore-Tite
	2.750	.500	CRWHA1 P	CR 15462	Bore-Tite
1.563	2.062	.250	CRW1 V	CR 15506	Bore-Tite
	2.062	.250	CRW1 R	CR 15508	Bore-Tite
	2.125	.313	CRW1 R	CR 15517	
	2.125	.313	CRWA1 P	CR 15518	Bore-Tite
	2.250	.313	CRW1 R	CR 15522	Bore-Tite
	2.374	.313	CRW1 P	CR 15540	
	2.374	.313	CRW1 R	CR 15542	Bore-Tite
	2.374	.313	CRWA1 R	CR 15543	Bore-Tite
	2.374	.313	CRWA1 V	CR 15549	Bore-Tite
	2.437	.313	CRW1 R	CR 15592	
	2.441	.500	CRWA1 R	CR 15620	Bore-Tite
	2.465	.374	CRWA1 P	CR 15624	Bore-Tite
	2.502	.313	CRWA1 R	CR 15635	Bore-Tite
	2.502	.313	CRW1 R	CR 15655	Bore-Tite
	2.502	.313	CRW1 V	CR 15656	Bore-Tite
	2.561	.313	CRW1 R	CR 15677	Bore-Tite
	2.623	.313	CRW1 R	CR 15699	Bore-Tite
	2.686	.313	CRW1 R	CR 15707	Bore-Tite
	2.750	.500	CRWH1 R	CR 15761	Bore-Tite
2.875	.313	CRW1 R	CR 15773	Bore-Tite	
2.875	.313	CRWA1 P	CR 15779	Bore-Tite	
1.578	2.082	.250	CRW1 R	CR 15510	Bore-Tite
	2.408	.313	CRWHA1 R	CR 15557	Bore-Tite
1.594	2.125	.313	CRW1 P	CR 15915	Bore-Tite
	2.437	.313	CRW1 P	CR 15940	Bore-Tite
	2.437	.313	CRW1 R	CR 15955	Bore-Tite
	2.502	.313	CRW1 R	CR 15960	Bore-Tite
	2.623	.313	CRW1 R	CR 15968	Bore-Tite
2.758	.313	CRW1 R	CR 15975	Bore-Tite	
1.618	2.531	.438	CRWA1 R	CR 16040	Bore-Tite
1.625	2.000	.250	CRW1 V	CR 16039	Bore-Tite
	2.000	.250	CRW1 R	CR 16046	
	2.116	.313	CRWA1 R	CR 16047	Bore-Tite

Series CRW1 – Inch sizes

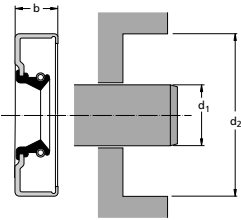

Dimensions		seal width b	Design and lip material	SKF Designation	
shaft d ₁	bore d ₂				
in					
1.625	2.125	.250	CRW1 V	CR 16048	Bore-Tite
	2.125	.250	CRW1 R	CR 16054	Bore-Tite
	2.248	.313	CRWA1 R	CR 16062	Bore-Tite
	2.250	.313	CRW1 R	CR 16061	Bore-Tite
	2.250	.313	CRW1 V	CR 16078	
	2.250	.375	CRW1 P	CR 16049	Bore-Tite
	2.282	.313	CRW1 R	CR 16083	Bore-Tite
	2.374	.250	CRW1 R	CR 16094	
	2.374	.313	CRWH1 R	CR 16072	Bore-Tite
	2.374	.313	CRW1 V	CR 16077	Bore-Tite
	2.374	.313	CRW1 R	CR 16084	Bore-Tite
	2.374	.313	CRWA1 R	CR 16085	Bore-Tite
	2.374	.313	CRWA1 P	CR 16091	
	2.374	.500	CRWH1 R	CR 16079	Bore-Tite
	2.437	.313	CRW1 R	CR 16117	Bore-Tite
	2.437	.313	CRWA1 R	CR 16118	Bore-Tite
	2.437	.313	CRW1 V	CR 16119	Bore-Tite
	2.437	.313	CRWA1 V	CR 16120	Bore-Tite
	2.441	.313	CRW1 R	CR 16180	Bore-Tite
	2.441	.313	CRWA1 R	CR 16201	Bore-Tite
	2.502	.313	CRWA1 V	CR 16243	Bore-Tite
	2.502	.313	CRW1 R	CR 16245	Bore-Tite
	2.502	.313	CRWA1 R	CR 16246	Bore-Tite
	2.502	.313	CRWA1 P	CR 16247	
	2.502	.374	CRWHA1 V	CR 16257	Bore-Tite
	2.502	.375	CRWHA1 R	CR 16254	Bore-Tite
	2.562	.313	CRWA1 V	CR 16290	Bore-Tite
	2.623	.313	CRW1 R	CR 16314	Bore-Tite
	2.623	.313	CRWA1 R	CR 16315	Bore-Tite
	2.623	.313	CRW1 V	CR 16316	Bore-Tite
	2.686	.313	CRW1 R	CR 16337	Bore-Tite
	2.686	.313	CRW1 V	CR 16338	Bore-Tite
	2.750	.250	CRW1 R	CR 16364	Bore-Tite
	2.750	.313	CRWH1 R	CR 16368	Bore-Tite
2.758	.313	CRW1 R	CR 16374	Bore-Tite	
2.875	.313	CRW1 R	CR 16406	Bore-Tite	
3.000	.313	CRWH1 R	CR 16422	Bore-Tite	
1.645	2.656	.313	CRWA1 P	CR 16500	Bore-Tite

Series CRW1 – Inch sizes

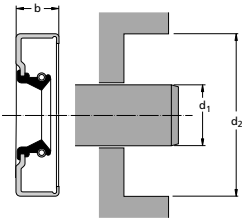

Dimensions		seal width b	Design and lip material	SKF Designation	
shaft d ₁	bore d ₂				
in					
1.656	2.623	.375	CRWA1 P	CR 16545	Bore-Tite
	2.686	.313	CRW1 R	CR 16556	Bore-Tite
1.688	2.279	.500	CRWH1 R	CR 16650	Bore-Tite
	2.328	.313	CRWA1 R	CR 16657	Bore-Tite
	2.437	.250	CRW1 S	CR 16692	Bore-Tite
	2.437	.313	CRW1 R	CR 16679	Bore-Tite
	2.437	.313	CRWA1 R	CR 16680	Bore-Tite
	2.437	.469	CRW1 S	CR 16696	Bore-Tite
	2.502	.313	CRW1 R	CR 16719	Bore-Tite
	2.623	.313	CRWA1 R	CR 16814	Bore-Tite
	2.623	.500	CRW1 R	CR 16816	Bore-Tite
	2.623	.500	CRWA1 V	CR 16817	Bore-Tite
	2.686	.313	CRW1 R	CR 16842	Bore-Tite
	2.716	.313	CRW1 R	CR 16854	Bore-Tite
	2.750	.313	CRW1 R	CR 16900	
	2.750	.375	CRWA1 R	CR 16903	Bore-Tite
	2.875	.313	CRW1 R	CR 16999	Bore-Tite
3.061	.375	CRW1 R	CR 17035	Bore-Tite	
3.125	.375	CRWA1 R	CR 17038	Bore-Tite	
1.704	3.034	.500	CRWA1 R	CR 17100	Bore-Tite
1.719	2.561	.315	CRWA1 R	CR 17144	Bore-Tite
1.750	2.250	.313	CRW1 R	CR 17231	Bore-Tite
	2.250	.313	CRW1 V	CR 17234	Bore-Tite
	2.374	.313	CRWA1 V	CR 17261	Bore-Tite
	2.374	.313	CRW1 R	CR 17270	Bore-Tite
	2.374	.313	CRWA1 R	CR 17271	Bore-Tite
	2.411	.375	CRW1 P	CR 17280	Bore-Tite
	2.437	.313	CRW1 R	CR 17283	Bore-Tite
	2.437	.313	CRW1 R	CR 17284	Bore-Tite
	2.437	.313	CRWA1 R	CR 17285	Bore-Tite
	2.437	.313	CRW1 V	CR 17292	Bore-Tite
	2.437	.313	CRWA1 V	CR 17293	Bore-Tite
	2.441	.313	CRW1 R	CR 17315	Bore-Tite
	2.441	.313	CRWA1 R	CR 550154	Bore-Tite
	2.441	.375	CRWA1 V	CR 17320	Bore-Tite
	2.502	.313	CRW1 V	CR 17379	Bore-Tite
2.502	.313	CRWA1 V	CR 17381	Bore-Tite	

Series CRW1 – Inch sizes

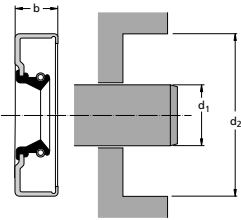

Dimensions			Design and lip material	SKF Designation	
shaft	bore	seal width			
d ₁	d ₂	b			
in					
1.750	2.502	.313	CRW1 R	CR 17386	Bore-Tite
	2.502	.313	CRWA1 R	CR 17387	Bore-Tite
	2.502	.375	CRWHA1 V	CR 17395	Bore-Tite
	2.502	.375	CRW1 S	CR 17399	Bore-Tite
	2.561	.313	CRW1 R	CR 17404	Bore-Tite
	2.565	.313	CRWA1 R	CR 17413	Bore-Tite
	2.623	.313	CRW1 R	CR 17442	Bore-Tite
	2.623	.313	CRWA1 R	CR 17443	Bore-Tite
	2.623	.313	CRW1 S	CR 17444	Bore-Tite
	2.623	.313	CRWA1 V	CR 17448	Bore-Tite
	2.623	.375	CRWH1 R	CR 17456	Bore-Tite
	2.686	.313	CRW1 R	CR 17484	
	2.717	.438	CRWA1 R	CR 17607	Bore-Tite
	2.750	.313	CRWA1 R	CR 17523	Bore-Tite
	2.750	.313	CRW1 R	CR 17557	Bore-Tite
	2.750	.313	CRW1 V	CR 17558	Bore-Tite
	2.758	.313	CRW1 R	CR 17605	Bore-Tite
	2.810	.313	CRWA1 R	CR 17624	
	2.810	.313	CRWA1 V	CR 17627	Bore-Tite
	2.875	.313	CRW1 R	CR 17653	Bore-Tite
	2.875	.313	CRW1 V	CR 17657	Bore-Tite
	2.875	.375	CRWHA1 R	CR 17645	Bore-Tite
	2.981	.438	CRWHA1 R	CR 17675	
	2.997	.313	CRWHA1 R	CR 17678	Bore-Tite
	2.997	.313	CRW1 R	CR 17695	Bore-Tite
	3.000	.313	CRWA1 R	CR 17699	Bore-Tite
	3.000	.313	CRW1 R	CR 17707	Bore-Tite
	3.000	.313	CRW1 V	CR 17709	Bore-Tite
	3.061	.313	CRW1 R	CR 17716	Bore-Tite
	3.061	.375	CRWA1 R	CR 17718	Bore-Tite
	3.189	.313	CRW1 R	CR 17746	Bore-Tite
	3.543	.438	CRW1 R	CR 17756	Bore-Tite
3.625	.438	CRW1 R	CR 17761	Bore-Tite	
1.768	2.363	.313	CRWHA1 V	CR 17780	Bore-Tite
1.781	2.252	.313	CRWA1 R	CR 17806	Bore-Tite
	2.502	.313	CRWH1 R	CR 17810	Bore-Tite
	2.502	.313	CRWH1 V	CR 17811	Bore-Tite
	2.623	.313	CRW1 R	CR 17821	Bore-Tite
	2.686	.313	CRW1 R	CR 17832	

Series CRW1 – Inch sizes

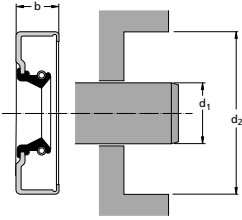

Dimensions		seal width b	Design and lip material	SKF Designation	
shaft d ₁	bore d ₂				
in					
1.812	2.623	.374	CRWA1 V	CR 17949	Bore-Tite
1.813	2.279	.313	CRW1 R	CR 18025	Bore-Tite
	2.437	.313	CRW1 R	CR 18039	Bore-Tite
	2.562	.313	CRWA1 V	CR 18049	Bore-Tite
	2.623	.313	CRW1 R	CR 18104	Bore-Tite
	2.686	.313	CRWA1 P	CR 18114	Bore-Tite
	2.750	.313	CRW1 R	CR 18159	Bore-Tite
	2.875	.313	CRW1 R	CR 18242	Bore-Tite
	3.000	.375	CRWA1 P	CR 18264	Bore-Tite
1.844	2.623	.313	CRW1 R	CR 18425	Bore-Tite
	2.750	.313	CRW1 P	CR 18444	Bore-Tite
1.868	2.518	.315	CRWA1 P	CR 18492	Bore-Tite
1.875	2.398	.250	CRW1 R	CR 18549	Bore-Tite
	2.471	.313	CRWA1 R	CR 18545	Bore-Tite
	2.500	.313	CRW1 P	CR 18555	Bore-Tite
	2.502	.313	CRW1 R	CR 18565	Bore-Tite
	2.562	.313	CRWA1 V	CR 18546	Bore-Tite
	2.562	.313	CRW1 P	CR 18562	Bore-Tite
	2.623	.313	CRW1 R	CR 18580	Bore-Tite
	2.623	.313	CRWA1 R	CR 18581	Bore-Tite
	2.623	.313	CRW1 V	CR 18582	Bore-Tite
	2.623	.313	CRWA1 V	CR 18584	Bore-Tite
	2.623	.374	CRW1 S	CR 18592	Bore-Tite
	2.686	.313	CRW1 R	CR 18626	Bore-Tite
	2.750	.313	CRW1 V	CR 18652	Bore-Tite
	2.750	.313	CRW1 R	CR 18657	Bore-Tite
	2.750	.313	CRWA1 R	CR 18658	Bore-Tite
	2.750	.313	CRW1 P	CR 18666	Bore-Tite
	2.758	.313	CRW1 P	CR 18671	Bore-Tite
	2.758	.313	CRW1 S	CR 18679	Bore-Tite
	2.782	.438	CRWH1 R	CR 18693	Bore-Tite
	2.782	.438	CRWHA1 R	CR 18695	Bore-Tite
2.875	.313	CRW1 V	CR 18732	Bore-Tite	
2.875	.313	CRW1 R	CR 18733	Bore-Tite	
2.875	.313	CRWA1 R	CR 18734	Bore-Tite	
2.875	.313	CRWA1 V	CR 18737	Bore-Tite	
2.997	.313	CRW1 R	CR 18785	Bore-Tite	

Series CRW1 – Inch sizes

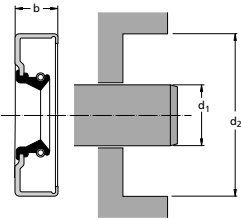

Dimensions			Design and lip material	SKF Designation	
shaft	bore	seal width			
d ₁	d ₂	b			
in					
1.875	3.000	.313	CRW1 R	CR 18817	Bore-Tite
	3.000	.313	CRW1 V	CR 18818	Bore-Tite
	3.061	.313	CRWA1 R	CR 18872	Bore-Tite
	3.105	.500	CRWA1 R	CR 18880	Bore-Tite
	3.189	.469	CRWH1 R	CR 18899	Bore-Tite
	3.249	.484	CRWA1 R	CR 18922	Bore-Tite
	3.371	.438	CRWH1 R	CR 18916	Bore-Tite
	3.496	.438	CRWA1 R	CR 18924	Bore-Tite
	3.500	.438	CRW1 R	CR 18926	Bore-Tite
1.893	2.434	.250	CRW1 R	CR 19000	
1.906	2.752	.375	CRWA1 P	CR 19017	Bore-Tite
1.915	2.533	.250	CRW1 R	CR 19010	Bore-Tite
1.938	2.412	.313	CRW1 R	CR 19215	Bore-Tite
	2.437	.250	CRW1 R	CR 19210	Bore-Tite
	2.437	.250	CRW1 R	CR 19212	Bore-Tite
	2.502	.375	CRWA1 R	CR 19220	Bore-Tite
	2.563	.313	CRW1 R	CR 19211	Bore-Tite
	2.623	.313	CRW1 R	CR 19226	Bore-Tite
	2.623	.313	CRWA1 V	CR 19227	Bore-Tite
	2.623	.313	CRWA1 R	CR 19229	Bore-Tite
	2.686	.300	CRW1 P	CR 19244	Bore-Tite
	2.686	.313	CRWA1 P	CR 19234	Bore-Tite
	2.686	.313	CRW1 R	CR 19236	Bore-Tite
	2.686	.313	CRWA1 R	CR 19237	Bore-Tite
	2.686	.313	CRWA1 V	CR 19243	Bore-Tite
	2.686	.375	CRW1 S	CR 19240	Bore-Tite
	2.750	.313	CRW1 R	CR 19264	Bore-Tite
	2.750	.313	CRW1 V	CR 19267	Bore-Tite
	2.875	.313	CRW1 R	CR 19300	Bore-Tite
	2.875	.313	CRWA1 R	CR 19301	Bore-Tite
	2.875	.313	CRWH1 V	CR 19304	Bore-Tite
	2.884	.313	CRWA1 P	CR 19310	Bore-Tite
2.997	.313	CRW1 R	CR 19350	Bore-Tite	
3.000	.313	CRW1 R	CR 19359	Bore-Tite	
3.000	.313	CRWA1 R	CR 19360		
3.000	.313	CRWA1 V	CR 19368	Bore-Tite	
3.061	.313	CRW1 R	CR 19380	Bore-Tite	

Series CRW1 – Inch sizes

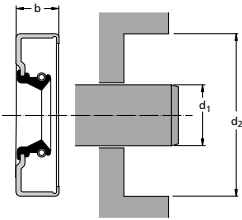

Dimensions		seal width b	Design and lip material	SKF Designation	
shaft d_1	bore d_2				
in					
1.938	3.062	.500	CRW1 S	CR 19438	Bore-Tite
	3.125	.500	CRW1 R	CR 19400	Bore-Tite
	3.189	.313	CRW1 R	CR 19407	Bore-Tite
	3.251	.313	CRWA1 V	CR 19433	Bore-Tite
	3.251	.313	CRW1 R	CR 19434	Bore-Tite
	3.350	.469	CRWHA1 R	CR 19445	Bore-Tite
	3.543	.313	CRW1 R	CR 19449	Bore-Tite
1.969	2.623	.313	CRWA1 R	CR 19607	Bore-Tite
2.000	2.500	.438	CRW1 S	CR 19739	Bore-Tite
	2.502	.313	CRW1 P	CR 19745	Bore-Tite
	2.623	.313	CRW1 R	CR 19760	Bore-Tite
	2.623	.313	CRWA1 R	CR 19762	Bore-Tite
	2.623	.313	CRWA1 V	CR 19777	Bore-Tite
	2.623	.313	CRWA1 V	CR 19782	Bore-Tite
	2.686	.375	CRW1 R	CR 19778	Bore-Tite
	2.716	.375	CRW1 R	CR 19785	Bore-Tite
	2.716	.375	CRWA1 R	CR 19786	Bore-Tite
	2.746	.375	CRW1 S	CR 19807	Bore-Tite
	2.750	.313	CRW1 V	CR 19823	Bore-Tite
	2.750	.313	CRW1 R	CR 19831	Bore-Tite
	2.750	.313	CRWA1 R	CR 19832	Bore-Tite
	2.750	.313	CRWA1 V	CR 19839	Bore-Tite
	2.750	.313	CRW1 V	CR 19840	Bore-Tite
	2.835	.469	CRWH1 R	CR 19848	Bore-Tite
	2.875	.313	CRW1 V	CR 19884	Bore-Tite
	2.875	.313	CRW1 R	CR 19886	Bore-Tite
	2.875	.313	CRWA1 R	CR 19887	Bore-Tite
	2.875	.375	CRWHA1 R	CR 19896	Bore-Tite
	2.875	.500	CRWH1 R	CR 19900	Bore-Tite
	2.880	.375	CRWA1 R	CR 19922	Bore-Tite
	2.880	.375	CRWA1 P	CR 19923	Bore-Tite
	2.997	.375	CRWH1 R	CR 19969	Bore-Tite
	2.997	.375	CRWHA1 R	CR 19970	Bore-Tite
	2.997	.375	CRWH1 V	CR 19979	Bore-Tite
	3.000	.313	CRW1 R	CR 19992	Bore-Tite
3.000	.313	CRWA1 R	CR 19993	Bore-Tite	
3.000	.313	CRWA1 V	CR 19995	Bore-Tite	
3.000	.375	CRWH1 V	CR 20002	Bore-Tite	
3.000	.375	CRWH1 R	CR 20004	Bore-Tite	

Series CRW1 – Inch sizes

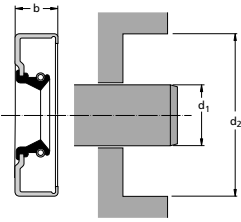

Dimensions					
shaft	bore	seal width	Design and	SKF Designation	
d_1	d_2	b	lip material		
in					
2.000	3.000	.375	CRWHA1 R	CR 20005	Bore-Tite
	3.061	.375	CRW1 R	CR 20045	Bore-Tite
	3.061	.500	CRWH1 R	CR 20053	Bore-Tite
	3.061	.500	CRWHA1 R	CR 20054	Bore-Tite
	3.125	.375	CRW1 R	CR 20070	Bore-Tite
	3.150	.375	CRW1 R	CR 20079	Bore-Tite
	3.189	.469	CRWH1 R	CR 20098	Bore-Tite
	3.189	.469	CRWHA1 R	CR 20100	Bore-Tite
	3.251	.438	CRWH1 R	CR 20109	Bore-Tite
	3.371	.438	CRW1 V	CR 20122	Bore-Tite
	3.371	.438	CRWH1 R	CR 20124	Bore-Tite
	3.371	.438	CRWHA1 R	CR 20125	Bore-Tite
	3.371	.438	CRWH1 V	CR 20127	
	3.543	.438	CRWH1 R	CR 20140	Bore-Tite
	3.623	.438	CRWH1 R	CR 20144	Bore-Tite
4.003	.438	CRWH1 R	CR 20158	Bore-Tite	
2.047	2.561	.315	CRW1 R	CR 20420	Bore-Tite
2.063	2.561	.313	CRW1 V	CR 20520	Bore-Tite
	2.750	.313	CRWH1 R	CR 20530	
	2.842	.438	CRWH1 R	CR 20538	Bore-Tite
	2.875	.438	CRWH1 R	CR 20554	Bore-Tite
	2.997	.438	CRWH1 R	CR 20586	Bore-Tite
	3.000	.375	CRW1 R	CR 20594	Bore-Tite
	3.000	.375	CRWA1 V	CR 20599	Bore-Tite
	3.061	.313	CRWH1 R	CR 20643	Bore-Tite
	3.125	.375	CRW1 R	CR 20659	Bore-Tite
	3.189	.375	CRW1 R	CR 20702	Bore-Tite
	3.251	.438	CRWHA1 R	CR 20747	Bore-Tite
	3.251	.438	CRWH1 R	CR 20749	Bore-Tite
	2.125	2.750	.375	CRW1 V	CR 21063
2.750		.500	CRWA1 R	CR 21061	Bore-Tite
2.763		.250	CRW1 R	CR 21069	Bore-Tite
2.875		.375	CRW1 S	CR 21103	Bore-Tite
2.875		.438	CRW1 V	CR 21091	Bore-Tite
2.875		.438	CRW1 R	CR 21098	Bore-Tite
2.875		.438	CRWA1 R	CR 21100	Bore-Tite
2.875		.438	CRWHA1 R	CR 21108	Bore-Tite
2.997		.438	CRWH1 R	CR 21134	Bore-Tite

Series CRW1 – Inch sizes

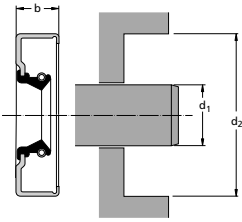

Dimensions		seal width b	Design and lip material	SKF Designation	
shaft d_1	bore d_2				
in					
2.125	2.997	.438	CRWHA1 R	CR 21136	Bore-Tite
	3.000	.313	CRWHA1 V	CR 21167	Bore-Tite
	3.000	.375	CRW1 R	CR 21163	Bore-Tite
	3.000	.375	CRWA1 R	CR 21164	Bore-Tite
	3.000	.438	CRWH1 V	CR 21171	Bore-Tite
	3.000	.438	CRWH1 R	CR 21172	Bore-Tite
	3.000	.438	CRWHA1 R	CR 21173	Bore-Tite
	3.061	.438	CRWH1 V	CR 21203	Bore-Tite
	3.061	.500	CRW1 R	CR 21210	Bore-Tite
	3.061	.500	CRWA1 R	CR 21211	
	3.061	.500	CRWHA1 R	CR 21213	Bore-Tite
	3.125	.438	CRWH1 R	CR 21234	Bore-Tite
	3.125	.438	CRWHA1 P	CR 21245	Bore-Tite
	3.189	.375	CRWA1 R	CR 21267	Bore-Tite
	3.189	.375	CRWA1 V	CR 21269	Bore-Tite
	3.189	.469	CRWHA1 S	CR 21270	Bore-Tite
	3.251	.438	CRWH1 R	CR 21302	Bore-Tite
	3.350	.438	CRWH1 R	CR 21336	Bore-Tite
	3.371	.375	CRWA1 R	CR 21352	Bore-Tite
	3.371	.438	CRWH1 R	CR 21353	Bore-Tite
3.543	.438	CRWH1 R	CR 21358	Bore-Tite	
2.188	2.875	.438	CRWH1 R	CR 21736	Bore-Tite
	2.997	.438	CRWH1 R	CR 21749	Bore-Tite
	3.000	.375	CRWA1 R	CR 21759	Bore-Tite
	3.000	.375	CRWA1 V	CR 21763	Bore-Tite
	3.000	.500	CRWH1 R	CR 21764	Bore-Tite
	3.061	.500	CRWH1 R	CR 21775	Bore-Tite
	3.251	.438	CRWH1 R	CR 21840	Bore-Tite
	3.350	.438	CRWH1 R	CR 21890	Bore-Tite
	3.371	.438	CRWH1 R	CR 21910	Bore-Tite
2.250	2.875	.313	CRWA1 R	CR 22328	Bore-Tite
	2.891	.563	CRWA1 R	CR 22319	Bore-Tite
	2.997	.438	CRWH1 R	CR 22338	Bore-Tite
	2.997	.438	CRWHA1 R	CR 22340	Bore-Tite
	3.000	.375	CRW1 R	CR 22353	Bore-Tite
	3.000	.375	CRWA1 R	CR 22354	Bore-Tite
	3.000	.375	CRWA1 V	CR 22361	Bore-Tite
	3.000	.375	CRW1 V	CR 22363	Bore-Tite
	3.000	.438	CRWH1 R	CR 22358	Bore-Tite

Series CRW1 – Inch sizes

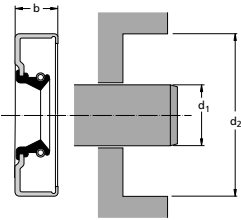

Dimensions		seal width b	Design and lip material	SKF Designation	
shaft d ₁	bore d ₂				
in					
2.250	3.000	.438	CRWHA1 R	CR 22359	Bore-Tite
	3.000	.438	CRWH1 V	CR 22367	Bore-Tite
	3.061	.375	CRW1 R	CR 22382	Bore-Tite
	3.061	.438	CRWH1 R	CR 22390	Bore-Tite
	3.061	.438	CRWHA1 R	CR 22391	Bore-Tite
	3.061	.438	CRWHA1 S	CR 22394	Bore-Tite
	3.125	.375	CRWA1 R	CR 22400	Bore-Tite
	3.125	.375	CRWA1 V	CR 22405	Bore-Tite
	3.125	.500	CRWH1 R	CR 22407	
	3.189	.438	CRW1 R	CR 22424	Bore-Tite
	3.189	.438	CRWA1 P	CR 22425	Bore-Tite
	3.251	.375	CRW1 R	CR 22440	Bore-Tite
	3.251	.375	CRWA1 R	CR 22441	Bore-Tite
	3.251	.375	CRWA1 P	CR 22450	Bore-Tite
	3.251	.438	CRWH1 R	CR 22446	Bore-Tite
	3.251	.438	CRWHA1 R	CR 22448	Bore-Tite
	3.251	.438	CRWH1 V	CR 22449	Bore-Tite
	3.350	.375	CRW1 P	CR 22484	Bore-Tite
	3.350	.438	CRWH1 R	CR 22492	
	3.350	.438	CRWHA1 R	CR 22493	Bore-Tite
	3.350	.438	CRWH1 V	CR 22495	Bore-Tite
	3.371	.438	CRWHA1 R	CR 22532	Bore-Tite
	3.371	.438	CRWH1 R	CR 22558	Bore-Tite
	3.371	.438	CRWH1 V	CR 22561	Bore-Tite
	3.481	.438	CRWH1 R	CR 22574	Bore-Tite
	3.500	.438	CRWHA1 R	CR 22582	Bore-Tite
	3.500	.438	CRWH1 R	CR 22583	Bore-Tite
	3.500	.438	CRWHA1 V	CR 22590	Bore-Tite
	3.565	.438	CRWA1 R	CR 22610	Bore-Tite
	3.623	.438	CRWH1 R	CR 22618	Bore-Tite
	3.623	.438	CRWHA1 R	CR 22619	Bore-Tite
	3.751	.438	CRWH1 R	CR 22626	Bore-Tite
3.876	.438	CRWH1 R	CR 22644		
4.003	.438	CRWH1 R	CR 22647	Bore-Tite	
2.313	2.997	.375	CRW1 R	CR 23030	Bore-Tite
	3.000	.438	CRWH1 V	CR 23040	Bore-Tite
	3.061	.313	CRW1 R	CR 23046	Bore-Tite
	3.125	.375	CRW1 R	CR 23061	Bore-Tite
	3.125	.375	CRWA1 V	CR 23063	Bore-Tite
	3.251	.438	CRWH1 R	CR 23093	Bore-Tite

Series CRW1 – Inch sizes

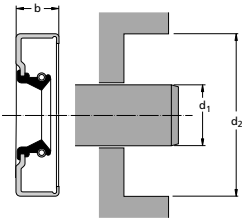

Dimensions			Design and lip material	SKF Designation	
shaft	bore	seal width			
d_1	d_2	b			
in					
2.313	3.251	.438	CRWHA1 V	CR 23099	
	3.350	.438	CRWH1 R	CR 23152	Bore-Tite
	3.371	.438	CRW1 R	CR 23167	Bore-Tite
	3.374	.438	CRWHA1 R	CR 23169	Bore-Tite
	3.500	.313	CRW1 R	CR 23184	
	3.751	.500	CRW1 R	CR 23277	Bore-Tite
2.328	3.000	.395	CRW1 P	CR 23300	Bore-Tite
2.375	2.997	.438	CRWH1 R	CR 23632	Bore-Tite
	3.000	.375	CRW1 V	CR 23641	Bore-Tite
	3.061	.438	CRWH1 R	CR 23644	Bore-Tite
	3.061	.438	CRWH1 P	CR 23645	Bore-Tite
	3.061	.438	CRWH1 V	CR 23655	Bore-Tite
	3.125	.375	CRW1 R	CR 23646	Bore-Tite
	3.125	.375	CRW1 S	CR 23659	Bore-Tite
	3.125	.438	CRWH1 R	CR 23652	Bore-Tite
	3.125	.438	CRWHA1 R	CR 23654	Bore-Tite
	3.125	.438	CRWHA1 V	CR 23656	Bore-Tite
	3.189	.438	CRWH1 R	CR 23666	Bore-Tite
	3.251	.438	CRWHA1 V	CR 23678	Bore-Tite
	3.251	.453	CRW1 P	CR 23685	Bore-Tite
	3.350	.375	CRW1 R	CR 23701	Bore-Tite
	3.350	.375	CRWA1 R	CR 23702	Bore-Tite
	3.350	.375	CRW1 P	CR 23703	Bore-Tite
	3.350	.375	CRW1 S	CR 23706	Bore-Tite
	3.350	.438	CRWH1 R	CR 23708	Bore-Tite
	3.350	.438	CRWHA1 R	CR 23710	Bore-Tite
	3.371	.438	CRWH1 R	CR 23742	Bore-Tite
	3.371	.438	CRWH1 V	CR 23746	Bore-Tite
	3.481	.438	CRWH1 R	CR 23755	Bore-Tite
	3.481	.438	CRWHA1 R	CR 23756	
	3.500	.375	CRWA1 P	CR 23770	Bore-Tite
	3.500	.375	CRWH1 V	CR 23771	Bore-Tite
	3.500	.375	CRWH1 R	CR 23779	Bore-Tite
	3.500	.438	CRWHA1 R	CR 23782	Bore-Tite
3.543	.438	CRWH1 R	CR 23808	Bore-Tite	
3.543	.438	CRWHA1 V	CR 23809	Bore-Tite	
3.601	.438	CRW1 R	CR 23820	Bore-Tite	
3.623	.438	CRWH1 R	CR 23839	Bore-Tite	
3.623	.438	CRWHA1 P	CR 23841	Bore-Tite	

Series CRW1 – Inch sizes

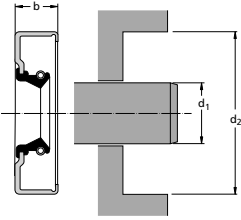

Dimensions		seal width b	Design and lip material	SKF Designation	
shaft d ₁	bore d ₂				
in					
2.375	3.623	.438	CRWHA1 V	CR 23843	Bore-Tite
	3.876	.438	CRWH1 R	CR 23844	Bore-Tite
2.438	3.125	.500	CRWH1 R	CR 24255	Bore-Tite
	3.251	.438	CRWH1 R	CR 24263	Bore-Tite
	3.350	.375	CRW1 R	CR 24286	Bore-Tite
	3.350	.375	CRWA1 R	CR 24287	Bore-Tite
	3.371	.438	CRWH1 R	CR 24320	Bore-Tite
	3.481	.438	CRWH1 R	CR 24340	Bore-Tite
	3.500	.438	CRWH1 R	CR 24370	Bore-Tite
	3.500	.438	CRWH1 V	CR 24372	Bore-Tite
	3.543	.438	CRWH1 R	CR 24445	Bore-Tite
2.500	3.189	.438	CRWH1 R	CR 24881	Bore-Tite
	3.189	.438	CRWH1 V	CR 24883	Bore-Tite
	3.245	.438	CRWH1 R	CR 24889	Bore-Tite
	3.251	.375	CRW1 R	CR 24897	Bore-Tite
	3.251	.375	CRWA1 R	CR 24898	Bore-Tite
	3.251	.375	CRWA1 V	CR 24899	Bore-Tite
	3.251	.438	CRWH1 R	CR 24910	Bore-Tite
	3.251	.438	CRWHA1 R	CR 24911	Bore-Tite
	3.251	.438	CRWH1 V	CR 24914	Bore-Tite
	3.251	.438	CRWHA1 V	CR 24916	Bore-Tite
	3.251	.500	CRW1 V	CR 24913	Bore-Tite
	3.350	.438	CRWH1 R	CR 24931	Bore-Tite
	3.350	.438	CRWHA1 R	CR 24932	Bore-Tite
	3.351	.433	CRWH1 V	CR 24926	Bore-Tite
	3.371	.375	CRWHA1 R	CR 24934	
	3.371	.438	CRWHA1 V	CR 24936	Bore-Tite
	3.371	.438	CRWH1 R	CR 24954	Bore-Tite
	3.371	.500	CRWH1 S	CR 24941	Bore-Tite
	3.428	.375	CRWA1 P	CR 24949	Bore-Tite
	3.428	.375	CRWA1 R	CR 24951	Bore-Tite
	3.500	.375	CRWA1 V	CR 24971	Bore-Tite
	3.500	.438	CRW1 R	CR 24980	Bore-Tite
	3.500	.438	CRWA1 R	CR 24982	Bore-Tite
	3.500	.438	CRWH1 V	CR 24984	Bore-Tite
	3.500	.438	CRWH1 R	CR 24986	Bore-Tite
	3.500	.438	CRWHA1 R	CR 24988	Bore-Tite
	3.500	.438	CRWH1 P	CR 24989	Bore-Tite
3.500	.438	CRWHA1 V	CR 24990	Bore-Tite	

Series CRW1 – Inch sizes

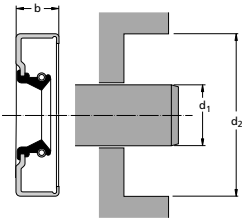

Dimensions		seal width b	Design and lip material	SKF Designation	
shaft d ₁	bore d ₂				
in					
2.500	3.502	.406	CRW1 S	CR 25082	Bore-Tite
	3.543	.438	CRWH1 R	CR 25043	Bore-Tite
	3.543	.438	CRWHA1 P	CR 25065	
	3.544	.433	CRWA1 V	CR 25037	Bore-Tite
	3.623	.375	CRW1 R	CR 25074	Bore-Tite
	3.623	.375	CRWA1 R	CR 25075	Bore-Tite
	3.623	.375	CRWA1 V	CR 25076	Bore-Tite
	3.623	.438	CRWH1 R	CR 25071	
	3.751	.438	CRWH1 R	CR 25091	
	3.876	.438	CRWH1 R	CR 25100	Bore-Tite
	3.876	.469	CRWHA1 P	CR 25102	Bore-Tite
	4.003	.375	CRWA1 R	CR 25108	Bore-Tite
	4.003	.375	CRWA1 V	CR 25110	Bore-Tite
	2.563	3.481	.500	CRWHA1 R	CR 25561
3.500		.438	CRWH1 R	CR 25577	Bore-Tite
3.623		.438	CRWH1 R	CR 25641	Bore-Tite
3.623		.469	CRWA1 P	CR 25661	Bore-Tite
3.751		.438	CRWH1 R	CR 25713	Bore-Tite
3.751		.438	CRWHA1 R	CR 25714	Bore-Tite
3.751		.438	CRWH1 V	CR 25725	Bore-Tite
3.873		.438	CRWHA1 R	CR 25745	
3.876		.438	CRWH1 R	CR 25748	Bore-Tite
2.598	3.481	.438	CRWHA1 P	CR 25970	Bore-Tite
2.607	3.350	.375	CRWH1 P	CR 25950	Bore-Tite
2.625	3.251	.438	CRWH1 R	CR 26110	Bore-Tite
	3.350	.375	CRW1 V	CR 26122	Bore-Tite
	3.350	.375	CRW1 R	CR 26123	Bore-Tite
	3.350	.375	CRWA1 R	CR 26124	Bore-Tite
	3.350	.438	CRW1 R	CR 26128	
	3.371	.438	CRWHA1 R	CR 26153	Bore-Tite
	3.374	.438	CRWHA1 R	CR 26141	Bore-Tite
	3.481	.438	CRWH1 R	CR 26163	Bore-Tite
	3.500	.375	CRW1 V	CR 26177	Bore-Tite
	3.500	.375	CRWA1 R	CR 26186	Bore-Tite
	3.500	.438	CRWH1 R	CR 26189	Bore-Tite
	3.500	.438	CRWHA1 R	CR 26190	Bore-Tite
	3.500	.438	CRWA1 P	CR 26191	Bore-Tite

Series CRW1 – Inch sizes

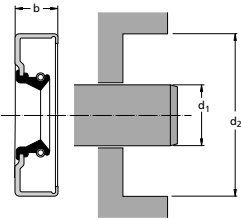

Dimensions		seal width b	Design and lip material	SKF Designation	
shaft d ₁	bore d ₂				
in					
2.625	3.543	.438	CRWH1 R	CR 26194	Bore-Tite
	3.623	.375	CRW1 V	CR 26204	Bore-Tite
	3.623	.375	CRWA1 P	CR 26220	Bore-Tite
	3.623	.375	CRW1 R	CR 26237	Bore-Tite
	3.623	.375	CRWA1 R	CR 26238	Bore-Tite
	3.623	.438	CRWH1 V	CR 26208	Bore-Tite
	3.623	.438	CRWH1 R	CR 26209	Bore-Tite
	3.623	.438	CRWHA1 R	CR 26211	Bore-Tite
	3.751	.375	CRWA1 R	CR 26284	Bore-Tite
	3.751	.438	CRWH1 R	CR 26297	Bore-Tite
	3.751	.438	CRWHA1 R	CR 26298	Bore-Tite
	3.751	.438	CRWHA1 V	CR 26299	Bore-Tite
	3.876	.438	CRWH1 R	CR 26328	Bore-Tite
	3.936	.438	CRWH1 R	CR 26346	Bore-Tite
	4.003	.375	CRWA1 R	CR 26354	Bore-Tite
	4.003	.438	CRWH1 R	CR 26356	Bore-Tite
4.370	.438	CRWHA1 R	CR 26359	Bore-Tite	
4.438	.438	CRWH1 R	CR 26368	Bore-Tite	
2.688	3.751	.438	CRWH1 R	CR 26761	Bore-Tite
	3.876	.438	CRWH1 R	CR 26921	Bore-Tite
	4.003	.469	CRWH1 R	CR 26975	Bore-Tite
2.750	3.481	.438	CRW1 R	CR 27251	
	3.500	.375	CRW1 R	CR 27268	Bore-Tite
	3.500	.375	CRWA1 R	CR 27269	Bore-Tite
	3.500	.375	CRWA1 V	CR 27272	Bore-Tite
	3.500	.438	CRWH1 R	CR 27280	Bore-Tite
	3.538	.438	CRWH1 R	CR 27284	Bore-Tite
	3.543	.438	CRWH1 P	CR 27292	Bore-Tite
	3.543	.438	CRWH1 V	CR 27293	Bore-Tite
	3.543	.438	CRWHA1 P	CR 27295	Bore-Tite
	3.544	.433	CRWHA1 V	CR 27230	Bore-Tite
	3.623	.438	CRWH1 V	CR 27324	Bore-Tite
	3.623	.438	CRWH1 R	CR 27334	Bore-Tite
	3.751	.438	CRW1 R	CR 27361	Bore-Tite
	3.751	.438	CRWA1 R	CR 27362	Bore-Tite
	3.751	.438	CRWH1 V	CR 27365	Bore-Tite
	3.751	.438	CRWH1 R	CR 27368	Bore-Tite
	3.751	.438	CRWHA1 R	CR 27370	Bore-Tite
3.751	.438	CRWA1 P	CR 27377	Bore-Tite	

Series CRW1 – Inch sizes

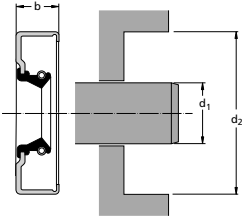

Dimensions		seal width b	Design and lip material	SKF Designation	
shaft d ₁	bore d ₂				
in					
2.750	3.765	.438	CRWH1 R	CR 27426	Bore-Tite
	3.876	.433	CRWHA1 P	CR 27452	Bore-Tite
	3.876	.438	CRWA1 R	CR 27467	Bore-Tite
	3.876	.438	CRWH1 R	CR 27470	Bore-Tite
	3.876	.438	CRWHA1 R	CR 27471	Bore-Tite
	3.936	.438	CRWH1 R	CR 27525	Bore-Tite
	3.937	.438	CRWA1 P	CR 27526	Bore-Tite
	4.003	.375	CRWA1 V	CR 27539	Bore-Tite
	4.003	.438	CRWH1 R	CR 27541	Bore-Tite
	4.003	.438	CRWHA1 P	CR 27565	
	4.249	.438	CRWH1 R	CR 27600	Bore-Tite
	4.249	.438	CRWHA1 P	CR 27601	Bore-Tite
	4.331	.500	CRWHA1 R	CR 27625	Bore-Tite
	4.500	.469	CRWH1 R	CR 28848	Bore-Tite
2.813	3.751	.438	CRWH1 R	CR 28035	Bore-Tite
	3.876	.438	CRWH1 R	CR 28116	Bore-Tite
	4.003	.438	CRWH1 R	CR 28175	Bore-Tite
	4.249	.313	CRW1 R	CR 28270	Bore-Tite
	4.249	.438	CRWH1 R	CR 28275	Bore-Tite
	4.250	.438	CRWH1 P	CR 28276	Bore-Tite
2.844	3.939	.500	CRWA1 R	CR 28425	Bore-Tite
	3.939	.550	CRWHA1 R	CR 28426	Bore-Tite
	4.003	.438	CRWH1 R	CR 28464	Bore-Tite
	4.003	.500	CRWH1 V	CR 28474	Bore-Tite
2.875	3.623	.438	CRWH1 R	CR 28654	Bore-Tite
	3.623	.438	CRWHA1 R	CR 28655	Bore-Tite
	3.751	.375	CRWA1 R	CR 28669	Bore-Tite
	3.751	.375	CRWA1 V	CR 28670	Bore-Tite
	3.751	.438	CRWH1 R	CR 28686	Bore-Tite
	3.751	.438	CRWHA1 R	CR 28687	Bore-Tite
	3.751	.438	CRWH1 P	CR 28697	Bore-Tite
	3.751	.438	CRWH1 V	CR 28698	Bore-Tite
	3.751	.438	CRWHA1 V	CR 28699	Bore-Tite
	3.876	.438	CRWH1 R	CR 28745	Bore-Tite
	3.876	.438	CRWHA1 R	CR 28746	Bore-Tite
	3.876	.438	CRWHA1 V	CR 28748	Bore-Tite
	4.003	.375	CRWA1 R	CR 28778	Bore-Tite
	4.003	.375	CRWA1 V	CR 28779	Bore-Tite

Series CRW1 – Inch sizes

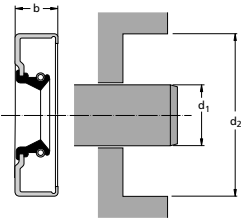

Dimensions		seal width b	Design and lip material	SKF Designation	
shaft d_1	bore d_2				
in					
2.875	4.003	.438	CRWH1 R	CR 28760	Bore-Tite
	4.003	.438	CRWHA1 R	CR 28761	Bore-Tite
	4.125	.375	CRWH1 R	CR 28817	Bore-Tite
	4.331	.438	CRWA1 P	CR 28841	Bore-Tite
2.938	3.623	.375	CRW1 R	CR 29218	Bore-Tite
	3.751	.375	CRW1 R	CR 29223	Bore-Tite
	3.751	.375	CRWA1 R	CR 29224	Bore-Tite
	3.751	.375	CRWA1 V	CR 29226	Bore-Tite
	3.876	.375	CRWHA1 R	CR 29260	
	3.876	.375	CRWHA1 V	CR 29262	Bore-Tite
	3.937	.438	CRWA1 P	CR 29273	Bore-Tite
	4.003	.438	CRWH1 R	CR 29316	Bore-Tite
	4.003	.438	CRWHA1 R	CR 29317	
	4.003	.438	CRWA1 P	CR 29322	Bore-Tite
	4.004	.433	CRWHA1 V	CR 29383	Bore-Tite
	4.125	.375	CRWH1 R	CR 29384	Bore-Tite
	4.125	.375	CRWHA1 R	CR 29385	Bore-Tite
	4.501	.438	CRWH1 R	CR 29465	Bore-Tite
3.000	3.500	.375	CRW1 V	CR 29841	Bore-Tite
	3.751	.375	CRW1 R	CR 29865	
	3.751	.375	CRWA1 R	CR 29866	Bore-Tite
	3.751	.375	CRWA1 P	CR 29867	Bore-Tite
	3.751	.375	CRW1 V	CR 29868	Bore-Tite
	3.751	.375	CRWA1 V	CR 29870	Bore-Tite
	3.751	.438	CRWH1 R	CR 29871	Bore-Tite
	3.751	.438	CRWHA1 R	CR 29872	Bore-Tite
	3.876	.313	CRW1 V	CR 29877	Bore-Tite
	3.876	.438	CRWH1 R	CR 29887	Bore-Tite
	3.876	.469	CRWH1 V	CR 29891	Bore-Tite
	4.003	.375	CRW1 R	CR 29906	Bore-Tite
	4.003	.375	CRWA1 R	CR 29907	Bore-Tite
	4.003	.375	CRWA1 V	CR 29912	Bore-Tite
	4.003	.375	CRWH1 P	CR 29950	Bore-Tite
	4.003	.438	CRWHA1 P	CR 29925	
	4.003	.438	CRWH1 R	CR 29951	
	4.003	.438	CRWHA1 R	CR 29952	Bore-Tite
	4.003	.438	CRWH1 V	CR 29958	Bore-Tite
	4.125	.438	CRWH1 R	CR 30000	Bore-Tite
4.125	.438	CRWH1 V	CR 30003	Bore-Tite	

Series CRW1 – Inch sizes

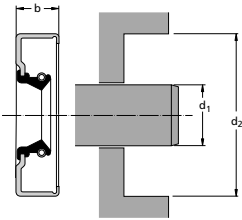

Dimensions		seal width b	Design and lip material	SKF Designation	
shaft d ₁	bore d ₂				
in					
3.000	4.249	.438	CRWH1 R	CR 30033	
	4.249	.438	CRWHA1 P	CR 30055	Bore-Tite
	4.331	.438	CRWH1 R	CR 30060	Bore-Tite
	4.376	.438	CRWH1 R	CR 30070	Bore-Tite
	4.500	.438	CRWH1 R	CR 30087	Bore-Tite
	4.500	.438	CRWHA1 R	CR 30095	Bore-Tite
	4.501	.438	CRWH1 V	CR 30098	Bore-Tite
	4.939	.750	CRWA1 P	CR 30145	Bore-Tite
	4.999	.438	CRWH1 R	CR 30125	Bore-Tite
3.125	3.811	.355	CRW1 V	CR 31132	Bore-Tite
	3.811	.355	CRW1 R	CR 31135	Bore-Tite
	4.003	.375	CRWA1 R	CR 31139	Bore-Tite
	4.003	.375	CRWHA1 V	CR 31152	Bore-Tite
	4.003	.438	CRWH1 R	CR 31147	Bore-Tite
	4.003	.438	CRWHA1 R	CR 31148	Bore-Tite
	4.125	.375	CRW1 R	CR 31177	Bore-Tite
	4.125	.375	CRWA1 V	CR 31179	Bore-Tite
	4.125	.438	CRWHA1 P	CR 31173	Bore-Tite
	4.125	.438	CRWHA1 S	CR 31185	Bore-Tite
	4.125	.438	CRWH1 R	CR 31189	
	4.249	.438	CRWH1 R	CR 31227	Bore-Tite
	4.249	.438	CRWHA1 R	CR 31228	Bore-Tite
	4.249	.438	CRWHA1 V	CR 31237	Bore-Tite
	4.376	.438	CRWH1 R	CR 31250	Bore-Tite
	4.376	.438	CRWHA1 P	CR 31261	Bore-Tite
	4.501	.438	CRWH1 R	CR 31269	Bore-Tite
	4.626	.438	CRWH1 R	CR 31299	Bore-Tite
	4.751	.438	CRWH1 R	CR 31316	Bore-Tite
4.999	.438	CRWH1 R	CR 31333	Bore-Tite	
5.251	.438	CRWH1 R	CR 31353	Bore-Tite	
3.150	3.946	.394	CRW1 V	CR 31511	Bore-Tite
3.188	4.249	.438	CRWH1 R	CR 31758	Bore-Tite
	4.376	.438	CRWH1 R	CR 31825	Bore-Tite
	4.501	.438	CRWH1 R	CR 31855	Bore-Tite
	4.626	.438	CRWH1 R	CR 31870	Bore-Tite
	4.999	.438	CRWH1 R	CR 31955	Bore-Tite

Series CRW1 – Inch sizes

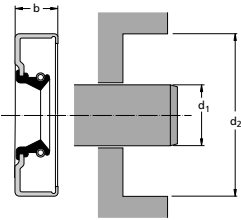

Dimensions		seal width b	Design and lip material	SKF Designation	
shaft d ₁	bore d ₂				
in					
3.250	3.876	.375	CRW1 P	CR 32330	Bore-Tite
	4.003	.375	CRW1 R	CR 32344	Bore-Tite
	4.003	.375	CRWA1 P	CR 32347	Bore-Tite
	4.249	.375	CRWA1 V	CR 32392	Bore-Tite
	4.249	.375	CRW1 R	CR 32393	Bore-Tite
	4.249	.375	CRWA1 R	CR 32395	Bore-Tite
	4.249	.438	CRWH1 P	CR 32380	
	4.249	.438	CRWHA1 P	CR 32385	Bore-Tite
	4.249	.438	CRWH1 R	CR 32396	Bore-Tite
	4.249	.438	CRWHA1 R	CR 32397	Bore-Tite
	4.249	.438	CRWH1 V	CR 32403	Bore-Tite
	4.376	.438	CRWH1 R	CR 32424	Bore-Tite
	4.500	.438	CRWA1 P	CR 32448	Bore-Tite
	4.501	.375	CRW1 R	CR 32477	Bore-Tite
	4.501	.438	CRWH1 R	CR 32501	Bore-Tite
	4.501	.438	CRWHA1 R	CR 32502	Bore-Tite
	4.626	.433	CRWHA1 R	CR 32514	
	4.626	.438	CRWH1 R	CR 32540	Bore-Tite
	4.718	.438	CRWH1 R	CR 32555	Bore-Tite
	4.751	.438	CRWHA1 R	CR 32547	Bore-Tite
4.751	.438	CRWH1 R	CR 32560	Bore-Tite	
4.999	.438	CRWH1 R	CR 32582	Bore-Tite	
4.999	.438	CRWHA1 R	CR 32583	Bore-Tite	
3.262	4.626	.500	CRWA1 R	CR 32710	
3.313	4.125	.438	CRWH1 R	CR 33033	Bore-Tite
	4.249	.438	CRWH1 R	CR 33073	Bore-Tite
	4.500	.438	CRWH1 R	CR 33136	Bore-Tite
	4.999	.438	CRWH1 R	CR 33206	Bore-Tite
	5.501	.438	CRWH1 R	CR 33250	Bore-Tite
3.375	4.125	.375	CRW1 R	CR 33645	Bore-Tite
	4.125	.375	CRWA1 V	CR 34647	Bore-Tite
	4.249	.438	CRWHA1 R	CR 33665	Bore-Tite
	4.280	.406	CRWA1 S	CR 33654	Bore-Tite
	4.376	.375	CRWA1 V	CR 33699	Bore-Tite
	4.376	.375	CRW1 R	CR 33700	Bore-Tite
	4.376	.375	CRWA1 R	CR 33701	Bore-Tite
	4.376	.438	CRWH1 R	CR 33711	Bore-Tite
	4.376	.438	CRWHA1 R	CR 33712	Bore-Tite

Series CRW1 – Inch sizes

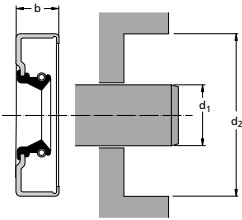

Dimensions		seal width b	Design and lip material	SKF Designation	
shaft d ₁	bore d ₂				
in					
3.375	4.501	.438	CRWA1 V	CR 33733	Bore-Tite
	4.501	.438	CRWH1 R	CR 33735	Bore-Tite
	4.626	.438	CRWH1 R	CR 33772	Bore-Tite
	4.626	.438	CRWHA1 R	CR 33773	Bore-Tite
	4.626	.438	CRWHA1 V	CR 33775	Bore-Tite
	4.686	.438	CRWH1 R	CR 33807	
	4.999	.438	CRWH1 R	CR 33837	
	5.251	.438	CRWHA1 R	CR 33866	Bore-Tite
3.438	4.249	.375	CRW1 R	CR 34256	Bore-Tite
	4.501	.375	CRWA1 R	CR 34279	Bore-Tite
	4.501	.438	CRWH1 R	CR 34282	Bore-Tite
	4.501	.438	CRWHA1 R	CR 34283	Bore-Tite
	4.626	.438	CRWH1 R	CR 34336	Bore-Tite
	4.626	.438	CRWHA1 R	CR 34338	Bore-Tite
	4.751	.438	CRWA1 R	CR 34379	Bore-Tite
	4.756	.438	CRWH1 R	CR 34383	Bore-Tite
	4.876	.438	CRWH1 R	CR 34398	Bore-Tite
	4.999	.438	CRWH1 R	CR 34407	Bore-Tite
	4.999	.438	CRWHA1 R	CR 34408	Bore-Tite
	3.500	4.249	.438	CRWHA1 V	CR 34857
4.376		.375	CRW1 R	CR 34860	Bore-Tite
4.376		.375	CRWA1 R	CR 34861	Bore-Tite
4.376		.375	CRWA1 V	CR 34866	Bore-Tite
4.376		.433	CRWHA1 V	CR 34869	Bore-Tite
4.376		.438	CRWH1 R	CR 34867	Bore-Tite
4.376		.438	CRWHA1 R	CR 34868	Bore-Tite
4.501		.375	CRWA1 V	CR 34883	Bore-Tite
4.501		.375	CRW1 R	CR 34886	Bore-Tite
4.501		.375	CRWA1 R	CR 34887	Bore-Tite
4.501		.438	CRWH1 R	CR 34888	Bore-Tite
4.501		.438	CRWHA1 R	CR 34889	Bore-Tite
4.501		.438	CRWHA1 P	CR 34891	
4.501		.438	CRWH1 V	CR 34892	Bore-Tite
4.626		.438	CRWH1 R	CR 34985	Bore-Tite
4.751		.375	CRWA1 V	CR 35039	Bore-Tite
4.751		.375	CRWA1 P	CR 35040	Bore-Tite
4.751		.438	CRWH1 R	CR 35012	Bore-Tite
4.751		.438	CRWHA1 R	CR 35020	Bore-Tite
4.751		.625	CRWH1 R	CR 35029	Bore-Tite

Series CRW1 – Inch sizes

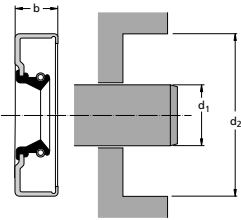

Dimensions		seal width b	Design and lip material	SKF Designation	
shaft d ₁	bore d ₂				
in					
3.500	4.999	.438	CRWA1 V	CR 35080	Bore-Tite
	4.999	.438	CRWH1 R	CR 35082	Bore-Tite
	4.999	.438	CRWHA1 P	CR 35083	Bore-Tite
	5.126	.438	CRWH1 R	CR 35086	Bore-Tite
	5.126	.438	CRWHA1 R	CR 35095	Bore-Tite
	5.251	.438	CRWH1 R	CR 35096	Bore-Tite
	5.251	.750	CRWHA11 P	CR 35098	Bore-Tite
3.563	4.501	.438	CRWH1 R	CR 35556	Bore-Tite
	4.626	.438	CRWH1 R	CR 35593	Bore-Tite
	4.751	.438	CRWH1 R	CR 35649	Bore-Tite
	4.876	.438	CRWH1 R	CR 35676	Bore-Tite
	4.999	.438	CRWH1 R	CR 35716	Bore-Tite
3.625	4.376	.375	CRWA1 V	CR 36153	Bore-Tite
	4.376	.375	CRWA1 R	CR 36155	Bore-Tite
	4.376	.375	CRWH1 R	CR 36157	Bore-Tite
	4.376	.375	CRWH1 P	CR 36158	Bore-Tite
	4.501	.375	CRW1 R	CR 36166	Bore-Tite
	4.626	.375	CRW1 R	CR 36177	Bore-Tite
	4.626	.375	CRWA1 V	CR 36179	Bore-Tite
	4.626	.438	CRWH1 R	CR 36185	Bore-Tite
	4.626	.438	CRWHA1 R	CR 36186	Bore-Tite
	4.626	.500	CRW1 P	CR 36182	Bore-Tite
	4.751	.438	CRWH1 R	CR 36220	Bore-Tite
	4.751	.500	CRWA1 S	CR 36234	Bore-Tite
	4.876	.438	CRWH1 R	CR 36314	Bore-Tite
	4.999	.375	CRWA1 V	CR 36359	Bore-Tite
	4.999	.375	CRWA1 R	CR 36361	Bore-Tite
	4.999	.438	CRWH1 R	CR 36363	Bore-Tite
	4.999	.438	CRWHA1 R	CR 36364	Bore-Tite
5.251	.375	CRWA1 R	CR 36382	Bore-Tite	
5.375	.438	CRWHA1 R	CR 36391	Bore-Tite	
3.688	4.501	.438	CRWHA1 R	CR 36740	Bore-Tite
	4.751	.438	CRWH1 R	CR 36770	Bore-Tite
	4.999	.438	CRWH1 R	CR 36880	Bore-Tite
	5.126	.438	CRWA1 R	CR 36895	Bore-Tite
	5.626	.438	CRWA1 R	CR 36910	Bore-Tite

Series CRW1 – Inch sizes

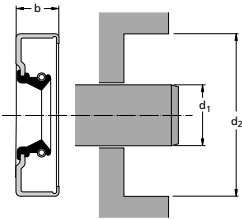

Dimensions		seal width b	Design and lip material	SKF Designation	
shaft d ₁	bore d ₂				
in					
3.750	4.501	.375	CRW1 R	CR 37327	
	4.501	.375	CRW1 V	CR 37328	Bore-Tite
	4.501	.469	CRWHA1 P	CR 37330	Bore-Tite
	4.502	.469	CRWHA1 V	CR 37332	Bore-Tite
	4.750	.438	CRWHA1 P	CR 37403	Bore-Tite
	4.751	.375	CRW1 P	CR 37387	Bore-Tite
	4.751	.375	CRW1 R	CR 37388	Bore-Tite
	4.751	.375	CRWA1 R	CR 37389	Bore-Tite
	4.751	.438	CRWA1 P	CR 37390	Bore-Tite
	4.751	.438	CRWHA1 S	CR 37395	Bore-Tite
	4.751	.438	CRWH1 R	CR 37396	Bore-Tite
	4.751	.438	CRWH1 V	CR 37405	Bore-Tite
	4.876	.438	CRWH1 R	CR 37433	Bore-Tite
	4.999	.375	CRW1 V	CR 37524	Bore-Tite
	4.999	.375	CRW1 R	CR 37525	Bore-Tite
	4.999	.375	CRWA1 R	CR 37526	Bore-Tite
	4.999	.438	CRWH1 R	CR 37532	Bore-Tite
	4.999	.438	CRWHA1 R	CR 37533	Bore-Tite
	5.251	.438	CRWH1 R	CR 37574	Bore-Tite
	5.251	.438	CRWH1 V	CR 37577	Bore-Tite
3.875	4.751	.375	CRW1 R	CR 38646	Bore-Tite
	4.751	.375	CRWA1 R	CR 38647	Bore-Tite
	4.751	.375	CRWA1 V	CR 38649	Bore-Tite
	4.751	.438	CRWH1 R	CR 38653	Bore-Tite
	4.876	.438	CRWHA1 R	CR 38673	Bore-Tite
	4.876	.500	CRWH1 R	CR 38669	Bore-Tite
	4.876	.500	CRWHA1 V	CR 38678	Bore-Tite
	4.999	.375	CRW1 R	CR 38691	Bore-Tite
	4.999	.375	CRWA1 R	CR 38692	Bore-Tite
	4.999	.375	CRWA1 V	CR 38694	Bore-Tite
	5.126	.438	CRWHA1 V	CR 38702	Bore-Tite
	5.126	.438	CRWH1 R	CR 38703	Bore-Tite
	5.126	.438	CRWHA1 R	CR 38713	Bore-Tite
	5.251	.438	CRWH1 R	CR 38730	Bore-Tite
	5.251	.438	CRWHA1 R	CR 38731	Bore-Tite
	5.251	.438	CRWHA1 P	CR 38739	Bore-Tite
	5.376	.438	CRWH1 R	CR 38745	Bore-Tite
	5.626	.433	CRWHA1 R	CR 38758	Bore-Tite
	5.690	.500	CRWH1 R	CR 38774	Bore-Tite

Series CRW1 – Inch sizes

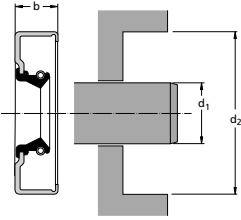

Dimensions		seal width b	Design and lip material	SKF Designation	
shaft d ₁	bore d ₂				
in					
3.938	4.876	.438	CRWH1 R	CR 39245	Bore-Tite
	4.999	.438	CRWH1 R	CR 39275	Bore-Tite
	4.999	.438	CRWH1 V	CR 39276	Bore-Tite
	4.999	.438	CRWH1 R	CR 39277	Bore-Tite
	5.126	.472	CRWHA1 V	CR 39304	Bore-Tite
	5.251	.438	CRWH1 R	CR 39320	Bore-Tite
	5.375	.438	CRWH1 R	CR 39350	Bore-Tite
	5.501	.438	CRWH1 R	CR 39423	Bore-Tite
4.000	4.876	.438	CRW1 R	CR 39851	Bore-Tite
	4.999	.375	CRW1 P	CR 39895	Bore-Tite
	4.999	.375	CRWA1 V	CR 39921	Bore-Tite
	4.999	.375	CRW1 R	CR 39922	Bore-Tite
	4.999	.375	CRWA1 R	CR 39923	Bore-Tite
	4.999	.438	CRWHA1 P	CR 39930	Bore-Tite
	4.999	.438	CRWH1 V	CR 39932	Bore-Tite
	4.999	.438	CRWH1 R	CR 39933	Bore-Tite
	4.999	.438	CRWHA1 R	CR 39934	Bore-Tite
	4.999	.438	CRWH1 S	CR 39935	Bore-Tite
	5.126	.438	CRWH1 R	CR 39975	Bore-Tite
	5.251	.438	CRWH1 V	CR 39996	Bore-Tite
	5.251	.438	CRWH1 R	CR 39997	Bore-Tite
	5.251	.438	CRWA1 R	CR 40000	Bore-Tite
	5.310	.500	CRWHA1 R	CR 40020	Bore-Tite
	5.376	.438	CRWH1 R	CR 40036	Bore-Tite
	5.501	.438	CRWH1 R	CR 40049	Bore-Tite
	5.626	.375	CRWA1 R	CR 40077	Bore-Tite
	5.626	.438	CRWH1 R	CR 40078	Bore-Tite
	5.751	.438	CRWH1 R	CR 40108	Bore-Tite
6.001	.500	CRWH1 R	CR 40138	Bore-Tite	
6.250	.500	CRWH1 R	CR 40158	Bore-Tite	
4.125	4.999	.438	CRWH1 R	CR 41125	Bore-Tite
4.125	4.999	.438	CRWH1 V	CR 41126	
	4.999	.438	CRWH1 S	CR 41130	Bore-Tite
	5.126	.438	CRWH1 R	CR 41170	Bore-Tite
	5.126	.438	CRWH1 V	CR 41171	Bore-Tite
	5.251	.438	CRWH1 R	CR 41185	Bore-Tite
	5.251	.438	CRWH1 V	CR 41186	Bore-Tite
	5.501	.438	CRWH1 R	CR 41265	Bore-Tite

Series CRW1 – Inch sizes

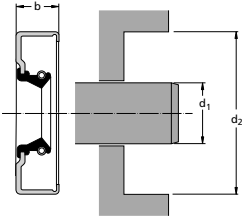

Dimensions		seal width b	Design and lip material	SKF Designation	
shaft d ₁	bore d ₂				
in					
4.125	5.501	.438	CRWH1 V	CR 41266	Bore-Tite
	5.751	.438	CRWH1 R	CR 41287	Bore-Tite
	6.001	.438	CRWH1 R	CR 41305	Bore-Tite
	6.001	.438	CRWH1 V	CR 41307	Bore-Tite
4.250	5.251	.375	CRWA1 R	CR 42419	Bore-Tite
	5.251	.375	CRW1 S	CR 42422	Bore-Tite
	5.251	.375	CRWH1 R	CR 42425	Bore-Tite
	5.251	.438	CRWH1 R	CR 42426	Bore-Tite
	5.251	.438	CRWHA1 R	CR 42427	Bore-Tite
	5.251	.438	CRWH1 V	CR 42433	Bore-Tite
	5.373	.438	CRWA1 V	CR 42474	Bore-Tite
	5.376	.438	CRWH1 R	CR 42475	Bore-Tite
	5.501	.438	CRWH1 R	CR 42528	Bore-Tite
	5.626	.438	CRWA1 R	CR 42557	Bore-Tite
	5.751	.438	CRWH1 R	CR 42573	Bore-Tite
	5.876	.500	CRWH1 V	CR 42592	Bore-Tite
	6.001	.500	CRWH1 R	CR 42616	Bore-Tite
	6.126	.500	CRWH1 R	CR 42635	Bore-Tite
6.250	.500	CRWH1 R	CR 42644	Bore-Tite	
4.313	5.501	.433	CRWHA1 P	CR 43072	Bore-Tite
	5.501	.438	CRWHA1 R	CR 43073	Bore-Tite
4.331	5.626	.472	CRWHA1 V	CR 43345	Bore-Tite
4.375	5.376	.438	CRWH1 R	CR 43650	Bore-Tite
	5.501	.438	CRWH1 R	CR 43691	Bore-Tite
	5.751	.438	CRWH1 R	CR 43751	Bore-Tite
	6.001	.500	CRWH1 R	CR 43771	Bore-Tite
	6.063	.500	CRWH1 R	CR 541974	
	6.250	.500	CRWH1 R	CR 43820	Bore-Tite
4.438	5.501	.500	CRWH1 R	CR 44275	Bore-Tite
	5.501	.500	CRWH1 V	CR 44276	Bore-Tite
	5.751	.500	CRWH1 R	CR 44295	Bore-Tite
	6.001	.500	CRWH1 R	CR 44320	Bore-Tite
	6.250	.500	CRWH1 R	CR 44350	Bore-Tite
4.477	6.250	.500	CRWH1 R	CR 44630	Bore-Tite

Series CRW1 – Inch sizes

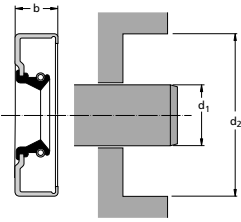

Dimensions		seal width b	Design and lip material	SKF Designation	
shaft d ₁	bore d ₂				
in					
4.500	5.251	.438	CRWH1 R	CR 44913	Bore-Tite
	5.251	.438	CRWHA1 V	CR 44917	Bore-Tite
	5.376	.438	CRWH1 R	CR 44920	Bore-Tite
	5.376	.438	CRWHA1 V	CR 44926	Bore-Tite
	5.501	.375	CRW1 R	CR 44959	Bore-Tite
	5.501	.375	CRWA1 R	CR 44960	Bore-Tite
	5.501	.435	CRWH1 V	CR 44980	Bore-Tite
	5.501	.438	CRWH1 R	CR 44967	Bore-Tite
	5.501	.438	CRWHA1 R	CR 44968	Bore-Tite
	5.501	.438	CRWH1 V	CR 44973	Bore-Tite
	5.626	.438	CRWH1 R	CR 45032	Bore-Tite
	5.626	.438	CRWHA1 V	CR 45033	Bore-Tite
	5.751	.375	CRWA1 V	CR 45064	Bore-Tite
	5.751	.438	CRWH1 R	CR 45069	Bore-Tite
	5.751	.438	CRWHA1 R	CR 45070	Bore-Tite
	6.001	.500	CRWH1 R	CR 45110	Bore-Tite
	6.001	.500	CRWHA1 R	CR 45111	Bore-Tite
	6.001	.500	CRWHA1 V	CR 45112	Bore-Tite
6.126	.563	CRWH1 R	CR 45140	Bore-Tite	
6.250	.500	CRWH1 R	CR 45150	Bore-Tite	
4.625	5.626	.500	CRWH1 R	CR 46144	Bore-Tite
	5.626	.500	CRWH1 V	CR 46155	Bore-Tite
	5.751	.500	CRWH1 R	CR 46200	Bore-Tite
	5.751	.500	CRWH1 S	CR 46208	Bore-Tite
	6.001	.500	CRWH1 R	CR 46285	Bore-Tite
	6.250	.500	CRWH1 R	CR 46324	Bore-Tite
4.688	5.751	.512	CRWH1 S	CR 46790	Bore-Tite
	5.751	.512	CRWH1 R	CR 46800	Bore-Tite
	6.250	.500	CRWH1 R	CR 46950	Bore-Tite
4.750	5.749	.438	CRW1 P	CR 47375	Bore-Tite
	5.751	.500	CRW1 V	CR 47379	Bore-Tite
	5.751	.500	CRWA1 V	CR 47382	Bore-Tite
	5.751	.500	CRW1 R	CR 47383	Bore-Tite
	5.751	.500	CRWH1 R	CR 47394	Bore-Tite
	5.751	.500	CRWHA1 R	CR 47395	Bore-Tite
	5.875	.500	CRWH1 R	CR 47441	Bore-Tite
	6.001	.500	CRWH1 R	CR 47474	Bore-Tite
	6.001	.500	CRWHA1 R	CR 47475	Bore-Tite

Series CRW1 – Inch sizes

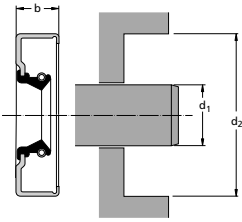

Dimensions		seal width b	Design and lip material	SKF Designation	
shaft d ₁	bore d ₂				
in					
4.750	6.001	.500	CRW1 V	CR 47481	Bore-Tite
	6.250	.500	CRWH1 R	CR 47583	Bore-Tite
	6.250	.500	CRWHA1 V	CR 47586	Bore-Tite
4.813	5.751	.563	CRWH1 P	CR 48060	Bore-Tite
	5.751	.563	CRWH1 V	CR 48062	Bore-Tite
	5.751	.563	CRWH1 S	CR 48065	Bore-Tite
4.875	6.001	.500	CRWH1 V	CR 48692	Bore-Tite
	6.001	.500	CRWH1 R	CR 48693	Bore-Tite
	6.126	.500	CRWH1 R	CR 48726	Bore-Tite
	6.250	.500	CRWHA1 R	CR 48768	Bore-Tite
	6.250	.500	CRWH1 R	CR 48769	Bore-Tite
	6.250	.500	CRWH1 V	CR 48772	Bore-Tite
4.921	6.375	.500	CRWHA1 V	CR 49274	Bore-Tite
4.938	6.001	.500	CRWH1 R	CR 49251	Bore-Tite
	6.250	.500	CRWH1 R	CR 49301	Bore-Tite
5.000	6.001	.500	CRWHA1 V	CR 49927	Bore-Tite
	6.001	.500	CRWH1 R	CR 49928	Bore-Tite
	6.001	.500	CRWHA1 R	CR 49929	Bore-Tite
	6.126	.500	CRW1 V	CR 49960	Bore-Tite
	6.250	.500	CRWH1 R	CR 49966	Bore-Tite
	6.250	.500	CRW1 R	CR 49984	Bore-Tite
	6.250	.500	CRWA1 R	CR 49985	Bore-Tite
	6.250	.500	CRWH1 P	CR 49990	
	6.250	.500	CRWH1 V	CR 49991	Bore-Tite
	6.250	.500	CRWHA1 R	CR 49998	Bore-Tite
	6.375	.500	CRWH1 R	CR 50130	Bore-Tite
	6.375	.500	CRWHA1 R	CR 50138	Bore-Tite
	6.500	.500	CRWH1 R	CR 50148	Bore-Tite
6.500	.500	CRWH1 V	CR 50151	Bore-Tite	
6.750	.500	CRWH1 R	CR 50168	Bore-Tite	
6.750	.500	CRWHA1 R	CR 50172	Bore-Tite	
5.063	6.126	.500	CRWH1 R	CR 50618	Bore-Tite
	6.375	.500	CRWH1 V	CR 50646	Bore-Tite
	6.375	.500	CRWH1 R	CR 50650	Bore-Tite

Series CRW1 – Inch sizes

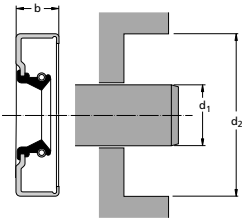

Dimensions		seal width b	Design and lip material	SKF Designation	
shaft d ₁	bore d ₂				
in					
5.125	6.126	.500	CRWHA1 R	CR 51240	Bore-Tite
	6.126	.500	CRW1 V	CR 51243	Bore-Tite
	6.126	.500	CRW1 R	CR 51247	Bore-Tite
	6.250	.500	CRWHA1 R	CR 51252	Bore-Tite
	6.250	.500	CRWA1 V	CR 51253	Bore-Tite
	6.375	.500	CRWH1 R	CR 51248	
	6.375	.500	CRWH1 V	CR 51255	Bore-Tite
5.188	6.501	.625	CRWH1 R	CR 51851	Bore-Tite
	6.501	.625	CRWH1 V	CR 51852	Bore-Tite
5.250	6.001	.375	CRW1 R	CR 52440	Bore-Tite
	6.001	.500	CRWH1 V	CR 52443	Bore-Tite
	6.250	.500	CRWH1 R	CR 52445	Bore-Tite
	6.250	.500	CRWH1 V	CR 52447	Bore-Tite
	6.500	.500	CRWH1 R	CR 52488	Bore-Tite
	6.500	.500	CRWH1 V	CR 52489	Bore-Tite
	6.750	.500	CRWH1 R	CR 52648	Bore-Tite
	6.750	.500	CRWH1 V	CR 52649	Bore-Tite
5.375	6.625	.500	CRWH1 R	CR 53701	Bore-Tite
	6.625	.500	CRWH1 V	CR 53702	Bore-Tite
	6.750	.500	CRWH1 V	CR 53771	Bore-Tite
	6.750	.500	CRWH1 R	CR 53775	Bore-Tite
5.500	6.250	.500	CRWA1 R	CR 54925	Bore-Tite
	6.500	.500	CRWH1 R	CR 54931	Bore-Tite
	6.500	.500	CRWH1 V	CR 54934	Bore-Tite
	6.500	.500	CRWH1 P	CR 54936	Bore-Tite
	6.750	.500	CRW1 R	CR 54959	Bore-Tite
	6.750	.500	CRWA1 R	CR 54960	Bore-Tite
	6.750	.500	CRWHA1 R	CR 54971	Bore-Tite
	6.750	.500	CRWH1 R	CR 54972	Bore-Tite
	6.750	.500	CRWH1 V	CR 54974	Bore-Tite
5.512	6.693	.472	CRWH1 V	CR 546747	
5.625	6.625	.500	CRWH1 R	CR 56101	Bore-Tite
	6.625	.500	CRWH1 V	CR 56102	Bore-Tite
	6.875	.500	CRWH1 R	CR 56136	Bore-Tite
	6.875	.500	CRWH1 V	CR 56137	Bore-Tite

Series CRW1 – Inch sizes

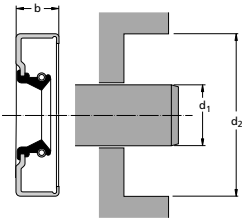

Dimensions		seal width b	Design and lip material	SKF Designation	
shaft d ₁	bore d ₂				
in					
5.625	7.125	.500	CRWHA1 R	CR 56160	Bore-Tite
	7.125	.500	CRWHA1 V	CR 56161	Bore-Tite
5.750	6.625	.500	CRWH1 R	CR 57505	Bore-Tite
	6.625	.500	CRW1 V	CR 57506	Bore-Tite
	6.750	.500	CRWH1 R	CR 57510	Bore-Tite
	6.750	.500	CRWH1 V	CR 57522	Bore-Tite
	6.751	.500	CRWHA1 R	CR 57509	
	7.000	.500	CRWH1 R	CR 57521	Bore-Tite
	7.000	.500	CRWH1 V	CR 57523	Bore-Tite
	7.000	.500	CRWHA1 R	CR 57531	Bore-Tite
5.875	7.125	.500	CRWH1 R	CR 58716	Bore-Tite
	7.125	.500	CRWH1 V	CR 58717	Bore-Tite
	7.125	.500	CRWHA1 R	CR 58741	Bore-Tite
	7.500	.500	CRWH1 R	CR 58760	Bore-Tite
	7.500	.500	CRWH1 V	CR 58761	Bore-Tite
6.000	6.750	.500	CRWA1 V	CR 59999	Bore-Tite
	6.750	.500	CRW1 V	CR 60000	Bore-Tite
	7.500	.500	CRWA1 R	CR 60016	Bore-Tite
	7.500	.500	CRWHA1 V	CR 60026	Bore-Tite
	7.500	.500	CRWH1 R	CR 60027	
	7.500	.500	CRWHA1 R	CR 60028	Bore-Tite
6.125	7.125	.625	CRWH1 R	CR 61210	
	7.625	.625	CRWH1 R	CR 61255	
	7.625	.625	CRWH1 P	CR 61256	
6.250	7.252	.500	CRWH1 R	CR 62482	
	7.500	.500	CRWH1 R	CR 62495	
	7.500	.500	CRWH1 V	CR 62497	
	7.750	.500	CRWH1 R	CR 62535	Bore-Tite
	7.875	.625	CRWH1 R	CR 62572	Bore-Tite
6.375	7.375	.625	CRWH1 R	CR 63700	Bore-Tite
	7.375	.625	CRWH1 V	CR 63705	Bore-Tite
	7.875	.563	CRWHA1 R	CR 63734	Bore-Tite
	7.875	.625	CRWH1 R	CR 63733	

Series CRW1 – Inch sizes

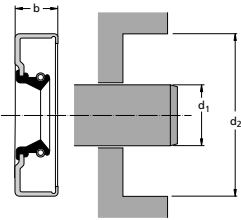

Dimensions		seal width b	Design and lip material	SKF Designation	
shaft d ₁	bore d ₂				
in					
6.500	7.500	.500	CRWA1 R	CR 64993	Bore-Tite
	7.500	.500	CRWH1 R	CR 64994	
	7.500	.500	CRWH1 V	CR 64998	Bore-Tite
	8.000	.500	CRW1 R	CR 65021	Bore-Tite
	8.000	.500	CRWH1 R	CR 65036	
	8.000	.500	CRWHA1 R	CR 65037	
6.625	8.125	.500	CRWH1 R	CR 66241	
6.750	8.000	.500	CRWH1 R	CR 67515	Bore-Tite
	8.250	.500	CRWH1 R	CR 67533	
	8.419	1.563	CRWH19 R	CR 67540	Bore-Tite
6.875	8.375	.500	CRWH1 R	CR 68745	
7.000	8.000	.630	CRWH1 R	CR 70016	Bore-Tite
	8.250	.625	CRW1 R	CR 70026	Bore-Tite
	8.250	.625	CRWH1 R	CR 70028	
	8.500	.500	CRWA1 R	CR 70080	Bore-Tite
	8.500	.625	CRW1 R	CR 70050	Bore-Tite
	8.500	.625	CRWH1 R	CR 70052	Bore-Tite
	8.500	.625	CRWHA1 R	CR 70053	Bore-Tite
	8.500	.625	CRWHA1 V	CR 70054	Bore-Tite
7.125	8.625	.625	CRWH1 R	CR 71245	
7.250	8.250	.625	CRW1 R	CR 72515	
	8.750	.625	CRWHA1 R	CR 72539	Bore-Tite
	8.750	.750	CRWH1 P	CR 72542	
	9.055	.625	CRWHA1 R	CR 72570	Bore-Tite
7.375	8.875	.625	CRWH1 R	CR 73745	
7.500	8.500	.625	CRWH1 R	CR 75030	
	9.000	.625	CRWH1 R	CR 75050	Bore-Tite
	9.000	.625	CRWHA1 P	CR 75052	Bore-Tite
7.625	8.625	.563	CRWH1 R	CR 76215	
	9.125	.625	CRWH1 R	CR 76255	
7.750	9.250	.625	CRWH1 R	CR 77540	

Series CRW1 – Inch sizes

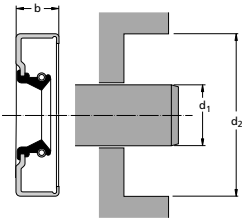

Dimensions		seal width b	Design and lip material	SKF Designation	
shaft d ₁	bore d ₂				
in					
7.875	9.250	1.000	CRWHA1 R	CR 78725	
	9.375	.625	CRWH1 R	CR 78738	
8.000	9.000	.625	CRWH1 R	CR 79960	
	9.000	.625	CRWHA1 R	CR 79961	
	9.250	.625	CRWH1 R	CR 79997	
	9.250	.625	CRWHA1 R	CR 79998	Bore-Tite
	9.500	.625	CRWH1 R	CR 80010	Bore-Tite
	10.000	.625	CRWH1 R	CR 80037	Bore-Tite
	10.000	.625	CRWHA1 R	CR 80038	
8.125	10.125	.625	CRWH1 R	CR 81245	
	10.125	.625	CRWHA1 R	CR 81246	
8.250	9.250	.625	CRWH1 R	CR 82510	
	9.252	.500	CRWH1 R	CR 82512	Bore-Tite
	9.500	.578	CRW1 R	CR 82521	
	10.250	.625	CRWH1 R	CR 82560	
8.500	9.750	.625	CRWH1 R	CR 85002	Bore-Tite
	10.000	.625	CRWH1 R	CR 85009	
	10.500	.625	CRWA1 R	CR 85014	
	10.500	.625	CRWH1 R	CR 85015	
	10.625	.625	CRWHA1 R	CR 85085	
8.625	10.625	.625	CRWH1 R	CR 86260	
8.750	10.750	.625	CRWH1 R	CR 87541	
8.875	10.125	.625	CRWH1 R	CR 88710	
	10.875	.625	CRWH1 R	CR 88760	
9.000	10.000	.625	CRWH1 R	CR 90006	
	11.000	.625	CRWH1 R	CR 90036	
9.250	11.250	.625	CRWHA1 R	CR 92536	Bore-Tite
	12.750	.625	CRWHA1 R	CR 92570	
	12.750	1.250	CRWHA1 R	CR 92574	
9.500	10.500	.438	CRW1 R	CR 95048	Bore-Tite
	11.500	.625	CRW1 R	CR 95062	Bore-Tite

Series CRW1 – Inch sizes

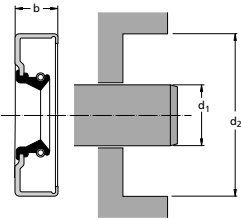

Dimensions				
shaft	bore	seal width	Design and	SKF Designation
d_1	d_2	b	lip material	
in				
9.625	11.625	.625	CRWH1 R	CR 96245
	11.125	.625	CRWH1 R	CR 97542
	11.250	.625	CRWH1 R	CR 97545
	11.750	.625	CRWH1 R	CR 97550
10.000	11.252	.625	CRWHA1 R	CR 100044
	12.000	.625	CRWH1 R	CR 100051
	12.000	.625	CRWA1 R	CR 100075
Bore-Tite				
10.250	11.250	.563	CRWH1 R	CR 102520
	12.250	.625	CRWH1 R	CR 102540
10.500	11.750	.625	CRWH1 R	CR 105010
	12.500	.625	CRWH1 R	CR 105051
10.750	12.750	.625	CRWH1 R	CR 107551
11.000	12.250	.625	CRWHA1 R	CR 110030
	13.000	.625	CRWH1 R	CR 110051
11.375	13.000	.625	CRW1 R	CR 113740
11.500	13.000	.625	CRWH1 R	CR 115021
	13.500	.625	CRWH1 R	CR 115041
12.000	14.000	.625	CRW1 R	CR 120060
12.250	13.375	.625	CRWH1 R	CR 122555
	13.813	.625	CRW1 R	CR 122580
	14.250	1.000	CRWHA1 R	CR 122590

Series CRW5

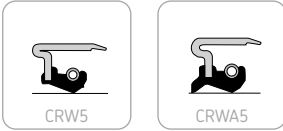

Features

Radial shaft seals for applications where pressure differential across the seal is moderate. Wavesal lip for reduced heat generation and steel shell for easy installation and a firm and accurate seating in the housing bore.

Primarily for lubricant retention, but the CRWA5 design will also exclude dust and light contamination. Where there is a pressure differential across the seal, the seal should be axially secured in the housing bore.

CRW5: Seal with steel shell, Bore-Tite coated outside diameter, hydrodynamically formed Wavesal lip and carbon steel garter spring.

CRWA5: Seal with steel shell, Bore-Tite coated outside diameter, hydrodynamically formed Wavesal lip, carbon steel garter spring and non-rubbing secondary lip.

Series CRW5 is only available in a limited range of inch sizes.

Further information about material, application and operating conditions for SKF CRW5 and CRWA5 seals is shown in the seal selection chart on **page 98**.

Series CRW5 – Inch sizes

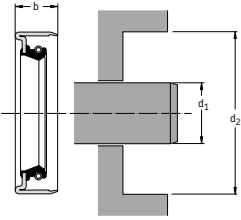

Dimensions		seal width b	Design and lip material	SKF Designation	
shaft d ₁	bore d ₂				
in					
.313	.686	.313	CRWA5 R	CR 3094	
	.749	.250	CRWA5 R	CR 3101	
	.749	.250	CRWA5 V	CR 3103	
	.999	.313	CRWA5 R	CR 3171	
.375	.749	.250	CRW5 R	CR 3689	
	1.124	.375	CRW5 V	CR 3807	Bore-Tite
.500	.875	.313	CRWA5 R	CR 4940	Bore-Tite
	.875	.313	CRWA5 V	CR 4941	
	.999	.250	CRWA5 V	CR 4991	Bore-Tite
	.999	.313	CRWA5 R	CR 4996	Bore-Tite
	1.124	.250	CRWA5 R	CR 5069	Bore-Tite
	1.124	.250	CRWA5 V	CR 5072	Bore-Tite
.625	.999	.250	CRWA5 R	CR 6151	Bore-Tite
	1.124	.250	CRW5 R	CR 6191	Bore-Tite
	1.124	.374	CRWA5 V	CR 6231	Bore-Tite
	1.124	.375	CRWA5 R	CR 6229	Bore-Tite
	1.126	.250	CRW5 R	CR 6232	Bore-Tite
	1.250	.313	CRWA5 R	CR 6280	
	1.250	.313	CRWA5 V	CR 6285	
	1.375	.250	CRW5 P	CR 6371	Bore-Tite
	1.375	.375	CRWA5 R	CR 6388	Bore-Tite
	1.500	.313	CRW5 V	CR 6393	Bore-Tite
.750	1.250	.250	CRWA5 R	CR 7434	Bore-Tite
	1.250	.375	CRWA5 R	CR 7449	Bore-Tite
	1.375	.250	CRWA5 V	CR 7509	Bore-Tite
.875	1.250	.250	CRWA5 V	CR 8634	Bore-Tite
	1.375	.250	CRWA5 R	CR 8660	Bore-Tite
	1.375	.250	CRWA5 V	CR 8665	Bore-Tite
	1.497	.313	CRWA5 V	CR 8694	Bore-Tite
.984	1.596	.250	CRWA5 R	CR 9700	Bore-Tite
	1.752	.313	CRWA5 V	CR 9805	Bore-Tite

Series CRW5 – Inch sizes

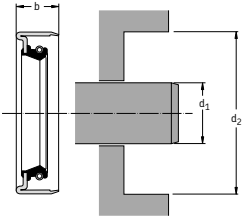

Dimensions					
shaft	bore	seal width	Design and	SKF Designation	
d_1	d_2	b	lip material		
in					
1.000	1.375	.250	CRWA5 R	CR 9814	Bore-Tite
	1.499	.250	CRWA5 R	CR 9843	Bore-Tite
	1.499	.250	CRW5 R	CR 9855	
	1.499	.250	CRWA5 V	CR 9858	Bore-Tite
	1.500	.250	CRWA5 R	CR 9863	Bore-Tite
	1.752	.313	CRWA5 R	CR 9967	Bore-Tite
	2.000	.313	CRWA5 R	CR 10131	Bore-Tite
1.125	1.626	.250	CRWA5 V	CR 11139	Bore-Tite
1.250	1.687	.313	CRWA5 R	CR 12333	Bore-Tite
	1.750	.250	CRWA5 V	CR 12339	Bore-Tite
	1.750	.250	CRWA5 R	CR 12360	Bore-Tite
	1.997	.438	CRWA5 V	CR 12438	Bore-Tite
	2.328	.500	CRWA5 R	CR 12609	Bore-Tite
	2.502	.500	CRWA5 R	CR 12640	Bore-Tite
1.500	1.997	.250	CRWA5 V	CR 14844	Bore-Tite
	2.064	.375	CRWA5 V	CR 14868	Bore-Tite
	2.311	.500	CRWA5 V	CR 14979	Bore-Tite
	2.328	.500	CRWA5 R	CR 14977	Bore-Tite
1.625	2.125	.256	CRWA5 R	CR 16093	Bore-Tite
1.750	2.502	.500	CRWA5 R	CR 17374	Bore-Tite
1.938	2.675	.250	CRWA5 R	CR 19213	Bore-Tite
	2.835	.250	CRWA5 R	CR 19278	Bore-Tite
2.500	3.251	.350	CRWA5 R	CR 24892	Bore-Tite

Series HMS4 and HMSA7



Series HMS4 and HMSA7 are complementary designs to the new developed series HMS5 and HMSA10 and are suitable as spare parts in older applications.

HMS4: Seal with outside diameter of elastomeric material, carbon steel reinforcement ring, garter spring of carbon steel or stainless steel and conventional sealing lip.

HMSA7: Seal with outside diameter of elastomeric material, carbon steel reinforcement ring, garter spring of carbon steel or stainless steel, conventional sealing lip and a secondary, contacting (dust) lip.

Both HMS4 and HMSA7 are available in sealing lip material R (NBR) for general purpose and in our lip material V (FPM) for higher operating temperature and for extended chemical resistance.

Further information about material, application and operating conditions for HMS4 and HMSA7 seals is shown in the seal selection chart on **page 98**.

Series HMS4 and HMSA7- Metric sizes

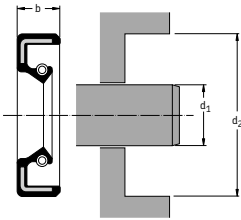

Dimensions shaft d_1	bore d_2	seal width b	Design and lip material	SKF Designation
mm				
10	24	7	HMS4 R	CR 10×24×7 HMS4 R
	26	7	HMS4 R	CR 10×26×7 HMS4 R
12	24	7	HMS4 R	CR 12×24×7 HMS4 R
17	28	7	HMS4 R	CR 17×28×7 HMS4 R
	40	10	HMS4 R	CR 17×40×10 HMS4 R
19	32	7	HMS4 R	CR 19×32×7 HMS4 R
25	52	8	HMS4 R	CR 25×52×8 HMS4 R
	52	10	HMS4 R	CR 25×52×10 HMS4 R
27	42	10	HMS4 R	CR 27×42×10 HMS4 R
28	40	7	HMS4 R	CR 28×40×7 HMS4 R
30	47	7	HMSA7 V	CR 30×47×7 HMSA7 V
	62	10	HMS4 R	CR 30×62×10 HMS4 R
33	50	6	HMSA7 R	CR 33×50×6 HMSA7 R
42	72	8	HMS4 R	CR 42×72×8 HMS4 R
45	85	10	HMS4 R	CR 45×85×10 HMS4 R
65	95	10	HMS4 R	CR 65×95×10 HMS4 R
80	110	12	HMS4 R	CR 80×110×12 HMS4 R
85	110	12	HMS4 R	CR 85×110×12 HMS4 R
120	150	12	HMS4 V	CR 120×150×12 HMS4 V
140	160	13	HMS4 R	CR 140×160×13 HMS4 R
230	260	15	HMS4 R	CR 230×260×15 HMS4 R

Series HMS4 and HMSA7 – Inch sizes

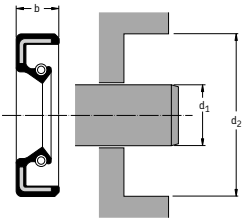

Dimensions			Design and lip material	SKF Designation
shaft	bore	seal width		
d ₁	d ₂	b		
in				
.370	.606	.310	HMSA76 R	CR 3626
.500	1.010	.204	HMSA7 V	CR 5008
.685	1.181	.276	HMSA7 R	CR 6757
.736	1.378	.276	HMSA7 R	CR 7400
.748	1.496	.300	HMSA7 R	CR 7251
.813	1.250	.375	HMS4 R	CR 8019
.906	1.338	.315	HMSA7 R	CR 9065
	1.339	.256	HMS4 R	CR 9006
	1.383	.250	HMS4 P	CR 9010
	1.575	.276	HMSA7 P	CR 9068
.984	1.496	.236	HMSA7 V	CR 9701
1.000	2.441	.375	HMSA7 R	CR 10178
1.063	1.575	.315	HMSA7 V	CR 10584
	1.693	.355	HMSA7 P	CR 10634
1.102	1.614	.276	HMSA7 P	CR 10944
	1.693	.276	HMSA7 P	CR 10494
	1.693	.315	HMSA7 R	CR 10927
1.125	1.630	.313	HMS4N R	CR 11143
1.142	1.693	.315	HMSA7 P	CR 11422
	1.772	.315	HMSA7 V	CR 11429
	2.047	.433	HMSA7 R	CR 14116
1.181	1.693	.315	HMSA7 V	CR 11672
	1.732	.276	HMSA7 P	CR 11612
	1.772	.276	HMS47 R	CR 11691
	1.772	.276	HMSA7 P	CR 11589
	2.126	.354	HMSA7 P	CR 11673
	2.126	.354	HMSA7 R	CR 11674
1.221	1.811	.315	HMSA7 S	CR 12301
1.250	1.752	.313	HMS4 R	CR 12371
	1.752	.391	HMSA7 R	CR 12355
	2.835	.375	HMSA7 R	CR 12668

Series HMS4 and HMSA7 – Inch sizes

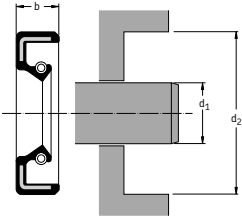

Dimensions			Design and lip material	SKF Designation
shaft	bore	seal width		
d_1	d_2	b		
in				
1.260	1.732	.236	HMSA7 P	CR 12706
	1.811	.236	HMSA7SP P	CR 12718
	2.087	.276	HMSA7 P	CR 12747
1.281	2.000	.375	HMSA7 R	CR 12830
1.299	1.810	.276	HMSA7 R	CR 12812
	1.850	.313	HMSA7 P	CR 12886
1.301	1.969	.469	HMSA7 R	CR 12900
1.339	1.929	.315	HMSA7 P	CR 13427
	2.087	.315	HMSA7 R	CR 13435
1.375	2.063	.374	HMS4 R	CR 13596
1.378	1.614	.359	HMS41 R	CR 13911
	1.851	.276	HMSA7 R	CR 555364
	1.929	.236	HMSA7 R	CR 13857
	1.969	.275	HMS4 S	CR 13943
	2.097	.313	HMSA7 P	CR 13953
	2.165	.433	HMSA7 R	CR 550233
1.417	1.732	.197	HMSA7 R	CR 14058
	1.811	.394	HMSA7 P	CR 14033
	1.929	.276	HMSA7 P	CR 14008
	3.543	.394	HMSA7SP R	CR 14087
1.418	2.521	.512	HMSA7 R	CR 550218
1.437	2.012	.312	HMSA7SP V	CR 14215
1.457	1.987	.276	HMSA7 P	CR 14477
	2.000	.276	HMSA7 R	CR 14601
	2.205	.354	HMS4 R	CR 14566
	3.071	.472	HMS4SPL R	CR 14484
1.496	1.969	.315	HMSA7 S	CR 14713
	2.087	.304	HMSA7 V	CR 14759
	2.362	.433	HMSA7SP S	CR 14756
1.504	1.937	.475	HMSA76 P	CR 15270
1.515	2.087	.315	HMSA7 P	CR 15500

Series HMS4 and HMSA7 – Inch sizes

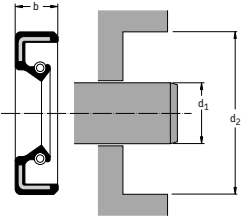

Dimensions		seal width b	Design and lip material	SKF Designation	
shaft d ₁	bore d ₂				
in					
1.535	1.969	.276	HMSA7 V	CR 15451	
	2.047	.276	HMSA7 P	CR 15300	
1.552	2.447	.500	HMSA78 RT	CR 15440	
1.575	2.047	.276	HMSA7 V	CR 15800	
	2.126	.394	HMSA7 P	CR 15881	
	2.165	.236	HMSA7 V	CR 15818	
	2.205	.276	HMS4 R	CR 550259	
	2.283	.236	HMSA7 P	CR 15736	
	2.461	.433	HMSA7 R	CR 15558	
1.594	2.067	.236	HMSA7 P	CR 15910	
	2.283	.315	HMSA7 P	CR 15920	
1.614	2.126	.236	HMSA7 P	CR 16003	
	2.323	.315	HMS4 R	CR 16023	
1.654	2.323	.303	HMS4 R	CR 16536	
	2.362	.335	HMSA7 V	CR 16533	
	2.480	.276	HMS4 R	CR 550253	
1.685	2.165	.433	HMSA7 R	CR 16620	
1.688	2.551	.470	HMSA7 R	CR 16735	
1.693	2.146	.236	HMSA7 V	CR 16889	
	2.165	.315	HMSA7 V	CR 16893	
1.732	2.165	.236	HMSA7 P	CR 17122	
	2.320	.260	HMS4 R	CR 17134	
	2.362	.394	HMSA7 V	CR 17330	
	3.622	.748	HMSA7SP R	CR 17193	Bore-Tite
1.772	2.638	.315	HMSA7 V	CR 17907	
	2.638	.394	HMSA7 V	CR 17921	
	2.638	.472	HMSA7S V	CR 17916	
	3.130	.571	HMSA7S V	CR 17683	
1.811	2.283	.276	HMSA7 R	CR 17897	
	2.480	.300	HMS4 P	CR 18014	
	3.543	.630	HMSA7SP P	CR 18000	
1.875	2.716	.394	HMSA7 P	CR 18623	
	2.830	.391	HMS4 R	CR 550185	

Series HMS4 and HMSA7 – Inch sizes

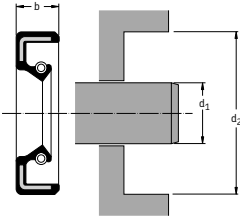

Dimensions			Design and	SKF Designation
shaft	bore	seal width	lip material	
d_1	d_2	b		
in				
1.890	2.362	.276	HMSA7 P	CR 18897
	2.624	.315	HMS4 S	CR 18895
1.929	2.441	.441	HMSA7 P	CR 19097
2.045	2.835	.618	HMSA7SP P	CR 20445
2.047	2.677	.512	HMSA7SP R	CR 20428
2.063	2.661	.188	HMS4 R	CR 20525
2.086	2.685	.276	HMSA7 R	CR 20906
2.125	2.953	.472	HMSA7 P	CR 21128
2.205	2.843	.315	HMS4SPL P	CR 22024
	2.953	.433	HMSA7SP R	CR 22031
2.244	2.638	.236	HMSA7 R	CR 22225
2.283	2.910	.390	HMSA7 P	CR 22842
	2.953	.276	HMS4SPL P	CR 22840
	3.197	.197	HMS4 S	CR 22837
2.323	3.937	.394	HMSA7SP P	CR 23286
2.362	3.228	.472	HMSA7 S	CR 23446
2.519	5.236	.511	HMSA7SP R	CR 25190
2.520	3.150	.315	HMS4 S	CR 25171
2.559	3.189	.276	HMSA7 P	CR 25518
	3.307	.354	HMSA7 S	CR 25419
2.638	3.503	.354	HMSA7 P	CR 26387
2.677	3.307	.335	HMSA7 S	CR 26625
2.717	3.380	.310	HMSA7 V	CR 26749
	3.386	.315	HMSA7 P	CR 26748
2.756	3.425	.335	HMSA7 S	CR 27723
	3.844	.315	HMSA7 R	CR 27764
2.832	3.622	.374	HMSA7 V	CR 28332

Bore-Tite

Series HMS4 and HMSA7 – Inch sizes

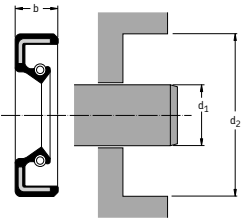

Dimensions		seal width b	Design and lip material	SKF Designation
shaft d_1	bore d_2			
in				
2.835	3.780	.354	HMSA7 P	CR 28308
2.913	3.858	.472	HMSA7 P	CR 29112
2.992	3.623	.385	HMSA7 V	CR 29862
	3.858	.472	HMSA7 S	CR 29685
3.040	3.937	.250	HMS4 R	CR 30360
3.071	6.417	.630	HMSA7SP R	CR 30771
3.150	3.780	.354	HMSA7 V	CR 31506
	3.858	.393	HMSA7 V	CR 31507
3.228	3.791	.315	HMSA7 P	CR 32283
	3.920	.500	HMSA7 V	CR 32289
3.268	3.937	.354	HMSA7 V	CR 32715
3.307	4.094	.433	HMSA7 R	CR 33405
3.346	4.094	.354	HMSA7 P	CR 33454
3.375	3.948	.375	HMSA7 P	CR 33628
3.386	4.055	.315	HMSA7 V	CR 33861
3.425	3.937	.295	HMSA7 V	CR 34115
	3.937	.315	HMSA7 S	CR 34120
3.465	4.252	.427	HMS4 V	CR 34611
	4.252	.453	HMSA7 V	CR 34116
3.543	4.134	.394	HMSA7 V	CR 35405
	4.331	.354	HMSA7 S	CR 35409
	4.528	.512	HMSA7 P	CR 35422
3.583	4.370	.410	HMSA7 V	CR 35910
3.622	4.331	.374	HMSA7 V	CR 36005
3.625	4.240	.380	HMSA7 V	CR 36147
3.661	4.252	.394	HMSA7 P	CR 36660
	4.331	.276	HMSA7 V	CR 36658
	4.488	.551	HMSA7 V	CR 36601

Series HMS4 and HMSA7 – Inch sizes

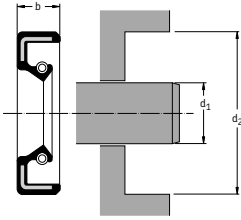

Dimensions		seal width b	Design and lip material	SKF Designation
shaft d ₁	bore d ₂			
in				
3.740	4.646	.394	HMSA7 S	CR 37030
3.750	4.500	.381	HMSA7 P	CR 37338
	4.501	.376	HMS4 V	CR 37341
	4.501	.380	HMS4 S	CR 37340
	4.501	.380	HMSA7 V	CR 37342
3.778	4.567	.354	HMSA7 V	CR 37570
3.780	4.606	.472	HMSA7 S	CR 37825
3.898	4.331	.276	HMSA7 V	CR 38883
4.134	4.724	.433	HMSA7 V	CR 41401
4.400	5.230	.375	HMSA7 P	CR 44000
4.811	5.543	.472	HMSA7 V	CR 48046
10.000	11.000	.375	HMS4 R	CR 100042
12.750	13.625	.563	HMSA7 R	CR 127540

Series CRS

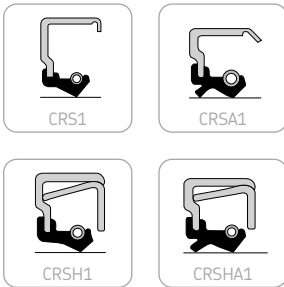

CRS1, CRSH1, CRSA1, CRSHA1: Radial shaft seals of high stiffness particularly for difficult or rough installation and operating conditions. Limited static sealing between outside diameter and housing bore.

CRS1: Seal with single steel shell, conventional sealing lip and carbon steel garter spring.

CRSA1: Seal with single steel shell, conventional sealing lip, carbon steel garter spring and a secondary, contacting (dust) lip.

CRSH1: Seal with double steel shell, conventional sealing lip and carbon steel garter spring.

CRSHA1: Seal with double steel shell, conventional sealing lip, carbon steel garter spring and secondary, contacting (dust) lip.

Radial shaft seals of CRS design are stocked in a wide range of sizes. They are available in lip material R (NBR) for general purpose and in lip material V (FPM) for higher operating temperature and for extended chemical resistance.

Further information about material, application and operating conditions for CRS seals is shown in the seal selection chart on **page 98**.

Series CRS – Metric sizes

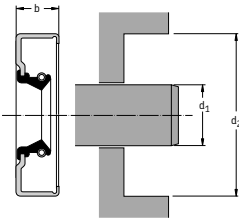

Dimensions			Design and lip material	SKF Designation
shaft	bore	seal width		
d_1	d_2	b		
mm				
12	20	5	CRSA1 R	CR 12×20×5 CRSA1 R
13	28	7	CRS1 R	CR 13×28×7 CRS1 R
19	37	10	CRS1 V	CR 19×37×10 CRS1 V
20	30	5	CRS1 R	CR 20×30×5 CRS1 R
	30	7	CRS1 V	CR 20×30×7 CRS1 V
	32	7	CRS1 V	CR 20×32×7 CRS1 V
	42	7	CRS1 V	CR 20×42×7 CRS1 V
22	32	7	CRS1 V	CR 22×32×7 CRS1 V
24	38	10	CRS1 R	CR 24×38×10 CRS1 R
25	32	7	CRSA1 R	CR 25×32×7 CRSA1 R
	47	10	CRSA1 V	CR 25×47×10 CRSA1 V
	52	7	CRS1 R	CR 25×52×7 CRS1 R
26	35	7	CRS1 R	CR 26×35×7 CRS1 R
	42	8	CRS1 R	CR 26×42×8 CRS1 R
27	37	7	CRS1 V	CR 27×37×7 CRS1 V
	41	10	CRSH1 R	CR 27×41×10 CRSH1 R
28	62	12	CRSH1 R	CR 28×62×12 CRSH1 R
30	45	8	CRS1 V	CR 30×45×8 CRS1 V
	52	9	CRSH1 R	CR 30×52×9 CRSH1 R
32	46	8	CRS1 R	CR 32×46×8 CRS1 R
34	52	10	CRS1 R	CR 34×52×10 CRS1 R
	54	11	CRS1 R	CR 34×54×11 CRS1 R
35	64	8	CRSA1 P	CR 35×64×8 CRSA1 P
	65	12	CRSA1 R	CR 35×65×12 CRSA1 R
36	46	9	CRS1 R	CR 36×46×9 CRS1 R
	56	10	CRS1 R	CR 36×56×10 CRS1 R

Series CRS – Metric sizes

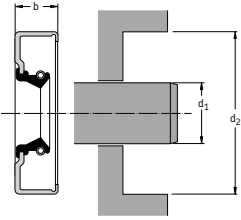

Dimensions			Design and lip material	SKF Designation
shaft	bore	seal width		
d ₁	d ₂	b		
mm				
37	55	10	CRSH1 R	CR 37×55×10 CRSH1 R
40	55	10	CRS1 R	CR 40×55×10 CRS1 R
	60	10	CRSA1 R	CR 40×60×10 CRSA1 R
42	62	10	CRS1 R	CR 42×62×10 CRS1 R
43	62	10	CRSH1 R	CR 43×62×10 CRSH1 R
45	58	9	CRSA1 R	CR 45×58×9 CRSA1 R
	62	7	CRSA1 R	CR 45×62×7 CRSA1 R
48	70	9	CRSA1 R	CR 48×70×9 CRSA1 R
50	62	7	CRS1 R	CR 50×62×7 CRS1 R
	62	10	CRS1 R	CR 50×62×10 CRS1 R
	85	13	CRSH1 R	CR 50×85×13 CRSH1 R
54	72	10	CRSA1 R	CR 54×72×10 CRSA1 R
	80	10	CRSH1 R	CR 54×80×10 CRSH1 R
57	72	10	CRSH1 R	CR 57×72×10 CRSH1 R
58	85	13	CRSH1 R	CR 58×85×13 CRSH1 R
59	75	10	CRSA1 R	CR 59×75×10 CRSA1 R
60	70	7	CRS1 R	CR 60×70×7 CRS1 R
	78	9	CRS1 R	CR 60×78×9 CRS1 R
	80	10	CRSHA1 R	CR 60×80×10 CRSHA1 R
	90	10	CRSH1 R	CR 60×90×10 CRSH1 R
62	75	10	CRS1 R	CR 62×75×10 CRS1 R
66	80	8,9	CRSHA1 R	CR 66×80×8,9 CRSHA1 R
	85	10	CRSHA1 R	CR 66×85×10 CRSHA1 R
	90	13	CRSH1 R	CR 66×90×13 CRSH1 R
68	85	10	CRS1 R	CR 68×85×10 CRS1 R

Series CRS – Metric sizes

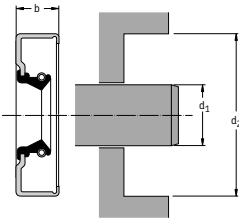

Dimensions			Design and lip material	SKF Designation
shaft	bore	seal width		
d_1	d_2	b		
mm				
74	100	13	CRSH1 R	CR 74×100×13 CRSH1 R
75	115	13	CRSH1 R	CR 75×115×13 CRSH1 R
80	100	13	CRSA1 R	CR 80×100×13 CRSA1 R
	125	13	CRSH1 R	CR 80×125×13 CRSH1 R
85	100	9	CRS1 R	CR 85×100×9 CRS1 R
88	110	13	CRSH1 R	CR 88×110×13 CRSH1 R
90	125	13	CRSH1 R	CR 90×125×13 CRSH1 R
95	110	9	CRS1 R	CR 95×110×9 CRS1 R
100	120	13	CRSH1 R	CR 100×120×13 CRSH1 R
105	125	12	CRS1 R	CR 105×125×12 CRS1 R
107	123	11	CRSA1 R	CR 107×123×11 CRSA1 R
108	130	13	CRSH1 R	CR 108×130×13 CRSH1 R
113	140	13	CRSH1 R	CR 113×140×13 CRSH1 R
115	160	15	CRSH1 R	CR 115×160×15 CRSH1 R
120	150	15	CRSH1 R	CR 120×150×15 CRSH1 R
125	146	14	CRSA1 P	CR 125×146×14 CRSA1 P
126	147	11	CRSA1 R	CR 126×147×11 CRSA1 R
130	150	10	CRSA1 R	CR 130×150×10 CRSA1 R
	150	14	CRSA1 R	CR 130×150×14 CRSA1 R
	155	10	CRSH1 R	CR 130×155×10 CRSH1 R
	160	13	CRS1 R	CR 130×160×13 CRS1 R
	160	13	CRSA1 R	CR 130×160×13 CRSA1 R
	165	13	CRSH1 R	CR 130×165×13 CRSH1 R

Series CRS – Metric sizes

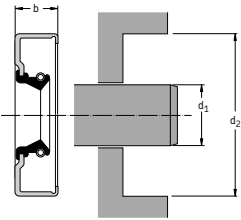

Dimensions		seal width b	Design and lip material	SKF Designation
shaft d_1	bore d_2			
mm				
135	160	13	CRSH1 R	CR 135×160×13 CRSH1 R
	170	15	CRSH1 R	CR 135×170×15 CRSH1 R
138	152	12	CRSA1 R	CR 138×152×12 CRSA1 R
145	164	14	CRSA1 R	CR 145×164×14 CRSA1 R
	175	14	CRS1 R	CR 145×175×14 CRS1 R
150	170	15	CRSH1 R	CR 150×170×15 CRSH1 R
	180	13	CRSH1 R	CR 150×180×13 CRSH1 R
	200	15	CRSH1 R	CR 150×200×15 CRSH1 R
154	175	13	CRSA1 R	CR 154×175×13 CRSA1 R
160	185	13	CRSA1 V	CR 160×185×13 CRSA1 V
168	200	15	CRSH1 R	CR 168×200×15 CRSH1 R
170	190	15	CRSH1 R	CR 170×190×15 CRSH1 R
180	200	12	CRS1 R	CR 180×200×12 CRS1 R
	215	16	CRS1 R	CR 180×215×16 CRS1 R
	220	16	CRSA1 R	CR 180×220×16 CRSA1 R
190	215	16	CRSH1 R	CR 190×215×16 CRSH1 R
195	230	15	CRSH1 R	CR 195×230×15 CRSH1 R
200	250	15	CRSH1 R	CR 200×250×15 CRSH1 R
260	300	20	CRS1 R	CR 260×300×20 CRS1 R

Series CRS – Inch sizes

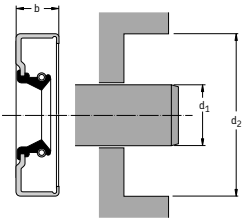

Dimensions		seal width b	Design and lip material	SKF Designation	
shaft d ₁	bore d ₂				
in					
.438	.875	.313	CRSH1 R	CR 4248	Bore-Tite
.500	1.006	.250	CRS1 R	CR 5001	
.531	1.124	.313	CRSA1 R	CR 5334	
.594	1.250	.313	CRSA1 R	CR 5950	Bore-Tite
	1.375	.313	CRSA1 R	CR 5966	
.669	1.339	.311	CRSA1 P	CR 6992	
.709	1.339	.315	CRSA1 P	CR 7089	
.781	1.752	.313	CRSHA1 R	CR 8213	
.844	1.828	.313	CRSA1 R	CR 8485	
.945	1.575	.315	CRS1 R	CR 9515	
.969	2.048	.375	CRS1 R	CR 9688	Bore-Tite
1.125	2.835	.375	CRSA1 R	CR 11405	Bore-Tite
	2.875	.469	CRSH1 R	CR 11410	Bore-Tite
1.156	2.125	.438	CRSH1 R	CR 11566	Bore-Tite
1.219	2.000	.438	CRSH1 R	CR 12131	Bore-Tite
1.250	2.561	.500	CRSH1 R	CR 12655	Bore-Tite
	2.713	.469	CRSH1 R	CR 12660	
	3.156	.500	CRSH1 R	CR 12678	
1.301	2.000	.438	CRSA1 P	CR 12905	
1.313	1.874	.375	CRSA1 R	CR 13027	Bore-Tite
	2.000	.313	CRSA1 R	CR 13037	Bore-Tite
	2.106	.375	CRSA1 R	CR 13084	Bore-Tite
	2.996	.500	CRSH1 R	CR 13275	Bore-Tite
1.328	2.312	.433	CRS1 R	CR 13419	Bore-Tite

Series CRS – Inch sizes

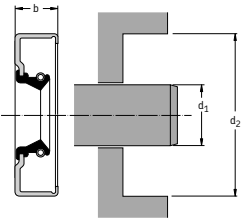

Dimensions			Design and lip material	SKF Designation	
shaft	bore	seal width			
d_1	d_2	b			
in					
1.362	2.191	.250	CRS1 P	CR 13500	
1.375	2.750	.500	CRSH1 R	CR 13906	Bore-Tite
	3.000	.500	CRSHA1 R	CR 13937	
	3.125	.500	CRSH1 R	CR 13936	
	3.350	.469	CRSH1 R	CR 13934	Bore-Tite
1.399	2.292	.469	CRSA1 R	CR 13992	Bore-Tite
	2.292	.500	CRSA1 R	CR 13990	Bore-Tite
1.414	2.250	.250	CRSHA1 R	CR 14035	Bore-Tite
1.469	2.374	.375	CRSA1 R	CR 14641	Bore-Tite
1.491	2.191	.250	CRSA1 R	CR 14780	
1.500	2.996	.500	CRSH1 R	CR 15240	
	3.000	.375	CRSA1 R	CR 15241	
1.524	2.374	.500	CRSH1 R	CR 15343	
1.563	2.716	.469	CRSH1 R	CR 15748	Bore-Tite
1.618	2.575	.500	CRSA1 R	CR 16044	Bore-Tite
1.625	2.437	.469	CRSHA1 R	CR 16121	
	2.835	.469	CRSH1 R	CR 16386	Bore-Tite
	3.062	.500	CRSH1 R	CR 16431	Bore-Tite
	3.251	.500	CRSH1 R	CR 16440	
1.656	2.502	.500	CRSH1 R	CR 16532	Bore-Tite
1.688	2.374	.313	CRSA1 R	CR 16669	
	2.835	.469	CRSA1 R	CR 16960	
1.705	3.084	.500	CRS1 R	CR 17053	
1.719	2.623	.500	CRSH1 R	CR 17136	Bore-Tite
1.750	2.328	.438	CRS1 R	CR 17257	
	3.154	.313	CRS1 R	CR 17726	

Series CRS – Inch sizes

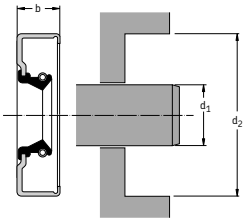

Dimensions			Design and lip material	SKF Designation	
shaft	bore	seal width			
d_1	d_2	b			
in					
	3.937	.313	CRSA1 R	CR 17771	Bore-Tite
1.781	2.750	.500	CRSH1 R	CR 17847	
	2.758	.500	CRSH1 R	CR 17851	Bore-Tite
1.844	2.502	.375	CRSA1 R	CR 18412	Bore-Tite
	2.750	.375	CRSA1 R	CR 18446	Bore-Tite
1.875	3.125	.313	CRSA1 R	CR 18879	Bore-Tite
1.889	3.110	.688	CRSA1 P	CR 18983	
1.890	2.874	.276	CRSA1 P	CR 18979	
1.906	3.189	.313	CRSA1 P	CR 19062	
1.938	2.762	.500	CRSA1 R	CR 19273	Bore-Tite
	2.825	.500	CRSH1 P	CR 19274	
	3.751	.500	CRSH1 R	CR 19466	Bore-Tite
1.969	2.638	.354	CRSA1 R	CR 19628	
	2.686	.500	CRSH1 R	CR 19615	
	2.742	.500	CRSH1 P	CR 19620	
	2.875	.469	CRSH1 R	CR 19643	
2.008	2.953	.354	CRSA1 P	CR 20012	
2.063	2.875	.375	CRSA1 R	CR 550085	Bore-Tite
2.125	3.623	.469	CRSA1 P	CR 21379	
2.145	3.188	.469	CRSH1 R	CR 21538	
2.188	3.623	.500	CRSHA1 R	CR 21950	
2.432	3.070	.227	CRSA1 P	CR 24110	
2.563	3.500	.500	CRSHA1 P	CR 25587	
2.648	3.812	.500	CRS1 R	CR 26877	

Series CRS – Inch sizes

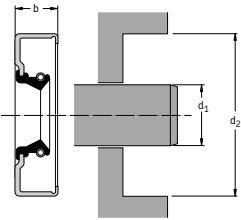

Dimensions			Design and lip material	SKF Designation	
shaft	bore	seal width			
d_1	d_2	b			
in					
2.750	4.125	.438	CRS1 P	CR 27576	Bore-Tite
	4.125	.563	CRSA1 R	CR 27577	
2.875	3.434	.294	CRSA1 R	CR 28646	Bore-Tite
	3.434	.294	CRSA1 R	CR 546158	Bore-Tite
2.913	3.543	.394	CRS1 P	CR 29105	
3.125	3.936	.512	CRSA1 V	CR 31144	Bore-Tite
3.250	3.876	.375	CRSA1 V	CR 32332	Bore-Tite
	4.125	.563	CRSH1 R	CR 32362	Bore-Tite
3.298	4.125	.563	CRSA1 R	CR 32815	Bore-Tite
3.469	4.626	.625	CRSA1 R	CR 34700	
3.500	5.751	.563	CRSH1 R	CR 35111	Bore-Tite
3.504	4.173	.354	CRSA1 V	CR 35120	
3.813	4.999	.469	CRSH1 R	CR 38160	Bore-Tite
	5.251	.469	CRSH1 R	CR 38220	
3.875	5.501	.500	CRSHA1 R	CR 38749	Bore-Tite
	5.751	.563	CRSH1 R	CR 38810	
3.898	4.680	.370	CRSA1 VR	CR 38880	
4.188	4.999	.469	CRSHA1 R	CR 41751	
	5.251	.469	CRSH1 R	CR 41761	
	5.751	.500	CRSHA1 R	CR 41833	
4.313	5.751	.500	CRSH1 R	CR 43131	
4.563	5.751	.500	CRSHA1 R	CR 45550	
	6.250	.500	CRSH1 R	CR 45560	
5.000	7.000	.500	CRSHA1 R	CR 50185	
	7.500	.500	CRSHA1 R	CR 50195	

Series CRS – Inch sizes

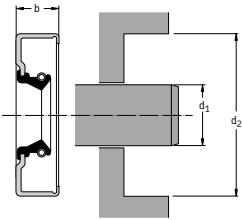

Dimensions					
shaft	bore	seal width	Design and	SKF Designation	
d_1	d_2	b	lip material		
in					
5.125	6.500	.500	CRSHA1 R	CR 51276	
5.250	6.375	.500	CRSHA1 R	CR 52487	
5.313	6.500	.500	CRSHA1 R	CR 53151	
5.375	6.374	.500	CRSHA1 R	CR 53688	Bore-Tite
	6.499	.563	CRSH1 R	CR 53692	
5.500	6.626	.563	CRSHA1 R	CR 54949	
	6.876	.563	CRSHA1 R	CR 55157	
	7.501	.563	CRSH1 R	CR 55179	
5.750	6.876	.563	CRSHA1 R	CR 57519	
	7.126	.563	CRSHA1 R	CR 57578	
	7.502	.563	CRSHA1 R	CR 57584	
6.000	7.002	.500	CRSHA1 R	CR 60006	Bore-Tite
	7.126	.563	CRSHA1 R	CR 60004	
6.062	6.772	.551	CRSA1 R	CR 60620	
6.125	7.502	.563	CRSHA1 R	CR 61248	Bore-Tite
6.188	7.500	.563	CRSH1 P	CR 61840	
7.000	8.375	.625	CRSHA1 R	CR 70034	
7.750	9.000	.650	CRSH1 R	CR 77530	

Radial shaft seals of PTFE

Radial shaft seals of PTFE with metal case, series RD

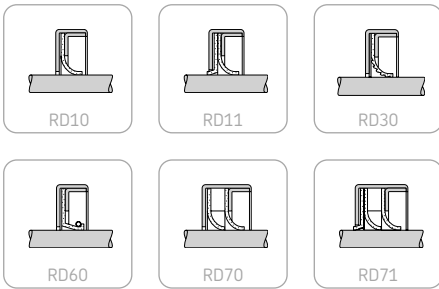

Radial shaft seals with one or more sealing lip(s) of PTFE are designed to withstand e.g. aggressive environments, high temperatures, high pressures and non-lubricated services that traditional radial seals do not withstand.

Radial shaft seals series RD are designed with a PTFE lip fastened in a metal case. Housing dimensions according to DIN 3760 or special designs.

Radial shaft seals series RD can be assembled in existing housing grooves where traditional radial seals are used, provided that they are produced in accordance with DIN 3760.

Series RD can be delivered with a metal case of steel, aluminium and the stainless steel materials M1 SS 304, SS 316 and SS 316 TI.

The PTFE material is to be chosen among several materials in order to adjust to each application's specific demands.

Advantages:

- High chemical resistance
- Withstands speeds up to 30 m/s
- Wide operating temperature range
-70°C – +250°C
- Withstands pressures up to 3,5 MPa
- Withstands non-lubricated service
- FDA approved materials available

Radial shaft seals of PTFE without metal case, series RDD

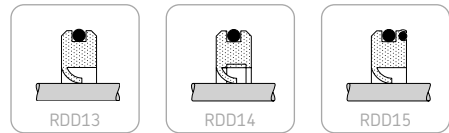

Radial shaft seals can also be produced purely of PTFE without a metal case. These are used e.g. in the food industry to enable dismantling of the equipment for cleaning. Radial lip seals of PTFE are also suitable for applications in aggressive environments or with temperatures below -20°C.

Type RDD without metal case has the same housing dimensions and the same technical specifications as type RD with a metal case.

Materials

The choice of seal materials always includes a compromise between advantages and disadvantages. Radial shaft seals can be delivered in several different PTFE materials. The materials which we most often suggest are stated below.

There are many hundreds of different PTFE materials with variants of fillers, e.g. glass fibre, carbon, graphite, molybdenum disulphide, metal oxides, polymeric fillers and combinations of different fillers. Each possesses different properties appropriate for different applications and working conditions.

Unfilled PTFE provides most often a lower friction than a filled PTFE material and the lowest degree of wear of the cylinder tube surface. However, its own resistance to wear and deformation under load is limited.

Common for all filled PTFE materials is their different degree of better resistance to wear and deformation.

Material codes, sealing lip

Code	MS	Material type
Al	141	PTFE + glass fibre (FDA approved)
AC	271	PTFE +Polyoxybenzoate (polymer)
AJ	443	PFA (FDA approved)
AC	831	PTFE + organic pigment (FDA approved)
AL	910	PTFE + carbon fibre + MoS ₂

Material codes, metal case

Code	Material type
A	M1 Carbon steel
B	SS 304 Standard material
C	SS 316 Acidproof steel
D	SS 316 TI Stainless steel with titanium

All series can be delivered with a special design regarding groove dimensions and material properties in order to obtain optimal solution.

Series RD and RDD – Metric sizes

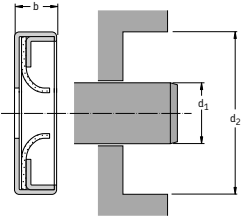

Design code and material code should be stated when ordering SKF Radial shaft seals of PTFE. For choice of adequate design and material, please see page 194 and 195 or contact your SKF representative.

Dimensions			Dimensions		
shaft	bore	seal width	shaft	bore	seal width
d ₁	d ₂	b	d ₁	d ₂	b
mm			mm		
6	16	7	30	42	7
	22	7		47	7
7	22	7		52	7
	8	22	7	32	45
24		7	47		8
24		7	52		8
9	22	7	35	50	8
	10	22		7	52
25		7		55	8
12		24	7	38	55
	25	7	58		8
	30	7	62		8
15	26	7	40	55	8
	30	7		62	8
	35	7	42	55	8
16	30	7		62	8
	18	30	7	45	62
35		7	65		8
20	35	7	50	68	8
	40	7		72	8
22	35	7	55	72	8
	40	7		80	8
	47	7		60	80
25	40	7	85		8
	47	7	65		85
	52	7		90	10
28	40	7	70	90	10
	47	7		95	10
	52	7			

Series RD and RDD – Metric sizes

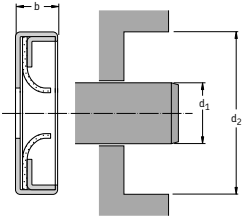

Dimensions			Dimensions		
shaft d_1	bore d_2	seal width b	shaft d_1	bore d_2	seal width b
mm			mm		
75	95	10	280	320	20
	100	10		300	340
80	100	10	320		360
	110	10		340	380
85	110	12	360		400
	120	12		380	420
90	120	12	400		440
95	120	12			
100	125	12			
110	140	12			
120	150	12			
130	160	12			
140	170	15			
150	180	15			
160	190	15			
170	200	15			
180	210	15			
190	220	15			
200	230	15			
220	250	15			
240	270	15			
260	300	15			

Large diameter radial shaft seals (LDS), standard designs

General

Heavy basic industries such as primary metals, construction, wind energy, forestry, mining and pulp and paper, provide a challenging environment for radial shaft seals. Operating in a wide range of speeds, temperatures and environmental conditions, shaft seals are asked to reliably retain lubrication while avoiding harsh contamination from penetrating and potentially damaging capital equipment. Generally, seals for shaft diameters larger than 200 mm or 8 in are known as large diameter seals (LDS).

Special design features for large diameter seals

Spacer lugs

Spacer lugs may be furnished on all metal clad designs to separate seals in multiple installations and provide space for lubrication. (fig 68).

The traditional fixed-width lugs are 9,5 mm (0.375 in) in diameter and are available in widths from 4,9 mm (0.125 in) to 12,7 mm (0.5 in) in increments of 1,6 mm (0.0625 in). The fixed-width lug is an available option on all metal clad seals except HDS3. All HDS3 style seals come standard with adjustable lugs. This new concept allows the user to adjust lug widths on the spot to suit individual requirements.

All adjustable lugs are 9,5 mm (0.375 in) in diameter and 12,7 mm (0.5 in) in width. They may be adjusted to smaller widths in 1,6 mm (0.0625 in) increments simply by removing the steel washers. Also, the lugs may be removed entirely.

Certain small cross sections may require special narrow diameter 5,33 mm (0.210 in) lugs with a width range of 1,6 to 3,2 mm (0.0625 to 0.125 in)

The lugs are placed around the heel of the seal in four, six or eight equally-spaced locations, depending on the seal outer diameter (Table 18).

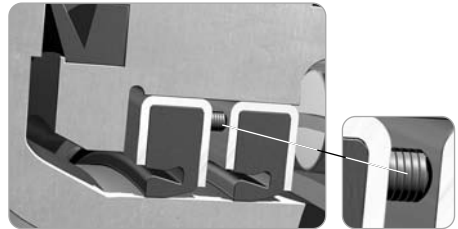

Fig 68. Spacer lug

Table 18. Number of spacer lugs needed

Spacer lugs pcs.	Seal outside diameter			
	from		incl.	
	mm		in	
4		762		30
6	762	1143	30	45
8	1143		45	

Spring-Lock

Spring-Lock is a sealing lip feature that surrounds 270° of the garter spring's diameter (**fig 69**). The Spring-Lock helps hold the spring in position during seal handling, installation and removal. It is standard on all HDS and HS seals.

Spring-Kover

In applications where dirt, water or other contaminants may pose serious problems or where installation could jar the spring out of place, Spring-Kover can be specified. Spring-Kover is a flexible covering over the exposed portion of the stainless steel garter spring (**fig 70**). It protects the spring without adversely affecting the spring's capability. Spring-Kover is available on all seals except HS3.

Bore-Tite®

Bore-Tite is a water based acrylate sealant that is an option available on most SKF metal clad seals. The sealant is used as a coating on the outside diameter of the seal (**fig 71**). The Bore-Tite layer is pliable with a thickness of 0,03 to 0,07 mm (0.0012 to 0.0028 in), allowing the sealant to help fill small imperfections in the housing bore. Bore-Tite can be used at temperatures up to 200 °C and is compatible with most oils, greases, aqueous acids and alkalis, alcohols and glycols. Please note that Bore-Tite is not compatible with aromatics, ketones and esters. Incidental contact with these substances will have little to no effect if wiped off quickly.

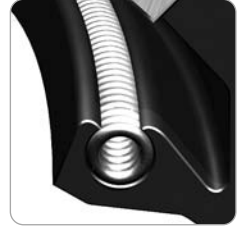

Fig 69. Spring-Lock

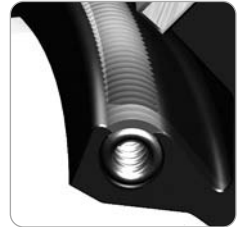

Fig 70. Spring-Kover

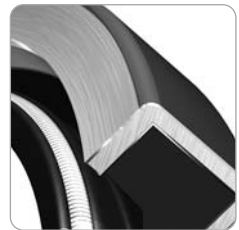

Fig 71. Bore-Tite



HDS7



Metal clad seal series

General

The most popular seal group in the SKF LDS line is the metal clad seal series with the HD seal designs.

The HD designs include the highly engineered HDS7, the ultra-high performance HDL and the reliable HDS1, HDS2 and HDS3 seal. SKF HD seals are specifically designed to withstand the extreme conditions encountered in heavy-duty applications.

The seals perform exceptionally well in the highly contaminated environment of metal rolling mills, the high speed and high temperature environment of paper mills, as well as more universal applications such as industrial gearboxes. The metal clad seal series has a product to perform in almost any industrial application.

Type HDS7

Water and solid contamination particles are common causes for bearing failures. SKF has developed the HDS7 as a grease seal with enhanced exclusion capabilities.

The highly engineered HDS7 features a computer optimized, springless lip profile designed to retain lubricants and aggressively pump contamination away from the lip. The increased ability of the HDS7 to exclude contamination makes it an ideal equipment protector in heavily contaminated environments such as the water and scale present in rolling mill applications. The springless lip concept of the HDS7 also reduces radial load.

The HDS7 is available in a nitrile lip material for common applications, Duratemp® for higher temperature conditions and Duralip® for applications where extra abrasion resistance is necessary.

It is important to note that the HDS7 is not available in FPM (LongLife®) material.

The HDS7 is available in all shaft sizes ranging from 200 to 1 575 mm (8 to 62 in). Spacer lugs are available for any configuration, see **page 198** for further information.

HDL seals

The HDL is a premium metal clad oil seal that is especially designed to operate in severe conditions including high speeds and temperatures, high runout and high misalignment. The excellent high-speed performance characteristics of the HDL make it the preferred design in the severe environment encountered in the rolls of the papermaking machines.

The HDL features a stainless steel garter spring that is entrapped by individual finger springs, also made of stainless steel, around the entire circumference of the seal.

The spring combination allows the seal to compensate for severe conditions in order to maintain high levels of sealing performance, operational life and equipment reliability.

The HDL series also comprises type HDLA with a secondary (dust) lip for extra protection against contaminations.

The HDL is available in lip material nitrile rubber, Duratemp and LongLife (**pages 28 and 29**), ensuring that the HDL will perform regardless of speed or temperature. Spacer lugs are available for all products within the HDL line. Available HDL sizes can be found in the size listing (**page 214 to 243**).

HDS1, HDS2 and HDS3

The most commonly used metal clad seal is the HDS series for general purpose applications. HDS seals are divided into the HDS1, HDS2 and HDS3 categories.

All three seal versions are encased in a heavy-duty steel shell and a SAE 302 series stainless steel spring is standard.

The basic HDS1 has its stainless steel spring mounted in a protective Spring-Lock groove. Where blind installations may increase the risk of spring displacement, the type HDS2 adds a Spring-Kover that bonds the spring into the groove. The HDS3 adds a spark-free inner diameter, standard Duralip material and



HDL



HDS1



HDS2



HDS3



HDSA



HDSB



HDSC



adjustable spacer lugs. The adjustable lugs are optional on all other HDS models, as are fixed width lugs (**page 198**).

The HDS seal product line is available in a wide variety of rubber materials in all sizes ranging from 200 to 1 575 mm (8 to 62 in) (**Table 20, page 211** and **Table 21, page 212**). Nitrile is standard on all HDS seals (with the exception of the HDS3 where Duralip is standard), however all seal types can also be ordered in Duralip, Duratemp or LongLife elastomers (**page 28 to 29**).

HD metal clad seal options

For enhanced exclusion performance, the HD metal clad seals are available in different styles to best meet the needs of your application. Each style is primarily based on HDS1, HDS2, HDS3 or HDS7 and is available with auxiliary elements for special applications.

HDSA, HDSB and HDSC

These seals are designed with a single rubber sealing element and an auxiliary exclusion element. For shaft sizes up to 550 mm (21.750 in), the excluder lip is made of Duralip material. Leather is used for larger shafts. These styles are generally used where there is insufficient space for more than one seal.

The HDSA, HDSB and HDSC seal product lines are available in sizes ranging from 203 to 1 016 mm (8 to 40 in) (**Table 20** on **page 211**).

HDSD

The HDSD seal types are designed with dual sealing elements with lips facing in opposite directions. This style is used for applications requiring the separation of two fluids. When using an HDSD seal, it is very important to provide a means to lubricate the sealing elements (i.e. the cavity between the sealing elements may be packed with grease or holes may be drilled from the outer diameter into the cavity between the lips).



HDSD

HDSE

This style features dual elements with lips facing in the same direction. This seal type is used where a back-up seal is desired for retention or exclusion purposes. As with the HDSD type, a means of lubricating the seals is necessary for a proper sealing function.



HDSE

Available sizes

The HDSD and HDSE seal product lines are available in sizes ranging from 203 to 1346 mm (8 to 53 in) (**Table 20 on page 211**).

Rubber covered seals

General

The SKF rubber covered seals include metal inserted (SBF), fabric-reinforced (HSF) and all-rubber (HS) products. The fabric-reinforced and all-rubber versions are available as solid round or with an open joint or split.

The rubber covered and all-rubber seals offer designers and operators of rotating equipment a number of important operating and installation benefits. They do not score the bore even after repeated installations and extractions. This prevents damage to the metal that can cause bypass leakage. Rubber covered and all-rubber seals accept rougher bore finishes, reducing machining costs. They are especially helpful for split housings. They resist corrosion and will not seize in the bore even years after assembly.

Due to lower press-in forces, rubber covered seals are often easier to install particularly in the field or confined spaces. They can be fitted by hand or with simple hand tools even when the diameters are very large. Further, in the case of split seals there is no need to dismount the shaft or other machine components.

Metal inserted seals series SBF

The SBF seal design is a new rubber outside diameter seal with a flexible metal stiffening ring that allows mounting without the use of a cover plate. The SBF seal can be used as an upgrade to rubber fabric seals in many applications that are either grease or oil lubricated. The SBF seals are available in both NBR and LongLife (FPM) ([page 28](#)) with optional Spring-Kover ([page 199](#)).

Available SBF sizes can be found in the size listing ([page 244 to 245](#)).



SBF

Metal inserted seals series HDS4 and HDS6

The HDS4 features a patented molded-in garter spring, which cannot be displaced during difficult installations and provides superior oil sealability while minimizing wear. The HDS6 is a springless version designed for grease retention and contamination exclusion. Nitrile rubber is standard and can be ordered in the full range of HDS rubber compounds.

Both HDS4 and HDS6 are equipped with moulded 12,7 mm (0.5 in) spacer lugs, which can be trimmed or removed if necessary. The HDS4 and HDS6 are stocked in a limited range of sizes; see [Table 21](#) on [page 212](#) or contact us for information on availability and new size additions.



HDS4



HDS6



HSF5 (solid), HSF1 (split)



HSF6 (solid), HSF2 (split)



HSF7 (solid), HSF3 (split)

Fabric-reinforced seals series HSF

The HSF seal types consist of the HSF5, HSF6, HSF7 and HSF8 solid seal styles and their split versions HSF1, HSF2, HSF3 and HSF4. There is also a pressure profile HSF9 in solid version only. These seal styles are mainly used in heavy-duty applications such as gear drives, propeller shafts, cold and hot mill work rolls, pumps, paper machinery, etc.

The HSF5, HSF6 and HSF7 are fabric-reinforced seals that have a strong, flexible, textile rubber back instead of a metal case. The HSF5 is the standard single lip rubber fabric seal. The HSF6 adds radial lubrication grooves in the back of the seal and the HSF7 adds a circumferential lubrication groove. The HSF8 offers a dust-lip version of the standard seal.

To attain optimum sealing performance, a retaining or cover plate is necessary to properly install and apply all HSF seal types. The plate creates an axial preload that ensures reliable static sealing performance of the seal. The plate should also be designed to avoid seal distortion upon assembly. The HSF seal types are available in NBR and FPM material.

Available HSF sizes can be found in the product tables (page 246 to 277).

All-rubber seals series HS

Type HS seals, available in solid round and split designs, are all-rubber, large diameter seals designed without an outer shell or metal case. HS solid and split large diameter seals are cataloged by shaft size and priced by the dimensions of the bore for which they are designed. The actual seal outside diameter is approximately 0,5 % to 2 % larger than the seal housing bore. Actual seal width is approximately 0,4 to 0,8 mm (0.016 to 0.031 in) wider than the bore depth. A cover plate is required to compress the seal within the cavity, helping seal the split joint and prevent leakage.

A garter-type spring embedded in the sealing element reinforces lip pressure against the shaft.

The HS solid and split seal product line is available in sizes ranging from 203 to 4 572 mm (8 to 180 in) (**Table 22** on **page 213**).

HS solid seal types

HS solid seals can be made as standard types from 203 mm (8 in) up to unlimited shaft size. There are two types:

HS4

HS4 seal is an all-rubber solid seal with a single spring-loaded element. It features a Spring-Lock (page 20) and is recommended for vertical and horizontal shafts. For proper fit, a cover plate is required.

HS5

HS5 is the same as HS4 with the addition of a Spring-Kover (page 20) for added protection against spring pop-out and contamination.



HS4



HS5



HS6



HS7

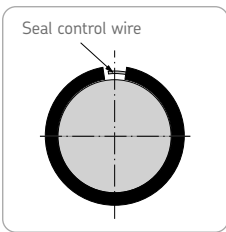

Fig 72. Seal control wire feature, used on HS7

HS split seal types

Where downtime is critical and shaft removal is impractical, type HS all-rubber split seals are ideal. They are simply placed around the shaft and pushed into the seal bore, then held firmly by a cover plate, which compresses the split joint together. HS split seals perform best with grease or heavy lubricants as well as with light lubricants, placed no higher than the shaft centreline. Horizontal shafts are preferred with the split placed in the 12 o'clock position. HS split seals are available in a wide variety of types, styles and materials.

HS6

HS6 is an all-rubber split seal with a single spring-loaded element and a Spring-Lock (**page 199**). HS6 features a separate loose spring and a positive spring connection. Generally, the spring connection is of the hook-and-eye type for shafts over 457 mm (18 in) and a threaded-type connection for smaller sizes. For proper fit, a cover plate is required.

HS7

HS7 is an all-rubber split seal with a single spring-loaded element, which has both a Spring-Lock and a Spring-Kover (**page 199**). A control-wire spring connector is used to join the seal together (**fig 72**). HS7 does not have the high performance as other HS types, but it is the easiest one to install. The spring is completely enclosed and the connection is simply made by running the control wire into the center of the spring coil across the split (butt joint). Spring tension to hold the sealing lip on the shaft is built-in at the factory. For proper fit, a cover plate is required. Due to the unique design that permits easier installation, please note that a gap may occur at the joint even after the cover plate is installed. Special attention to place the gap at the 12 o'clock position during installation is necessary.

HS8

HS8 is an all-rubber split seal with a single spring-loaded element, Spring-Lock, Spring-Kover (**page 199**) and a positive spring connection. The spring is entirely enclosed except for a small portion on either side of the split. HS8 provides the most positive seal of all the split types and is the preferred design for use with lighter lubricant retention and water exclusion. HS8 performs best on horizontal shafts, but may also be used on vertical shafts. For proper fit, a cover plate is required.



HS8

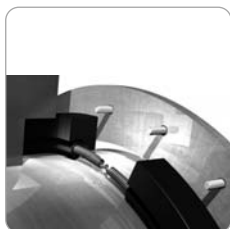

Fig 73. Hook-and-eye spring connection

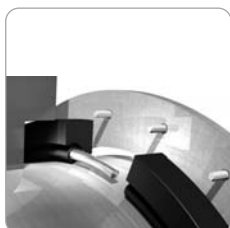

Fig 74. Threaded spring connection

Spring connections for split seal types

The SAE 302 stainless steel garter springs are supplied loosely (separately) in the HS6 style. The springs are factory-installed and encased with Spring-Kover (page 199) in the HS7 and HS8 styles. In styles HS6 and HS8, the spring connection is generally of the hook-and-eye type for shafts over 457 mm (18 in) in diameter (fig 73) and of the threaded type for smaller sizes (fig 74). It is recommended for sealing light oils as well as heavy greases.

The special control-wire type is available only in the HS7 design for all shaft sizes and recommended for grease only. Where positive spring connections are made, the connection should be offset to the left or right of the split for maximum efficiency. See also Table 19.

Table 19. Spring arrangements for HS seals

Features	Solid Types		Split Types		
	HS4	HS5	HS6	HS7	HS8
Spring groove type	Spring-Lock	Spring-Lock	Spring-Lock	Spring-Lock	Spring-Lock
Spring connection	Factory made	Factory made	Threaded/ Hook-and-Eye	Control wire	Threaded/
Spring-Kover	None covered	100%	None covered	100% except ends	Covered

Size and type listing

Size options of HDS metal clad seals

To accommodate almost every application, HDS seal designs are available on a “made-to-order basis”.

Please see **Table 20** for the available sizes and cross sections of the different types and contact us for further information about delivery time.

Size listing of HDS4 and HDS6

The rubber covered HDS4 and HDS6 seals are currently stocked in the range of sizes listed in **Table 21, page 212**. Please contact us for availability and new size additions.

Table 20. Preferred standard metal clad seals sections

Seal type	Bore diameter ¹		Shaft size ²		Difference between bore and shaft		Width	
	from	to	from	to	from	to	from	to
–	mm (in)		mm (in)		mm (in)		mm (in)	
HDS7	234,95 9.250	1 638,30 64.500	203,20 8.000	1 574,80 62.00	31,75 1.250	63,50 2.500	15,88 0.625	31,75 1.250
HDS1, HDS2, HDS3	234,34 9.226	1 651 65.000	203,20 8.000	1 574,80 62.000	31,14 1.226	76,20 3.000	15,88 0.625	38,01 1.500
HDSA, HDSB, HDSC	234,34 9.226	1 092 43.000	203,20 8.000	1 016 40.000	31,14 1.226	76,20 3.000	22,23 0.875	38,10 1.500
HDS4, HDSE	234,43 9.226	1 346 53.000	234,34 8.000	1 346 53.000	31,14 1.226	76,20 3.000	31,75 1.250	50,80 2.000

¹) Bore tolerance H8

²) Shaft tolerance h11

Table 21. Available sizes of HDS4 and HDS6

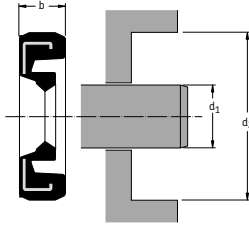

Dimensions

shaft d_1	bore d_2	seal width b	shaft d_1	bore d_2	seal width b
mm			in		
406,4	457,2	20,65	16.000	18.000	0.813
419,1	469,9	20,65	16.500	18.500	0.813
457,2	508	22,2	18.000	20.000	0.875
533,4	584,2	19,05	21.000	23.000	0.750
558,8	609,6	22,23	22.000	24.000	0.875
698,5	749,3	22,23	27.500	29.500	0.875

Size options of HS seals

HS seal sizes are not listed in this brochure but are available in standard cross sections and widths according to **Table 22**. For other cross sections please contact us for availability.

Table 22. Size options of HS seals

Difference between bore and shaft	Bore diameter ¹ from to	Shaft diameter ² from to	Bore depth ³
mm (in)	mm (in)	mm (in)	mm (in)
25,40 1.000	228,60 1854 9.000 73.000	203,20 1829 8.000 72.000	12,70; 15,88 0.500; 0.625
31,75 1.250	234,95 1301 9.250 51.250	203,20 1829 8.000 50.000	15,88 0.625
38,10 1.500	279,40 4610 11.000 181.500	241,30 4572 9.500 180.000	15,88; 17,48; 19,05 0.625; 0.688; 0.750
50,80 2.000	330,00 4622 13.000 182.000	279,40 4572 11.000 180.000	20,70 0.815
	¹) Bore tolerance H8	²) Shaft tolerance h11	³) Tolerance $\pm 0,1$

Series HDL – Metric sizes

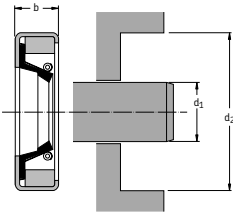

Dimensions			SKF Designation	
shaft	bore	seal width	Lip material	V
d_1	d_2	b	R	
mm				
200	240	20	CR 200×240×20 HDL R	CR 200×240×20 HDL V
220	250	18	CR 220×250×18 HDL R	CR 220×250×18 HDL V
232	269,87	17,45	CR 232×269.87×17.45 HDL R	CR 232×269.87×17.45 HDL V
240	270	15	CR 240×270×15 HDL R	CR 240×270×15 HDL V
	280	20	CR 240×280×20 HDL R	CR 240×280×20 HDL V
270	308	17,45	CR 270×308×17.45 HDL R	CR 270×308×17.45 HDL V
280	320	19,98	CR 280×320×19.98 HDL R	CR 280×320×19.98 HDL V
	340	20,62	CR 280×340×20.62 HDL R	CR 280×340×20.62 HDL V
330	370	18	CR 330×370×18 HDL R	CR 330×370×18 HDL V
360	404	17,45	CR 360×404×17.45 HDL R	CR 360×404×17.45 HDL V
390	430	16	CR 390×430×16 HDL R	CR 390×430×16 HDL V
400	450	17,45	CR 400×450×17.45 HDL R	CR 400×450×17.45 HDL V
	440	20	CR 400×440×20 HDL R	CR 400×440×20 HDL V
420	460	17,45	CR 420×460×17.45 HDL R	CR 420×460×17.45 HDL V
	470	17,45	CR 420×470×17.45 HDL R	CR 420×470×17.45 HDL V
	460	20	CR 420×460×20 HDL R	CR 420×460×20 HDL V
440	480	20	CR 440×480×20 HDL R	CR 440×480×20 HDL V
470	520	22	CR 470×520×22 HDL R	CR 470×520×22 HDL V
480	520	20	CR 480×520×20 HDL R	CR 480×520×20 HDL V
485	535	19	CR 485×535×19 HDL R	CR 485×535×19 HDL V
500	550	19	CR 500×550×19 HDL R	CR 500×550×19 HDL V
508	560	25	CR 508×560×25 HDL R	CR 508×560×25 HDL V
513	543	16	CR 513×543×16 HDL R	CR 513×543×16 HDL V
520	560	18	CR 520×560×18 HDL R	CR 520×560×18 HDL V
	570	22	CR 520×570×22 HDL R	CR 520×570×22 HDL V
530	580	20,62	CR 530×580×20.62 HDL R	CR 530×580×20.62 HDL V
540	590	24,98	CR 540×590×24.98 HDL R	CR 540×590×24.98 HDL V
560	610	20	CR 560×610×20 HDL R	CR 560×610×20 HDL V
565	601	20	CR 565×601×20 HDL R	CR 565×601×20 HDL V
600	640	20	CR 600×640×20 HDL R	CR 600×640×20 HDL V
630	670	20	CR 630×670×20 HDL R	CR 630×670×20 HDL V

Series HDL – Metric sizes

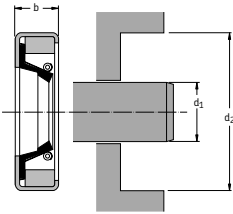

Dimensions			SKF Designation	
shaft	bore	seal width	Lip material	
d_1	d_2	b	R	V
mm				
640	680	20	CR 640×680×20 HDL R	CR 640×680×20 HDL V
650	714	25	CR 650×714×25 HDL R	CR 650×714×25 HDL V
668	706	25,4	CR 668×706×25.4 HDL R	CR 668×706×25.4 HDL V
750	814	25	CR 750×814×25 HDL R	CR 750×814×25 HDL V
760	804	18	CR 760×804×18 HDL R	CR 760×804×18 HDL V
780	844	25	CR 780×844×25 HDL R	CR 780×844×25 HDL V
790	854	25	CR 790×854×25 HDL R	CR 790×854×25 HDL V
837	889	22,22	CR 837×889×22.22 HDL R	CR 837×889×22.22 HDL V
838,1	881	20	CR 838.1×881×20 HDL R	CR 838.1×881×20 HDL V
840	904	25	CR 840×904×25 HDL R	CR 840×904×25 HDL V
920	958,01	19,05	CR 920×958.01×19.05 HDL R	CR 920×958.01×19.05 HDL V
930	980	22,22	CR 930×980×22.22 HDL R	CR 930×980×22.22 HDL V
990	1040	25	CR 990×1040×25 HDL R	CR 990×1040×25 HDL V
1000	1050	22,22	CR 1000×1050×22.22 HDL R	CR 1000×1050×22.22 HDL V
1055	1100	25	CR 1055×1100×25 HDL R	CR 1055×1100×25 HDL V
1105	1160	22	CR 1105×1160×22 HDL R	CR 1105×1160×22 HDL V
1350	1414	22	CR 1350×1414×22 HDL R	CR 1350×1414×22 HDL V
1350	1415	25	CR 1350×1415×25 HDL R	CR 1350×1415×25 HDL V
1380	1440	25	CR 1380×1440×25 HDL R	CR 1380×1440×25 HDL V

Series HDL - Inch sizes

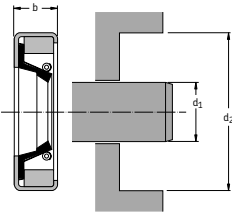

Dimensions shaft d ₁	bore d ₂	seal width b	SKF Designation Lip material R	V
in (mm)				
6.125 155,57	7.625 193,67	0.687 17,45	CR HDL 1299 R	CR HDL 1299 V
7.125 180,97	8.250 209,55	0.750 19,05	CR HDL 3011 R	CR HDL 3011 V
7.875 200,02	9.375 238,12	0.687 17,45	CR HDL 9176 R	CR HDL 9176 V
8.000 203,20	9.500 241,30	0.687 17,45	CR HDL 3921 R	CR HDL 3921 V
8.125 206,37	10.125 257,17	0.687 17,45	CR HDL 9712 R	CR HDL 9712 V
8.250 209,55	10.250 260,35	0.812 20,62	CR HDL 4499 R	CR HDL 4499 V
8.375 212,72	9.875 250,82	0.687 17,45	CR HDL 3933 R	CR HDL 3933 V
	10.375 263,52	0.812 20,62	CR HDL 4500 R	CR HDL 4500 V
8.500 215,90	9.750 247,65	0.562 14,28	CR HDL 1705 R	CR HDL 1705 V
	9.750 247,65	0.652 16,56	CR HDL 6384 R	CR HDL 6384 V
	10.000 254,00	0.687 17,45	CR HDL 8453 R	CR HDL 8453 V
	10.500 266,70	0.812 20,62	CR HDL 3938 R	CR HDL 3938 V
8.625 219,07	10.125 257,17	0.687 17,45	CR HDL 3939 R	CR HDL 3939 V
	10.260 260,60	0.687 17,45	CR HDL 2736 R	CR HDL 2736 V
	10.750 273,05	0.812 20,62	CR HDL 7718 R	CR HDL 7718 V
8.750 222,25	10.250 260,35	0.687 17,45	CR HDL 3946 R	CR HDL 3946 V
	10.500 266,70	0.687 17,45	CR HDL 9911 R	CR HDL 9911 V
	10.750 273,05	0.812 20,62	CR HDL 3952 R	CR HDL 3952 V

Series HDL - Inch sizes

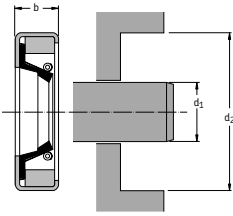

Dimensions shaft d_1	bore d_2	seal width b	SKF Designation Lip material R	V
in (mm)				
8.875	10.875	0.812	CR HDL 3953 R	CR HDL 3953 V
225,42	276,22	20,62		
9.000	10.500	0.687	CR HDL 3954 R	CR HDL 3954 V
228,60	266,70	17,45		
	11.000	0.812	CR HDL 3955 R	CR HDL 3955 V
	279,40	20,62		
9.125	10.625	0.687	CR HDL 3957 R	CR HDL 3957 V
231,77	269,87	17,45		
	11.125	0.812	CR HDL 3962 R	CR HDL 3962 V
	282,57	20,62		
9.250	10.750	0.687	CR HDL 3963 R	CR HDL 3963 V
234,95	273,05	17,45		
	11.250	0.687	CR HDL 9706 R	CR HDL 9706 V
	285,75	17,45		
9.375	11.375	0.812	CR HDL 4610 R	CR HDL 4610 V
238,12	288,92	20,62		
9.500	10.750	0.562	CR HDL 3145 R	CR HDL 3145 V
241,30	273,05	14,28		
	11.250	0.750	CR HDL 3981 R	CR HDL 3981 V
	285,75	19,05		
	11.500	0.812	CR HDL 3984 R	CR HDL 3984 V
	292,10	20,62		
9.750	11.125	0.562	CR HDL 1692 R	CR HDL 1692 V
247,65	282,57	14,28		
	11.250	0.687	CR HDL 3985 R	CR HDL 3985 V
	285,75	17,45		
	11.750	0.687	CR HDL 9425 R	CR HDL 9425 V
	298,45	17,45		
10.000	11.500	0.687	CR HDL 3992 R	CR HDL 3992 V
254,00	292,10	17,45		
	11.750	0.750	CR HDL 3994 R	CR HDL 3994 V
	298,45	19,05		
	12.000	0.812	CR HDL 3997 R	CR HDL 3997 V
	304,80	20,62		
	12.000	0.875	CR HDL 3998 R	CR HDL 3998 V
	304,80	22,22		
	12.250	0.812	CR HDL 3669 R	CR HDL 3669 V
	311,15	20,62		

Series HDL - Inch sizes

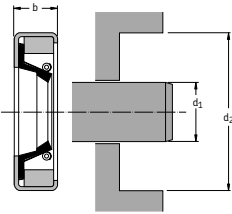

Dimensions shaft	bore	seal width	SKF Designation	Lip material	
d ₁	d ₂	b	R	V	
in (mm)					
10.125	11.625	0.687	CR HDL 3999 R		CR HDL 3999 V
257,17	295,27	17,45			
	11.750	0.687	CR HDL 5989 R		CR HDL 5989 V
	298,45	17,45			
10.250	11.750	0.687	CR HDL 4004 R		CR HDL 4004 V
260,35	298,45	17,45			
	12.250	0.812	CR HDL 4009 R		CR HDL 4009 V
	311,15	20,62			
	12.500	0.812	CR HDL 4015 R		CR HDL 4015 V
	317,50	20,62			
10.500	12.000	0.687	CR HDL 4011 R		CR HDL 4011 V
266,70	304,80	17,45			
	12.500	0.812	CR HDL 4017 R		CR HDL 4017 V
	317,50	20,62			
10.750	12.250	0.687	CR HDL 4023 R		CR HDL 4023 V
273,05	311,15	17,45			
	12.500	0.875	CR HDL 4033 R		CR HDL 4033 V
	317,50	22,22			
	12.750	0.625	CR HDL 3014 R		CR HDL 3014 V
	323,85	15,87			
	12.750	0.812	CR HDL 4031 R		CR HDL 4031 V
	323,85	20,62			
	13.000	0.812	CR HDL 4022 R		CR HDL 4022 V
	330,20	20,62			
	13.250	0.812	CR HDL 4026 R		CR HDL 4026 V
	336,55	20,62			
10.875	12.375	0.687	CR HDL 4027 R		CR HDL 4027 V
276,22	314,32	17,45			
	12.500	0.687	CR HDL 4028 R		CR HDL 4028 V
	317,50	17,45			
11.000	12.250	0.562	CR HDL 3135 R		CR HDL 3135 V
279,40	311,15	14,28			
	12.500	0.687	CR HDL 4611 R		CR HDL 4611 V
	317,50	17,45			
	13.000	0.687	CR HDL 6034 R		CR HDL 6034 V
	330,20	17,45			
	13.000	0.812	CR HDL 4036 R		CR HDL 4036 V
	330,20	20,62			

Series HDL - Inch sizes

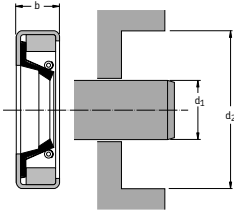

Dimensions shaft d_1	bore d_2	seal width b	SKF Designation Lip material R	V
in (mm)				
11.125 282,57	13.000 330,20	0.687 17,45	CR HDL 3699 R	CR HDL 3699 V
	13.250 336,55	0.812 20,62	CR HDL 3700 R	CR HDL 3700 V
11.250 285,75	12.750 323,85	0.687 17,45	CR HDL 4527 R	CR HDL 4527 V
	13.250 336,55	0.687 17,45	CR HDL 8778 R	CR HDL 8778 V
	13.250 336,55	0.812 20,62	CR HDL 4047 R	CR HDL 4047 V
11.375 288,92	13.375 339,72	0.812 20,62	CR HDL 4052 R	CR HDL 4052 V
11.500 292,10	13.000 330,20	0.687 17,45	CR HDL 4057 R	CR HDL 4057 V
	13.500 342,90	0.812 20,62	CR HDL 4063 R	CR HDL 4063 V
11.750 298,45	13.250 336,55	0.687 17,45	CR HDL 4064 R	CR HDL 4064 V
12.000 304,80	13.500 342,90	0.687 17,45	CR HDL 4612 R	CR HDL 4612 V
	13.625 346,07	0.687 17,45	CR HDL 8523 R	CR HDL 8523 V
	13.750 349,25	0.687 17,45	CR HDL 3701 R	CR HDL 3701 V
	14.000 355,60	0.687 17,45	CR HDL 5838 R	CR HDL 5838 V
	14.000 355,60	0.750 19,05	CR HDL 4071 R	CR HDL 4071 V
	14.000 355,60	0.812 20,62	CR HDL 4072 R	CR HDL 4072 V
	14.750 374,65	0.812 20,62	CR HDL 3702 R	CR HDL 3702 V
12.125 307,97	13.875 352,42	0.687 17,45	CR HDL 4053 R	CR HDL 4053 V

Series HDL - Inch sizes

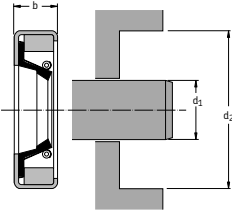

Dimensions shaft	bore	seal width	SKF Designation	Lip material	
d ₁	d ₂	b	R	V	
in (mm)					
12.250	13.750	0.687	CR HDL 4613 R		CR HDL 4613 V
<i>311,15</i>	<i>349,25</i>	<i>17,45</i>			
	13.750	0.875	CR HDL 4614 R		CR HDL 4614 V
	<i>349,25</i>	<i>22,22</i>			
	14.000	0.687	CR HDL 4055 R		CR HDL 4055 V
	<i>355,60</i>	<i>17,45</i>			
	14.250	0.812	CR HDL 4075 R		CR HDL 4075 V
	<i>361,95</i>	<i>20,62</i>			
12.375	13.875	0.687	CR HDL 4076 R		CR HDL 4076 V
<i>314,32</i>	<i>352,42</i>	<i>17,45</i>			
	14.000	0.687	CR HDL 4056 R		CR HDL 4056 V
	<i>355,60</i>	<i>17,45</i>			
	14.375	0.687	CR HDL 4097 R		CR HDL 4097 V
	<i>365,12</i>	<i>17,45</i>			
	14.500	0.812	CR HDL 4106 R		CR HDL 4106 V
	<i>368,30</i>	<i>20,62</i>			
12.500	14.000	0.687	CR HDL 4079 R		CR HDL 4079 V
<i>317,50</i>	<i>355,60</i>	<i>17,45</i>			
	14.500	0.750	CR HDL 4082 R		CR HDL 4082 V
	<i>368,30</i>	<i>19,05</i>			
	14.500	0.812	CR HDL 4083 R		CR HDL 4083 V
	<i>368,30</i>	<i>20,62</i>			
	15.000	0.812	CR HDL 4084 R		CR HDL 4084 V
	<i>381,00</i>	<i>20,62</i>			
12.625	14.125	0.687	CR HDL 4081 R		CR HDL 4081 V
<i>320,67</i>	<i>358,77</i>	<i>17,45</i>			
	14.500	0.687	CR HDL 3716 R		CR HDL 3716 V
	<i>368,30</i>	<i>17,45</i>			
12.687	14.750	0.812	CR HDL 9766 R		CR HDL 9766 V
<i>322,24</i>	<i>374,65</i>	<i>20,62</i>			
12.750	14.250	0.687	CR HDL 4089 R		CR HDL 4089 V
<i>323,85</i>	<i>361,95</i>	<i>17,45</i>			
	14.750	0.687	CR HDL 7652 R		CR HDL 7652 V
	<i>374,65</i>	<i>17,45</i>			
	15.000	0.812	CR HDL 4092 R		CR HDL 4092 V
	<i>381,00</i>	<i>20,62</i>			
12.875	15.000	0.812	CR HDL 5404 R		CR HDL 5404 V
<i>327,02</i>	<i>381,00</i>	<i>20,62</i>			

Series HDL - Inch sizes

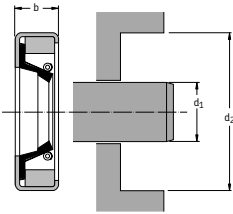

Dimensions shaft	bore	seal width	SKF Designation	Lip material	V
d_1	d_2	b	R		
in (mm)					
13.000	14.500	0.687	CR HDL 4093 R		CR HDL 4093 V
330,20	368,30	17,45			
	14.875	0.687	CR HDL 4096 R		CR HDL 4096 V
	377,82	17,45			
	15.000	0.812	CR HDL 4099 R		CR HDL 4099 V
	381,00	20,62			
13.250	14.750	0.687	CR HDL 4101 R		CR HDL 4101 V
336,55	374,65	17,45			
	14.875	0.687	CR HDL 7734 R		CR HDL 7734 V
	377,82	17,45			
	15.000	0.687	CR HDL 7169 R		CR HDL 7169 V
	381,00	17,45			
	15.125	0.687	CR HDL 4105 R		CR HDL 4105 V
	384,17	17,45			
	15.250	0.687	CR HDL 6294 R		CR HDL 6294 V
	387,35	17,45			
	15.250	0.812	CR HDL 4779 R		CR HDL 4779 V
	387,35	20,62			
13.500	15.000	0.687	CR HDL 4121 R		CR HDL 4121 V
342,90	381,00	17,45			
	15.500	0.812	CR HDL 4128 R		CR HDL 4128 V
	393,70	20,62			
	15.750	0.812	CR HDL 4123 R		CR HDL 4123 V
	400,05	20,62			
13.625	15.500	0.687	CR HDL 4120 R		CR HDL 4120 V
346,07	393,70	17,45			
13.750	15.250	0.687	CR HDL 4529 R		CR HDL 4529 V
349,25	387,35	17,45			
	15.500	0.750	CR HDL 4531 R		CR HDL 4531 V
	393,70	19,05			
	15.750	0.812	CR HDL 4129 R		CR HDL 4129 V
	400,05	20,62			
	16.000	0.812	CR HDL 4119 R		CR HDL 4119 V
	406,40	20,62			
13.813	16.000	0.812	CR HDL 4108 R		CR HDL 4108 V
350,85	406,40	20,62			

Series HDL - Inch sizes

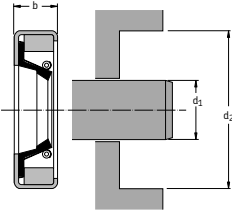

Dimensions shaft d ₁	bore d ₂	seal width b	SKF Designation Lip material R	V
in (mm)				
13.875 352,42	16.000 406,40	0.812 20,62	CR HDL 4110 R	CR HDL 4110 V
13.937 353,99	15.437 392,09	0.687 17,45	CR HDL 4130 R	CR HDL 4130 V
13.938 354,02	15.500 393,70	0.687 17,45	CR HDL 4111 R	CR HDL 4111 V
	16.000 406,40	0.687 17,45	CR HDL 4112 R	CR HDL 4112 V
14.000 355,60	15.500 393,70	0.687 17,45	CR HDL 4131 R	CR HDL 4131 V
	15.750 400,05	0.687 17,45	CR HDL 5991 R	CR HDL 5991 V
	15.750 400,05	0.750 19,05	CR HDL 4134 R	CR HDL 4134 V
	16.000 406,40	0.812 20,62	CR HDL 4135 R	CR HDL 4135 V
	16.250 412,75	0.812 20,62	CR HDL 5382 R	CR HDL 5382 V
	16.500 419,10	0.812 20,62	CR HDL 7535 R	CR HDL 7535 V
14.187 360,34	16.732 424,99	0.812 20,62	CR HDL 9280 R	CR HDL 9280 V
14.250 361,95	15.750 400,05	0.687 17,45	CR HDL 4118 R	CR HDL 4118 V
	16.000 406,40	0.687 17,45	CR HDL 4139 R	CR HDL 4139 V
	16.250 412,75	0.812 20,62	CR HDL 4140 R	CR HDL 4140 V
	16.500 419,10	0.812 20,62	CR HDL 3855 R	CR HDL 3855 V
14.375 365,12	16.000 406,40	0.687 17,45	CR HDL 5481 R	CR HDL 5481 V
14.500 368,30	16.000 406,40	0.687 17,45	CR HDL 4142 R	CR HDL 4142 V
	16.500 419,10	0.812 20,62	CR HDL 4145 R	CR HDL 4145 V

Series HDL - Inch sizes

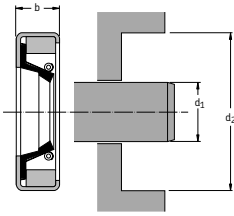

Dimensions shaft	bore	seal width	SKF Designation	Lip material	V
d_1	d_2	b	R		
in (mm)					
14.625	16.250	0.687	CR HDL 3856 R		CR HDL 3856 V
371,47	412,75	17,45			
	16.750	0.812	CR HDL 3857 R		CR HDL 3857 V
	425,45	20,62			
14.750	16.250	0.687	CR HDL 4147 R		CR HDL 4147 V
374,65	412,75	17,45			
	16.500	0.687	CR HDL 5990 R		CR HDL 5990 V
	419,10	17,45			
14.875	16.500	0.687	CR HDL 3858 R		CR HDL 3858 V
377,82	419,10	17,45			
	16.750	0.687	CR HDL 3859 R		CR HDL 3859 V
	425,45	17,45			
	16.875	0.937	CR HDL 2622 R		CR HDL 2622 V
	428,62	23,79			
	16.875	1.000	CR HDL 4150 R		CR HDL 4150 V
	428,62	25,40			
	17.000	0.812	CR HDL 3860 R		CR HDL 3860 V
	431,80	20,62			
14.906	17.000	0.812	CR HDL 3861 R		CR HDL 3861 V
378,61	431,80	20,62			
15.000	16.500	0.687	CR HDL 4151 R		CR HDL 4151 V
381,00	419,10	17,45			
	17.000	0.812	CR HDL 4156 R		CR HDL 4156 V
	431,80	20,62			
	17.250	0.812	CR HDL 3862 R		CR HDL 3862 V
	438,15	20,62			
	17.250	0.812	CR HDL 8508 R		CR HDL 8508 V
	438,15	20,62			
	17.500	0.812	CR HDL 9637 R		CR HDL 9637 V
	444,50	20,62			
	17.750	0.812	CR HDL 3862 R		CR HDL 3862 V
	450,85	20,62			
15.125	16.750	0.687	CR HDL 4165 R		CR HDL 4165 V
384,17	425,45	17,45			

Series HDL – Inch sizes

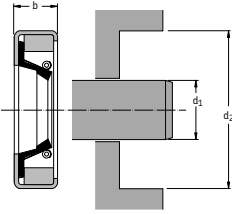

Dimensions		seal width b	SKF Designation	
shaft d ₁	bore d ₂		Lip material R	V
in (mm)				
15.250 387,35	16.750	0.687	CR HDL 4615 R	CR HDL 4615 V
	425,45	17,45		
	17.250	0.812	CR HDL 4476 R	CR HDL 4476 V
	438,15	20,62		
	17.250	0.875	CR HDL 3030 R	CR HDL 3030 V
	438,15	22,22		
15.312 388,92	16.875	0.687	CR HDL 4158 R	CR HDL 4158 V
	428,62	17,45		
	17.312	0.687	CR HDL 5992 R	CR HDL 5992 V
	439,72	17,45		
15.359 390,11	17.717	0.687	CR HDL 4166 R	CR HDL 4166 V
	450,01	17,45		
15.375 390,52	17.250	0.687	CR HDL 4167 R	CR HDL 4167 V
	438,15	17,45		
	17.375	0.812	CR HDL 4159 R	CR HDL 4159 V
	441,32	20,62		
15.500 393,70	17.496	0.812	CR HDL 4163 R	CR HDL 4163 V
	444,40	20,62		
	17.750	0.812	CR HDL 6771 R	CR HDL 6771 V
	450,85	20,62		
	18.000	0.812	CR HDL 4168 R	CR HDL 4168 V
	457,20	20,62		
15.750 400,05	17.165	0.687	CR HDL 9986 R	CR HDL 9986 V
	436,00	17,45		
	17.250	0.687	CR HDL 4170 R	CR HDL 4170 V
	438,15	17,45		
	17.312	0.687	CR HDL 9271 R	CR HDL 9271 V
	439,72	17,45		
	17.500	0.687	CR HDL 4171 R	CR HDL 4171 V
	444,50	17,45		
	17.750	0.687	CR HDL 6874 R	CR HDL 6874 V
	450,85	17,45		
	18.000	0.812	CR HDL 4172 R	CR HDL 4172 V
	457,20	20,62		
	18.500	1.000	CR HDL 4175 R	CR HDL 4175 V
469,90	25,40			
15.875 403,22	17.875	0.812	CR HDL 4176 R	CR HDL 4176 V
	454,02	20,62		

Series HDL – Inch sizes

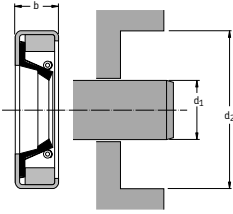

Dimensions shaft d_1	bore d_2	seal width b	SKF Designation Lip material R	V
in (mm)				
16.000	17.500	0.687	CR HDL 4177 R	CR HDL 4177 V
406,40	444,50	17,45		
	17.625	0.687	CR HDL 4173 R	CR HDL 4173 V
	447,67	17,45		
	18.000	0.812	CR HDL 4180 R	CR HDL 4180 V
	457,20	20,62		
	18.000	0.875	CR HDL 5077 R	CR HDL 5077 V
	457,20	22,22		
	18.500	0.812	CR HDL 5995 R	CR HDL 5995 V
	469,90	20,62		
16.250	17.750	0.687	CR HDL 4181 R	CR HDL 4181 V
412,75	450,85	17,45		
	18.000	0.687	CR HDL 8217 R	CR HDL 8217 V
	457,20	17,45		
	18.000	0.750	CR HDL 4184 R	CR HDL 4184 V
	457,20	19,05		
	18.250	0.687	CR HDL 9892 R	CR HDL 9892 V
	463,55	17,45		
	18.500	0.812	CR HDL 4174 R	CR HDL 4174 V
	469,90	20,62		
16.375	17.875	0.687	CR HDL 4179 R	CR HDL 4179 V
415,92	454,02	17,45		
16.500	18.000	0.687	CR HDL 9863 R	CR HDL 9863 V
419,10	457,20	17,45		
	18.500	0.687	CR HDL 4187 R	CR HDL 4187 V
	469,90	17,45		
	18.500	0.812	CR HDL 4186 R	CR HDL 4186 V
	469,90	20,62		
	19.000	0.812	CR HDL 4183 R	CR HDL 4183 V
	482,60	20,62		
16.535	18.504	0.875	CR HDL 1929 R	CR HDL 1929 V
419,98	470,00	22,22		
16.750	18.250	0.687	CR HDL 3744 R	CR HDL 3744 V
425,45	463,55	17,45		
	18.500	0.687	CR HDL 8862 R	CR HDL 8862 V
	469,90	17,45		
	19.000	0.812	CR HDL 3748 R	CR HDL 3748 V
	482,60	20,62		

Series HDL - Inch sizes

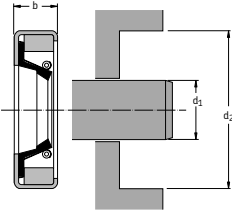

Dimensions shaft	bore	seal width	SKF Designation	Lip material	V
d_1	d_2	b	R		
in (mm)					
16.937	19.291	0.812	CR HDL 9695 R		CR HDL 9695 V
430,19	489,99	20,62			
17.000	18.500	0.687	CR HDL 4188 R		CR HDL 4188 V
431,80	469,90	17,45			
	19.000	0.812	CR HDL 4190 R		CR HDL 4190 V
	482,60	20,62			
	19.250	0.812	CR HDL 4191 R		CR HDL 4191 V
	488,95	20,62			
	19.500	0.812	CR HDL 3750 R		CR HDL 3750 V
	495,30	20,62			
17.250	18.750	0.687	CR HDL 3751 R		CR HDL 3751 V
438,15	476,25	17,45			
	18.750	0.750	CR HDL 6967 R		CR HDL 6967 V
	476,25	19,05			
17.500	19.000	0.687	CR HDL 4194 R		CR HDL 4194 V
444,50	482,60	17,45			
	19.250	0.687	CR HDL 5054 R		CR HDL 5054 V
	488,95	17,45			
	19.250	1.000	CR HDL 3005 R		CR HDL 3005 V
	488,95	25,40			
	19.500	0.687	CR HDL 4198 R		CR HDL 4198 V
	495,30	17,45			
	19.750	0.812	CR HDL 4197 R		CR HDL 4197 V
	501,65	20,62			
17.625	19.250	0.687	CR HDL 4199 R		CR HDL 4199 V
447,67	488,95	17,45			
	19.625	0.687	CR HDL 6850 R		CR HDL 6850 V
	498,47	17,45			
17.750	19.750	0.812	CR HDL 4200 R		CR HDL 4200 V
450,85	501,65	20,62			
	20.078	0.875	CR HDL 9084 R		CR HDL 9084 V
	509,98	22,22			
17.875	19.875	0.812	CR HDL 4204 R		CR HDL 4204 V
454,02	504,82	20,62			

Series HDL - Inch sizes

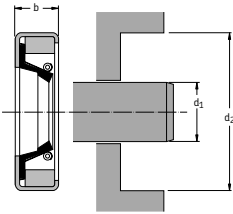

Dimensions shaft d_1	bore d_2	seal width b	SKF Designation Lip material R	V
in (mm)				
18.000	19.500	0.687	CR HDL 4206 R	CR HDL 4206 V
457,20	495,30	17,45		
	19.750	0.687	CR HDL 5728 R	CR HDL 5728 V
	501,65	17,45		
	19.875	0.687	CR HDL 4203 R	CR HDL 4203 V
	504,82	17,45		
	20.000	0.750	CR HDL 4209 R	CR HDL 4209 V
	508,00	19,05		
	20.000	0.875	CR HDL 4210 R	CR HDL 4210 V
	508,00	22,22		
	20.500	0.875	CR HDL 3752 R	CR HDL 3752 V
	520,70	22,22		
	21.000	0.875	CR HDL 3753 R	CR HDL 3753 V
	533,40	22,22		
18.120	20.500	0.875	CR HDL 3754 R	CR HDL 3754 V
460,24	520,70	22,22		
18.125	20.500	0.875	CR HDL 3756 R	CR HDL 3756 V
460,37	520,70	22,22		
18.250	19.750	0.687	CR HDL 3757 R	CR HDL 3757 V
463,55	501,65	17,45		
	19.875	0.687	CR HDL 3765 R	CR HDL 3765 V
	504,82	17,45		
18.375	19.875	0.687	CR HDL 4213 R	CR HDL 4213 V
466,72	504,82	17,45		
	19.937	0.687	CR HDL 7103 R	CR HDL 7103 V
	506,39	17,45		
	20.000	0.750	CR HDL 4215 R	CR HDL 4215 V
	508,00	19,05		
	20.375	0.812	CR HDL 6740 R	CR HDL 6740 V
	517,52	20,62		
	20.500	0.750	CR HDL 3767 R	CR HDL 3767 V
	520,70	19,05		
18.500	20.000	0.687	CR HDL 3768 R	CR HDL 3768 V
469,90	508,00	17,45		
	20.250	0.687	CR HDL 3772 R	CR HDL 3772 V
	514,35	17,45		
	20.500	0.875	CR HDL 4216 R	CR HDL 4216 V
	520,70	22,22		

Series HDL - Inch sizes

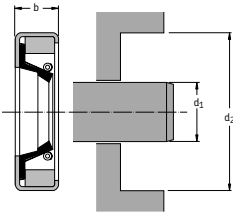

Dimensions shaft	bore	seal width	SKF Designation	Lip material	
d ₁	d ₂	b	R	V	
in (mm)					
19.000	20.500	0.750	CR HDL 4218 R		CR HDL 4218 V
482,60	520,70	19,05			
	21.000	0.875	CR HDL 4219 R		CR HDL 4219 V
	533,40	22,22			
	21.500	0.875	CR HDL 3773 R		CR HDL 3773 V
	546,10	22,22			
19.250	20.750	0.750	CR HDL 4617 R		CR HDL 4617 V
488,95	527,05	19,05			
	21.000	0.750	CR HDL 3777 R		CR HDL 3777 V
	533,40	19,05			
	21.250	0.750	CR HDL 5485 R		CR HDL 5485 V
	539,75	19,05			
19.375	21.000	0.750	CR HDL 3778 R		CR HDL 3778 V
492,12	533,40	19,05			
19.500	21.000	0.750	CR HDL 3779 R		CR HDL 3779 V
495,30	533,40	19,05			
	21.500	0.875	CR HDL 4221 R		CR HDL 4221 V
	546,10	22,22			
	21.688	0.875	CR HDL 3783 R		CR HDL 3783 V
	550,87	22,22			
19.750	21.750	0.875	CR HDL 4228 R		CR HDL 4228 V
501,65	552,45	22,22			
	22.125	0.875	CR HDL 7400 R		CR HDL 7400 V
	561,97	22,22			
	22.250	0.875	CR HDL 3785 R		CR HDL 3785 V
	565,15	22,22			
19.875	22.000	0.875	CR HDL 3788 R		CR HDL 3788 V
504,82	558,80	22,22			
19.937	21.687	0.625	CR HDL 4233 R		CR HDL 4233 V
506,39	550,84	15,87			
19.938	21.500	0.750	CR HDL 3789 R		CR HDL 3789 V
506,42	546,10	19,05			

Series HDL - Inch sizes

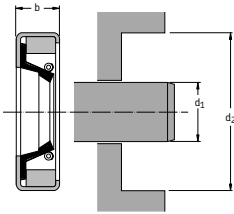

Dimensions shaft	bore	seal width	SKF Designation	Lip material	V
d_1	d_2	b	R		
in (mm)					
20.000	21.500	0.750	CR HDL 4235 R		CR HDL 4235 V
508,00	546,10	19,05			
	21.750	0.750	CR HDL 4236 R		CR HDL 4236 V
	552,45	19,05			
	22.000	0.875	CR HDL 4237 R		CR HDL 4237 V
	558,80	22,22			
	22.500	0.875	CR HDL 3790 R		CR HDL 3790 V
	571,50	22,22			
20.143	22.250	0.875	CR HDL 3792 R		CR HDL 3792 V
511,63	565,15	22,22			
20.250	21.750	0.750	CR HDL 4239 R		CR HDL 4239 V
514,35	552,45	19,05			
	22.245	0.875	CR HDL 8231 R		CR HDL 8231 V
	565,02	22,22			
	22.250	0.875	CR HDL 4240 R		CR HDL 4240 V
	565,15	22,22			
	22.375	0.750	CR HDL 4241 R		CR HDL 4241 V
	568,32	19,05			
	22.500	0.875	CR HDL 8770 R		CR HDL 8770 V
	571,50	22,22			
20.438	22.500	0.812	CR HDL 4242 R		CR HDL 4242 V
519,12	571,50	20,62			
20.500	22.000	0.750	CR HDL 4619 R		CR HDL 4619 V
520,70	558,80	19,05			
	22.250	0.812	CR HDL 4245 R		CR HDL 4245 V
	565,15	20,62			
	22.500	0.875	CR HDL 4246 R		CR HDL 4246 V
	571,50	22,22			
	22.750	0.875	CR HDL 6287 R		CR HDL 6287 V
	577,85	22,22			
20.625	22.625	0.812	CR HDL 9893 R		CR HDL 9893 V
523,87	574,67	20,62			
20.750	22.750	0.875	CR HDL 4248 R		CR HDL 4248 V
527,05	577,85	22,22			
	23.000	0.812	CR HDL 4243 R		CR HDL 4243 V
	584,20	20,62			

Series HDL - Inch sizes

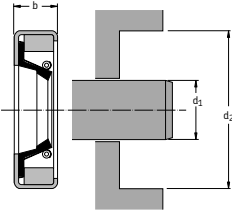

Dimensions shaft d ₁	bore d ₂	seal width b	SKF Designation Lip material R	V
in (mm)				
20.875	22.875	0.875	CR HDL 4250 R	CR HDL 4250 V
530,22	581,02	22,22		
	23.228	0.875	CR HDL 6417 R	CR HDL 6417 V
	589,99	22,22		
21.000	22.500	0.750	CR HDL 5259 R	CR HDL 5259 V
533,40	571,50	19,05		
	22.750	0.750	CR HDL 5312 R	CR HDL 5312 V
	577,85	19,05		
	23.000	0.812	CR HDL 6535 R	CR HDL 6535 V
	584,20	20,62		
	23.000	0.875	CR HDL 4253 R	CR HDL 4253 V
	584,20	22,22		
	23.250	0.812	CR HDL 4251 R	CR HDL 4251 V
	590,55	20,62		
	23.500	0.875	CR HDL 9772 R	CR HDL 9772 V
	596,90	22,22		
21.250	23.000	0.750	CR HDL 4255 R	CR HDL 4255 V
539,75	584,20	19,05		
	23.250	0.875	CR HDL 4254 R	CR HDL 4254 V
	590,55	22,22		
21.437	23.187	0.750	CR HDL 4256 R	CR HDL 4256 V
544,49	588,94	19,05		
21.500	23.250	0.750	CR HDL 4257 R	CR HDL 4257 V
546,10	590,55	19,05		
	23.500	0.812	CR HDL 7407 R	CR HDL 7407 V
	596,90	20,62		
	23.500	0.875	CR HDL 4259 R	CR HDL 4259 V
	596,90	22,22		
	23.625	0.875	CR HDL 6493 R	CR HDL 6493 V
	600,07	22,22		
	24.000	0.875	CR HDL 6779 R	CR HDL 6779 V
	609,60	22,22		
21.625	23.375	0.750	CR HDL 4261 R	CR HDL 4261 V
549,27	593,72	19,05		
	23.625	0.875	CR HDL 4263 R	CR HDL 4263 V
	600,07	22,22		

Series HDL - Inch sizes

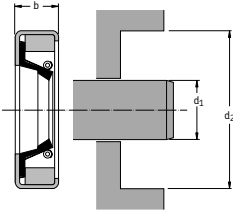

Dimensions shaft	bore	seal width	SKF Designation	Lip material	V
d ₁	d ₂	b	R		
in (mm)					
21.750	23.250	0.750	CR HDL 4621 R		CR HDL 4621 V
552,45	590,55	19,05			
	23.750	0.875	CR HDL 4265 R		CR HDL 4265 V
	603,25	22,22			
	24.000	0.875	CR HDL 5276 R		CR HDL 5276 V
	609,60	22,22			
	24.250	0.875	CR HDL 8675 R		CR HDL 8675 V
	615,95	22,22			
	24.500	0.875	CR HDL 4260 R		CR HDL 4260 V
	622,30	22,22			
	24.750	0.875	CR HDL 4262 R		CR HDL 4262 V
	628,65	22,22			
22.000	23.500	0.750	CR HDL 4269 R		CR HDL 4269 V
558,80	596,90	19,05			
	24.000	0.875	CR HDL 4270 R		CR HDL 4270 V
	609,60	22,22			
	24.250	0.812	CR HDL 9082 R		CR HDL 9082 V
	615,95	20,62			
	24.250	0.875	CR HDL 3763 R		CR HDL 3763 V
	615,95	22,22			
	24.500	0.875	CR HDL 6295 R		CR HDL 6295 V
	622,30	22,22			
22.250	24.250	0.875	CR HDL 3764 R		CR HDL 3764 V
565,15	615,95	22,22			
22.375	24.250	0.750	CR HDL 4268 R		CR HDL 4268 V
568,32	615,95	19,05			
	24.375	0.750	CR HDL 6999 R		CR HDL 6999 V
	619,12	19,05			
	24.375	0.875	CR HDL 2576 R		CR HDL 2576 V
	619,12	22,22			
22.437	24.000	0.750	CR HDL 4275 R		CR HDL 4275 V
569,89	609,60	19,05			
	24.250	0.750	CR HDL 4276 R		CR HDL 4276 V
	615,95	19,05			
	24.437	0.750	CR HDL 6480 R		CR HDL 6480 V
	620,69	19,05			
	24.437	0.875	CR HDL 1915 R		CR HDL 1915 V
	620,69	22,22			
	24.500	0.750	CR HDL 9840 R		CR HDL 9840 V
	622,30	19,05			

Series HDL - Inch sizes

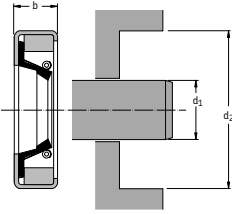

Dimensions shaft d ₁	bore d ₂	seal width b	SKF Designation Lip material R	V
in (mm)				
22.500 571,50	24.000	0.750	CR HDL 4271 R	CR HDL 4271 V
	609,60	19,05		
	24.250	0.750	CR HDL 4272 R	CR HDL 4272 V
	615,95	19,05		
	24.500	0.875	CR HDL 4279 R	CR HDL 4279 V
	622,30	22,22		
	24.750	0.875	CR HDL 4273 R	CR HDL 4273 V
	628,65	22,22		
	25.000	0.875	CR HDL 4274 R	CR HDL 4274 V
635,00	22,22			
22.750 577,85	24.750	0.875	CR HDL 4281 R	CR HDL 4281 V
	628,65	22,22		
	25.000	0.875	CR HDL 6843 R	CR HDL 6843 V
	635,00	22,22		
23.000 584,20	24.500	0.750	CR HDL 4283 R	CR HDL 4283 V
	622,30	19,05		
	24.750	0.750	CR HDL 5421 R	CR HDL 5421 V
	628,65	19,05		
	25.000	0.875	CR HDL 4284 R	CR HDL 4284 V
	635,00	22,22		
	25.375	0.875	CR HDL 4277 R	CR HDL 4277 V
	644,52	22,22		
	25.500	0.875	CR HDL 4285 R	CR HDL 4285 V
647,70	22,22			
23.250 590,55	25.000	0.750	CR HDL 4286 R	CR HDL 4286 V
	635,00	19,05		
	25.250	0.750	CR HDL 9371 R	CR HDL 9371 V
	641,35	19,05		
	25.250	0.812	CR HDL 6910 R	CR HDL 6910 V
641,35	20,62			
23.375 593,72	25.375	0.875	CR HDL 4287 R	CR HDL 4287 V
	644,52	22,22		
23.500 596,90	24.681	0.591	CR HDL 3033 R	CR HDL 3033 V
	626,90	15,00		
	25.250	0.750	CR HDL 5547 R	CR HDL 5547 V
	641,35	19,05		
	25.500	0.875	CR HDL 4288 R	CR HDL 4288 V
647,70	22,22			

Series HDL - Inch sizes

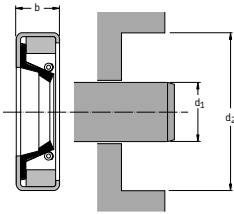

Dimensions shaft	bore	seal width	SKF Designation	Lip material	V
d_1	d_2	b	R		
in (mm)					
23.562	25.250	0.750	CR HDL 4290 R		CR HDL 4290 V
598,47	641,35	19,05			
	25.375	0.750	CR HDL 4291 R		CR HDL 4291 V
	644,52	19,05			
23.625	26.000	0.875	CR HDL 4292 R		CR HDL 4292 V
600,07	660,40	22,22			
23.750	25.250	1.000	CR HDL 6239 R		CR HDL 6239 V
603,25	641,35	25,40			
23.875	26.000	0.875	CR HDL 4293 R		CR HDL 4293 V
606,42	660,40	22,22			
24.000	25.500	0.750	CR HDL 4623 R		CR HDL 4623 V
609,60	647,70	19,05			
	26.000	0.750	CR HDL 9988 R		CR HDL 9988 V
	660,40	19,05			
	26.000	0.812	CR HDL 4295 R		CR HDL 4295 V
	660,40	20,62			
	26.000	0.875	CR HDL 4294 R		CR HDL 4294 V
	660,40	22,22			
	26.250	0.875	CR HDL 6293 R		CR HDL 6293 V
	666,75	22,22			
	26.500	0.875	CR HDL 4297 R		CR HDL 4297 V
	673,10	22,22			
	27.000	0.875	CR HDL 5644 R		CR HDL 5644 V
	685,80	22,22			
24.250	26.250	0.875	CR HDL 4301 R		CR HDL 4301 V
615,95	666,75	22,22			
	26.250	1.000	CR HDL 3770 R		CR HDL 3770 V
	666,75	25,40			
24.437	26.000	0.750	CR HDL 4302 R		CR HDL 4302 V
620,69	660,40	19,05			
	26.437	0.750	CR HDL 4304 R		CR HDL 4304 V
	671,49	19,05			
	26.935	1.000	CR HDL 9990 R		CR HDL 9990 V
	684,15	25,40			
24.500	26.500	0.875	CR HDL 4305 R		CR HDL 4305 V
622,30	673,10	22,22			

Series HDL - Inch sizes

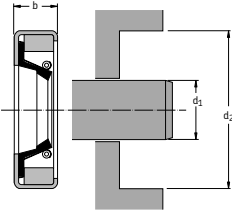

Dimensions shaft		bore	seal width	SKF Designation	Lip material
d ₁	d ₂	b		R	V
in (mm)					
25.000	26.500	0.750		CR HDL 4308 R	CR HDL 4308 V
635,00	673,10	19,05			
	27.000	0.875		CR HDL 3774 R	CR HDL 3774 V
	685,80	22,22			
	27.000	1.000		CR HDL 4309 R	CR HDL 4309 V
	685,80	25,40			
	27.250	0.875		CR HDL 6421 R	CR HDL 6421 V
	692,15	22,22			
	27.482	0.875		CR HDL 5997 R	CR HDL 5997 V
	698,05	22,22			
25.187	26.875	0.750		CR HDL 4311 R	CR HDL 4311 V
639,74	682,62	19,05			
	26.937	0.750		CR HDL 5994 R	CR HDL 5994 V
	684,19	19,05			
25.250	27.250	0.750		CR HDL 4299 R	CR HDL 4299 V
641,35	692,15	19,05			
25.500	26.750	0.750		CR HDL 3022 R	CR HDL 3022 V
647,70	679,45	19,05			
	27.000	0.875		CR HDL 4300 R	CR HDL 4300 V
	685,80	22,22			
	27.500	0.875		CR HDL 4318 R	CR HDL 4318 V
	698,50	22,22			
25.750	27.500	0.750		CR HDL 6998 R	CR HDL 6998 V
654,05	698,50	19,05			
25.875	28.000	0.875		CR HDL 4303 R	CR HDL 4303 V
657,22	711,20	22,22			
25.988	27.625	0.750		CR HDL 4306 R	CR HDL 4306 V
660,09	701,67	19,05			
26.000	27.625	0.750		CR HDL 5921 R	CR HDL 5921 V
660,40	701,67	19,05			
	28.000	0.875		CR HDL 4325 R	CR HDL 4325 V
	711,20	22,22			
	28.125	0.875		CR HDL 9402 R	CR HDL 9402 V
	714,37	22,22			
	28.500	0.875		CR HDL 4794 R	CR HDL 4794 V
	723,90	22,22			

Series HDL - Inch sizes

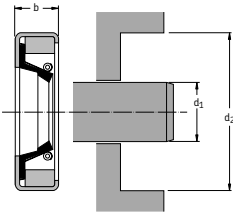

Dimensions shaft d_1	bore d_2	seal width b	SKF Designation Lip material R	V
in (mm)				
26.125 663,57	27.625 701,67	0.750 19,05	CR HDL 4329 R	CR HDL 4329 V
	28.125 714,37	0.875 22,22	CR HDL 4330 R	CR HDL 4330 V
26.375 669,92	28.188 715,97	0.875 22,22	CR HDL 4307 R	CR HDL 4307 V
	28.250 717,55	0.875 22,22	CR HDL 4312 R	CR HDL 4312 V
26.500 673,10	28.000 711,20	0.750 19,05	CR HDL 4533 R	CR HDL 4533 V
	28.500 723,90	0.875 22,22	CR HDL 4313 R	CR HDL 4313 V
27.000 685,80	29.000 736,60	0.875 22,22	CR HDL 4333 R	CR HDL 4333 V
	29.500 749,30	0.875 22,22	CR HDL 8031 R	CR HDL 8031 V
	30.000 762,00	0.875 22,22	CR HDL 9984 R	CR HDL 9984 V
27.250 692,15	29.250 742,95	0.875 22,22	CR HDL 4626 R	CR HDL 4626 V
27.500 698,50	29.000 736,60	0.750 19,05	CR HDL 4315 R	CR HDL 4315 V
	29.500 749,30	0.875 22,22	CR HDL 4339 R	CR HDL 4339 V
27.625 701,67	29.625 752,47	0.750 19,05	CR HDL 5001 R	CR HDL 5001 V
	29.500 749,30	0.750 19,05	CR HDL 4336 R	CR HDL 4336 V
27.875 708,02	29.812 757,22	0.875 22,22	CR HDL 4341 R	CR HDL 4341 V

Series HDL - Inch sizes

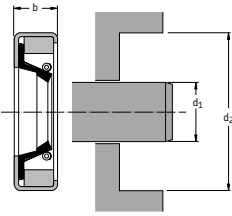

Dimensions shaft	bore	seal width	SKF Designation	Lip material	
d ₁	d ₂	b	R	V	
in (mm)					
28.000	29.500	0.750	CR HDL 4343 R		CR HDL 4343 V
<i>711,20</i>	<i>749,30</i>	<i>19,05</i>			
	29.625	0.750	CR HDL 7828 R		CR HDL 7828 V
	<i>752,47</i>	<i>19,05</i>			
	29.813	0.750	CR HDL 4316 R		CR HDL 4316 V
	<i>757,25</i>	<i>19,05</i>			
	30.000	0.875	CR HDL 4344 R		CR HDL 4344 V
	<i>762,00</i>	<i>22,22</i>			
	30.250	0.812	CR HDL 4320 R		CR HDL 4320 V
	<i>768,35</i>	<i>20,62</i>			
	30.500	0.875	CR HDL 3878 R		CR HDL 3878 V
	<i>774,70</i>	<i>22,22</i>			
	31.000	0.875	CR HDL 5998 R		CR HDL 5998 V
	<i>787,40</i>	<i>22,22</i>			
28.438	31.000	0.875	CR HDL 4321 R		CR HDL 4321 V
<i>722,32</i>	<i>787,40</i>	<i>22,22</i>			
28.500	30.500	0.875	CR HDL 4346 R		CR HDL 4346 V
<i>723,90</i>	<i>774,70</i>	<i>22,22</i>			
	31.000	0.875	CR HDL 4534 R		CR HDL 4534 V
	<i>787,40</i>	<i>22,22</i>			
28.750	30.750	0.875	CR HDL 4628 R		CR HDL 4628 V
<i>730,25</i>	<i>781,05</i>	<i>22,22</i>			
29.000	30.500	0.750	CR HDL 4347 R		CR HDL 4347 V
<i>736,60</i>	<i>774,70</i>	<i>19,05</i>			
	31.000	0.875	CR HDL 4348 R		CR HDL 4348 V
	<i>787,40</i>	<i>22,22</i>			
	31.500	1.000	CR HDL 8793 R		CR HDL 8793 V
	<i>800,10</i>	<i>25,40</i>			
	32.000	0.875	CR HDL 4537 R		CR HDL 4537 V
	<i>812,80</i>	<i>22,22</i>			

Series HDL - Inch sizes

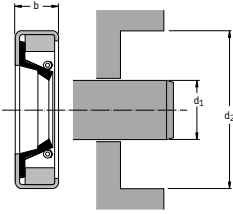

Dimensions shaft	bore	seal width	SKF Designation	Lip material	V
d_1	d_2	b	R		
in (mm)					
29.500	31.500	0.875	CR HDL 4352 R		CR HDL 4352 V
749,30	800,10	22,22			
	31.500	1.000	CR HDL 3791 R		CR HDL 3791 V
	800,10	25,40			
	32.000	0.875	CR HDL 4538 R		CR HDL 4538 V
	812,80	22,22			
	32.250	0.875	CR HDL 4322 R		CR HDL 4322 V
	819,15	22,22			
	32.500	0.875	CR HDL 4539 R		CR HDL 4539 V
	825,50	22,22			
30.000	31.500	0.750	CR HDL 4356 R		CR HDL 4356 V
762,00	800,10	19,05			
	31.616	0.750	CR HDL 5000 R		CR HDL 5000 V
	803,04	19,05			
	31.625	0.750	CR HDL 7870 R		CR HDL 7870 V
	803,27	19,05			
	32.000	0.875	CR HDL 4357 R		CR HDL 4357 V
	812,80	22,22			
	32.250	0.875	CR HDL 4323 R		CR HDL 4323 V
	819,15	22,22			
	32.500	0.875	CR HDL 4358 R		CR HDL 4358 V
	825,50	22,22			
	32.500	1.000	CR HDL 3797 R		CR HDL 3797 V
	825,50	25,40			
	32.750	0.875	CR HDL 4359 R		CR HDL 4359 V
	831,85	22,22			
	33.000	0.875	CR HDL 4360 R		CR HDL 4360 V
	838,20	22,22			
30.250	32.500	0.875	CR HDL 4906 R		CR HDL 4906 V
768,35	825,50	22,22			
30.312	32.375	0.875	CR HDL 4361 R		CR HDL 4361 V
769,92	822,32	22,22			
30.500	32.500	0.875	CR HDL 4365 R		CR HDL 4365 V
774,70	825,50	22,22			
	33.000	0.875	CR HDL 8577 R		CR HDL 8577 V
	838,20	22,22			
	33.500	0.875	CR HDL 8230 R		CR HDL 8230 V
	850,90	22,22			

Series HDL - Inch sizes

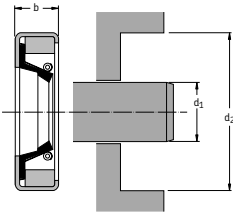

Dimensions shaft	bore	seal width	SKF Designation	Lip material
d ₁	d ₂	b	R	V
in (mm)				
31.000	32.500	0.750	CR HDL 5739 R	CR HDL 5739 V
787,40	825,50	19,05		
	33.000	0.875	CR HDL 4367 R	CR HDL 4367 V
	838,20	22,22		
	33.500	0.875	CR HDL 4540 R	CR HDL 4540 V
	850,90	22,22		
	34.000	0.875	CR HDL 4541 R	CR HDL 4541 V
	863,60	22,22		
31.250	32.750	0.750	CR HDL 4631 R	CR HDL 4631 V
793,75	831,85	19,05		
	33.250	0.750	CR HDL 5033 R	CR HDL 5033 V
	844,55	19,05		
31.750	33.750	0.875	CR HDL 5016 R	CR HDL 5016 V
806,45	857,25	22,22		
32.000	33.500	0.750	CR HDL 3023 R	CR HDL 3023 V
812,80	850,90	19,05		
	34.000	0.875	CR HDL 4632 R	CR HDL 4632 V
	863,60	22,22		
	34.500	0.875	CR HDL 8407 R	CR HDL 8407 V
	876,30	22,22		
32.125	34.125	0.875	CR HDL 4371 R	CR HDL 4371 V
815,97	866,77	22,22		
	34.625	0.875	CR HDL 7537 R	CR HDL 7537 V
	879,47	22,22		
	34.125	0.750	CR HDL 3002 R	CR HDL 3002 V
	866,77	19,05		
32.312	34.500	0.875	CR HDL 4373 R	CR HDL 4373 V
820,72	876,30	22,22		
32.500	34.500	0.875	CR HDL 4377 R	CR HDL 4377 V
825,50	876,30	22,22		
32.750	34.250	0.750	CR HDL 4542 R	CR HDL 4542 V
831,85	869,95	19,05		
	35.000	0.875	CR HDL 8289 R	CR HDL 8289 V
	889,00	22,22		

Series HDL - Inch sizes

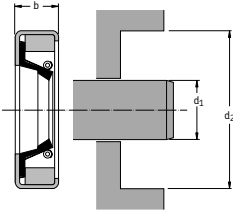

Dimensions shaft	bore	seal width	SKF Designation	Lip material	V
d_1	d_2	b	R		
in (mm)					
33.000	34.500	0.750	CR HDL 4381 R		CR HDL 4381 V
838,20	876,30	19,05			
	34.625	0.750	CR HDL 6787 R		CR HDL 6787 V
	879,47	19,05			
	34.650	0.787	CR HDL 4634 R		CR HDL 4634 V
	880,10	20,00			
	34.687	0.750	CR HDL 6152 R		CR HDL 6152 V
	881,04	19,05			
	35.000	0.875	CR HDL 4382 R		CR HDL 4382 V
	889,00	22,22			
	35.250	0.875	CR HDL 4326 R		CR HDL 4326 V
	895,35	22,22			
	35.500	0.875	CR HDL 4544 R		CR HDL 4544 V
	901,70	22,22			
33.500	35.000	0.875	CR HDL 9504 R		CR HDL 9504 V
850,90	889,00	22,22			
	35.500	0.875	CR HDL 4389 R		CR HDL 4389 V
	901,70	22,22			
	35.625	0.875	CR HDL 4548 R		CR HDL 4548 V
	904,87	22,22			
	35.625	0.875	CR HDL 4327 R		CR HDL 4327 V
	904,87	22,22			
	35.750	0.875	CR HDL 4549 R		CR HDL 4549 V
	908,05	22,22			
	36.000	0.875	CR HDL 4550 R		CR HDL 4550 V
	914,40	22,22			
	36.417	0.875	CR HDL 4552 R		CR HDL 4552 V
	924,99	22,22			
33.625	35.625	0.875	CR HDL 4328 R		CR HDL 4328 V
854,07	904,87	22,22			
34.000	35.625	0.875	CR HDL 4331 R		CR HDL 4331 V
863,60	904,87	22,22			
	36.000	0.875	CR HDL 4399 R		CR HDL 4399 V
	914,40	22,22			
	36.500	0.875	CR HDL 4400 R		CR HDL 4400 V
	927,10	22,22			
	37.000	0.875	CR HDL 4332 R		CR HDL 4332 V
	939,80	22,22			

Series HDL – Inch sizes

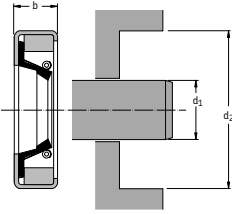

Dimensions shaft d ₁	bore d ₂	seal width b	SKF Designation Lip material R	V
in (mm)				
34.250	36.000	0.750	CR HDL 3017 R	CR HDL 3017 V
869,95	914,40	19,05		
	36.250	0.875	CR HDL 4401 R	CR HDL 4401 V
	920,75	22,22		
	36.750	0.875	CR HDL 4335 R	CR HDL 4335 V
	933,45	22,22		
	37.500	0.875	CR HDL 4338 R	CR HDL 4338 V
	952,50	22,22		
34.500	36.000	0.750	CR HDL 6908 R	CR HDL 6908 V
876,30	914,40	19,05		
	36.500	0.875	CR HDL 4405 R	CR HDL 4405 V
	927,10	22,22		
	36.500	1.000	CR HDL 3021 R	CR HDL 3021 V
	927,10	25,40		
	37.500	0.875	CR HDL 4338 R	CR HDL 4338 V
	952,50	22,22		
34.750	36.750	0.875	CR HDL 3831 R	CR HDL 3831 V
882,65	933,45	22,22		
	37.000	0.875	CR HDL 3835 R	CR HDL 3835 V
889,00	939,80	22,22		
	37.500	0.875	CR HDL 3836 R	CR HDL 3836 V
	952,50	22,22		
	38.000	0.875	CR HDL 3837 R	CR HDL 3837 V
	965,20	22,22		
35.250	37.250	0.875	CR HDL 4416 R	CR HDL 4416 V
895,35	946,15	22,22		
	38.250	0.812	CR HDL 4647 R	CR HDL 4647 V
	971,55	20,62		
35.375	37.375	0.875	CR HDL 4417 R	CR HDL 4417 V
898,52	949,32	22,22		
35.437	38.583	0.875	CR HDL 9079 R	CR HDL 9079 V
900,09	980,00	22,22		
35.496	37.996	0.984	CR HDL 3001 R	CR HDL 3001 V
901,60	965,10	25,00		
35.500	37.500	0.875	CR HDL 4553 R	CR HDL 4553 V
901,70	952,50	22,22		
35.827	38.077	0.687	CR HDL 3003 R	CR HDL 3003 V
910,00	967,15	17,45		

Series HDL - Inch sizes

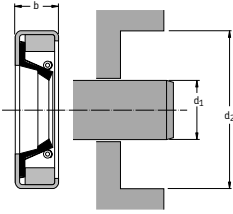

Dimensions shaft d ₁	bore d ₂	seal width b	SKF Designation Lip material R	V
in (mm)				
36.000	38.000	0.875	CR HDL 4421 R	CR HDL 4421 V
<i>914,40</i>	<i>965,20</i>	<i>22,22</i>		
	38.500	1.000	CR HDL 9993 R	CR HDL 9993 V
	<i>977,90</i>	<i>25,40</i>		
36.500	38.000	0.750	CR HDL 4429 R	CR HDL 4429 V
<i>927,10</i>	<i>965,20</i>	<i>19,05</i>		
	38.500	0.875	CR HDL 4430 R	CR HDL 4430 V
	<i>977,90</i>	<i>22,22</i>		
36.750	38.750	0.875	CR HDL 4432 R	CR HDL 4432 V
<i>933,45</i>	<i>984,25</i>	<i>22,22</i>		
	39.250	0.875	CR HDL 7428 R	CR HDL 7428 V
	<i>996,95</i>	<i>22,22</i>		
37.000	39.000	0.875	CR HDL 4434 R	CR HDL 4434 V
<i>939,80</i>	<i>990,60</i>	<i>22,22</i>		
37.250	39.250	0.875	CR HDL 4436 R	CR HDL 4436 V
<i>946,15</i>	<i>996,95</i>	<i>22,22</i>		
37.374	39.500	0.875	CR HDL 4425 R	CR HDL 4425 V
<i>949,30</i>	<i>1 003,30</i>	<i>22,22</i>		
37.437	39.500	0.875	CR HDL 3847 R	CR HDL 3847 V
<i>950,89</i>	<i>1 003,30</i>	<i>22,22</i>		
37.500	39.000	0.750	CR HDL 9411 R	CR HDL 9411 V
<i>952,50</i>	<i>990,60</i>	<i>19,05</i>		
	39.500	0.875	CR HDL 4438 R	CR HDL 4438 V
	<i>1 003,30</i>	<i>22,22</i>		
38.000	39.500	0.750	CR HDL 3004 R	CR HDL 3004 V
<i>965,20</i>	<i>1 003,30</i>	<i>19,05</i>		
	40.000	0.875	CR HDL 4448 R	CR HDL 4448 V
	<i>1 016,00</i>	<i>22,22</i>		
	41.000	0.875	CR HDL 4340 R	CR HDL 4340 V
	<i>1 041,40</i>	<i>22,22</i>		
38.250	40.250	0.875	CR HDL 4454 R	CR HDL 4454 V
<i>971,55</i>	<i>1 022,35</i>	<i>22,22</i>		
	40.750	0.875	CR HDL 4567 R	CR HDL 4567 V
	<i>1 035,05</i>	<i>22,22</i>		
	41.250	0.875	CR HDL 4569 R	CR HDL 4569 V
	<i>1 047,75</i>	<i>22,22</i>		

Series HDL – Inch sizes

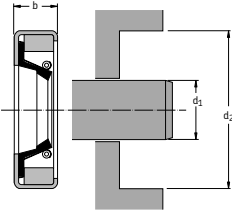

Dimensions shaft d ₁	bore d ₂	seal width b	SKF Designation Lip material R	V
in (mm)				
38.258 971,75	40.750 1 035,05	0.875 22,22	CR HDL 4342 R	CR HDL 4342 V
38.500 977,90	41.000 1 041,40	0.875 22,22	CR HDL 4349 R	CR HDL 4349 V
38.750 984,25	40.750 1 035,05	0.875 22,22	CR HDL 4456 R	CR HDL 4456 V
	41.000 1 041,40	0.875 22,22	CR HDL 4570 R	CR HDL 4570 V
38.937 988,99	41.000 1 041,40	0.875 22,22	CR HDL 4462 R	CR HDL 4462 V
39.000 990,60	41.000 1 041,40	0.875 22,22	CR HDL 4465 R	CR HDL 4465 V
	41.500 1 054,10	0.875 22,22	CR HDL 4350 R	CR HDL 4350 V
	42.250 1 073,15	0.875 22,22	CR HDL 4577 R	CR HDL 4577 V
39.750 1 009,65	42.250 1 073,15	0.875 22,22	CR HDL 7538 R	CR HDL 7538 V
40.000 1 016,00	42.000 1 066,80	0.875 22,22	CR HDL 4467 R	CR HDL 4467 V
	42.500 1 079,50	0.875 22,22	CR HDL 8791 R	CR HDL 8791 V
	42.500 1 079,50	1.000 25,40	CR HDL 8599 R	CR HDL 8599 V
40.500 1 028,70	42.500 1 079,50	0.875 22,22	CR HDL 4468 R	CR HDL 4468 V
	43.000 1 092,20	0.875 22,22	CR HDL 7300 R	CR HDL 7300 V
	43.020 1 092,70	0.875 22,22	CR HDL 1964 R	CR HDL 1964 V
41.500 1 054,10	43.500 1 104,90	0.875 22,22	CR HDL 4635 R	CR HDL 4635 V
41.875 1 063,62	43.500 1 104,90	1.000 25,40	CR HDL 8628 R	CR HDL 8628 V
42.248 1 073,10	44.248 1 123,90	1.000 25,40	CR HDL 4470 R	CR HDL 4470 V

Series HDL - Inch sizes

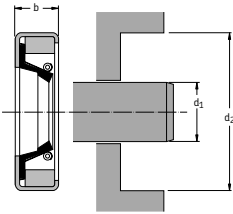

Dimensions shaft	bore	seal width	SKF Designation	Lip material	V
d_1	d_2	b	R		
in (mm)					
42.500	44.250	0.875	CR HDL 5555 R		CR HDL 5555 V
1 079,50	1 123,95	22,22			
	45.000	0.875	CR HDL 4473 R		CR HDL 4473 V
	1 143,00	22,22			
	45.500	0.875	CR HDL 6269 R		CR HDL 6269 V
	1 155,70	22,22			
43.000	45.500	0.875	CR HDL 7189 R		CR HDL 7189 V
1 092,20	1 155,70	22,22			
	45.500	1.000	CR HDL 9994 R		CR HDL 9994 V
	1 155,70	25,40			
43.500	45.500	0.875	CR HDL 4637 R		CR HDL 4637 V
1 104,90	1 155,70	22,22			
43.750	45.750	0.875	CR HDL 4638 R		CR HDL 4638 V
1 111,25	1 162,05	22,22			
44.000	46.000	0.875	CR HDL 7087 R		CR HDL 7087 V
1 117,60	1 168,40	22,22			
	46.500	0.875	CR HDL 4475 R		CR HDL 4475 V
	1 181,10	22,22			
	46.500	1.000	CR HDL 3024 R		CR HDL 3024 V
	1 181,10	25,40			
44.500	46.000	0.750	CR HDL 4563 R		CR HDL 4563 V
1 130,30	1 168,40	19,05			
	46.625	1.000	CR HDL 8903 R		CR HDL 8903 V
	1 184,27	25,40			
46.004	47.500	0.750	CR HDL 3006 R		CR HDL 3006 V
1 168,50	1 206,50	19,05			
46.500	48.500	0.875	CR HDL 4578 R		CR HDL 4578 V
1 181,10	1 231,90	22,22			
46.850	48.819	0.875	CR HDL 8317 R		CR HDL 8317 V
1 189,99	1 240,00	22,22			
48.000	50.000	0.875	CR HDL 8579 R		CR HDL 8579 V
1 219,20	1 270,00	22,22			
48.250	50.250	0.875	CR HDL 4639 R		CR HDL 4639 V
1 225,55	1 276,35	22,22			
51.248	53.289	0.875	CR HDL 6747 R		CR HDL 6747 V
1 301,71	1 353,55	22,22			
51.250	53.300	0.875	CR HDL 1914 R		CR HDL 1914 V
1 301,75	1 353,82	22,22			

Series SBF – Metric sizes

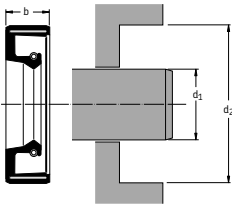

Dimensions			SKF Designation	
shaft	bore	seal width	Lip material	
d_1	d_2	b	R	V
in (mm)				
175	205	15	CR 175×205×15 SBF R	CR 175×205×15 SBF V
230	260	15	CR 230×260×15 SBF R	CR 230×260×15 SBF V
240	270	15	CR 240×270×15 SBF R	CR 240×270×15 SBF V
	280	16	CR 240×280×16 SBF R	CR 240×280×16 SBF V
245	275	16	CR 245×275×16 SBF R	CR 245×275×16 SBF V
260	290	16	CR 260×290×16 SBF R	CR 260×290×16 SBF V
	310	16	CR 260×310×16 SBF R	CR 260×310×16 SBF V
270	235	16	CR 270×235×16 SBF R	CR 270×235×16 SBF V
290	330	18	CR 290×330×18 SBF R	CR 290×330×18 SBF V
	334	20	CR 290×334×20 SBF R	CR 290×334×20 SBF V
300	344	20	CR 300×344×20 SBF R	CR 300×344×20 SBF V
316	360	20	CR 316×360×20 SBF R	CR 316×360×20 SBF V
325	365	16	CR 325×365×16 SBF R	CR 325×365×16 SBF V
340	380	20	CR 340×380×20 SBF R	CR 340×380×20 SBF V
360	400	20	CR 360×400×20 SBF R	CR 360×400×20 SBF V
385	430	25	CR 385×430×25 SBF R	CR 385×430×25 SBF V
390	430	20	CR 390×430×20 SBF R	CR 390×430×20 SBF V
400	440	20	CR 400×440×20 SBF R	CR 400×440×20 SBF V
430	480	22	CR 430×480×22 SBF R	CR 430×480×22 SBF V
440	490	25	CR 440×490×25 SBF R	CR 440×490×25 SBF V
450	500	25	CR 450×500×25 SBF R	CR 450×500×25 SBF V
900	960	27	CR 900×960×27 SBF R	CR 900×960×27 SBF V

Series SBF – Inch sizes

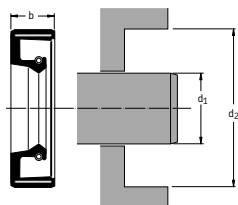

Dimensions			SKF Designation	
shaft	bore	seal width	Lip material	
d_1	d_2	b	R	V
in (mm)				
11.000	12.500	0.625	CR SBF 5809 R	CR SBF 5809 V
279,4	317,5	15,88		
20.500	22.500	0.875	CR SBF 7083 R	CR SBF 7083 V
520,7	571,5	22,23		
21.500	23.469	0.875	CR SBF 7175 R	CR SBF 7175 V
546,1	596,11	22,23		
23.000	24.500	0.750	CR SBF 7270 R	CR SBF 7270 V
584,2	622,3	19,05		
27.500	29.500	1.000	CR SBF 7406 R	CR SBF 7406 V
698,5	749,3	25,4		

Series HSF1 (split), HSF5 (solid) – Metric sizes

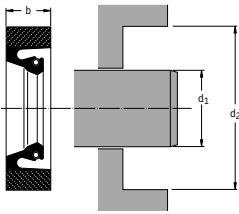

Dimensions			SKF Designation	Lip material R	Lip material V
shaft	bore	seal width	Lip material R	Lip material R	Lip material V
d ₁	d ₂	b	Lip material V		
mm					
40	60	10	CR 40×60×10 HSF1 R CR 40×60×10 HSF1 V	CR 40×60×10 HSF5 R CR 40×60×10 HSF5 V	
55	80	12,2	CR 55×80×12.2 HSF1 R CR 55×80×12.2 HSF1 V	CR 55×80×12.2 HSF5 R CR 55×80×12.2 HSF5 V	
60	80	10	CR 60×80×10 HSF1 R CR 60×80×10 HSF1 V	CR 60×80×10 HSF5 R CR 60×80×10 HSF5 V	
70	102	12,5	CR 70×102×12.5 HSF1 R CR 70×102×12.5 HSF1 V	CR 70×102×12.5 HSF5 R CR 70×102×12.5 HSF5 V	
80	100	8	CR 80×100×8 HSF1 R CR 80×100×8 HSF1 V	CR 80×100×8 HSF5 R CR 80×100×8 HSF5 V	
	100	10	CR 80×100×10 HSF1 R CR 80×100×10 HSF1 V	CR 80×100×10 HSF5 R CR 80×100×10 HSF5 V	
	112	12,5	CR 80×112×12.5 HSF1 R CR 80×112×12.5 HSF1 V	CR 80×112×12.5 HSF5 R CR 80×112×12.5 HSF5 V	
	100	8	CR 84×100×8 HSF1 R CR 84×100×8 HSF1 V	CR 84×100×8 HSF5 R CR 84×100×8 HSF5 V	
85	101	8	CR 85×101×8 HSF1 R CR 85×101×8 HSF1 V	CR 85×101×8 HSF5 R CR 85×101×8 HSF5 V	
	109	12	CR 85×109×12 HSF1 R CR 85×109×12 HSF1 V	CR 85×109×12 HSF5 R CR 85×109×12 HSF5 V	
	120	12	CR 85×120×12 HSF1 R CR 85×120×12 HSF1 V	CR 85×120×12 HSF5 R CR 85×120×12 HSF5 V	
90	110	12	CR 90×110×12 HSF1 R CR 90×110×12 HSF1 V	CR 90×110×12 HSF5 R CR 90×110×12 HSF5 V	
	122	12,5	CR 90×122×12.5 HSF1 R CR 90×122×12.5 HSF1 V	CR 90×122×12.5 HSF5 R CR 90×122×12.5 HSF5 V	
	116	8	CR 100×116×8 HSF1 R CR 100×116×8 HSF1 V	CR 100×116×8 HSF5 R CR 100×116×8 HSF5 V	
100	125	10	CR 100×125×10 HSF1 R CR 100×125×10 HSF1 V	CR 100×125×10 HSF5 R CR 100×125×10 HSF5 V	
	130	10	CR 100×130×10 HSF1 R CR 100×130×10 HSF1 V	CR 100×130×10 HSF5 R CR 100×130×10 HSF5 V	
	130	12	CR 110×130×12 HSF1 R CR 110×130×12 HSF1 V	CR 110×130×12 HSF5 R CR 110×130×12 HSF5 V	
110	140	13	CR 110×140×13 HSF1 R CR 110×140×13 HSF1 V	CR 110×140×13 HSF5 R CR 110×140×13 HSF5 V	

Series HSF1 (split), HSF5 (solid) – Metric sizes

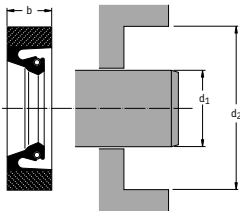

Dimensions			SKF Designation	
shaft	bore	seal width	Lip material R	Lip material V
d ₁	d ₂	b	Lip material R	Lip material V
mm				
120	150	13	CR 120×150×13 HSF1 R CR 120×150×13 HSF1 V	CR 120×150×13 HSF5 R CR 120×150×13 HSF5 V
	160	16	CR 120×160×16 HSF1 R CR 120×160×16 HSF1 V	CR 120×160×16 HSF5 R CR 120×160×16 HSF5 V
125	155	12,5	CR 125×155×12.5 HSF1 R CR 125×155×12.5 HSF1 V	CR 125×155×12.5 HSF5 R CR 125×155×12.5 HSF5 V
		12,5	CR 125×157×12.5 HSF1 R CR 125×157×12.5 HSF1 V	CR 125×157×12.5 HSF5 R CR 125×157×12.5 HSF5 V
	160	12	CR 125×160×12 HSF1 R CR 125×160×12 HSF1 V	CR 125×160×12 HSF5 R CR 125×160×12 HSF5 V
		11,11	CR 127×146.05×11.11 HSF1 R CR 127×146.05×11.11 HSF1 V	CR 127×146.05×11.11 HSF5 R CR 127×146.05×11.11 HSF5 V
135	160	12	CR 135×160×12 HSF1 R CR 135×160×12 HSF1 V	CR 135×160×12 HSF5 R CR 135×160×12 HSF5 V
	170	16,5	CR 135×170×16.5 HSF1 R CR 135×170×16.5 HSF1 V	CR 135×170×16.5 HSF5 R CR 135×170×16.5 HSF5 V
140	170	12	CR 140×170×12 HSF1 R CR 140×170×12 HSF1 V	CR 140×170×12 HSF5 R CR 140×170×12 HSF5 V
	170	15	CR 140×170×15 HSF1 R CR 140×170×15 HSF1 V	CR 140×170×15 HSF5 R CR 140×170×15 HSF5 V
145	180	14	CR 145×180×14 HSF1 R CR 145×180×14 HSF1 V	CR 145×180×14 HSF5 R CR 145×180×14 HSF5 V
		12	CR 150×180×12 HSF1 R CR 150×180×12 HSF1 V	CR 150×180×12 HSF5 R CR 150×180×12 HSF5 V
160	190	15	CR 160×190×15 HSF1 R CR 160×190×15 HSF1 V	CR 160×190×15 HSF5 R CR 160×190×15 HSF5 V
	190	16,5	CR 160×190×16.5 HSF1 R CR 160×190×16.5 HSF1 V	CR 160×190×16.5 HSF5 R CR 160×190×16.5 HSF5 V
		10	CR 160×200×10 HSF1 R CR 160×200×10 HSF1 V	CR 160×200×10 HSF5 R CR 160×200×10 HSF5 V
	200	16	CR 160×200×16 HSF1 R CR 160×200×16 HSF1 V	CR 160×200×16 HSF5 R CR 160×200×16 HSF5 V
170		12	CR 170×200×12 HSF1 R CR 170×200×12 HSF1 V	CR 170×200×12 HSF5 R CR 170×200×12 HSF5 V

Series HSF1 (split), HSF5 (solid) – Metric sizes

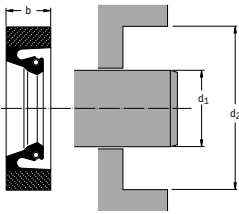

Dimensions			SKF Designation	
shaft	bore	seal width	Lip material R	Lip material V
d ₁	d ₂	b	Lip material R	Lip material V
mm				
170	200	16	CR 170×200×16 HSF1 R CR 170×200×16 HSF1 V	CR 170×200×16 HSF5 R CR 170×200×16 HSF5 V
	210	16	CR 170×210×16 HSF1 R CR 170×210×16 HSF1 V	CR 170×210×16 HSF5 R CR 170×210×16 HSF5 V
	211	16	CR 170×211×16 HSF1 R CR 170×211×16 HSF1 V	CR 170×211×16 HSF5 R CR 170×211×16 HSF5 V
175	200	15	CR 175×200×15 HSF1 R CR 175×200×15 HSF1 V	CR 175×200×15 HSF5 R CR 175×200×15 HSF5 V
180	200	15	CR 180×200×15 HSF1 R CR 180×200×15 HSF1 V	CR 180×200×15 HSF5 R CR 180×200×15 HSF5 V
	210	15	CR 180×210×15 HSF1 R CR 180×210×15 HSF1 V	CR 180×210×15 HSF5 R CR 180×210×15 HSF5 V
	222	16	CR 180×222×16 HSF1 R CR 180×222×16 HSF1 V	CR 180×222×16 HSF5 R CR 180×222×16 HSF5 V
185	225	16	CR 185×225×16 HSF1 R CR 185×225×16 HSF1 V	CR 185×225×16 HSF5 R CR 185×225×16 HSF5 V
190	150	16	CR 190×150×16 HSF1 R CR 190×150×16 HSF1 V	CR 190×150×16 HSF5 R CR 190×150×16 HSF5 V
	220	15	CR 190×220×15 HSF1 R CR 190×220×15 HSF1 V	CR 190×220×15 HSF5 R CR 190×220×15 HSF5 V
	225	18	CR 190×225×18 HSF1 R CR 190×225×18 HSF1 V	CR 190×225×18 HSF5 R CR 190×225×18 HSF5 V
	230	10	CR 190×230×10 HSF1 R CR 190×230×10 HSF1 V	CR 190×230×10 HSF5 R CR 190×230×10 HSF5 V
	230	16	CR 190×230×16 HSF1 R CR 190×230×16 HSF1 V	CR 190×230×16 HSF5 R CR 190×230×16 HSF5 V
200	240	16	CR 200×240×16 HSF1 R CR 200×240×16 HSF1 V	CR 200×240×16 HSF5 R CR 200×240×16 HSF5 V
	250	18	CR 200×250×18 HSF1 R CR 200×250×18 HSF1 V	CR 200×250×18 HSF5 R CR 200×250×18 HSF5 V
210	240	12	CR 210×240×12 HSF1 R CR 210×240×12 HSF1 V	CR 210×240×12 HSF5 R CR 210×240×12 HSF5 V
	245	18,2	CR 210×245×18.2 HSF1 R CR 210×245×18.2 HSF1 V	CR 210×245×18.2 HSF5 R CR 210×245×18.2 HSF5 V
	250	16	CR 210×250×16 HSF1 R CR 210×250×16 HSF1 V	CR 210×250×16 HSF5 R CR 210×250×16 HSF5 V

Series HSF1 (split), HSF5 (solid) – Metric sizes

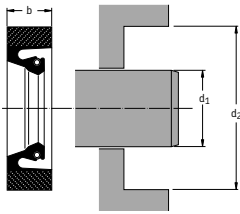

Dimensions			SKF Designation	
shaft	bore	seal width	Lip material R	Lip material R
d_1	d_2	b	Lip material V	Lip material V
mm				
215	248	15	CR 215×248×15 HSF1 R	CR 215×248×15 HSF5 R
			CR 215×248×15 HSF1 V	CR 215×248×15 HSF5 V
	250	16	CR 215×250×16 HSF1 R	CR 215×250×16 HSF5 R
			CR 215×250×16 HSF1 V	CR 215×250×16 HSF5 V
220	180	16	CR 220×180×16 HSF1 R	CR 220×180×16 HSF5 R
			CR 220×180×16 HSF1 V	CR 220×180×16 HSF5 V
	255	18	CR 220×255×18 HSF1 R	CR 220×255×18 HSF5 R
			CR 220×255×18 HSF1 V	CR 220×255×18 HSF5 V
	260	16	CR 220×260×16 HSF1 R	CR 220×260×16 HSF5 R
			CR 220×260×16 HSF1 V	CR 220×260×16 HSF5 V
	260	16,5	CR 220×260×16.5 HSF1 R	CR 220×260×16.5 HSF5 R
			CR 220×260×16.5 HSF1 V	CR 220×260×16.5 HSF5 V
226	276	22,22	CR 226×276×22.22 HSF1 R	CR 226×276×22.22 HSF5 R
			CR 226×276×22.22 HSF1 V	CR 226×276×22.22 HSF5 V
230	260	15	CR 230×260×15 HSF1 R	CR 230×260×15 HSF5 R
			CR 230×260×15 HSF1 V	CR 230×260×15 HSF5 V
	265	18	CR 230×265×18 HSF1 R	CR 230×265×18 HSF5 R
			CR 230×265×18 HSF1 V	CR 230×265×18 HSF5 V
	270	16	CR 230×270×16 HSF1 R	CR 230×270×16 HSF5 R
		CR 230×270×16 HSF1 V	CR 230×270×16 HSF5 V	
235	265	15	CR 235×265×15 HSF1 R	CR 235×265×15 HSF5 R
			CR 235×265×15 HSF1 V	CR 235×265×15 HSF5 V
	275	20	CR 235×275×20 HSF1 R	CR 235×275×20 HSF5 R
			CR 235×275×20 HSF1 V	CR 235×275×20 HSF5 V
236	276	16	CR 236×276×16 HSF1 R	CR 236×276×16 HSF5 R
			CR 236×276×16 HSF1 V	CR 236×276×16 HSF5 V
240	275	18	CR 240×275×18 HSF1 R	CR 240×275×18 HSF5 R
			CR 240×275×18 HSF1 V	CR 240×275×18 HSF5 V
	280	16	CR 240×280×16 HSF1 R	CR 240×280×16 HSF5 R
			CR 240×280×16 HSF1 V	CR 240×280×16 HSF5 V
	280	18	CR 240×280×18 HSF1 R	CR 240×280×18 HSF5 R
			CR 240×280×18 HSF1 V	CR 240×280×18 HSF5 V
	290	16	CR 240×290×16 HSF1 R	CR 240×290×16 HSF5 R
			CR 240×290×16 HSF1 V	CR 240×290×16 HSF5 V
	290	25	CR 240×290×25 HSF1 R	CR 240×290×25 HSF5 R
		CR 240×290×25 HSF1 V	CR 240×290×25 HSF5 V	

Series HSF1 (split), HSF5 (solid) – Metric sizes

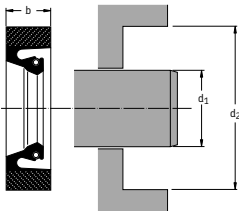

Dimensions			SKF Designation	Lip material R	Lip material V
shaft	bore	seal width	Lip material R	Lip material R	Lip material V
d ₁	d ₂	b	Lip material V		
mm					
250	280	15	CR 250×280×15 HSF1 R	CR 250×280×15 HSF5 R	CR 250×280×15 HSF5 V
			CR 250×280×15 HSF1 V	CR 250×280×15 HSF5 R	CR 250×280×15 HSF5 V
	285	18	CR 250×285×18 HSF1 R	CR 250×285×18 HSF5 R	CR 250×285×18 HSF5 V
			CR 250×285×18 HSF1 V	CR 250×285×18 HSF5 R	CR 250×285×18 HSF5 V
	290	16,5	CR 250×290×16.5 HSF1 R	CR 250×290×16.5 HSF5 R	CR 250×290×16.5 HSF5 V
			CR 250×290×16.5 HSF1 V	CR 250×290×16.5 HSF5 R	CR 250×290×16.5 HSF5 V
260	290	18	CR 250×290×18 HSF1 R	CR 250×290×18 HSF5 R	CR 250×290×18 HSF5 V
			CR 250×290×18 HSF1 V	CR 250×290×18 HSF5 R	CR 250×290×18 HSF5 V
	300	16	CR 260×290×16 HSF1 R	CR 260×290×16 HSF5 R	CR 260×290×16 HSF5 V
			CR 260×290×16 HSF1 V	CR 260×290×16 HSF5 R	CR 260×290×16 HSF5 V
	304	18	CR 260×300×18 HSF1 R	CR 260×300×18 HSF5 R	CR 260×300×18 HSF5 V
			CR 260×300×18 HSF1 V	CR 260×300×18 HSF5 R	CR 260×300×18 HSF5 V
270	304	20	CR 260×304×20 HSF1 R	CR 260×304×20 HSF5 R	CR 260×304×20 HSF5 V
			CR 260×304×20 HSF1 V	CR 260×304×20 HSF5 R	CR 260×304×20 HSF5 V
	310	15	CR 270×310×15 HSF1 R	CR 270×310×15 HSF5 R	CR 270×310×15 HSF5 V
			CR 270×310×15 HSF1 V	CR 270×310×15 HSF5 R	CR 270×310×15 HSF5 V
275	314	20	CR 270×314×20 HSF1 R	CR 270×314×20 HSF5 R	CR 270×314×20 HSF5 V
			CR 270×314×20 HSF1 V	CR 270×314×20 HSF5 R	CR 270×314×20 HSF5 V
	315	20	CR 275×315×20 HSF1 R	CR 275×315×20 HSF5 R	CR 275×315×20 HSF5 V
		CR 275×315×20 HSF1 V	CR 275×315×20 HSF5 R	CR 275×315×20 HSF5 V	
280	320	16	CR 280×320×16 HSF1 R	CR 280×320×16 HSF5 R	CR 280×320×16 HSF5 V
			CR 280×320×16 HSF1 V	CR 280×320×16 HSF5 R	CR 280×320×16 HSF5 V
	320	18	CR 280×320×18 HSF1 R	CR 280×320×18 HSF5 R	CR 280×320×18 HSF5 V
			CR 280×320×18 HSF1 V	CR 280×320×18 HSF5 R	CR 280×320×18 HSF5 V
	320	20	CR 280×320×20 HSF1 R	CR 280×320×20 HSF5 R	CR 280×320×20 HSF5 V
			CR 280×320×20 HSF1 V	CR 280×320×20 HSF5 R	CR 280×320×20 HSF5 V
	320	24	CR 280×320×24 HSF1 R	CR 280×320×24 HSF5 R	CR 280×320×24 HSF5 V
			CR 280×320×24 HSF1 V	CR 280×320×24 HSF5 R	CR 280×320×24 HSF5 V
	324	20	CR 280×324×20 HSF1 R	CR 280×324×20 HSF5 R	CR 280×324×20 HSF5 V
			CR 280×324×20 HSF1 V	CR 280×324×20 HSF5 R	CR 280×324×20 HSF5 V
285	350	16	CR 280×350×16 HSF1 R	CR 280×350×16 HSF5 R	CR 280×350×16 HSF5 V
			CR 280×350×16 HSF1 V	CR 280×350×16 HSF5 R	CR 280×350×16 HSF5 V
	310	15	CR 285×310×15 HSF1 R	CR 285×310×15 HSF5 R	CR 285×310×15 HSF5 V
		CR 285×310×15 HSF1 V	CR 285×310×15 HSF5 R	CR 285×310×15 HSF5 V	
289	327	19	CR 289×327×19 HSF1 R	CR 289×327×19 HSF5 R	CR 289×327×19 HSF5 V
			CR 289×327×19 HSF1 V	CR 289×327×19 HSF5 R	CR 289×327×19 HSF5 V

Series HSF1 (split), HSF5 (solid) – Metric sizes

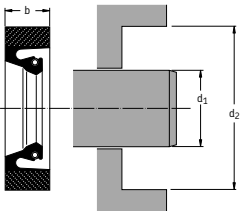

Dimensions			SKF Designation		
shaft	bore	seal width	Lip material R	Lip material V	
d_1	d_2	b	Lip material R	Lip material V	
mm					
290	330	20	CR 290×330×20 HSF1 R	CR 290×330×20 HSF5 R	
			CR 290×330×20 HSF1 V	CR 290×330×20 HSF5 V	
	330	20,3	CR 290×330×20.3 HSF1 R	CR 290×330×20.3 HSF5 R	
			CR 290×330×20.3 HSF1 V	CR 290×330×20.3 HSF5 V	
	334	20	CR 290×334×20 HSF1 R	CR 290×334×20 HSF5 R	
			CR 290×334×20 HSF1 V	CR 290×334×20 HSF5 V	
	330	15,87	CR 292×330×15.87 HSF1 R	CR 292×330×15.87 HSF5 R	
			CR 292×330×15.87 HSF1 V	CR 292×330×15.87 HSF5 V	
300	340	16,5	CR 300×340×16.5 HSF1 R	CR 300×340×16.5 HSF5 R	
			CR 300×340×16.5 HSF1 V	CR 300×340×16.5 HSF5 V	
	340	18	CR 300×340×18 HSF1 R	CR 300×340×18 HSF5 R	
			CR 300×340×18 HSF1 V	CR 300×340×18 HSF5 V	
	340	20	CR 300×340×20 HSF1 R	CR 300×340×20 HSF5 R	
			CR 300×340×20 HSF1 V	CR 300×340×20 HSF5 V	
	344	20	CR 300×344×20 HSF1 R	CR 300×344×20 HSF5 R	
			CR 300×344×20 HSF1 V	CR 300×344×20 HSF5 V	
	304	348	20	CR 304×348×20 HSF1 R	CR 304×348×20 HSF5 R
			CR 304×348×20 HSF1 V	CR 304×348×20 HSF5 V	
308	352	20	CR 308×352×20 HSF1 R	CR 308×352×20 HSF5 R	
			CR 308×352×20 HSF1 V	CR 308×352×20 HSF5 V	
310	345	18	CR 310×345×18 HSF1 R	CR 310×345×18 HSF5 R	
			CR 310×345×18 HSF1 V	CR 310×345×18 HSF5 V	
	354	20	CR 310×354×20 HSF1 R	CR 310×354×20 HSF5 R	
			CR 310×354×20 HSF1 V	CR 310×354×20 HSF5 V	
	354	20,5	CR 310×354×20.5 HSF1 R	CR 310×354×20.5 HSF5 R	
			CR 310×354×20.5 HSF1 V	CR 310×354×20.5 HSF5 V	
	360	22	CR 310×360×22 HSF1 R	CR 310×360×22 HSF5 R	
			CR 310×360×22 HSF1 V	CR 310×360×22 HSF5 V	
	311	345	18,3	CR 311×345×18.3 HSF1 R	CR 311×345×18.3 HSF5 R
			CR 311×345×18.3 HSF1 V	CR 311×345×18.3 HSF5 V	
314	355	20	CR 314×355×20 HSF1 R	CR 314×355×20 HSF5 R	
			CR 314×355×20 HSF1 V	CR 314×355×20 HSF5 V	
316	360	20	CR 316×360×20 HSF1 R	CR 316×360×20 HSF5 R	
			CR 316×360×20 HSF1 V	CR 316×360×20 HSF5 V	

Series HSF1 (split), HSF5 (solid) – Metric sizes

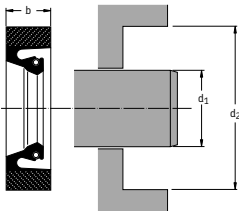

Dimensions			SKF Designation	
shaft	bore	seal width	Lip material R	Lip material V
d ₁	d ₂	b	Lip material R	Lip material V
mm				
320	350	15	CR 320×350×15 HSF1 R	CR 320×350×15 HSF5 R
			CR 320×350×15 HSF1 V	CR 320×350×15 HSF5 V
	350	15,4	CR 320×350×15.4 HSF1 R	CR 320×350×15.4 HSF5 R
			CR 320×350×15.4 HSF1 V	CR 320×350×15.4 HSF5 V
	360	18	CR 320×360×18 HSF1 R	CR 320×360×18 HSF5 R
			CR 320×360×18 HSF1 V	CR 320×360×18 HSF5 V
320	360	20	CR 320×360×20 HSF1 R	CR 320×360×20 HSF5 R
			CR 320×360×20 HSF1 V	CR 320×360×20 HSF5 V
			CR 320×360×20 HSF1 V	CR 320×360×20 HSF5 V
328	372	20,2	CR 328×372×20.2 HSF1 R	CR 328×372×20.2 HSF5 R
			CR 328×372×20.2 HSF1 V	CR 328×372×20.2 HSF5 V
330	370	18	CR 330×370×18 HSF1 R	CR 330×370×18 HSF5 R
			CR 330×370×18 HSF1 V	CR 330×370×18 HSF5 V
	370	20	CR 330×370×20 HSF1 R	CR 330×370×20 HSF5 R
			CR 330×370×20 HSF1 V	CR 330×370×20 HSF5 V
	374	20	CR 330×374×20 HSF1 R	CR 330×374×20 HSF5 R
			CR 330×374×20 HSF1 V	CR 330×374×20 HSF5 V
330	380,8	20,62	CR 330×380.8×20.62 HSF1 R	CR 330×380.8×20.62 HSF5 R
			CR 330×380.8×20.62 HSF1 V	CR 330×380.8×20.62 HSF5 V
335	373	19	CR 335×373×19 HSF1 R	CR 335×373×19 HSF5 R
			CR 335×373×19 HSF1 V	CR 335×373×19 HSF5 V
340	380	16	CR 340×380×16 HSF1 R	CR 340×380×16 HSF5 R
			CR 340×380×16 HSF1 V	CR 340×380×16 HSF5 V
	380	18	CR 340×380×18 HSF1 R	CR 340×380×18 HSF5 R
			CR 340×380×18 HSF1 V	CR 340×380×18 HSF5 V
	380	20	CR 340×380×20 HSF1 R	CR 340×380×20 HSF5 R
			CR 340×380×20 HSF1 V	CR 340×380×20 HSF5 V
340	384	20	CR 340×384×20 HSF1 R	CR 340×384×20 HSF5 R
			CR 340×384×20 HSF1 V	CR 340×384×20 HSF5 V
			CR 340×384×20 HSF1 V	CR 340×384×20 HSF5 V
			CR 340×384×20 HSF1 V	CR 340×384×20 HSF5 V
350	380	17,7	CR 350×380×17.7 HSF1 R	CR 350×380×17.7 HSF5 R
			CR 350×380×17.7 HSF1 V	CR 350×380×17.7 HSF5 V
	390	20	CR 350×390×20 HSF1 R	CR 350×390×20 HSF5 R
			CR 350×390×20 HSF1 V	CR 350×390×20 HSF5 V
350	394	20	CR 350×394×20 HSF1 R	CR 350×394×20 HSF5 R
			CR 350×394×20 HSF1 V	CR 350×394×20 HSF5 V
360	404	20	CR 360×404×20 HSF1 R	CR 360×404×20 HSF5 R
			CR 360×404×20 HSF1 V	CR 360×404×20 HSF5 V
	410	20	CR 360×410×20 HSF1 R	CR 360×410×20 HSF5 R
		CR 360×410×20 HSF1 V	CR 360×410×20 HSF5 V	

Series HSF1 (split), HSF5 (solid) – Metric sizes

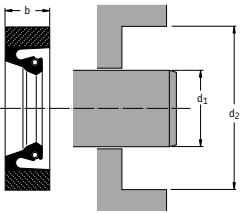

Dimensions			SKF Designation	
shaft	bore	seal width	Lip material R	Lip material V
d_1	d_2	b	Lip material R	Lip material V
mm				
362	400	20	CR 362×400×20 HSF1 R CR 362×400×20 HSF1 V	CR 362×400×20 HSF5 R CR 362×400×20 HSF5 V
	406	19,8	CR 362×406×19.8 HSF1 R CR 362×406×19.8 HSF1 V	CR 362×406×19.8 HSF5 R CR 362×406×19.8 HSF5 V
	406	22	CR 362×406×22 HSF1 R CR 362×406×22 HSF1 V	CR 362×406×22 HSF5 R CR 362×406×22 HSF5 V
370	410	20	CR 370×410×20 HSF1 R CR 370×410×20 HSF1 V	CR 370×410×20 HSF5 R CR 370×410×20 HSF5 V
	414	20	CR 370×414×20 HSF1 R CR 370×414×20 HSF1 V	CR 370×414×20 HSF5 R CR 370×414×20 HSF5 V
380	420	20	CR 380×420×20 HSF1 R CR 380×420×20 HSF1 V	CR 380×420×20 HSF5 R CR 380×420×20 HSF5 V
387	431	22,5	CR 387×431×22.5 HSF1 R CR 387×431×22.5 HSF1 V	CR 387×431×22.5 HSF5 R CR 387×431×22.5 HSF5 V
	438	25,4	CR 387×438×25.4 HSF1 R CR 387×438×25.4 HSF1 V	CR 387×438×25.4 HSF5 R CR 387×438×25.4 HSF5 V
390	430	20	CR 390×430×20 HSF1 R CR 390×430×20 HSF1 V	CR 390×430×20 HSF5 R CR 390×430×20 HSF5 V
395	439	20	CR 395×439×20 HSF1 R CR 395×439×20 HSF1 V	CR 395×439×20 HSF5 R CR 395×439×20 HSF5 V
	439	20,5	CR 395×439×20.5 HSF1 R CR 395×439×20.5 HSF1 V	CR 395×439×20.5 HSF5 R CR 395×439×20.5 HSF5 V
400	440	20	CR 400×440×20 HSF1 R CR 400×440×20 HSF1 V	CR 400×440×20 HSF5 R CR 400×440×20 HSF5 V
	444	20	CR 400×444×20 HSF1 R CR 400×444×20 HSF1 V	CR 400×444×20 HSF5 R CR 400×444×20 HSF5 V
	450	22	CR 400×450×22 HSF1 R CR 400×450×22 HSF1 V	CR 400×450×22 HSF5 R CR 400×450×22 HSF5 V
	420	25	CR 400×450×25 HSF1 R CR 400×450×25 HSF1 V	CR 400×450×25 HSF5 R CR 400×450×25 HSF5 V
420	460	20	CR 420×460×20 HSF1 R CR 420×460×20 HSF1 V	CR 420×460×20 HSF5 R CR 420×460×20 HSF5 V
	470	22	CR 420×470×22 HSF1 R CR 420×470×22 HSF1 V	CR 420×470×22 HSF5 R CR 420×470×22 HSF5 V
	470	25	CR 420×470×25 HSF1 R CR 420×470×25 HSF1 V	CR 420×470×25 HSF5 R CR 420×470×25 HSF5 V
	470	25	CR 420×470×25 HSF1 R CR 420×470×25 HSF1 V	CR 420×470×25 HSF5 R CR 420×470×25 HSF5 V

Series HSF1 (split), HSF5 (solid) – Metric sizes

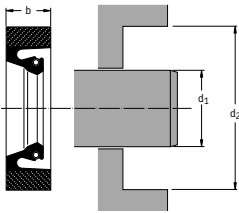

Dimensions			SKF Designation	Lip material R	Lip material V
shaft	bore	seal width	Lip material R	Lip material V	Lip material V
d ₁	d ₂	b	Lip material V		
mm					
430	480	25	CR 430×480×25 HSF1 R	CR 430×480×25 HSF5 R	CR 430×480×25 HSF5 V
			CR 430×480×25 HSF1 V	CR 430×480×25 HSF5 R	CR 430×480×25 HSF5 V
435	485	22	CR 435×485×22 HSF1 R	CR 435×485×22 HSF5 R	CR 435×485×22 HSF5 V
			CR 435×485×22 HSF1 V	CR 435×485×22 HSF5 R	CR 435×485×22 HSF5 V
438	476	24	CR 438×476×24 HSF1 R	CR 438×476×24 HSF5 R	CR 438×476×24 HSF5 V
			CR 438×476×24 HSF1 V	CR 438×476×24 HSF5 R	CR 438×476×24 HSF5 V
440	480	20	CR 440×480×20 HSF1 R	CR 440×480×20 HSF5 R	CR 440×480×20 HSF5 V
			CR 440×480×20 HSF1 V	CR 440×480×20 HSF5 R	CR 440×480×20 HSF5 V
	480	26	CR 440×480×26 HSF1 R	CR 440×480×26 HSF5 R	CR 440×480×26 HSF5 V
			CR 440×480×26 HSF1 V	CR 440×480×26 HSF5 R	CR 440×480×26 HSF5 V
	490	20	CR 440×490×20 HSF1 R	CR 440×490×20 HSF5 R	CR 440×490×20 HSF5 V
			CR 440×490×20 HSF1 V	CR 440×490×20 HSF5 R	CR 440×490×20 HSF5 V
490	25	CR 440×490×25 HSF1 R	CR 440×490×25 HSF5 R	CR 440×490×25 HSF5 V	
		CR 440×490×25 HSF1 V	CR 440×490×25 HSF5 R	CR 440×490×25 HSF5 V	
446	486	16,5	CR 446×486×16.5 HSF1 R	CR 446×486×16.5 HSF5 R	CR 446×486×16.5 HSF5 V
			CR 446×486×16.5 HSF1 V	CR 446×486×16.5 HSF5 R	CR 446×486×16.5 HSF5 V
450	490	18	CR 450×490×18 HSF1 R	CR 450×490×18 HSF5 R	CR 450×490×18 HSF5 V
			CR 450×490×18 HSF1 V	CR 450×490×18 HSF5 R	CR 450×490×18 HSF5 V
	500	20	CR 450×500×20 HSF1 R	CR 450×500×20 HSF5 R	CR 450×500×20 HSF5 V
			CR 450×500×20 HSF1 V	CR 450×500×20 HSF5 R	CR 450×500×20 HSF5 V
	500	22	CR 450×500×22 HSF1 R	CR 450×500×22 HSF5 R	CR 450×500×22 HSF5 V
			CR 450×500×22 HSF1 V	CR 450×500×22 HSF5 R	CR 450×500×22 HSF5 V
500	25	CR 450×500×25 HSF1 R	CR 450×500×25 HSF5 R	CR 450×500×25 HSF5 V	
		CR 450×500×25 HSF1 V	CR 450×500×25 HSF5 R	CR 450×500×25 HSF5 V	
460	510	22	CR 460×510×22 HSF1 R	CR 460×510×22 HSF5 R	CR 460×510×22 HSF5 V
			CR 460×510×22 HSF1 V	CR 460×510×22 HSF5 R	CR 460×510×22 HSF5 V
	510	25	CR 460×510×25 HSF1 R	CR 460×510×25 HSF5 R	CR 460×510×25 HSF5 V
CR 460×510×25 HSF1 V			CR 460×510×25 HSF5 R	CR 460×510×25 HSF5 V	
470	520	25	CR 470×520×25 HSF1 R	CR 470×520×25 HSF5 R	CR 470×520×25 HSF5 V
			CR 470×520×25 HSF1 V	CR 470×520×25 HSF5 R	CR 470×520×25 HSF5 V

Series HSF1 (split), HSF5 (solid) – Metric sizes

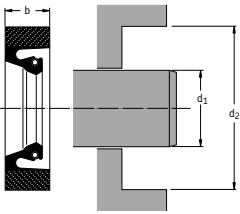

Dimensions			SKF Designation	
shaft	bore	seal width	Lip material R	Lip material R
d_1	d_2	b	Lip material V	Lip material V
mm				
480	520	18	CR 480×520×18 HSF1 R	CR 480×520×18 HSF5 R
			CR 480×520×18 HSF1 V	CR 480×520×18 HSF5 V
	520	20	CR 480×520×20 HSF1 R	CR 480×520×20 HSF5 R
			CR 480×520×20 HSF1 V	CR 480×520×20 HSF5 V
	530	22	CR 480×530×22 HSF1 R	CR 480×530×22 HSF5 R
			CR 480×530×22 HSF1 V	CR 480×530×22 HSF5 V
	530	25	CR 480×530×25 HSF1 R	CR 480×530×25 HSF5 R
			CR 480×530×25 HSF1 V	CR 480×530×25 HSF5 V
	550	25	CR 480×550×25 HSF1 R	CR 480×550×25 HSF5 R
			CR 480×550×25 HSF1 V	CR 480×550×25 HSF5 V
495	545	22	CR 495×545×22 HSF1 R	CR 495×545×22 HSF5 R
			CR 495×545×22 HSF1 V	CR 495×545×22 HSF5 V
500	540	10	CR 500×540×10 HSF1 R	CR 500×540×10 HSF5 R
			CR 500×540×10 HSF1 V	CR 500×540×10 HSF5 V
	540	20	CR 500×540×20 HSF1 R	CR 500×540×20 HSF5 R
			CR 500×540×20 HSF1 V	CR 500×540×20 HSF5 V
	550	20	CR 500×550×20 HSF1 R	CR 500×550×20 HSF5 R
			CR 500×550×20 HSF1 V	CR 500×550×20 HSF5 V
564	25	CR 500×564×25 HSF1 R	CR 500×564×25 HSF5 R	
		CR 500×564×25 HSF1 V	CR 500×564×25 HSF5 V	
520	560	18	CR 520×560×18 HSF1 R	CR 520×560×18 HSF5 R
			CR 520×560×18 HSF1 V	CR 520×560×18 HSF5 V
	560	20	CR 520×560×20 HSF1 R	CR 520×560×20 HSF5 R
CR 520×560×20 HSF1 V			CR 520×560×20 HSF5 V	
525	575	22	CR 525×575×22 HSF1 R	CR 525×575×22 HSF5 R
			CR 525×575×22 HSF1 V	CR 525×575×22 HSF5 V
530	580	22	CR 530×580×22 HSF1 R	CR 530×580×22 HSF5 R
			CR 530×580×22 HSF1 V	CR 530×580×22 HSF5 V
	580	22,3	CR 530×580×22.3 HSF1 R	CR 530×580×22.3 HSF5 R
			CR 530×580×22.3 HSF1 V	CR 530×580×22.3 HSF5 V
	580	25	CR 530×580×25 HSF1 R	CR 530×580×25 HSF5 R
			CR 530×580×25 HSF1 V	CR 530×580×25 HSF5 V
620	22	CR 530×620×22 HSF1 R	CR 530×620×22 HSF5 R	
		CR 530×620×22 HSF1 V	CR 530×620×22 HSF5 V	
535	585	22	CR 535×585×22 HSF1 R	CR 535×585×22 HSF5 R
			CR 535×585×22 HSF1 V	CR 535×585×22 HSF5 V

Series HSF1 (split), HSF5 (solid) – Metric sizes

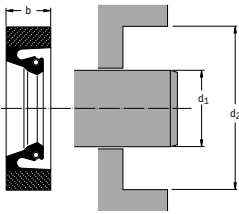

Dimensions			SKF Designation	
shaft	bore	seal width	Lip material R	Lip material R
d ₁	d ₂	b	Lip material V	Lip material V
mm				
540	590	22	CR 540×590×22 HSF1 R	CR 540×590×22 HSF5 R
	590	30	CR 540×590×22 HSF1 V	CR 540×590×22 HSF5 V
550	600	22,3	CR 540×590×30 HSF1 R	CR 540×590×30 HSF5 R
	600	30	CR 540×590×30 HSF1 V	CR 540×590×30 HSF5 V
560	604	20	CR 550×600×22.3 HSF1 R	CR 550×600×22.3 HSF5 R
	604	20	CR 550×600×22.3 HSF1 V	CR 550×600×22.3 HSF5 V
560	610	20	CR 560×604×20 HSF1 R	CR 560×604×20 HSF5 R
	610	20	CR 560×604×20 HSF1 V	CR 560×604×20 HSF5 V
560	610	22,3	CR 560×610×20 HSF1 R	CR 560×610×20 HSF5 R
	610	22,3	CR 560×610×20 HSF1 V	CR 560×610×20 HSF5 V
560	610	25	CR 560×610×22.3 HSF1 R	CR 560×610×22.3 HSF5 R
	610	25	CR 560×610×22.3 HSF1 V	CR 560×610×22.3 HSF5 V
570	616	19	CR 560×610×25 HSF1 R	CR 560×610×25 HSF5 R
	616	19	CR 560×610×25 HSF1 V	CR 560×610×25 HSF5 V
570	620	25	CR 570×616×19 HSF1 R	CR 570×616×19 HSF5 R
	620	25	CR 570×616×19 HSF1 V	CR 570×616×19 HSF5 V
575	625	22	CR 570×620×25 HSF1 R	CR 570×620×25 HSF5 R
	625	22	CR 570×620×25 HSF1 V	CR 570×620×25 HSF5 V
580	630	22	CR 575×625×22 HSF1 R	CR 575×625×22 HSF5 R
	630	22	CR 575×625×22 HSF1 V	CR 575×625×22 HSF5 V
600	650	22	CR 580×630×22 HSF1 R	CR 580×630×22 HSF5 R
	650	22	CR 580×630×22 HSF1 V	CR 580×630×22 HSF5 V
620	670	22	CR 600×650×22 HSF1 R	CR 600×650×22 HSF5 R
	670	22	CR 600×650×22 HSF1 V	CR 600×650×22 HSF5 V
620	684	25	CR 620×670×22 HSF1 R	CR 620×670×22 HSF5 R
	684	25	CR 620×670×22 HSF1 V	CR 620×670×22 HSF5 V
625	689	25	CR 620×684×25 HSF1 R	CR 620×684×25 HSF5 R
	689	25	CR 620×684×25 HSF1 V	CR 620×684×25 HSF5 V
630	690	30	CR 625×689×25 HSF1 R	CR 625×689×25 HSF5 R
	690	30	CR 625×689×25 HSF1 V	CR 625×689×25 HSF5 V
635	705	30	CR 630×690×30 HSF1 R	CR 630×690×30 HSF5 R
	705	30	CR 630×690×30 HSF1 V	CR 630×690×30 HSF5 V
650	690	18	CR 635×705×30 HSF1 R	CR 635×705×30 HSF5 R
	690	18	CR 635×705×30 HSF1 V	CR 635×705×30 HSF5 V
650	690	18	CR 650×690×18 HSF1 R	CR 650×690×18 HSF5 R
	690	18	CR 650×690×18 HSF1 V	CR 650×690×18 HSF5 V

Series HSF1 (split), HSF5 (solid) – Metric sizes

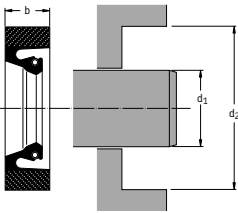

Dimensions			SKF Designation	
shaft	bore	seal width	Lip material R	Lip material R
d ₁	d ₂	b	Lip material V	Lip material V
mm				
660	724	25	CR 660×724×25 HSF1 R	CR 660×724×25 HSF5 R
			CR 660×724×25 HSF1 V	CR 660×724×25 HSF5 V
670	734	25	CR 670×734×25 HSF1 R	CR 670×734×25 HSF5 R
			CR 670×734×25 HSF1 V	CR 670×734×25 HSF5 V
685	749	25	CR 685×749×25 HSF1 R	CR 685×749×25 HSF5 R
			CR 685×749×25 HSF1 V	CR 685×749×25 HSF5 V
700	760	30	CR 700×760×30 HSF1 R	CR 700×760×30 HSF5 R
710	770	30	CR 710×770×30 HSF1 R	CR 710×770×30 HSF5 R
			CR 710×770×30 HSF1 V	CR 710×770×30 HSF5 V
	774	25	CR 710×774×25 HSF1 R	CR 710×774×25 HSF5 R
			CR 710×774×25 HSF1 V	CR 710×774×25 HSF5 V
730	794	25	CR 730×794×25 HSF1 R	CR 730×794×25 HSF5 R
736	800	25	CR 736×800×25 HSF1 R	CR 736×800×25 HSF5 R
			CR 736×800×25 HSF1 V	CR 736×800×25 HSF5 V
740	785	18	CR 740×785×18 HSF1 R	CR 740×785×18 HSF5 R
			CR 740×785×18 HSF1 V	CR 740×785×18 HSF5 V
744	808	25	CR 744×808×25 HSF1 R	CR 744×808×25 HSF5 R
			CR 744×808×25 HSF1 V	CR 744×808×25 HSF5 V
750	810	30	CR 750×810×30 HSF1 R	CR 750×810×30 HSF5 R
			CR 750×810×30 HSF1 V	CR 750×810×30 HSF5 V
	814	25	CR 750×814×25 HSF1 R	CR 750×814×25 HSF5 R
CR 750×814×25 HSF1 V			CR 750×814×25 HSF5 V	
760	820	30	CR 760×820×30 HSF1 R	CR 760×820×30 HSF5 R
			CR 760×820×30 HSF1 V	CR 760×820×30 HSF5 V
770	834	25	CR 770×834×25 HSF1 R	CR 770×834×25 HSF5 R
			CR 770×834×25 HSF1 V	CR 770×834×25 HSF5 V
780	844	25	CR 780×844×25 HSF1 R	CR 780×844×25 HSF5 R
			CR 780×844×25 HSF1 V	CR 780×844×25 HSF5 V
790	850	30	CR 790×850×30 HSF1 R	CR 790×850×30 HSF5 R
			CR 790×850×30 HSF1 V	CR 790×850×30 HSF5 V

Series HSF1 (split), HSF5 (solid) – Metric sizes

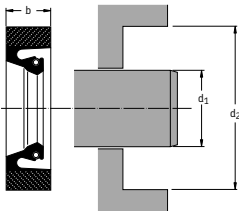

Dimensions			SKF Designation	
shaft	bore	seal width	Lip material R	Lip material V
d_1	d_2	b	Lip material R	Lip material V
mm				
800	860	30	CR 800×860×30 HSF1 R	CR 800×860×30 HSF5 R
	865	25	CR 800×860×30 HSF1 V	CR 800×860×30 HSF5 V
810	860	25	CR 800×865×25 HSF1 R	CR 800×865×25 HSF5 R
			CR 800×865×25 HSF1 V	CR 800×865×25 HSF5 V
	874	22	CR 810×860×25 HSF1 R	CR 810×860×25 HSF5 R
			CR 810×860×25 HSF1 V	CR 810×860×25 HSF5 V
840	904	25	CR 810×874×22 HSF1 R	CR 810×874×22 HSF5 R
			CR 810×874×22 HSF1 V	CR 810×874×22 HSF5 V
	904	25	CR 840×904×25 HSF1 R	CR 840×904×25 HSF5 R
			CR 840×904×25 HSF1 V	CR 840×904×25 HSF5 V
850	900	22	CR 850×904×25 HSF1 R	CR 850×904×25 HSF5 R
			CR 850×904×25 HSF1 V	CR 850×904×25 HSF5 V
	904	25	CR 850×900×22 HSF1 R	CR 850×900×22 HSF5 R
			CR 850×900×22 HSF1 V	CR 850×900×22 HSF5 V
	910	30	CR 850×904×25 HSF1 R	CR 850×904×25 HSF5 R
CR 850×904×25 HSF1 V			CR 850×904×25 HSF5 V	
900	960	30	CR 850×910×30 HSF1 R	CR 850×910×30 HSF5 R
			CR 850×910×30 HSF1 V	CR 850×910×30 HSF5 V
	964	32	CR 900×960×30 HSF1 R	CR 900×960×30 HSF5 R
			CR 900×960×30 HSF1 V	CR 900×960×30 HSF5 V
910	974	25	CR 900×964×32 HSF1 R	CR 900×964×32 HSF5 R
			CR 900×964×32 HSF1 V	CR 900×964×32 HSF5 V
	974	25,4	CR 910×974×25 HSF1 R	CR 910×974×25 HSF5 R
			CR 910×974×25 HSF1 V	CR 910×974×25 HSF5 V
920	984	25	CR 910×974×25.4 HSF1 R	CR 910×974×25.4 HSF5 R
			CR 910×974×25.4 HSF1 V	CR 910×974×25.4 HSF5 V
950	1 000	25	CR 920×984×25 HSF1 R	CR 920×984×25 HSF5 R
			CR 920×984×25 HSF1 V	CR 920×984×25 HSF5 V
	1 010	30	CR 950×1000×25 HSF1 R	CR 950×1000×25 HSF5 R
			CR 950×1000×25 HSF1 V	CR 950×1000×25 HSF5 V
960	1 024	25	CR 950×1010×30 HSF1 R	CR 950×1010×30 HSF5 R
			CR 950×1010×30 HSF1 V	CR 950×1010×30 HSF5 V
960	1 024	25	CR 960×1024×25 HSF1 R	CR 960×1024×25 HSF5 R
			CR 960×1024×25 HSF1 V	CR 960×1024×25 HSF5 V

Series HSF1 (split), HSF5 (solid) – Metric sizes

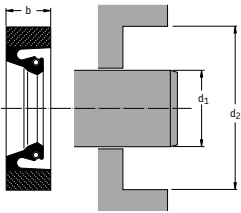

Dimensions			SKF Designation	
shaft	bore	seal width	Lip material R	Lip material V
d_1	d_2	b	Lip material R	Lip material V
mm				
970	1 020	25	CR 970×1020×25 HSF1 R	CR 970×1020×25 HSF5 R
	1 034	25	CR 970×1020×25 HSF1 V	CR 970×1020×25 HSF5 V
1 000	1 064	25	CR 970×1034×25 HSF1 R	CR 970×1034×25 HSF5 R
			CR 970×1034×25 HSF1 V	CR 970×1034×25 HSF5 V
1 016	1 064	25	CR 1000×1064×25 HSF1 R	CR 1000×1064×25 HSF5 R
			CR 1000×1064×25 HSF1 V	CR 1000×1064×25 HSF5 V
1 016	1 043,1	13,7	CR 1016×1043,1×13,7 HSF1 R	CR 1016×1043,1×13,7 HSF5 R
			CR 1016×1043,1×13,7 HSF1 V	CR 1016×1043,1×13,7 HSF5 V
1 110	1 174	25	CR 1110×1174×25 HSF1 R	CR 1110×1174×25 HSF5 R
			CR 1110×1174×25 HSF1 V	CR 1110×1174×25 HSF5 V

Series HSF1 (split), HSF5 (solid) – Inch sizes

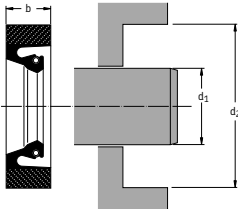

Dimensions			SKF Designation			
shaft	bore	seal width	Split version	Solid version	Lip material R	Lip material V
d ₁	d ₂	b	Lip material R	Lip material V	Lip material R	Lip material V
in (mm)						
1.000 25,4	1.874 47,6	0.375 9,5	CR HSF1 5001 R	CR HSF1 5001 V	CR HSF5 5001 R	CR HSF5 5001 V
2.750 69,9	3.375 85,7	0.312 7,9	CR HSF1 5156 R	CR HSF1 5156 V	CR HSF5 5156 R	CR HSF5 5156 V
3.248 82,5	4.500 114,3	0.500 12,7	CR HSF1 5225 R	CR HSF1 5225 V	CR HSF5 5225 R	CR HSF5 5225 V
3.500 88,9	4.500 114,3	0.500 12,7	CR HSF1 5252 R	CR HSF1 5252 V	CR HSF5 5252 R	CR HSF5 5252 V
3.874 98,4	4.878 123,9	0.500 12,7	CR HSF1 5265 R	CR HSF1 5265 V	CR HSF5 5265 R	CR HSF5 5265 V
4.000 101,6	5.000 127	0.500 12,7	CR HSF1 5310 R	CR HSF1 5310 V	CR HSF5 5310 R	CR HSF5 5310 V
4.425 112,4	5.500 139,7	0.562 14,3	CR HSF1 5353 R	CR HSF1 5353 V	CR HSF5 5353 R	CR HSF5 5353 V
4.437 112,7	5.465 138,8	0.583 14,8	CR HSF1 5351 R	CR HSF1 5351 V	CR HSF5 5351 R	CR HSF5 5351 V
4.874 123,8	5.874 149,2	0.500 12,7	CR HSF1 5391 R	CR HSF1 5391 V	CR HSF5 5391 R	CR HSF5 5391 V
5.205 132,2	6.504 165,2	0.591 15	CR HSF1 5431 R	CR HSF1 5431 V	CR HSF5 5431 R	CR HSF5 5431 V
5.622 142,8	6.622 168,2	0.625 15,9	CR HSF1 5471 R	CR HSF1 5471 V	CR HSF5 5471 R	CR HSF5 5471 V
5.750 146,1	7.000 177,8	0.625 15,9	CR HSF1 5489 R	CR HSF1 5489 V	CR HSF5 5489 R	CR HSF5 5489 V
5.874 149,2	7.000 177,8	0.492 12,5	CR HSF1 5498 R	CR HSF1 5498 V	CR HSF5 5498 R	CR HSF5 5498 V
6.000 152,4	7.126 181	0.630 16	CR HSF1 5509 R	CR HSF1 5509 V	CR HSF5 5509 R	CR HSF5 5509 V
	7.500 190,5	0.625 15,9	CR HSF1 5510 R	CR HSF1 5510 V	CR HSF5 5510 R	CR HSF5 5510 V
6.500 165,1	8.000 203,2	0.750 19,1	CR HSF1 5570 R	CR HSF1 5570 V	CR HSF5 5570 R	CR HSF5 5570 V

Series HSF1 (split), HSF5 (solid) – Inch sizes

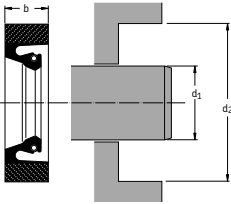

Dimensions			SKF Designation			
shaft	bore	seal width	Split version	Solid version		
d_1	d_2	b	Lip material R	Lip material V	Lip material R	Lip material V
in (mm)						
6.748	7.750	0.750	CR HSF1 5585 R	CR HSF1 5585 V	CR HSF5 5585 R	CR HSF5 5585 V
171,4	196,9	19,1				
7.000	8.000	0.437	CR HSF1 5587 R	CR HSF1 5587 V	CR HSF5 5587 R	CR HSF5 5587 V
177,8	203,2	11,1				
	8.250	0.750	CR HSF1 5600 R	CR HSF1 5600 V	CR HSF5 5600 R	CR HSF5 5600 V
	209,6	19,1				
7.250	8.500	0.625	CR HSF1 5624 R	CR HSF1 5624 V	CR HSF5 5624 R	CR HSF5 5624 V
184,2	215,9	15,9				
7.500	8.500	0.625	CR HSF1 5662 R	CR HSF1 5662 V	CR HSF5 5662 R	CR HSF5 5662 V
190,5	215,9	15,9				
7.677	8.677	0.500	CR HSF1 5667 R	CR HSF1 5667 V	CR HSF5 5667 R	CR HSF5 5667 V
195	220,4	12,7				
8.598	9.843	0.591	CR HSF1 5764 R	CR HSF1 5764 V	CR HSF5 5764 R	CR HSF5 5764 V
218,4	250	15				
8.750	10.000	0.625	CR HSF1 5790 R	CR HSF1 5790 V	CR HSF5 5790 R	CR HSF5 5790 V
222,3	254	15,9				
9.625	11.635	1.000	CR HSF1 5878 R	CR HSF1 5878 V	CR HSF5 5878 R	CR HSF5 5878 V
244,5	295,5	25,4				
9.843	10.843	0.500	CR HSF1 5885 R	CR HSF1 5885 V	CR HSF5 5885 R	CR HSF5 5885 V
250	275,4	12,7				
10.000	11.250	0.625	CR HSF1 5910 R	CR HSF1 5910 V	CR HSF5 5910 R	CR HSF5 5910 V
254	285,8	15,9				
10.250	12.250	0.750	CR HSF1 5950 R	CR HSF1 5950 V	CR HSF5 5950 R	CR HSF5 5950 V
260,4	311,2	19,1				
11.000	12.181	0.591	CR HSF1 6000 R	CR HSF1 6000 V	CR HSF5 6000 R	CR HSF5 6000 V
279,4	309,4	15				
11.250	12.500	0.625	CR HSF1 6040 R	CR HSF1 6040 V	CR HSF5 6040 R	CR HSF5 6040 V
285,8	317,5	15,9				
11.260	13.250	0.591	CR HSF1 6049 R	CR HSF1 6049 V	CR HSF5 6049 R	CR HSF5 6049 V
286	336,6	15				
11.417	12.417	0.500	CR HSF1 6055 R	CR HSF1 6055 V	CR HSF5 6055 R	CR HSF5 6055 V
290	315,4	12,7				

Series HSF1 (split), HSF5 (solid) – Inch sizes

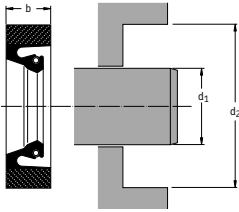

Dimensions			SKF Designation			
shaft	bore	seal width	Split version	Solid version		
d ₁	d ₂	b	Lip material R	Lip material V	Lip material R	Lip material V
in (mm)						
12.250	14.250	0.812	CR HSF1 6150 R	CR HSF1 6150 V	CR HSF5 6150 R	CR HSF5 6150 V
311,2	362	20,6				
12.484	14.000	0.630	CR HSF1 6172 R	CR HSF1 6172 V	CR HSF5 6172 R	CR HSF5 6172 V
317,1	355,6	16				
12.500	14.000	0.750	CR HSF1 6173 R	CR HSF1 6173 V	CR HSF5 6173 R	CR HSF5 6173 V
317,5	355,6	19,1				
12.504	14.000	0.687	CR HSF1 6175 R	CR HSF1 6175 V	CR HSF5 6175 R	CR HSF5 6175 V
317,6	355,6	17,4				
12.746	14.248	0.687	CR HSF1 6192 R	CR HSF1 6192 V	CR HSF5 6192 R	CR HSF5 6192 V
323,7	361,9	17,4				
	14.750	1.000	CR HSF1 6195 R	CR HSF1 6195 V	CR HSF5 6195 R	CR HSF5 6195 V
	374,7	25,4				
13.000	14.500	0.687	CR HSF1 6230 R	CR HSF1 6230 V	CR HSF5 6230 R	CR HSF5 6230 V
330,2	368,3	17,4				
	14.500	0.687	CR HSF1 6230 R	CR HSF1 6230 V	CR HSF5 6230 R	CR HSF5 6230 V
	368,3	17,4				
13.500	15.000	0.750	CR HSF1 6271 R	CR HSF1 6271 V	CR HSF5 6271 R	CR HSF5 6271 V
342,9	381	19,1				
14.370	16.118	0.750	CR HSF1 6350 R	CR HSF1 6350 V	CR HSF5 6350 R	CR HSF5 6350 V
365	409,4	19,1				
14.500	16.250	0.625	CR HSF1 6370 R	CR HSF1 6370 V	CR HSF5 6370 R	CR HSF5 6370 V
368,3	412,8	15,9				
14.961	16.961	0.812	CR HSF1 6425 R	CR HSF1 6425 V	CR HSF5 6425 R	CR HSF5 6425 V
380	430,8	20,6				
15.250	17.250	0.875	CR HSF1 6460 R	CR HSF1 6460 V	CR HSF5 6460 R	CR HSF5 6460 V
387,4	438,2	22,2				
15.992	17.500	0.687	CR HSF1 6550 R	CR HSF1 6550 V	CR HSF5 6550 R	CR HSF5 6550 V
406,2	444,5	17,4				
16.000	18.000	0.750	CR HSF1 6560 R	CR HSF1 6560 V	CR HSF5 6560 R	CR HSF5 6560 V
406,4	457,2	19,1				
	18.000	0.812	CR HSF1 6565 R	CR HSF1 6565 V	CR HSF5 6565 R	CR HSF5 6565 V
	457,2	20,6				
	18.000	0.906	CR HSF1 6575 R	CR HSF1 6575 V	CR HSF5 6575 R	CR HSF5 6575 V
	457,2	23				

Series HSF1 (split), HSF5 (solid) – Inch sizes

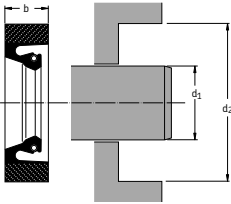

Dimensions			SKF Designation			
shaft	bore	seal width	Split version	Solid version		
d ₁	d ₂	b	Lip material R	Lip material V	Lip material R	Lip material V
in (mm)						
16.226	17.750	0.687	CR HSF1 6590 R	CR HSF1 6590 V	CR HSF5 6590 R	CR HSF5 6590 V
412,1	450,9	17,4				
16.500	17.750	0.750	CR HSF1 6600 R	CR HSF1 6600 V	CR HSF5 6600 R	CR HSF5 6600 V
419,1	450,9	19,1				
17.000	19.000	0.812	CR HSF1 6645 R	CR HSF1 6645 V	CR HSF5 6645 R	CR HSF5 6645 V
431,8	482,6	20,6				
17.248	18.748	0.750	CR HSF1 6656 R	CR HSF1 6656 V	CR HSF5 6656 R	CR HSF5 6656 V
438,1	476,2	19,1				
18.169	21.260	1.220	CR HSF1 6734 R	CR HSF1 6734 V	CR HSF5 6734 R	CR HSF5 6734 V
461,5	540	31				
20.500	22.500	1.000	CR HSF1 6890 R	CR HSF1 6890 V	CR HSF5 6890 R	CR HSF5 6890 V
520,7	571,5	25,4				
21.000	23.000	0.875	CR HSF1 6930 R	CR HSF1 6930 V	CR HSF5 6930 R	CR HSF5 6930 V
533,4	584,2	22,2				
22.000	24.000	0.875	CR HSF1 7000 R	CR HSF1 7000 V	CR HSF5 7000 R	CR HSF5 7000 V
558,8	609,6	22,2				
23.248	25.250	0.812	CR HSF1 7100 R	CR HSF1 7100 V	CR HSF5 7100 R	CR HSF5 7100 V
590,5	641,4	20,6				
23.501	22.001	0.750	CR HSF1 6990 R	CR HSF1 6990 V	CR HSF5 6990 R	CR HSF5 6990 V
596,9	558,8	19,1				
30.000	32.500	1.000	CR HSF1 7520 R	CR HSF1 7520 V	CR HSF5 7520 R	CR HSF5 7520 V
762	825,5	25,4				
30.461	32.500	0.906	CR HSF1 7525 R	CR HSF1 7525 V	CR HSF5 7525 R	CR HSF5 7525 V
773,7	825,5	23				
31.000	33.000	0.906	CR HSF1 7570 R	CR HSF1 7570 V	CR HSF5 7570 R	CR HSF5 7570 V
787,4	838,2	23				
31.250	33.250	0.750	CR HSF1 7580 R	CR HSF1 7580 V	CR HSF5 7580 R	CR HSF5 7580 V
793,8	844,6	19,1				
32.500	34.500	0.875	CR HSF1 7700 R	CR HSF1 7700 V	CR HSF5 7700 R	CR HSF5 7700 V
825,5	876,3	22,2				
	34.500	1.000	CR HSF1 7710 R	CR HSF1 7710 V	CR HSF5 7710 R	CR HSF5 7710 V
	876,3	25,4				

Series HSF1 (split), HSF5 (solid) – Inch sizes

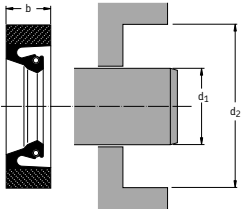

Dimensions			SKF Designation			
shaft	bore	seal width	Split version	Solid version		
d ₁	d ₂	b	Lip material R	Lip material V	Lip material R	Lip material V
in (mm)						
33.000	35.000	0.906	CR HSF1 7730 R	CR HSF1 7730 V	CR HSF5 7730 R	CR HSF5 7730 V
838,2	889	23				
34.375	36.875	1.250	CR HSF1 7810 R	CR HSF1 7810 V	CR HSF5 7810 R	CR HSF5 7810 V
873,1	936,6	31,8				
36.500	39.000	1.250	CR HSF1 7895 R	CR HSF1 7895 V	CR HSF5 7895 R	CR HSF5 7895 V
927,1	990,6	31,8				
36.748	38.749	0.875	CR HSF1 7900 R	CR HSF1 7900 V	CR HSF5 7900 R	CR HSF5 7900 V
933,4	984,2	22,2				
38.000	40.000	0.875	CR HSF1 7990 R	CR HSF1 7990 V	CR HSF5 7990 R	CR HSF5 7990 V
965,2	1 016	22,2				
39.118	40.000	0.500	CR HSF1 8170 R	CR HSF1 8170 V	CR HSF5 8170 R	CR HSF5 8170 V
993,6	1 016	12,7				
48.000	49.000	1.260	CR HSF1 8400 R	CR HSF1 8400 V	CR HSF5 8400 R	CR HSF5 8400 V
1 219,2	1 244,6	32				

HSF2 (split), HSF6 (solid) series – Metric sizes

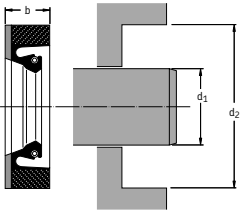

Dimensions			SKF Designation	
shaft	bore	seal width	Split version (HSF2)	Solid version (HSF6)
d_1	d_2	b	Lip material R	Lip material R
			Lip material V	Lip material V
mm				
127	158,8	12,3	CR 127×158.8×12.3 HSF2 R CR 127×158.8×12.3 HSF2 V	CR 127×158.8×12.3 HSF6 R CR 127×158.8×12.3 HSF6 V
275	319,5	19	CR 275×319.5×19 HSF2 R CR 275×319.5×19 HSF2 V	CR 275×319.5×19 HSF6 R CR 275×319.5×19 HSF6 V
320	364	18	CR 320×364×18 HSF2 R CR 320×364×18 HSF2 V	CR 320×364×18 HSF6 R CR 320×364×18 HSF6 V
800	864	21,6	CR 800×864×21.6 HSF2 R CR 800×864×21.6 HSF2 V	CR 800×864×21.6 HSF6 R CR 800×864×21.6 HSF6 V

Series HSF2 (split), HSF6 (solid) – Inch sizes

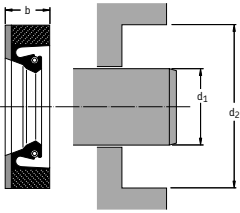

Dimensions			SKF Designation			
shaft	bore	seal width	Split version (HSF2)		Solid version (HSF6)	
d_1	d_2	b	Lip material R	Lip material V	Lip material R	Lip material V
in (mm)						
21.000	23.000	0.875	CR HSF2 6930 R	CR HSF2 6930 V	CR HSF6 6930 R	CR HSF6 6930 V
533,40	584,20	22,23				

Series HSF3 (split), HSF7 (solid) – Metric sizes

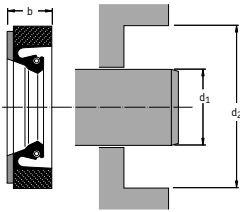

Dimensions			SKF Designation	
shaft	bore	seal width	Split version (HSF3)	Solid version (HSF7)
d_1	d_2	b	Lip material R Lip material V	Lip material R Lip material V
mm				
80	95	10	CR 80×95×10 HSF3 R CR 80×95×10 HSF3 V	CR 80×95×10 HSF7 R CR 80×95×10 HSF7 V
100	130	12,5	CR 100×130×12.5 HSF3 R CR 100×130×12.5 HSF3 V	CR 100×130×12.5 HSF7 R CR 100×130×12.5 HSF7 V
140	180	16	CR 140×180×16 HSF3 R CR 140×180×16 HSF3 V	CR 140×180×16 HSF7 R CR 140×180×16 HSF7 V
150	190	16	CR 150×190×16 HSF3 R CR 150×190×16 HSF3 V	CR 150×190×16 HSF7 R CR 150×190×16 HSF7 V
160	200	16	CR 160×200×16 HSF3 R CR 160×200×16 HSF3 V	CR 160×200×16 HSF7 R CR 160×200×16 HSF7 V
165	195	15	CR 165×195×15 HSF3 R CR 165×195×15 HSF3 V	CR 165×195×15 HSF7 R CR 165×195×15 HSF7 V
220	250	15	CR 220×250×15 HSF3 R CR 220×250×15 HSF3 V	CR 220×250×15 HSF7 R CR 220×250×15 HSF7 V
	260	18	CR 220×260×18 HSF3 R CR 220×260×18 HSF3 V	CR 220×260×18 HSF7 R CR 220×260×18 HSF7 V
230	270	16	CR 230×270×16 HSF3 R CR 230×270×16 HSF3 V	CR 230×270×16 HSF7 R CR 230×270×16 HSF7 V
		15,3	CR 235×265×15.3 HSF3 R CR 235×265×15.3 HSF3 V	CR 235×265×15.3 HSF7 R CR 235×265×15.3 HSF7 V
240	280	18	CR 240×280×18 HSF3 R CR 240×280×18 HSF3 V	CR 240×280×18 HSF7 R CR 240×280×18 HSF7 V
	290	25	CR 240×290×25 HSF3 R CR 240×290×25 HSF3 V	CR 240×290×25 HSF7 R CR 240×290×25 HSF7 V
245	285	16	CR 245×285×16 HSF3 R CR 245×285×16 HSF3 V	CR 245×285×16 HSF7 R CR 245×285×16 HSF7 V
250	280	16	CR 250×280×16 HSF3 R CR 250×280×16 HSF3 V	CR 250×280×16 HSF7 R CR 250×280×16 HSF7 V
	290	16,5	CR 250×290×16.5 HSF3 R CR 250×290×16.5 HSF3 V	CR 250×290×16.5 HSF7 R CR 250×290×16.5 HSF7 V
270	310	18	CR 270×310×18 HSF3 R CR 270×310×18 HSF3 V	CR 270×310×18 HSF7 R CR 270×310×18 HSF7 V

Series HSF3 (split), HSF7 (solid) – Metric sizes

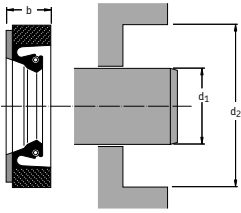

Dimensions			SKF Designation	Solid version (HSF7)
shaft	bore	seal width		
d_1	d_2	b	Split version (HSF3) Lip material R Lip material V	Lip material R Lip material V
mm				
280	320	18	CR 280×320×18 HSF3 R	CR 280×320×18 HSF7 R
			CR 280×320×18 HSF3 V	CR 280×320×18 HSF7 V
285	325	18	CR 285×325×18 HSF3 R	CR 285×325×18 HSF7 R
			CR 285×325×18 HSF3 V	CR 285×325×18 HSF7 V
290	334	20,3	CR 290×334×20.3 HSF3 R	CR 290×334×20.3 HSF7 R
			CR 290×334×20.3 HSF3 V	CR 290×334×20.3 HSF7 V
300	340	16,5	CR 300×340×16.5 HSF3 R	CR 300×340×16.5 HSF7 R
		CR 300×340×16.5 HSF3 V	CR 300×340×16.5 HSF7 V	
	18	CR 300×340×18 HSF3 R	CR 300×340×18 HSF7 R	
		CR 300×340×18 HSF3 V	CR 300×340×18 HSF7 V	
20	344	CR 300×344×20 HSF3 R	CR 300×344×20 HSF7 R	
	CR 300×344×20 HSF3 V	CR 300×344×20 HSF7 V		
310	353	20	CR 310×353×20 HSF3 R	CR 310×353×20 HSF7 R
		CR 310×353×20 HSF3 V	CR 310×353×20 HSF7 V	
	20	354	CR 310×354×20 HSF3 R	CR 310×354×20 HSF7 R
		CR 310×354×20 HSF3 V	CR 310×354×20 HSF7 V	
315	360	20	CR 315×360×20 HSF3 R	CR 315×360×20 HSF7 R
			CR 315×360×20 HSF3 V	CR 315×360×20 HSF7 V
320	350	15	CR 320×350×15 HSF3 R	CR 320×350×15 HSF7 R
			CR 320×350×15 HSF3 V	CR 320×350×15 HSF7 V
	17,7	360	CR 320×360×17.7 HSF3 R	CR 320×360×17.7 HSF7 R
CR 320×360×17.7 HSF3 V		CR 320×360×17.7 HSF7 V		
325	365	16	CR 325×365×16 HSF3 R	CR 325×365×16 HSF7 R
			CR 325×365×16 HSF3 V	CR 325×365×16 HSF7 V
330	370	20	CR 330×370×20 HSF3 R	CR 330×370×20 HSF7 R
			CR 330×370×20 HSF3 V	CR 330×370×20 HSF7 V
	20	374	CR 330×374×20 HSF3 R	CR 330×374×20 HSF7 R
CR 330×374×20 HSF3 V		CR 330×374×20 HSF7 V		
340	372	16	CR 340×372×16 HSF3 R	CR 340×372×16 HSF7 R
			CR 340×372×16 HSF3 V	CR 340×372×16 HSF7 V
345	389	20	CR 345×389×20 HSF3 R	CR 345×389×20 HSF7 R
			CR 345×389×20 HSF3 V	CR 345×389×20 HSF7 V

Series HSF3 (split), HSF7 (solid) – Metric sizes

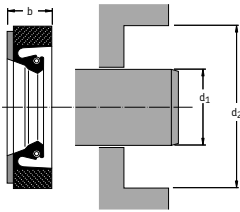

Dimensions			SKF Designation	Solid version (HSF7)
shaft	bore	seal width		
d_1	d_2	b	Split version (HSF3) Lip material R Lip material V	Lip material R Lip material V
mm				
350	390	18	CR 350×390×18 HSF3 R CR 350×390×18 HSF3 V	CR 350×390×18 HSF7 R CR 350×390×18 HSF7 V
	394	20	CR 350×394×20 HSF3 R CR 350×394×20 HSF3 V	CR 350×394×20 HSF7 R CR 350×394×20 HSF7 V
	394	22	CR 350×394×22 HSF3 R CR 350×394×22 HSF3 V	CR 350×394×22 HSF7 R CR 350×394×22 HSF7 V
			CR 350×394×22 HSF3 V	CR 350×394×22 HSF7 V
360	404	20	CR 360×404×20 HSF3 R CR 360×404×20 HSF3 V	CR 360×404×20 HSF7 R CR 360×404×20 HSF7 V
365	409,4	19,05	CR 365×409,4×19.05 HSF3 R CR 365×409,4×19.05 HSF3 V	CR 365×409,4×19.05 HSF7 R CR 365×409,4×19.05 HSF7 V
366	410	20	CR 366×410×20 HSF3 R CR 366×410×20 HSF3 V	CR 366×410×20 HSF7 R CR 366×410×20 HSF7 V
370	410	18	CR 370×410×18 HSF3 R CR 370×410×18 HSF3 V	CR 370×410×18 HSF7 R CR 370×410×18 HSF7 V
380	419	24	CR 380×419×24 HSF3 R CR 380×419×24 HSF3 V	CR 380×419×24 HSF7 R CR 380×419×24 HSF7 V
	424	20	CR 380×424×20 HSF3 R CR 380×424×20 HSF3 V	CR 380×424×20 HSF7 R CR 380×424×20 HSF7 V
385	425	18,3	CR 385×425×18.3 HSF3 R CR 385×425×18.3 HSF3 V	CR 385×425×18.3 HSF7 R CR 385×425×18.3 HSF7 V
387	431	22,5	CR 387×431×22.5 HSF3 R CR 387×431×22.5 HSF3 V	CR 387×431×22.5 HSF7 R CR 387×431×22.5 HSF7 V
390	430	18	CR 390×430×18 HSF3 R CR 390×430×18 HSF3 V	CR 390×430×18 HSF7 R CR 390×430×18 HSF7 V
400	440	18	CR 400×440×18 HSF3 R CR 400×440×18 HSF3 V	CR 400×440×18 HSF7 R CR 400×440×18 HSF7 V
	440	22	CR 400×440×22 HSF3 R CR 400×440×22 HSF3 V	CR 400×440×22 HSF7 R CR 400×440×22 HSF7 V
	444	20	CR 400×444×20 HSF3 R CR 400×444×20 HSF3 V	CR 400×444×20 HSF7 R CR 400×444×20 HSF7 V
	450	22	CR 400×450×22 HSF3 R CR 400×450×22 HSF3 V	CR 400×450×22 HSF7 R CR 400×450×22 HSF7 V
420	470	22	CR 420×470×22 HSF3 R CR 420×470×22 HSF3 V	CR 420×470×22 HSF7 R CR 420×470×22 HSF7 V

Series HSF3 (split), HSF7 (solid) – Metric sizes

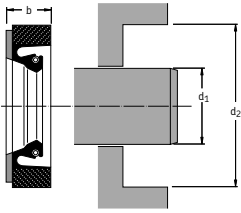

Dimensions			SKF Designation	Solid version (HSF7)
shaft	bore	seal width		
d_1	d_2	b	Split version (HSF3) Lip material R Lip material V	Lip material R Lip material V
mm				
430	480	22	CR 430×480×22 HSF3 R	CR 430×480×22 HSF7 R
			CR 430×480×22 HSF3 V	CR 430×480×22 HSF7 V
440	490	22	CR 440×490×22 HSF3 R	CR 440×490×22 HSF7 R
			CR 440×490×22 HSF3 V	CR 440×490×22 HSF7 V
450	494	20	CR 450×494×20 HSF3 R	CR 450×494×20 HSF7 R
			CR 450×494×20 HSF3 V	CR 450×494×20 HSF7 V
460	510	22	CR 460×510×22 HSF3 R	CR 460×510×22 HSF7 R
			CR 460×510×22 HSF3 V	CR 460×510×22 HSF7 V
	510	22	CR 460×510×22 HSF3 R	CR 460×510×22 HSF7 R
			CR 460×510×22 HSF3 V	CR 460×510×22 HSF7 V
480	530	22	CR 480×530×22 HSF3 R	CR 480×530×22 HSF7 R
			CR 480×530×22 HSF3 V	CR 480×530×22 HSF7 V
500	544	20	CR 500×544×20 HSF3 R	CR 500×544×20 HSF7 R
			CR 500×544×20 HSF3 V	CR 500×544×20 HSF7 V
515	555	20	CR 515×555×20 HSF3 R	CR 515×555×20 HSF7 R
			CR 515×555×20 HSF3 V	CR 515×555×20 HSF7 V
520	564	20	CR 520×564×20 HSF3 R	CR 520×564×20 HSF7 R
			CR 520×564×20 HSF3 V	CR 520×564×20 HSF7 V
	570	22	CR 520×570×22 HSF3 R	CR 520×570×22 HSF7 R
			CR 520×570×22 HSF3 V	CR 520×570×22 HSF7 V
530	580	22	CR 530×580×22 HSF3 R	CR 530×580×22 HSF7 R
			CR 530×580×22 HSF3 V	CR 530×580×22 HSF7 V
540	590	22	CR 540×590×22 HSF3 R	CR 540×590×22 HSF7 R
			CR 540×590×22 HSF3 V	CR 540×590×22 HSF7 V
	590	25	CR 540×590×25 HSF3 R	CR 540×590×25 HSF7 R
			CR 540×590×25 HSF3 V	CR 540×590×25 HSF7 V
545	596,9	19,05	CR 545×596.9×19.05 HSF3 R	CR 545×596.9×19.05 HSF7 R
			CR 545×596.9×19.05 HSF3 V	CR 545×596.9×19.05 HSF7 V
550	600	22	CR 550×600×22 HSF3 R	CR 550×600×22 HSF7 R
			CR 550×600×22 HSF3 V	CR 550×600×22 HSF7 V

Series HSF3 (split), HSF7 (solid) – Metric sizes

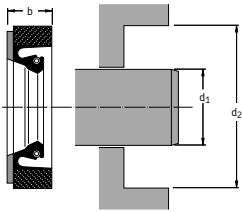

Dimensions			SKF Designation	Solid version (HSF7)
shaft	bore	seal width		
d_1	d_2	b	Split version (HSF3) Lip material R Lip material V	Lip material R Lip material V
mm				
560	603	20	CR 560×603×20 HSF3 R CR 560×603×20 HSF3 V	CR 560×603×20 HSF7 R CR 560×603×20 HSF7 V
	604	20	CR 560×604×20 HSF3 R CR 560×604×20 HSF3 V	CR 560×604×20 HSF7 R CR 560×604×20 HSF7 V
580	630	22	CR 580×630×22 HSF3 R CR 580×630×22 HSF3 V	CR 580×630×22 HSF7 R CR 580×630×22 HSF7 V
590	640	22	CR 590×640×22 HSF3 R CR 590×640×22 HSF3 V	CR 590×640×22 HSF7 R CR 590×640×22 HSF7 V
600	640	18	CR 600×640×18 HSF3 R CR 600×640×18 HSF3 V	CR 600×640×18 HSF7 R CR 600×640×18 HSF7 V
614	658	20	CR 614×658×20 HSF3 R CR 614×658×20 HSF3 V	CR 614×658×20 HSF7 R CR 614×658×20 HSF7 V
620	670	22	CR 620×670×22 HSF3 R CR 620×670×22 HSF3 V	CR 620×670×22 HSF7 R CR 620×670×22 HSF7 V
640	680	20	CR 640×680×20 HSF3 R CR 640×680×20 HSF3 V	CR 640×680×20 HSF7 R CR 640×680×20 HSF7 V
650	700	22	CR 650×700×22 HSF3 R CR 650×700×22 HSF3 V	CR 650×700×22 HSF7 R CR 650×700×22 HSF7 V
660	700	18	CR 660×700×18 HSF3 R CR 660×700×18 HSF3 V	CR 660×700×18 HSF7 R CR 660×700×18 HSF7 V
665	715	22	CR 665×715×22 HSF3 R CR 665×715×22 HSF3 V	CR 665×715×22 HSF7 R CR 665×715×22 HSF7 V
670	714	22	CR 670×714×22 HSF3 R CR 670×714×22 HSF3 V	CR 670×714×22 HSF7 R CR 670×714×22 HSF7 V
700	764	25	CR 700×764×25 HSF3 R CR 700×764×25 HSF3 V	CR 700×764×25 HSF7 R CR 700×764×25 HSF7 V
710	774	25	CR 710×774×25 HSF3 R CR 710×774×25 HSF3 V	CR 710×774×25 HSF7 R CR 710×774×25 HSF7 V
724	775	22	CR 724×775×22 HSF3 R CR 724×775×22 HSF3 V	CR 724×775×22 HSF7 R CR 724×775×22 HSF7 V
740	780	16,5	CR 740×780×16.5 HSF3 R CR 740×780×16.5 HSF3 V	CR 740×780×16.5 HSF7 R CR 740×780×16.5 HSF7 V

Series HSF3 (split), HSF7 (solid) – Metric sizes

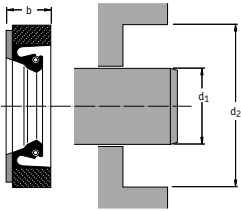

Dimensions			SKF Designation	
shaft	bore	seal width	Split version (HSF3)	Solid version (HSF7)
d_1	d_2	b	Lip material R	Lip material R
			Lip material V	Lip material V
mm				
750	814	28	CR 750×814×28 HSF3 R CR 750×814×28 HSF3 V	CR 750×814×28 HSF7 R CR 750×814×28 HSF7 V
775	839	25	CR 775×839×25 HSF3 R CR 775×839×25 HSF3 V	CR 775×839×25 HSF7 R CR 775×839×25 HSF7 V
790	834	25	CR 790×834×25 HSF3 R CR 790×834×25 HSF3 V	CR 790×834×25 HSF7 R CR 790×834×25 HSF7 V
	854	25	CR 790×854×25 HSF3 R CR 790×854×25 HSF3 V	CR 790×854×25 HSF7 R CR 790×854×25 HSF7 V
800	864	25	CR 800×864×25 HSF3 R CR 800×864×25 HSF3 V	CR 800×864×25 HSF7 R CR 800×864×25 HSF7 V
840	880	18	CR 840×880×18 HSF3 R CR 840×880×18 HSF3 V	CR 840×880×18 HSF7 R CR 840×880×18 HSF7 V
880	944	25,4	CR 880×944×25,4 HSF3 R CR 880×944×25,4 HSF3 V	CR 880×944×25,4 HSF7 R CR 880×944×25,4 HSF7 V
890	930	18	CR 890×930×18 HSF3 R CR 890×930×18 HSF3 V	CR 890×930×18 HSF7 R CR 890×930×18 HSF7 V
910	974	25	CR 910×974×25 HSF3 R CR 910×974×25 HSF3 V	CR 910×974×25 HSF7 R CR 910×974×25 HSF7 V
970	1 034	25	CR 970×1034×25 HSF3 R CR 970×1034×25 HSF3 V	CR 970×1034×25 HSF7 R CR 970×1034×25 HSF7 V
985	1 045	25	CR 985×1045×25 HSF3 R CR 985×1045×25 HSF3 V	CR 985×1045×25 HSF7 R CR 985×1045×25 HSF7 V
1 030	970	21,5	CR 1030×970×21,5 HSF3 R CR 1030×970×21,5 HSF3 V	CR 1030×970×21,5 HSF7 R CR 1030×970×21,5 HSF7 V

Series HSF3 (split), HSF7 (solid) – Inch sizes

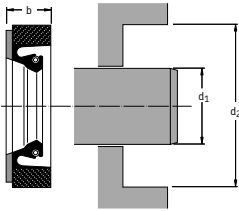

Dimensions			SKF Designation		Solid version (HSF7)	
shaft	bore	seal width	Split version (HSF3)		Solid version (HSF7)	
d_1	d_2	b	Lip material R	Lip material V	Lip material R	Lip material V
in (mm)						
28.500	9.750	0.812	CR HSF3 5766 R	CR HSF3 5766 V	CR HSF7 5766 R	CR HSF7 5766 V
215,9	247,65	20,62				
10.000	11.500	0.630	CR HSF3 5920 R	CR HSF3 5920 V	CR HSF7 5920 R	CR HSF7 5920 V
254,00	292,10	16,00				
11.500	13.780	0.630	CR HSF3 6075 R	CR HSF3 6075 V	CR HSF7 6075 R	CR HSF7 6075 V
292,10	350,01	16,00				
12.250	14.250	0.812	CR HSF3 6150 R	CR HSF3 6150 V	CR HSF7 6150 R	CR HSF7 6150 V
311,15	361,95	20,62				
14.500	16.500	0.812	CR HSF3 6370 R	CR HSF3 6370 V	CR HSF7 6370 R	CR HSF7 6370 V
368,30	419,10	20,62				
	16.500	1.152	CR HSF3 6375 R	CR HSF3 6375 V	CR HSF7 6375 R	CR HSF7 6375 V
	419,10	29,26				
14.750	16.500	0.875	CR HSF3 6395 R	CR HSF3 6395 V	CR HSF7 6395 R	CR HSF7 6395 V
374,65	419,10	22,23				
15.250	17.250	1.000	CR HSF3 6465 R	CR HSF3 6465 V	CR HSF7 6465 R	CR HSF7 6465 V
387,35	438,15	25,40				
16.500	18.000	0.750	CR HSF3 6611 R	CR HSF3 6611 V	CR HSF7 6611 R	CR HSF7 6611 V
419,10	457,20	19,05				
35.500	37.500	0.875	CR HSF3 7860 R	CR HSF3 7860 V	CR HSF7 7860 R	CR HSF7 7860 V
901,70	952,50	22,23				
36.000	38.500	0.875	CR HSF3 7890 R	CR HSF3 7890 V	CR HSF7 7890 R	CR HSF7 7890 V
914,40	977,90	22,23				
45.500	47.000	0.812	CR HSF3 9000 R	CR HSF3 9000 V	CR HSF7 9000 R	CR HSF7 9000 V
1 155,70	1 193,80	20,62				

Series HSF4 (split), HSF8 (solid) – Metric sizes

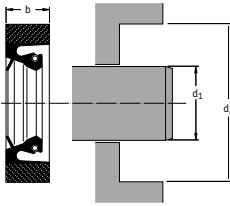

Dimensions			SKF Designation	Solid version (HSF8)
shaft	bore	seal width		
d ₁	d ₂	b	Split version (HSF4) Lip material R Lip material V	Lip material R Lip material V
mm				
75	107	12,5	CR 75×107×12.5 HSF4 R CR 75×107×12.5 HSF4 V	CR 75×107×12.5 HSF8 R CR 75×107×12.5 HSF8 V
105	145	16	CR 105×145×16 HSF4 R CR 105×145×16 HSF4 V	CR 105×145×16 HSF8 R CR 105×145×16 HSF8 V
215	250	16	CR 215×250×16 HSF4 R CR 215×250×16 HSF4 V	CR 215×250×16 HSF8 R CR 215×250×16 HSF8 V
	340	16	CR 300×340×16 HSF4 R CR 300×340×16 HSF4 V	CR 300×340×16 HSF8 R CR 300×340×16 HSF8 V
300	340	16	CR 300×340×16 HSF4 R CR 300×340×16 HSF4 V	CR 300×340×16 HSF8 R CR 300×340×16 HSF8 V
330	374	20	CR 330×374×20 HSF4 R CR 330×374×20 HSF4 V	CR 330×374×20 HSF8 R CR 330×374×20 HSF8 V
370	410	15	CR 370×410×15 HSF4 R CR 370×410×15 HSF4 V	CR 370×410×15 HSF8 R CR 370×410×15 HSF8 V
	420	20	CR 380×420×20 HSF4 R CR 380×420×20 HSF4 V	CR 380×420×20 HSF8 R CR 380×420×20 HSF8 V
380	420	22	CR 380×420×22 HSF4 R CR 380×420×22 HSF4 V	CR 380×420×22 HSF8 R CR 380×420×22 HSF8 V
	490	20	CR 440×490×20 HSF4 R CR 440×490×20 HSF4 V	CR 440×490×20 HSF8 R CR 440×490×20 HSF8 V
440	490	22	CR 440×490×22 HSF4 R CR 440×490×22 HSF4 V	CR 440×490×22 HSF8 R CR 440×490×22 HSF8 V
450	500	22	CR 450×500×22 HSF4 R CR 450×500×22 HSF4 V	CR 450×500×22 HSF8 R CR 450×500×22 HSF8 V
460	500	16	CR 460×500×16 HSF4 R CR 460×500×16 HSF4 V	CR 460×500×16 HSF8 R CR 460×500×16 HSF8 V
500	540	22	CR 500×540×22 HSF4 R CR 500×540×22 HSF4 V	CR 500×540×22 HSF8 R CR 500×540×22 HSF8 V
660	704	20	CR 660×704×20 HSF4 R CR 660×704×20 HSF4 V	CR 660×704×20 HSF8 R CR 660×704×20 HSF8 V

Series HSF4 (split), HSF8 (solid) – Inch sizes

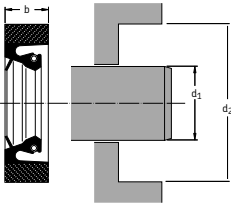

Dimensions			SKF Designation			
shaft	bore	seal width	Split version (HSF4)		Solid version (HSF7)	
d_1	d_2	b	Lip material R	Lip material V	Lip material R	Lip material V
in (mm)						
7.250	5.750	0.625	HSF4 5490 R	HSF4 5490 V	HSF8 5490 R	HSF8 5490 V
184,15	146,05	15,88				
38.000	40.000	0.875	HSF4 7990 R	HSF4 7990 V	HSF8 7990 R	HSF8 7990 V
965,2	1 016	22,23				

Series HSF9 – Metric sizes

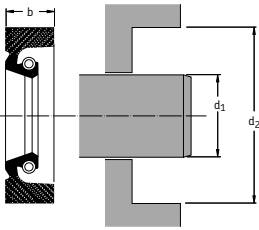

Dimensions			SKF Designation	
shaft	bore	seal width	Lip material	V
d ₁	d ₂	b	R	
mm				
200	240	16,5	CR 200×240×16.5 HSF9 R	CR 200×240×16.5 HSF9 V
335	379	20	CR 335×379×20 HSF9 R	CR 335×379×20 HSF9 V
346	390	18	CR 346×390×18 HSF9 R	CR 346×390×18 HSF9 V
360	404	17,45	CR 360×404×17.45 HSF9 R	CR 360×404×17.45 HSF9 V
480	530	22	CR 480×530×22 HSF9 R	CR 480×530×22 HSF9 V
500	540	20	CR 500×540×20 HSF9 R	CR 500×540×20 HSF9 V
515	555	20	CR 515×555×20 HSF9 R	CR 515×555×20 HSF9 V
600	644	20	CR 600×644×20 HSF9 R	CR 600×644×20 HSF9 V
700	750	25	CR 700×750×25 HSF9 R	CR 700×750×25 HSF9 V
751	814	25,4	CR 751×814×25.4 HSF9 R	CR 751×814×25.4 HSF9 V
840	904	25	CR 840×904×25 HSF9 R	CR 840×904×25 HSF9 V
860	924	25	CR 860×924×25 HSF9 R	CR 860×924×25 HSF9 V

Series HSF9 – Inch sizes

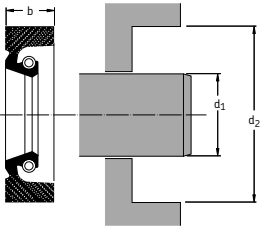

Dimensions			SKF Designation	
shaft	bore	seal width	Lip material	
d_1	d_2	b	R	V
in				
17.875	19.850	0.812	CR HSF9 6715 R	CR HSF9 6715 V
454,03	504,19	20,62		
25.996	28.000	1.000	CR HSF9 7233 R	CR HSF9 7233 V
660,30	711,20	25,40		

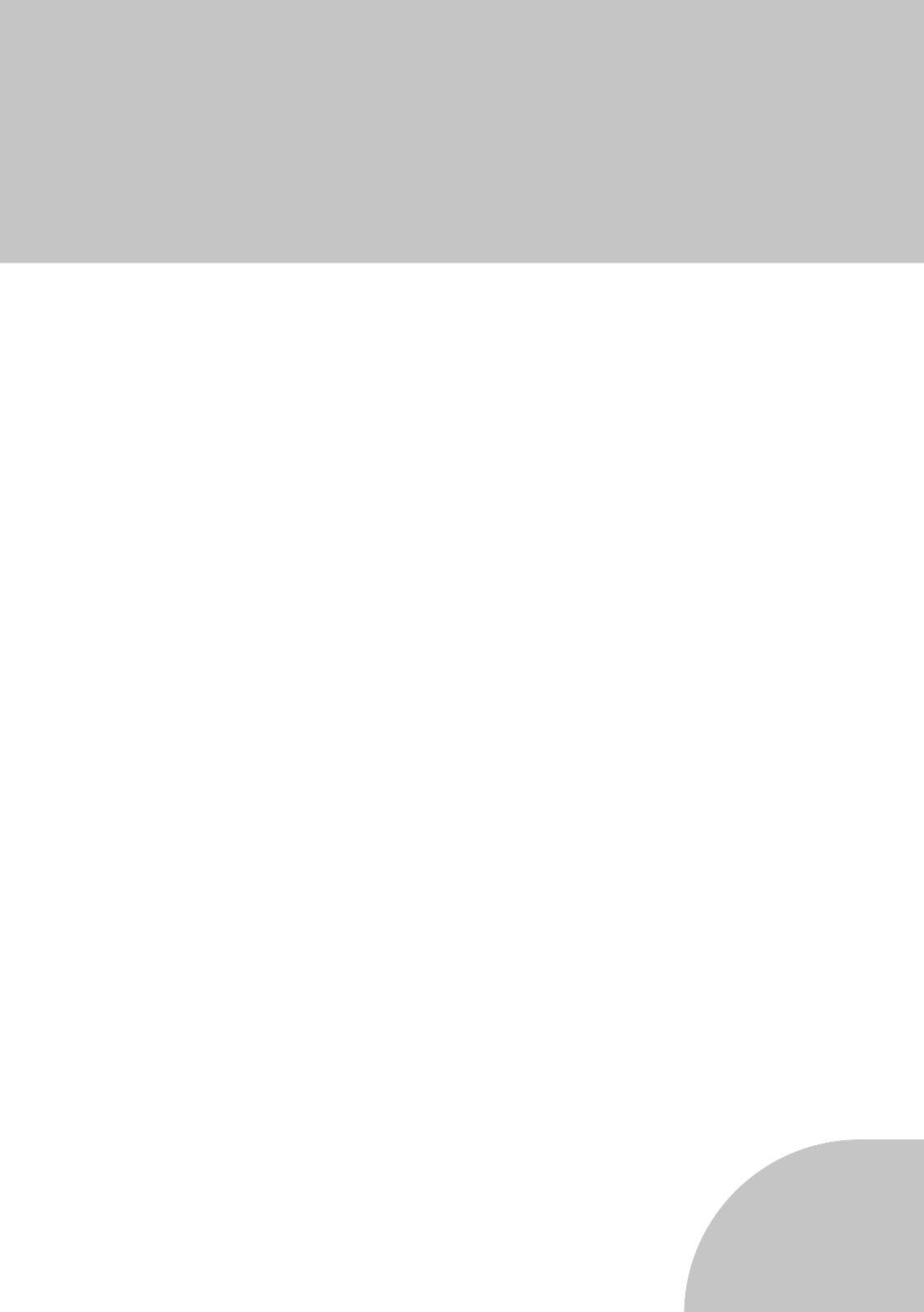

Wear sleeves

Contents

281	Wear sleeves
282	Speedi-Sleeve®
283	Speedi-Sleeve Gold
284	Installation
284	Choosing the right size
285	Mounting Speedi-Sleeve
285	Removal
286	Size listing/metric Speedi-Sleeve
298	Size listing/inch Speedi-Sleeve
310	Large diameter wear sleeves
310	General
310	Product features
311	Use
311	Mounting
311	Dismounting

Wear sleeves

To seal efficiently, radial shaft seals must run against a smooth round surface – the seal counterface. If the counterface becomes worn, and it usually does, then the seal will no longer be able to fulfil its function, which is to retain lubricant and to exclude contaminants – solid particles, liquids as well as moisture.

Normally, the counterface will become grooved as a contaminant particle is caught under the seal lip and generates a track as the shaft rotates. As this continues, the seal will allow more particles to pass or get stuck, and seal efficiency deteriorates, eventually leading to malfunction of the component the seal is meant to protect. To rectify the situation it is necessary to repair the counterface on the shaft – a simple seal replacement will not be sufficient.

To repair the shaft it is usually necessary to dismantle the machine in order to be able to handle the shaft and then to grind down the counter face until it is smooth again. If the grooves are deep the original size of seal will no longer function properly – a seal with a smaller shaft diameter has to be found to match it.

Now there is an easy way to repair the counter face with the shaft still in position and without having to look for a different size of seal. The answer is wear sleeves from SKF.

SKF wear sleeves are available in two different designs, depending on size. One is the extremely thin-walled "Speedi-Sleeve" (**fig 75**), which allows replacement seals of the same size as the original seals to be used. These Speedi-Sleeves are produced for shaft diameters up to and including 203 mm.

For larger shafts, up to approximately 1.150 mm in diameter, SKF produces the LDSLV wear sleeves in two designs: the LDSLV3 (**fig 76**) with a flange, and the LDSLV4 (**fig 77**) without a flange.

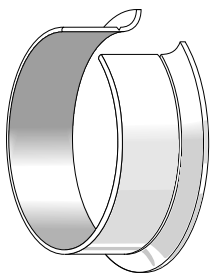

Fig 75

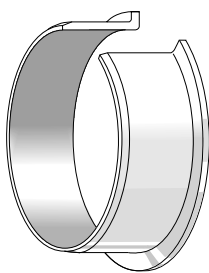

Fig 76

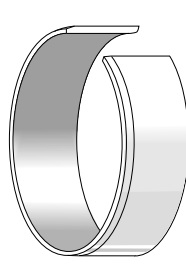

Fig 77

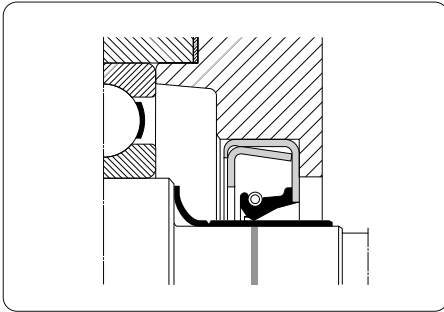

Fig 78

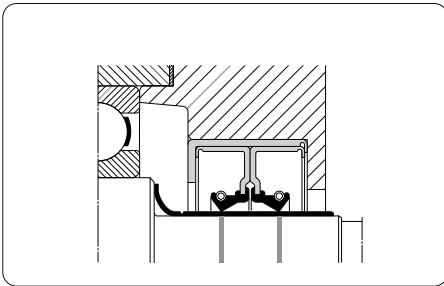

Fig 79

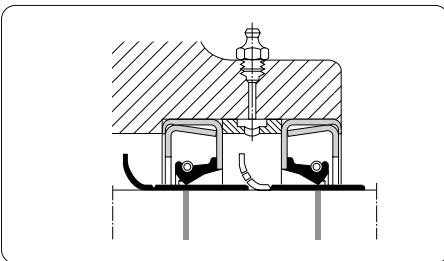

Fig 80

Speedi-Sleeve®

Speedi-Sleeves are made of stainless steel and have a wall thickness of 0,254 mm (0,01 inch). Because of the extreme thinness, the diameter of the seal seating will only be increased by about 0,5 mm so that it is possible to use replacement seals of the same size as the original.

The sleeves have a hardness of 95 HRB and a surface roughness of between 0,25 to 0,5 R_a μm . Thus they often offer a better counter face for the seal lip than the original shaft itself.

Normally, Speedi-Sleeves can be mounted immediately on the cleaned shaft (**fig 78**, **fig 79** and **fig 80**). Only in cases where the shaft exhibits deep grooving or is otherwise damaged is it advisable to first apply powdered metal epoxy filler to the grooves and other damaged areas.

All SKF Speedi-Sleeves have a removable installation flange at one side for easy mounting together with the mounting tool supplied with each sleeve. The flange can be retained to act as a flinger or can be removed easily as a pre-cut tear groove is provided.

Speedi-Sleeve Gold

This is a recent development and embodies all the advantages of the original Speedi-Sleeve. Speedi-Sleeve Gold is equally thin but has a surface hardness of between 80 and 85 HRC and thus is much harder than the standard sleeve. The surface is very resistant to abrasion – being almost on a par with diamond coatings, **Diagram 10**. However, installation is just as easy and again the tool is supplied with the sleeve. Thus for heavy-duty applications it is the preferred choice.

The Speedi-Sleeve Gold has been thoroughly tested to ascertain its degree of abrasion resistance in severe dust environments using both coarse and fine sand. The tests were carried out at temperatures up to 100°C and at shaft speeds of up to 8,6 m/s (28.2 ft/s).

Under these conditions, seals on shafts without Speedi-Sleeve protection started to leak after 450 hours on average. Seals on Speedi-Sleeve Gold ran for an average of 2 500 hours.

In other tests, for example, it was found that continuous salt spray at 40°C produced no trace of corrosion even after 600 hours.

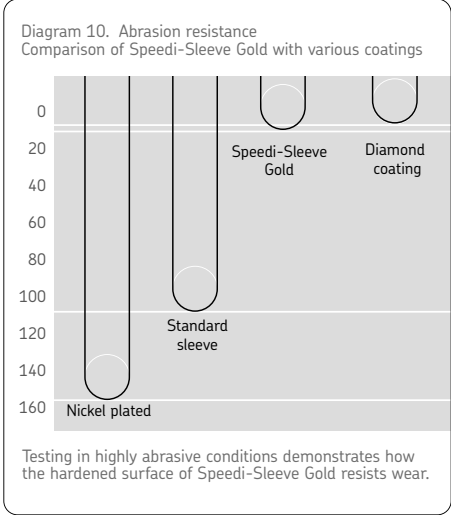

Installation

Although installation is simple, it should be done carefully to achieve the best results.

Before starting, the seal seating on the shaft should be carefully cleaned and any burrs or rough spots should be filed down and polished. Deep wear grooves, scratches or very rough surfaces should be treated with a suitable metallic powder epoxy filler. The sleeve must be positioned on the shaft before the filler has hardened.

It should also be noted that although Speedi-Sleeves can be easily installed within minutes on most shafts, they should not be placed over splines or keyways etc. on the shaft. As the thin-walled sleeve has an interference fit, any disturbances on the shaft surface may create a similar pattern on the sleeve surface and the seal will leak.

Choosing the right size

To determine the appropriate sleeve size it is first necessary to clean the shaft carefully. The diameter of an undamaged section of the seal counterface should then be measured in at least three different planes. The arithmetical mean of these measurements is used to choose a Speedi-Sleeve. If the value lies within the permissible range shown in the product table for the shaft diameter (da) then the Speedi-Sleeve will have an adequately tight fit on the shaft. The sleeve cannot turn on the shaft and no adhesive is required.

If no suitable sleeve is listed in the product table then it will be necessary to rework the shaft to an appropriate dimension. This will also mean that a new size of seal will be required. If production quantities are viable, tailored sleeves can also be produced.

Mounting Speedi-Sleeve

The mounting procedure is as follows (fig 81):

- 1 The final position of the sleeve on the shaft should be determined and marked. The sleeve should cover the wear tracks of the old seal and not just left flush with the shaft end.
- 2 Push the sleeve on to the shaft with the flanged end first. The mounting tool supplied with the sleeve is then pushed on to the sleeve. If the tool is not long enough a length of pipe or tubing with square, deburred ends can be used instead.
- 3 Apply light mallet blows centrally to the mounting tool until the sleeve has been driven up to its final position. Be careful not to damage the outside diameter of the sleeve.
- 4 Remove the flange if necessary. It is important that this is only done after the sleeve has reached its final position. The flange should be cut through to the tear groove after which it can be peeled off along the groove using a pair of tongs. If the flange is not in the way when other parts are being assembled and if it will not foul another component in operation, it is recommended that it be left in position.
- 5 After the sleeve has been installed, check the shaft end again for burrs which could damage the new seal.
- 6 Lightly oil or grease the Speedi-Sleeve surface and, if necessary, the shaft end to ease mounting the seal. Use the same lubricant as that which the seal is to retain.

Removal

A Speedi-Sleeve can be dismantled in one of the following ways; by applying heat to the sleeve; by using a pair of wire cutters starting at or near the flange and applying a twisting action; by “peening” with a small hammer across the full width of the sleeve to expand it or, if accessible, by using a drift on the flange. A Speedi-Sleeve cannot be re-used.

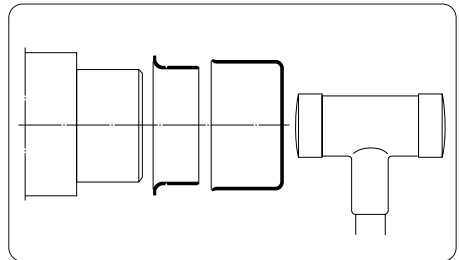
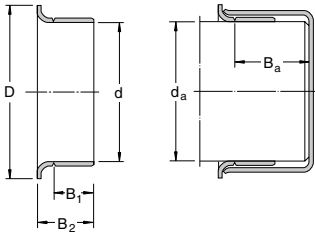

Fig 81

Speedi-Sleeves – Metric sizes



Shaft diameter		Sleeve dimensions					SKF Designation
d_a min	max	d	D ± 0.063	B_1 ± 0.031	B_2 ± 0.031	B_{a1} ¹⁾	
mm		mm					–
11,93	12,07	12,00	15,50	6,00	8,40	47,63	CR 99049
12,65	12,75	12,70	15,50	6,40	8,70	51,00	CR 99050
13,89	14,00	14,00	19,10	6,40	9,90	46,50	CR 99055
14,22	14,38	14,30	19,10	6,40	9,90	47,00	CR 99056
14,96	15,06	15,00	19,10	5,00	9,00	47,30	CR 99059
15,82	15,92	15,88	19,10	8,00	10,30	51,00	CR 99062
	15,93	15,88	19,10	8,00	10,30	50,80	CR 99810*
15,89	16,00	16,00	19,10	8,00	11,10	50,80	CR 99058
16,95	17,05	17,00	27,00	8,00	11,00	51,00	CR 99068
17,32	17,42	17,37	22,90	8,00	11,10	51,00	CR 99060
17,89	18,00	18,00	27,00	8,00	11,00	46,00	CR 99082
19,00	19,10	19,00	24,00	8,00	11,10	50,80	CR 99811*
		19,00	24,00	8,00	11,10	51,00	CR 99076
19,28	19,33	19,30	23,80	8,00	11,10	51,00	CR 99081
19,81	19,91	19,86	23,80	8,00	11,10	51,00	CR 99080
19,95	20,05	20,00	23,60	8,00	11,00	51,00	CR 99078
21,77	21,87	21,82	29,30	6,50	9,50	51,00	CR 99086
21,87	22,00	22,00	30,20	6,60	9,10	47,10	CR 99084
		22,00	30,20	8,00	12,00	46,00	CR 99085
22,17	22,27	22,23	27,80	8,00	11,10	51,00	CR 99087
	22,28	22,23	27,80	8,00	11,10	50,80	CR 99812*
23,06	23,16	23,11	30,90	8,00	11,10	47,00	CR 99091
	23,17	23,11	30,90	8,00	11,10	47,00	CR 99860*
23,87	24,00	24,00	28,70	8,00	11,10	50,80	CR 99092
24,54	24,64	24,59	28,70	8,00	11,10	51,00	CR 99094
		24,59	28,70	15,90	18,30	51,00	CR 99096

* Indicates Speedi-Sleeve Gold
¹⁾ Possible max. distance of rear groove from shaft end when installation tool supplied with sleeve is used

Speedi-Sleeves – Metric sizes

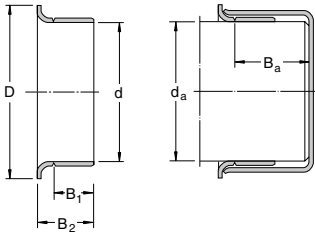

Shaft diameter		Sleeve dimensions					SKF Designation
d_a min	max	d	D ± 0.063	B_1 ± 0.031	B_2 ± 0.031	B_{a1} ¹⁾	
mm		mm					–
24,94	25,04	25,00	33,00	8,00	11,00	50,80	CR 99813*
24,95	25,05	25,00	33,00	8,00	11,00	51,00	CR 99098
25,35	25,45	25,40	31,00	8,00	11,10	50,80	CR 99814*
		25,40	31,00	8,00	11,10	51,00	CR 99100
25,87	26,00	26,00	33,30	8,00	12,00	46,00	CR 99103
26,92	27,03	27,00	33,50	8,00	11,10	47,00	CR 99815*
		27,00	33,50	8,00	11,00	72,00	CR 99106
27,61	27,71	27,66	35,70	8,00	11,10	16,00	CR 99108
27,94	28,04	28,00	34,90	9,50	12,70	72,00	CR 99111
28,52	28,62	28,58	38,10	8,00	11,10	17,00	CR 99816*
		28,58	38,10	8,00	11,10	17,00	CR 99112
28,53	28,63	28,58	38,10	9,50	12,70	17,50	CR 99116
29,31	29,41	29,36	34,30	9,50	12,70	17,00	CR 99120
29,79	29,92	29,85	40,00	8,00	11,10	17,00	CR 99122
29,95	30,07	30,00	35,60	8,00	11,00	17,00	CR 99114
30,10	30,22	30,15	35,60	8,00	11,00	17,00	CR 99118
30,89	31,04	31,00	39,70	8,00	11,00	16,00	CR 99123
31,42	31,57	31,50	39,10	8,00	11,10	17,00	CR 99141
31,67	31,83	31,75	38,10	8,00	11,10	18,00	CR 99817*
		31,75	38,10	8,00	11,10	18,00	CR 99125
31,92	32,08	32,00	38,00	8,00	11,10	18,00	CR 99128
33,23	33,37	33,30	40,60	6,40	9,50	21,00	CR 99129
33,28	33,42	33,35	40,50	12,70	15,90	21,00	CR 99818*
		33,35	40,50	12,70	15,90	21,00	CR 99131
33,84	34,00	34,00	41,30	12,70	15,90	20,70	CR 99134

* Indicates Speedi-Sleeve Gold
¹⁾ Possible max. distance of rear groove from shaft end when installation tool supplied with sleeve is used

Speedi-Sleeves – Metric sizes

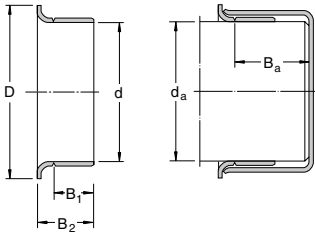

Shaft diameter		Sleeve dimensions					SKF Designation
d_a min	max	d	D ± 0.063	B_1 ± 0.031	B_2 ± 0.031	B_a ¹⁾	
mm		mm					–
34,82	34,98	34,90	41,60	8,00	11,10	21,00	CR 99133
		34,93	41,60	12,70	15,90	21,00	CR 99819*
		34,90	41,60	12,70	15,90	21,00	CR 99138
34,92	35,08	35,00	41,60	13,00	16,00	20,00	CR 99820*
		35,00	41,60	13,00	16,00	20,00	CR 99139
35,86	36,00	36,00	42,90	13,00	17,00	25,00	CR 99146
36,37	36,52	36,45	45,20	14,30	17,50	26,00	CR 99821*
		36,45	45,20	14,30	17,50	26,00	CR 99143
36,45	36,60	36,53	45,20	9,50	12,70	26,00	CR 99144
37,84	38,00	38,00	45,20	13,00	17,00	25,00	CR 99147
38,02	38,18	38,10	45,20	9,50	12,70	26,00	CR 99823*
		38,10	45,20	9,50	12,70	26,00	CR 99150
		38,10	45,20	14,30	17,50	26,00	CR 99822*
		38,10	45,20	14,30	17,50	26,00	CR 99149
38,61	38,76	38,68	47,20	11,10	14,30	26,00	CR 99152
39,35	39,49	39,42	47,20	11,10	14,30	26,00	CR 99155
39,60	39,74	39,67	47,20	14,30	17,50	26,00	CR 99824*
		39,67	47,20	14,30	17,50	26,00	CR 99156
39,77	39,93	39,85	47,20	16,00	19,10	26,00	CR 99159
39,84	40,00	40,00	46,90	9,90	12,90	25,40	CR 99153
39,92	40,08	40,00	47,00	13,00	16,00	26,00	CR 99825*
		40,00	47,00	13,00	16,00	26,00	CR 99157
40,69	40,84	40,77	49,20	12,70	16,30	25,00	CR 99160
40,84	41,00	41,00	49,20	12,70	15,90	25,80	CR 99163
41,20	41,35	41,28	47,60	8,00	11,10	26,00	CR 99161
41,21	41,35	41,28	47,60	14,30	17,50	21,00	CR 99826*
		41,28	47,60	14,30	17,50	21,00	CR 99162

* Indicates Speedi-Sleeve Gold
¹⁾ Possible max. distance of rear groove from shaft end when installation tool supplied with sleeve is used

Speedi-Sleeves – Metric sizes

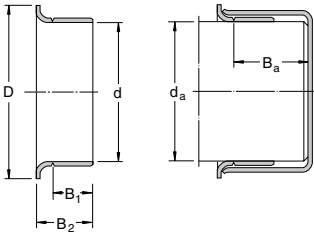

Shaft diameter		Sleeve dimensions					SKF Designation
d_a min	max	d	D ± 0.063	B_1 ± 0.031	B_2 ± 0.031	$B_a^{1)}$	
mm		mm					–
41,84	42,00	42,00	53,00	11,30	14,50	21,00	CR 99166
		42,00	53,00	14,30	17,50	21,00	CR 99169
41,98	42,14	42,06	53,00	14,00	17,50	21,00	CR 99165
42,77	42,93	42,85	48,40	14,30	17,50	22,00	CR 99168
42,80	42,95	42,88	48,40	8,00	11,10	22,00	CR 99167
42,84	43,00	43,00	48,40	12,70	15,90	21,40	CR 99182
43,56	43,71	43,64	51,60	14,30	17,50	21,00	CR 99971
44,09	44,25	44,17	52,40	9,50	12,70	21,00	CR 99170
44,37	44,53	44,45	52,40	13,50	15,90	22,30	CR 99180
		44,45	52,40	14,30	17,50	21,00	CR 99827*
		44,45	52,40	14,30	17,50	21,00	CR 99174
		44,45	52,40	19,00	22,20	21,00	CR 99828*
		44,45	52,40	19,00	22,20	21,00	CR 99175
		44,45	52,50	9,50	12,70	21,00	CR 99172
		44,45	52,50	9,50	12,70	21,00	CR 99172
44,73	44,87	44,80	52,40	14,30	17,50	21,00	CR 99829*
		44,80	52,40	14,30	17,50	21,00	CR 99176
44,92	45,08	45,00	53,00	14,00	17,00	21,00	CR 99830*
		45,00	53,00	14,00	17,00	21,00	CR 99177
45,16	45,31	45,24	54,00	17,20	20,30	27,00	CR 99179
45,95	46,10	46,00	53,10	14,30	17,50	26,00	CR 99181
		46,05	53,10	14,30	17,50	26,00	CR 99831*
47,17	47,32	47,24	54,80	14,30	17,50	25,00	CR 99185
47,40	47,55	47,45	55,60	22,60	26,00	25,00	CR 99186
47,55	47,70	47,63	56,00	4,50	7,50	19,00	CR 99190
		47,63	56,00	7,50	10,50	19,00	CR 99188
		47,63	56,00	9,50	13,10	27,00	CR 99184
		47,63	56,00	14,30	17,50	25,40	CR 99832*
		47,63	56,00	14,30	17,50	25,00	CR 99187
47,92	48,08	48,00	56,00	14,00	17,00	25,00	CR 99189

* Indicates Speedi-Sleeve Gold
1) Possible max. distance of rear groove from shaft end when installation tool supplied with sleeve is used

Speedi-Sleeves – Metric sizes

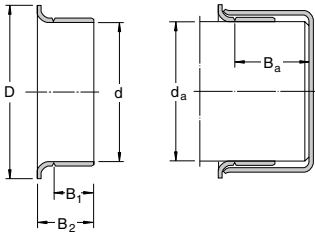

Shaft diameter		Sleeve dimensions					SKF Designation
d_a min	max	d	D ± 0.063	B_1 ± 0.031	B_2 ± 0.031	B_a ¹⁾	
mm		mm					–
48,49	48,64	48,56	56,40	9,50	12,70	25,00	CR 99192
49,12	49,28	49,20	56,40	14,30	17,50	25,00	CR 99193
		49,23	56,40	14,30	17,50	25,40	CR 99833*
49,92	50,08	50,00	57,00	14,00	17,00	25,00	CR 99196
50,22	50,37	50,30	58,70	14,30	17,90	27,00	CR 99198
50,72	50,88	50,80	61,10	14,30	17,50	25,40	CR 99834*
		50,80	61,10	22,20	25,40	25,40	CR 99835*
50,73	50,87	50,80	61,10	14,30	17,50	25,00	CR 99199
		50,80	61,10	22,20	25,40	25,00	CR 99200
51,81	52,00	52,00	62,70	12,70	15,90	34,50	CR 99204
53,95	54,10	54,00	61,50	12,70	19,00	33,00	CR 99210
		54,00	61,50	19,80	23,80	35,00	CR 99212
		54,00	62,00	20,00	24,00	35,00	CR 99836*
54,92	55,08	55,00	62,00	20,00	23,00	32,00	CR 99215
		55,09	62,00	20,00	23,00	32,00	CR 99863*
55,32	55,47	55,40	64,00	20,00	24,00	38,10	CR 99217
55,52	55,68	55,60	63,50	19,80	23,80	33,00	CR 99218
55,81	56,00	56,00	64,30	12,70	15,90	33,40	CR 99220
56,56	56,72	56,64	64,30	12,70	15,90	33,00	CR 99229
		56,64	64,30	19,80	23,00	32,00	CR 99230
56,57	56,72	56,64	64,30	12,70	15,90	33,40	CR 99861*
56,82	56,97	56,90	65,10	19,40	22,90	32,00	CR 99226
57,12	57,28	57,20	64,30	8,00	11,10	33,00	CR 99227
		57,20	64,30	19,80	23,80	33,00	CR 99225
57,13	57,28	57,15	64,30	8,00	11,10	33,40	CR 99838*
		57,15	64,30	19,80	23,80	33,40	CR 99837*
58,65	58,80	58,72	68,30	19,80	23,80	35,00	CR 99231

* Indicates Speedi-Sleeve Gold
¹⁾ Possible max. distance of rear groove from shaft end when installation tool supplied with sleeve is used

Speedi-Sleeves – Metric sizes

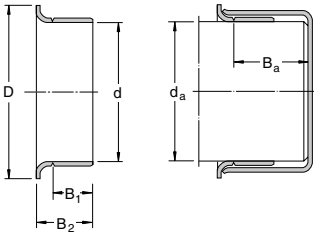

Shaft diameter		Sleeve dimensions					SKF Designation
d_a min	max	d	D ± 0.063	B_1 ± 0.031	B_2 ± 0.031	B_a ¹⁾	
mm		mm					–
59,10	59,26	59,18	69,80	19,00	22,20	38,00	CR 99233
59,92	60,07	60,00	70,70	9,40	11,40	37,40	CR 99241
		60,00	70,70	20,00	23,00	35,00	CR 99235
60,25	60,40	60,33	69,90	15,10	19,10	35,00	CR 99238
60,30	60,45	60,33	69,90	19,80	23,80	35,00	CR 99839*
60,31	60,45	60,38	69,90	13,40	17,30	35,00	CR 99240
		60,38	69,90	19,80	23,80	35,00	CR 99237
61,83	61,97	61,90	71,80	19,80	23,80	35,30	CR 99243
61,81	62,00	62,00	71,80	12,70	15,90	36,20	CR 99244
61,85	62,00	62,00	71,80	12,70	15,90	36,00	CR 99242
63,23	63,37	63,30	73,00	19,80	23,80	35,00	CR 99249
63,42	63,58	63,50	71,60	14,10	16,50	23,00	CR 99253
63,50	63,65	63,50	71,80	12,70	16,70	35,00	CR 99248
		63,50	71,60	19,80	23,80	35,00	CR 99840*
		63,50	71,60	19,80	23,80	35,00	CR 99250
63,75	63,91	63,83	71,80	19,80	23,00	37,00	CR 99251
64,92	65,08	65,00	72,40	20,00	23,00	35,00	CR 99254
	65,75	65,00	72,40	20,00	23,00	35,00	CR 99841*
65,02	65,18	65,10	73,40	19,80	23,80	35,00	CR 99256
65,92	66,07	66,00	76,00	19,80	23,80	32,00	CR 99259
66,50	66,64	66,57	77,40	19,80	23,80	35,00	CR 99261
66,57	66,73	66,65	77,40	19,80	23,00	35,00	CR 99264
66,60	66,75	66,68	77,40	12,70	15,90	35,00	CR 99260
66,68	66,82	66,75	77,40	19,80	23,80	35,00	CR 99262
	66,83	66,78	77,40	19,80	23,80	35,00	CR 99842*
67,81	68,00	68,00	79,40	19,10	22,20	42,90	CR 99266

* Indicates Speedi-Sleeve Gold
¹⁾ Possible max. distance of rear groove from shaft end when installation tool supplied with sleeve is used

Speedi-Sleeves – Metric sizes

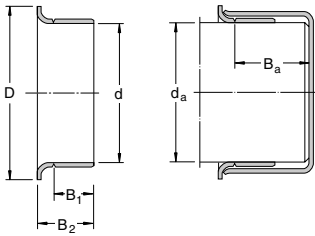

Shaft diameter		Sleeve dimensions					SKF Designation
d_a min	max	d	D ± 0.063	B_1 ± 0.031	B_2 ± 0.031	B_a ¹⁾	
mm		mm					–
69,26	69,42	69,34	79,40	19,80	23,00	33,00	CR 99268
69,60	69,74	69,67	77,90	19,80	23,80	32,00	CR 99273
69,72	69,88	69,80	79,40	19,80	23,80	32,00	CR 99844*
		69,80	79,40	19,80	23,80	32,00	CR 99274
69,77	69,93	69,85	78,10	36,50	41,30	41,00	CR 99267
69,85	70,00	70,00	79,40	19,80	23,80	32,00	CR 99844*
		70,00	79,40	19,80	23,80	32,00	CR 99275
		70,00	79,40	28,60	31,80	32,00	CR 99269
69,92	70,08	70,00	79,40	10,30	14,30	32,00	CR 99272
		70,00	79,40	20,00	24,00	32,00	CR 99276
71,35	71,50	71,42	80,90	15,10	17,50	32,00	CR 99281
71,81	72,00	72,00	81,90	19,10	22,20	34,10	CR 99284
72,08	72,24	72,16	81,90	12,70	16,70	32,00	CR 99282
72,09	72,24	72,09	81,90	12,70	16,70	32,00	CR 99845*
72,80	72,94	72,87	81,00	19,80	23,80	32,00	CR 99286
72,97	73,13	73,00	81,80	19,80	23,80	32,00	CR 99846*
		73,00	81,80	19,80	23,80	32,00	CR 99287
74,60	74,75	74,68	84,90	12,70	16,30	33,00	CR 99290
		74,63	84,90	19,80	23,80	33,40	CR 99847*
		74,68	84,90	19,80	23,80	33,00	CR 99293
74,92	75,08	75,00	83,10	15,10	17,50	28,00	CR 99289
		75,00	84,00	22,00	26,00	33,00	CR 99294
75,49	75,59	75,54	82,20	20,60	25,40	32,00	CR 99292
75,95	76,10	76,00	85,10	20,60	25,40	33,00	CR 99299
		76,00	85,30	12,30	15,90	34,00	CR 99291
		76,00	85,30	14,30	17,50	35,00	CR 99298
76,12	76,28	76,20	82,30	20,60	23,80	35,00	CR 99296

* Indicates Speedi-Sleeve Gold
¹⁾ Possible max. distance of rear groove from shaft end when installation tool supplied with sleeve is used

Speedi-Sleeves – Metric sizes

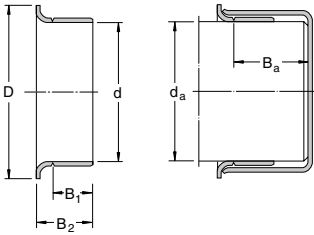

Shaft diameter		Sleeve dimensions					SKF Designation
d_a min	max	d	D ± 0.063	B_1 ± 0.031	B_2 ± 0.031	$B_a^{1)}$	
mm		mm					–
76,20	76,35	76,20	82,20	20,60	25,40	32,60	CR 99848*
		76,28	82,20	20,60	25,40	33,00	CR 99300
	76,40	76,28	85,00	15,90	20,60	27,00	CR 99303
76,40	76,56	76,48	85,20	12,70	15,80	51,00	CR 99301
77,81	78,00	78,00	88,10	19,50	22,20	52,30	CR 99306
79,24	79,40	79,32	89,70	17,50	20,60	51,00	CR 99311
79,25	79,40	79,38	89,70	20,60	25,40	50,80	CR 99849*
		79,32	89,70	20,60	25,40	51,00	CR 99312
79,35	79,55	79,44	89,50	14,00	18,00	52,00	CR 99307
79,81	80,01	80,00	89,90	19,10	22,50	35,00	CR 99313
79,92	80,08	80,00	90,00	11,00	15,00	35,00	CR 99317
		80,00	90,00	21,00	24,00	35,00	CR 99315
81,92	82,07	82,00	91,10	16,80	21,60	44,00	CR 99328
82,47	82,63	82,55	91,30	20,60	25,40	35,00	CR 99322
82,50	82,70	82,50	90,80	15,10	18,30	35,00	CR 99850*
82,55	82,70	82,63	90,80	15,10	18,30	35,00	CR 99324
		82,63	91,10	17,50	22,20	32,00	CR 99326
		82,70	91,10	20,60	25,40	35,00	CR 99851*
		82,63	91,10	20,60	25,40	35,00	CR 99325
84,00	84,15	84,00	93,70	20,60	25,40	35,00	CR 99331
84,76	85,02	85,00	94,00	17,00	21,00	35,00	CR 99332
84,78	85,00	85,00	93,90	10,10	12,70	36,40	CR 99334
		85,00	94,00	21,00	25,00	35,00	CR 99333
85,67	85,83	85,75	93,70	9,50	12,70	36,00	CR 99338
		85,75	93,90	20,60	25,40	35,00	CR 99337
87,25	87,40	87,33	97,60	19,80	23,00	36,00	CR 99339
88,31	88,47	88,39	97,40	19,80	23,00	36,00	CR 99340

* Indicates Speedi-Sleeve Gold
1) Possible max. distance of rear groove from shaft end when installation tool supplied with sleeve is used

Speedi-Sleeves – Metric sizes

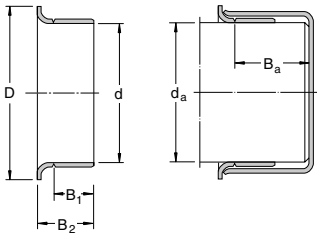

Shaft diameter		Sleeve dimensions					SKF Designation
d_a min	max	d	D ± 0.063	B_1 ± 0.031	B_2 ± 0.031	$B_a^{1)}$	
mm		mm					–
88,82	88,98	88,98	97,60	16,00	20,60	34,20	CR 99346
88,90	89,05	89,00	97,20	8,00	12,70	34,00	CR 99347
		89,00	97,60	20,60	25,40	34,20	CR 99852*
		89,00	97,60	20,60	25,40	34,00	CR 99350
88,93	89,08	89,00	97,60	15,90	20,60	34,00	CR 99349
89,92	90,08	90,00	101,60	11,00	13,70	46,00	CR 99352
		90,00	101,60	13,40	16,90	44,00	CR 99353
		90,00	101,60	18,00	23,00	46,00	CR 99351
		90,00	101,60	23,00	28,00	44,00	CR 99354
90,42	90,58	90,50	99,10	20,60	25,40	44,00	CR 99356
91,90	92,05	92,00	102,40	20,60	25,40	44,00	CR 99360
92,02	92,18	92,10	102,20	12,70	15,90	45,00	CR 99363
		92,10	102,40	20,60	25,40	44,00	CR 99362
93,57	93,73	93,65	97,30	8,00	11,10	22,00	CR 99368
93,60	93,75	93,68	102,20	20,60	23,80	45,00	CR 99365
94,66	94,82	94,74	102,20	19,80	23,00	45,00	CR 99366
94,67	94,82	94,74	102,00	12,00	15,10	44,00	CR 99359
94,92	95,08	95,00	102,20	21,00	24,00	44,00	CR 99369
94,99	95,15	95,00	102,50	12,00	15,10	45,00	CR 99364
95,00	95,15	95,00	102,40	8,70	12,70	44,00	CR 99374
95,14	95,30	95,22	102,20	14,30	17,50	45,00	CR 99376
		95,25	102,10	17,50	22,20	45,70	CR 99853*
95,26	95,40	95,33	102,10	17,50	22,20	48,00	CR 99372
		95,33	102,20	8,70	12,70	44,00	CR 99367
98,25	98,40	98,32	106,30	20,60	25,40	48,00	CR 99386
98,37	98,53	98,45	107,20	20,60	25,40	48,00	CR 99387

* Indicates Speedi-Sleeve Gold
1) Possible max. distance of rear groove from shaft end when installation tool supplied with sleeve is used

Speedi-Sleeves – Metric sizes

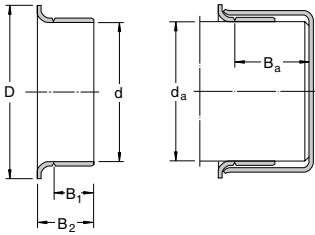

Shaft diameter		Sleeve dimensions					SKF Designation
d_a min	max	d	D ± 0.063	B_1 ± 0.031	B_2 ± 0.031	$B_a^{1)}$	
mm		mm					–
99,95	100,10	100,00	109,60	20,60	25,40	52,00	CR 99854*
		100,00	110,00	20,60	25,40	52,00	CR 99393
101,55	101,75	101,60	111,10	20,60	25,40	52,00	CR 99855*
		101,65	111,10	12,70	15,90	52,00	CR 99401
		101,65	111,10	15,20	18,40	52,00	CR 99395
		101,65	111,10	16,50	19,70	35,00	CR 99400
103,90	104,10	104,00	112,70	20,00	24,00	36,00	CR 99409
		104,80	113,50	20,60	25,40	35,00	CR 99412
104,90	105,10	105,00	113,50	20,00	23,20	35,00	CR 99413
106,25	106,45	106,35	114,30	20,60	25,40	35,00	CR 99418
107,34	107,54	107,44	117,10	19,80	23,00	37,00	CR 99423
107,90	108,10	108,00	117,10	20,60	25,40	37,00	CR 99424
109,78	110,00	110,00	124,90	11,40	14,50	32,90	CR 99434
109,90	110,10	110,00	125,00	12,90	16,50	32,00	CR 99435
111,00	111,20	111,00	120,70	20,60	25,40	42,00	CR 99437
111,80	112,00	112,00	120,70	19,00	22,50	27,00	CR 99438
112,62	112,83	112,72	122,20	25,40	29,00	33,00	CR 99439
114,12	114,40	114,30	124,50	20,60	25,40	32,00	CR 99856*
114,20	114,40	114,30	124,50	20,60	25,40	32,00	CR 99450
114,90	115,10	115,00	127,00	20,60	23,80	32,00	CR 99452
117,37	117,57	117,48	128,60	25,40	31,80	35,00	CR 99463
		117,58	127,00	11,10	15,80	35,00	CR 99465
119,00	119,20	119,00	128,60	20,60	25,40	35,00	CR 99468
		120,00	129,80	8,00	11,00	33,00	CR 99471
		120,00	129,80	20,00	25,00	32,00	CR 99473
120,55	120,75	120,65	127,00	12,70	19,00	38,00	CR 99475

* Indicates Speedi-Sleeve Gold
1) Possible max. distance of rear groove from shaft end when installation tool supplied with sleeve is used

Speedi-Sleeves – Metric sizes

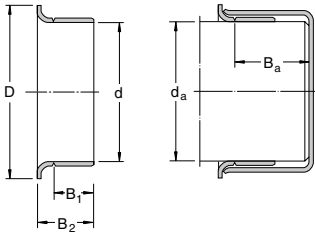

Shaft diameter		Sleeve dimensions					SKF Designation
d_a min	max	d	D ± 0.063	B_1 ± 0.031	B_2 ± 0.031	B_{a1} ¹⁾	
mm		mm					–
121,89	122,10	122,00	131,50	20,00	24,00	32,00	CR 99472
122,90	123,10	123,00	132,80	20,00	25,00	31,00	CR 99484
123,72	123,93	123,83	133,40	15,90	19,10	37,00	CR 99487
124,90	125,10	125,00	137,20	10,00	14,00	37,00	CR 99490
		125,00	137,20	26,00	32,00	37,00	CR 99492
126,95	127,15	127,00	137,20	13,70	17,30	37,00	CR 99501
		127,00	137,20	17,50	22,20	37,00	CR 99857*
		127,00	137,20	17,50	22,20	37,00	CR 99498
		127,00	139,90	20,60	25,40	37,00	CR 99858*
		127,00	136,90	20,60	25,40	37,00	CR 99499
129,79	130,00	130,00	139,50	19,00	24,00	30,00	CR 99494
129,98	130,18	130,00	139,50	22,00	25,30	33,00	CR 99491
130,05	130,25	130,15	139,70	20,60	25,40	32,00	CR 99513
133,25	133,45	133,35	141,20	20,60	25,40	32,00	CR 99525
134,79	135,00	135,00	149,20	20,50	25,40	32,00	CR 99533
136,42	136,62	136,53	149,20	20,60	25,40	32,00	CR 99537
138,02	138,23	138,13	146,10	38,10	42,90	48,00	CR 99548
139,00	139,20	139,00	154,90	14,30	19,10	24,00	CR 99547
139,65	139,85	139,70	150,80	20,60	25,40	32,00	CR 99859*
		139,75	150,80	13,20	17,90	32,00	CR 99550
		139,75	150,80	20,60	25,40	32,00	CR 99549
139,90	140,10	140,00	151,00	20,50	25,50	32,00	CR 99552
142,77	142,98	142,88	157,20	22,20	25,40	46,00	CR 99560
144,75	145,00	145,00	149,90	19,50	22,20	46,00	CR 99571
145,44	145,64	145,54	149,90	14,30	19,10	49,20	CR 99562
145,95	146,15	146,05	157,00	20,60	25,40	44,00	CR 99575

* Indicates Speedi-Sleeve Gold
¹⁾ Possible max. distance of rear groove from shaft end when installation tool supplied with sleeve is used

Speedi-Sleeves – Metric sizes

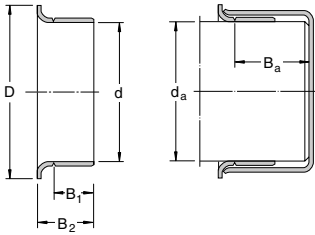

Shaft diameter		Sleeve dimensions					SKF Designation
d_a min	max	d	D ± 0.063	B_1 ± 0.031	B_2 ± 0.031	B_{a1} ¹⁾	
mm		mm					–
149,12	149,33	149,23 149,23	157,20 157,20	25,40 25,40	31,80 31,80	33,00 33,00	CR 99862* CR 99587
149,75	150,00	150,00	159,00	26,00	30,00	34,00	CR 99595
150,73	150,93	150,83	161,90	25,40	28,60	48,00	CR 99596
152,27	152,47	152,37 152,37	161,50 161,90	12,70 25,40	19,00 31,80	44,00 44,00	CR 99601 CR 99599
153,87	154,13	154,00	161,90	26,00	30,00	33,00	CR 99605
154,75	155,00	155,00	167,00	26,00	30,00	33,00	CR 99606
157,43	157,68	157,56	168,30	20,60	27,00	44,00	CR 99620
158,62	158,88	158,75	168,30	26,20	31,80	44,00	CR 99625
159,74	169,00	160,00	177,80	25,40	31,80	35,00	CR 99630
164,97	165,23	165,10	177,80	25,40	31,80	35,00	CR 99650
169,75	170,00	170,00	182,60	31,80	38,00	44,50	CR 99640
171,32	171,58	171,45	181,00	20,60	27,00	44,00	CR 99675
174,75	175,00	175,00	187,00	28,00	32,00	35,00	CR 99687
177,67	177,93	177,80	189,90	25,40	31,80	43,00	CR 99700
179,79	180,00	180,00	190,50	33,00	38,00	45,00	CR 99721
184,00	184,25	184,00	197,10	31,70	38,10	55,00	CR 99725
184,73	185,00	185,00	199,00	32,00	38,00	55,00	CR 99726
189,08	189,33	189,20	199,60	20,60	25,40	32,00	CR 99745
190,37	190,63	190,50	200,00	20,60	25,40	32,00	CR 99750
196,72	196,98	196,85	210,10	25,40	33,30	48,00	CR 99775
199,87	200,13	200,00	212,70	34,50	38,10	44,00	CR 99787
201,50	201,75	201,63	212,70	25,40	31,80	44,00	CR 99799
203,07	203,33	203,20	212,70	25,40	31,80	44,00	CR 99800

* Indicates Speedi-Sleeve Gold
¹⁾ Possible max. distance of rear groove from shaft end when installation tool supplied with sleeve is used

Speedi-Sleeves – Inch sizes

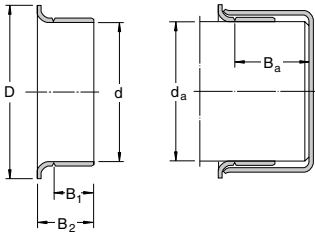

Shaft diameter		Sleeve dimensions					SKF Designation
d_a min	max	d	D ± 0.063	B_1 ± 0.031	B_2 ± 0.031	$B_a^{1)}$	
in		in					–
0.469	0.475	0.472	0.610	0.236	0.331	1.875	CR 99049
0.498	0.502	0.500	0.610	0.250	0.344	2.000	CR 99050
0.547	0.551	0.551	0.752	0.251	0.389	1.831	CR 99055
0.560	0.566	0.563	0.750	0.250	0.391	1.831	CR 99056
0.589	0.593	0.591	0.750	0.197	0.354	1.862	CR 99059
0.623	0.627	0.625	0.750	0.313	0.406	2.000	CR 99810*
		0.625	0.750	0.313	0.406	2.000	CR 99062
0.624	0.630	0.630	0.752	0.315	0.437	2.000	CR 99058
0.667	0.671	0.669	1.063	0.313	0.433	2.000	CR 99068
0.682	0.686	0.684	0.900	0.313	0.438	2.000	CR 99060
0.704	0.709	0.706	1.063	0.315	0.433	1.811	CR 99082
0.748	0.752	0.750	0.945	0.313	0.438	2.000	CR 99871*
		0.750	0.945	0.313	0.438	2.000	CR 99076
0.759	0.761	0.760	0.938	0.313	0.438	2.000	CR 99081
0.780	0.784	0.781	0.935	0.313	0.438	2.000	CR 99080
0.785	0.789	0.787	0.930	0.313	0.133	2.000	CR 99078
0.857	0.861	0.859	1.155	0.250	0.375	2.000	CR 99086
0.861	0.866	0.866	1.189	0.260	0.358	1.854	CR 99084
		0.866	1.188	0.315	0.472	1.813	CR 99085
0.873	0.877	0.875	1.094	0.313	0.438	2.000	CR 99812*
		0.875	1.094	0.313	0.438	2.000	CR 99087
0.908	0.912	0.910	1.218	0.313	0.438	1.847	CR 99860*
		0.910	1.218	0.313	0.438	1.847	CR 99091
0.940	0.945	0.945	1.130	0.315	0.437	2.000	CR 99092
0.966	0.970	0.969	1.130	0.313	0.438	2.000	CR 99094
		0.969	1.130	0.625	0.719	2.000	CR 99096

* Indicates Speedi-Sleeve Gold
1) Possible max. distance of rear groove from shaft end when installation tool supplied with sleeve is used

Speedi-Sleeves – Inch sizes

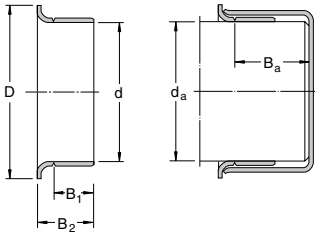

Shaft diameter		Sleeve dimensions					SKF Designation
d_a min	max	d	D ± 0.063	B_1 ± 0.031	B_2 ± 0.031	B_a ¹⁾	
in		in					–
0.982	0.986	0.984	1.300	0.313	0.433	2.000	CR 99813*
		0.984	1.300	0.313	0.433	2.000	CR 99098
0.998	1.002	1.000	1.219	0.313	0.438	2.000	CR 99814*
		1.000	1.219	0.313	0.438	2.000	CR 99100
1.019	1.024	1.024	1.312	0.313	0.472	1.813	CR 99103
1.060	1.064	1.063	1.320	0.313	0.438	1.843	CR 99815*
		1.063	1.320	0.313	0.438	2.813	CR 99106
1.087	1.091	1.089	1.406	0.313	0.438	0.625	CR 99108
1.100	1.104	1.102	1.375	0.375	0.500	1.843	CR 99111
1.123	1.127	1.125	1.500	0.313	0.438	0.688	CR 99816*
		1.125	1.500	0.313	0.438	0.688	CR 99112
		1.125	1.500	0.375	0.500	0.688	CR 99116
1.154	1.158	1.156	1.350	0.375	0.500	0.688	CR 99120
1.173	1.178	1.175	1.575	0.313	0.438	0.688	CR 99122
1.179	1.184	1.181	1.400	0.315	0.433	0.688	CR 99114
1.185	1.190	1.188	1.400	0.313	0.438	0.688	CR 99118
1.216	1.222	1.219	1.563	0.313	0.433	0.625	CR 99123
1.237	1.243	1.240	1.540	0.315	0.438	0.688	CR 99141
1.247	1.253	1.250	1.500	0.313	0.438	0.688	CR 99817*
		1.250	1.500	0.313	0.438	0.688	CR 99125
1.257	1.263	1.260	1.500	0.315	0.438	0.688	CR 99128
1.308	1.314	1.313	1.600	0.250	0.375	0.813	CR 99129
1.310	1.316	1.313	1.594	0.500	0.625	0.813	CR 99818*
		1.313	1.594	0.500	0.625	0.813	CR 99131
1.332	1.339	1.339	1.625	0.500	0.625	0.815	CR 99134

* Indicates Speedi-Sleeve Gold
¹⁾ Possible max. distance of rear groove from shaft end when installation tool supplied with sleeve is used

Speedi-Sleeves – Inch sizes

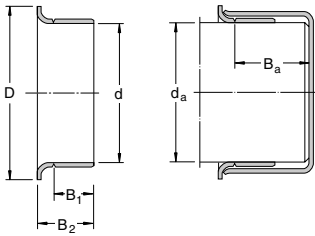

Shaft diameter		Sleeve dimensions					SKF Designation
d_a min	max	d	D ± 0.063	B_1 ± 0.031	B_2 ± 0.031	$B_a^{1)}$	
in		in					–
1.371	1.377	1.375	1.638	0.313	0.438	0.813	CR 99133
		1.375	1.638	0.500	0.625	0.813	CR 99819*
		1.375	1.638	0.500	0.625	0.813	CR 99138
1.375	1.381	1.375	1.638	0.512	0.630	0.813	CR 99820*
		1.375	1.638	0.512	0.630	0.813	CR 99139
1.412	1.417	1.417	1.781	0.512	0.669	0.984	CR 99146
1.432	1.438	1.438	1.781	0.563	0.688	1.016	CR 99821*
		1.438	1.781	0.563	0.688	1.016	CR 99143
1.435	1.441	1.438	1.781	0.375	0.500	1.016	CR 99144
1.490	1.496	1.496	1.781	0.512	0.669	0.984	CR 99147
1.497	1.503	1.500	1.781	0.375	0.500	1.016	CR 99823*
		1.500	1.781	0.375	0.500	1.016	CR 99150
		1.500	1.781	0.563	0.688	1.016	CR 99822*
		1.500	1.781	0.563	0.688	1.016	CR 99149
1.520	1.526	1.523	1.859	0.438	0.563	1.016	CR 99152
1.549	1.555	1.552	1.859	0.438	0.563	1.016	CR 99155
1.559	1.565	1.563	1.859	0.563	0.688	1.016	CR 99824*
		1.563	1.859	0.563	0.688	1.016	CR 99156
1.566	1.572	1.569	1.859	0.625	0.750	1.016	CR 99159
1.569	1.575	1.575	1.846	0.389	0.508	1.000	CR 99153
		1.578	1.850	0.512	0.630	1.023	CR 99825*
1.572	1.578	1.578	1.850	0.512	0.630	1.023	CR 99157
		1.605	1.938	0.500	0.641	1.000	CR 99160
1.608	1.614	1.614	1.937	0.500	0.625	1.016	CR 99163
		1.625	1.875	0.313	0.438	1.016	CR 99161
1.622	1.628	1.625	1.875	0.563	0.688	0.813	CR 99826*
		1.625	1.875	0.563	0.688	0.813	CR 99162

* Indicates Speedi-Sleeve Gold
¹⁾ Possible max. distance of rear groove from shaft end when installation tool supplied with sleeve is used

Speedi-Sleeves – Inch sizes

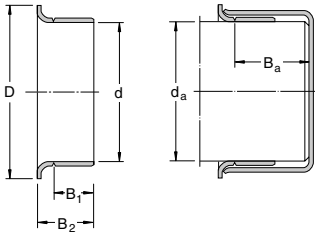

Shaft diameter		Sleeve dimensions					SKF Designation
d_a min	max	d	D ± 0.063	B_1 ± 0.031	B_2 ± 0.031	$B_a^{1)}$	
in		in					–
1.647	1.653	1.650	2.087	0.445	0.571	0.846	CR 99166
		1.650	2.087	0.563	0.689	0.827	CR 99169
1.653	1.659	1.656	2.087	0.550	0.689	0.827	CR 99165
1.684	1.690	1.688	1.906	0.563	0.688	0.875	CR 99168
1.685	1.691	1.688	1.906	0.313	0.438	0.875	CR 99167
1.687	1.693	1.693	1.906	0.500	0.625	0.843	CR 99182
1.715	1.721	1.719	2.031	0.563	0.688	0.813	CR 99171
1.736	1.742	1.739	2.063	0.375	0.500	0.813	CR 99170
1.747	1.753	1.750	2.055	0.375	0.500	0.813	CR 99172
		1.750	2.063	0.531	0.625	0.875	CR 99180
		1.750	2.063	0.563	0.688	0.813	CR 9827*
		1.750	2.063	0.563	0.688	0.813	CR 99174
		1.750	2.063	0.750	0.875	0.813	CR 99828*
		1.750	2.063	0.750	0.875	0.813	CR 99175
1.761	1.767	1.766	2.063	0.563	0.688	0.813	CR 99829*
		1.766	2.063	0.563	0.688	0.813	CR 99176
1.769	1.775	1.772	2.087	0.551	0.669	0.812	CR 99830*
		1.772	2.087	0.551	0.669	0.813	CR 99177
1.778	1.784	1.781	2.125	0.675	0.800	1.062	CR 99179
1.809	1.815	1.813	2.090	0.563	0.688	1.000	CR 99831*
		1.813	2.090	0.563	0.688	1.000	CR 99181
1.857	1.863	1.859	2.156	0.563	0.688	1.000	CR 99185
1.866	1.872	1.868	2.188	0.889	1.025	1.000	CR 99186
1.872	1.878	1.875	2.203	0.175	0.295	0.744	CR 99190
		1.875	2.203	0.295	0.415	0.744	CR 99188
		1.875	2.203	0.375	0.516	1.050	CR 99184
		1.875	2.203	0.563	0.688	1.000	CR 99832*
		1.875	2.203	0.563	0.688	1.000	CR 99187
1.887	1.893	1.891	2.205	0.551	0.668	0.984	CR 99189

* Indicates Speedi-Sleeve Gold
1) Possible max. distance of rear groove from shaft end when installation tool supplied with sleeve is used

Speedi-Sleeves – Inch sizes

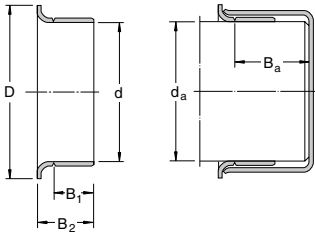

Shaft diameter		Sleeve dimensions					SKF Designation
d_a min	max	d	D ± 0.063	B_1 ± 0.031	B_2 ± 0.031	B_a ¹⁾	
in		in					–
1.909	1.915	1.912	2.219	0.375	0.500	1.000	CR 99192
1.934	1.940	1.938	2.219	0.563	0.688	1.000	CR 99833*
		1.938	2.219	0.563	0.688	1.000	CR 99193
1.965	1.971	1.969	2.244	0.551	0.668	0.984	CR 99196
1.977	1.983	1.980	2.313	0.563	0.704	1.050	CR 99198
	2.003	2.000	2.406	0.563	0.688	1.000	CR 99199
		2.000	2.406	0.563	0.688	1.006	CR 99834*
		2.000	2.406	0.875	1.000	1.000	CR 99835*
		2.000	2.406	0.875	1.000	1.000	CR 99200
2.040	2.047	2.047	2.469	0.500	0.625	1.358	CR 99204
2.057	2.063	2.063	2.469	0.813	0.938	1.375	CR 99205
2.123	2.128	2.125	2.422	0.500	0.750	1.281	CR 99210
2.124	2.130	2.125	2.422	0.781	0.938	1.375	CR 99836*
		2.125	2.422	0.781	0.938	1.375	CR 99212
2.162	2.169	2.165	2.441	0.787	0.905	1.250	CR 99863*
	2.168	2.165	2.441	0.787	0.905	1.250	CR 99215
2.178	2.184	2.181	2.500	0.781	0.938	1.500	CR 99217
2.186	2.192	2.188	2.500	0.781	0.938	1.313	CR 99218
2.198	2.205	2.205	2.531	0.500	0.625	1.315	CR 99220
2.227	2.233	2.230	2.531	0.500	0.625	1.313	CR 99861*
		2.230	2.531	0.500	0.625	1.313	CR 99229
		2.230	2.531	0.781	0.906	1.250	CR 99230
2.237	2.243	2.240	2.563	0.764	0.900	1.250	CR 99226
2.249	2.255	2.250	2.531	0.313	0.438	1.313	CR 99838*
		2.250	2.531	0.313	0.438	1.313	CR 99227
		2.250	2.531	0.781	0.938	1.313	CR 99837*
		2.250	2.531	0.781	0.938	1.313	CR 99225
2.309	2.315	2.313	2.688	0.781	0.938	1.375	CR 99231

* Indicates Speedi-Sleeve Gold
¹⁾ Possible max. distance of rear groove from shaft end when installation tool supplied with sleeve is used

Speedi-Sleeves – Inch sizes

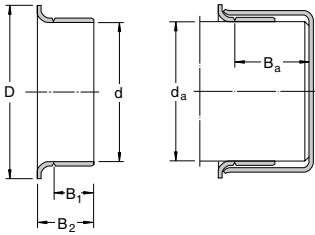

Shaft diameter		Sleeve dimensions					SKF Designation
d_a min	max	d	D ± 0.063	B_1 ± 0.031	B_2 ± 0.031	$B_a^{1)}$	
in		in					–
2.327	2.333	2.328	2.750	0.750	0.875	1.500	CR 99233
2.359	2.365	2.362	2.785	0.370	0.450	1.471	CR 99241
		2.362	2.785	0.787	0.905	1.375	CR 99235
2.372	2.378	2.375	2.750	0.594	0.750	1.375	CR 99238
2.374	2.380	2.375	2.750	0.526	0.683	1.375	CR 99240
		2.375	2.750	0.781	0.938	1.375	CR 99839*
		2.375	2.750	0.781	0.938	1.375	CR 99237
2.434	2.440	2.438	2.828	0.781	0.938	1.393	CR 99243
2.435	2.441	2.438	2.828	0.500	0.625	1.425	CR 99242
2.433	2.441	2.441	2.827	0.500	0.625	1.425	CR 99244
2.489	2.495	2.492	2.875	0.781	0.938	1.393	CR 99249
2.497	2.503	2.500	2.820	0.555	0.650	0.890	CR 99253
2.500	2.506	2.500	2.820	0.781	0.938	1.375	CR 99840*
		2.500	2.820	0.781	0.938	1.375	CR 99250
		2.500	2.828	0.500	0.656	1.393	CR 99248
2.510	2.516	2.516	2.828	0.781	0.906	1.438	CR 99251
2.556	2.562	2.559	2.850	0.787	0.905	1.375	CR 99841*
		2.559	2.850	0.787	0.905	1.375	CR 99254
2.560	2.566	2.563	2.891	0.781	0.938	1.375	CR 99256
2.595	2.601	2.598	2.990	0.781	0.938	1.250	CR 99259
2.618	2.624	2.621	3.047	0.781	0.938	1.375	CR 99261
2.621	2.627	2.625	3.047	0.781	0.906	1.375	CR 99264
2.622	2.628	2.625	3.047	0.500	0.625	1.375	CR 99260
2.625	2.631	2.625	3.047	0.781	0.938	1.375	CR 99842*
		2.625	3.047	0.781	0.938	1.375	CR 99262
2.670	2.677	2.677	3.126	0.752	0.874	1.689	CR 99266
2.727	2.733	2.730	3.125	0.781	0.906	1.313	CR 99268

* Indicates Speedi-Sleeve Gold
1) Possible max. distance of rear groove from shaft end when installation tool supplied with sleeve is used

Speedi-Sleeves – Inch sizes

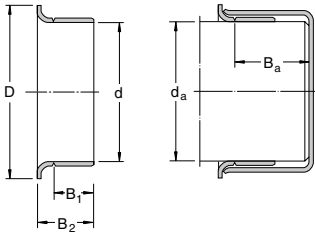

Shaft diameter		Sleeve dimensions					SKF Designation
d_a min	max	d	D ± 0.063	B_1 ± 0.031	B_2 ± 0.031	$B_a^{1)}$	
in		in					–
2.740	2.746	2.743	3.065	0.781	0.938	1.250	CR 99273
2.745	2.751	2.750	3.125	0.781	0.938	1.250	CR 99274
2.747	2.753	2.750	3.075	1.438	1.625	1.625	CR 99267
2.750	2.756	2.750	3.125	0.406	0.563	1.250	CR 99272
		2.750	3.125	0.781	0.938	1.250	CR 99844*
		2.750	3.125	0.781	0.938	1.250	CR 99275
		2.750	3.125	1.125	1.250	1.313	CR 99269
2.745	2.751	2.750	3.125	0.781	0.938	1.250	CR 99843*
2.753	2.759	2.756	3.125	0.787	0.945	1.250	CR 99276
2.809	2.815	2.813	3.188	0.594	0.688	1.250	CR 99281
2.827	2.835	2.835	3.224	0.752	0.874	1.343	CR 99284
2.838	2.844	2.838	3.225	0.500	0.656	1.250	CR 99845*
		2.844	3.225	0.500	0.656	1.250	CR 99282
2.866	2.872	2.869	3.188	0.781	0.938	1.250	CR 99286
2.873	2.879	2.875	3.219	0.781	0.938	1.250	CR 99846*
		2.875	3.219	0.781	0.938	1.250	CR 99287
2.937	2.943	2.938	3.344	0.500	0.641	1.331	CR 99290
		2.938	3.344	0.781	0.938	1.313	CR 99847*
		2.938	3.344	0.781	0.938	1.313	CR 99293
2.950	2.956	2.953	3.273	0.594	0.688	1.083	CR 99289
		2.953	3.305	0.866	1.024	1.313	CR 99294
2.972	2.976	2.974	3.235	0.813	1.000	1.250	CR 99292
2.990	2.996	2.993	3.350	0.813	1.000	1.281	CR 99299
		2.993	3.359	0.484	0.625	1.331	CR 99291
		2.993	3.359	0.563	0.688	1.375	CR 99298
2.997	3.003	3.000	3.240	0.813	0.938	1.375	CR 99296

* Indicates Speedi-Sleeve Gold

1) Possible max. distance of rear groove from shaft end when installation tool supplied with sleeve is used

Speedi-Sleeves - Inch sizes

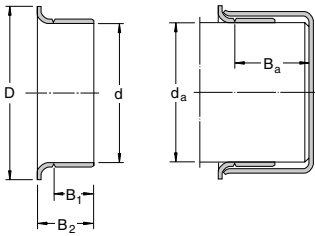

Shaft diameter		Sleeve dimensions					SKF Designation
d_a min	max	d	D ± 0.063	B_1 ± 0.031	B_2 ± 0.031	$B_a^{1)}$	
in		in					-
3.000	3.006	3.000	3.235	0.813	1.000	1.281	CR 99848*
		3.000	3.235	0.813	1.000	1.281	CR 99300
		3.000	3.345	0.625	0.813	1.063	CR 99303
3.008	3.014	3.011	3.355	0.500	0.625	2.000	CR 99301
3.063	3.071	3.071	3.469	0.770	0.874	2.059	CR 99306
3.120	3.126	3.125	3.531	0.688	0.813	2.000	CR 99311
		3.125	3.531	0.813	1.000	2.000	CR 99312
		3.125	3.531	0.813	1.000	2.000	CR 99849*
3.124	3.132	3.125	3.525	0.551	0.709	2.031	CR 99307
3.142	3.150	3.146	3.540	0.750	0.886	1.375	CR 99313
3.146	3.153	3.150	3.543	0.433	0.591	1.375	CR 99317
		3.150	3.543	0.827	0.945	1.375	CR 99315
3.225	3.231	3.228	3.585	0.660	0.848	1.750	CR 99328
3.250	3.256	3.250	3.575	0.595	0.719	1.375	CR 99850*
		3.250	3.575	0.595	0.719	1.375	CR 99324
		3.250	3.585	0.688	0.875	1.250	CR 99326
		3.250	3.585	0.813	1.000	1.375	CR 99851*
		3.250	3.585	0.813	1.000	1.375	CR 99325
3.247	3.253	3.250	3.594	0.813	1.000	1.375	CR 99322
3.307	3.313	3.310	3.688	0.813	1.000	1.375	CR 99331
3.337	3.347	3.342	3.700	0.669	0.827	1.378	CR 99332
		3.342	3.700	0.827	0.984	1.378	CR 99333
3.338	3.346	3.346	3.697	0.398	0.500	1.433	CR 99334
3.373	3.379	3.375	3.688	0.375	0.500	1.410	CR 99338
		3.375	3.695	0.813	1.000	1.375	CR 99337
3.435	3.441	3.438	3.844	0.781	0.906	1.406	CR 99339
3.477	3.483	3.480	3.835	0.781	0.906	1.406	CR 99340
3.497	3.503	3.500	3.844	0.625	0.813	1.347	CR 99346

* Indicates Speedi-Sleeve Gold
1) Possible max. distance of rear groove from shaft end when installation tool supplied with sleeve is used

Speedi-Sleeves – Inch sizes

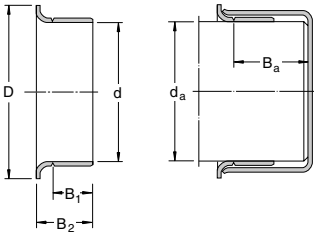

Shaft diameter		Sleeve dimensions					SKF Designation
d_a min	max	d	D ± 0.063	B_1 ± 0.031	B_2 ± 0.031	$B_a^{1)}$	
in		in					–
3.500	3.506	3.500	3.825	0.313	0.500	1.347	CR 99347
		3.500	3.844	0.813	1.000	1.347	CR 99852*
		3.500	3.844	0.813	1.000	1.347	CR 99350
3.501	3.507	3.504	3.844	0.625	0.813	1.348	CR 99349
3.540	3.546	3.543	4.000	0.434	0.538	1.813	CR 99352
		3.543	4.000	0.526	0.667	1.750	CR 99353
		3.543	4.000	0.710	0.906	1.813	CR 99351
		3.543	4.000	0.906	1.102	1.750	CR 99354
3.560	3.566	3.563	3.900	0.813	1.000	1.750	CR 99356
3.618	3.624	3.621	4.031	0.813	1.000	1.750	CR 99360
3.623	3.629	3.625	4.025	0.500	0.625	1.750	CR 99363
		3.625	4.031	0.813	1.000	1.750	CR 99362
3.684	3.690	3.688	3.830	0.313	0.438	0.875	CR 99368
3.685	3.691	3.688	4.025	0.813	0.938	1.750	CR 99365
3.727	3.733	3.730	4.016	0.469	0.594	1.719	CR 99359
		3.730	4.025	0.781	0.906	1.750	CR 99366
3.737	3.743	3.740	4.025	0.827	0.945	1.750	CR 99369
3.740	3.746	3.743	4.031	0.344	0.500	1.750	CR 99374
		3.743	4.035	0.469	0.594	1.750	CR 99364
3.746	3.752	3.750	4.025	0.563	0.688	1.750	CR 99376
3.750	3.756	3.750	4.025	0.344	0.500	1.750	CR 99367
		3.750	4.020	0.688	0.875	1.800	CR 99853*
		3.750	4.020	0.688	0.875	1.875	CR 99372
3.868	3.874	3.871	4.185	0.813	1.000	1.875	CR 99386
3.873	3.879	3.875	4.219	0.813	1.000	1.875	CR 99387
3.935	3.941	3.938	4.313	0.813	1.000	2.050	CR 99854*
		3.938	4.313	0.813	1.000	2.050	CR 99393

* Indicates Speedi-Sleeve Gold

1) Possible max. distance of rear groove from shaft end when installation tool supplied with sleeve is used

Speedi-Sleeves – Inch sizes

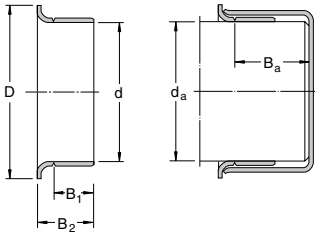

Shaft diameter		Sleeve dimensions					SKF Designation
d_a min	max	d	D ± 0.063	B_1 ± 0.031	B_2 ± 0.031	$B_a^{1)}$	
in		in					–
3.998	4.006	4.000	4.375	0.500	0.625	2.066	CR 99401
		4.000	4.375	0.600	0.725	2.050	CR 99395
		4.000	4.375	0.650	0.775	1.375	CR 99400
		4.000	4.375	0.813	1.000	2.050	CR 99855*
		4.000	4.375	0.813	1.000	2.050	CR 99399
4.090	4.098	4.094	4.438	0.787	0.945	1.417	CR 99409
4.122	4.130	4.125	4.420	0.813	1.000	1.375	CR 99412
4.130	4.138	4.134	4.470	0.787	0.913	1.378	CR 99413
4.183	4.191	4.188	4.500	0.813	1.000	1.375	CR 99418
4.226	4.234	4.234	4.610	0.781	0.906	1.438	CR 99423
4.248	4.256	4.250	4.610	0.813	1.000	1.438	CR 99424
4.322	4.331	4.331	4.917	0.499	0.570	1.295	CR 99434
4.327	4.335	4.328	4.921	0.509	0.650	1.250	CR 99435
4.370	4.378	4.375	4.750	0.813	1.000	1.650	CR 99437
4.401	4.409	4.406	4.750	0.748	0.886	1.063	CR 99438
4.434	4.442	4.438	4.813	1.000	1.142	1.313	CR 99439
		4.504	4.500	4.900	0.813	1.000	1.250
4.496	4.504	4.500	4.900	0.813	1.000	1.250	CR 99450
		4.523	4.531	4.527	5.000	0.813	0.938
4.621	4.629	4.625	5.000	0.438	0.625	1.375	CR 99465
		4.625	5.063	1.000	1.250	1.375	CR 99463
4.685	4.693	4.688	5.063	0.813	1.000	1.375	CR 99468
4.720	4.728	4.724	5.110	0.315	0.433	1.323	CR 99471
		4.724	5.110	0.787	0.984	1.260	CR 99473
4.746	4.754	4.750	5.000	0.500	0.750	1.500	CR 99475
4.799	4.807	4.803	5.177	0.787	0.945	1.260	CR 99472
4.839	4.847	4.843	5.229	0.787	0.984	1.244	CR 99484

* Indicates Speedi-Sleeve Gold
1) Possible max. distance of rear groove from shaft end when installation tool supplied with sleeve is used

Speedi-Sleeves – Inch sizes

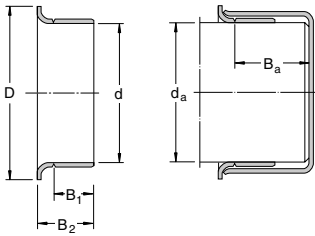

Shaft diameter		Sleeve dimensions					SKF Designation
d_a min	max	d	D ± 0.063	B_1 ± 0.031	B_2 ± 0.031	B_a ¹⁾	
in		in					–
4.871	4.879	4.875	5.250	0.625	0.750	1.438	CR 99487
4.917	4.925	4.921	5.400	0.394	0.551	1.438	CR 99490
		4.921	5.400	1.024	1.260	1.438	CR 99492
4.998	5.006	5.000	5.400	0.540	0.681	1.438	CR 99501
		5.000	5.400	0.688	0.875	1.438	CR 99857*
		5.000	5.400	0.688	0.875	1.438	CR 99498
		5.000	5.390	0.813	1.000	1.438	CR 99858*
		5.000	5.390	0.813	1.000	1.438	CR 99499
5.110	5.118	5.114	5.493	0.750	0.938	1.181	CR 99494
5.117	5.125	5.125	5.493	0.866	0.996	1.280	CR 99491
5.120	5.128	5.125	5.500	0.813	1.000	1.250	CR 99513
5.246	5.254	5.250	5.560	0.813	1.000	1.250	CR 99525
5.307	5.315	5.313	5.875	0.807	1.000	1.250	CR 99533
5.371	5.379	5.375	5.875	0.813	1.000	1.250	CR 99537
5.434	5.442	5.438	5.750	1.500	1.688	1.875	CR 99548
5.472	5.480	5.472	6.100	0.563	0.750	0.938	CR 99547
5.498	5.506	5.500	5.938	0.518	0.705	1.250	CR 99550
		5.500	5.938	0.813	1.000	1.250	CR 99859*
		5.500	5.938	0.813	1.000	1.250	CR 99549
5.508	5.516	5.512	5.945	0.807	1.000	1.250	CR 99552
5.621	5.629	5.625	6.188	0.875	1.000	1.812	CR 99560
5.700	5.709	5.709	5.902	0.768	0.874	1.811	CR 99571
5.726	5.734	5.734	5.900	0.563	0.750	1.938	CR 99562
5.746	5.754	5.750	6.180	0.813	1.000	1.750	CR 99575
5.871	5.879	5.875	6.188	1.000	1.250	1.313	CR 99862*
		5.875	6.188	1.000	1.250	1.313	CR 99587
5.895	5.905	5.905	6.260	1.024	1.181	1.338	CR 99595

* Indicates Speedi-Sleeve Gold
¹⁾ Possible max. distance of rear groove from shaft end when installation tool supplied with sleeve is used

Speedi-Sleeves – Inch sizes

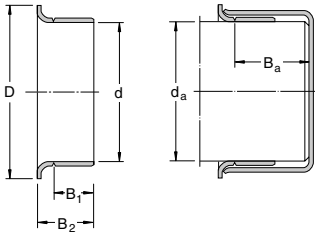

Shaft diameter		Sleeve dimensions					SKF Designation
d_a min	max	d	D ± 0.063	B_1 ± 0.031	B_2 ± 0.031	$B_a^{1)}$	
in		in					–
5.934	5.942	5.938	6.375	1.000	1.125	1.875	CR 99596
5.995	6.003	6.000	6.360	0.500	0.750	1.750	CR 99601
		6.000	6.375	1.000	1.250	1.750	CR 99599
6.058	6.068	6.063	6.375	1.024	1.181	1.299	CR 99605
6.092	6.102	6.097	6.575	1.024	1.181	1.299	CR 99606
6.198	6.208	6.203	6.625	0.813	1.063	1.750	CR 99620
6.245	6.255	6.250	6.625	1.031	1.250	1.750	CR 99625
6.289	6.299	6.299	7.000	1.000	1.250	1.375	CR 99630
6.495	6.505	6.500	7.000	1.000	1.250	1.375	CR 99650
6.683	6.693	6.688	7.188	1.250	1.496	1.750	CR 99640
6.745	6.755	6.750	7.125	0.813	1.063	1.750	CR 99675
6.880	6.890	6.890	7.362	1.102	1.260	1.378	CR 99687
6.995	7.005	7.000	7.475	1.000	1.250	1.688	CR 99700
7.077	7.087	7.087	7.500	1.300	1.496	1.752	CR 99721
7.244	7.254	7.250	7.760	1.250	1.500	2.175	CR 99725
7.273	7.283	7.278	7.834	1.260	1.496	2.165	CR 99726
7.444	7.454	7.453	7.860	0.813	1.000	1.250	CR 99745
7.495	7.505	7.500	7.875	0.813	1.000	1.250	CR 99750
7.745	7.755	7.750	8.270	1.000	1.313	1.875	CR 99775
7.869	7.879	7.875	8.375	1.359	1.500	1.750	CR 99787
7.933	7.943	7.938	8.375	1.000	1.250	1.750	CR 99799
7.995	8.005	8.000	8.375	1.000	1.250	1.750	CR 99800

* Indicates Speedi-Sleeve Gold
1) Possible max. distance of rear groove from shaft end when installation tool supplied with sleeve is used

Large diameter wear sleeves

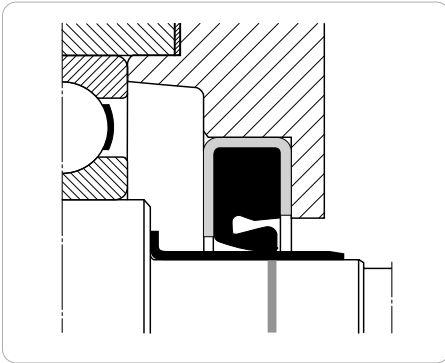

Fig 82. LDSLV3 with a flange

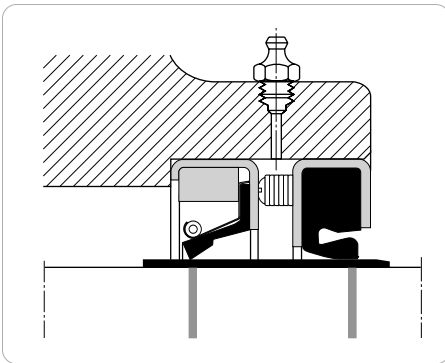

Fig 83. Flangeless LDSLV4

General

Large diameter wear sleeves, (LDSLV), are used primarily for applications where no Speedi-Sleeve is available, i.e. for shafts in the diameter range 203 to 1 150 mm (8 to 45 in). Two designs of LDSLV are produced; the LDSLV3 with a flange (**fig 82**) and the flangeless LDSLV4 (**fig 83**). Their use is recommended in all cases where the operating conditions for the seals are difficult, particularly where solid contaminants can reach the seal lip, e.g. in rolling mills and chemical plants. These are cases where seal wear and damage of the counterface on the shaft can be expected.

It is recommended that LDSLV are designed into the application from the outset. During repairs, it will then not be necessary to rework the shaft and the original seal size can always be used as the replacement.

Product features

LDSLV are made of stainless steels, chrome plated with a hardness of ≈ 50 HRC and a surface roughness or $0,25$ to $0,5 \mu\text{m R}_a$. The wall thickness of the standard sleeves is $2,54$ mm (0.100 in). The sliding surface for the seal is fine machined and chromium plated to enhance the wear and corrosion resistance.

The width of the counterface for the seal on the LDSLV3 is $6,4$ mm (0.250 in) narrower than the total width B of the sleeve. The flange height is $12,7$ mm (0.500 in) for all sizes. Details of the possible diameters and widths of the sleeves will be found in **Table 23, page 312**, together with the sleeve and shaft tolerances.

LDSLV4 are intended for applications where a flange (to ease mounting) is in the way, or where a wider sliding surface for the seal is required. The dimensions, tolerance recommendations etc. are otherwise the same as those quoted for the LDSLV3.

Use

There are two alternative ways of using LDSLV for shaft repairs. Either the sleeve can be pushed along the shaft until it covers the damaged part and a seal which has a 4,8 mm (0.180 in) larger bore diameter than the original is used, or the shaft can be machined down 4,8 mm (0.180 in) and the original seal size used. The reworked shaft seating for the sleeve should have a surface roughness value of between 2,5 and 3,2 $\mu\text{m R}_a$ (100 to 125 μin)

Mounting

LDSLV are mounted with an interference fit on the shaft. It is therefore recommended that they are heated prior to mounting.

Temperatures of up to 180 °C are permitted; on no account should the sleeve be heated (to) above 200 °C. The types of heating arrangements normally used for bearings are suitable, e.g. heating cabinets, oil baths or induction heaters.

The thin-walled sleeves should be mounted immediately after heating as they cool rapidly. This is particularly true of the LDSLV4.

Dismounting

To dismount the sleeves it is recommended first to either heat them or to expand them by light hammer blows. The flange of the LDSLV3 should first be cut through at one point.

Table 23. Possible sleeve diameters and widths

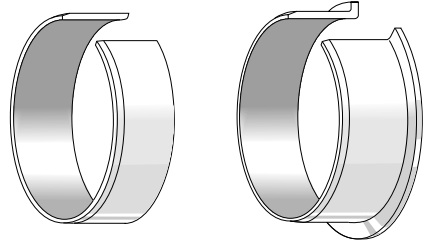
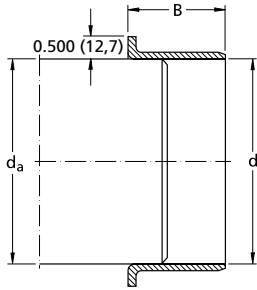

Diameter nominal		Sleeve bore diameter, d Deviation		Width B			Shaft diameter d _a Deviation		Probable interference	
over	incl.	high	low	max	min LDSL3	min LDSL4	high	low	min	max
mm/in		µm		mm/in			µm		µm	
203,2 8	304,8 12	-127	-305	63,5 2.500	17,5 0.680	12,7 0.500	+50	-50	+57	+355
304,8 12	508 20	-150	-400	63,5 2.500	17,5 0.680	12,7 0.500	+100	-50	+100	+500
508 20	762 30	-150	-400	63,5 2.500	17,5 0.680	12,7 0.500	+200	-50	+100	+600
762 30	1016 40	-150	-400	63,5 2.500	25,4 1.000	19,05 0.750	+200	-50	+100	+600
1016 40		-150	-450	63,5 2.500	25,4 1.000	19,05 0.750	+250	-50	+100	+700

Please contact us for recommendations concerning large diameter wear sleeves that will operate in systems with sustained oil sump temperatures of 75 °C and speeds in excess of 20 m/s.



Mechanical seals

Contents

- 317 Mechanical seals
- 319 Installation
- 319 Repair kits

Mechanical seals

These mechanical seals are designed for use under severe service conditions at relatively low peripheral speeds. They offer reliable protection against solid and liquid contaminants as well as leak-proof retention of lubricant. The seals were originally developed for off-road and tracked vehicles but have been found to be equally suitable for a range of other applications where effective protection is required against sand, soil, mud, water etc. These applications include

- all types of mixers,
- sand treatment equipment,
- conveyors and other construction equipment,
- agricultural machinery,
- washing equipment,
- grinding mills and other comminution equipment,
- ore dressing equipment, and
- mining equipment.

The mechanical seals from SKF (**fig 84**) consist of two identical sealing rings and two similar nitrile rubber Belleville washers (cup springs). The sealing rings are of wear and corrosion resistant steel and have finely finished sliding and sealing surfaces. Sealing is assured even against thin oils, such as SAE 10W40 oils. The Belleville washers of nitrile rubber provide the necessary uniform face loading and positive sealing at the bore and outside diameters. The outside diameter of the washers adapts to the form of the bore in which they are mounted and there are no special demands in respect of surface finish.

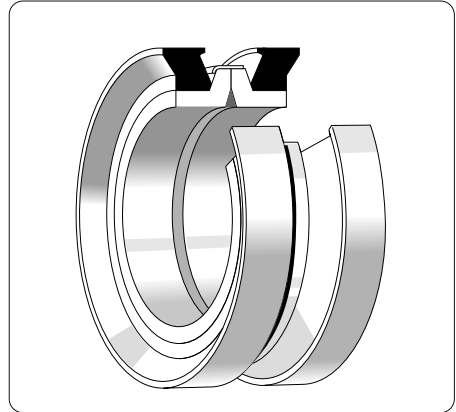

Fig 84

Table 24. Permissible operating conditions

Operating conditions	Guideline values
Operating temperature, °C	
continuous operation	-50 to +100
brief periods, maximum	+120
Peripheral speed, m/s	
continuous operation	up to 1,75
brief periods, maximum	up to 4
Pressure acting on seal, MPa	
continuous operation	up to 0,2
brief periods	up to 0,35

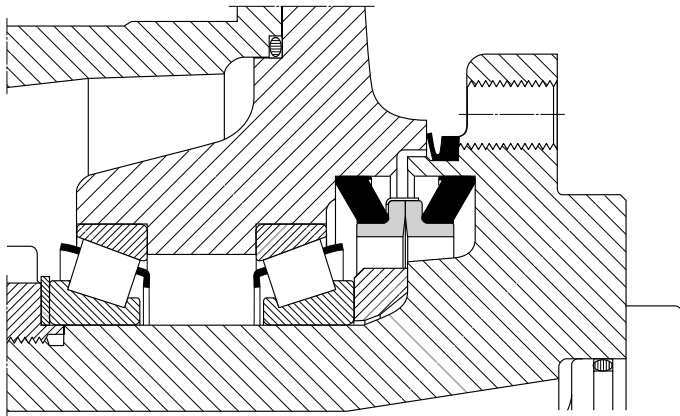

Fig 85

SKF mechanical seals are supplied as ready-to-mount cartridge units. A special retainer ring holds the two sealing ring faces together. This not only facilitates mounting but also protects the seal against damage.

The retainer is left in position after mounting and provides extra protection for the sliding surfaces during the initial stages of operation. It slowly wears away.

The permissible operating conditions for the mechanical seals are given in **Table 24**. The chemical resistance of the nitrile rubber is dealt with in the section "Chemical resistance".

Installation

No special tools are required to mount the mechanical seals. To ease installation it is recommended that the housing bore should have a lead-in chamfer as shown in the product tables. The recommended tolerances for the housing bore are also given in the product tables. A typical application for this type of seal, the drive assembly of an off-road tracked vehicle, is shown in **fig 85**.

Repair kits

For repairs where the sealing rings are to be re-used and only the washers are to be replaced, replacement washers can be supplied. They come as "repair kits" which also contain installation instructions and two lint-free cloths for cleaning the sealing rings of the original seal. Appropriate repair kits for individual SKF mechanical seals are listed in **Table 25**.

Table 25. Repair kits for SKF mechanical seals

Designations Original seal	Repair kit
CR 16904	CR 16906
CR 18259	CR 18257
CR 21306	CR 21307
CR 25096	CR 25097
CR 27536	CR 27535
CR 30651	CR 30654
CR 35076	CR 35079
CR 38740	CR 38741
CR 38751	CR 38752
CR 43135	CR 43136
CR 43150	CR 43149
CR 46975	CR 46976
CR 50655	CR 50656
CR 54000	CR 54001
CR 56170	CR 56171
CR 58775	CR 58776
CR 63796	CR 63797
CR 67560	CR 67561
CR 74310	CR 74311
CR 78020	CR 78021
CR 82540	CR 82541
CR 86850	CR 86851
CR 93115	CR 93116
CR 93125	CR 93126
CR 95620	CR 95621
CR 108710	CR 108711
CR 116500	CR 116501
CR 124020	CR 124021
CR 137570	CR 137571
CR 171025	CR 171026
CR 191022	CR 191021
CR 238020	CR 238021



V-ring seals

Contents

323	V-ring seals
323	General
323	Function
324	Standard designs
325	Design of sealing arrangement
326	Materials
326	Sliding velocities
329	Coaxiality and runout
329	Axial displacement
329	Counterface
329	Misalignment
330	Mounting instructions
331	Size listing – Metric sizes
347	Size listing – Inch sizes
359	MVR axial shaft seals
359	Advantages
359	Construction
359	Temperature range
360	Size listing – Metric sizes

V-ring seals

General

The V-ring is a unique all-rubber seal for rotary shafts. Developed in the 1960's, it has been used successfully by OEM and the replacement market worldwide in an extremely wide range of applications.

The V-ring is used alone to seal out the ingress of dirt, dust, water or combination of the above media while positively retaining grease. With its unique design and performance the V-ring protects a wide range of bearing types. It is often used as a secondary seal to protect primary seals that do not perform well in hostile environments.

V-ring seals are mounted on shafts and their thin, tapered lip seals against a surface (counterface) at right angles to the shaft (**fig 86a**). No special demands are placed on the surface finish of the shaft seating and the V-rings act as flingers (**fig 86b**), since they have an interference fit on the shaft and rotate with it. Misalignment of the shaft with respect to the counterface (**fig 86c**) can be tolerated and V-rings also provide reliable sealing if the shaft is out-of-round or rotates eccentrically (**fig 86d**). It should be remembered when

using V-rings that the amount by which the shaft can be displaced axially is governed by the permissible displacement of the V-ring relative to its counterface.

V-rings are made entirely of elastomer without fabric or sheet metal reinforcement. They are, therefore, particularly easy to install.

They can be stretched and, depending on size, can be pushed over other components of the arrangement, e.g. flanges, pulleys or even housings. This is a very valuable characteristic, especially in the case of repairs.

Function

The V-ring has a body (**87a**) and a flexible conical shaped sealing lip (**87b**) with an integral resilient "hinge" (**87c**). It is stretched and mounted directly on the shaft, where it is held in place by the inherent tension of the seal body. It rotates with the shaft and seals axially against a stationary counterface.

The counterface can be the end face of a bearing, a washer, stamping, bearing housing, or even the metal case of an oil seal.

In many instances the V-ring can be stretched and installed over flanges and bearing housings without costly dismantling.

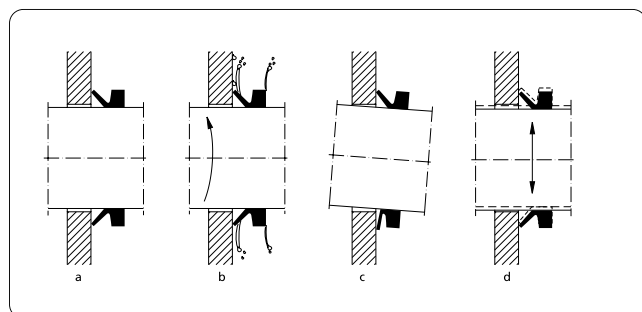

Fig 86

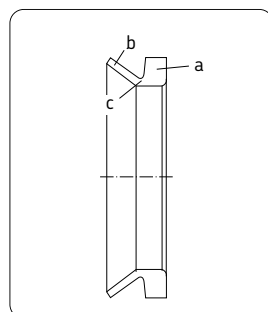

Fig 87

The V-ring shall be located in the medium to be sealed.

The sealing lip is flexible and applies only a relatively light contact pressure against the counterface but sufficient enough to maintain the sealing function. The light contact pressure even allows the seal to run dry in some low speed applications. The contact pressure varies with the fitted width.

The flexible lip and hinge effect provide adequate sealing even in applications with considerable end play and shaft misalignment.

Due to the centrifugal force the contact pressure of the lip decreases with increase in speed. This means that frictional losses and heat are kept to a minimum, resulting in better wear characteristics and extended seal life. The power loss reaches its maximum at a shaft speed of approx. 12 m/s and is thereafter gradually reduced up to about 20 m/s where it will decrease to zero. The V-ring then serves as a clearance seal and deflector.

Standard Designs

VR1 design

This is the most common design and is available for shaft diameters from 2,7 to 2.020 mm, inclusive.

VR2 design

The body of this V-ring is wide and tapered. This gives the seal a very firm hold on the shaft. Seals of the VR2 design are available for the most commonly used shaft diameters in the range 4,5 to 210 mm.

VR3 design







These seals have a very narrow axial cross section making for compact arrangements and are often used in combination with labyrinth seals. They are available for shaft diameters in the range 135 to 630 mm.

VR4 design

These V-rings were designed as secondary seals for heavy-duty applications where the primary seal has to be protected against water and/or solid contaminants. They have the largest cross section of any V-ring design and also permit the largest axial displacements. They are available in the diameter range 450 to 2.010 mm.

VR5 and VR6 design

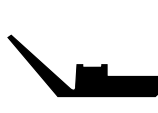
The heavy-duty large diameter style can easily be fitted with a standard clamping band for axial fixation in high speed applications. Ideal for steel mills, ball mills and paper mills.

						
Design	VR1	VR2	VR3	VR4	VR5	VR6
min Ø mm	2,7	4,5	15	450	300	300
max Ø mm	2020	2010	2010	2010	2010	2010

Design of sealing arrangement

V-ring seals are suitable for both grease and oil-lubricated applications. For sealing grease-lubricated bearing arrangements against dust or water spray, the V-ring should be arranged outside the housing cover or housing wall. Dust, water spray and other impurities can be excluded in this position (**fig 88a**). The V-ring will also act as a grease valve (**fig 88b**) Used grease or excess new grease can escape between the counterface and the sealing lip. The use of two opposing V-rings (**fig 89**) is recommended where lubricant retention and contaminant exclusion are of equal importance.

If V-rings are to be used to retain oil, they should always be axially located on the shaft on the lubricant side (**fig 90**). If the direction of shaft rotation is constant, a spiral groove in the counterface causes oil to leave the sealing position and thus improves sealing efficiency.

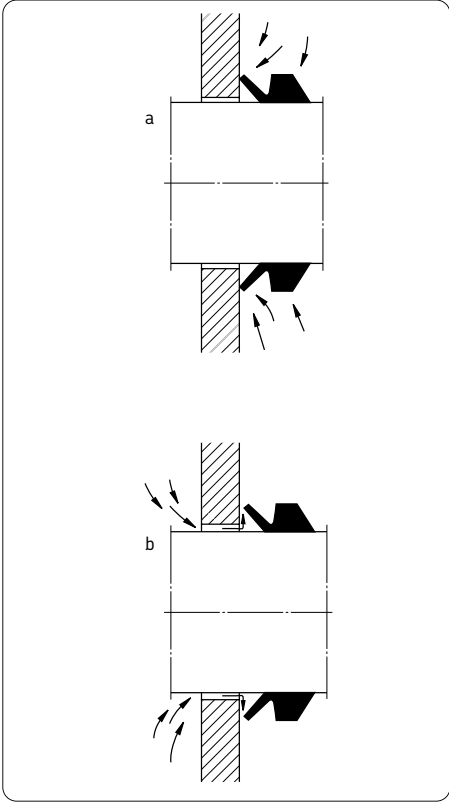

Fig 88

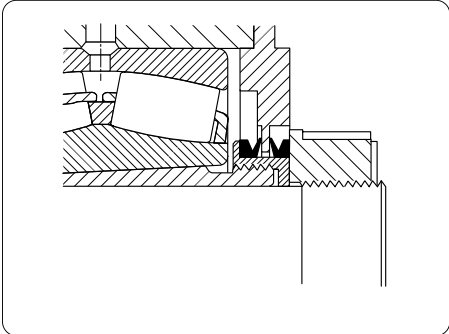

Fig 89

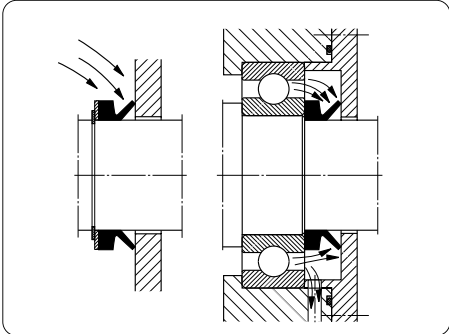

Fig 90

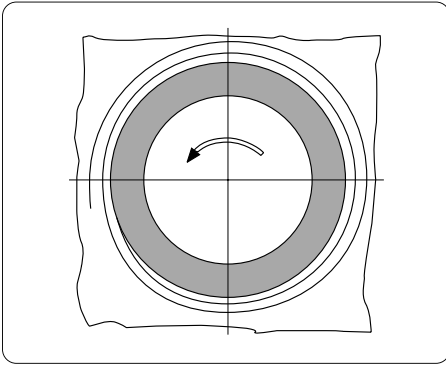

Fig 91

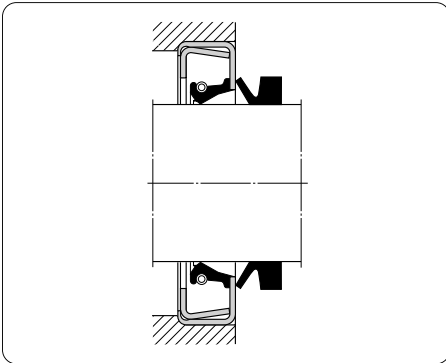

Fig 92

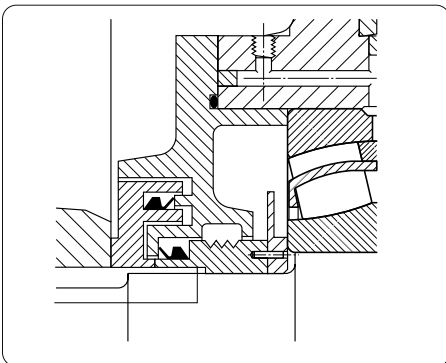

Fig 93

The spiral groove (**fig 91**) should have an enlargement of approximately 2 mm for each complete turn in the direction of rotation and should have a depth of between 0,05 and 0,1 mm with a radius of curvature of approximately 0,5 mm. All edges must be smoothed. V-rings may also be used as a secondary back-up seal (**fig 92**), for example, where it is necessary to protect the sealing lip and counterface of the primary seal against solid contaminants or corrosion. They have also been used to advantage to enhance the efficiency of labyrinth seals (**fig 93**). If the seating diameter lies in the appropriate range for two V-rings, the larger V-ring should always be chosen.

Materials

Normally V-rings are made from nitrile rubber (NBR). This has good resistance to wear as well as to chemicals and can be used for normal operating temperatures. For applications where higher temperatures occur or where aggressive media are present, V-rings made of fluoro rubber (FPM) can be supplied. The permissible operating conditions will be found in **table 26**. The chemical resistance of the rubber materials is described in the section entitled "Chemical resistance". In the product table under the heading "Design and material", the letters R and V are used to identify nitrile rubber and fluoro rubber, respectively.

Warning: fluoro rubber seals will give off toxic fumes at temperatures above 300°C. If overheated they are still dangerous to handle even once they have cooled down.

Sliding velocities

V-ring seals can be operated under the conditions given in **table 26**. It should be noted that at speeds above 15 m/s the sealing lip will lift from the counterface and the V-ring will only act as a gap-type seal.

Table 26. Permissible operating conditions

 <p>1</p>	 <p>2</p>	 <p>3</p>
<p>Operating conditions</p>	<p>Guideline values for V-rings of nitrile rubber</p>	<p>Guideline values for V-rings of fluoro rubber</p>
<p>Operating temperature, °C dynamic sealing static sealing</p> <p>Peripheral speed, m/s normal (1) axially located (2) with support ring (3) with rotating counterface</p>	<p>–40 to + 100 –40 to + 120</p> <p>up to 8 8 to 12 >12 up to 20</p>	<p>–20 to + 150 –40 to + 230</p> <p>up to 6,5 6,5 to 10 >10 up to 20</p>
<p>Pressure acting on seal, MPa static sealing or very low speed operation</p>	<p>up to 0,03</p>	<p>up to 0,03</p>

Table 27. Coaxiality and runout tolerances



Shaft diameter nominal		Total tolerance for coaxiality deviation and runout
------------------------	--	---

d ₁ over	incl	t ₁ max
mm		mm

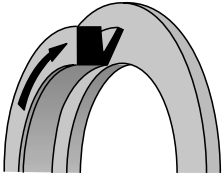
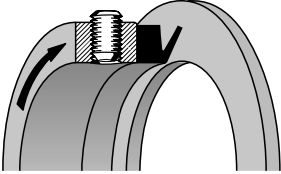
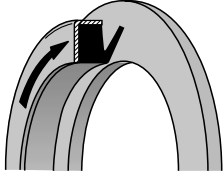
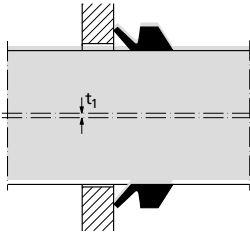
V-rings, VR1 and VR2 designs

	9,5	0,4
9,5	19,5	0,6
19,5	38	0,9
38	68	1,1
68	105	1,4
105	155	1,6
155	210	1,9
210	2020	3,6

V-rings, VR3 designs

135	630	1,5
-----	-----	-----

V-rings, VR4 designs

450	2100	6
-----	------	---

Table 28. Axial displacement

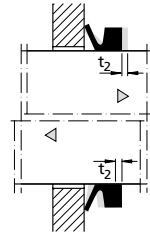

Shaft diameter nominal		Permissible axial displacement
------------------------	--	--------------------------------

d ₁ over	incl	t ₂ max
mm		mm

V-rings, VR1 and VR2 designs

	9,5	0,4
9,5	19,5	0,6
19,5	38	0,9
38	68	1
68	105	1,2
105	155	1,5
155	210	1,8
210	2020	4

V-rings, VR3 designs

135	630	1,5
-----	-----	-----

V-rings, VR4 designs

450	2100	12
-----	------	----

Coaxiality and runout

The total tolerance for the deviation from coaxiality and runout should not exceed the guideline values given in **Table 27**.

Axial displacement

Values for the permissible axial displacement of the V-ring with respect to its counterface are given in **Table 28**.

Counterface

Fine turned counterfaces are adequate for V-rings. Recommended surface roughness values are 2,5 µm for R_a and 12 µm for R_t.

Misalignment

V-rings can tolerate misalignment between shaft and housing axes, i.e. deviations from the perpendicularity between the shaft and counterface on the housing. Guideline values for the maximum permissible misalignment can be obtained from **Diagram 11**. The values apply to V-rings of the VR1 and VR2 designs which are axially supported on the shaft.

The permissible misalignment values for the very compact VR3-design V-rings are appreciably smaller. V-rings of the VR4 design, on the other hand, have a large seal cross section and permit larger misalignments.

Where V-rings are not axially supported on the shaft, the maximum value obtained from the diagram should be reduced and the following equation should be used:

$$\alpha = \alpha_{\max} - 0,0005 n$$

where:

- α permissible misalignment for V-rings without axial support operating at speed n, degrees
- α_{\max} maximum permissible misalignment from Diagram 1, degrees
- n rotational speed, r/min

Example:

A 50 mm diameter shaft is misaligned by 1° with respect to the counterface on the housing. What speed can the shaft be run at if a V-ring of the VR1 design is to be used without axial support?

From Diagram 8 $\alpha_{\max} = 2^\circ$, which gives the permissible speed

$$\alpha_{\max} - \alpha = 2 - 1$$

$$n = 0,0005 \quad = 0,0005 = 2.000 \text{ r/min}$$

This corresponds to a sliding velocity of approximately 5 m/s.

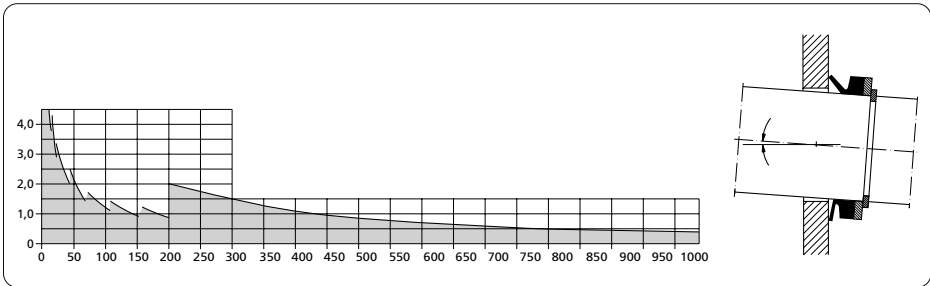

Diagram 11. Maximum permissible misalignment for V-rings of the VR1 and VR2 designs

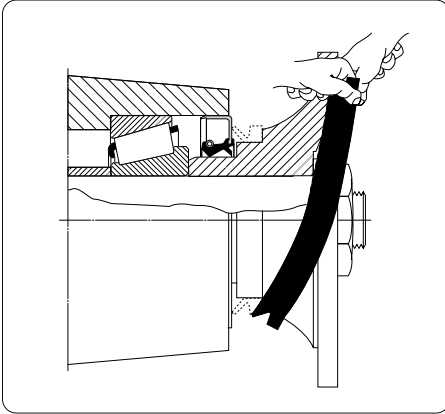

Fig 94

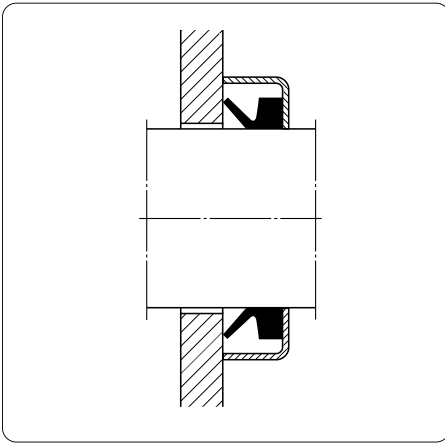

Fig 95

Mounting instructions

V-rings seals are elastic and may be stretched to enable them to be pushed over other components, so that mounting is a simple operation (**fig 94**) may be used to push the seal to its position at a predetermined distance from the counterface.

In cases where many V-rings are to be mounted, a simple tool (**fig 95**) may be used to push the seal to its position at a predetermined distance from the counterface.

If the replacement of V-rings involves the time-consuming dismounting of several other components, the replacement ring may be cut in two and portable vulcanisation equipment used to join the two seal halves once they are in position.

V-ring seals – Metric sizes

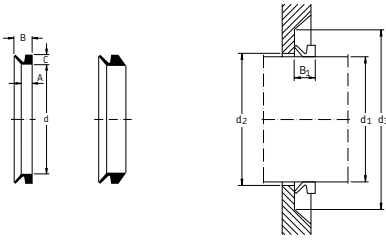

Shaft diameter d_1 (range)	Inside diameter d	Dimension A	Free width B	Height C	Maximum $d_2 = (d_1 +)$	Minimum $d_3 = (d_1 +)$	Fitted width B_1	Design	Lip code	SKF Designation
mm										
2,7-3,5	2,5	2,1	3	1,5	d1+1	d1+4	2,5±0,3	VR1	R	CR 400030
2,7-3,5	2,5	2,1	3	1,5	d1+1	d1+4	2,5±0,3	VR1	V	CR 400034
3,5-4,5	3,2	2,4	3,7	2	d1+1	d1+6	3,0±0,4	VR1	R	CR 400040
3,5-4,5	3,2	2,4	3,7	2	d1+1	d1+6	3,0±0,4	VR1	V	CR 400044
4,5-5,5	4	2,4	3,7	2	d1+1	d1+6	3,0±0,4	VR1	R	CR 400050
4,5-5,5	4	2,4	3,7	2	d1+1	d1+6	3,0±0,4	VR1	V	CR 400054
4,5-5,5	4	3,9	5,2	2	d1+1	d1+6	4,5±0,4	VR2	R	CR 400051
4,5-5,5	4	3,9	5,2	2	d1+1	d1+6	4,5±0,4	VR2	V	CR 400055
5,5-6,5	5	2,4	3,7	2	d1+1	d1+6	3,0±0,4	VR1	R	CR 400060
5,5-6,5	5	2,4	3,7	2	d1+1	d1+6	3,0±0,4	VR1	V	CR 400064
5,5-6,5	5	3,9	5,2	2	d1+1	d1+6	4,5±0,4	VR2	R	CR 400061
5,5-6,5	5	3,9	5,2	2	d1+1	d1+6	4,5±0,4	VR2	V	CR 400065
6,5-8,0	6	2,4	3,7	2	d1+1	d1+6	3,0±0,4	VR1	R	CR 400070
6,5-8,0	6	2,4	3,7	2	d1+1	d1+6	3,0±0,4	VR1	V	CR 400074
6,5-8,0	6	3,9	5,2	2	d1+1	d1+6	4,5±0,4	VR2	R	CR 400071
6,5-8,0	6	3,9	5,2	2	d1+1	d1+6	4,5±0,4	VR2	V	CR 400075
8,0-9,5	7	2,4	3,7	2	d1+1	d1+6	3,0±0,4	VR1	R	CR 400080
8,0-9,5	7	2,4	3,7	2	d1+1	d1+6	3,0±0,4	VR1	V	CR 400084
8,0-9,5	7	3,9	5,2	2	d1+1	d1+6	4,5±0,4	VR2	R	CR 400081
8,0-9,5	7	3,9	5,2	2	d1+1	d1+6	4,5±0,4	VR2	V	CR 400085
9,5-11,5	9	3,4	5,5	3	d1+1	d1+9	4,5±0,6	VR1	R	CR 400100
9,5-11,5	9	3,4	5,5	3	d1+1	d1+9	4,5±0,6	VR1	V	CR 400104
9,5-11,5	9	5,6	7,7	3	d1+1	d1+9	6,7±0,6	VR2	R	CR 400101
9,5-11,5	9	5,6	7,7	3	d1+1	d1+9	6,7±0,6	VR2	V	CR 400105
11,5-12,5	10,5	3,4	5,5	3	d1+1	d1+9	4,5±0,6	VR1	R	CR 400120
11,5-12,5	10,5	3,4	5,5	3	d1+1	d1+9	4,5±0,6	VR1	V	CR 400124
11,5-13,5	10,5	5,6	7,7	3	d1+1	d1+9	6,7±0,6	VR2	R	CR 400121
11,5-13,5	10,5	5,6	7,7	3	d1+1	d1+9	6,7±0,6	VR2	V	CR 400125
12,5-13,5	11,7	3,4	5,5	3	d1+1	d1+9	4,5±0,6	VR1	R	CR 400130
12,5-13,5	11,7	3,4	5,5	3	d1+1	d1+9	4,5±0,6	VR1	V	CR 400134
13,5-15,5	12,5	3,4	5,5	3	d1+1	d1+9	4,5±0,6	VR1	R	CR 400140
13,5-15,5	12,5	3,4	5,5	3	d1+1	d1+9	4,5±0,6	VR1	V	CR 400144
13,5-15,5	12,5	5,6	7,7	3	d1+1	d1+9	6,7±0,6	VR2	R	CR 400141
13,5-15,5	12,5	5,6	7,7	3	d1+1	d1+9	6,7±0,6	VR2	V	CR 400145
15,5-17	14	3,4	5,5	3	d1+1	d1+9	4,5±0,6	VR1	R	CR 400160

Select the larger V-ring when the dimension d_1 is on the boundary between two sizes of V-ring.

V-ring seals – Metric sizes

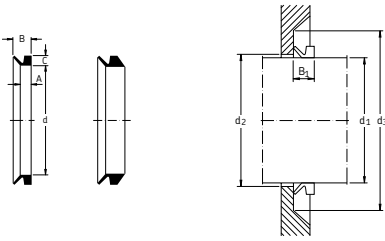

Shaft diameter d_1 (range)	Inside diameter d	Dimension A	Free width B	Height C	Maximum $d_2 = (d_1 +)$	Minimum $d_3 = (d_1 +)$	Fitted width B_1	Design	Lip code	SKF Designation
mm										
15,5-17	14	3,4	5,5	3	d_1+1	d_1+9	$4,5\pm 0,6$	VR1	V	CR 400164
15,5-17,5	14	5,6	7,7	3	d_1+1	d_1+9	$6,7\pm 0,6$	VR2	R	CR 400161
15,5-17,5	14	5,6	7,7	3	d_1+1	d_1+9	$6,7\pm 0,6$	VR2	V	CR 400165
17,5-19	16	3,4	5,5	3	d_1+1	d_1+9	$4,5\pm 0,6$	VR1	R	CR 400180
17,5-19	16	3,4	5,5	3	d_1+1	d_1+9	$4,5\pm 0,6$	VR1	V	CR 400184
17,5-19	16	5,6	7,7	3	d_1+1	d_1+9	$6,7\pm 0,6$	VR2	R	CR 400181
17,5-19	16	5,6	7,7	3	d_1+1	d_1+9	$6,7\pm 0,6$	VR2	V	CR 400185
19-21	18	4,7	7,5	4	d_1+2	d_1+12	$6,0\pm 0,8$	VR1	R	CR 400200
19-21	18	4,7	7,5	4	d_1+2	d_1+12	$6,0\pm 0,8$	VR1	V	CR 400204
19-21	18	7,9	10,5	4	d_1+2	d_1+12	$9,0\pm 0,8$	VR2	R	CR 400201
19-21	18	7,9	10,5	4	d_1+2	d_1+12	$9,0\pm 0,8$	VR2	V	CR 400205
21-24	20	4,7	7,5	4	d_1+2	d_1+12	$6,0\pm 0,8$	VR1	R	CR 400220
21-24	20	4,7	7,5	4	d_1+2	d_1+12	$6,0\pm 0,8$	VR1	V	CR 400224
21-24	20	7,9	10,5	4	d_1+2	d_1+12	$9,0\pm 0,8$	VR2	R	CR 400221
21-24	20	7,9	10,5	4	d_1+2	d_1+12	$9,0\pm 0,8$	VR2	V	CR 400225
24-27	22	4,7	7,5	4	d_1+2	d_1+12	$6,0\pm 0,8$	VR1	R	CR 400250
24-27	22	4,7	7,5	4	d_1+2	d_1+12	$6,0\pm 0,8$	VR1	V	CR 400254
24-27	22	7,9	10,5	4	d_1+2	d_1+12	$9,0\pm 0,8$	VR2	R	CR 400251
24-27	22	7,9	10,5	4	d_1+2	d_1+12	$9,0\pm 0,8$	VR2	V	CR 400255
27-29	25	4,7	7,5	4	d_1+2	d_1+12	$6,0\pm 0,8$	VR1	R	CR 400280
27-29	25	4,7	7,5	4	d_1+2	d_1+12	$6,0\pm 0,8$	VR1	V	CR 400284
27-29	25	7,9	10,5	4	d_1+2	d_1+12	$9,0\pm 0,8$	VR2	R	CR 400281
27-29	25	7,9	10,5	4	d_1+2	d_1+12	$9,0\pm 0,8$	VR2	V	CR 400285
29-31	27	4,7	7,5	4	d_1+2	d_1+12	$6,0\pm 0,8$	VR1	R	CR 400300
29-31	27	4,7	7,5	4	d_1+2	d_1+12	$6,0\pm 0,8$	VR1	V	CR 400304
29-31	27	7,9	10,5	4	d_1+2	d_1+12	$9,0\pm 0,8$	VR2	R	CR 400301
29-31	27	7,9	10,5	4	d_1+2	d_1+12	$9,0\pm 0,8$	VR2	V	CR 400305
31-33	29	4,7	7,5	4	d_1+2	d_1+12	$6,0\pm 0,8$	VR1	R	CR 400320
31-33	29	4,7	7,5	4	d_1+2	d_1+12	$6,0\pm 0,8$	VR1	V	CR 400324
31-33	29	7,9	10,5	4	d_1+2	d_1+12	$9,0\pm 0,8$	VR2	R	CR 400321
31-33	29	7,9	10,5	4	d_1+2	d_1+12	$9,0\pm 0,8$	VR2	V	CR 400325
33-36	31	4,7	7,5	4	d_1+2	d_1+12	$6,0\pm 0,8$	VR1	R	CR 400350
33-36	31	4,7	7,5	4	d_1+2	d_1+12	$6,0\pm 0,8$	VR1	V	CR 400354
33-36	31	7,9	10,5	4	d_1+2	d_1+12	$9,0\pm 0,8$	VR2	R	CR 400351
33-36	31	7,9	10,5	4	d_1+2	d_1+12	$9,0\pm 0,8$	VR2	V	CR 400355

Select the larger V-ring when the dimension d_1 is on the boundary between two sizes of V-ring.

V-ring seals – Metric sizes

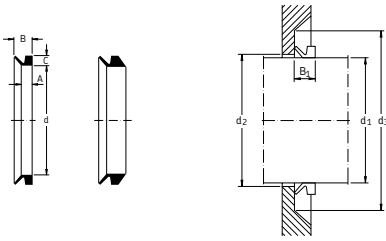

Shaft diameter d_1 (range)	Inside diameter d	Dimension A	Free width B	Height C	Maximum $d_2 = (d_1 +)$	Minimum $d_3 = (d_1 +)$	Fitted width B_1	Design	Lip code	SKF Designation
mm										
36-38	34	4,7	7,5	4	d_1+2	d_1+12	$6,0\pm 0,8$	VR1	R	CR 400380
36-38	34	4,7	7,5	4	d_1+2	d_1+12	$6,0\pm 0,8$	VR1	V	CR 400384
36-38	34	7,9	10,5	4	d_1+2	d_1+12	$9,0\pm 0,8$	VR2	R	CR 400381
36-38	34	7,9	10,5	4	d_1+2	d_1+12	$9,0\pm 0,8$	VR2	V	CR 400385
38-43	36	5,5	9	5	d_1+2	d_1+15	$7,0\pm 1$	VR1	R	CR 400400
38-43	36	5,5	9	5	d_1+2	d_1+15	$7,0\pm 1$	VR1	V	CR 400404
38-43	36	9,5	13	5	d_1+2	d_1+15	$11,0\pm 1$	VR2	R	CR 400401
38-43	36	9,5	13	5	d_1+2	d_1+15	$11,0\pm 1$	VR2	V	CR 400405
43-48	40	5,5	9	5	d_1+2	d_1+15	$7,0\pm 1$	VR1	R	CR 400450
43-48	40	5,5	9	5	d_1+2	d_1+15	$7,0\pm 1$	VR1	V	CR 400454
43-48	40	9,5	13	5	d_1+2	d_1+15	$11,0\pm 1$	VR2	R	CR 400451
43-48	40	9,5	13	5	d_1+2	d_1+15	$11,0\pm 1$	VR2	V	CR 400455
48-53	45	5,5	9	5	d_1+2	d_1+15	$7,0\pm 1$	VR1	R	CR 400500
48-53	45	5,5	9	5	d_1+2	d_1+15	$7,0\pm 1$	VR1	V	CR 400504
48-53	45	9,5	13	5	d_1+2	d_1+15	$11,0\pm 1$	VR2	R	CR 400501
48-53	45	9,5	13	5	d_1+2	d_1+15	$11,0\pm 1$	VR2	V	CR 400505
53-58	49	5,5	9	5	d_1+2	d_1+15	$7,0\pm 1$	VR1	R	CR 400550
53-58	49	5,5	9	5	d_1+2	d_1+15	$7,0\pm 1$	VR1	V	CR 400554
53-58	49	9,5	13	5	d_1+2	d_1+15	$11,0\pm 1$	VR2	R	CR 400551
53-58	49	9,5	13	5	d_1+2	d_1+15	$11,0\pm 1$	VR2	V	CR 400555
58-63	54	5,5	9	5	d_1+2	d_1+15	$7,0\pm 1$	VR1	R	CR 400600
58-63	54	5,5	9	5	d_1+2	d_1+15	$7,0\pm 1$	VR1	V	CR 400604
58-63	54	9,5	13	5	d_1+2	d_1+15	$11,0\pm 1$	VR2	R	CR 400601
58-63	54	9,5	13	5	d_1+2	d_1+15	$11,0\pm 1$	VR2	V	CR 400605
63-68	58	5,5	9	5	d_1+2	d_1+15	$7,0\pm 1$	VR1	R	CR 400650
63-68	58	5,5	9	5	d_1+2	d_1+15	$7,0\pm 1$	VR1	V	CR 400654
63-68	58	9,5	13	5	d_1+2	d_1+15	$11,0\pm 1$	VR2	R	CR 400651
63-68	58	9,5	13	5	d_1+2	d_1+15	$11,0\pm 1$	VR2	V	CR 400655
68-73	63	6,8	11	6	d_1+3	d_1+18	$9,0\pm 1,2$	VR1	R	CR 400700
68-73	63	6,8	11	6	d_1+3	d_1+18	$9,0\pm 1,2$	VR1	V	CR 400704
68-73	63	11,3	15,5	6	d_1+3	d_1+18	$13,5\pm 1,2$	VR2	R	CR 400701
68-73	63	11,3	15,5	6	d_1+3	d_1+18	$13,5\pm 1,2$	VR2	V	CR 400705
73-78	67	6,8	11	6	d_1+3	d_1+18	$9,0\pm 1,2$	VR1	R	CR 400750
73-78	67	6,8	11	6	d_1+3	d_1+18	$13,5\pm 1,2$	VR2	R	CR 400751
73-78	67	11,3	15,5	6	d_1+3	d_1+18	$13,5\pm 1,2$	VR2	V	CR 400755

Select the larger V-ring when the dimension d_1 is on the boundary between two sizes of V-ring.

V-ring seals – Metric sizes

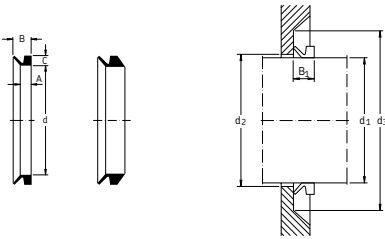

Shaft diameter d_1 (range)	Inside diameter d	Dimension A	Free width B	Height C	Maximum $d_2 = (d_1 +)$	Minimum $d_3 = (d_1 +)$	Fitted width B_1	Design	Lip code	SKF Designation
mm										
78-83	72	6,8	11	6	d_1+3	d_1+18	$9,0\pm 1,2$	VR1	R	CR 400800
78-83	72	6,8	11	6	d_1+3	d_1+18	$9,0\pm 1,2$	VR1	V	CR 400804
78-83	72	11,3	15,5	6	d_1+3	d_1+18	$13,5\pm 1,2$	VR2	R	CR 400801
78-83	72	11,3	15,5	6	d_1+3	d_1+18	$13,5\pm 1,2$	VR2	V	CR 400805
83-88	76	6,8	11	6	d_1+3	d_1+18	$9,0\pm 1,2$	VR1	R	CR 400850
83-88	76	6,8	11	6	d_1+3	d_1+18	$9,0\pm 1,2$	VR1	V	CR 400854
83-88	76	11,3	15,5	6	d_1+3	d_1+18	$13,5\pm 1,2$	VR2	R	CR 400851
83-88	76	11,3	15,5	6	d_1+3	d_1+18	$13,5\pm 1,2$	VR2	V	CR 400855
88-93	81	6,8	11	6	d_1+3	d_1+18	$9,0\pm 1,2$	VR1	R	CR 400900
88-93	81	6,8	11	6	d_1+3	d_1+18	$9,0\pm 1,2$	VR1	V	CR 400904
88-93	81	11,3	15,5	6	d_1+3	d_1+18	$13,5\pm 1,2$	VR2	R	CR 400901
88-93	81	11,3	15,5	6	d_1+3	d_1+18	$13,5\pm 1,2$	VR2	V	CR 400905
93-98	85	6,8	11	6	d_1+3	d_1+18	$9,0\pm 1,2$	VR1	R	CR 400950
93-98	85	6,8	11	6	d_1+3	d_1+18	$9,0\pm 1,2$	VR1	V	CR 400954
93-98	85	11,3	15,5	6	d_1+3	d_1+18	$13,5\pm 1,2$	VR2	R	CR 400951
93-98	85	11,3	15,5	6	d_1+3	d_1+18	$13,5\pm 1,2$	VR2	V	CR 400955
98-105	90	6,8	11	6	d_1+3	d_1+18	$9,0\pm 1,2$	VR1	R	CR 401000
98-105	90	6,8	11	6	d_1+3	d_1+18	$9,0\pm 1,2$	VR1	V	CR 401004
98-105	90	11,3	15,5	6	d_1+3	d_1+18	$13,5\pm 1,2$	VR2	R	CR 401001
98-105	90	11,3	15,5	6	d_1+3	d_1+18	$13,5\pm 1,2$	VR2	V	CR 401005
105-115	99	6	10,5	6,5	d_1+5	d_1+20	$8,0\pm 1,5$	VR3	R	CR 401102
105-115	99	6	10,5	6,5	d_1+5	d_1+20	$8,0\pm 1,5$	VR3	V	CR 401106
105-115	99	7,9	12,8	7	d_1+4	d_1+21	$10,5\pm 1,5$	VR1	R	CR 401100
105-115	99	7,9	12,8	7	d_1+4	d_1+21	$10,5\pm 1,5$	VR1	V	CR 401104
105-115	99	13,1	18	7	d_1+4	d_1+21	$15,5\pm 1,5$	VR2	R	CR 401101
105-115	99	13,1	18	7	d_1+4	d_1+21	$15,5\pm 1,5$	VR2	V	CR 401105
115-125	108	6	10,5	6,5	d_1+5	d_1+20	$8,0\pm 1,5$	VR3	R	CR 401202
115-125	108	6	10,5	6,5	d_1+5	d_1+20	$8,0\pm 1,5$	VR3	V	CR 401206
115-125	108	7,9	12,8	7	d_1+4	d_1+21	$10,5\pm 1,5$	VR1	R	CR 401200
115-125	108	7,9	12,8	7	d_1+4	d_1+21	$10,5\pm 1,5$	VR1	V	CR 401204
115-125	108	13,1	18	7	d_1+4	d_1+21	$15,5\pm 1,5$	VR2	R	CR 401201
115-125	108	13,1	18	7	d_1+4	d_1+21	$15,5\pm 1,5$	VR2	V	CR 401205
125-135	117	6	10,5	6,5	d_1+5	d_1+20	$8,0\pm 1,5$	VR3	R	CR 401302
125-135	117	6	10,5	6,5	d_1+5	d_1+20	$8,0\pm 1,5$	VR3	V	CR 401306
125-135	117	7,9	12,8	7	d_1+4	d_1+21	$10,5\pm 1,5$	VR1	R	CR 401300

Select the larger V-ring when the dimension d_1 is on the boundary between two sizes of V-ring.

V-ring seals – Metric sizes

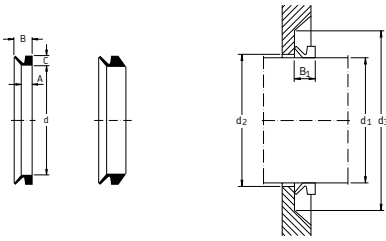

Shaft diameter d_1 (range)	Inside diameter d	Dimension A	Free width B	Height C	Maximum $d_2 = (d_1 +)$	Minimum $d_3 = (d_1 +)$	Fitted width B_1	Design	Lip code	SKF Designation
mm										
125-135	117	7,9	12,8	7	d_1+4	d_1+21	$10,5\pm 1,5$	VR1	V	CR 401304
125-135	117	13,1	18	7	d_1+4	d_1+21	$15,5\pm 1,5$	VR2	R	CR 401301
125-135	117	13,1	18	7	d_1+4	d_1+21	$15,5\pm 1,5$	VR2	V	CR 401305
135-145	126	6	10,5	6,5	d_1+5	d_1+20	$8,0\pm 1,5$	VR3	R	CR 401402
135-145	126	6	10,5	6,5	d_1+5	d_1+20	$8,0\pm 1,5$	VR3	V	CR 401406
135-145	126	7,9	12,8	7	d_1+4	d_1+21	$10,5\pm 1,5$	VR1	R	CR 401400
135-145	126	7,9	12,8	7	d_1+4	d_1+21	$10,5\pm 1,5$	VR1	V	CR 401404
135-145	126	13,1	18	7	d_1+4	d_1+21	$15,5\pm 1,5$	VR2	R	CR 401401
135-145	126	13,1	18	7	d_1+4	d_1+21	$15,5\pm 1,5$	VR2	V	CR 401405
145-155	135	6	10,5	6,5	d_1+5	d_1+20	$8,0\pm 1,5$	VR3	R	CR 401502
145-155	135	6	10,5	6,5	d_1+5	d_1+20	$8,0\pm 1,5$	VR3	V	CR 401506
145-155	135	7,9	12,8	7	d_1+4	d_1+21	$10,5\pm 1,5$	VR1	R	CR 401500
145-155	135	7,9	12,8	7	d_1+4	d_1+21	$10,5\pm 1,5$	VR1	V	CR 401504
145-155	135	13,1	18	7	d_1+4	d_1+21	$15,5\pm 1,5$	VR2	R	CR 401501
145-155	135	13,1	18	7	d_1+4	d_1+21	$15,5\pm 1,5$	VR2	V	CR 401505
155-165	144	6	10,5	6,5	d_1+5	d_1+20	$8,0\pm 1,5$	VR3	R	CR 401602
155-165	144	6	10,5	6,5	d_1+5	d_1+20	$8,0\pm 1,5$	VR3	V	CR 401606
155-165	144	9	14,5	8	d_1+4	d_1+24	$12,0\pm 1,8$	VR1	R	CR 401600
155-165	144	9	14,5	8	d_1+4	d_1+24	$12,0\pm 1,8$	VR1	V	CR 401604
155-165	144	15	20,5	8	d_1+4	d_1+24	$18,0\pm 1,8$	VR2	R	CR 401601
155-165	144	15	20,5	8	d_1+4	d_1+24	$18,0\pm 1,8$	VR2	V	CR 401605
165-175	153	6	10,5	6,5	d_1+5	d_1+20	$8,0\pm 1,5$	VR3	R	CR 401702
165-175	153	6	10,5	6,5	d_1+5	d_1+20	$8,0\pm 1,5$	VR3	V	CR 401706
165-175	153	9	14,5	8	d_1+4	d_1+24	$12,0\pm 1,8$	VR1	R	CR 401700
165-175	153	9	14,5	8	d_1+4	d_1+24	$12,0\pm 1,8$	VR1	V	CR 401704
165-175	153	15	20,5	8	d_1+4	d_1+24	$18,0\pm 1,8$	VR2	R	CR 401701
165-175	153	15	20,5	8	d_1+4	d_1+24	$18,0\pm 1,8$	VR2	V	CR 401705
175-185	162	6	10,5	6,5	d_1+5	d_1+20	$8,0\pm 1,5$	VR3	R	CR 401802
175-185	162	6	10,5	6,5	d_1+5	d_1+20	$8,0\pm 1,5$	VR3	V	CR 401806
175-185	162	9	14,5	8	d_1+4	d_1+24	$12,0\pm 1,8$	VR1	R	CR 401800
175-185	162	9	14,5	8	d_1+4	d_1+24	$12,0\pm 1,8$	VR1	V	CR 401804
175-185	162	15	20,5	8	d_1+4	d_1+24	$18,0\pm 1,8$	VR2	R	CR 401801
175-185	162	15	20,5	8	d_1+4	d_1+24	$18,0\pm 1,8$	VR2	V	CR 401805
185-195	171	6	10,5	6,5	d_1+5	d_1+20	$8,0\pm 1,5$	VR3	R	CR 401902
185-195	171	6	10,5	6,5	d_1+5	d_1+20	$8,0\pm 1,5$	VR3	V	CR 401906

Select the larger V-ring when the dimension d_1 is on the boundary between two sizes of V-ring.

V-ring seals – Metric sizes

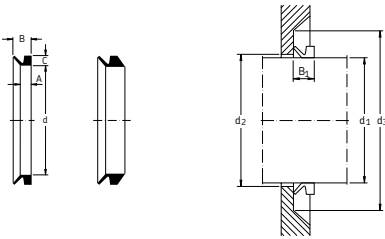

Shaft diameter d_1 (range)	Inside diameter d	Dimension A	Free width B	Height C	Maximum $d_2 = (d_1 +)$	Minimum $d_3 = (d_1 +)$	Fitted width B_1	Design	Lip code	SKF Designation
mm										
185-195	171	9	14,5	8	d_1+4	d_1+24	$12,0\pm 1,8$	VR1	R	CR 401900
185-195	171	9	14,5	8	d_1+4	d_1+24	$12,0\pm 1,8$	VR1	V	CR 401904
185-195	171	15	20,5	8	d_1+4	d_1+24	$18,0\pm 1,8$	VR2	R	CR 401901
185-195	171	15	20,5	8	d_1+4	d_1+24	$18,0\pm 1,8$	VR2	V	CR 401905
195-210	180	9	14,5	8	d_1+4	d_1+24	$12,0\pm 1,8$	VR1	R	CR 401990
195-210	180	9	14,5	8	d_1+4	d_1+24	$12,0\pm 1,8$	VR1	V	CR 401994
190-210	180	14,3	25	15	d_1+10	d_1+45	$20,0\pm 4$	VR1	R	CR 402000
190-210	180	14,3	25	15	d_1+10	d_1+45	$20,0\pm 4$	VR1	V	CR 402004
195-210	180	15	20,5	8	d_1+4	d_1+24	$18,0\pm 1,8$	VR2	R	CR 401991
195-210	180	15	20,5	8	d_1+4	d_1+24	$18,0\pm 1,8$	VR2	V	CR 401995
195-210	182	6	10,5	6,5	d_1+5	d_1+20	$8,0\pm 1,5$	VR3	R	CR 402002
195-210	182	6	10,5	6,5	d_1+5	d_1+20	$8,0\pm 1,5$	VR3	V	CR 402006
210-233	198	6	10,5	6,5	d_1+5	d_1+20	$8,0\pm 1,5$	VR3	R	CR 402004
210-233	198	6	10,5	6,5	d_1+5	d_1+20	$8,0\pm 1,5$	VR3	V	CR 402206
210-235	198	14,3	25	15	d_1+10	d_1+45	$20,0\pm 4$	VR1	R	CR 402200
210-235	198	14,3	25	15	d_1+10	d_1+45	$20,0\pm 4$	VR1	V	CR 402204
233-260	225	6	10,5	6,5	d_1+5	d_1+20	$8,0\pm 1,5$	VR3	R	CR 402502
233-260	225	6	10,5	6,5	d_1+5	d_1+20	$8,0\pm 1,5$	VR3	V	CR 402506
235-265	225	14,3	25	15	d_1+10	d_1+45	$20,0\pm 4$	VR1	R	CR 402500
235-265	225	14,3	25	15	d_1+10	d_1+45	$20,0\pm 4$	VR1	V	CR 402504
260-285	247	6	10,5	6,5	d_1+5	d_1+20	$8,0\pm 1,5$	VR3	R	CR 402752
260-285	247	6	10,5	6,5	d_1+5	d_1+20	$8,0\pm 1,5$	VR3	V	CR 402756
265-290	247	14,3	25	15	d_1+10	d_1+45	$20,0\pm 4$	VR1	R	CR 402750
265-290	247	14,3	25	15	d_1+10	d_1+45	$20,0\pm 4$	VR1	V	CR 402754
285-310	270	6	10,5	6,5	d_1+5	d_1+20	$8,0\pm 1,5$	VR3	R	CR 403002
285-310	270	6	10,5	6,5	d_1+5	d_1+20	$8,0\pm 1,5$	VR3	V	CR 403006
290-310	270	14,3	25	15	d_1+10	d_1+45	$20,0\pm 4$	VR1	R	CR 403000
290-310	270	14,3	25	15	d_1+10	d_1+45	$20,0\pm 4$	VR1	V	CR 403004
310-335	292	6	10,5	6,5	d_1+5	d_1+20	$8,0\pm 1,5$	VR3	R	CR 403252
310-335	292	6	10,5	6,5	d_1+5	d_1+20	$8,0\pm 1,5$	VR3	V	CR 403256
310-335	292	14,3	25	15	d_1+10	d_1+45	$20,0\pm 4$	VR1	R	CR 403250
310-335	292	14,3	25	15	d_1+10	d_1+45	$20,0\pm 4$	VR1	V	CR 403254
300-305	294	32,5	65	21	d_1+24	d_1+115	50 ± 12	VR6	R	CR 470301
300-305	294	32,5	65	30	d_1+24	d_1+115	50 ± 12	VR4	R	CR 403003
305-310	299	32,5	65	30	d_1+24	d_1+115	50 ± 12	VR4	R	CR 403053

Select the larger V-ring when the dimension d_1 is on the boundary between two sizes of V-ring.

V-ring seals – Metric sizes

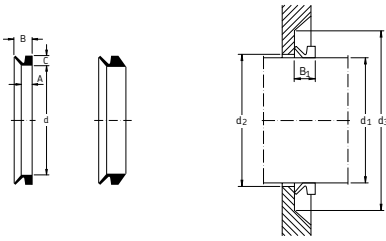

Shaft diameter d_1 (range)	Inside diameter d	Dimension A	Free width B	Height C	Maximum $d_2 = (d_1 +)$	Minimum $d_3 = (d_1 +)$	Fitted width B_1	Design	Lip code	SKF Designation
mm										
310-315	304	32,5	65	21	d1+24	d1+115	50±12	VR6	R	CR 470311
310-315	304	32,5	65	30	d1+24	d1+115	50±12	VR4	R	CR 403303
315-320	309	32,5	65	30	d1+24	d1+115	50±12	VR4	R	CR 403153
320-325	314	32,5	65	30	d1+24	d1+115	50±12	VR4	R	CR 403203
335-365	315	6	10,5	6,5	d1+5	d1+20	8,0±1,5	VR3	R	CR 403502
335-365	315	6	10,5	6,5	d1+5	d1+20	8,0±1,5	VR3	V	CR 403506
335-365	315	14,3	25	15	d1+10	d1+45	20,0±4	VR1	R	CR 403500
335-365	315	14,3	25	15	d1+10	d1+45	20,0±4	VR1	V	CR 403504
325-330	319	32,5	65	21	d1+24	d1+115	50±12	VR6	R	CR 470326
325-330	319	32,5	65	30	d1+24	d1+115	50±12	VR4	R	CR 403253
330-335	323	32,5	65	30	d1+24	d1+115	50±12	VR4	R	CR 403303
335-340	328	32,5	65	30	d1+24	d1+115	50±12	VR4	R	CR 403353
340-345	333	32,5	65	21	d1+24	d1+115	50±12	VR6	R	CR 470341
340-345	333	32,5	65	30	d1+24	d1+115	50±12	VR4	R	CR 403403
365-385	337	6	10,5	6,5	d1+5	d1+20	8,0±1,5	VR3	R	CR 403752
365-385	337	6	10,5	6,5	d1+5	d1+20	8,0±1,5	VR3	V	CR 403756
365-390	337	14,3	25	15	d1+10	d1+45	20,0±4	VR1	R	CR 403750
365-390	337	14,3	25	15	d1+10	d1+45	20,0±4	VR1	V	CR 403754
345-350	338	32,5	65	30	d1+24	d1+115	50±12	VR4	R	CR 403453
350-355	343	32,5	65	21	d1+24	d1+115	50±12	VR6	R	CR 470351
350-355	343	32,5	65	30	d1+24	d1+115	50±12	VR4	R	CR 403503
355-360	347	32,5	65	21	d1+24	d1+115	50±12	VR6	R	CR 470356
355-360	347	32,5	65	30	d1+24	d1+115	50±12	VR4	R	CR 403553
360-365	352	32,5	65	30	d1+24	d1+115	50±12	VR4	R	CR 403603
365-370	357	32,5	65	30	d1+24	d1+115	50±12	VR4	R	CR 403653
385-410	360	6	10,5	6,5	d1+5	d1+20	8,0±1,5	VR3	R	CR 404002
385-410	360	6	10,5	6,5	d1+5	d1+20	8,0±1,5	VR3	V	CR 404006
390-430	360	14,3	25	15	d1+10	d1+45	20,0±4	VR1	R	CR 404000
390-430	360	14,3	25	15	d1+10	d1+45	20,0±4	VR1	V	CR 404004
370-375	362	32,5	65	21	d1+24	d1+115	50±12	VR6	R	CR 470371
370-375	362	32,5	65	30	d1+24	d1+115	50±12	VR4	R	CR 403703
375-380	367	32,5	65	21	d1+24	d1+115	50±12	VR6	R	CR 403776
375-380	367	32,5	65	30	d1+24	d1+115	50±12	VR4	R	CR 403753
380-385	371	32,5	65	21	d1+24	d1+115	50±12	VR6	R	CR 470381
380-385	371	32,5	65	30	d1+24	d1+115	50±12	VR4	R	CR 403803

Select the larger V-ring when the dimension d_1 is on the boundary between two sizes of V-ring.

V-ring seals – Metric sizes

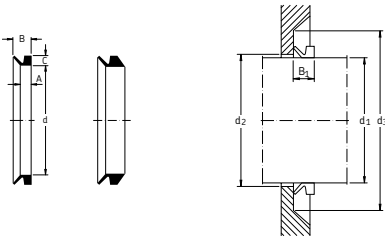

Shaft diameter d_1 (range)	Inside diameter d	Dimension A	Free width B	Height C	Maximum $d_2 = (d_1 +)$	Minimum $d_3 = (d_1 +)$	Fitted width B_1	Design	Lip code	SKF Designation
mm										
385-390	376	32,5	65	30	d1+24	d1+115	50±12	VR4	R	CR 403853
390-395	381	32,5	65	21	d1+24	d1+115	50±12	VR6	R	CR 470391
390-395	381	32,5	65	30	d1+24	d1+115	50±12	VR4	R	CR 403903
410-440	382	6	10,5	6,5	d1+5	d1+20	8,0±1,5	VR3	R	CR 404252
410-440	382	6	10,5	6,5	d1+5	d1+20	8,0±1,5	VR3	V	CR 404256
395-400	386	32,5	65	30	d1+24	d1+115	50±12	VR4	R	CR 403953
400-405	391	32,5	65	21	d1+24	d1+115	50±12	VR6	R	CR 470401
400-405	391	32,5	65	30	d1+24	d1+115	50±12	VR4	R	CR 404003
405-410	396	32,5	65	30	d1+24	d1+115	50±12	VR4	R	CR 404053
410-415	401	32,5	65	21	d1+24	d1+115	50±12	VR6	R	CR 470411
410-415	401	32,5	65	30	d1+24	d1+115	50±12	VR4	R	CR 404103
440-475	405	6	10,5	6,5	d1+5	d1+20	8,0±1,5	VR3	R	CR 404502
440-475	405	6	10,5	6,5	d1+5	d1+20	8,0±1,5	VR3	V	CR 404506
430-480	405	14,3	25	15	d1+10	d1+45	20,0±4	VR1	R	CR 404500
430-480	405	14,3	25	15	d1+10	d1+45	20,0±4	VR1	V	CR 404504
415-420	405	32,5	65	30	d1+24	d1+115	50±12	VR4	R	CR 404153
420-425	410	32,5	65	21	d1+24	d1+115	50±12	VR6	R	CR 470421
420-425	410	32,5	65	30	d1+24	d1+115	50±12	VR4	R	CR 404203
425-430	415	32,5	65	30	d1+24	d1+115	50±12	VR4	R	CR 404253
430-435	420	32,5	65	21	d1+24	d1+115	50±12	VR6	R	CR 470431
430-435	420	32,5	65	30	d1+24	d1+115	50±12	VR4	R	CR 404303
435-440	425	32,5	65	30	d1+24	d1+115	50±12	VR4	R	CR 404353
440-445	429	32,5	65	30	d1+24	d1+115	50±12	VR4	R	CR 404403
445-450	434	32,5	65	30	d1+24	d1+115	50±12	VR4	R	CR 404453
450-455	439	32,5	65	30	d1+24	d1+115	50±12	VR4	R	CR 404503
450-455	439	67,5	100	13	d1+24	d1+115	85±12	VR5	R	CR 470450
455-460	444	32,5	65	30	d1+24	d1+115	50±12	VR4	R	CR 404553
460-465	448	32,5	65	21	d1+24	d1+115	50±12	VR6	R	CR 470461
460-465	448	32,5	65	30	d1+24	d1+115	50±12	VR4	R	CR 404603
475-510	450	6	10,5	6,5	d1+5	d1+20	8,0±1,5	VR3	R	CR 405002
475-510	450	6	10,5	6,5	d1+5	d1+20	8,0±1,5	VR3	V	CR 405006
480-530	450	14,3	25	15	d1+10	d1+45	20,0±4	VR1	R	CR 405000
480-530	450	14,3	25	15	d1+10	d1+45	20,0±4	VR1	V	CR 405004
465-470	453	32,5	65	30	d1+24	d1+115	50±12	VR4	R	CR 404653
470-475	458	32,5	65	30	d1+24	d1+115	50±12	VR4	R	CR 404703

Select the larger V-ring when the dimension d_1 is on the boundary between two sizes of V-ring.

V-ring seals – Metric sizes

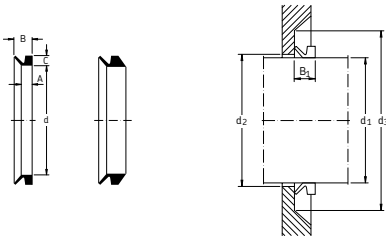

Shaft diameter d_1 (range)	Inside diameter d	Dimension A	Free width B	Height C	Maximum $d_2 = (d_1 +)$	Minimum $d_3 = (d_1 +)$	Fitted width B_1	Design	Lip code	SKF Designation
mm										
475-480	463	32,5	65	21	d_1+24	d_1+115	50 ± 12	VR6	R	CR 470476
475-480	463	32,5	65	30	d_1+24	d_1+115	50 ± 12	VR4	R	CR 404753
480-485	468	32,5	65	30	d_1+24	d_1+115	50 ± 12	VR4	R	CR 404803
510-540	472	6	10,5	6,5	d_1+5	d_1+20	$8,0\pm 1,5$	VR3	R	CR 405252
510-540	472	6	10,5	6,5	d_1+5	d_1+20	$8,0\pm 1,5$	VR3	V	CR 405256
485-490	473	32,5	65	30	d_1+24	d_1+115	50 ± 12	VR4	R	CR 404853
490-495	478	32,5	65	30	d_1+24	d_1+115	50 ± 12	VR4	R	CR 404903
495-500	483	32,5	65	21	d_1+24	d_1+115	50 ± 12	VR6	R	CR 470496
495-500	483	32,5	65	30	d_1+24	d_1+115	50 ± 12	VR4	R	CR 404953
500-505	488	32,5	65	30	d_1+24	d_1+115	50 ± 12	VR4	R	CR 405003
500-505	488	67,5	100	13	d_1+24	d_1+115	85 ± 12	VR5	R	CR 470500
505-510	493	32,5	65	30	d_1+24	d_1+115	50 ± 12	VR4	R	CR 405053
540-575	495	6	10,5	6,5	d_1+5	d_1+20	$8,0\pm 1,5$	VR3	R	CR 405502
540-575	495	6	10,5	6,5	d_1+5	d_1+20	$8,0\pm 1,5$	VR3	V	CR 405506
530-580	495	14,3	25	15	d_1+10	d_1+45	$20,0\pm 4$	VR1	R	CR 405500
530-580	495	14,3	25	15	d_1+10	d_1+45	$20,0\pm 4$	VR1	V	CR 405504
510-515	497	32,5	65	30	d_1+24	d_1+115	50 ± 12	VR4	R	CR 405103
515-520	502	32,5	65	30	d_1+24	d_1+115	50 ± 12	VR4	R	CR 405153
520-525	507	32,5	65	30	d_1+24	d_1+115	50 ± 12	VR4	R	CR 405203
525-530	512	32,5	65	21	d_1+24	d_1+115	50 ± 12	VR6	R	CR 470526
525-530	512	32,5	65	30	d_1+24	d_1+115	50 ± 12	VR4	R	CR 405253
530-535	517	32,5	65	30	d_1+24	d_1+115	50 ± 12	VR4	R	CR 405303
535-540	521	32,5	65	30	d_1+24	d_1+115	50 ± 12	VR4	R	CR 405353
540-545	526	32,5	65	30	d_1+24	d_1+115	50 ± 12	VR4	R	CR 405403
545-550	531	32,5	65	30	d_1+24	d_1+115	50 ± 12	VR4	R	CR 405453
550-555	536	32,5	65	30	d_1+24	d_1+115	50 ± 12	VR4	R	CR 405503
550-555	536	67,5	100	13	d_1+24	d_1+115	85 ± 12	VR5	R	CR 470550
575-625	540	6	10,5	6,5	d_1+5	d_1+20	$8,0\pm 1,5$	VR3	R	CR 406002
575-625	540	6	10,5	6,5	d_1+5	d_1+20	$8,0\pm 1,5$	VR3	V	CR 406006
580-630	540	14,3	25	15	d_1+10	d_1+45	$20,0\pm 4$	VR1	R	CR 406000
580-630	540	14,3	25	15	d_1+10	d_1+45	$20,0\pm 4$	VR1	V	CR 406004
555-560	541	32,5	65	30	d_1+24	d_1+115	50 ± 12	VR4	R	CR 405553
560-565	546	32,5	65	30	d_1+24	d_1+115	50 ± 12	VR4	R	CR 405603
565-570	550	32,5	65	30	d_1+24	d_1+115	50 ± 12	VR4	R	CR 405653
570-575	555	32,5	65	30	d_1+24	d_1+115	50 ± 12	VR4	R	CR 405703

Select the larger V-ring when the dimension d_1 is on the boundary between two sizes of V-ring.

V-ring seals – Metric sizes

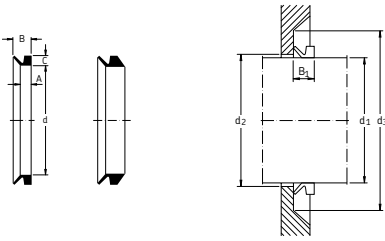

Shaft diameter d_1 (range)	Inside diameter d	Dimension A	Free width B	Height C	Maximum $d_2 = (d_1 +)$	Minimum $d_3 = (d_1 +)$	Fitted width B_1	Design	Lip code	SKF Designation
mm										
575-580	560	32,5	65	30	d_1+24	d_1+115	50 ± 12	VR4	R	CR 405753
580-585	565	32,5	65	30	d_1+24	d_1+115	50 ± 12	VR4	R	CR 405803
585-590	570	32,5	65	30	d_1+24	d_1+115	50 ± 12	VR4	R	CR 405853
590-600	575	32,5	65	30	d_1+24	d_1+115	50 ± 12	VR4	R	CR 405903
600-610	582	32,5	65	30	d_1+24	d_1+115	50 ± 12	VR4	R	CR 406003
600-610	582	67,5	100	13	d_1+24	d_1+115	85 ± 12	VR5	R	CR 470600
610-620	592	32,5	65	30	d_1+24	d_1+115	50 ± 12	VR4	R	CR 406103
615-675	600	6	10,5	6,5	d_1+5	d_1+20	$8,0\pm 1,5$	VR3	R	CR 406502
615-675	600	6	10,5	6,5	d_1+5	d_1+20	$8,0\pm 1,5$	VR3	V	CR 406506
630-665	600	14,3	25	15	d_1+10	d_1+45	$20,0\pm 4$	VR1	R	CR 406500
630-665	600	14,3	25	15	d_1+10	d_1+45	$20,0\pm 4$	VR1	V	CR 406504
620-630	602	32,5	65	30	d_1+24	d_1+115	50 ± 12	VR4	R	CR 406203
630-640	612	32,5	65	30	d_1+24	d_1+115	50 ± 12	VR4	R	CR 406303
640-650	621	32,5	65	30	d_1+24	d_1+115	50 ± 12	VR4	R	CR 406403
675-710	630	6	10,5	6,5	d_1+5	d_1+20	$8,0\pm 1,5$	VR3	R	CR 407002
675-710	630	6	10,5	6,5	d_1+5	d_1+20	$8,0\pm 1,5$	VR3	V	CR 407006
665-705	630	14,3	25	15	d_1+10	d_1+45	$20,0\pm 4$	VR1	R	CR 407000
665-705	630	14,3	25	15	d_1+10	d_1+45	$20,0\pm 4$	VR1	V	CR 407004
650-660	631	32,5	65	21	d_1+24	d_1+115	50 ± 12	VR6	R	CR 470651
650-660	631	32,5	65	30	d_1+24	d_1+115	50 ± 12	VR4	R	CR 406503
650-660	631	67,5	100	13	d_1+24	d_1+115	85 ± 12	VR5	R	CR 470650
660-670	640	32,5	65	21	d_1+24	d_1+115	50 ± 12	VR6	R	CR 470661
660-670	640	32,5	65	30	d_1+24	d_1+115	50 ± 12	VR4	R	CR 406603
670-680	650	32,5	65	21	d_1+24	d_1+115	50 ± 12	VR6	R	CR 470671
670-680	650	32,5	65	30	d_1+24	d_1+115	50 ± 12	VR4	R	CR 406703
680-690	660	32,5	65	21	d_1+24	d_1+115	50 ± 12	VR6	R	CR 470681
680-690	660	32,5	65	30	d_1+24	d_1+115	50 ± 12	VR4	R	CR 406803
710-740	670	6	10,5	6,5	d_1+5	d_1+20	$8,0\pm 1,5$	VR3	R	CR 407252
710-740	670	6	10,5	6,5	d_1+5	d_1+20	$8,0\pm 1,5$	VR3	V	CR 407256
705-745	670	14,3	25	15	d_1+10	d_1+45	$20,0\pm 4$	VR1	R	CR 407250
705-745	670	14,3	25	15	d_1+10	d_1+45	$20,0\pm 4$	VR1	V	CR 407254
690-700	670	32,5	65	21	d_1+24	d_1+115	50 ± 12	VR6	R	CR 470691
690-700	670	32,5	65	30	d_1+24	d_1+115	50 ± 12	VR4	R	CR 406903
700-710	680	32,5	65	30	d_1+24	d_1+115	50 ± 12	VR4	R	CR 407003
700-710	680	67,5	100	13	d_1+24	d_1+115	85 ± 12	VR5	R	CR 470700

Select the larger V-ring when the dimension d_1 is on the boundary between two sizes of V-ring.

V-ring seals – Metric sizes

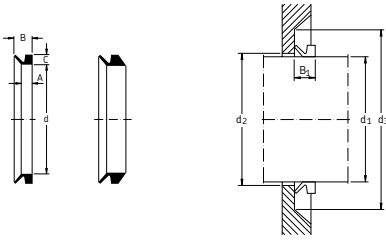

Shaft diameter d_1 (range)	Inside diameter d	Dimension A	Free width B	Height C	Maximum $d_2 = (d_1 +)$	Minimum $d_3 = (d_1 +)$	Fitted width B_1	Design	Lip code	SKF Designation
mm										
710-720	689	32,5	65	30	d_1+24	d_1+115	50 ± 12	VR4	R	CR 407103
720-730	699	32,5	65	30	d_1+24	d_1+115	50 ± 12	VR4	R	CR 407203
740-775	705	6	10,5	6,5	d_1+5	d_1+20	$8,0\pm 1,5$	VR3	R	CR 407502
740-775	705	6	10,5	6,5	d_1+5	d_1+20	$8,0\pm 1,5$	VR3	V	CR 407506
745-785	705	14,3	25	15	d_1+10	d_1+45	$20,0\pm 4$	VR1	R	CR 407500
745-785	705	14,3	25	15	d_1+10	d_1+45	$20,0\pm 4$	VR1	V	CR 407504
730-740	709	32,5	65	30	d_1+24	d_1+115	50 ± 12	VR4	R	CR 407303
740-750	718	32,5	65	30	d_1+24	d_1+115	50 ± 12	VR4	R	CR 407403
750-758	728	32,5	65	21	d_1+24	d_1+115	50 ± 12	VR6	R	CR 407051
750-758	728	32,5	65	30	d_1+24	d_1+115	50 ± 12	VR4	R	CR 407503
750-758	728	67,5	100	13	d_1+24	d_1+115	85 ± 12	VR5	R	CR 407050
758-766	735	32,5	65	21	d_1+24	d_1+115	50 ± 12	VR6	R	CR 407061
758-766	735	32,5	65	30	d_1+24	d_1+115	50 ± 12	VR4	R	CR 407603
766-774	743	32,5	65	30	d_1+24	d_1+115	50 ± 12	VR4	R	CR 407703
775-825	745	6	10,5	6,5	d_1+5	d_1+20	$8,0\pm 1,5$	VR3	R	CR 408002
775-825	745	6	10,5	6,5	d_1+5	d_1+20	$8,0\pm 1,5$	VR3	V	CR 408006
785-830	745	14,3	25	15	d_1+10	d_1+45	$20,0\pm 4$	VR1	R	CR 408000
785-830	745	14,3	25	15	d_1+10	d_1+45	$20,0\pm 4$	VR1	V	CR 408004
774-783	751	32,5	65	30	d_1+24	d_1+115	50 ± 12	VR4	R	CR 407803
783-792	759	32,5	65	21	d_1+24	d_1+115	50 ± 12	VR6	R	CR 407091
783-792	759	32,5	65	30	d_1+24	d_1+115	50 ± 12	VR4	R	CR 407903
792-801	768	32,5	65	21	d_1+24	d_1+115	50 ± 12	VR6	R	CR 407801
792-801	768	32,5	65	30	d_1+24	d_1+115	50 ± 12	VR4	R	CR 408003
792-801	768	67,5	100	13	d_1+24	d_1+115	85 ± 12	VR5	R	CR 407800
801-810	777	32,5	65	30	d_1+24	d_1+115	50 ± 12	VR4	R	CR 408103
825-875	785	6	10,5	6,5	d_1+5	d_1+20	$8,0\pm 1,5$	VR3	R	CR 408502
825-875	785	6	10,5	6,5	d_1+5	d_1+20	$8,0\pm 1,5$	VR3	V	CR 408506
830-875	785	14,3	25	15	d_1+10	d_1+45	$20,0\pm 4$	VR1	R	CR 408500
830-875	785	14,3	25	15	d_1+10	d_1+45	$20,0\pm 4$	VR1	V	CR 408504
810-821	786	32,5	65	30	d_1+24	d_1+115	50 ± 12	VR4	R	CR 408203
821-831	796	32,5	65	21	d_1+24	d_1+115	50 ± 12	VR6	R	CR 407831
821-831	796	32,5	65	30	d_1+24	d_1+115	50 ± 12	VR4	R	CR 408303
831-841	805	32,5	65	30	d_1+24	d_1+115	50 ± 12	VR4	R	CR 408403
841-851	814	32,5	65	30	d_1+24	d_1+115	50 ± 12	VR4	R	CR 408503
841-851	814	67,5	100	13	d_1+24	d_1+115	85 ± 12	VR5	R	CR 407850

Select the larger V-ring when the dimension d_1 is on the boundary between two sizes of V-ring.

V-ring seals – Metric sizes

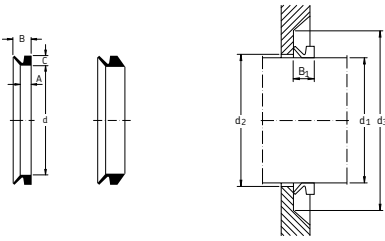

Shaft diameter d_1 (range)	Inside diameter d	Dimension A	Free width B	Height C	Maximum $d_2 = (d_1 +)$	Minimum $d_3 = (d_1 +)$	Fitted width B_1	Design	Lip code	SKF Designation
mm										
851-861	824	32,5	65	30	d_1+24	d_1+115	50 ± 12	VR4	R	CR 408603
875-925	825	6	10,5	6,5	d_1+5	d_1+20	$8,0\pm 1,5$	VR3	R	CR 409002
875-925	825	6	10,5	6,5	d_1+5	d_1+20	$8,0\pm 1,5$	VR3	V	CR 409006
875-920	825	14,3	25	15	d_1+10	d_1+45	$20,0\pm 4$	VR1	R	CR 409000
875-920	825	14,3	25	15	d_1+10	d_1+45	$20,0\pm 4$	VR1	V	CR 409004
861-871	833	32,5	65	30	d_1+24	d_1+115	50 ± 12	VR4	R	CR 408703
871-882	843	32,5	65	21	d_1+24	d_1+115	50 ± 12	VR6	R	CR 470881
871-882	843	32,5	65	30	d_1+24	d_1+115	50 ± 12	VR4	R	CR 408803
882-892	853	32,5	65	30	d_1+24	d_1+115	50 ± 12	VR4	R	CR 408903
925-975	865	6	10,5	6,5	d_1+5	d_1+20	$8,0\pm 1,5$	VR3	R	CR 409502
925-975	865	6	10,5	6,5	d_1+5	d_1+20	$8,0\pm 1,5$	VR3	V	CR 409506
920-965	865	14,3	25	15	d_1+10	d_1+45	$20,0\pm 4$	VR1	R	CR 409500
920-965	865	14,3	25	15	d_1+10	d_1+45	$20,0\pm 4$	VR1	V	CR 409504
892-912	871	32,5	65	21	d_1+24	d_1+115	50 ± 12	VR6	R	CR 470901
892-912	871	32,5	65	30	d_1+24	d_1+115	50 ± 12	VR4	R	CR 409003
892-912	871	67,5	100	13	d_1+24	d_1+115	85 ± 12	VR5	R	CR 470900
912-922	880	32,5	65	30	d_1+24	d_1+115	50 ± 12	VR4	R	CR 409203
922-933	890	32,5	65	30	d_1+24	d_1+115	50 ± 12	VR4	R	CR 409303
933-944	900	32,5	65	30	d_1+24	d_1+115	50 ± 12	VR4	R	CR 409403
975-1025	910	6	10,5	6,5	d_1+5	d_1+20	$8,0\pm 1,5$	VR3	R	CR 410002
975-1025	910	6	10,5	6,5	d_1+5	d_1+20	$8,0\pm 1,5$	VR3	V	CR 410006
944-955	911	32,5	65	30	d_1+24	d_1+115	50 ± 12	VR4	R	CR 409503
944-955	911	67,5	100	13	d_1+24	d_1+115	85 ± 12	VR5	R	CR 470950
955-966	921	32,5	65	30	d_1+24	d_1+115	50 ± 12	VR4	R	CR 409603
966-977	932	32,5	65	30	d_1+24	d_1+115	50 ± 12	VR4	R	CR 409703
977-988	942	32,5	65	21	d_1+24	d_1+115	50 ± 12	VR6	R	CR 470981
977-988	942	32,5	65	30	d_1+24	d_1+115	50 ± 12	VR4	R	CR 409803
988-999	953	32,5	65	30	d_1+24	d_1+115	50 ± 12	VR4	R	CR 409903
1025-1075	955	6	10,5	6,5	d_1+5	d_1+20	$8,0\pm 1,5$	VR3	R	CR 410502
1025-1075	955	6	10,5	6,5	d_1+5	d_1+20	$8,0\pm 1,5$	VR3	V	CR 410506
1015-1065	955	14,3	25	15	d_1+10	d_1+45	$20,0\pm 4$	VR1	R	CR 410500
999-1010	963	32,5	65	30	d_1+24	d_1+115	50 ± 12	VR4	R	CR 410003
999-1010	963	67,5	100	13	d_1+24	d_1+115	85 ± 12	VR5	R	CR 471000
1010-1025	973	32,5	65	30	d_1+24	d_1+115	50 ± 12	VR4	R	CR 410203
1025-1045	990	32,5	65	21	d_1+24	d_1+115	50 ± 12	VR6	R	CR 471041

Select the larger V-ring when the dimension d_1 is on the boundary between two sizes of V-ring.

V-ring seals – Metric sizes

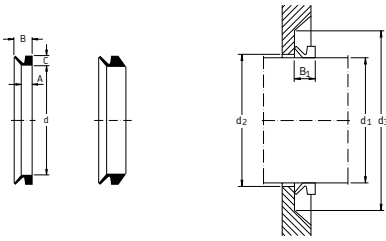

Shaft diameter d_1 (range)	Inside diameter d	Dimension A	Free width B	Height C	Maximum $d_2 = (d_1 +)$	Minimum $d_3 = (d_1 +)$	Fitted width B_1	Design	Lip code	SKF Designation
mm										
1025-1045	990	32,5	65	30	d_1+24	d_1+115	50 ± 12	VR4	R	CR 410403
1075-1125	1000	6	10,5	6,5	d_1+5	d_1+20	$8,0\pm 1,5$	VR3	R	CR 411002
1075-1125	1000	6	10,5	6,5	d_1+5	d_1+20	$8,0\pm 1,5$	VR3	V	CR 411006
1065-1115	1000	14,3	25	15	d_1+10	d_1+45	$20,0\pm 4$	VR1	R	CR 411000
1045-1065	1008	32,5	65	30	d_1+24	d_1+115	50 ± 12	VR4	R	CR 410603
1065-1085	1027	32,5	65	30	d_1+24	d_1+115	50 ± 12	VR4	R	CR 410803
1125-1175	1045	6	10,5	6,5	d_1+5	d_1+20	$8,0\pm 1,5$	VR3	R	CR 411502
1125-1175	1045	6	10,5	6,5	d_1+5	d_1+20	$8,0\pm 1,5$	VR3	V	CR 411506
1115-1165	1045	14,3	25	15	d_1+10	d_1+45	$20,0\pm 4$	VR1	R	CR 411500
1085-1105	1045	32,5	65	30	d_1+24	d_1+115	50 ± 12	VR4	R	CR 411003
1085-1105	1045	67,5	100	13	d_1+24	d_1+115	85 ± 12	VR5	R	CR 471100
1105-1125	1065	32,5	65	30	d_1+24	d_1+115	50 ± 12	VR4	R	CR 411203
1125-1145	1084	32,5	65	30	d_1+24	d_1+115	50 ± 12	VR4	R	CR 411403
1175-1225	1090	6	10,5	6,5	d_1+5	d_1+20	$8,0\pm 1,5$	VR3	R	CR 412002
1165-1215	1090	14,3	25	15	d_1+10	d_1+45	$20,0\pm 4$	VR1	R	CR 412000
1145-1165	1103	32,5	65	30	d_1+24	d_1+115	50 ± 12	VR4	R	CR 411603
1165-1185	1121	32,5	65	30	d_1+24	d_1+115	50 ± 12	VR4	R	CR 411803
1225-1275	1135	6	10,5	6,5	d_1+5	d_1+20	$8,0\pm 1,5$	VR3	R	CR 412502
1225-1275	1135	6	10,5	6,5	d_1+5	d_1+20	$8,0\pm 1,5$	VR3	V	CR 412506
1215-1270	1135	14,3	25	15	d_1+10	d_1+45	$20,0\pm 4$	VR1	R	CR 412500
1185-1205	1139	32,5	65	21	d_1+24	d_1+115	50 ± 12	VR6	R	CR 471201
1185-1205	1139	32,5	65	30	d_1+24	d_1+115	50 ± 12	VR4	R	CR 412003
1185-1205	1139	67,5	100	13	d_1+24	d_1+115	85 ± 12	VR5	R	CR 471200
1205-1225	1157	32,5	65	30	d_1+24	d_1+115	50 ± 12	VR4	R	CR 412203
1225-1245	1176	32,5	65	30	d_1+24	d_1+115	50 ± 12	VR4	R	CR 412403
1275-1325	1180	6	10,5	6,5	d_1+5	d_1+20	$8,0\pm 1,5$	VR3	R	CR 413002
1275-1325	1180	6	10,5	6,5	d_1+5	d_1+20	$8,0\pm 1,5$	VR3	V	CR 413006
1270-1320	1180	14,3	25	15	d_1+10	d_1+45	$20,0\pm 4$	VR1	R	CR 413000
1245-1270	1195	32,5	65	30	d_1+24	d_1+115	50 ± 12	VR4	R	CR 412603
1270-1295	1218	32,5	65	30	d_1+24	d_1+115	50 ± 12	VR4	R	CR 412803
1325-1375	1225	6	10,5	6,5	d_1+5	d_1+20	$8,0\pm 1,5$	VR3	R	CR 413502
1325-1375	1225	6	10,5	6,5	d_1+5	d_1+20	$8,0\pm 1,5$	VR3	V	CR 413506
1320-1370	1225	14,3	25	15	d_1+10	d_1+45	$20,0\pm 4$	VR1	R	CR 413500
1295-1315	1240	32,5	65	30	d_1+24	d_1+115	50 ± 12	VR4	R	CR 413003
1295-1315	1240	67,5	100	13	d_1+24	d_1+115	85 ± 12	VR5	R	CR 471300

Select the larger V-ring when the dimension d_1 is on the boundary between two sizes of V-ring.

V-ring seals – Metric sizes

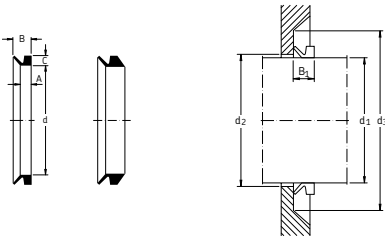

Shaft diameter d_1 (range)	Inside diameter d	Dimension A	Free width B	Height C	Maximum $d_2 = (d_1 +)$	Minimum $d_3 = (d_1 +)$	Fitted width B_1	Design	Lip code	SKF Designation
mm										
1315-1340	1259	32,5	65	30	d_1+24	d_1+115	50 ± 12	VR4	R	CR 413253
1375-1425	1270	6	10,5	6,5	d_1+5	d_1+20	$8,0\pm 1,5$	VR3	R	CR 414002
1375-1425	1270	6	10,5	6,5	d_1+5	d_1+20	$8,0\pm 1,5$	VR3	V	CR 414006
1370-1420	1270	14,3	25	15	d_1+10	d_1+45	$20,0\pm 4$	VR1	R	CR 414000
1340-1365	1281	32,5	65	30	d_1+24	d_1+115	50 ± 12	VR4	R	CR 413503
1340-1365	1281	67,5	100	13	d_1+24	d_1+115	85 ± 12	VR5	R	CR 471350
1365-1390	1305	32,5	65	30	d_1+24	d_1+115	50 ± 12	VR4	R	CR 413753
1425-1475	1315	6	10,5	6,5	d_1+5	d_1+20	$8,0\pm 1,5$	VR3	R	CR 414502
1425-1475	1315	6	10,5	6,5	d_1+5	d_1+20	$8,0\pm 1,5$	VR3	V	CR 414506
1420-1470	1315	14,3	25	15	d_1+10	d_1+45	$20,0\pm 4$	VR1	R	CR 414500
1390-1415	1328	32,5	65	30	d_1+24	d_1+115	50 ± 12	VR4	R	CR 414003
1390-1415	1328	67,5	100	13	d_1+24	d_1+115	85 ± 12	VR5	R	CR 471400
1415-1440	1350	32,5	65	21	d_1+24	d_1+115	50 ± 12	VR6	R	CR 414226
1415-1440	1350	32,5	65	30	d_1+24	d_1+115	50 ± 12	VR4	R	CR 414253
1475-1525	1360	6	10,5	6,5	d_1+5	d_1+20	$8,0\pm 1,5$	VR3	R	CR 415002
1475-1525	1360	6	10,5	6,5	d_1+5	d_1+20	$8,0\pm 1,5$	VR3	V	CR 415006
1470-1520	1360	14,3	25	15	d_1+10	d_1+45	$20,0\pm 4$	VR1	R	CR 415000
1440-1465	1374	32,5	65	21	d_1+24	d_1+115	50 ± 12	VR6	R	CR 471451
1440-1465	1374	32,5	65	30	d_1+24	d_1+115	50 ± 12	VR4	R	CR 414503
1440-1465	1374	67,5	100	13	d_1+24	d_1+115	85 ± 12	VR5	R	CR 471450
1465-1490	1397	32,5	65	30	d_1+24	d_1+115	50 ± 12	VR4	R	CR 414753
1525-1575	1405	6	10,5	6,5	d_1+5	d_1+20	$8,0\pm 1,5$	VR3	R	CR 415502
1525-1575	1405	6	10,5	6,5	d_1+5	d_1+20	$8,0\pm 1,5$	VR3	V	CR 415506
1520-1570	1405	14,3	25	15	d_1+10	d_1+45	$20,0\pm 4$	VR1	R	CR 415500
1490-1515	1419	32,5	65	21	d_1+24	d_1+115	50 ± 12	VR6	R	CR 471501
1490-1515	1419	32,5	65	30	d_1+24	d_1+115	50 ± 12	VR4	R	CR 415003
1490-1515	1419	67,5	100	13	d_1+24	d_1+115	85 ± 12	VR5	R	CR 471500
1515-1540	1443	32,5	65	30	d_1+24	d_1+115	50 ± 12	VR4	R	CR 415253
1575-1625	1450	6	10,5	6,5	d_1+5	d_1+20	$8,0\pm 1,5$	VR3	R	CR 416002
1575-1625	1450	6	10,5	6,5	d_1+5	d_1+20	$8,0\pm 1,5$	VR3	V	CR 416006
1570-1620	1450	14,3	25	15	d_1+10	d_1+45	$20,0\pm 4$	VR1	R	CR 416000
1540-1570	1467	32,5	65	21	d_1+24	d_1+115	50 ± 12	VR6	R	CR 471551
1540-1570	1467	32,5	65	30	d_1+24	d_1+115	50 ± 12	VR4	R	CR 415503
1540-1570	1467	67,5	100	13	d_1+24	d_1+115	85 ± 12	VR5	R	CR 471550
1625-1675	1495	6	10,5	6,5	d_1+5	d_1+20	$8,0\pm 1,5$	VR3	R	CR 416502

Select the larger V-ring when the dimension d_1 is on the boundary between two sizes of V-ring.

V-ring seals – Metric sizes

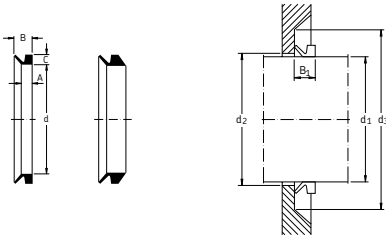

Shaft diameter d_1 (range)	Inside diameter d	Dimension A	Free width B	Height C	Maximum $d_2 = (d_1 +)$	Minimum $d_3 = (d_1 +)$	Fitted width B_1	Design	Lip code	SKF Designation
mm										
1625-1675	1495	6	10,5	6,5	d1+5	d1+20	8,0±1,5	VR3	V	CR 416506
1620-1670	1495	14,3	25	15	d1+10	d1+45	20,0±4	VR1	R	CR 416500
1570-1600	1495	32,5	65	30	d1+24	d1+115	50±12	VR4	R	CR 415753
1600-1640	1524	32,5	65	30	d1+24	d1+115	50±12	VR4	R	CR 416003
1600-1640	1524	67,5	100	13	d1+24	d1+115	85±12	VR5	R	CR 471600
1675-1725	1540	6	10,5	6,5	d1+5	d1+20	8,0±1,5	VR3	R	CR 417002
1675-1725	1540	6	10,5	6,5	d1+5	d1+20	8,0±1,5	VR3	V	CR 417006
1670-1720	1540	14,3	25	15	d1+10	d1+45	20,0±4	VR1	R	CR 417000
1640-1680	1559	32,5	65	30	d1+24	d1+115	50±12	VR4	R	CR 416503
1640-1680	1559	67,5	100	13	d1+24	d1+115	85±12	VR5	R	CR 471650
1725-1775	1585	6	10,5	6,5	d1+5	d1+20	8,0±1,5	VR3	R	CR 417502
1725-1775	1585	6	10,5	6,5	d1+5	d1+20	8,0±1,5	VR3	V	CR 417506
1720-1770	1585	14,3	25	15	d1+10	d1+45	20,0±4	VR1	R	CR 417500
1680-1720	1596	32,5	65	21	d1+24	d1+115	50±12	VR6	R	CR 471701
1680-1720	1596	32,5	65	30	d1+24	d1+115	50±12	VR4	R	CR 417003
1680-1720	1596	67,5	100	13	d1+24	d1+115	85±12	VR5	R	CR 471700
1775-1825	1630	6	10,5	6,5	d1+5	d1+20	8,0±1,5	VR3	R	CR 418002
1775-1825	1630	6	10,5	6,5	d1+5	d1+20	8,0±1,5	VR3	V	CR 418006
1770-1820	1630	14,3	25	15	d1+10	d1+45	20,0±4	VR1	R	CR 418000
1720-1765	1632	32,5	65	21	d1+24	d1+115	50±12	VR6	R	CR 471751
1720-1765	1632	32,5	65	30	d1+24	d1+115	50±12	VR4	R	CR 417503
1720-1765	1632	67,5	100	13	d1+24	d1+115	85±12	VR5	R	CR 471750
1765-1810	1671	32,5	65	30	d1+24	d1+115	50±12	VR4	R	CR 418003
1765-1810	1671	67,5	100	13	d1+24	d1+115	85±12	VR5	R	CR 471800
1825-1875	1675	6	10,5	6,5	d1+5	d1+20	8,0±1,5	VR3	R	CR 418502
1825-1875	1675	6	10,5	6,5	d1+5	d1+20	8,0±1,5	VR3	V	CR 418506
1820-1870	1675	14,3	25	15	d1+10	d1+45	20,0±4	VR1	R	CR 418500
1810-1855	1714	32,5	65	21	d1+24	d1+115	50±12	VR6	R	CR 471851
1810-1855	1714	32,5	65	30	d1+24	d1+115	50±12	VR4	R	CR 418503
1810-1855	1714	67,5	100	13	d1+24	d1+115	85±12	VR5	R	CR 471850
1875-1925	1720	6	10,5	6,5	d1+5	d1+20	8,0±1,5	VR3	R	CR 419002
1875-1925	1720	6	10,5	6,5	d1+5	d1+20	8,0±1,5	VR3	V	CR 419006
1870-1920	1720	14,3	25	15	d1+10	d1+45	20,0±4	VR1	R	CR 419000
1855-1905	1753	32,5	65	21	d1+24	d1+115	50±12	VR6	R	CR 471901
1855-1905	1753	32,5	65	30	d1+24	d1+115	50±12	VR4	R	CR 419003

Select the larger V-ring when the dimension d_1 is on the boundary between two sizes of V-ring.

V-ring seals – Metric sizes

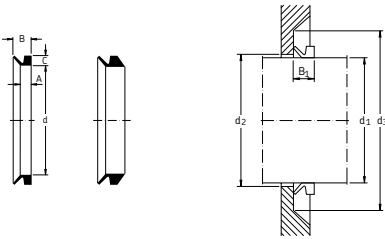

Shaft diameter d_1 (range)	Inside diameter d	Dimension A	Free width B	Height C	Maximum $d_2 = (d_1 +)$	Minimum $d_3 = (d_1 +)$	Fitted width B_1	Design	Lip code	SKF Designation
mm										
1855-1905	1753	67,5	100	13	d_1+24	d_1+115	85 ± 12	VR5	R	CR 471900
1925-1975	1765	6	10,5	6,5	d_1+5	d_1+20	$8,0\pm 1,5$	VR3	R	CR 419502
1925-1975	1765	6	10,5	6,5	d_1+5	d_1+20	$8,0\pm 1,5$	VR3	V	CR 419506
1920-1970	1765	14,3	25	15	d_1+10	d_1+45	$20,0\pm 4$	VR1	R	CR 419500
1905-1955	1794	32,5	65	21	d_1+24	d_1+115	50 ± 12	VR6	R	CR 471951
1905-1955	1794	32,5	65	30	d_1+24	d_1+115	50 ± 12	VR4	R	CR 419503
1905-1955	1794	67,5	100	13	d_1+24	d_1+115	85 ± 12	VR5	R	CR 471950
1975-2025	1810	6	10,5	6,5	d_1+5	d_1+20	$8,0\pm 1,5$	VR3	R	CR 420002
1975-2025	1810	6	10,5	6,5	d_1+5	d_1+20	$8,0\pm 1,5$	VR3	V	CR 420006
1970-2020	1810	14,3	25	15	d_1+10	d_1+45	$20,0\pm 4$	VR1	R	CR 420000
1955-2010	1844	32,5	65	30	d_1+24	d_1+115	50 ± 12	VR4	R	CR 420003
1955-2010	1844	67,5	100	13	d_1+24	d_1+115	85 ± 12	VR5	R	CR 472000

Select the larger V-ring when the dimension d_1 is on the boundary between two sizes of V-ring.

V-ring seals – Inch sizes

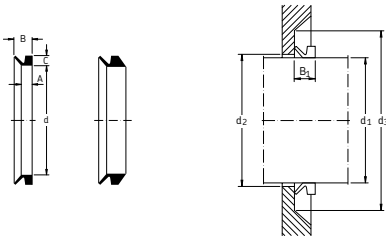

Shaft diameter d_1 (range)	Reference metric shaft size	Inside diameter d	Height C	Dimension A	Free width B	max $d_2 = (d_1 +)$	min $d_3 = (d_1 +)$	Fitted width B_1	Design	Lip code	SKF Designation
in	mm	in	in	in	in	in	in	in			
0.110-0.140	3	.100	.060	.080	.120	.040	.160	.100±.012	VR1	R	CR 400030
0.110-0.140	3	.100	.060	.080	.120	.040	.160	.100±.012	VR1	V	CR 400034
0.140-0.180	4	.130	.080	.090	.150	.040	.240	.120±.016	VR1	R	CR 400040
0.140-0.180	4	.130	.080	.090	.150	.040	.240	.120±.016	VR1	V	CR 400044
0.180-0.210	5	.160	.080	.090	.150	.040	.240	.120±.016	VR1	R	CR 400050
0.180-0.210	5	.160	.080	.150	.200	.040	.240	.180±.016	VR2	R	CR 400051
0.180-0.210	5	.160	.080	.090	.150	.040	.240	.120±.016	VR1	V	CR 400054
0.180-0.210	5	.160	.080	.150	.200	.040	.240	.180±.016	VR2	V	CR 400055
0.210-0.260	6	.200	.080	.090	.150	.040	.240	.120±.016	VR1	R	CR 400060
0.210-0.260	6	.200	.080	.150	.200	.040	.240	.180±.016	VR2	R	CR 400061
0.210-0.260	6	.200	.080	.090	.150	.040	.240	.120±.016	VR1	V	CR 400064
0.210-0.260	6	.200	.080	.150	.200	.040	.240	.180±.016	VR2	V	CR 400065
0.260-0.310	7	.240	.080	.090	.150	.040	.240	.120±.016	VR1	R	CR 400070
0.260-0.310	7	.240	.080	.150	.200	.040	.240	.180±.016	VR2	R	CR 400071
0.260-0.310	7	.240	.080	.090	.150	.040	.240	.120±.016	VR1	V	CR 400074
0.260-0.310	7	.240	.080	.150	.200	.040	.240	.180±.016	VR2	V	CR 400075
0.310-0.370	8	.280	.080	.090	.150	.040	.240	.120±.016	VR1	R	CR 400080
0.310-0.370	8	.280	.080	.150	.200	.040	.240	.180±.016	VR2	R	CR 400081
0.310-0.370	8	.280	.080	.090	.150	.040	.240	.120±.016	VR1	V	CR 400084
0.310-0.370	8	.280	.080	.150	.200	.040	.240	.180±.016	VR2	V	CR 400085
0.370-0.450	10	.350	.120	.130	.220	.080	.350	.180±.020	VR1	R	CR 400100
0.370-0.450	10	.350	.120	.220	.300	.080	.350	.260±.020	VR2	R	CR 400101
0.370-0.450	10	.350	.120	.130	.220	.080	.350	.180±.020	VR1	V	CR 400104
0.370-0.450	10	.350	.120	.220	.300	.080	.350	.260±.020	VR2	V	CR 400105
0.450-0.530	12	.410	.120	.130	.220	.080	.350	.180±.020	VR1	R	CR 400120
0.450-0.530	12	.410	.120	.220	.300	.080	.350	.260±.020	VR2	R	CR 400121
0.450-0.530	12	.410	.120	.130	.220	.080	.350	.180±.020	VR1	V	CR 400124
0.450-0.530	12	.410	.120	.220	.300	.080	.350	.260±.020	VR2	V	CR 400125
0.490-0.570	13	.450	.120	.130	.220	.080	.350	.180±.020	VR1	R	CR 400130
0.490-0.570	13	.450	.120	.130	.220	.080	.350	.180±.020	VR1	V	CR 400134
0.530-0.610	14	.490	.120	.130	.220	.080	.350	.180±.020	VR1	R	CR 400140
0.530-0.610	14	.490	.120	.220	.300	.080	.350	.260±.020	VR2	R	CR 400141
0.530-0.610	14	.490	.120	.130	.220	.080	.350	.180±.020	VR1	V	CR 400144
0.530-0.610	14	.490	.120	.220	.300	.080	.350	.260±.020	VR2	V	CR 400145
0.610-0.690	16	.550	.120	.130	.220	.080	.350	.180±.020	VR1	R	CR 400160

Select the larger V-ring when the dimension d_1 is on the boundary between two sizes of V-ring. Purple dot on V-ring indicates LongLife material. Sizes under .748 (19 mm) are brown with no dot. * Check for availability and pricing.

V-ring seals – Inch sizes

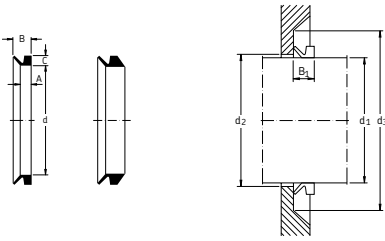

Shaft diameter d_1 (range)	Reference metric shaft size	Inside diameter d	Height C	Dimension A	Free width B	max $d_2 = (d_1 +)$	min $d_3 = (d_1 +)$	Fitted width B_1	Design	Lip code	SKF Designation
in	mm	in	in	in	in	in	in	in			
0.610-0.690	16	.550	.120	.220	.300	.080	.350	.260±.020	VR2	R	CR 400161
0.610-0.690	16	.550	.120	.130	.220	.080	.350	.180±.020	VR1	V	CR 400164
0.610-0.690	16	.550	.120	.220	.300	.080	.350	.260±.020	VR2	V	CR 400165
0.690-0.750	18	.630	.120	.130	.220	.080	.350	.180±.020	VR1	R	CR 400180
0.690-0.770	18	.630	.120	.220	.300	.080	.350	.260±.020	VR2	R	CR 400181
0.690-0.750	18	.630	.120	.130	.220	.080	.350	.180±.020	VR1	V	CR 400184
0.690-0.770	18	.630	.120	.220	.300	.080	.350	.260±.020	VR2	V	CR 400185
0.750-0.830	20	.710	.160	.190	.300	.080	.470	.240±.030	VR1	R	CR 400200
0.770-0.830	20	.710	.160	.310	.410	.080	.470	.350±.030	VR2	R	CR 400201
0.750-0.830	20	.710	.160	.190	.300	.080	.470	.240±.030	VR1	V	CR 400204
0.770-0.830	20	.710	.160	.310	.410	.080	.470	.350±.030	VR2	V	CR 400205
0.830-0.950	22	.790	.160	.190	.300	.080	.470	.240±.030	VR1	R	CR 400220
0.830-0.950	22	.790	.160	.310	.410	.080	.470	.350±.030	VR2	R	CR 400221
0.830-0.950	22	.790	.160	.190	.300	.080	.470	.240±.030	VR1	V	CR 400224
0.830-0.950	22	.790	.160	.310	.410	.080	.470	.350±.030	VR2	V	CR 400225
0.950-1.070	25	.870	.160	.190	.300	.080	.470	.240±.030	VR1	R	CR 400250
0.950-1.070	25	.870	.160	.310	.410	.080	.470	.350±.030	VR2	R	CR 400251
0.950-1.070	25	.870	.160	.190	.300	.080	.470	.240±.030	VR1	V	CR 400254
0.950-1.070	25	.870	.160	.310	.410	.080	.470	.350±.030	VR2	V	CR 400255
1.070-1.140	28	.980	.160	.190	.300	.120	.470	.240±.030	VR1	R	CR 400280
1.070-1.140	28	.980	.160	.310	.410	.120	.470	.350±.030	VR2	R	CR 400281
1.070-1.140	28	.980	.160	.190	.300	.120	.470	.240±.030	VR1	V	CR 400284
1.070-1.140	28	.980	.160	.310	.410	.120	.470	.350±.030	VR2	V	CR 400285
1.140-1.220	30	1.060	.160	.190	.300	.120	.470	.240±.030	VR1	R	CR 400300
1.140-1.220	30	1.060	.160	.310	.410	.120	.470	.350±.030	VR2	R	CR 400301
1.140-1.220	30	1.060	.160	.190	.300	.120	.470	.240±.030	VR1	V	CR 400304
1.140-1.220	30	1.060	.160	.310	.410	.120	.470	.350±.030	VR2	V	CR 400305
1.220-1.300	32	1.140	.160	.190	.300	.120	.470	.240±.030	VR1	R	CR 400320
1.220-1.300	32	1.140	.160	.310	.410	.120	.470	.350±.030	VR2	R	CR 400321
1.220-1.300	32	1.140	.160	.190	.300	.120	.470	.240±.030	VR1	V	CR 400324
1.220-1.300	32	1.140	.160	.310	.410	.120	.470	.350±.030	VR2	V	CR 400325
1.300-1.420	35	1.220	.160	.190	.300	.120	.470	.240±.030	VR1	R	CR 400350
1.300-1.420	35	1.220	.160	.310	.410	.120	.470	.350±.030	VR2	R	CR 400351
1.300-1.420	35	1.220	.160	.190	.300	.120	.470	.240±.030	VR1	V	CR 400354
1.300-1.420	35	1.220	.160	.310	.410	.120	.470	.350±.030	VR2	V	CR 400355

Select the larger V-ring when the dimension d_1 is on the boundary between two sizes of V-ring. Purple dot on V-ring indicates LongLife material. Sizes under .748 (19 mm) are brown with no dot. * Check for availability and pricing.

V-ring seals – Inch sizes

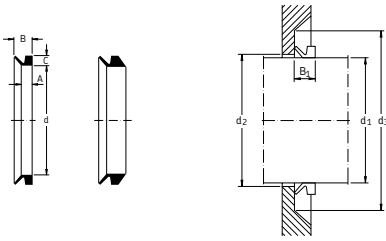

Shaft diameter d_1 (range)	Reference metric shaft size	Inside diameter d	Height C	Dimension A	Free width B	max $d_2 = (d_1 +)$	min $d_3 = (d_1 +)$	Fitted width B_1	Design	Lip code	SKF Designation
in	mm	in	in	in	in	in	in	in			
1.420-1.500	38	1.340	.160	.190	.300	.120	.470	.240±.030	VR1	R	CR 400380
1.420-1.500	38	1.340	.160	.310	.410	.120	.470	.350±.030	VR2	R	CR 400381
1.420-1.500	38	1.340	.160	.190	.300	.120	.470	.240±.030	VR1	V	CR 400384
1.420-1.500	38	1.340	.160	.310	.410	.120	.470	.350±.030	VR2	V	CR 400385
1.500-1.700	40	1.420	.200	.220	.350	.120	.590	.280±.040	VR1	R	CR 400400
1.500-1.700	40	1.420	.200	.370	.510	.120	.590	.430±.040	VR2	R	CR 400401
1.500-1.700	40	1.420	.200	.220	.350	.120	.590	.280±.040	VR1	V	CR 400404
1.500-1.700	40	1.420	.200	.370	.510	.120	.590	.430±.040	VR2	V	CR 400405
1.700-1.890	45	1.570	.200	.220	.350	.120	.590	.280±.040	VR1	R	CR 400450
1.700-1.890	45	1.570	.200	.370	.510	.120	.590	.430±.040	VR2	R	CR 400451
1.700-1.890	45	1.570	.200	.220	.350	.120	.590	.280±.040	VR1	V	CR 400454
1.700-1.890	45	1.570	.200	.370	.510	.120	.590	.430±.040	VR2	V	CR 400455
1.890-2.090	50	1.770	.200	.220	.350	.120	.590	.280±.040	VR1	R	CR 400500
1.890-2.090	50	1.770	.200	.370	.510	.120	.590	.430±.040	VR2	R	CR 400501
1.890-2.090	50	1.770	.200	.220	.350	.120	.590	.280±.040	VR1	V	CR 400504
1.890-2.090	50	1.770	.200	.370	.510	.120	.590	.430±.040	VR2	V	CR 400505
2.090-2.290	55	1.930	.200	.220	.350	.120	.590	.280±.040	VR1	R	CR 400550
2.090-2.290	55	1.930	.200	.370	.510	.120	.590	.430±.040	VR2	R	CR 400551
2.090-2.290	55	1.930	.200	.220	.350	.120	.590	.280±.040	VR1	V	CR 400554
2.090-2.290	55	1.930	.200	.370	.510	.120	.590	.430±.040	VR2	V	CR 400555
2.290-2.480	60	2.130	.200	.220	.350	.120	.590	.280±.040	VR1	R	CR 400600
2.290-2.480	60	2.130	.200	.370	.510	.120	.590	.430±.040	VR2	R	CR 400601
2.290-2.480	60	2.130	.200	.220	.350	.120	.590	.280±.040	VR1	V	CR 400604
2.290-2.480	60	2.130	.200	.370	.510	.120	.590	.430±.040	VR2	V	CR 400605
2.480-2.680	65	2.280	.200	.220	.350	.120	.590	.280±.040	VR1	R	CR 400650
2.480-2.680	65	2.280	.200	.370	.510	.120	.590	.430±.040	VR2	R	CR 400651
2.480-2.680	65	2.280	.200	.220	.350	.120	.590	.280±.040	VR1	V	CR 400654
2.480-2.680	65	2.280	.200	.370	.510	.120	.590	.430±.040	VR2	V	CR 400655
2.480-2.680	65	2.280	.200	.220	.350	.120	.590	.280±.040	VR1	R	CR 400659
2.680-2.880	70	2.480	.240	.270	.430	.160	.710	.350±.050	VR1	R	CR 400700
2.680-2.880	70	2.480	.240	.440	.610	.160	.710	.530±.050	VR2	R	CR 400701
2.680-2.880	70	2.480	.240	.270	.430	.160	.710	.350±.050	VR1	V	CR 400704
2.680-2.880	70	2.480	.240	.440	.610	.160	.710	.530±.050	VR2	V	CR 400705
2.880-3.070	75	2.640	.240	.270	.430	.160	.710	.350±.050	VR1	R	CR 400750
2.880-3.070	75	2.640	.240	.440	.610	.160	.710	.530±.050	VR2	R	CR 400751

Select the larger V-ring when the dimension d_1 is on the boundary between two sizes of V-ring. Purple dot on V-ring indicates LongLife material. Sizes under .748 (19 mm) are brown with no dot. * Check for availability and pricing.

V-ring seals – Inch sizes

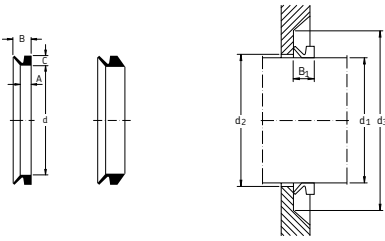

Shaft diameter d_1 (range)	Reference metric shaft size	Inside diameter d	Height C	Dimension A	Free width B	max $d_2 = (d_1 +)$	min $d_3 = (d_1 +)$	Fitted width B_1	Design	Lip code	SKF Designation
in	mm	in	in	in	in	in	in	in			
2.880-3.070	75	2.640	.240	.270	.430	.160	.710	.350±.050	VR1	V	CR 400754
2.880-3.070	75	2.640	.240	.440	.610	.160	.710	.530±.050	VR2	V	CR 400755
3.070-3.270	80	2.830	.240	.270	.430	.160	.710	.350±.050	VR1	R	CR 400800
3.070-3.270	80	2.830	.240	.440	.610	.160	.710	.530±.050	VR2	R	CR 400801
3.070-3.270	80	2.830	.240	.270	.430	.160	.710	.350±.050	VR1	V	CR 400804
3.070-3.270	80	2.830	.240	.440	.610	.160	.710	.530±.050	VR2	V	CR 400805
3.270-3.470	85	2.990	.240	.270	.430	.160	.710	.350±.050	VR1	R	CR 400850
3.270-3.470	85	2.940	.240	.440	.610	.160	.710	.530±.050	VR2	R	CR 400851
3.270-3.470	85	2.990	.240	.270	.430	.160	.710	.350±.050	VR1	V	CR 400854
3.270-3.470	85	2.940	.240	.440	.610	.160	.710	.530±.050	VR2	V	CR 400855
3.470-3.660	90	3.190	.240	.270	.430	.160	.710	.350±.050	VR1	R	CR 400900
3.470-3.660	90	3.190	.240	.440	.610	.160	.710	.530±.050	VR2	R	CR 400901
3.470-3.660	90	3.190	.240	.270	.430	.160	.710	.350±.050	VR1	V	CR 400904
3.470-3.660	90	3.190	.240	.440	.610	.160	.710	.530±.050	VR2	V	CR 400905
3.660-3.860	95	3.350	.240	.270	.430	.160	.710	.350±.050	VR1	R	CR 400950
3.660-3.860	95	3.350	.240	.440	.610	.160	.710	.530±.050	VR2	R	CR 400951
3.660-3.860	95	3.350	.240	.270	.430	.160	.710	.350±.050	VR1	V	CR 400954
3.660-3.860	95	3.350	.240	.440	.610	.160	.710	.530±.050	VR2	V	CR 400955
3.860-4.140	100	3.540	.240	.270	.430	.160	.710	.350±.050	VR1	R	CR 401000
3.860-4.140	100	3.540	.240	.440	.610	.160	.710	.530±.050	VR2	R	CR 401001
3.860-4.140	100	3.540	.240	.270	.430	.160	.710	.350±.050	VR1	V	CR 401004
3.860-4.140	100	3.540	.240	.440	.610	.160	.710	.530±.050	VR2	V	CR 401005
4.140-4.530	110	3.900	.280	.310	.500	.160	.830	.410±.060	VR1	R	CR 401100
4.140-4.530	110	3.900	.280	.520	.710	.160	.830	.610±.060	VR2	R	CR 401101
4.140-4.530	110	3.900	.280	.310	.500	.160	.830	.410±.060	VR1	V	CR 401104
4.140-4.530	110	3.900	.280	.520	.710	.160	.830	.610±.060	VR2	V	CR 401105
4.530-4.920	120	4.250	.280	.310	.500	.160	.830	.410±.060	VR1	R	CR 401200
4.530-4.920	120	4.250	.280	.520	.710	.160	.830	.610±.060	VR2	R	CR 401201
4.530-4.920	120	4.250	.260	.240	.410	.200	.800	.315±.060	VR3	V	CR 401202*
4.530-4.920	120	4.250	.280	.310	.500	.160	.830	.410±.060	VR1	V	CR 401204
4.530-4.920	120	4.250	.280	.520	.710	.160	.830	.610±.060	VR2	V	CR 401205
4.531-4.917	120	4.250	.280	.310	.500	.160	.830	.410±.060	VR1	R	CR 401208
4.920-5.320	130	4.610	.280	.310	.500	.160	.830	.410±.060	VR1	R	CR 401300
4.920-5.320	130	4.610	.280	.520	.710	.160	.830	.610±.060	VR2	R	CR 401301
4.920-5.320	130	4.610	.280	.310	.500	.160	.830	.410±.060	VR1	V	CR 401304

Select the larger V-ring when the dimension d_1 is on the boundary between two sizes of V-ring. Purple dot on V-ring indicates LongLife material. Sizes under .748 (19 mm) are brown with no dot. * Check for availability and pricing.

V-ring seals – Inch sizes

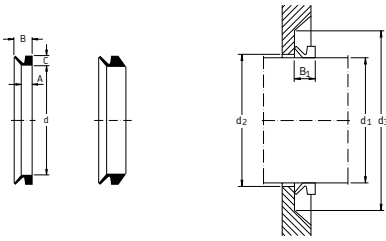

Shaft diameter d_1 (range)	Reference metric shaft size	Inside diameter d	Height C	Dimension A	Free width B	max $d_2 = (d_1 +)$	min $d_3 = (d_1 +)$	Fitted width B_1	Design	Lip code	SKF Designation
in	mm	in	in	in	in	in	in	in			
4.920-5.320	130	4.610	.280	.520	.710	.160	.830	.610±.060	VR2	V	CR 401305
5.320-5.710	140	4.960	.280	.310	.500	.160	.830	.410±.060	VR1	R	CR 401400
5.320-5.710	140	4.960	.280	.520	.710	.160	.830	.610±.060	VR2	R	CR 401401
5.320-5.710	140	4.960	.260	.240	.410	.200	.800	.310±.060	VR3	R	CR 401402
5.320-5.710	140	4.960	.280	.310	.500	.160	.830	.410±.060	VR1	V	CR 401404
5.320-5.710	140	4.960	.280	.520	.710	.160	.830	.610±.060	VR2	V	CR 401405
5.320-5.710	140	4.960	.260	.240	.410	.200	.800	.310±.060	VR3	V	CR 401406
5.710-6.100	150	5.310	.280	.310	.500	.160	.830	.410±.060	VR1	R	CR 401500
5.710-6.100	150	5.310	.280	.520	.710	.160	.830	.610±.060	VR2	R	CR 401501
5.710-6.100	150	5.310	.260	.240	.410	.200	.800	.310±.060	VR3	R	CR 401502
5.710-6.100	150	5.310	.280	.310	.500	.160	.830	.410±.060	VR1	V	CR 401504
5.710-6.100	150	5.310	.280	.520	.710	.160	.830	.610±.060	VR2	V	CR 401505
5.710-6.100	150	5.310	.260	.240	.410	.200	.800	.310±.060	VR3	V	CR 401506
6.100-6.500	160	5.670	.310	.350	.570	.200	.940	.470±.070	VR1	R	CR 401600
6.100-6.500	160	5.670	.310	.590	.810	.200	.940	.710±.070	VR2	R	CR 401601
6.100-6.500	160	5.670	.260	.240	.410	.200	.800	.310±.060	VR3	R	CR 401602
6.100-6.500	160	5.670	.310	.350	.570	.200	.940	.470±.070	VR1	V	CR 401604
6.100-6.500	160	5.670	.310	.590	.810	.200	.940	.710±.070	VR2	V	CR 401605
6.100-6.500	160	5.670	.260	.240	.410	.200	.800	.310±.060	VR3	V	CR 401606
6.100-6.500	160	5.670	.310	.350	.570	.200	.940	.470±.070	VR1	R	CR 401608
6.500-6.890	170	6.020	.310	.350	.570	.200	.940	.470±.070	VR1	R	CR 401700
6.500-6.890	170	6.020	.310	.590	.810	.200	.940	.710±.070	VR2	R	CR 401701
6.500-6.890	170	6.020	.260	.240	.410	.200	.800	.310±.060	VR3	R	CR 401702
6.500-6.890	170	6.020	.310	.350	.570	.200	.940	.470±.070	VR1	V	CR 401704
6.500-6.890	170	6.020	.310	.590	.810	.200	.940	.710±.070	VR2	V	CR 401705
6.500-6.890	170	6.020	.260	.240	.410	.200	.800	.310±.060	VR3	V	CR 401706
6.890-7.290	180	6.380	.310	.350	.570	.200	.940	.470±.070	VR1	R	CR 401800
6.890-7.290	180	6.380	.310	.590	.810	.200	.940	.710±.070	VR2	R	CR 401801
6.890-7.290	180	6.380	.260	.240	.410	.200	.800	.310±.060	VR3	R	CR 401802
6.890-7.290	180	6.380	.310	.350	.570	.200	.940	.470±.070	VR1	V	CR 401804
6.890-7.290	180	6.380	.310	.590	.810	.200	.940	.710±.070	VR2	V	CR 401805
6.890-7.290	180	6.380	.260	.240	.410	.200	.800	.310±.060	VR3	V	CR 401806
7.290-7.680	190	6.730	.310	.350	.570	.200	.940	.470±.070	VR1	R	CR 401900
7.290-7.680	190	6.730	.310	.590	.810	.200	.940	.710±.070	VR2	R	CR 401901
7.290-7.680	190	6.730	.260	.240	.410	.200	.800	.310±.060	VR3	R	CR 401902

Select the larger V-ring when the dimension d_1 is on the boundary between two sizes of V-ring. Purple dot on V-ring indicates LongLife material. Sizes under .748 (19 mm) are brown with no dot. * Check for availability and pricing.

V-ring seals – Inch sizes

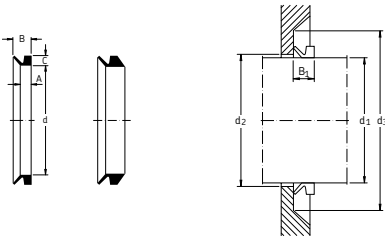

Shaft diameter d_1 (range)	Reference metric shaft size	Inside diameter d	Height C	Dimension A	Free width B	max $d_2 = (d_1 +)$	min $d_3 = (d_1 +)$	Fitted width B_1	Design	Lip code	SKF Designation
in	mm	in	in	in	in	in	in	in			
7.290-7.680	190	6.730	.310	.350	.570	.200	.940	.470±.070	VR1	V	CR 401904
7.290-7.680	190	6.730	.310	.590	.810	.200	.940	.710±.070	VR2	V	CR 401905
7.290-7.680	190	6.730	.260	.240	.410	.200	.800	.310±.060	VR3	V	CR 401906
7.680-8.270	199	7.090	.310	.350	.570	.200	.940	.470±.070	VR1	R	CR 401990
7.680-8.270	199	7.090	.310	.590	.810	.200	.940	.710±.070	VR2	R	CR 401991
7.680-8.270	199	7.090	.310	.350	.570	.200	.940	.470±.070	VR1	V	CR 401994
7.680-8.270	199	7.090	.310	.590	.810	.200	.940	.710±.070	VR2	V	CR 401995
7.480-8.270	200	7.090	.590	.560	.980	.400	1.770	.790±.160	VR1	R	CR 402000
7.680-8.270	200	7.170	.260	.240	.410	.200	.800	.310±.060	VR3	R	CR 402002
7.480-8.270	200	7.090	.590	.560	.980	.400	1.770	.790±.160	VR1	V	CR 402004
7.680-8.270	200	7.170	.260	.240	.410	.200	.800	.310±.060	VR3	V	CR 402006
8.270-9.250	220	7.800	.590	.560	.980	.400	1.770	.790±.160	VR1	R	CR 402200
8.270-9.170	220	7.800	.260	.240	.410	.200	.800	.310±.060	VR3	R	CR 402202
8.270-9.250	220	7.800	.590	.560	.980	.400	1.770	.790±.160	VR1	V	CR 402204
8.270-9.170	220	7.800	.260	.240	.410	.200	.800	.310±.060	VR3	V	CR 402206
9.250-10.430	250	8.860	.590	.560	.980	.400	1.770	.790±.160	VR1	R	CR 402500
9.170-10.240	250	8.860	.260	.240	.410	.200	.800	.310±.060	VR3	R	CR 402502
9.250-10.430	250	8.860	.590	.560	.980	.400	1.770	.790±.160	VR1	V	CR 402504
9.170-10.240	250	8.860	.260	.240	.410	.200	.800	.310±.060	VR3	V	CR 402506
10.430-11.420	275	9.720	.590	.560	.980	.400	1.770	.790±.160	VR1	R	CR 402750
10.240-11.220	275	9.720	.260	.240	.410	.200	.800	.310±.060	VR3	R	CR 402752
10.430-11.420	275	9.720	.590	.560	.980	.400	1.770	.790±.160	VR1	V	CR 402754
10.240-11.220	275	9.720	.260	.240	.410	.200	.800	.310±.060	VR3	V	CR 402756
11.420-12.200	300	10.630	.590	.560	.980	.400	1.770	.790±.160	VR1	R	CR 403000
11.220-12.200	300	10.630	.260	.240	.410	.200	.800	.310±.060	VR3	R	CR 403002
11.420-12.200	300	10.630	.590	.560	.980	.400	1.770	.790±.160	VR1	V	CR 403004
11.220-12.200	300	10.630	.260	.240	.410	.200	.800	.310±.060	VR3	V	CR 403006
11.811-12.000	300	11.575	.827	2.657	3.931	.940	4.530	3.350±.500	VR5	R	CR 470300*
12.400-12.600	315	12.170	1.180	1.280	2.560	.940	4.530	2.000±.500	VR4	R	CR 403153*
12.200-13.190	325	11.500	.590	.560	.980	.400	1.770	.790±.160	VR1	R	CR 403250
12.200-13.190	325	11.500	.260	.240	.410	.200	.800	.310±.060	VR3	R	CR 403252
12.200-13.190	325	11.500	.590	.560	.980	.400	1.770	.790±.160	VR1	V	CR 403254
12.200-13.190	325	11.500	.260	.240	.410	.200	.800	.310±.060	VR3	V	CR 403256
13.190-14.370	350	12.400	.590	.560	.980	.400	1.770	.790±.160	VR1	R	CR 403500
13.190-14.370	350	12.400	.260	.240	.410	.200	.800	.310±.060	VR3	R	CR 403502

Select the larger V-ring when the dimension d_1 is on the boundary between two sizes of V-ring. Purple dot on V-ring indicates LongLife material. Sizes under .748 (19 mm) are brown with no dot. * Check for availability and pricing.

V-ring seals – Inch sizes

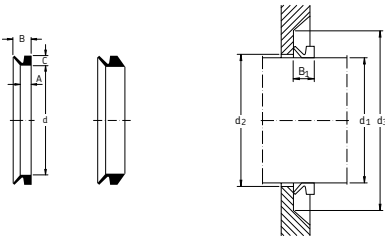

Shaft diameter d_1 (range)	Reference metric shaft size	Inside diameter d	Height C	Dimension A	Free width B	max $d_2 = (d_1+)$	min $d_3 = (d_1+)$	Fitted width B_1	Design	Lip code	SKF Designation
in	mm	in	in	in	in	in	in	in			
13.190-14.370	350	12.400	.590	.560	.980	.400	1.770	.790±.160	VR1	V	CR 403504
13.190-14.370	350	12.400	.260	.240	.410	.200	.800	.310±.060	VR3	V	CR 403506
14.170-14.370	360	13.858	1.181	1.280	2.559	.945	4.528	1.969±.472	VR4	R	CR 403603
14.170-14.370	360	13.858	1.180	1.280	2.560	.940	4.530	2.000±.500	VR4	V	CR 403607*
14.567-14.764	370	14.252	1.180	1.280	2.560	.940	4.530	2.000±.500	VR4	R	CR 403703*
14.370-15.350	375	13.270	.590	.560	.980	.400	1.770	.790±.160	VR1	R	CR 403750
14.370-15.350	375	13.270	.260	.240	.410	.200	.800	.310±.060	VR3	R	CR 403752
14.764-14.961	375	14.449	1.180	1.280	2.560	.940	4.530	2.000±.500	VR4	R	CR 403753*
14.370-15.350	375	13.270	.590	.560	.980	.400	1.770	.790±.160	VR1	V	CR 403754
14.370-15.350	375	13.270	.260	.240	.410	.200	.800	.310±.060	VR3	V	CR 403756
14.961-15.157	380	14.606	.827	2.657	3.937	.940	4.530	3.350±.500	VR5	R	CR 470380*
15.354-19.685	385	14.803	.827	2.657	3.937	.940	4.530	3.350±.500	VR5	R	CR 470385*
14.350-15.550	390	15.000	1.180	1.280	2.560	.940	4.530	2.000±.500	VR4	R	CR 403903*
15.350-16.930	400	14.170	.590	.560	.980	.400	1.770	.790±.160	VR1	R	CR 404000
15.150-16.730	400	14.170	.260	.240	.410	.200	.800	.310±.060	VR3	R	CR 404002
15.750-15.940	400	15.394	1.181	1.280	2.559	.945	4.528	1.969±.472	VR4	R	CR 404003
15.350-16.930	400	14.170	.590	.560	.980	.400	1.770	.790±.160	VR1	V	CR 404004
15.150-16.930	400	14.170	.260	.240	.410	.200	.800	.310±.060	VR3	V	CR 404006
16.142-17.322	425	15.039	.260	.240	.410	.200	.800	.315±.060	VR3	R	CR 404252*
16.930-17.120	430	16.490	1.180	1.280	2.560	.940	4.530	2.000±.500	VR4	R	CR 404303
16.930-18.900	450	15.940	.590	.560	.980	.400	1.770	.790±.160	VR1	R	CR 404500
16.730-18.700	450	15.940	.260	.240	.410	.200	.800	.310±.060	VR3	R	CR 404502
17.720-17.910	450	17.280	1.180	1.280	2.560	.940	4.530	2.000±.500	VR4	R	CR 404503
16.930-18.900	450	15.940	.590	.560	.980	.400	1.770	.790±.160	VR1	V	CR 404504
16.730-18.700	450	15.940	.260	.240	.410	.200	.800	.310±.060	VR3	V	CR 404506
19.910-18.110	455	17.480	1.180	1.280	2.560	.940	4.530	2.000±.500	VR4	R	CR 404553
18.110-18.310	460	17.640	1.180	1.280	2.560	.940	4.530	5.000±.500	VR4	R	CR 404603
18.500-18.700	470	18.030	1.180	1.280	2.560	.940	4.530	2.000±.500	VR4	R	CR 404703
18.700-18.900	475	18.228	1.180	1.280	2.560	.940	4.530	2.000±.500	VR4	R	CR 404753*
18.700-18.900	475	18.228	1.180	1.280	2.560	.940	4.530	2.000±.500	VR4	V	CR 404757*
18.900-19.090	480	18.430	1.180	1.280	2.560	.940	4.530	2.000±.500	VR4	R	CR 404803
18.900-19.090	480	18.430	1.180	1.280	2.560	.940	4.530	2.000±.500	VR4	V	CR 404807*
19.090-19.290	485	18.622	1.181	1.280	2.559	.945	4.528	1.969±.472	VR4	R	CR 404853
19.100-19.290	485	19.094	1.180	1.280	2.560	.940	4.530	2.000±.500	VR4	V	CR 404857*
19.290-19.490	490	18.820	1.180	1.280	2.560	.940	4.530	2.000±.500	VR4	R	CR 404903

Select the larger V-ring when the dimension d_1 is on the boundary between two sizes of V-ring. Purple dot on V-ring indicates LongLife material. Sizes under .748 (19 mm) are brown with no dot. * Check for availability and pricing.

V-ring seals – Inch sizes

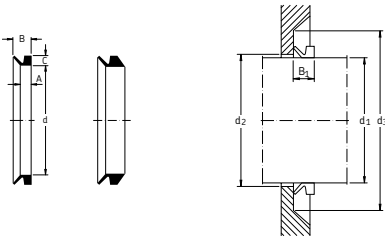

Shaft diameter d_1 (range)	Reference metric shaft size	Inside diameter d	Height C	Dimension A	Free width B	max $d_2=(d_1+)$	min $d_3=(d_1+)$	Fitted width B_1	Design	Lip code	SKF Designation
in	mm	in	in	in	in	in	in	in			
18.900-20.870	500	17.720	.590	.560	.980	.400	1.770	.790±.160	VR1	R	CR 405000
18.900-20.870	500	17.720	.260	.240	.410	.200	.800	.310±.060	VR3	R	CR 405002
19.690-19.880	500	19.210	1.180	1.280	2.560	.940	4.530	2.000±.500	VR4	R	CR 405003
18.900-20.870	500	17.720	.590	.560	.980	.400	1.770	.790±.160	VR1	V	CR 405004
18.700-20.080	500	17.717	.255	.236	.413	.196	.787	.315±.060	VR3	R	CR 405006
19.690-19.880	500	19.213	1.180	1.280	2.560	.940	4.530	2.000±.500	VR4	V	CR 405007*
20.010-20.280	510	19.570	1.180	1.280	2.560	.940	4.530	2.000±.500	VR4	R	CR 405103
20.470-20.670	520	19.960	1.180	1.280	2.560	.940	4.530	2.000±.500	VR4	R	CR 405203
20.080-21.260	525	18.580	.260	.240	.410	.200	.800	.310±.060	VR3	R	CR 405252
20.870-21.060	530	20.350	1.180	1.280	2.560	.940	4.530	2.000±.500	VR4	R	CR 405303
21.260-21.460	540	20.709	1.180	1.280	2.560	.940	4.530	2.000±.500	VR4	R	CR 405403*
20.870-22.830	550	19.490	.590	.560	.980	.400	1.770	.790±.160	VR1	R	CR 405500
20.870-22.830	550	19.490	.260	.240	.410	.200	.800	.310±.060	VR3	R	CR 405502
21.650-21.850	550	21.100	1.180	1.280	2.560	.940	4.530	2.000±.500	VR4	R	CR 405503
20.870-22.830	550	19.490	.590	.560	.980	.400	1.770	.790±.160	VR1	V	CR 405504
21.560-22.638	550	19.488	.260	.240	.410	.200	.800	.315±.060	VR3	V	CR 405506*
22.050-22.240	560	21.496	1.181	1.280	2.559	.945	4.528	1.969±.472	VR4	R	CR 405603
22.050-22.240	560	21.496	1.180	1.280	2.560	.940	4.530	2.000±.500	VR4	V	CR 405607*
22.440-22.640	570	21.850	1.180	1.280	2.560	.940	4.530	2.000±.500	VR4	R	CR 405703
22.640-22.830	575	22.050	1.180	1.280	2.560	.940	4.530	2.000±.500	VR4	R	CR 405753
22.638-22.835	575	22.047	1.180	1.280	2.560	.940	4.530	2.000±.500	VR4	V	CR 405757*
22.830-23.030	580	22.240	1.180	1.280	2.560	.940	4.530	2.000±.500	VR4	R	CR 405803
23.230-23.620	590	22.640	1.180	1.280	2.560	.940	4.530	2.000±.500	VR4	R	CR 405903
22.830-24.800	600	21.260	.590	.560	.980	.400	1.770	.790±.160	VR1	R	CR 406000
22.830-24.800	600	21.260	.260	.240	.410	.200	.800	.310±.060	VR3	R	CR 406002
23.620-24.020	600	22.910	1.180	1.280	2.560	.940	4.530	2.000±.500	VR4	R	CR 406003
22.830-24.800	600	21.260	.590	.560	.980	.400	1.770	.790±.160	VR1	V	CR 406004
22.638-24.606	600	21.260	.260	.240	.410	.200	.800	.315±.060	VR3	V	CR 406006*
24.020-24.410	610	23.310	1.180	1.280	2.560	.940	4.530	2.000±.500	VR4	R	CR 406103
24.410-24.800	620	23.700	1.180	1.280	2.560	.940	4.530	2.000±.500	VR4	R	CR 406203
24.800-25.200	630	24.090	1.180	1.280	2.560	.940	4.530	2.000±.500	VR4	R	CR 406303
25.200-25.590	640	24.450	1.180	1.280	2.560	.940	4.530	2.000±.500	VR4	R	CR 406403
24.800-26.180	650	23.620	.590	.560	.980	.400	1.770	.790±.160	VR1	R	CR 406500
25.590-25.980	650	24.840	1.180	1.280	2.560	.940	4.530	2.000±.500	VR4	R	CR 406503
24.790-26.187	650	23.622	.590	.560	.980	.400	1.770	.790±.160	VR1	V	CR 406504*

Select the larger V-ring when the dimension d_1 is on the boundary between two sizes of V-ring. Purple dot on V-ring indicates LongLife material. Sizes under .748 (19 mm) are brown with no dot. * Check for availability and pricing.

V-ring seals – Inch sizes

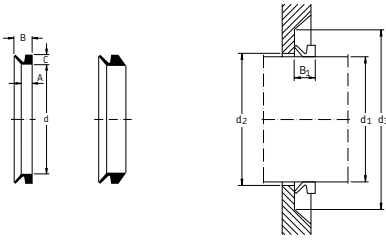

Shaft diameter d_1 (range)	Reference metric shaft size	Inside diameter d	Height C	Dimension A	Free width B	max $d_2 = (d_1 +)$	min $d_3 = (d_1 +)$	Fitted width B_1	Design	Lip code	SKF Designation
in	mm	in	in	in	in	in	in	in			
25.590-25.980	650	24.842	1.180	1.280	2.560	.940	4.530	2.000±.500	VR4	V	CR 406507*
25.980-26.380	660	25.197	1.180	1.280	2.560	.940	4.530	2.000±.500	VR4	R	CR 406603*
26.380-26.770	670	25.591	1.180	1.280	2.560	.940	4.530	2.000±.500	VR4	N	CR 406703*
26.770-27.170	680	25.984	1.180	1.280	2.560	.940	4.530	2.000±.500	VR4	N	CR 406803*
27.170-27.560	690	26.380	1.180	1.280	2.560	.940	4.530	2.000±.500	VR4	R	CR 406903
27.170-27.560	690	26.378	1.180	1.280	2.560	.940	4.530	2.000±.500	VR4	V	CR 406907*
26.180-27.760	700	24.800	.590	.560	.980	.400	1.770	.790±.160	VR1	R	CR 407000
27.560-27.950	700	26.780	1.180	1.280	2.560	.940	4.530	2.000±.500	VR4	R	CR 407003
26.180-27.760	700	24.803	.590	.560	.980	.400	1.770	.790±.160	VR1	V	CR 407004*
27.953-28.346	710	27.126	1.180	1.280	2.560	.940	4.530	2.000±.500	VR4	R	CR 407103*
28.350-28.740	720	27.520	1.180	1.280	2.560	.940	4.530	2.000±.500	VR4	R	CR 407203*
27.760-29.330	725	26.380	.590	.560	.980	.400	1.770	.790±.160	VR1	R	CR 407250
28.740-29.134	730	27.910	1.180	1.280	2.560	.940	4.530	2.000±.500	VR4	R	CR 407303
28.740-29.134	730	27.913	1.180	1.280	2.560	.940	4.530	2.500±.500	VR4	V	CR 407307*
29.130-29.530	740	28.270	1.180	1.280	2.560	.940	4.530	2.000±.500	VR4	R	CR 407403
29.330-30.910	750	27.760	.590	.560	.980	.400	1.770	.790±.160	VR1	R	CR 407500
29.134-30.512	750	29.528	.260	.240	.410	.200	.800	.315±.060	VR3	R	CR 407502*
29.530-29.840	750	28.660	1.180	1.280	2.560	.940	4.530	2.000±.500	VR4	R	CR 407503
29.330-30.900	750	27.756	.590	.560	.980	.400	1.770	.790±.160	VR1	V	CR 407504*
29.845-30.157	760	28.937	1.181	1.280	2.559	.945	4.528	1.969±.472	VR4	R	CR 407603
30.157-30.472	770	29.250	1.181	1.280	2.559	.945	4.528	1.969±.472	VR4	R	CR 407703
30.470-30.830	780	29.570	1.180	1.280	2.560	.940	4.530	2.000±.500	VR4	R	CR 407803
30.910-32.680	800	29.330	.590	.560	.980	.400	1.770	.790±.160	VR1	R	CR 408000
31.180-31.540	800	30.240	1.180	1.280	2.560	.940	4.530	2.000±.500	VR4	R	CR 408003
30.900-32.680	800	29.330	.590	.560	.980	.400	1.770	.790±.160	VR1	V	CR 408004*
32.720-33.110	840	31.693	1.181	1.280	2.560	.940	4.530	2.500±.500	VR4	R	CR 408403*
32.680-34.450	850	30.910	.590	.560	.980	.400	1.770	.790±.160	VR1	R	CR 408500
33.110-33.500	850	32.050	1.180	1.280	2.560	.940	4.530	2.000±.500	VR4	R	CR 408503
33.900-34.290	870	32.795	1.180	1.280	2.560	.940	4.530	2.000±.500	VR4	R	CR 408703*
34.290-34.720	880	33.189	1.180	1.280	2.560	.940	4.530	2.000±.500	VR4	R	CR 408803*
34.290-34.720	880	33.189	1.180	1.280	2.560	.940	4.530	2.000±.500	VR4	V	CR 408807*
34.720-35.310	890	33.580	1.180	1.280	2.560	.940	4.530	2.000±.500	VR4	R	CR 408903
34.450-36.220	890	33.583	1.180	1.280	2.560	.940	4.530	2.000±.500	VR4	V	CR 408907*
34.450-36.220	900	32.480	.590	.560	.980	.400	1.770	.790±.160	VR1	R	CR 409000
34.449-36.417	900	32.480	.260	.240	.410	.200	.800	.315±.060	VR3	R	CR 409002*

Select the larger V-ring when the dimension d_1 is on the boundary between two sizes of V-ring. Purple dot on V-ring indicates LongLife material. Sizes under .748 (19 mm) are brown with no dot. * Check for availability and pricing.

V-ring seals – Inch sizes

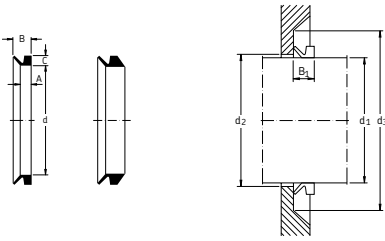

Shaft diameter d_1 (range)	Reference metric shaft size	Inside diameter d	Height C	Dimension A	Free width B	max $d_2 = (d_1 +)$	min $d_3 = (d_1 +)$	Fitted width B_1	Design	Lip code	SKF Designation
in	mm	in	in	in	in	in	in	in			
35.310-35.910	900	34.290	1.180	1.280	2.560	.940	4.530	2.000±.500	VR4	R	CR 409003
35.118-35.905	900	34.291	.827	2.657	3.937	.940	4.530	3.350±.500	VR5	R	CR 470900*
34.450-36.220	900	32.480	.590	.560	.980	.400	1.770	.790±.160	VR1	V	CR 409004*
36.732-37.165	940	35.433	1.180	1.280	2.560	.940	4.530	2.000±.500	VR4	R	CR 409403*
36.730-31.170	940	35.433	.827	2.657	3.937	.940	4.530	3.350±.500	VR5	R	CR 470940*
36.220-37.990	950	34.060	.590	.560	.980	.400	1.770	.790±.160	VR1	R	CR 409500
37.170-37.600	950	35.870	1.180	1.280	2.560	.940	4.530	2.000±.500	VR4	R	CR 409503
36.220-37.992	950	34.055	.590	.560	.980	.400	1.770	.790±.160	VR1	V	CR 409504*
38.898-39.331	990	37.520	1.180	1.280	2.560	.940	4.530	2.000±.500	VR4	R	CR 409903*
37.990-39.960	1000	35.830	.590	.560	.980	.400	1.770	.790±.160	VR1	R	CR 410000
39.330-39.760	1000	37.910	1.180	1.280	2.560	.940	4.530	2.000±.500	VR4	R	CR 410003
37.990-39.960	1000	35.827	.590	.560	.980	.400	1.770	.790±.160	VR1	V	CR 410004*
39.960-41.930	1050	37.600	.590	.560	.980	.400	1.770	.790±.160	VR1	R	CR 410500
40.550-41.350	1050	39.340	1.180	1.280	2.560	.940	4.530	2.000±.500	VR4	R	CR 410503
41.140-41.930	1060	39.690	1.180	1.280	2.560	.940	4.530	2.000±.500	VR4	R	CR 410603
41.930-42.720	1080	40.433	1.180	1.280	2.560	.940	4.530	2.000±.500	VR4	R	CR 410803*
41.930-43.900	1100	39.370	.590	.560	.980	.400	1.770	.790±.160	VR1	R	CR 411000
42.720-43.500	1100	41.140	1.180	1.280	2.560	.940	4.530	2.000±.500	VR4	R	CR 411003
43.500-44.290	1120	41.929	1.180	1.280	2.560	.940	4.530	2.000±.500	VR4	R	CR 411203*
44.291-45.079	1140	42.677	.827	2.657	3.937	.940	4.530	3.350±.500	VR5	R	CR 471140*
43.900-45.870	1150	41.140	.590	.560	.980	.400	1.770	.790±.160	VR1	R	CR 411500
44.290-46.260	1150	41.142	.260	.240	.410	.200	.800	.315±.060	VR3	R	CR 411502*
44.490-45.290	1150	43.060	1.180	1.280	2.560	.940	4.530	2.000±.500	VR4	R	CR 411503
45.870-46.650	1180	44.134	1.180	1.280	2.560	.940	4.530	2.000±.500	VR4	R	CR 411803*
45.870-47.840	1200	42.910	.590	.560	.980	.400	1.770	.790±.160	VR1	R	CR 412000
46.259-48.238	1200	42.913	.260	.240	.410	.200	.800	.315±.060	VR3	R	CR 412002*
46.650-47.440	1200	44.840	1.180	1.280	2.560	.940	4.530	2.000±.500	VR4	R	CR 412003
45.875-47.840	1200	42.913	.590	.560	.980	.400	1.770	.790±.160	VR1	V	CR 412004*
48.230-49.020	1240	46.299	1.180	1.280	2.560	.940	4.530	2.000±.500	VR4	R	CR 412403*
47.840-50.000	1250	44.690	.590	.560	.980	.400	1.770	.790±.160	VR1	R	CR 412500
48.520-49.320	1250	46.680	1.180	1.280	2.560	.940	4.530	2.000±.500	VR4	R	CR 412503
47.840-50.000	1250	44.685	.590	.560	.980	.400	1.770	.790±.160	VR1	V	CR 412504*
50.000-50.890	1280	47.953	1.180	1.280	2.560	.940	4.530	2.000±.500	VR4	R	CR 412803*
50.000-51.970	1300	46.460	.590	.560	.980	.400	1.770	.790±.160	VR1	R	CR 413000
50.980-51.770	1300	48.820	1.180	1.280	2.560	.940	4.530	2.000±.500	VR4	R	CR 413003

Select the larger V-ring when the dimension d_1 is on the boundary between two sizes of V-ring. Purple dot on V-ring indicates LongLife material. Sizes under .748 (19 mm) are brown with no dot. * Check for availability and pricing.

V-ring seals – Inch sizes

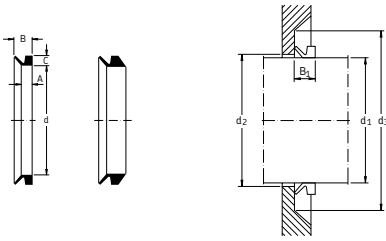

Shaft diameter d_1 (range)	Reference metric shaft size	Inside diameter d	Height C	Dimension A	Free width B	max $d_2 = (d_1 +)$	min $d_3 = (d_1 +)$	Fitted width B_1	Design	Lip code	SKF Designation
in	mm	in	in	in	in	in	in	in			
51.770-52.760	1325	49.567	1.180	1.280	2.560	.940	4.530	2.000±.500	VR4	R	CR 413253*
51.970-53.940	1350	48.230	.590	.560	.980	.400	1.770	.790±.160	VR1	R	CR 413500
52.165-54.134	1350	48.228	.260	.240	.410	.200	.800	.315±.060	VR3	R	CR 413502*
52.760-53.740	1350	50.430	1.180	1.280	2.560	.940	4.530	2.000±.500	VR4	R	CR 413503
53.940-55.910	1400	50.000	.590	.560	.980	.400	1.770	.790±.160	VR1	R	CR 414000
54.720-55.710	1400	52.280	1.180	1.280	2.560	.940	4.530	2.000±.500	VR4	R	CR 414003
54.130-56.100	1400	50.000	.260	.240	.410	.200	.800	.315±.060	VR3	V	CR 414006*
55.910-57.870	1450	51.770	.590	.560	.980	.400	1.770	.790±.160	VR1	R	CR 414500
56.690-57.680	1450	54.090	1.180	1.280	2.560	.940	4.530	2.000±.500	VR4	R	CR 414503
55.190-57.870	1450	51.772	.590	.560	.980	.400	1.770	.790±.160	VR1	V	CR 414504*
57.870-59.840	1500	53.540	.590	.560	.980	.400	1.770	.790±.160	VR1	R	CR 415000
58.660-59.650	1500	55.870	1.180	1.280	2.560	.940	4.530	2.000±.500	VR4	R	CR 415003
59.840-61.810	1550	55.320	.590	.560	.980	.400	1.770	.790±.160	VR1	R	CR 415500
60.630-61.810	1550	57.760	1.180	1.280	2.560	.940	4.530	2.000±.500	VR4	R	CR 415503
61.810-63.780	1600	57.090	.590	.560	.980	.400	1.770	.790±.160	VR1	R	CR 416000
62.990-64.570	1600	60.000	1.180	1.280	2.560	.940	4.530	2.000±.500	VR4	R	CR 416003
63.780-65.750	1650	58.860	.590	.560	.980	.400	1.770	.790±.160	VR1	R	CR 416500
64.570-66.140	1650	61.380	1.180	1.280	2.560	.940	4.530	2.000±.500	VR4	R	CR 416503
65.750-67.720	1700	60.630	.590	.560	.980	.400	1.770	.790±.160	VR1	R	CR 417000
66.140-67.720	1700	62.830	1.180	1.280	2.560	.940	4.530	2.000±.500	VR4	R	CR 417003
67.720-69.690	1750	62.400	.590	.560	.980	.400	1.770	.790±.160	VR1	R	CR 417500
67.720-69.490	1750	64.250	1.180	1.280	2.560	.940	4.530	2.000±.500	VR4	R	CR 417503
69.690-71.560	1800	64.170	.590	.560	.980	.400	1.770	.790±.160	VR1	R	CR 418000
69.490-71.260	1800	65.790	1.180	1.280	2.560	.940	4.530	2.000±.500	VR4	R	CR 418003
69.880-71.850	1800	64.173	.260	.240	.410	.200	.800	.315±.060	VR3	V	CR 418006*
71.650-73.620	1850	65.950	.590	.560	.980	.400	1.770	.790±.160	VR1	R	CR 418500
71.260-73.030	1850	67.480	1.180	1.280	2.560	.940	4.530	2.000±.500	VR4	R	CR 418503
73.620-75.590	1900	67.720	.590	.560	.980	.400	1.770	.790±.160	VR1	R	CR 419000
73.030-75.000	1900	69.020	1.180	1.280	2.560	.940	4.530	2.000±.500	VR4	R	CR 419003
75.590-77.560	1950	69.490	.590	.560	.980	.400	1.770	.790±.160	VR1	R	CR 419500
75.000-76.970	1950	70.630	1.180	1.280	2.560	.940	4.530	2.000±.500	VR4	R	CR 419503
77.560-79.530	2000	71.260	.590	.560	.980	.400	1.770	.790±.160	VR1	R	CR 419990
76.970-79.130	2000	72.600	1.180	1.280	2.560	.940	4.530	2.000±.500	VR4	R	CR 419993
79.530-83.460	2100	72.420	.590	.560	.980	.400	1.770	.790±.160	VR1	R	CR 421000*
83.360-86.420	2150	78.660	1.180	1.280	2.560	.940	4.530	2.000±.520	VR4	R	CR 421503*

Select the larger V-ring when the dimension d_1 is on the boundary between two sizes of V-ring. Purple dot on V-ring indicates LongLife material. Sizes under .748 (19 mm) are brown with no dot. * Check for availability and pricing.

V-ring seals – Inch sizes

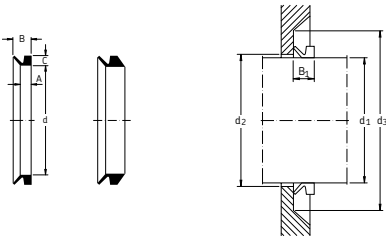

Shaft diameter d_1 (range)	Reference metric shaft size	Inside diameter d	Height C	Dimension A	Free width B	max $d_2 = (d_1 +)$	min $d_3 = (d_1 +)$	Fitted width B_1	Design	Lip code	SKF Designation
in	mm	in	in	in	in	in	in	in			
86.419-89.209	2200	80.905	.827	2.657	3.937	.940	4.530	3.350±.500	VR5	R	CR 472201*
97.358-99.543	2500	86.020	.590	.560	.980	.400	1.770	.790±.160	VR1	R	CR 425000*
96.063-100.000	2500	89.520	1.180	1.280	2.560	.940	4.530	2.00±.500	VR4	R	CR 425003*
126.260-129.670	3250	113.740	1.180	1.280	2.560	.940	4.530	2.00±.500	VR4	R	CR 432503*
127.950-131.890	3300	115.390	1.180	1.280	2.560	.940	4.530	2.00±.500	VR4	R	CR 433003*

Select the larger V-ring when the dimension d_1 is on the boundary between two sizes of V-ring. Purple dot on V-ring indicates LongLife material. Sizes under .748 (19 mm) are brown with no dot. * Check for availability and pricing.

MVR axial shaft seals

For added protection in extremely contaminated applications, in addition to our standard V-ring, SKF also offers the type MVR. The MVR seal also seals axially and functions by combining positive lip contact with centrifugal “slinging” action. However, the MVR seal is different in that the rubber element is stretch fitted into a metal shell. The metal shell is then press-fitted onto the shaft. This shell provides excellent protection from heavy debris and it automatically accommodates high rotating speeds without auxiliary clamping devices.

Advantages/User benefits:

- The metal shell serves as a support and deflector. The rubber body and lip are protected from damage and displacement by external debris (i.e. rocks, viscous media).
- In most cases, the shell also functions as a holder that keeps the rubber lip in position during high surface speeds. No additional axial retention is required. Contact SKF regarding radial retention limits.
- Due to its compact design, narrow installation widths are possible.

- Frictional heat build-up and torque drag are very low compared to contacting radial shaft seals. As rotary speed increases, the MVR seal lip lifts off the counter surface starting at about 2362 FPM (12 m/s) and drops to zero contact by 3937 FPM (20 m/s). Like the V-ring, the high rotary speed prevents contamination ingress while minimizing power loss.
- Service life is considerably higher than radial seals in contaminated environments and can extend to thousands of hours.

Construction

The MVR seal lip is made from an 80 durometer nitrile rubber with very good wear resistance. Other elastomers are possible in production lot orders. There are two versions of the metal shell, the MVR1 and the MVR2 with shell extension. Please refer to the illustrations below for details. The stock metal element is zinc plated cold-rolled carbon steel. Acid resistant steel similar to SAE 316 is available by special order.

Temperature range

Generally the same as NBR V-rings or -40°C to 100°C .

MVR1 – Metric sizes

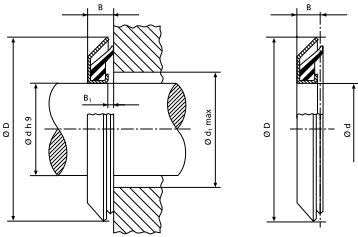

Dimensions					SKF Designation
shaft diameter	outer case diameter	housing width	clearance	max. counter surface hole diameter	
10	24	3,5	1,0	15	CR MVR1-10
12	26	3,5	1,0	17	CR MVR1-12
15	30	4,0	1,0	21	CR MVR1-15
16	32	4,0	1,0	23	CR MVR1-16
17	32	4,0	1,0	23	CR MVR1-17
18	33	4,0	1,0	24	CR MVR1-18
20	35	4,0	1,0	26	CR MVR1-20
22	40	4,0	1,0	28	CR MVR1-22
24	40	4,0	1,0	30	CR MVR1-24
25	40	4,0	1,0	31	CR MVR1-25
26	40	4,0	1,0	32	CR MVR1-26
28	43	4,0	1,0	34	CR MVR1-28
30	47	4,5	1,0	37	CR MVR1-30
32	49	4,5	1,0	39	CR MVR1-32
35	52	4,5	1,0	42	CR MVR1-35
40	57	4,5	1,0	47	CR MVR1-40
45	62	4,5	1,0	52	CR MVR1-45
48	65	4,5	1,0	55	CR MVR1-48
50	70	5,5	1,0	58	CR MVR1-50
52	72	5,5	1,0	60	CR MVR1-52
53	73	5,5	1,0	61	CR MVR1-53
55	75	5,5	1,0	63	CR MVR1-55
58	78	5,5	1,0	66	CR MVR1-58
60	80	5,5	1,0	68	CR MVR1-60
62	82	5,5	1,0	70	CR MVR1-62
65	85	5,5	1,0	73	CR MVR1-65
68	88	5,5	1,0	76	CR MVR1-68
70	90	5,5	1,0	78	CR MVR1-70
72	92	5,5	1,0	80	CR MVR1-72
75	95	5,5	1,0	83	CR MVR1-75

Special designs are available and new sizes are added gradually.
At present sizes with outer diameters up to 250 mm are manufactured.

MVR1 – Metric sizes

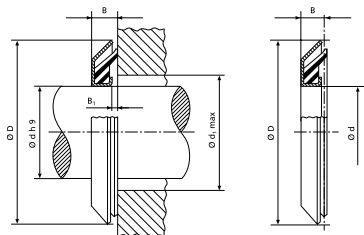

Dimensions					SKF Designation
shaft diameter	outer case diameter	housing width	clearance	max. counter surface hole diameter	
78	98	5,5	1,0	86	CR MVR1-78
80	100	5,5	1,0	88	CR MVR1-80
85	105	5,5	1,0	93	CR MVR1-85
90	110	5,5	1,0	98	CR MVR1-90
95	115	5,5	1,0	103	CR MVR1-95
100	120	5,5	1,0	108	CR MVR1-100
105	125	5,5	1,0	113	CR MVR1-105
125	148	6,5	1,0	133	CR MVR1-125
135	159	6,5	1,0	145	CR MVR1-135

Special designs are available and new sizes are added gradually.
At present sizes with outer diameters up to 250 mm are manufactured.

MVR2 – Metric sizes

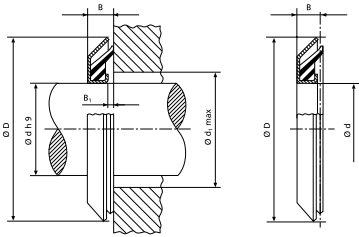

Dimensions

shaft diameter	outer case diameter	housing width	clearance	total seal case width	case groove width	max. seal counter-face hole	case groove inside diameter	case groove outside diameter	metal case thickness	SKF Designation
15	32	4,0	1,0	6,0	3	21	29	34	0,5	CR MVR2-15
17	34	4,0	1,0	6,0	3	23	31	36	0,5	CR MVR2-17
20	37	4,0	1,0	6,0	3	26	34	39	0,5	CR MVR2-20
25	42	4,0	1,0	6,0	3	31	39	44	0,5	CR MVR2-25
30	48	4,5	1,0	6,5	3	37	45	50	0,5	CR MVR2-30
35	53	4,5	1,0	6,5	3	42	50	55	0,5	CR MVR2-35
40	58	4,5	1,0	6,5	3	47	55	60	0,5	CR MVR2-40
45	63	4,5	1,0	6,5	3	52	60	65	0,5	CR MVR2-45
50	72	5,5	1,0	7,5	3	58	68,5	74	0,75	CR MVR2-50
55	77	5,5	1,0	7,5	3	63	73,5	79	0,75	CR MVR2-55
60	82	5,5	1,0	7,5	3	68	78,5	84	0,75	CR MVR2-60
65	87	5,5	1,0	7,5	3	73	83,5	89	0,75	CR MVR2-65
70	92	5,5	1,0	7,5	3	78	88,5	94	0,75	CR MVR2-70
75	95	5,5	1,0	7,5	3	83	93,5	99	0,75	CR MVR2-75
80	102	5,5	1,0	7,5	3	88	98,5	104	0,75	CR MVR2-80
85	107	5,5	1,0	7,5	3	93	103,5	109	0,75	CR MVR2-85
90	112	5,5	1,0	7,5	3	98	108,5	114	0,75	CR MVR2-90
95	117	5,5	1,0	7,5	3	103	113,5	119	0,75	CR MVR2-95
100	122	5,5	1,0	7,5	3	108	118,5	124	0,75	CR MVR2-100

Special designs are available and new sizes are added gradually.
At present sizes with outer diameters up to 250 mm are manufactured.

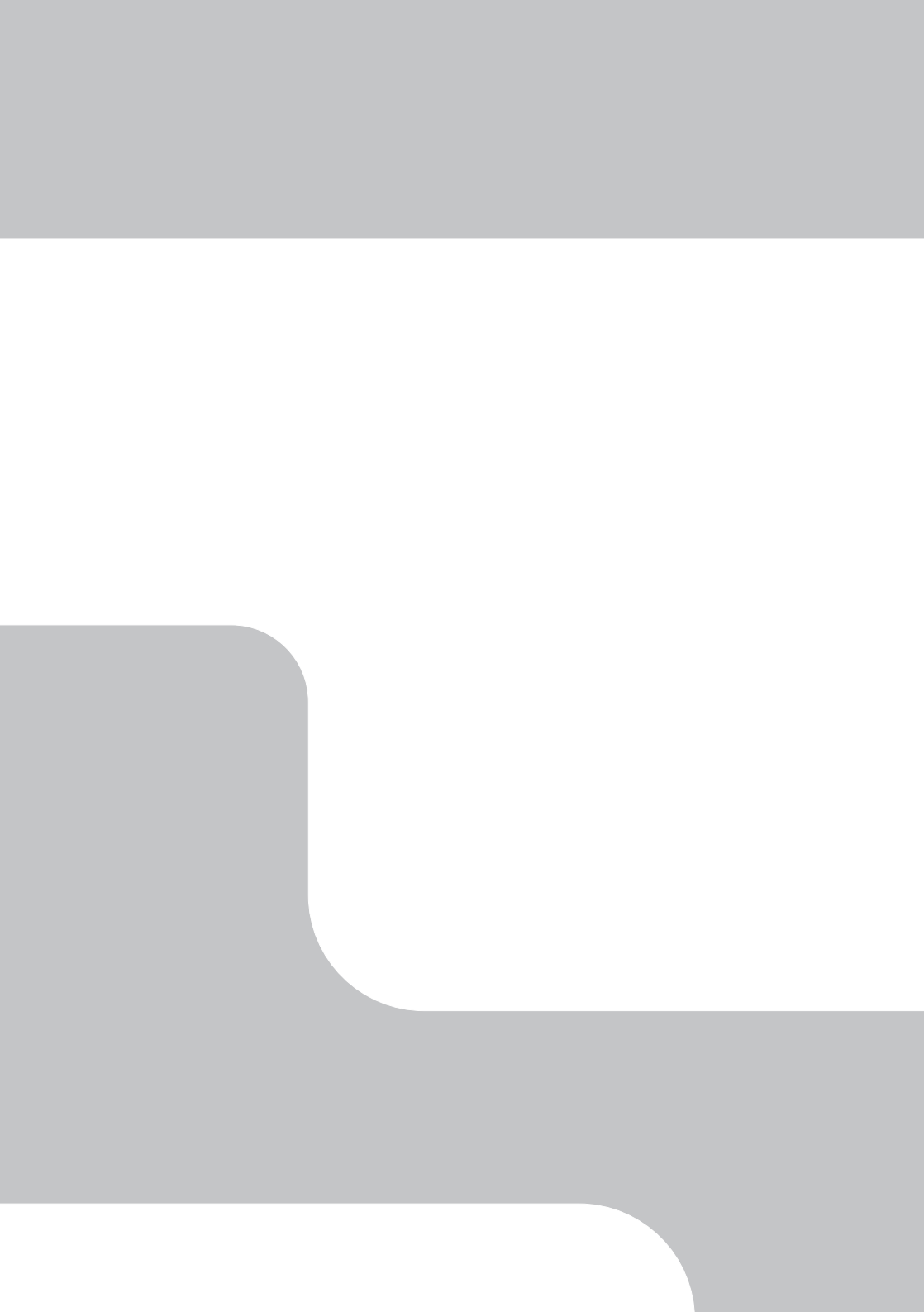

Axial clamp seals

Contents

367	CT1 design
367	CT3 design
367	CT4 design
368	Design of sealing arrangement
368	Mounting instructions
368	Assortment
370	Size listing – Metric sizes
373	Size listing – Inch sizes

Axial clamp seals

The SKF axial clamp seals are designed for large and very large diameters and are eminently suitable as secondary seals for applications where otherwise the primary seals would be subjected to excessive quantities of particulate contaminants or water. The seals do not rotate but seal axially against a rotating counterface.

These SKF axial clamp seals are made of appropriately profiled strips of non-reinforced nitrile rubber which are held firmly in place by stainless steel screw-type clamps. They are available in the diameter range 150 to 4.600.

The standard range of axial clamp seals basically comprises seals intended for inch-diameter seatings. However, as normally the seals are mounted with an approximately 25 mm gap between the ends, they may be used for appropriate metric-size seatings. In case of doubt, please contact the SKF application engineering service.

SKF axial clamp seals are produced in three different designs:

CT1 design

Axial clamp seals of the CT1 design (**fig 96a**) have a flat face sealing lip and are held in position by a screw-type clamp. The maximum permissible axial displacement (operating interference) with respect to the counterface is +2,4 mm.

CT3 design

The seals of the CT3 design (**fig 96b**) differ from those of the CT1 design only in the form of the sealing lip. This is again flat but is provided with annular grooves. These serve to trap contaminants which may have started to penetrate the lip/counterface contact. The maximum operating interference for these seals is +4,8 mm.

CT4 design

Axial clamp seals of the CT4 design (**fig 96c**) are extra wide and have a double clamp. The maximum operating interference is +4,8 mm. The sealing lip is flat as for the CT1 design.

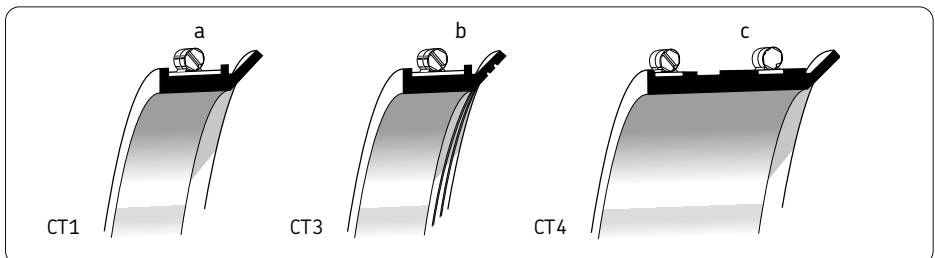

Fig 96

Design of sealing arrangement

To obtain reliable sealing, the diameter d_a and width C_a of the seal seating as well as the distance B_a should meet the requirements given in **Table 29**. It is also recommended that the seal should abut a shoulder. This eases alignment.

Finely turned counterfaces are adequate for axial clamp seals. The recommended surface roughnesses are $R_a = 2,5 \mu\text{m}$ and $R_t = 12 \mu\text{m}$.

Normally, after mounting, the CT axial clamp seal will have an approximately 25 mm (1 inch) gap. This should be arranged at the 6 o'clock position (**fig 97**). This eases installation and also facilitates drainage of contaminants. Butt-joint seals (no gap) are also available for certain applications. These provide sealing around the whole periphery.

Mounting instructions

The axial clamp seals with clamps are supplied as rolled-up coils. The assembly is placed in position on its seating in the housing, e.g. a roll chock, and screwed together lightly. It is then pushed forward towards the counterface and the gap (or joint) between the two ends is arranged at the 6 o'clock position (**fig 97**). The clamps are then tightened. The torque applied to the clamp screws should not exceed approximately 7 Nm.

Assortment

The standard range of axial clamp seals basically comprises seals intended for inch-diameter seatings. However, as normally the seals are mounted with an approximately 25 mm gap between the ends, they may be used for appropriate metric size seatings. In case of doubt, please contact the application engineering service.

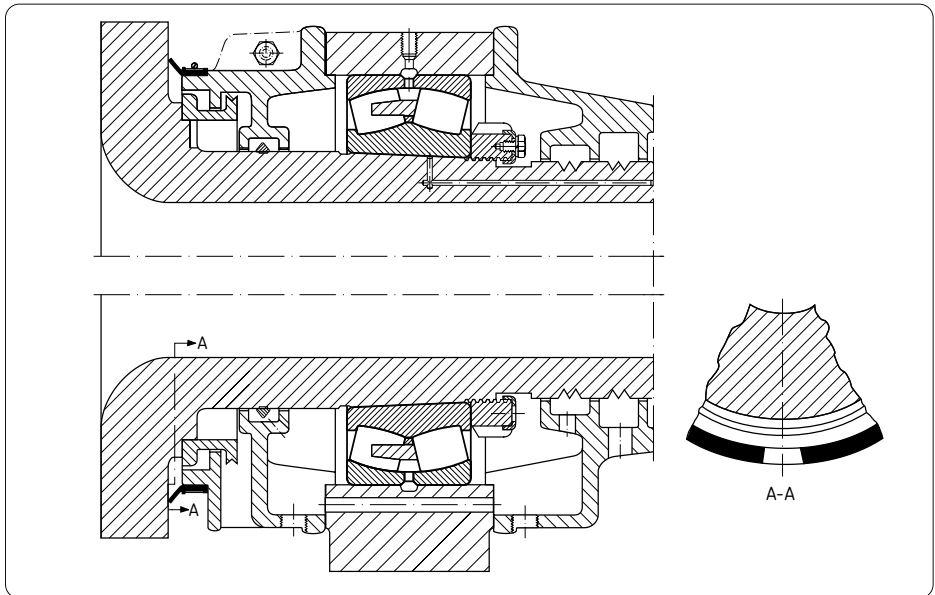
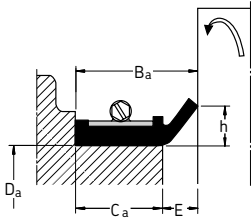

Fig 97

Table 29. Application tolerances



Dimension		Tolerance		
		Axial clamp seal of design		
		CT1	CT3	CT4
Seal seating diameter	D_a	$D_a \pm 1,6 \text{ mm}$	$D_a \pm 1,6 \text{ mm}$	$D_a \pm 1,6 \text{ mm}$
Seal seating width	C_a	$C \pm 3,2 \text{ mm}$	$C \pm 3,2 \text{ mm}$	$C \pm 3,2 \text{ mm}$
Distance	B_a	$B \pm 0,8 \text{ mm}$	$B \pm 0,8 \text{ mm}$	$B \pm 0,8 \text{ mm}$
Distance	E	$11,1 \pm 3,2 \text{ mm}$	$4,8 \pm 3,2 \text{ mm}$	$11,1 \pm 3,2 \text{ mm}$
Seal lip height above " D_a "	h	$12,7 \pm 0,8 \text{ mm}$	$15,1 \pm 1,6 \text{ mm}$	$12,7 \pm 0,8 \text{ mm}$

Axial clamp seals – Metric sizes

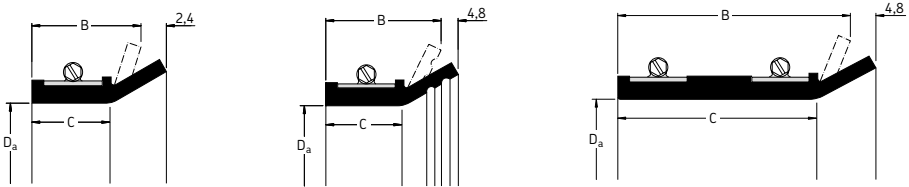

Seating diameter D _a	Seal dimensions B C		SKF Designation	Design	Seating diameter D _a	Seal dimensions B C		SKF Designation	Design
mm	mm		-	-	mm	mm		-	-
168	28,6	17,5	CR 594334	CT1	381	28,6	17,5	CR 594025	CT1
168,3	28,6	17,5	CR 529489	CT1	387	28,6	17,5	CR 594954	CT1
178	38,1	27	CR 523586	CT1	389	22,2	17,5	CR 524382	CT3
180	22,2	17,5	CR 595109	CT3	389	22,2	17,5	CR 593526	CT3
185	30	18,9	CR 593637	CT1	389	23,8	19	CR 524383	CT3
203,2	22,2	17,5	CR 528745	CT3	390	25,4	20,7	CR 594190	CT3
203,2	22,2	17,5	CR 528035	CT3	394	22,2	17,5	CR 594432	CT3
209,6	28,6	17,5	CR 527820	CT1	406	22,2	17,5	CR 529760	CT3
215,9	25,4	20,7	CR 594343	CT3	410	23,8	12,7	CR 595110	CT1
219	28,6	17,5	CR 529490	CT1	413	88,9	77,8	CR 592934	CT4
225,4	22,2	17,5	CR 524375	CT3	414	22,2	17,5	CR 524386	CT3
225,4	22,2	17,5	CR 530096	CT3	425	31,8	20,7	CR 523826	CT1
227	28,6	17,5	CR 531635	CT1	425	33,4	22,3	CR 524815	CT1
228,6	28,6	17,5	CR 524204	CT1	427	25,4	20,7	CR 594681	CT3
228,6	28,6	17,5	CR 527819	CT1	432	25,4	20,7	CR 524360	CT3
229	29	17,9	CR 528631	CT1	432	38,1	27	CR 528535	CT1
240	28,6	17,5	CR 594780	CT3	440	22,2	17,5	CR 524388	CT3
254	25,4	20,7	CR 528780	CT3	444,5	34,9	23,8	CR 525737	CT1
254	28,6	17,5	CR 524205	CT1	445	31,8	20,7	CR 522679	CT1
254	28,6	17,5	CR 527806	CT1	445	34,9	23,8	CR 523547	CT1
259	22,2	17,5	CR 524434	CT3	449,3	23,8	19	CR 524389	CT3
273	28,6	17,5	CR 594369	CT1	449,3	95,3	84,2	CR 528070	CT4
280	28,6	17,5	CR 524206	CT1	470	28,6	17,5	CR 525708	CT1
280	31,8	20,7	CR 524928	CT1	470	31,8	20,7	CR 526192	CT1
298,4	28,6	17,5	CR 593629	CT1	495	28,6	17,5	CR 594181	CT1
300	24	19,3	CR 594814	CT3	508	31,8	20,7	CR 524587	CT1
304	22,2	17,5	CR 528036	CT3	516	23,8	19,1	CR 525030	CT3
305	22,2	17,5	CR 524380	CT3	520	25,4	20,7	CR 530468	CT3
305	31,8	20,7	CR 524208	CT1	530	22,2	17,5	CR 528536	CT3
305	38,1	27	CR 525582	CT1	533	32	20,9	CR 594241	CT1
330	28,6	17,5	CR 524209	CT1	546	25,4	20,7	CR 524362	CT3
330	38,1	27	CR 523587	CT1	546	31,8	20,7	CR 524599	CT1
333	22,2	17,5	CR 524381	CT3	546	95,3	84,2	CR 526741	CT4
345	22,2	17,5	CR 525029	CT3	554	31,8	20,7	CR 524210	CT1
350,8	38,1	27	CR 594110	CT1	557	28,6	17,5	CR 524211	CT1
355,6	38,1	27	CR 530733	CT1	559	25,4	20,7	CR 524363	CT3
355,6	34,9	23,8	CR 593037	CT1	559	31,8	20,7	CR 524347	CT1
380	38,1	27	CR 593171	CT1	571,5	31,8	20,7	CR 524212	CT1

* Butt-joint seal; when installed there is no gap between

Axial clamp seals – Metric sizes

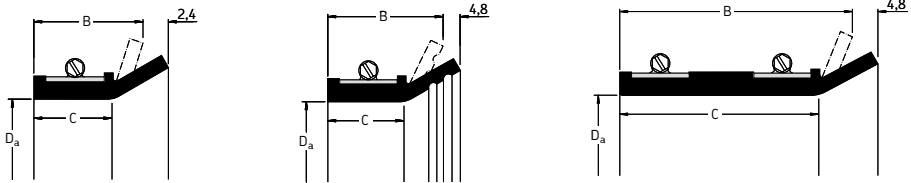

Seating diameter D _a	Seal dimensions B C		SKF Designation	Design	Seating diameter D _a	Seal dimensions B C		SKF Designation	Design
mm	mm		-	-	mm	mm		-	-
578	34,9	23,8	CR 524657	CT1	787	31,8	20,7	CR 525212	CT1
594	34,9	23,8	CR 525627	CT1	800	31,8	20,7	CR 528210	CT1
595	28,6	17,5	CR 525031	CT1	806	22,2	17,5	CR 526244	CT3
597	34,9	23,8	CR 524364	CT1	806	31,8	20,7	CR 526715	CT1
600	30	18,9	CR 594431	CT1	818	31,8	20,7	CR 525034	CT1
603	31,8	20,7	CR 524365	CT1	819,2	31,8	20,7	CR 524294	CT1
603	34,9	23,8	CR 523184	CT1	822,3	31,8	20,7	CR 593949	CT1
603	46	34,9	CR 528651	CT4	825	28,6	17,5	CR 594785	CT1
603,3	25,4	20,7	CR 530589	CT3	825	31,8	20,7	CR 524367	CT1
603,3	34,9	23,8	CR 525637	CT1	825,5	17,4	12,7	CR 594799	CT3
603,3	46	34,9	CR 528267	CT4	840	31,8	20,7	CR 526867	CT1
609,6	25,4	20,7	CR 594059	CT3	856	31,8	20,7	CR 524219	CT1
616	25,4	20,7	CR 526277	CT3	876	38,1	27	CR 523063	CT1
616	47,6	36,5	CR 529276	CT4	889	31,8	20,7	CR 524220	CT1
629	31,8	20,7	CR 524213	CT1	892	22,2	17,5	CR 531069	CT3
638	34,9	23,8	CR 524214	CT1	900	31,8	20,7	CR 524221	CT1
655	40	28,9	CR 594784	CT4	902	38,1	27	CR 524222	CT1
660	34,9	23,8	CR 524591	CT1	914	28,6	17,5	CR 528416	CT1
683	25,4	20,7	CR 529823	CT3	914	30,2	19,1	CR 524223	CT1
684	28,6	17,5	CR 524215	CT1	914	38,1	27	CR 524224	CT1
684	73	61,9	CR 593604	CT4	914,4	28,6	17,5	CR 593606	CT1
686	25,4	20,7	CR 528926	CT3	914,4	31,8	20,7	CR 530466	CT1
692	34,9	23,8	CR 524592	CT1	929	28,6	17,5	CR 593285	CT1
705	34,9	23,8	CR 524216	CT1	929	75,2	64,1	CR 594202	CT4
705	60,3	49,2	CR 528268	CT4	937	34,9	23,8	CR 523154	CT1
711	25,4	20,7	CR 524366	CT3	940	25,4	20,7	CR 526245	CT3
711	31,8	20,7	CR 527232	CT1	949	31,8	20,7	CR 526246	CT1
716	22,2	17,5	CR 531719	CT3	940	38,1	27	CR 525320	CT1
732	28,6	17,5	CR 525032	CT1	943	31,8	20,7	CR 524768	CT1
737	22,2	17,5	CR 594856	CT3	946	31,8	20,7	CR 524368	CT1
737	38,1	27	CR 524940	CT1	952	31,8	20,7	CR 526582	CT1
737	44,5	33,4	CR 528269	CT4	962	31,8	20,7	CR 524225	CT1
746	38,1	27	CR 524853	CT1	965	31,8	20,7	CR 524226	CT1
746	39,7	28,6	CR 528270	CT4	1003	28,6	17,5	CR 529452	CT1
755	34,9	23,8	CR 524217	CT1	1003	31,8	20,7	CR 526806	CT1
755	38,1	27	CR 524218	CT1	1013	34,9	23,8	CR 523584	CT1
755,7	38,1	27	CR 524973	CT1	1013	36,5	25,4	CR 529379	CT1
764	28,6	17,5	CR 525033	CT1	1016	36,5	25,4	CR 525035	CT1

* Butt-joint seal; when installed there is no gap between

Axial clamp seals – Metric sizes

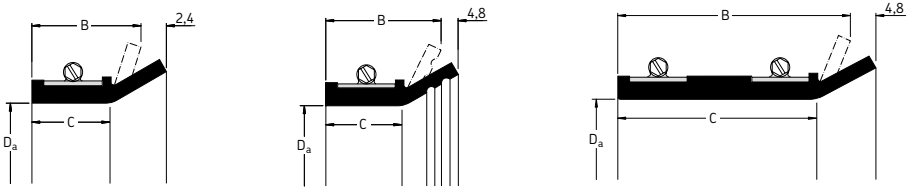

Seating diameter Da	Seal dimensions B C		SKF Designation	Design	Seating diameter Da	Seal dimensions B C		SKF Designation	Design
mm	mm		-	-	mm	mm		-	-
1016	38,1	27	CR 527903	CT1	1286	31,8	20,7	CR 525953	CT1
1018	54,8	43,7	CR 530396	CT4	1302	34,9	23,8	CR 529130	CT1
1022	31,8	20,7	CR 525426	CT1	1308	31,8	20,7	CR 524372	CT1
1029	38,1	27	CR 528532	CT1	1308	34,9	23,8	CR 530661	CT1
1038	38,1	27	CR 525633	CT1	1308	38,1	27	CR 524232	CT1
1041	38,1	27	CR 524227	CT1	1321	38,1	27	CR 528927	CT1
1045	38,1	27	CR 525036	CT1	1346	25,4	20,7	CR 594396	CT3
1047,8	22,2	17,5	CR 594395	CT3	1346	31,8	20,7	CR 528526	CT1
1051	33,4	22,3	CR 530448	CT1	1397	31,8	20,7	CR 526807	CT1
1054	31,8	20,7	CR 527474	CT1	1448	31,8	20,7	CR 528525	CT1
1054	38,1	27	CR 524228	CT1	1497,6	41,3	30,2	CR 594163	CT4
1064	41,3	30,2	CR 528272	CT4	1613	31,8	20,7	CR 526808	CT1
1066	63,5	52,4	CR 528271	CT4	1721	31,8	20,7	CR 528975	CT1
1066,9	38,1	27	CR 594494	CT4	1778	31,8	20,7	CR 526809	CT1
1080	28,6	17,5	CR 523133	CT1	1803	31,8	20,7	CR 524373	CT1
1081,1	25,4	20,7	CR 593564	CT3	1854	38,1	27	CR 531456	CT1
1101,7	31,8	20,7	CR 524909	CT1	1924	31,8	20,7	CR 525092	CT1
1105	38,1	27	CR 524369	CT1	1968	31,8	20,7	CR 529517	CT1
1118	31,8	20,7	CR 524370	CT1	2540	38,1	27	CR 522856	CT1
1118	34,9	23,8	CR 528415	CT1	2616	31,8	20,7	CR 594083	CT1
1118	38,1	27	CR 524229	CT1	4142	31,8	20,7	CR 594682	CT1
1118	38,1	27	CR 593180	CT1					
1118	44,5	33,4	CR 528002	CT4					
1118	44,5	33,4	CR 528273	CT4					
1140	38,1	27	CR 522676	CT1					
1181	31,8	20,7	CR 529086	CT1					
1193,8	38,1	27	CR 527211	CT1					
1206	31,8	27	CR 525091	CT1					
1206	34,9	23,8	CR 526021	CT1					
1206	38,1	27	CR 524230	CT1					
1206,5	30,2	19,1	CR 530606	CT1					
1210	38,1	27	CR 522677	CT1					
1220	25,4	20,7	CR 530441	CT3					
1225	38,1	27	CR 524231	CT1					
1241	38,1	27	CR 524371	CT1					
1245	31,8	20,7	CR 522828	CT1					
1270	25,4	20,7	CR 593525	CT3					
1270	34,9	23,8	CR 529129	CT1					

* Butt-joint seal; when installed there is no gap between

Axial clamp seals – Inch sizes

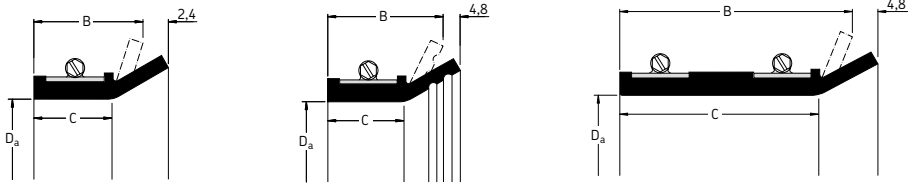

Seating diameter Da	Seal dimensions B C		SKF Designation	Design	Seating diameter Da	Seal dimensions B C		SKF Designation	Design
mm	mm		-	-	mm	mm		-	-
6,6142	1,126	0,689	CR 594334	CT1	15	1,126	0,689	CR 594025	CT1
6,626	1,126	0,689	CR 529489	CT1	15,2362	1,126	0,689	CR 594954	CT1
7,0079	1,5	1,063	CR 523586	CT1	15,315	0,874	0,689	CR 524382	CT3
7,0866	0,874	0,689	CR 595109	CT3	15,315	0,874	0,689	CR 593526	CT3
7,2835	1,1811	0,7441	CR 593637	CT1	15,315	0,937	0,748	CR 524383	CT3
8	0,874	0,689	CR 528745	CT3	15,3543	1	0,815	CR 594190	CT3
8	0,874	0,689	CR 528035	CT3	15,5118	0,874	0,689	CR 594432	CT3
8,252	1,126	0,689	CR 527820	CT1	15,9843	0,874	0,689	CR 529760	CT3
8,5	1	0,815	CR 594343	CT3	16,1417	0,937	0,5	CR 595110	CT1
8,622	1,126	0,689	CR 529490	CT1	16,2598	3,5	3,063	CR 592934	CT4
8,874	0,874	0,689	CR 524375	CT3	16,2992	0,874	0,689	CR 524386	CT3
8,874	0,874	0,689	CR 530096	CT3	16,7323	1,252	0,815	CR 523826	CT1
8,937	1,126	0,689	CR 531635	CT1	16,7323	1,315	0,878	CR 524815	CT1
9	1,126	0,689	CR 524204	CT1	16,811	1	0,815	CR 594681	CT3
9	1,126	0,689	CR 527819	CT1	17,0079	1	0,815	CR 524360	CT3
9,0157	1,1417	0,7047	CR 528631	CT1	17,0079	1,5	1,063	CR 528535	CT1
9,4488	1,126	0,689	CR 594780	CT3	17,3228	0,874	0,689	CR 524388	CT3
10	1	0,815	CR 528780	CT3	17,5	1,374	0,937	CR 525737	CT1
10	1,126	0,689	CR 524205	CT1	17,5197	1,252	0,815	CR 522679	CT1
10	1,126	0,689	CR 527806	CT1	17,5197	1,374	0,937	CR 523547	CT1
10,1969	0,874	0,689	CR 524434	CT3	17,689	0,937	0,748	CR 524389	CT3
10,748	1,126	0,689	CR 594369	CT1	17,689	3,752	3,315	CR 528070	CT4
11,0236	1,126	0,689	CR 524206	CT1	18,5039	1,126	0,689	CR 525708	CT1
11,0236	1,252	0,815	CR 524928	CT1	18,5039	1,252	0,815	CR 526192	CT1
11,748	1,126	0,689	CR 593629	CT1	19,4882	1,126	0,689	CR 594181	CT1
11,811	0,9449	0,7598	CR 594814	CT3	20	1,252	0,815	CR 524587	CT1
11,9685	0,874	0,689	CR 528036	CT3	20,315	0,937	0,752	CR 525030	CT3
12,0079	0,874	0,689	CR 524380	CT3	20,4724	1	0,815	CR 530468	CT3
12,0079	1,252	0,815	CR 524208	CT1	20,8661	0,874	0,689	CR 528536	CT3
12,0079	1,5	1,063	CR 525582	CT1	20,9843	1,2598	0,8228	CR 594241	CT1
12,9921	1,126	0,689	CR 524209	CT1	21,4961	1	0,815	CR 524362	CT3
12,9921	1,5	1,063	CR 523587	CT1	21,4961	1,252	0,815	CR 524599	CT1
13,1102	0,874	0,689	CR 524381	CT3	21,4961	3,752	3,315	CR 526741	CT4
13,5827	0,874	0,689	CR 525029	CT3	21,811	1,252	0,815	CR 524210	CT1
13,811	1,5	1,063	CR 594110	CT1	21,9291	1,126	0,689	CR 524211	CT1
14	1,5	1,063	CR 530733	CT1	22,0079	1	0,815	CR 524363	CT3
14	1,374	0,937	CR 593037	CT1	22,0079	1,252	0,815	CR 524347	CT1
14,9606	1,5	1,063	CR 593171	CT1	22,5	1,252	0,815	CR 524212	CT1

* Butt-joint seal; when installed there is no gap between

Axial clamp seals – Inch sizes

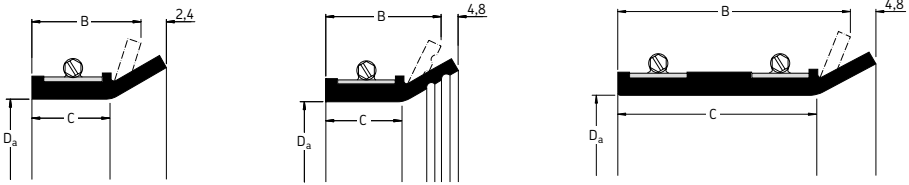

Seating diameter Da	Seal dimensions B C		SKF Designation	Design	Seating diameter Da	Seal dimensions B C		SKF Designation	Design
mm	mm		-	-	mm	mm		-	-
22,7559	1,374	0,937	CR 524657	CT1	30,9843	1,252	0,815	CR 525212	CT1
23,3858	1,374	0,937	CR 525627	CT1	31,4961	1,252	0,815	CR 528210	CT1
23,4252	1,126	0,689	CR 525031	CT1	31,7323	0,874	0,689	CR 526244	CT3
23,5039	1,374	0,937	CR 524364	CT1	31,7323	1,252	0,815	CR 526715	CT1
23,622	1,1811	0,7441	CR 594431	CT1	32,2047	1,252	0,815	CR 525034	CT1
23,7402	1,252	0,815	CR 524365	CT1	32,252	1,252	0,815	CR 524294	CT1
23,7402	1,374	0,937	CR 523184	CT1	32,374	1,252	0,815	CR 593949	CT1
23,7402	1,811	1,374	CR 528651	CT4	32,4803	1,126	0,689	CR 594785	CT1
23,752	1	0,815	CR 530589	CT3	32,4803	1,252	0,815	CR 524367	CT1
23,752	1,374	0,937	CR 525637	CT1	32,5	0,685	0,5	CR 594799	CT3
23,752	1,811	1,374	CR 528267	CT4	33,0709	1,252	0,815	CR 526867	CT1
24	1	0,815	CR 594059	CT3	33,7008	1,252	0,815	CR 524219	CT1
24,252	1	0,815	CR 526277	CT3	34,4882	1,5	1,063	CR 523063	CT1
24,252	1,874	1,437	CR 529276	CT4	35	1,252	0,815	CR 524220	CT1
24,7638	1,252	0,815	CR 524213	CT1	35,1181	0,874	0,689	CR 531069	CT3
25,1181	1,374	0,937	CR 524214	CT1	35,4331	1,252	0,815	CR 524221	CT1
25,7874	1,5748	1,1378	CR 594784	CT4	35,5118	1,5	1,063	CR 524222	CT1
25,9843	1,374	0,937	CR 524591	CT1	35,9843	1,126	0,689	CR 528416	CT1
26,8898	1	0,815	CR 529823	CT3	35,9843	1,189	0,752	CR 524223	CT1
26,9291	1,126	0,689	CR 524215	CT1	35,9843	1,5	1,063	CR 524224	CT1
26,9291	2,874	2,437	CR 593604	CT4	36	1,126	0,689	CR 593606	CT1
27,0079	1	0,815	CR 528926	CT3	36	1,252	0,815	CR 530466	CT1
27,2441	1,374	0,937	CR 524592	CT1	36,5748	1,126	0,689	CR 593285	CT1
27,7559	1,374	0,937	CR 524216	CT1	36,5748	2,9606	2,5236	CR 594202	CT4
27,7559	2,374	1,937	CR 528268	CT4	36,8898	1,374	0,937	CR 523154	CT1
27,9921	1	0,815	CR 524366	CT3	37,0079	1	0,815	CR 526245	CT3
27,9921	1,252	0,815	CR 527232	CT1	37,0079	1,252	0,815	CR 526246	CT1
28,189	0,874	0,689	CR 531719	CT3	37,0079	1,5	1,063	CR 525320	CT1
28,8189	1,126	0,689	CR 525032	CT1	37,126	1,252	0,815	CR 524768	CT1
29,0157	0,874	0,689	CR 594856	CT3	37,2441	1,252	0,815	CR 524368	CT1
29,0157	1,5	1,063	CR 524940	CT1	37,4803	1,252	0,815	CR 526582	CT1
29,0157	1,752	1,315	CR 528269	CT4	37,874	1,252	0,815	CR 524225	CT1
29,3701	1,5	1,063	CR 524853	CT1	37,9921	1,252	0,815	CR 524226	CT1
29,3701	1,563	1,126	CR 528270	CT4	39,4882	1,126	0,689	CR 529452	CT1
29,7244	1,374	0,937	CR 524217	CT1	39,4882	1,252	0,815	CR 526806	CT1
29,7244	1,5	1,063	CR 524218	CT1	39,8819	1,374	0,937	CR 523584	CT1
29,752	1,5	1,063	CR 524973	CT1	39,8819	1,437	1	CR 529379	CT1
30,0787	1,126	0,689	CR 525033	CT1	40	1,437	1	CR 525035	CT1

* Butt-joint seal; when installed there is no gap between

Axial clamp seals – Inch sizes

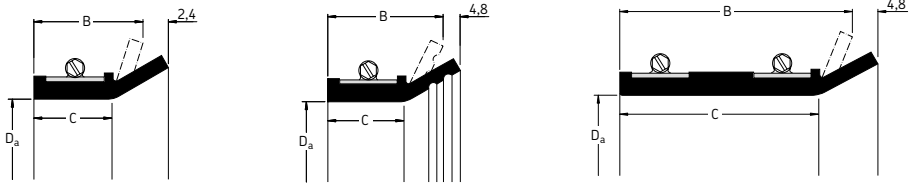

Seating diameter Da	Seal dimensions B C		SKF Designation	Design	Seating diameter Da	Seal dimensions B C		SKF Designation	Design
mm	mm		-	-	mm	mm		-	-
40	1,5	1,063	CR 527903	CT1	50,6299	1,252	0,815	CR 525953	CT1
40,0787	2,1575	1,7206	CR 530396	CT4	51,2598	1,374	0,937	CR 529130	CT1
40,2362	1,252	0,815	CR 525426	CT1	51,4961	1,252	0,815	CR 524372	CT1
40,5118	1,5	1,063	CR 528532	CT1	51,4961	1,374	0,937	CR 530661	CT1
40,8661	1,5	1,063	CR 525633	CT1	51,4961	1,5	1,063	CR 524232	CT1
40,9843	1,5	1,063	CR 524227	CT1	52,0079	1,5	1,063	CR 528927	CT1
41,1417	1,5	1,063	CR 525036	CT1	52,9921	1	0,815	CR 594396	CT3
41,252	0,874	0,689	CR 594395	CT3	52,9921	1,252	0,815	CR 528526	CT1
41,378	1,315	0,878	CR 530448	CT1	55	1,252	0,815	CR 526807	CT1
41,4961	1,252	0,815	CR 527474	CT1	57,0079	1,252	0,815	CR 528525	CT1
41,4961	1,5	1,063	CR 524228	CT1	58,606	1,626	1,189	CR 594163	CT4
41,8898	1,626	1,189	CR 528272	CT4	63,5039	1,252	0,815	CR 526808	CT1
41,9685	2,5	2,063	CR 528271	CT4	67,7559	1,252	0,815	CR 528975	CT1
42,0039	1,5	1,063	CR 594494	CT4	70	1,252	0,815	CR 526809	CT1
42,5197	1,126	0,689	CR 523133	CT1	70,9843	1,252	0,815	CR 524373	CT1
42,563	1	0,815	CR 593564	CT3	72,9921	1,5	1,063	CR 531456	CT1
43,374	1,252	0,815	CR 524909	CT1	75,748	1,252	0,815	CR 525092	CT1
43,5039	1,5	1,063	CR 524369	CT1	77,4803	1,252	0,815	CR 529517	CT1
44,0157	1,252	0,815	CR 524370	CT1	100	1,5	1,063	CR 522856	CT1
44,0157	1,374	0,937	CR 528415	CT1	102,9921	1,252	0,815	CR 594083	CT1
44,0157	1,5	1,063	CR 524229	CT1	163,0709	1,252	0,815	CR 594082	CT1
44,0157	1,5	1,063	CR 593180	CT1	163,0709	1,252	0,815	CR 594082	CT1
44,0157	1,752	1,315	CR 528002	CT4					
44,0157	1,752	1,315	CR 528273	CT4					
44,8819	1,5	1,063	CR 522676	CT1					
46,4961	1,252	0,815	CR 529086	CT1					
47	1,5	1,063	CR 527211	CT1					
47,4803	1,252	1,063	CR 525091	CT1					
47,4803	1,374	0,937	CR 526021	CT1					
47,4803	1,5	1,063	CR 524230	CT1					
47,5	1,189	0,752	CR 530606	CT1					
47,6378	1,5	1,063	CR 522677	CT1					
48,0315	1	0,815	CR 530441	CT3					
48,2283	1,5	1,063	CR 524231	CT1					
48,8583	1,5	1,063	CR 524371	CT1					
49,0157	1,252	0,815	CR 522828	CT1					
50	1	0,815	CR 593525	CT3					
50	1,374	0,937	CR 529129	CT1					

* Butt-joint seal; when installed there is no gap between

