

NTN[®]

BCA[®]



PREMIUM AGRICULTURAL BEARINGS



Serving The Farming Community For Over 55 Years



TABLE OF CONTENTS

<i>What Does The Program Have To Offer?</i>	2 - 3
<i>Flanged Disc Units - FD Series</i>	4 - 5
<i>Rubber Mounted Disc Bearings - CDS Series</i>	6 - 7
<i>Hex Bore Bearings - HPC Series & HPS Series</i>	8 - 9
<i>Square & Round Bore Bearings - DC Series</i>	10 - 11
<i>Square & Round Bore Bearings - DS Series</i>	12 - 13
<i>Bearing Units - Ultra-Class Series</i>	14
<i>Bearing Unit Inserts (Adapter Bearings) - WPC/WPS & NPC/NPS Series</i>	15
<i>Special Radial Ball Bearings</i>	16



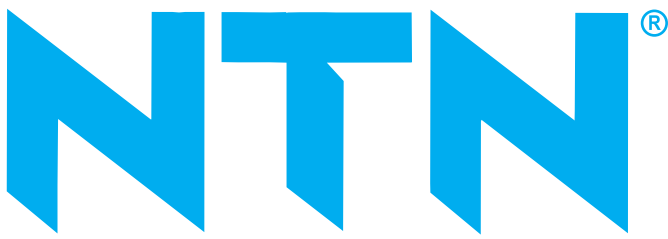

What Does The Program Have To Offer?

AGRICULTURAL APPLICATIONS

BCA[®]

HISTORY

NTN-BCA has been committed to quality bearing manufacturing for over 100 years. It was founded in 1898 in Lancaster, PA as the Star Ball Retainer Company and merged with the Bretz Company in 1910 to form the Bearing Corporation of America (BCA). After acquiring BCA in 1996, NTN's goal has been to reinforce the innovative development and manufacturing of bearing products

- BALL BEARINGS
- DISK HARROW BEARINGS
- INSERT BEARINGS
- MOUNTED UNITS
- 2-BOLT and 4-BOLT FLANGE UNITS

Premium Agricultural SEAL DESIGNS

New Generation BCA Vanguard[®] Seals

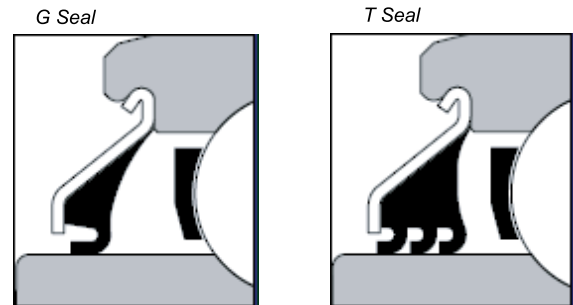

- More lip interference with thicker inboard and outboard lips to ensure the highest resistance to contamination
- Closer clearance between the trash guard and the inner ring O.D. for increased durability
- Thicker corrosion-resistant shield for maximum strength, rigidity, and wear resistance

OEM PREFERRED

BROAD APPLICATION COVERAGE

MULTIPLE CONFIGURATIONS

TRADITION OF QUALITY

COMMITMENT TO SERVICE

MAXIMIZE PRODUCTIVITY

An Array Of Environmentally Friendly Products To Fulfill Your Every Need.

The Preferred Bearing.

OEM PREFERRED

NTN-BCA is a major supplier of bearings to all original agricultural machinery manufacturers (OEM) in the United States. These OEM manufacturers have performed many rigorous field and laboratory tests, proving the superior performance of NTN bearings. Continually improving manufacturing technologies and designs, NTN meets the demanding performance standards of OEM manufacturers who service the farming community.

- **SUPERIOR PERFORMANCE**
- **REDUCED MAINTENANCE REQUIREMENTS**
- **MINIMIZED DOWNTIME**

NTN bearings offer dependability. Each bearing has been manufactured to the highest engineering specifications, using the finest quality materials. Molded seals are designed for optimum performance under highly contaminated environments, and raceways have been honed for smooth operation and longer life. Each bearing also comes lubricated with the optimum grease type and fill. With a global network of over 700 engineers and research laboratories, NTN customers receive unparalleled support for their demanding bearing applications.

BROAD APPLICATION COVERAGE

No matter what agricultural equipment you are using, if it has a rotating component, NTN has a bearing for it! You'll find bearings for disk harrows, planters, mowers, rakes, all types of balers, tileage, seeding and forage harvester equipment, combines, cotton pickers/strippers and more. Bearings for other agricultural equipment like silo unloaders and grain elevators are also available. Need a bearing not featured in our program? No problem. With one of the largest product lines of any bearing manufacturer, chances are NTN has what you need in its industrial product offering.

TRADITION OF QUALITY

NTN has a hard-earned reputation for its exceptionally high-quality product. Earned through an ongoing commitment to develop and manufacture the finest in ball and roller bearings for the OEM and replacement bearing markets, NTN stands for reliability. NTN was the first bearing manufacturer to receive the prestigious Deming Award for statistical process control.

COMMITMENT TO SERVICE

NTN's focus is equally devoted to customer service - authorized NTN distributors have access to engineering support and our 24-hour 'Round the Clock' emergency ordering service. You no longer have to decide between getting the product you need or getting the support you want. With NTN you can have it all.

*Not currently stocking or using NTN bearings for all your agricultural applications?
Contact NTN for interchange information and make the switch today!*



HEAVY DUTY DISC BEARINGS

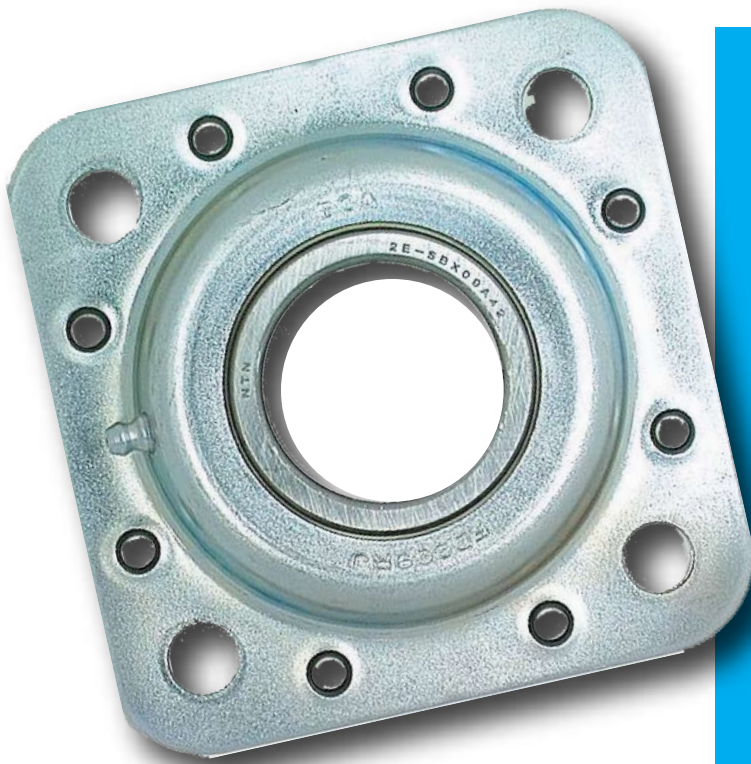

These NTN-BCA integral assemblies are designed specifically for the most severe tillage applications. The FD integral bearing/housing design provides a "bolt-in-place" unit for factory or field installation.

All the benefits of high-performance Heavy Duty Disc Bearings securely installed into a rugged corrosion-resistant housing.

✓ YEARS OF FIELD EXPERIENCE

✓ MAXIMUM INTEGRITY

- Heavy gauge case-hardened and zinc-plated stampings encapsulate the bearing and are assembled with eight cold formed rivets to prevent contamination from entering the unit
- Two nitrile o-rings installed within the cavity to exclude contaminants and provide a grease seal to ensure lubricant feeds directly into the bearing
- Grease fitting is permanently retained in the stamping, allowing easy lubrication and protection from the environment

✓ DYNAMIC ALIGNMENT

- Spherical bearing OD allows misalignment relative to the housing

✓ MAXIMUM SEAL EFFECTIVENESS

- Sealed on both sides with rugged triple lip nitrile rubber seals
- Crimped to outer ring grooves for ultimate seal security
- Seals bonded to heavy gauge trash guard shields

✓ BROAD PRODUCT LINE COVERAGE

- Available in a variety of bore options including: square, round, and round with locking collar

✓ MISALIGNMENT TOLERANT

- Flexible nylon retainer
- C3 internal clearance
- Ability to support both axial and radial loads

FD Series

FLANGED DISC UNITS

PART NUMBER INTERCHANGE

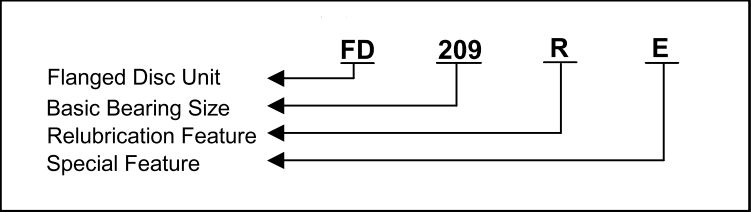

BCA P/N	Fafnir* P/N	Shaft Size	Shaft Shape
FD209RE	DHU 1.1/2R-209	1 1/2"	Round
FD209RJ	Premium DHU491A	1 3/4"	Round
FD209RJH	DHU491A	1 3/4"	Round
FD209RK	DHU 1.1/4S-209	1 1/4"	Square
FD209RM	DHU 1.1/8S-209	1 1/8"	Square
FD211RBA	DHU 2.3/16R-211	2 3/16"	Round
FD211REA	DHU 1.3/4R-211	1 3/4"	Round
FD211RJA	-	1 15/16"	Round
FD211RM	DHU 1.1/2S-211	1 1/2"	Square

* Fafnir is a registered trademark of the Timken Company

NOTE:
FD209RJ is interchangeable with FD209RP/Case ST491A

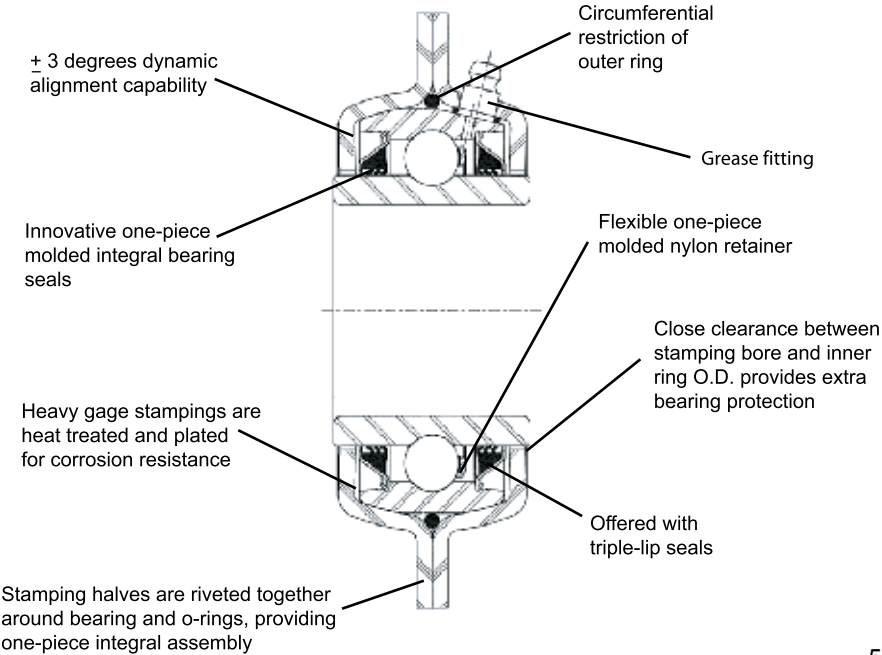



RUBBER MOUNTED DISC BEARINGS



NTN-BCA CDS assemblies are designed specifically for tillage applications with high shock loads. The CDS units are comprised of an integral bearing and a rubber grommet housing that absorbs impact loads.

✓ **YEARS OF FIELD EXPERIENCE**

✓ **DYNAMIC ALIGNMENT**

- Spherical bearing OD allows misalignment relative to the housing

✓ **SPECIAL DIMENSIONAL ATTRIBUTES**

- These units are compatible with a variety of equipment designs

✓ **BROAD PRODUCT LINE COVERAGE**

- Available in a variety of bore options including: square, round, and round with locking collar

✓ **RUBBER GROMMET HOUSING ABSORBS IMPACT LOADS FROM UNEVEN FIELDS**

✓ **MAXIMUM SEAL EFFECTIVENESS**

- Sealed on both sides with rugged triple lip nitrile rubber seals
- Crimped to outer ring grooves for ultimate seal security
- Seals bonded to heavy gauge trash guard shields

CDS Series

RUBBER MOUNTED DISC HARROW BEARINGS

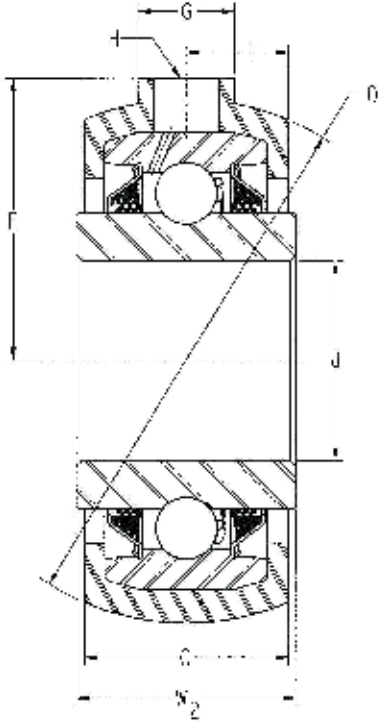
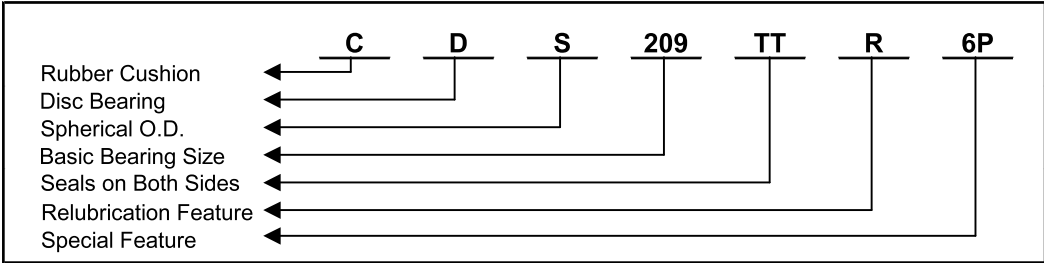

BCA P/N	Bore	Inner Ring Width	Housing Width	Housing O.D.	Housing Relube Hole Radius	Relube Hole Center Distance	Housing Relube Hole Width	Housing Relube Hole Diameter
	d	W ₂	C	D	E	F	G	H
(Dimensions in Inches)								
CDS209TTR6P	1.530 RD	1.6875	1.560	4.000	2.160	0.780	0.750	0.500
CDS209TTR6PB	1.770 RD	1.6875	1.560	4.000	2.160	0.780	0.750	0.500
CDS211TTR23	1.780 RD	2.1250	1.760	4.438	2.375	0.880	0.750	0.500
CDS211TTR23A	1.531 SQ	2.1250	1.760	4.438	2.375	0.880	0.750	0.500

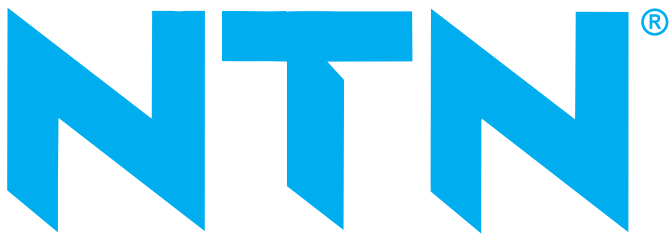

HEX BORE BEARINGS



NTN-BCA Hex Bore Bearings are a popular selection in moderately-loaded, low-speed agricultural applications.

Hex Bore Bearings eliminate the need for locking devices and simplify installation.

✓ YEARS OF FIELD EXPERIENCE

✓ MAXIMUM SEAL EFFECTIVENESS

- Sealed on both sides with rugged triple lip nitrile rubber seals
- Crimped to outer ring grooves for ultimate seal security
- Seals bonded to heavy gauge trash guard shields

✓ MISALIGNMENT TOLERANT

- Flexible nylon retainer
- C3 internal clearance
- Ability to support both axial and radial loads

✓ AVAILABLE WITH SPHERICAL OR CYLINDRICAL OUTER RING OD

✓ AVAILABLE IN RE-LUBRICATABLE AND NON-RE-LUBRICATABLE

✓ AVAILABLE IN NUMEROUS HEX BORE SIZES

- From 7/8" ~ 2 1/2"

HPC Series - HPS Series

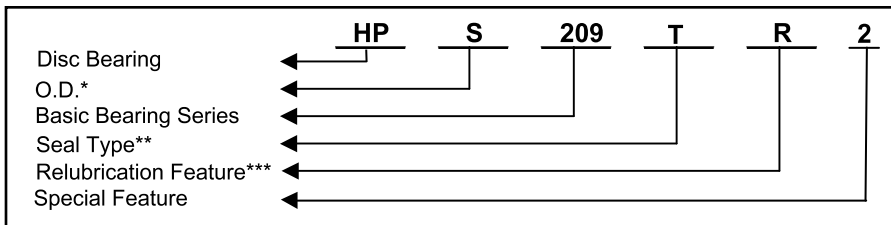

* C = Cylindrical, S = Spherical
** T = Triple-lip, G = Single-lip, V = Double-lip Seals
*** R = Re-lubricatable; blank = Non-re-lubricatable

PART NUMBER INTERCHANGE

BCA P/N	Fafnir* P/N	Shaft Size	Shaft Shape
HPC011GP	204KRR2	11/16"	Hex
HPC014GP	205KRR2	7/8"	Hex
HEC014VP	-	7/8"	Hex
HPC100GP	206KRR6	1"	Hex
HPC100TP	206KPP3	1"	Hex
HPC100TPD	206KPPB5	1"	Hex
HPC100TR	G206KPP4	1"	Hex
HPC103TP2	-	1 1/4"	Hex
HPC103TPA	-	1 1/4"	Hex
HPC104TPA	W208PP21	1 1/4"	Hex

BCA P/N	Fafnir* P/N	Shaft Size	Shaft Shape
HPS014GP	205KRRB2	7/8"	Hex
HPS100GP	206KRRB6	1"	Hex
HPS100TPD	-	1"	Hex
HPS102GP	207KRRB9	1 1/8"	Hex
HPS102GPE	207KRRB12	1 1/8"	Hex
HPS102GR	G207KPPB2	1 1/8"	Hex
HPS102TR	-	1 1/8"	Hex
HPS103GP2	207KPP3	1 1/4"	Hex
HPS103GP2A	-	1 1/4"	Hex
HPS103TP2	207KPPB3	1 1/4"	Hex
HPS104TR	GW208PPB22	1 1/4"	Hex
HPS106GP	-	1 3/8"	Hex
HPS108GPB	-	1 1/2"	Hex - OR width 0.8661"
HPS108GPH	209KRRB2	1 1/2"	Hex - OR width 0.7480"

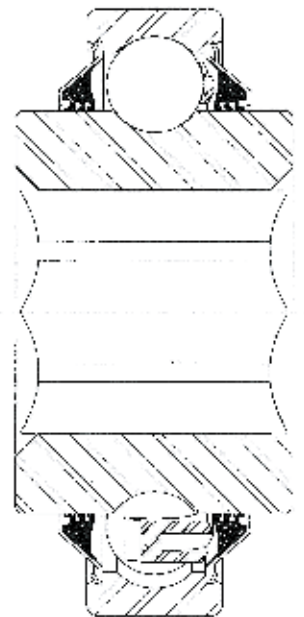

* Fafnir is a registered trademark of the Timken Company



SQUARE & ROUND BORE BEARINGS

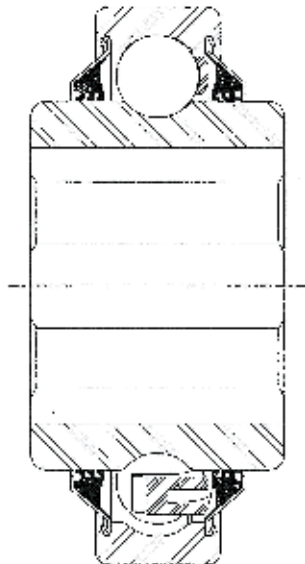

✓ **YEARS OF FIELD EXPERIENCE**

✓ **IMPACT RESISTANT**

✓ **MAXIMUM SEAL EFFECTIVENESS**

- Sealed on both sides with rugged triple lip nitrile rubber seals
- Crimped into outer ring grooves for ultimate seal security
- Seals bonded to heavy gauge trash guard shields

✓ **MISALIGNMENT TOLERANT**

- Flexible nylon retainer
- C3 internal clearance
- Ability to support both axial and radial loads

✓ **AVAILABLE IN RE-LUBRICATABLE AND NON-RE-LUBRICATABLE**

✓ **AVAILABLE WITH ROUND OR SQUARE BORES**

- Square bores - 7/8" ~ 2 1/2"
- Round bores - up to 3 1/8"

DC Series

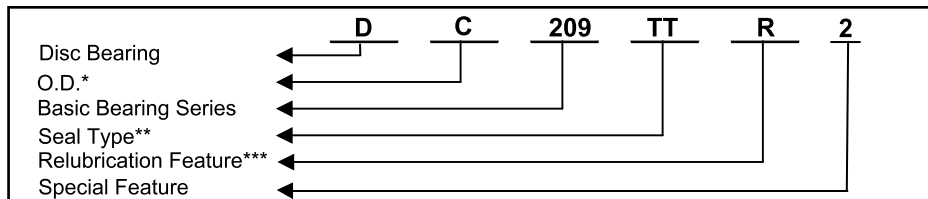

* C = Cylindrical, S = Spherical
 ** TT = Triple-lip Seals
 ***R = Re-lubricatable; blank = Non-re-lubricatable

PART NUMBER INTERCHANGE

BCA P/N	Fafnir* P/N	Shaft Size	Shaft Shape
DC208TT	W208K3	1 1/8"	Square
DC208TT10	W208PP10	1.5000"	Round
DC208TT5	W208PP5	1 1/8"	Square
DC208TT6	W208PP6	1"	Square
DC208TT8	W208PP8	1 1/8"	Square
DC208TTR17	GW208PP17	1 1/8"	Square
DC209TTR10	-	1.7700"	Round
DC209TTR8	GW209PP8	1 1/4"	Square
DC210TT2	W210PP2	1.9380"	Round
DC210TT4	W210PP4	1 1/8"	Square
DC210TTR4	GW210PP4	1 1/8"	Square
DC211TT2	W211PP2	2.1880"	Round
DC211TT3	W211PP3	1 1/2"	Square
DC211TT5	W211PP5	1 1/2"	Square
DC211TTR2	GW211PP2	2.1880"	Round
DC211TTR21	GW211PP37	1.7800"	Round
DC211TTR3	GW211PP3	1 1/2"	Square
DC211TTR3E	GW211PP17	1 1/2"	Square
DC211TTR4	GW211PP4	1 1/2"	Square
DC212TTR	-	1 3/4"	Square
DC214TTR2	GW214PP2	2.7559"	Round
DC214TTR3	-	2.6881"	Round
DC216TTR2	GW216PP2	2 1/4"	Square



SQUARE & ROUND BORE BEARINGS

DS Series

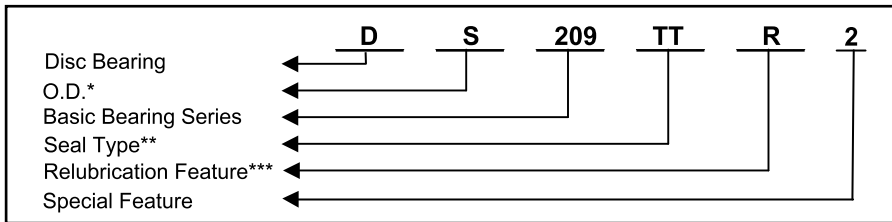

* C = Cylindrical, S = Spherical

** TT = Triple-lip Seals

*** R = Re-lubricatable; blank = Non-re-lubricatable



✓ **YEARS OF FIELD EXPERIENCE**

✓ **IMPACT RESISTANT**

✓ **MAXIMUM SEAL EFFECTIVENESS**

- Sealed on both sides with rugged triple lip nitrile rubber seals
- Crimped into outer ring grooves for ultimate seal security
- Seals bonded to heavy gauge trash guard shields

✓ **MISALIGNMENT TOLERANT**

- Flexible nylon retainer
- C3 internal clearance
- Ability to support both axial and radial loads

✓ **AVAILABLE IN RE-LUBRICATABLE AND NON-RE-LUBRICATABLE**

✓ **AVAILABLE WITH ROUND OR HEX BORES**

- Square bores - 7/8" ~ 2 1/2"
- Round bores - up to 3 1/8"



PART NUMBER INTERCHANGE

BCA P/N	Fafnir* P/N	Shaft Size	Shaft Shape
DS208TT12	-	1 1/8"	Square
DS208TT12A	W208PPB12	1 1/8"	Square
DS208TT13	W208PPB13	7/8"	Square
DS208TT2A	W208PPB23	1.5005"	Round
DS208TT5	W208PPB5	1 1/8"	Square
DS208TT6	W208PPB6	1"	Square
DS208TT7	W208PPB7	1.1880"	Round
DS208TT8	W208PPB8	1 1/8"	Square
DS208TT9	W208PPB9	1"	Square
DS208TTR5	GW208PPB5	1 1/8"	Square
DS208TTR8	GW208PPB8	1 1/8"	Square
DS209TT2	W209PPB2	1.7717"	Round
DS209TT4	W209PPB4	1.5300"	Round
DS209TT5	W209PPB8	1 1/4"	Square
DS209TT6	W209PPB6	1.5300"	Round
DS209TTR10	GW209PPB11	1.7780"	Round
DS209TTR11B	-	1.7700"	Round
DS209TTR15	-	1 1/8"	Square
DS209TTR2	GW209PPB2	1.7717"	Round
DS209TTR4	GW209PPB4	1.5300"	Round
DS209TTR5	GW209PPB5	1 1/4"	Square
DS209TTR6JA	-	1.7700"	Round
DS209TTR6P	-	1.5300"	Round
DS209TTR6PA	-	1.7700"	Round
DS209TTR8	GW209PPB8	1 1/4"	Square
DS210TT2	W210PPB2	1.9380"	Round
DS210TT4	W210PPB4	1 1/8"	Square
DS210TT5	W210PPB5	1.7850"	Round
DS210TTR2	GW210PPB2	1.9380"	Round
DS210TTR4	GW210PPB4	1 1/8"	Square
DS210TTR5R	GW210PPB5	1.7850"	Round
DS211TT2	W211PPB2	2.1880"	Round
DS211TT3	W211PPB3	1 1/2"	Square
DS211TT4	W211PPB4	2.1880"	Round
DS211TT6	W211PPB6	1 1/2"	Square
DS211TTR13	GW211PPB13	1.7850"	Round
DS211TTR14	GW211PPB14	2.0150"	Round
DS211TTR2	GW211PPB2	2.1880"	Round
DS211TTR21A	-	1.7800"	Round
DS211TTR23	-	1.7800"	Round
DS211TTR3	GW211PPB3	1 1/2"	Square
DS211TTR8R	-	2.1880"	Round
DS214TTR3	-	1.9381"	Round
DS214TTR5	GW1214PPB5	2.7559"	Round
DS216TTR2	-	2 1/4"	Square

* Fafnir is a registered trademark of the Timken Company







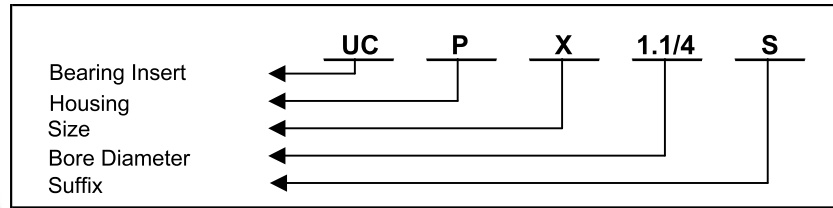



BEARING UNITS

ULTRA-CLASS Series



Ultra Class represents feature rich bearing units with electric motor quality inserts. All wide inner ring inserts are black oxide coated to resist corrosion.

HOUSING INSERT MATRIX

HOUSINGS > ▽ INSERTS			
 A-UC2	UCP UCPL	UCFU	UCFLU
 A-UCX	UCPX	UCFUX	UCFLUX
 A-UEL2	UELP UELPL	UELFU	UELFLU
 A-AR2	ARP ARPL	ARFU	ARFLU
 A-JEL2	JELP JELPL	JELFU	JELFLU

✓ INNOVATIVE DESIGN

✓ HEAVY DUTY HOUSING WITH SOLID BASE

- Rugged housing with solid base can take more abuse, dampens vibrations and provides protection against over-tightening of bolts

✓ RUBBER LIP SEAL WITH FLINGER

- Flinger combined with a full contact molded rubber seal provides superior protection against contamination

✓ PERMANENT METALLIC NAME PLATE

- Units have a metallic name plate showing the complete unit part number, making it easier for stocking on the shelf and identification of parts for replacement

✓ BALL POINT SET SCREW - "NTN Exclusive"

- Ball point set screw is an exclusive NTN design that is superior to cup point set screws

✓ ELECTRIC MOTOR QUALITY INSERTS

- Insert bearing raceways are super finished and have tighter run out tolerances

BEARING UNIT INSERTS

WPC/WPS & NPC/NPS Series

WPC/WPS - WIDE INNER RING ADAPTER BEARINGS

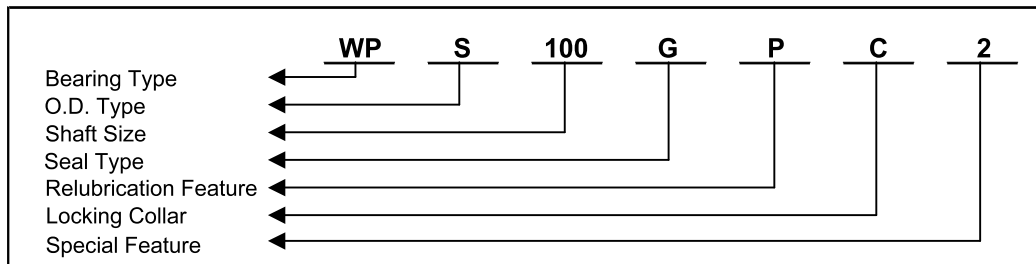

NPC/NPS - NARROW INNER RING ADAPTER BEARINGS

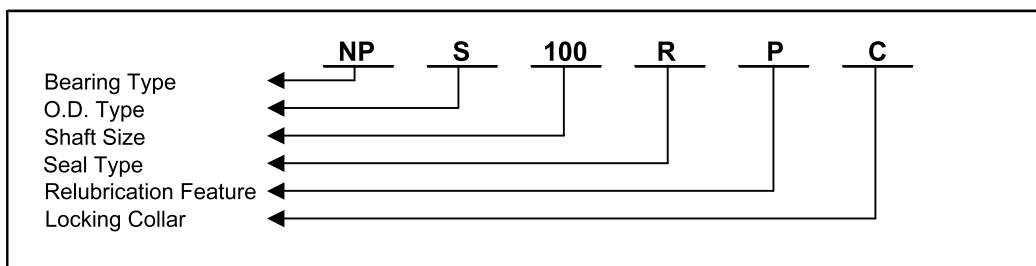

Bearing Type

WP=Adapter bearings with wide inner ring and locking collar
 NP=Adapter bearings with narrow inner ring and locking collar

OD Type

S = Spherical OD
 C = Cylindrical OD

Shaft Size

100 = 1st digit is in inches, and 2nd number is 1/16"
 ex. 100 = 1"
 104 = 1.1/4"
 014 = 14/16 = 7/8"

Seal Type

G = Vanguard™ single lip seals
 V= Vanguard™ double lip seals
 T = Vanguard™ triple lip seals
 R = Vanguard™ single lip seals

Re-lube Feature

P = Non-relubricatable
 R = Relubricatable

Locking collar

C = Comes with locking collar

Special Feature

2 = Special feature



SPECIAL RADIAL BALL BEARINGS

Part Number Interchange

BCA P/N	Fafnir* P/N	Special Features
203FFA	-	Basic 203FF with Inch Dimensions
203RRAR10	BB203KRR2	Special Bore and Width
204BAR	-	Basic 204AR with Seal on One Side
204BBAR	P204RR6	Special 3/4 Bore, Double Sealed with Special Seal
204BBE	204RR8	Special .6260 Bore, Double Sealed
204FREN	204PY3	Special 204 with Wide I.R., Double Sealed
204GGB	1012KRRB3	Special Self Aligning Adapter Bearing
204TJN	-	Special Disc Bearing with one Triple Lip Seal
204TTM	-	Special Adapter Bearing with 2-Set Screws for; TNT-3/4-RA
205FFW	-	Special Seals, Nylon Retainer
205RHN	205KR3	Special 3/4 Bore with R Type Seal
205RRA	-	Special 3/4 Bore with Extended I.R.
205RRU	-	Special Bore with Wide I.R.
205RTAN	205RVA	Special Bore with Wide I.R., T Seal on One Side
205TNJ	205KP6	Special Bore with Wide I.R., T Seal on One Side
205TNK	-	Special Bore with Wide I.R., T Seal on One Side
205TTB	205PP9	Special Bore with Wide I.R., Two T Seals
205TTH	205PPB7	Special Bore with Wide I.R., Two T Seals
205TTP	205PP12	Special Bore with Wide I.R., Two T Seals
205VVA	-	Special Bore, O.D. and Width, Nylon Retainer
206FFB	-	Special Seals, Nylon Retainer
206GGBN	-	Special Bore with Wide I.R. and Spherical O.D., Two G Seals
206GGH	-	Special .7560 Bore with Two G Seals
206RRMN	-	Special .7580 Bore and Two R Seals
206RTQ	-	Special Bore and Width with One R and T Seal
206TTA	-	Special 1.0100 Bore with Wide I.R. and Spherical O.D., Two Seals
206TTU	-	Basic 206TTA, with Re-lube feature
8445C3	-	Single Seal, C3
8505	205KL	Single Seal
8506/2A	206KL	Single Seal
87506	206KLD	Seal and Shield
88016/2AS	202KLL3	Basic 88016
88107BGG	207KRR14	Basic 88107 with 1.2525 Bore and "G" Seals
88128GG	P208KRR4	Basic 88128A with Two "G" Seals
88502A	202KLL4	Basic 88502 with .5512 Bore and .035 Bore Corners
88506/2AS	206NPP2	Basic 88506
88508/2AS	208KRR2	Basic 88508
8984YY	203KRR3	Basic 8984 with "Y" Seals

* Fafnir is a registered trademark of the Timken Company

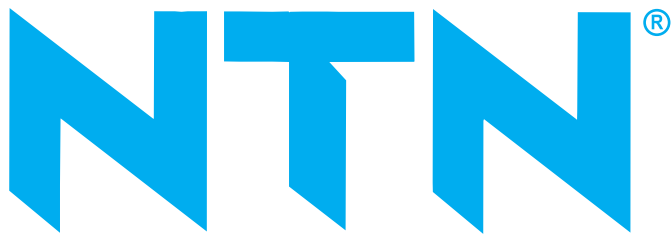

www.ntnamerica.com

CORPORATE OFFICE

*1600 East Bishop Court
Mt. Prospect, IL 60056
Tel: (847) 298-7500 1-800-468-6528
Fax: (847) 294-1230*

SALES OFFICES:

EASTERN REGION

*191 Sheree Blvd. Suite 101
Exton, PA 19341
Tel: (610) 524-1477 1-800-394-4686
Fax: (610) 524-1577*

SOUTHEAST REGION

*5475 Peachtree Industrial Blvd.
Norcross, GA 30092
Tel: (770) 448-4710 1-800-241-0568
Fax: (770) 448-6969*

GREAT LAKES REGION

*1600 East Bishop Court
Mt. Prospect, IL 60056
Tel: (847) 298-7500 1-800-252-8123
Fax: (847) 294-1364*

CENTRAL REGION

*111 W. Washington St. Suite 310
East Peoria, IL 61611
Tel: (309) 699-8600 1-800-545-0434
Fax: (309) 699-8670*

WESTERN REGION

*5800 Campus Circle Dr. E Suite 108A
Irving, TX 75063-2708
Tel: (972) 751-1818 1-800-441-0825
Fax: (972) 751-1836*

AUTOMOTIVE GROUP

*39255 West 12 Mile Rd.
Farmington Hills, MI 48331
Tel: (248) 324-4700 1-800-929-3892
Fax: (248) 324-1103*